Matplotlib

Release 2.0.2

John Hunter, Darren Dale, Eric Firing, Michael Droettboom and the m

May 10, 2017

CONTENTS

I	User's Guide	1
1	Introduction	3
2	Installing	5
3	Tutorials	11
4	Working with text	97
5	Colors	145
6	Customizing matplotlib	173
7	Interactive plots	189
8	Selected Examples	205
9	What's new in matplotlib	239
10	GitHub Stats	339
11	License	417
12	Credits	421
II	The Matplotlib API	423
13	Plotting commands summary	425
14	API Changes	433
15	The top level <code>matplotlib</code> module	483
16	<code>afm</code> (Adobe Font Metrics interface)	487
17	<code>animation</code> module	491

18 artist Module	535
19 Axes class	555
20 axis and tick API	793
21 backends	913
22 cbook	953
23 cm (colormap)	971
24 collections	975
25 colorbar	1145
26 colors	1151
27 container	1165
28 dates	1167
29 dviread	1181
30 figure	1185
31 finance	1207
32 font_manager	1219
33 gridspec	1227
34 image	1231
35 legend and legend_handler	1237
36 lines	1245
37 markers	1255
38 mathtext	1259
39 mlab	1279
40 offsetbox	1313
41 patches	1325
42 path	1367
43 patheffects	1375
44 projections	1379

45	pyplot	1387
46	rcsetup	1593
47	sankey	1597
48	scale	1605
49	spines	1615
50	style	1619
51	text	1621
52	ticker	1635
53	tight_layout	1647
54	Working with transformations	1649
55	triangular grids	1671
56	type1font	1683
57	units	1685
58	widgets	1687
III The Matplotlib FAQ		1703
59	Installation	1705
60	Usage	1713
61	How-To	1725
62	Troubleshooting	1741
63	Environment Variables	1745
64	Working with Matplotlib in Virtual environments	1747
65	Working with Matplotlib on OSX	1749
IV Matplotlib AxesGrid Toolkit		1753
66	Overview of AxesGrid toolkit	1757
67	The Matplotlib AxesGrid Toolkit User's Guide	1779

68	The Matplotlib AxesGrid Toolkit API	1795
69	The Matplotlib axes_grid1 Toolkit API	1805
V	mplot3d	1823
70	Matplotlib mplot3d toolkit	1825
VI	Toolkits	1879
71	Mapping Toolkits	1883
72	General Toolkits	1885
73	High-Level Plotting	1889
VII	External Resources	1893
74	Books, Chapters and Articles	1895
75	Videos	1897
76	Tutorials	1899
VIII	The Matplotlib Developers' Guide	1901
77	Contributing	1903
78	Developer's tips for testing	1911
79	Developer's tips for documenting matplotlib	1917
80	Developer's guide for creating scales and transformations	1929
81	Developer's tips for writing code for Python 2 and 3	1933
82	Working with <i>Matplotlib</i> source code	1937
83	Reviewers guideline	1957
84	Release Guide	1959
85	Matplotlib Enhancement Proposals	1965
86	Licenses	2017
87	Default Color changes	2019

IX Matplotlib Examples	2023
88 animation Examples	2025
89 api Examples	2029
90 axes_grid Examples	2123
91 color Examples	2175
92 event_handling Examples	2187
93 frontpage Examples	2221
94 images_contours_and_fields Examples	2225
95 lines_bars_and_markers Examples	2237
96 misc Examples	2251
97 mplot3d Examples	2275
98 pie_and_polar_charts Examples	2323
99 pylab_examples Examples	2329
100pyplots Examples	2769
101scales Examples	2791
102shapes_and_collections Examples	2793
103showcase Examples	2799
104specialty_plots Examples	2817
105statistics Examples	2825
106style_sheets Examples	2857
107subplots_axes_and_figures Examples	2873
108tests Examples	2877
109text_labels_and_annotations Examples	2889
110ticks_and_spines Examples	2895
111units Examples	2909
112user_interfaces Examples	2935
113widgets Examples	3001

X	Glossary	3015
	Bibliography	3019
	Python Module Index	3021
	Index	3023

Part I

User's Guide

INTRODUCTION

Matplotlib is a library for making 2D plots of arrays in [Python](#). Although it has its origins in emulating the MATLAB®¹ graphics commands, it is independent of MATLAB, and can be used in a Pythonic, object oriented way. Although Matplotlib is written primarily in pure Python, it makes heavy use of [NumPy](#) and other extension code to provide good performance even for large arrays.

Matplotlib is designed with the philosophy that you should be able to create simple plots with just a few commands, or just one! If you want to see a histogram of your data, you shouldn't need to instantiate objects, call methods, set properties, and so on; it should just work.

For years, I used to use MATLAB exclusively for data analysis and visualization. MATLAB excels at making nice looking plots easy. When I began working with EEG data, I found that I needed to write applications to interact with my data, and developed an EEG analysis application in MATLAB. As the application grew in complexity, interacting with databases, http servers, manipulating complex data structures, I began to strain against the limitations of MATLAB as a programming language, and decided to start over in Python. Python more than makes up for all of MATLAB's deficiencies as a programming language, but I was having difficulty finding a 2D plotting package (for 3D [VTK](#) more than exceeds all of my needs).

When I went searching for a Python plotting package, I had several requirements:

- Plots should look great - publication quality. One important requirement for me is that the text looks good (antialiased, etc.)
- Postscript output for inclusion with TeX documents
- Embeddable in a graphical user interface for application development
- Code should be easy enough that I can understand it and extend it
- Making plots should be easy

Finding no package that suited me just right, I did what any self-respecting Python programmer would do: rolled up my sleeves and dived in. Not having any real experience with computer graphics, I decided to emulate MATLAB's plotting capabilities because that is something MATLAB does very well. This had the added advantage that many people have a lot of MATLAB experience, and thus they can quickly get up to steam plotting in python. From a developer's perspective, having a fixed user interface (the *pylab* interface) has been very useful, because the guts of the code base can be redesigned without affecting user code.

The Matplotlib code is conceptually divided into three parts: the *pylab interface* is the set of functions provided by `matplotlib.pyplot` which allow the user to create plots with code quite similar to MATLAB

¹ MATLAB is a registered trademark of The MathWorks, Inc.

figure generating code (*Pyplot tutorial*). The *Matplotlib frontend* or *Matplotlib API* is the set of classes that do the heavy lifting, creating and managing figures, text, lines, plots and so on (*Artist tutorial*). This is an abstract interface that knows nothing about output. The *backends* are device-dependent drawing devices, aka renderers, that transform the frontend representation to hardcopy or a display device (*What is a backend?*). Example backends: PS creates [PostScript®](#) hardcopy, SVG creates [Scalable Vector Graphics](#) hardcopy, Agg creates PNG output using the high quality [Anti-Grain Geometry](#) library that ships with Matplotlib, GTK embeds Matplotlib in a [Gtk+](#) application, GTKAgg uses the Anti-Grain renderer to create a figure and embed it in a Gtk+ application, and so on for [PDF](#), [WxWidgets](#), [Tkinter](#), etc.

Matplotlib is used by many people in many different contexts. Some people want to automatically generate PostScript files to send to a printer or publishers. Others deploy Matplotlib on a web application server to generate PNG output for inclusion in dynamically-generated web pages. Some use Matplotlib interactively from the Python shell in Tkinter on Windows™. My primary use is to embed Matplotlib in a Gtk+ application that runs on Windows, Linux and Macintosh OS X.

INSTALLING

There are many different ways to install matplotlib, and the best way depends on what operating system you are using, what you already have installed, and how you want to use it. To avoid wading through all the details (and potential complications) on this page, there are several convenient options.

2.1 Installing pre-built packages

2.1.1 Most platforms : scientific Python distributions

The first option is to use one of the pre-packaged python distributions that already provide matplotlib built-in. The Continuum.io Python distribution ([Anaconda](#) or [miniconda](#)) and the Enthought distribution ([Canopy](#)) are both excellent choices that “just work” out of the box for Windows, OSX and common Linux platforms. Both of these distributions include matplotlib and *lots* of other useful tools.

2.1.2 Linux : using your package manager

If you are on Linux, you might prefer to use your package manager. matplotlib is packaged for almost every major Linux distribution.

- Debian / Ubuntu : `sudo apt-get install python-matplotlib`
- Fedora / Redhat : `sudo yum install python-matplotlib`

2.1.3 Mac OSX : using pip

If you are on Mac OSX you can probably install matplotlib binaries using the standard Python installation program `pip`. See [Installing OSX binary wheels](#).

2.1.4 Windows

If you don't already have Python installed, we recommend using one of the [scipy-stack compatible Python distributions](#) such as WinPython, Python(x,y), Enthought Canopy, or Continuum Anaconda, which have matplotlib and many of its dependencies, plus other useful packages, preinstalled.

For [standard Python](#) installations, install matplotlib using `pip`:

```
python -m pip install -U pip setuptools
python -m pip install matplotlib
```

In case Python 2.7 or 3.4 are not installed for all users, the Microsoft Visual C++ 2008 (64 bit or 32 bit for Python 2.7) or Microsoft Visual C++ 2010 (64 bit or 32 bit for Python 3.4) redistributable packages need to be installed.

Matplotlib depends on [Pillow](#) for reading and saving JPEG, BMP, and TIFF image files. Matplotlib requires [MiKTeX](#) and [GhostScript](#) for rendering text with LaTeX. [FFmpeg](#), [avconv](#), [mencoder](#), or [ImageMagick](#) are required for the animation module.

The following backends should work out of the box: `agg`, `tkagg`, `ps`, `pdf` and `svg`. For other backends you may need to install [pycairo](#), [PyQt4](#), [PyQt5](#), [PySide](#), [wxPython](#), [PyGTK](#), [Tornado](#), or [GhostScript](#).

`TkAgg` is probably the best backend for interactive use from the standard Python shell or IPython. It is enabled as the default backend for the official binaries. `GTK3` is not supported on Windows.

The Windows wheels (*.whl) on the [PyPI download page](#) do not contain test data or example code. If you want to try the many demos that come in the matplotlib source distribution, download the *.tar.gz file and look in the `examples` subdirectory. To run the test suite, copy the `lib\matplotlib\tests` and `lib\mpl_toolkits\tests` directories from the source distribution to `sys.prefix\Lib\site-packages\matplotlib` and `sys.prefix\Lib\site-packages\mpl_toolkits` respectively, and install [nose](#), [mock](#), [Pillow](#), [MiKTeX](#), [GhostScript](#), [ffmpeg](#), [avconv](#), [mencoder](#), [ImageMagick](#), and [Inkscape](#).

2.2 Installing from source

If you are interested in contributing to matplotlib development, running the latest source code, or just like to build everything yourself, it is not difficult to build matplotlib from source. Grab the latest `tar.gz` release file from the [PyPI files page](#), or if you want to develop matplotlib or just need the latest bugfixed version, grab the latest git version *Source install from git*.

The standard environment variables `CC`, `CXX`, `PKG_CONFIG` are respected. This means you can set them if your toolchain is prefixed. This may be used for cross compiling.

```
export CC=x86_64-pc-linux-gnu-gcc
export CXX=x86_64-pc-linux-gnu-g++
export PKG_CONFIG=x86_64-pc-linux-gnu-pkg-config
```

Once you have satisfied the requirements detailed below (mainly python, numpy, libpng and freetype), you can build matplotlib.

```
cd matplotlib
python setup.py build
python setup.py install
```

We provide a `setup.cfg` file that goes with `setup.py` which you can use to customize the build process. For example, which default backend to use, whether some of the optional libraries that matplotlib ships with are installed, and so on. This file will be particularly useful to those packaging matplotlib.

If you have installed prerequisites to nonstandard places and need to inform matplotlib where they are, edit `setuptools.py` and add the base dirs to the `basedir` dictionary entry for your `sys.platform`. e.g., if the header to some required library is in `/some/path/include/someheader.h`, put `/some/path` in the `basedir` list for your platform.

2.2.1 Build requirements

These are external packages which you will need to install before installing matplotlib. If you are building on OSX, see *Building on OSX*. If you are building on Windows, see *Building on Windows*. If you are installing dependencies with a package manager on Linux, you may need to install the development packages (look for a “-dev” postfix) in addition to the libraries themselves.

Required Dependencies

python 2.7, 3.4, 3.5 or 3.6 [Download python](#).

numpy 1.7.1 (or later) [array support for python \(download numpy\)](#)

setuptools [Setuptools provides extensions for python package installation.](#)

dateutil 1.1 or later [Provides extensions to python datetime handling. If using pip, easy_install or installing from source, the installer will attempt to download and install python_dateutil from PyPI.](#)

pyparsing [Required for matplotlib’s mathtext math rendering support. If using pip, easy_install or installing from source, the installer will attempt to download and install pyparsing from PyPI.](#)

libpng 1.2 (or later) [library for loading and saving PNG files \(download\).](#) libpng requires zlib.

pytz [Used to manipulate time-zone aware datetimes. https://pypi.python.org/pypi/pytz](https://pypi.python.org/pypi/pytz)

FreeType 2.3 or later [Library for reading true type font files. If using pip, easy_install or installing from source, the installer will attempt to locate FreeType in expected locations. If it cannot, try installing pkg-config, a tool used to find required non-python libraries.](#)

cycler 0.10.0 or later [Composable cycle class used for constructing style-cycles](#)

six [Required for compatibility between python 2 and python 3](#)

Dependencies for python 2

functools32 [Required for compatibility if running on Python 2.7.](#)

subprocess32 [Optional, unix only. Backport of the subprocess standard library from 3.2+ for Python 2.7. It provides better error messages and timeout support.](#)

Optional GUI framework

These are optional packages which you may want to install to use matplotlib with a user interface toolkit. See *What is a backend?* for more details on the optional matplotlib backends and the capabilities they provide.

tk 8.3 or later, not 8.6.0 or 8.6.1 The TCL/Tk widgets library used by the TkAgg backend.

Versions 8.6.0 and 8.6.1 are known to have issues that may result in segfaults when closing multiple windows in the wrong order.

pyqt 4.4 or later The Qt4 widgets library python wrappers for the Qt4Agg backend

pygtk 2.4 or later The python wrappers for the GTK widgets library for use with the GTK or GTKAgg backend

wxpython 2.8 or later The python wrappers for the wx widgets library for use with the WX or WXAgg backend

Optional external programs

ffmpeg/avconv or mencoder Required for the animation module to be save out put to movie formats.

ImageMagick Required for the animation module to be able to save to animated gif.

Optional dependencies

Pillow If Pillow is installed, matplotlib can read and write a larger selection of image file formats.

pkg-config A tool used to find required non-python libraries. This is not strictly required, but can make installation go more smoothly if the libraries and headers are not in the expected locations.

Required libraries that ship with matplotlib

agg 2.4 The antigrain C++ rendering engine. matplotlib links against the agg template source statically, so it will not affect anything on your system outside of matplotlib.

qhull 2012.1 A library for computing Delaunay triangulations.

ttconv truetype font utility

2.2.2 Building on Linux

It is easiest to use your system package manager to install the dependencies.

If you are on Debian/Ubuntu, you can get all the dependencies required to build matplotlib with:

```
sudo apt-get build-dep python-matplotlib
```

If you are on Fedora/RedHat, you can get all the dependencies required to build matplotlib by first installing `yum-builddep` and then running:

```
su -c "yum-builddep python-matplotlib"
```

This does not build matplotlib, but it does get the install the build dependencies, which will make building from source easier.

2.2.3 Building on OSX

The build situation on OSX is complicated by the various places one can get the libpng and freetype requirements (darwinports, fink, /usr/X11R6) and the different architectures (e.g., x86, ppc, universal) and the different OSX version (e.g., 10.4 and 10.5). We recommend that you build the way we do for the OSX release: get the source from the tarball or the git repository and follow the instruction in `README.osx`.

2.2.4 Building on Windows

The Python shipped from <https://www.python.org> is compiled with Visual Studio 2008 for versions before 3.3, Visual Studio 2010 for 3.3 and 3.4, and Visual Studio 2015 for 3.5 and 3.6. Python extensions are recommended to be compiled with the same compiler.

Since there is no canonical Windows package manager, the methods for building freetype, zlib, and libpng from source code are documented as a build script at `matplotlib-winbuild`.

3.1 Introductory

3.1.1 Pyplot tutorial

matplotlib.pyplot is a collection of command style functions that make matplotlib work like MATLAB. Each pyplot function makes some change to a figure: e.g., creates a figure, creates a plotting area in a figure, plots some lines in a plotting area, decorates the plot with labels, etc. In *matplotlib.pyplot* various states are preserved across function calls, so that it keeps track of things like the current figure and plotting area, and the plotting functions are directed to the current axes (please note that “axes” here and in most places in the documentation refers to the *axes part of a figure* and not the strict mathematical term for more than one axis).

```
import matplotlib.pyplot as plt
plt.plot([1,2,3,4])
plt.ylabel('some numbers')
plt.show()
```

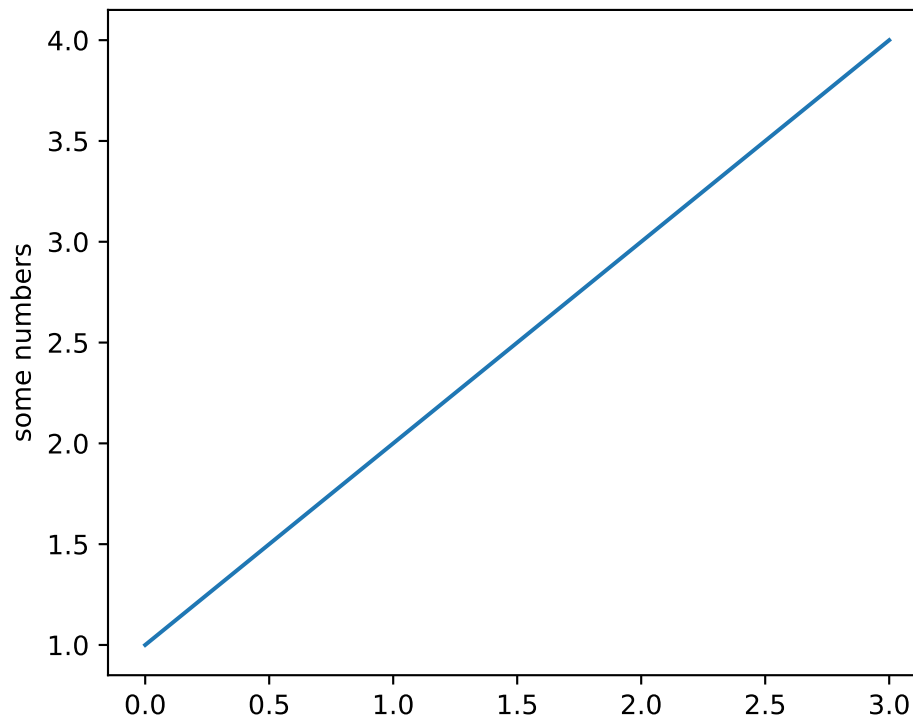

You may be wondering why the x-axis ranges from 0-3 and the y-axis from 1-4. If you provide a single list or array to the `plot()` command, matplotlib assumes it is a sequence of y values, and automatically generates the x values for you. Since python ranges start with 0, the default x vector has the same length as y but starts with 0. Hence the x data are `[0, 1, 2, 3]`.

`plot()` is a versatile command, and will take an arbitrary number of arguments. For example, to plot x versus y, you can issue the command:

```
plt.plot([1, 2, 3, 4], [1, 4, 9, 16])
```

For every x, y pair of arguments, there is an optional third argument which is the format string that indicates the color and line type of the plot. The letters and symbols of the format string are from MATLAB, and you concatenate a color string with a line style string. The default format string is 'b-', which is a solid blue line. For example, to plot the above with red circles, you would issue

```
import matplotlib.pyplot as plt
plt.plot([1,2,3,4], [1,4,9,16], 'ro')
plt.axis([0, 6, 0, 20])
plt.show()
```

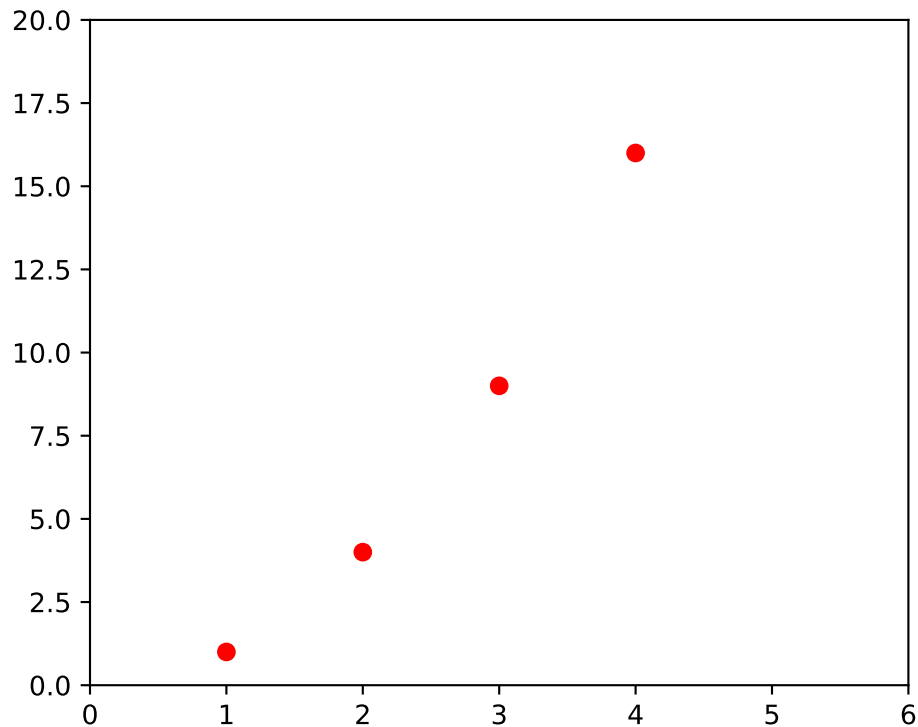

See the `plot()` documentation for a complete list of line styles and format strings. The `axis()` command in the example above takes a list of `[xmin, xmax, ymin, ymax]` and specifies the viewport of the axes.

If matplotlib were limited to working with lists, it would be fairly useless for numeric processing. Generally, you will use `numpy` arrays. In fact, all sequences are converted to `numpy` arrays internally. The example below illustrates a plotting several lines with different format styles in one command using arrays.

```
import numpy as np
import matplotlib.pyplot as plt

# evenly sampled time at 200ms intervals
t = np.arange(0., 5., 0.2)

# red dashes, blue squares and green triangles
plt.plot(t, t, 'r--', t, t**2, 'bs', t, t**3, 'g^')
plt.show()
```

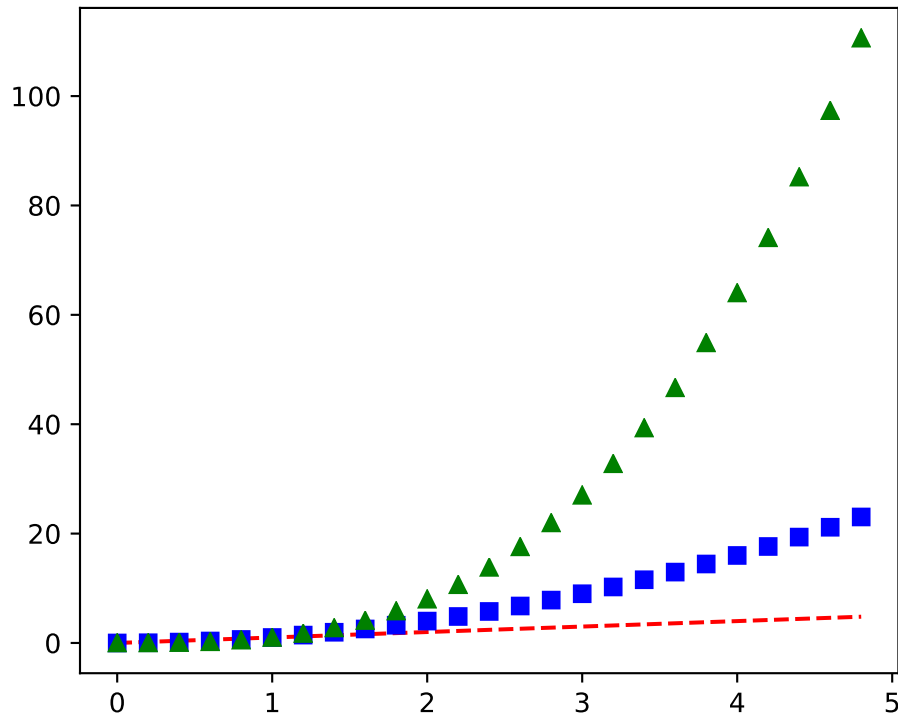

Controlling line properties

Lines have many attributes that you can set: linewidth, dash style, antialiased, etc; see [matplotlib.lines.Line2D](#). There are several ways to set line properties

- Use keyword args:

```
plt.plot(x, y, linewidth=2.0)
```

- Use the setter methods of a `Line2D` instance. `plot` returns a list of `Line2D` objects; e.g., `line1, line2 = plot(x1, y1, x2, y2)`. In the code below we will suppose that we have only one line so that the list returned is of length 1. We use tuple unpacking with `line`, to get the first element of that list:

```
line, = plt.plot(x, y, '-')
line.set_antialiased(False) # turn off antialiasing
```

- Use the `setp()` command. The example below uses a MATLAB-style command to set multiple properties on a list of lines. `setp` works transparently with a list of objects or a single object. You can either use python keyword arguments or MATLAB-style string/value pairs:

```
lines = plt.plot(x1, y1, x2, y2)
# use keyword args
plt.setp(lines, color='r', linewidth=2.0)
```

```
# or MATLAB style string value pairs
plt.setp(lines, 'color', 'r', 'linewidth', 2.0)
```

Here are the available *Line2D* properties.

Property	Value Type
alpha	float
animated	[True False]
antialiased or aa	[True False]
clip_box	a matplotlib.transform.Bbox instance
clip_on	[True False]
clip_path	a Path instance and a Transform instance, a Patch
color or c	any matplotlib color
contains	the hit testing function
dash_capstyle	['butt' 'round' 'projecting']
dash_joinstyle	['miter' 'round' 'bevel']
dashes	sequence of on/off ink in points
data	(np.array xdata, np.array ydata)
figure	a matplotlib.figure.Figure instance
label	any string
linestyle or ls	['-' '--' '-.' ':' 'steps' ...]
linewidth or lw	float value in points
lod	[True False]
marker	['+' ',' '.' '1' '2' '3' '4']
markeredgecolor or mec	any matplotlib color
markeredgewidth or mew	float value in points
markerfacecolor or mfc	any matplotlib color
markersize or ms	float
markevery	[None integer (startind, stride)]
picker	used in interactive line selection
pickradius	the line pick selection radius
solid_capstyle	['butt' 'round' 'projecting']
solid_joinstyle	['miter' 'round' 'bevel']
transform	a matplotlib.transforms.Transform instance
visible	[True False]
xdata	np.array
ydata	np.array
zorder	any number

To get a list of settable line properties, call the `setp()` function with a line or lines as argument

```
In [69]: lines = plt.plot([1, 2, 3])
```

```
In [70]: plt.setp(lines)
alpha: float
animated: [True | False]
antialiased or aa: [True | False]
```

```
...snip
```

Working with multiple figures and axes

MATLAB, and *pyplot*, have the concept of the current figure and the current axes. All plotting commands apply to the current axes. The function *gca()* returns the current axes (a *matplotlib.axes.Axes* instance), and *gcf()* returns the current figure (*matplotlib.figure.Figure* instance). Normally, you don't have to worry about this, because it is all taken care of behind the scenes. Below is a script to create two subplots.

```
import numpy as np
import matplotlib.pyplot as plt

def f(t):
    return np.exp(-t) * np.cos(2*np.pi*t)

t1 = np.arange(0.0, 5.0, 0.1)
t2 = np.arange(0.0, 5.0, 0.02)

plt.figure(1)
plt.subplot(211)
plt.plot(t1, f(t1), 'bo', t2, f(t2), 'k')

plt.subplot(212)
plt.plot(t2, np.cos(2*np.pi*t2), 'r--')
plt.show()
```

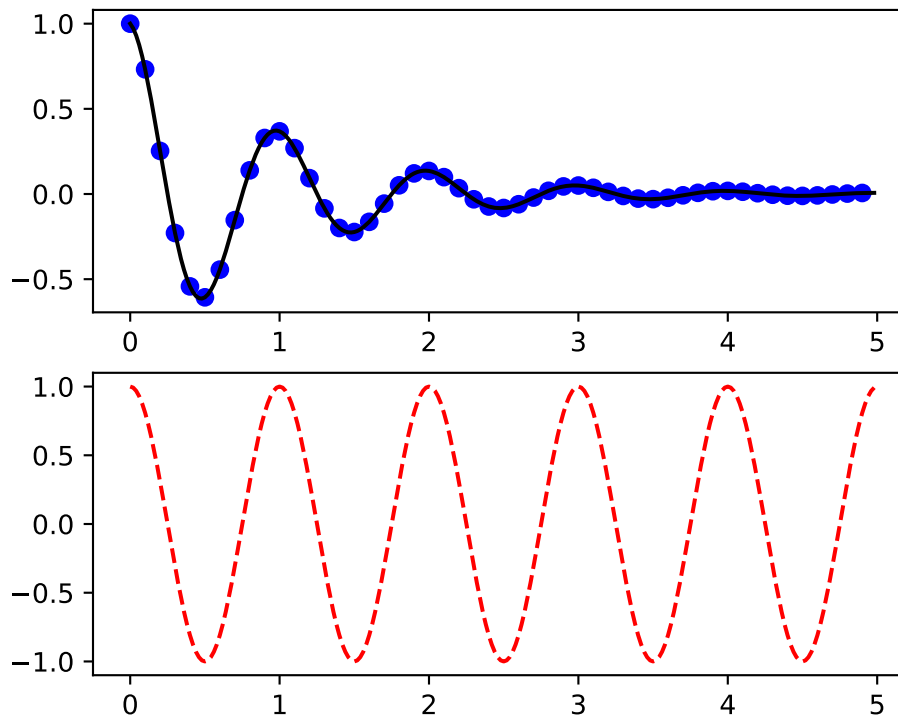

The `figure()` command here is optional because `figure(1)` will be created by default, just as a `subplot(111)` will be created by default if you don't manually specify any axes. The `subplot()` command specifies `numrows`, `numcols`, `fignum` where `fignum` ranges from 1 to `numrows*numcols`. The commas in the subplot command are optional if `numrows*numcols < 10`. So `subplot(211)` is identical to `subplot(2, 1, 1)`. You can create an arbitrary number of subplots and axes. If you want to place an axes manually, i.e., not on a rectangular grid, use the `axes()` command, which allows you to specify the location as `axes([left, bottom, width, height])` where all values are in fractional (0 to 1) coordinates. See [pylab_examples example code: axes_demo.py](#) for an example of placing axes manually and [pylab_examples example code: subplots_demo.py](#) for an example with lots of subplots.

You can create multiple figures by using multiple `figure()` calls with an increasing figure number. Of course, each figure can contain as many axes and subplots as your heart desires:

```
import matplotlib.pyplot as plt
plt.figure(1)           # the first figure
plt.subplot(211)       # the first subplot in the first figure
plt.plot([1, 2, 3])
plt.subplot(212)       # the second subplot in the first figure
plt.plot([4, 5, 6])

plt.figure(2)          # a second figure
plt.plot([4, 5, 6])    # creates a subplot(111) by default

plt.figure(1)          # figure 1 current; subplot(212) still current
```

```
plt.subplot(211)          # make subplot(211) in figure1 current
plt.title('Easy as 1, 2, 3') # subplot 211 title
```

You can clear the current figure with `clf()` and the current axes with `cla()`. If you find it annoying that states (specifically the current image, figure and axes) are being maintained for you behind the scenes, don't despair: this is just a thin stateful wrapper around an object oriented API, which you can use instead (see *Artist tutorial*)

If you are making lots of figures, you need to be aware of one more thing: the memory required for a figure is not completely released until the figure is explicitly closed with `close()`. Deleting all references to the figure, and/or using the window manager to kill the window in which the figure appears on the screen, is not enough, because pyplot maintains internal references until `close()` is called.

Working with text

The `text()` command can be used to add text in an arbitrary location, and the `xlabel()`, `ylabel()` and `title()` are used to add text in the indicated locations (see *Text introduction* for a more detailed example)

```
import numpy as np
import matplotlib.pyplot as plt

# Fixing random state for reproducibility
np.random.seed(19680801)

mu, sigma = 100, 15
x = mu + sigma * np.random.randn(10000)

# the histogram of the data
n, bins, patches = plt.hist(x, 50, normed=1, facecolor='g', alpha=0.75)

plt.xlabel('Smarts')
plt.ylabel('Probability')
plt.title('Histogram of IQ')
plt.text(60, .025, r'\mu=100, \sigma=15$')
plt.axis([40, 160, 0, 0.03])
plt.grid(True)
plt.show()
```

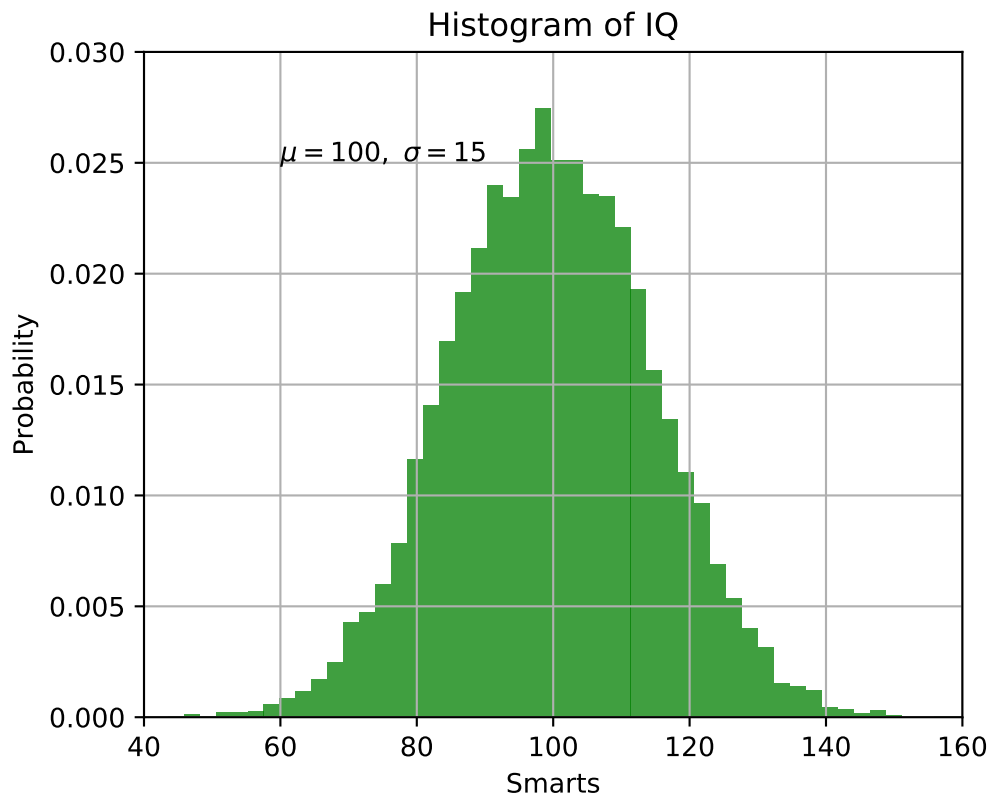
All of the `text()` commands return an `matplotlib.text.Text` instance. Just as with with lines above, you can customize the properties by passing keyword arguments into the text functions or using `setp()`:

```
t = plt.xlabel('my data', fontsize=14, color='red')
```

These properties are covered in more detail in *Text properties and layout*.

Using mathematical expressions in text

matplotlib accepts TeX equation expressions in any text expression. For example to write the expression $\sigma_i = 15$ in the title, you can write a TeX expression surrounded by dollar signs:

```
plt.title(r'\sigma_i=15')
```

The `r` preceding the title string is important – it signifies that the string is a *raw* string and not to treat backslashes as python escapes. matplotlib has a built-in TeX expression parser and layout engine, and ships its own math fonts – for details see *Writing mathematical expressions*. Thus you can use mathematical text across platforms without requiring a TeX installation. For those who have LaTeX and dvipng installed, you can also use LaTeX to format your text and incorporate the output directly into your display figures or saved postscript – see *Text rendering With LaTeX*.

Annotating text

The uses of the basic `text()` command above place text at an arbitrary position on the Axes. A common use for text is to annotate some feature of the plot, and the `annotate()` method provides helper functionality to make annotations easy. In an annotation, there are two points to consider: the location being annotated represented by the argument `xy` and the location of the text `xytext`. Both of these arguments are `(x,y)` tuples.

```
import numpy as np
import matplotlib.pyplot as plt

ax = plt.subplot(111)

t = np.arange(0.0, 5.0, 0.01)
s = np.cos(2*np.pi*t)
line, = plt.plot(t, s, lw=2)

plt.annotate('local max', xy=(2, 1), xytext=(3, 1.5),
            arrowprops=dict(facecolor='black', shrink=0.05),
            )

plt.ylim(-2,2)
plt.show()
```

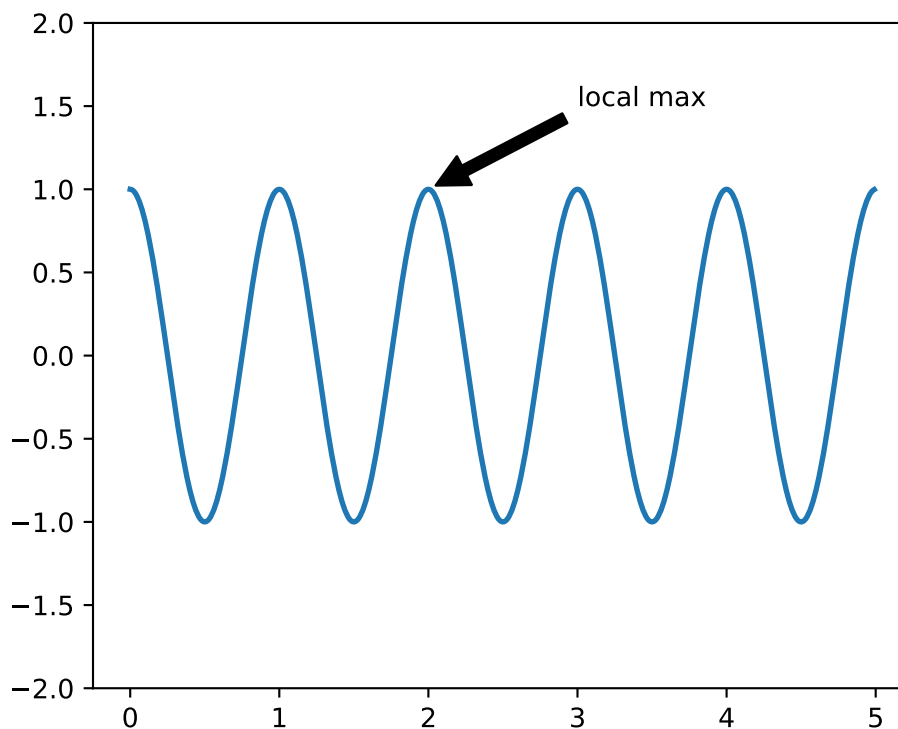

In this basic example, both the `xy` (arrow tip) and `xytext` locations (text location) are in data coordinates.

There are a variety of other coordinate systems one can choose – see *Basic annotation* and *Advanced Annotation* for details. More examples can be found in *pylab_examples example code: annotation_demo.py*.

Logarithmic and other nonlinear axes

`matplotlib.pyplot` supports not only linear axis scales, but also logarithmic and logit scales. This is commonly used if data spans many orders of magnitude. Changing the scale of an axis is easy:

```
plt.xscale('log')
```

An example of four plots with the same data and different scales for the y axis is shown below.

```
import numpy as np
import matplotlib.pyplot as plt

from matplotlib.ticker import NullFormatter # useful for `logit` scale

# Fixing random state for reproducibility
np.random.seed(19680801)

# make up some data in the interval ]0, 1[
y = np.random.normal(loc=0.5, scale=0.4, size=1000)
y = y[(y > 0) & (y < 1)]
y.sort()
x = np.arange(len(y))

# plot with various axes scales
plt.figure(1)

# linear
plt.subplot(221)
plt.plot(x, y)
plt.yscale('linear')
plt.title('linear')
plt.grid(True)

# log
plt.subplot(222)
plt.plot(x, y)
plt.yscale('log')
plt.title('log')
plt.grid(True)

# symmetric log
plt.subplot(223)
plt.plot(x, y - y.mean())
plt.yscale('symlog', linthreshy=0.01)
plt.title('symlog')
plt.grid(True)

# logit
```

```

plt.subplot(224)
plt.plot(x, y)
plt.yscale('logit')
plt.title('logit')
plt.grid(True)
# Format the minor tick labels of the y-axis into empty strings with
# `NullFormatter`, to avoid cumbering the axis with too many labels.
plt.gca().yaxis.set_minor_formatter(NullFormatter())
# Adjust the subplot layout, because the logit one may take more space
# than usual, due to y-tick labels like "1 - 10^{-3}"
plt.subplots_adjust(top=0.92, bottom=0.08, left=0.10, right=0.95, hspace=0.25,
                    wspace=0.35)

plt.show()

```

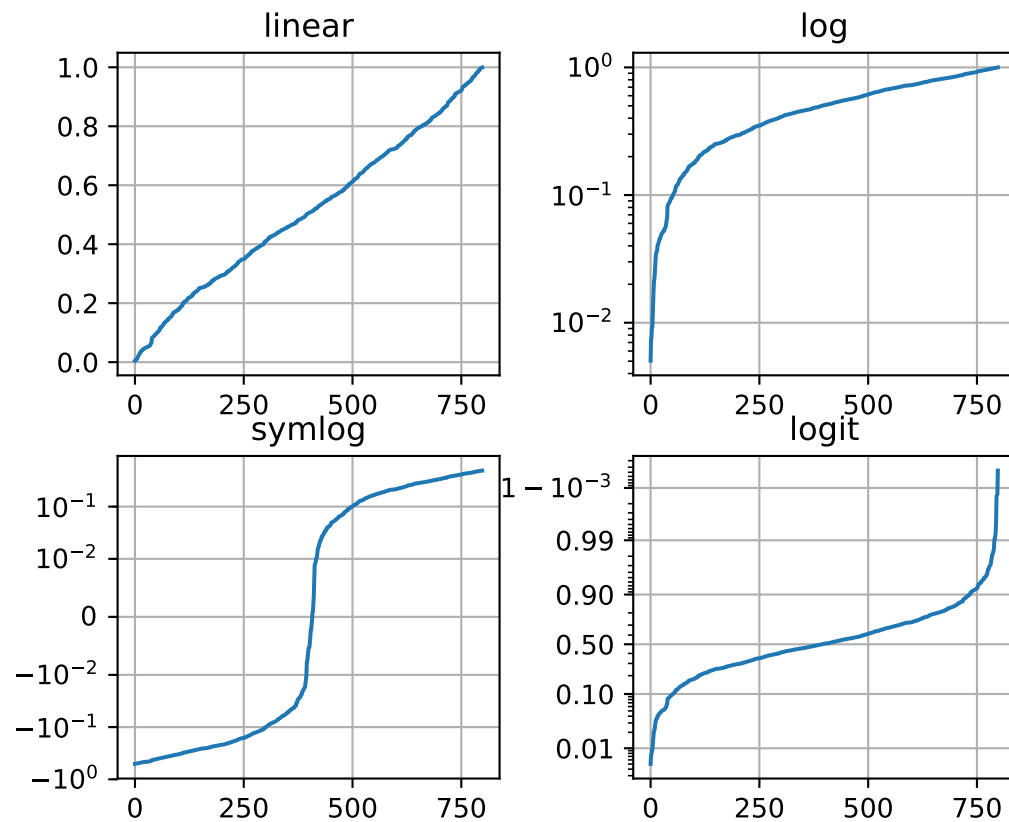

It is also possible to add your own scale, see *Developer's guide for creating scales and transformations* for details.

3.1.2 Image tutorial

Startup commands

First, let's start IPython. It is a most excellent enhancement to the standard Python prompt, and it ties in especially well with Matplotlib. Start IPython either at a shell, or the IPython Notebook now.

With IPython started, we now need to connect to a GUI event loop. This tells IPython where (and how) to display plots. To connect to a GUI loop, execute the `%matplotlib` magic at your IPython prompt. There's more detail on exactly what this does at [IPython's documentation on GUI event loops](#).

If you're using IPython Notebook, the same commands are available, but people commonly use a specific argument to the `%matplotlib` magic:

```
In [1]: %matplotlib inline
```

This turns on inline plotting, where plot graphics will appear in your notebook. This has important implications for interactivity. For inline plotting, commands in cells below the cell that outputs a plot will not affect the plot. For example, changing the color map is not possible from cells below the cell that creates a plot. However, for other backends, such as qt4, that open a separate window, cells below those that create the plot will change the plot - it is a live object in memory.

This tutorial will use matplotlib's imperative-style plotting interface, `pyplot`. This interface maintains global state, and is very useful for quickly and easily experimenting with various plot settings. The alternative is the object-oriented interface, which is also very powerful, and generally more suitable for large application development. If you'd like to learn about the object-oriented interface, a great place to start is our [FAQ on usage](#). For now, let's get on with the imperative-style approach:

```
In [2]: import matplotlib.pyplot as plt
In [3]: import matplotlib.image as mpimg
In [4]: import numpy as np
```

Importing image data into Numpy arrays

Loading image data is supported by the [Pillow](#) library. Natively, matplotlib only supports PNG images. The commands shown below fall back on Pillow if the native read fails.

The image used in this example is a PNG file, but keep that Pillow requirement in mind for your own data.

Here's the image we're going to play with:



It's a 24-bit RGB PNG image (8 bits for each of R, G, B). Depending on where you get your data, the other kinds of image that you'll most likely encounter are RGBA images, which allow for transparency, or single-channel grayscale (luminosity) images. You can right click on it and choose "Save image as" to download it to your computer for the rest of this tutorial.

And here we go...

```
In [5]: img=mpimg.imread('stinkbug.png')
Out[5]:
array([[ 0.40784314,  0.40784314,  0.40784314],
       [ 0.40784314,  0.40784314,  0.40784314],
       [ 0.40784314,  0.40784314,  0.40784314],
       ...,
       [ 0.42745098,  0.42745098,  0.42745098],
       [ 0.42745098,  0.42745098,  0.42745098],
       [ 0.42745098,  0.42745098,  0.42745098]],
      ...,
      [[ 0.44313726,  0.44313726,  0.44313726],
       [ 0.4509804 ,  0.4509804 ,  0.4509804 ],
       [ 0.4509804 ,  0.4509804 ,  0.4509804 ],
       ...,
       [ 0.44705883,  0.44705883,  0.44705883],
```

```
[ 0.44705883,  0.44705883,  0.44705883],
 [ 0.44313726,  0.44313726,  0.44313726]]], dtype=float32)
```

Note the dtype there - float32. Matplotlib has rescaled the 8 bit data from each channel to floating point data between 0.0 and 1.0. As a side note, the only datatype that Pillow can work with is uint8. Matplotlib plotting can handle float32 and uint8, but image reading/writing for any format other than PNG is limited to uint8 data. Why 8 bits? Most displays can only render 8 bits per channel worth of color gradation. Why can they only render 8 bits/channel? Because that's about all the human eye can see. More here (from a photography standpoint): [Luminous Landscape bit depth tutorial](#).

Each inner list represents a pixel. Here, with an RGB image, there are 3 values. Since it's a black and white image, R, G, and B are all similar. An RGBA (where A is alpha, or transparency), has 4 values per inner list, and a simple luminance image just has one value (and is thus only a 2-D array, not a 3-D array). For RGB and RGBA images, matplotlib supports float32 and uint8 data types. For grayscale, matplotlib supports only float32. If your array data does not meet one of these descriptions, you need to rescale it.

Plotting numpy arrays as images

So, you have your data in a numpy array (either by importing it, or by generating it). Let's render it. In Matplotlib, this is performed using the `imshow()` function. Here we'll grab the plot object. This object gives you an easy way to manipulate the plot from the prompt.

```
In [6]: imgplot = plt.imshow(img)
```

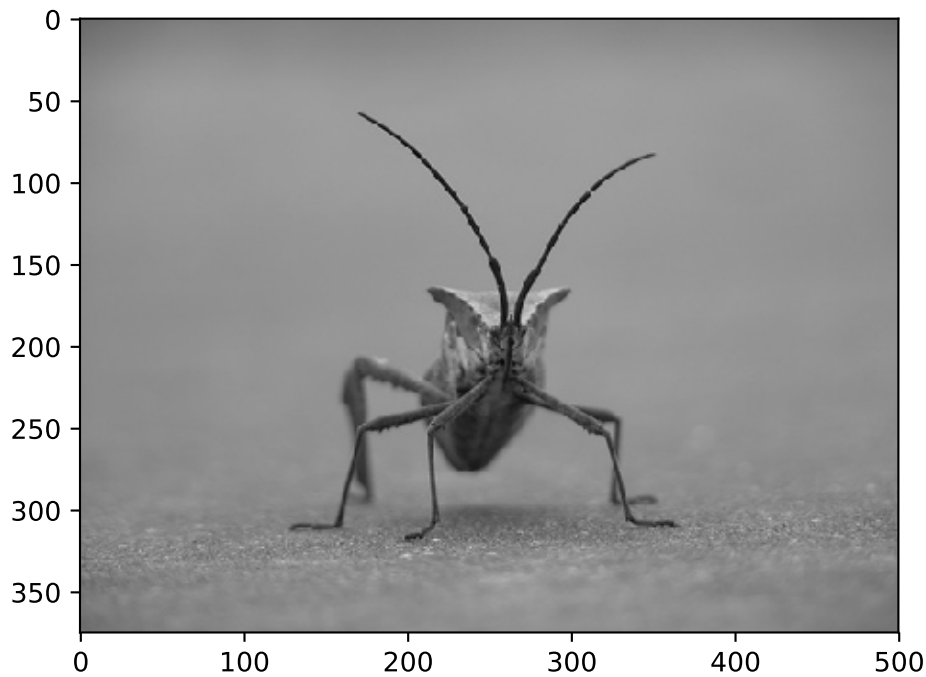

You can also plot any numpy array.

Applying pseudocolor schemes to image plots

Pseudocolor can be a useful tool for enhancing contrast and visualizing your data more easily. This is especially useful when making presentations of your data using projectors - their contrast is typically quite poor.

Pseudocolor is only relevant to single-channel, grayscale, luminosity images. We currently have an RGB image. Since R, G, and B are all similar (see for yourself above or in your data), we can just pick one channel of our data:

```
In [7]: lum_img = img[:, :, 0]
```

This is array slicing. You can read more in the [Numpy tutorial](#).

```
In [8]: plt.imshow(lum_img)
```

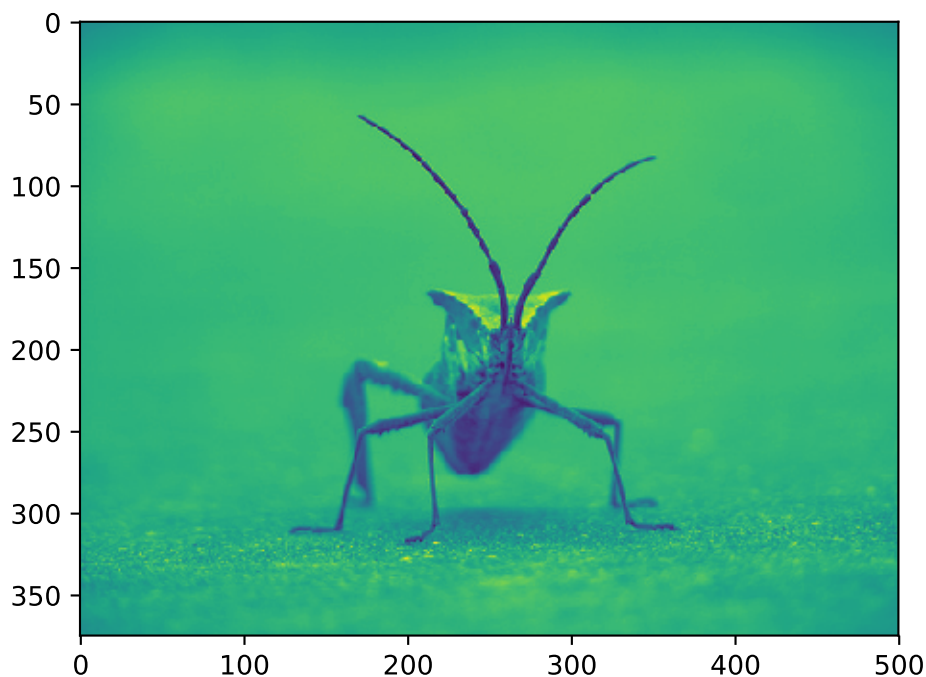

Now, with a luminosity (2D, no color) image, the default colormap (aka lookup table, LUT), is applied. The default is called viridis. There are plenty of others to choose from.

```
In [9]: plt.imshow(lum_img, cmap="hot")
```

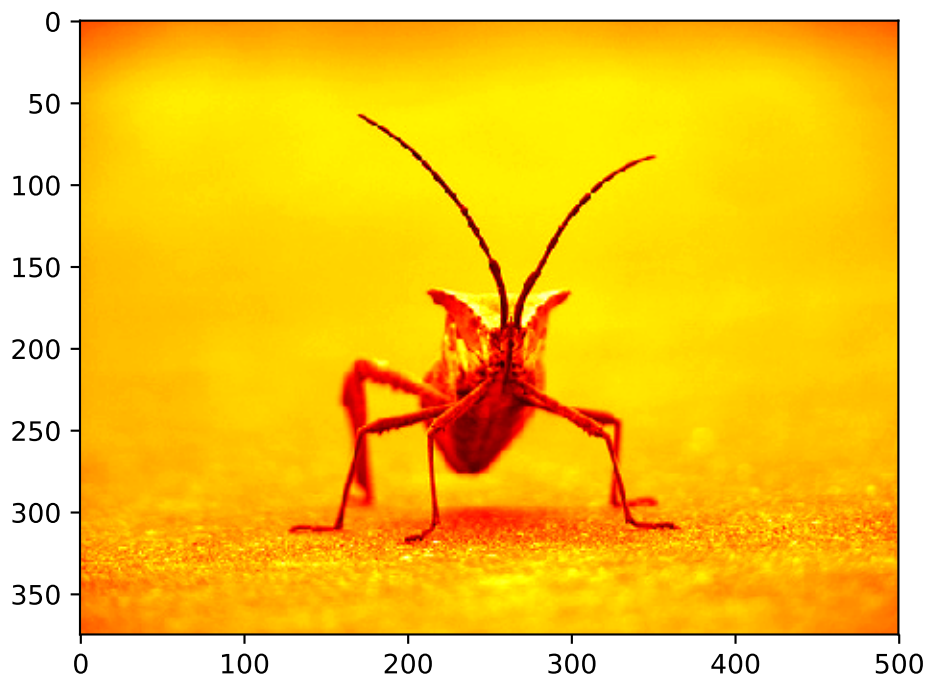
Note that you can also change colormaps on existing plot objects using the `set_cmap()` method:

```
In [10]: imgplot = plt.imshow(lum_img)
In [11]: imgplot.set_cmap('nipy_spectral')
```

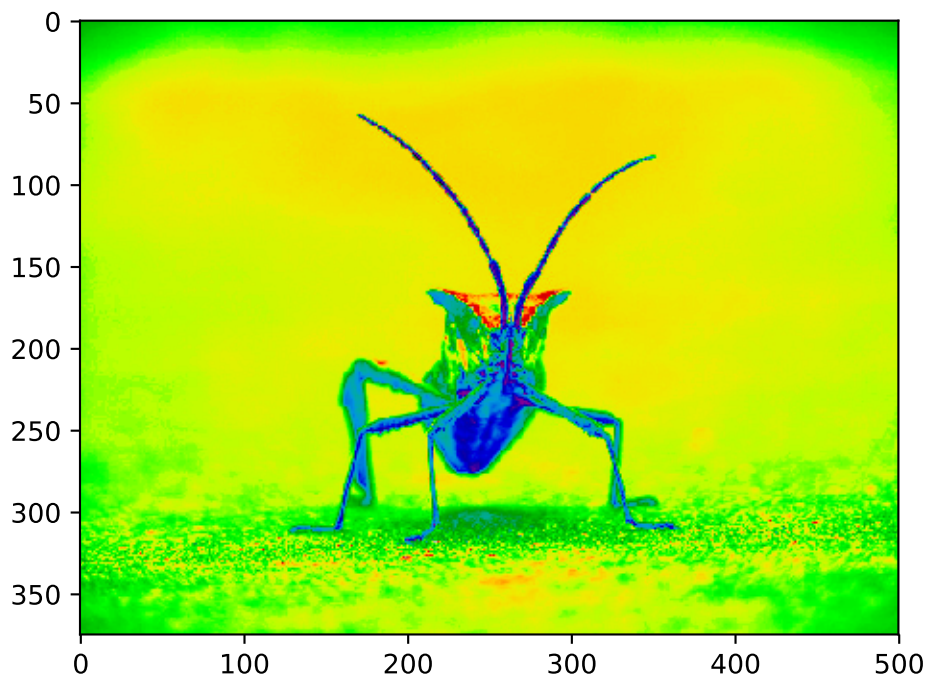

Note: However, remember that in the IPython notebook with the inline backend, you can't make changes to plots that have already been rendered. If you create `imgplot` here in one cell, you cannot call `set_cmap()` on it in a later cell and expect the earlier plot to change. Make sure that you enter these commands together in one cell. `plt` commands will not change plots from earlier cells.

There are many other colormap schemes available. See the list and images of the colormaps.

Color scale reference

It's helpful to have an idea of what value a color represents. We can do that by adding color bars.

```
In [12]: imgplot = plt.imshow(lum_img)
In [13]: plt.colorbar()
```

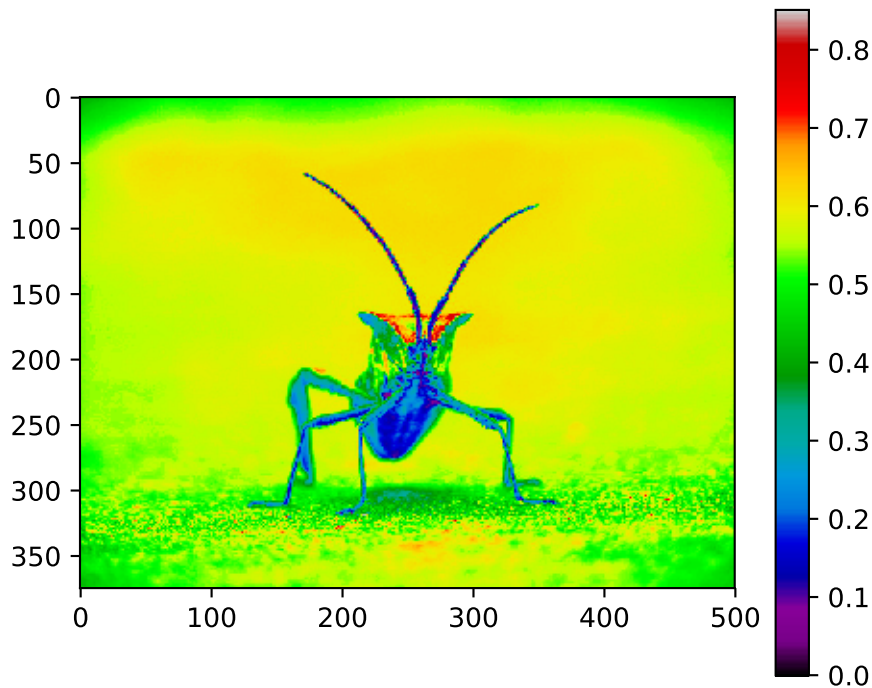

This adds a colorbar to your existing figure. This won't automatically change if you change you switch to a different colormap - you have to re-create your plot, and add in the colorbar again.

Examining a specific data range

Sometimes you want to enhance the contrast in your image, or expand the contrast in a particular region while sacrificing the detail in colors that don't vary much, or don't matter. A good tool to find interesting regions is the histogram. To create a histogram of our image data, we use the `hist()` function.

```
In [14]: plt.hist(lum_img.ravel(), bins=256, range=(0.0, 1.0), fc='k', ec='k')
```

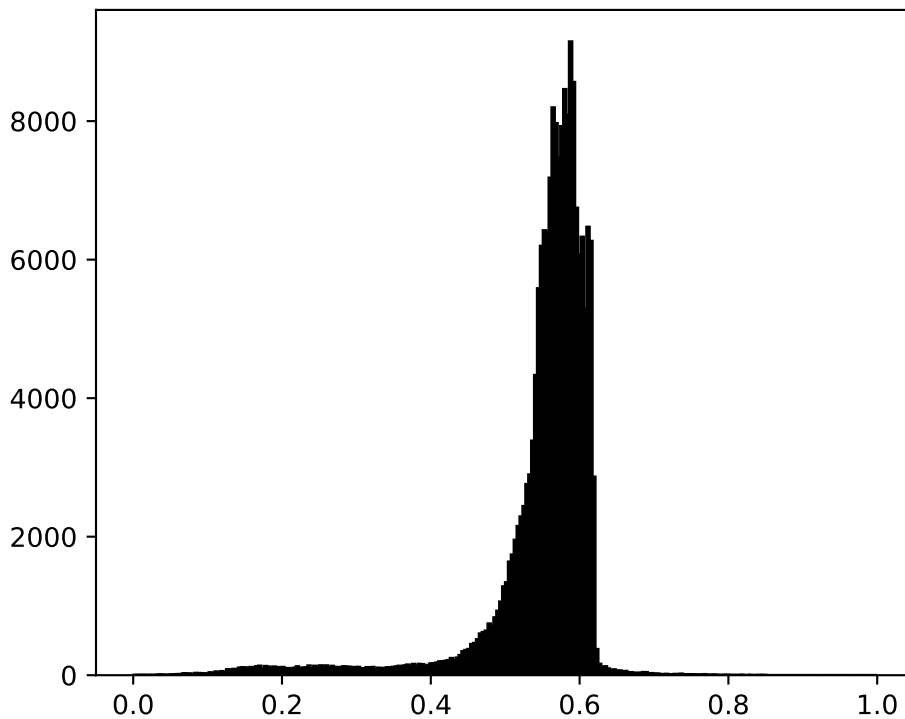

Most often, the “interesting” part of the image is around the peak, and you can get extra contrast by clipping the regions above and/or below the peak. In our histogram, it looks like there’s not much useful information in the high end (not many white things in the image). Let’s adjust the upper limit, so that we effectively “zoom in on” part of the histogram. We do this by passing the `clim` argument to `imshow`. You could also do this by calling the `set_clim()` method of the image plot object, but make sure that you do so in the same cell as your plot command when working with the IPython Notebook - it will not change plots from earlier cells.

```
In [15]: imgplot = plt.imshow(lum_img, clim=(0.0, 0.7))
```

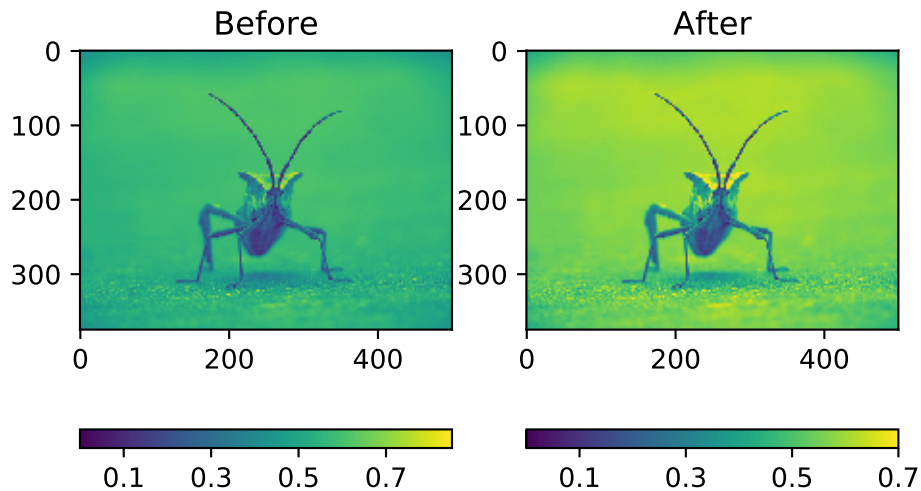

Array Interpolation schemes

Interpolation calculates what the color or value of a pixel “should” be, according to different mathematical schemes. One common place that this happens is when you resize an image. The number of pixels change, but you want the same information. Since pixels are discrete, there’s missing space. Interpolation is how you fill that space. This is why your images sometimes come out looking pixelated when you blow them up. The effect is more pronounced when the difference between the original image and the expanded image is greater. Let’s take our image and shrink it. We’re effectively discarding pixels, only keeping a select few. Now when we plot it, that data gets blown up to the size on your screen. The old pixels aren’t there anymore, and the computer has to draw in pixels to fill that space.

We’ll use the Pillow library that we used to load the image also to resize the image.

```
In [16]: from PIL import Image
In [17]: img = Image.open('../_static/stinkbug.png')
In [18]: img.thumbnail((64, 64), Image.ANTIALIAS) # resizes image in-place
In [19]: imgplot = plt.imshow(img)
```

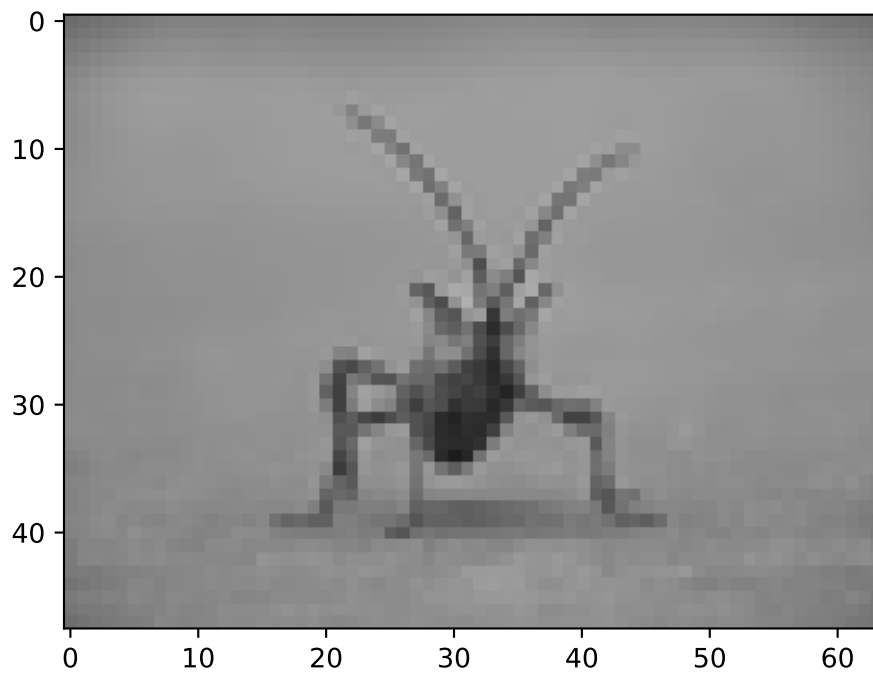

Here we have the default interpolation, bilinear, since we did not give `imshow()` any interpolation argument.

Let's try some others:

```
In [20]: imgplot = plt.imshow(img, interpolation="nearest")
```

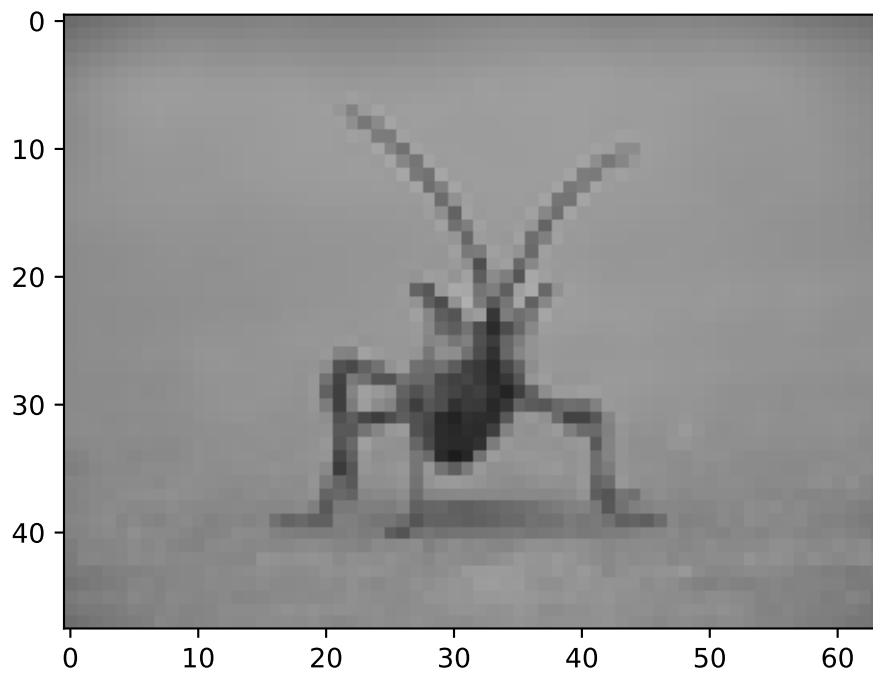

```
In [21]: imgplot = plt.imshow(img, interpolation="bicubic")
```

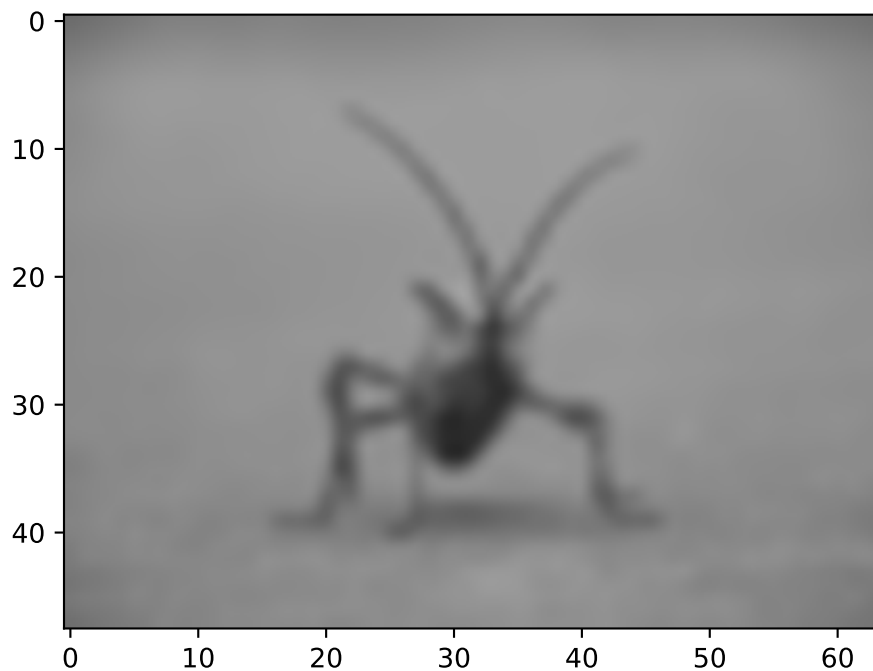

Bicubic interpolation is often used when blowing up photos - people tend to prefer blurry over pixelated.

3.1.3 Customizing Location of Subplot Using GridSpec

GridSpec specifies the geometry of the grid that a subplot will be placed. The number of rows and number of columns of the grid need to be set. Optionally, the subplot layout parameters (e.g., left, right, etc.) can be tuned.

SubplotSpec specifies the location of the subplot in the given *GridSpec*.

`subplot2grid()` a helper function that is similar to `subplot()` but uses 0-based indexing and let subplot to occupy multiple cells.

Basic Example of using subplot2grid

To use `subplot2grid()`, you provide geometry of the grid and the location of the subplot in the grid. For a simple single-cell subplot:

```
ax = plt.subplot2grid((2, 2), (0, 0))
```

is identical to

```
ax = plt.subplot(2, 2, 1)
```

Note that, unlike Matplotlib's subplot, the index starts from 0 in GridSpec.

To create a subplot that spans multiple cells,

```
ax2 = plt.subplot2grid((3, 3), (1, 0), colspan=2)
ax3 = plt.subplot2grid((3, 3), (1, 2), rowspan=2)
```

For example, the following commands

```
ax1 = plt.subplot2grid((3, 3), (0, 0), colspan=3)
ax2 = plt.subplot2grid((3, 3), (1, 0), colspan=2)
ax3 = plt.subplot2grid((3, 3), (1, 2), rowspan=2)
ax4 = plt.subplot2grid((3, 3), (2, 0))
ax5 = plt.subplot2grid((3, 3), (2, 1))
```

creates

subplot2grid

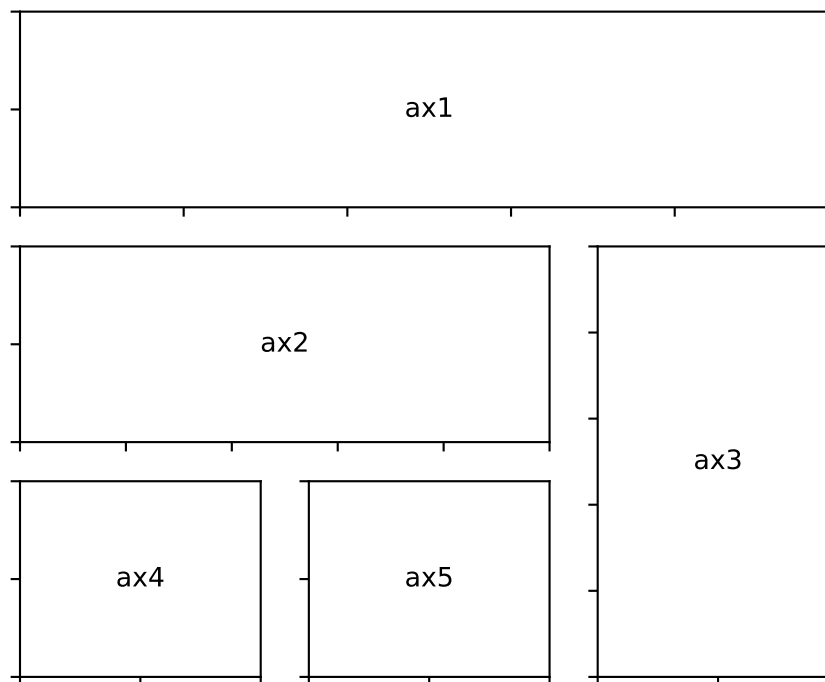

GridSpec and SubplotSpec

You can create *GridSpec* explicitly and use them to create a subplot.

For example,

```
ax = plt.subplot2grid((2, 2), (0, 0))
```

is equal to

```
import matplotlib.gridspec as gridspec
gs = gridspec.GridSpec(2, 2)
ax = plt.subplot(gs[0, 0])
```

A GridSpec instance provides array-like (2d or 1d) indexing that returns the SubplotSpec instance. For a SubplotSpec that spans multiple cells, use slice.

```
ax2 = plt.subplot(gs[1, :-1])
ax3 = plt.subplot(gs[1:, -1])
```

The above example becomes

```
gs = gridspec.GridSpec(3, 3)
ax1 = plt.subplot(gs[0, :])
ax2 = plt.subplot(gs[1, :-1])
ax3 = plt.subplot(gs[1:, -1])
ax4 = plt.subplot(gs[-1, 0])
ax5 = plt.subplot(gs[-1, -2])
```

GridSpec

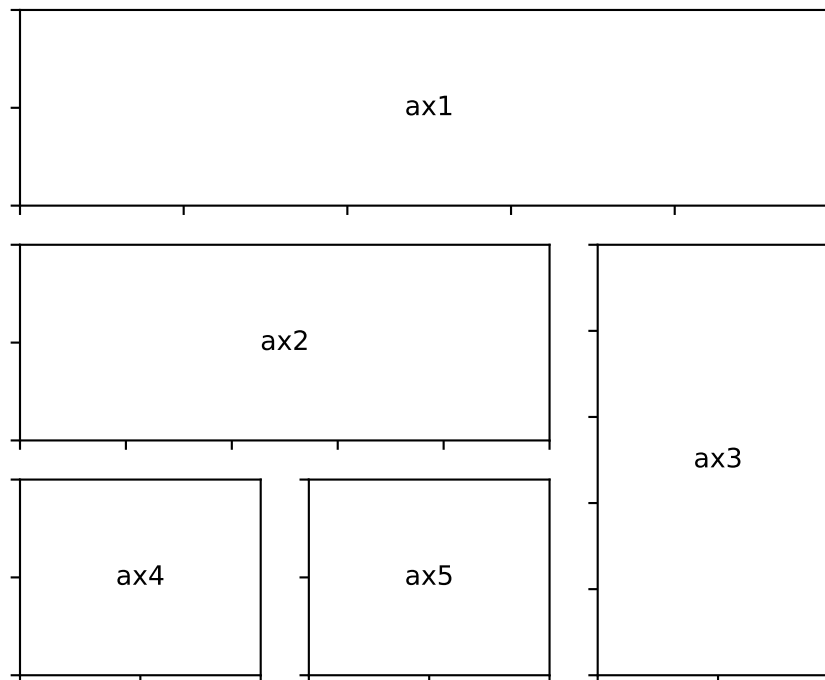

Adjust GridSpec layout

When a GridSpec is explicitly used, you can adjust the layout parameters of subplots that are created from the GridSpec.

```
gs1 = gridspec.GridSpec(3, 3)
gs1.update(left=0.05, right=0.48, wspace=0.05)
```

This is similar to `subplots_adjust()`, but it only affects the subplots that are created from the given GridSpec.

The code below

```
gs1 = gridspec.GridSpec(3, 3)
gs1.update(left=0.05, right=0.48, wspace=0.05)
ax1 = plt.subplot(gs1[:-1, :])
ax2 = plt.subplot(gs1[-1, :-1])
ax3 = plt.subplot(gs1[-1, -1])

gs2 = gridspec.GridSpec(3, 3)
gs2.update(left=0.55, right=0.98, hspace=0.05)
ax4 = plt.subplot(gs2[:, :-1])
ax5 = plt.subplot(gs2[-1, -1])
ax6 = plt.subplot(gs2[-1, -1])
```

creates

GridSpec w/ different subplotpars

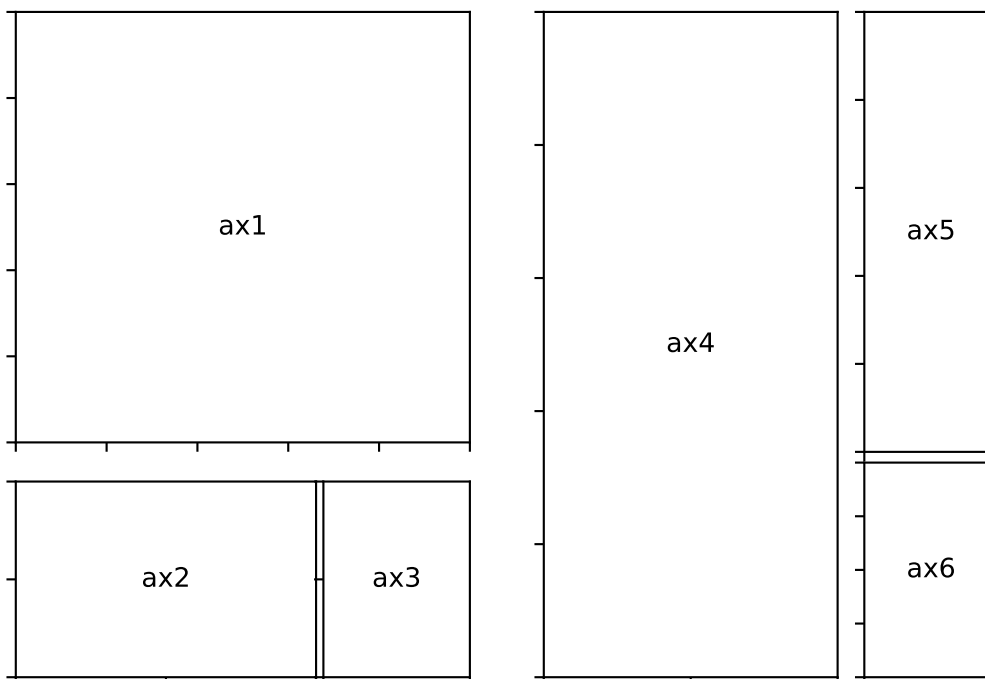

GridSpec using SubplotSpec

You can create `GridSpec` from the `SubplotSpec`, in which case its layout parameters are set to that of the location of the given `SubplotSpec`.

```
gs0 = gridspec.GridSpec(1, 2)

gs00 = gridspec.GridSpecFromSubplotSpec(3, 3, subplot_spec=gs0[0])
gs01 = gridspec.GridSpecFromSubplotSpec(3, 3, subplot_spec=gs0[1])
```

GridSpec Inside GridSpec

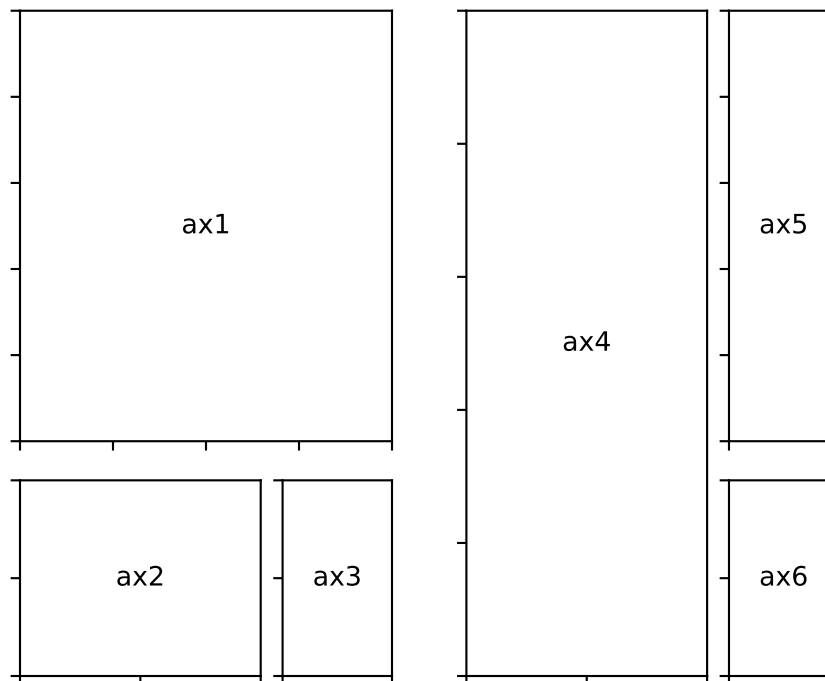

A Complex Nested GridSpec using SubplotSpec

Here's a more sophisticated example of nested `GridSpec` where we put a box around each cell of the outer `4x4` grid, by hiding appropriate spines in each of the inner `3x3` grids.

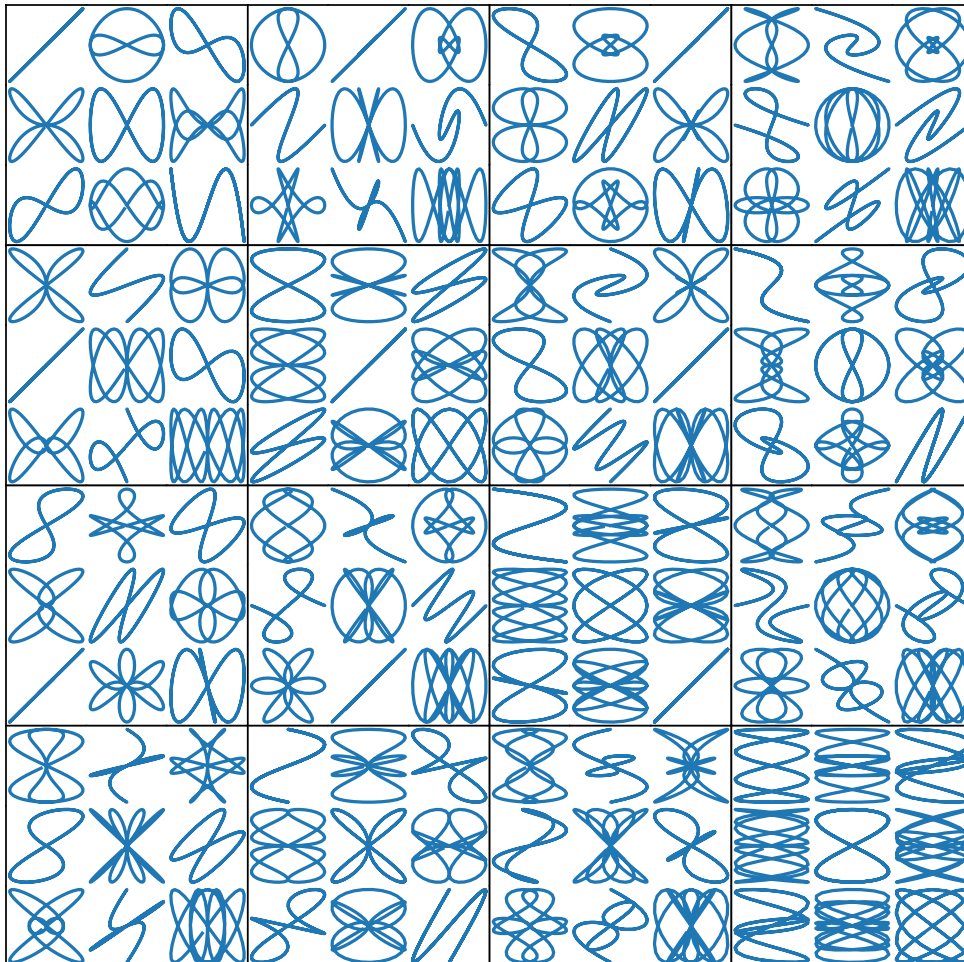

GridSpec with Varying Cell Sizes

By default, GridSpec creates cells of equal sizes. You can adjust relative heights and widths of rows and columns. Note that absolute values are meaningless, only their relative ratios matter.

```
gs = gridspec.GridSpec(2, 2,
                        width_ratios=[1, 2],
                        height_ratios=[4, 1]
                        )

ax1 = plt.subplot(gs[0])
ax2 = plt.subplot(gs[1])
```

```
ax3 = plt.subplot(gs[2])
ax4 = plt.subplot(gs[3])
```

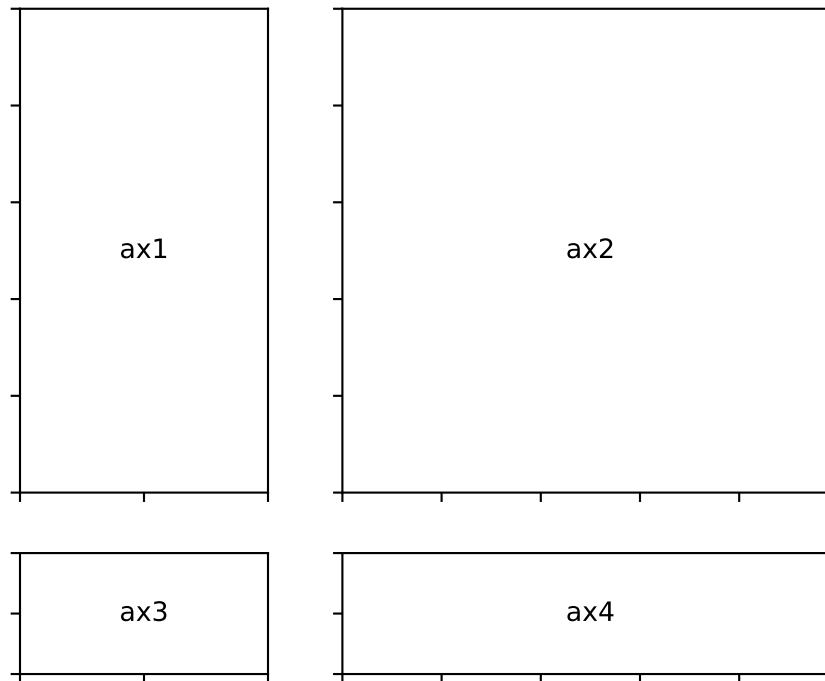

3.1.4 Tight Layout guide

tight_layout automatically adjusts subplot params so that the subplot(s) fits in to the figure area. This is an experimental feature and may not work for some cases. It only checks the extents of ticklabels, axis labels, and titles.

Simple Example

In matplotlib, the location of axes (including subplots) are specified in normalized figure coordinates. It can happen that your axis labels or titles (or sometimes even ticklabels) go outside the figure area, and are thus clipped.

```
plt.rcParams['savefig.facecolor'] = "#0.8"

def example_plot(ax, fontsize=12):
    ax.plot([1, 2])
    ax.locator_params(nbins=3)
    ax.set_xlabel('x-label', fontsize=fontsize)
    ax.set_ylabel('y-label', fontsize=fontsize)
```

```
ax.set_title('Title', fontsize=fontsize)

plt.close('all')
fig, ax = plt.subplots()
example_plot(ax, fontsize=24)
```

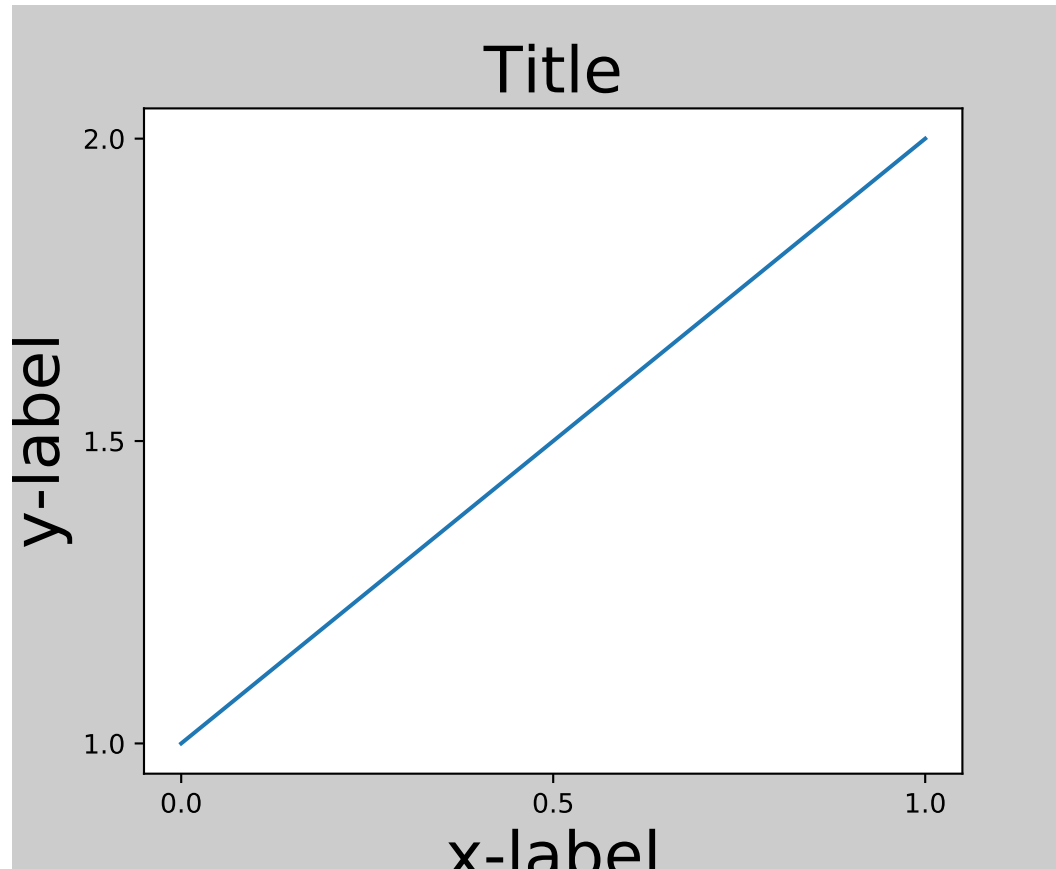

To prevent this, the location of axes needs to be adjusted. For subplots, this can be done by adjusting the subplot params (*Move the edge of an axes to make room for tick labels*). Matplotlib v1.1 introduces a new command `tight_layout()` that does this automatically for you.

```
plt.tight_layout()
```

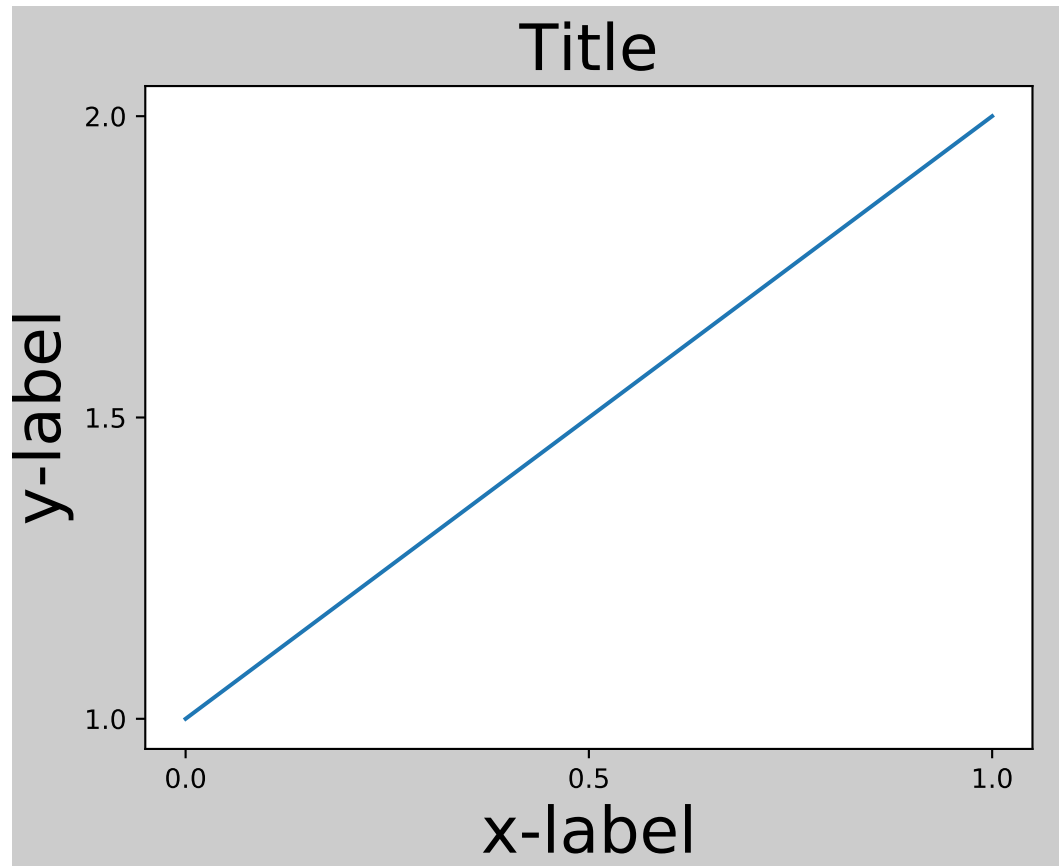

When you have multiple subplots, often you see labels of different axes overlapping each other.

```
plt.close('all')
fig, ((ax1, ax2), (ax3, ax4)) = plt.subplots(nrows=2, ncols=2)
example_plot(ax1)
example_plot(ax2)
example_plot(ax3)
example_plot(ax4)
```

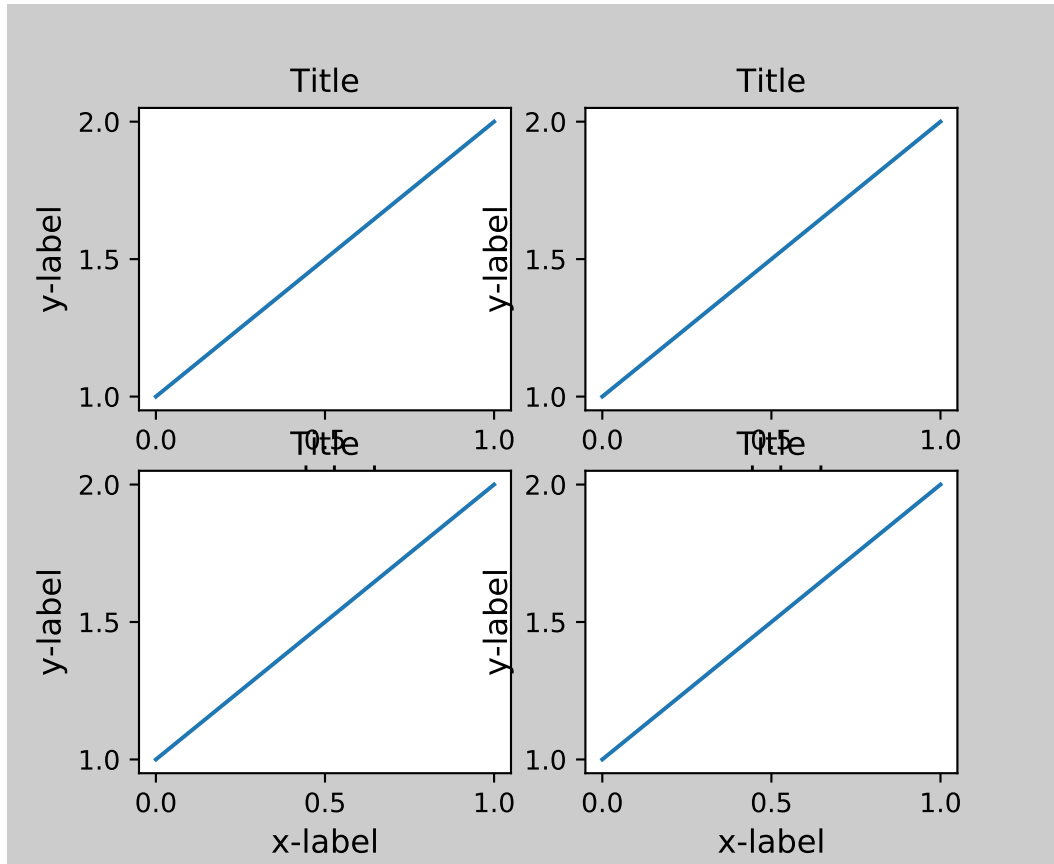
`tight_layout()` will also adjust spacing between subplots to minimize the overlaps.

```
plt.tight_layout()
```

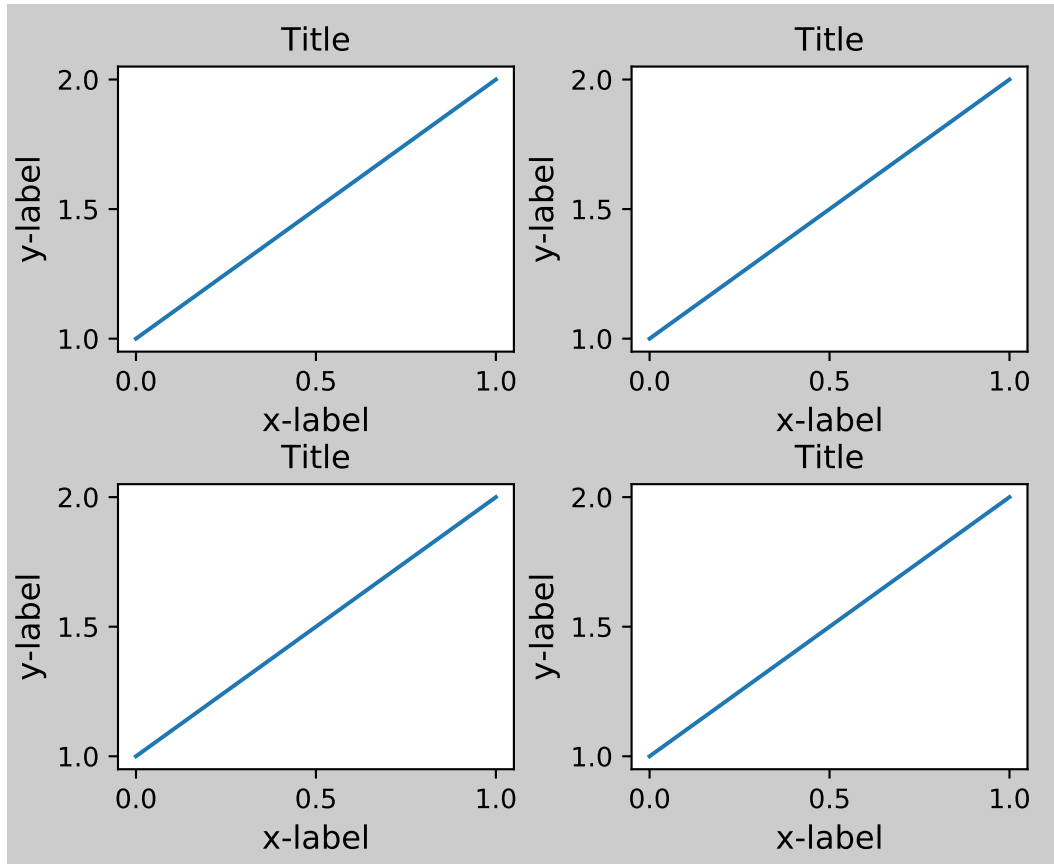

`tight_layout()` can take keyword arguments of `pad`, `w_pad` and `h_pad`. These control the extra padding around the figure border and between subplots. The pads are specified in fraction of fontsize.

```
plt.tight_layout(pad=0.4, w_pad=0.5, h_pad=1.0)
```

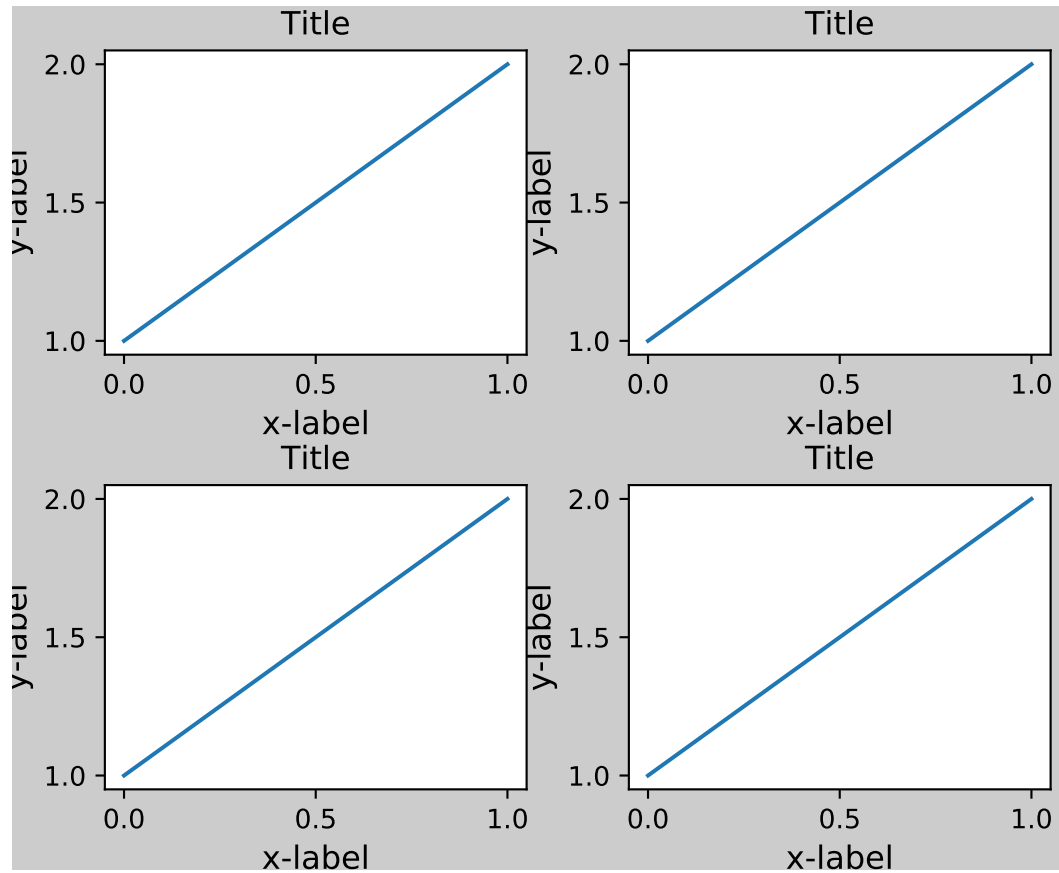

`tight_layout()` will work even if the sizes of subplots are different as far as their grid specification is compatible. In the example below, `ax1` and `ax2` are subplots of a 2x2 grid, while `ax3` is of a 1x2 grid.

```
plt.close('all')
fig = plt.figure()

ax1 = plt.subplot(221)
ax2 = plt.subplot(223)
ax3 = plt.subplot(122)

example_plot(ax1)
example_plot(ax2)
example_plot(ax3)

plt.tight_layout()
```

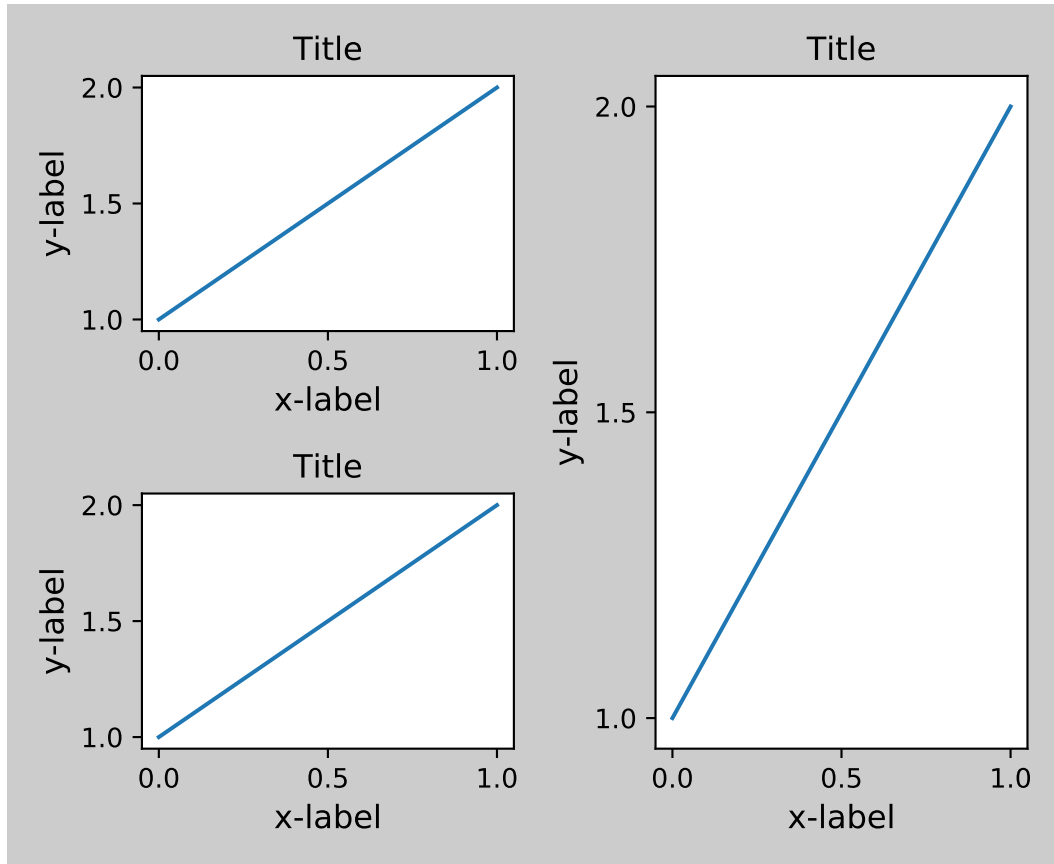

It works with subplots created with `subplot2grid()`. In general, subplots created from the gridspec (*Customizing Location of Subplot Using GridSpec*) will work.

```
plt.close('all')
fig = plt.figure()

ax1 = plt.subplot2grid((3, 3), (0, 0))
ax2 = plt.subplot2grid((3, 3), (0, 1), colspan=2)
ax3 = plt.subplot2grid((3, 3), (1, 0), colspan=2, rowspan=2)
ax4 = plt.subplot2grid((3, 3), (1, 2), rowspan=2)

example_plot(ax1)
example_plot(ax2)
example_plot(ax3)
example_plot(ax4)

plt.tight_layout()
```

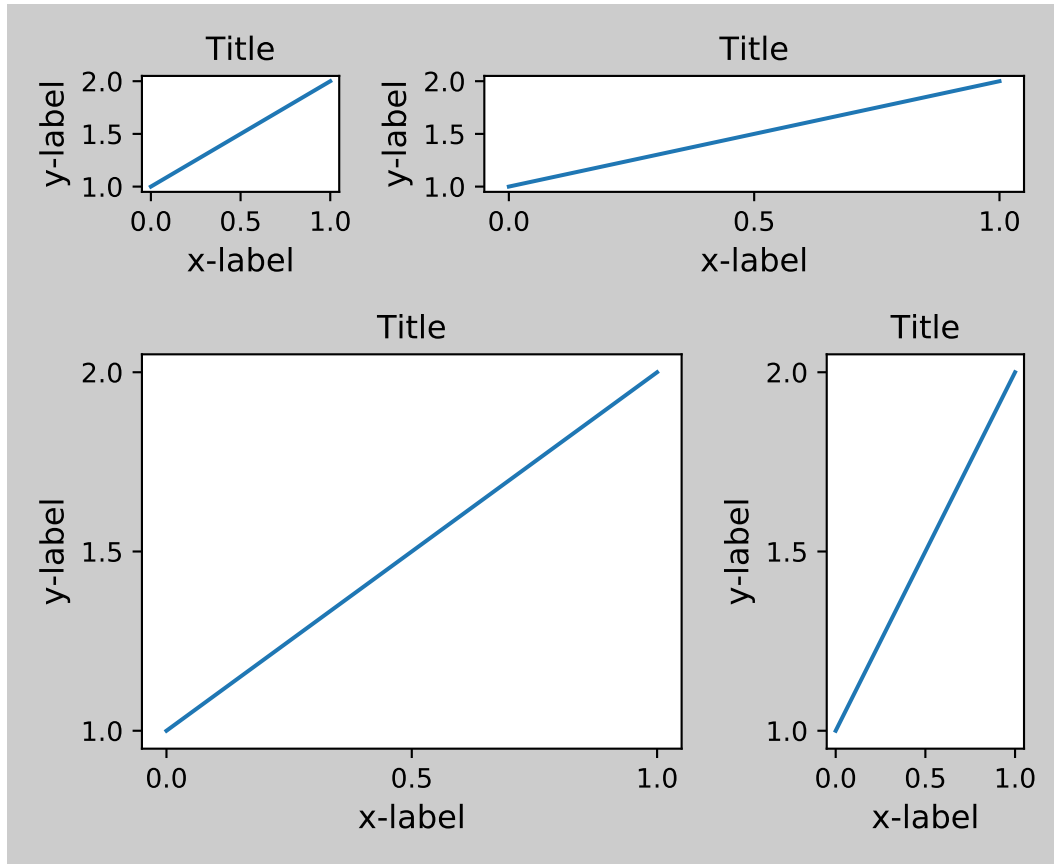

Although not thoroughly tested, it seems to work for subplots with `aspect != "auto"` (e.g., axes with images).

```
arr = np.arange(100).reshape((10, 10))

plt.close('all')
fig = plt.figure(figsize=(5,4))

ax = plt.subplot(111)
im = ax.imshow(arr, interpolation="none")

plt.tight_layout()
```

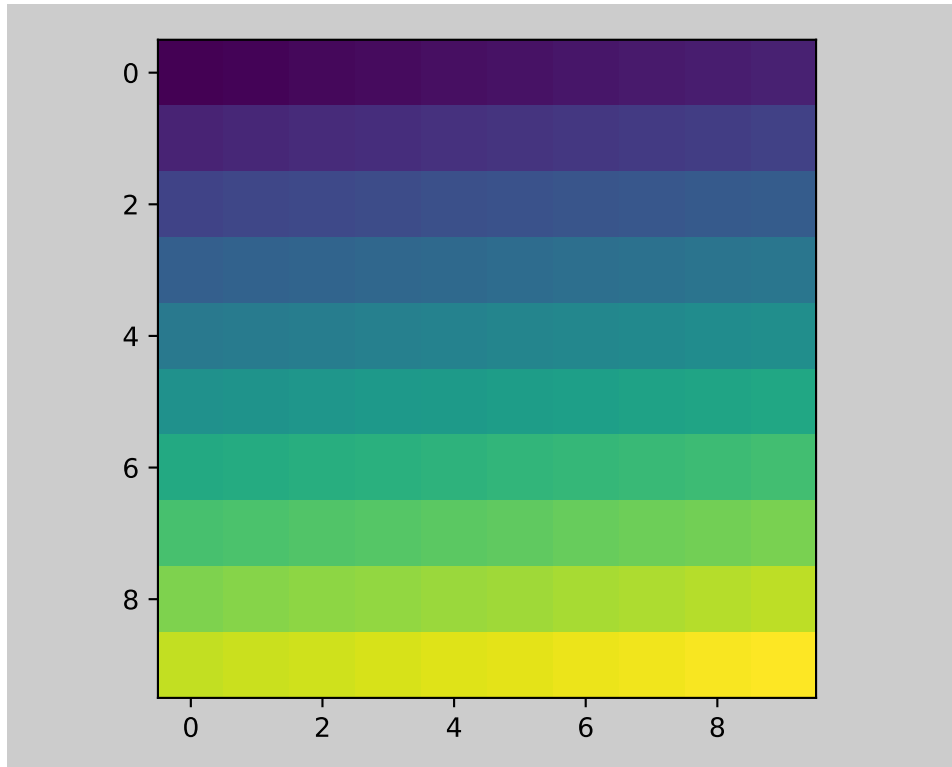

Caveats

- `tight_layout()` only considers ticklabels, axis labels, and titles. Thus, other artists may be clipped and also may overlap.
- It assumes that the extra space needed for ticklabels, axis labels, and titles is independent of original location of axes. This is often true, but there are rare cases where it is not.
- `pad=0` clips some of the texts by a few pixels. This may be a bug or a limitation of the current algorithm and it is not clear why it happens. Meanwhile, use of `pad` at least larger than 0.3 is recommended.

Use with GridSpec

GridSpec has its own `tight_layout()` method (the pyplot api `tight_layout()` also works).

```
plt.close('all')
fig = plt.figure()

import matplotlib.gridspec as gridspec

gs1 = gridspec.GridSpec(2, 1)
ax1 = fig.add_subplot(gs1[0])
ax2 = fig.add_subplot(gs1[1])
```

```
example_plot(ax1)
example_plot(ax2)

gs1.tight_layout(fig)
```

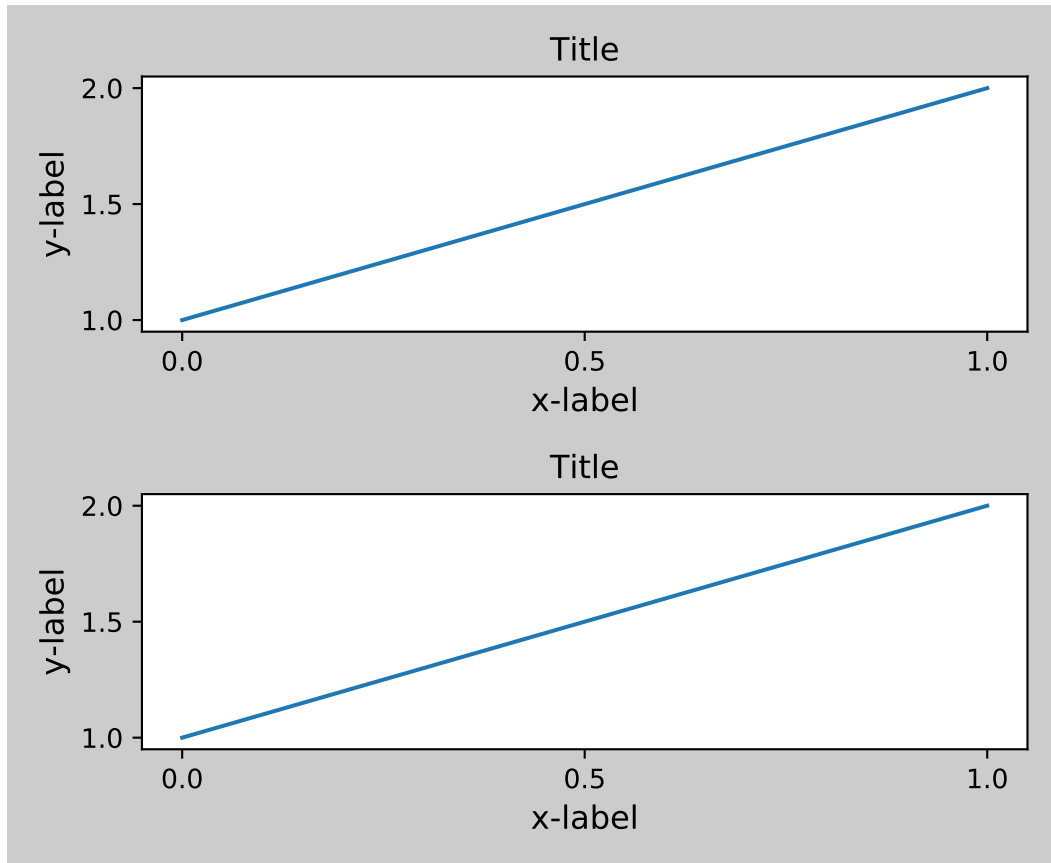

You may provide an optional *rect* parameter, which specifies the bounding box that the subplots will be fit inside. The coordinates must be in normalized figure coordinates and the default is (0, 0, 1, 1).

```
gs1.tight_layout(fig, rect=[0, 0, 0.5, 1])
```

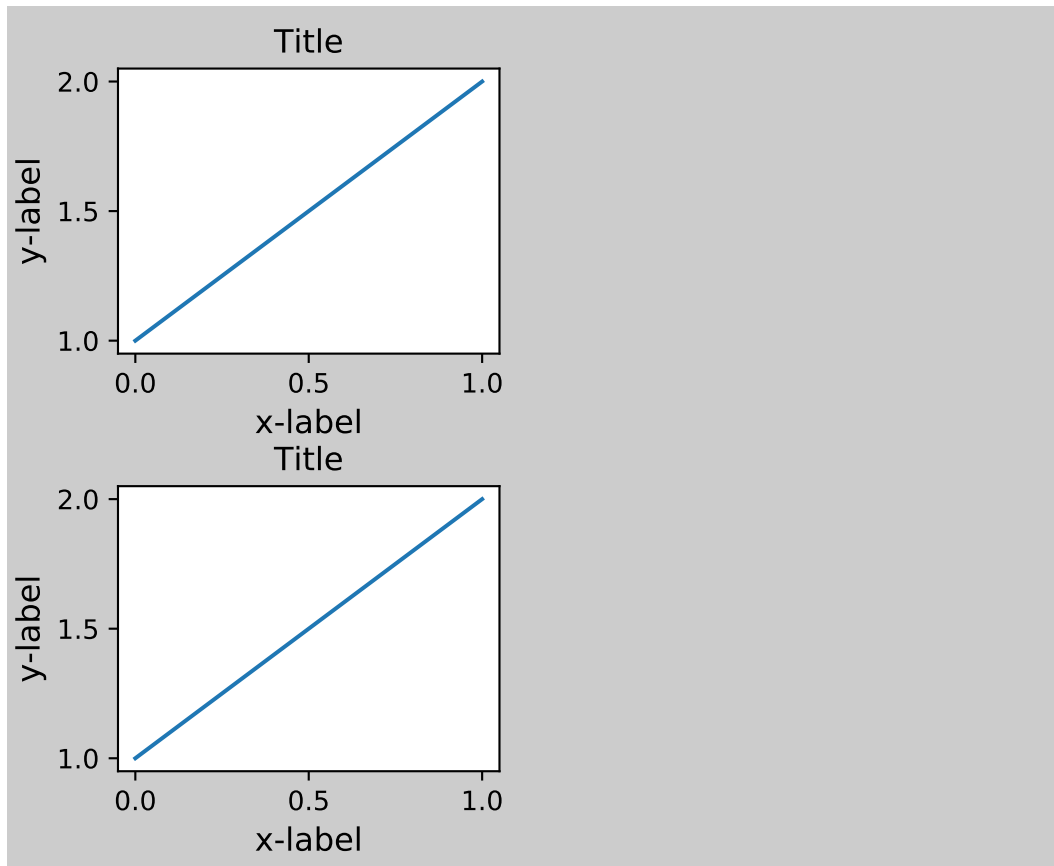

For example, this can be used for a figure with multiple gridspecs.

```
gs2 = gridspec.GridSpec(3, 1)

for ss in gs2:
    ax = fig.add_subplot(ss)
    example_plot(ax)
    ax.set_title("")
    ax.set_xlabel("")

ax.set_xlabel("x-label", fontsize=12)

gs2.tight_layout(fig, rect=[0.5, 0, 1, 1], h_pad=0.5)
```

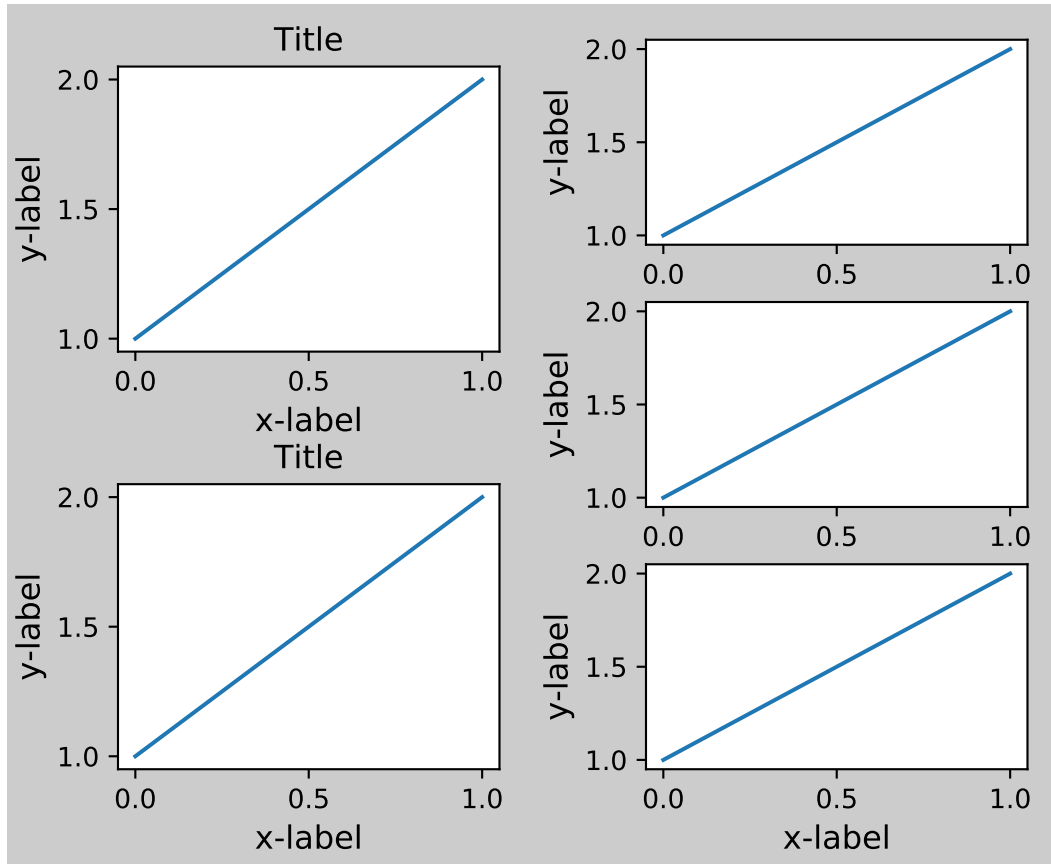
We may try to match the top and bottom of two grids

```
top = min(gs1.top, gs2.top)
bottom = max(gs1.bottom, gs2.bottom)

gs1.update(top=top, bottom=bottom)
gs2.update(top=top, bottom=bottom)
```

While this should be mostly good enough, adjusting top and bottom may require adjustment of hspace also. To update hspace & vspace, we call `tight_layout()` again with updated rect argument. Note that the rect argument specifies the area including the ticklabels, etc. Thus, we will increase the bottom (which is 0 for the normal case) by the difference between the `bottom` from above and the bottom of each gridspec. Same thing for the top.

```
top = min(gs1.top, gs2.top)
bottom = max(gs1.bottom, gs2.bottom)

gs1.tight_layout(fig, rect=[None, 0 + (bottom-gs1.bottom),
                           0.5, 1 - (gs1.top-top)])
gs2.tight_layout(fig, rect=[0.5, 0 + (bottom-gs2.bottom),
                           None, 1 - (gs2.top-top)],
                 h_pad=0.5)
```

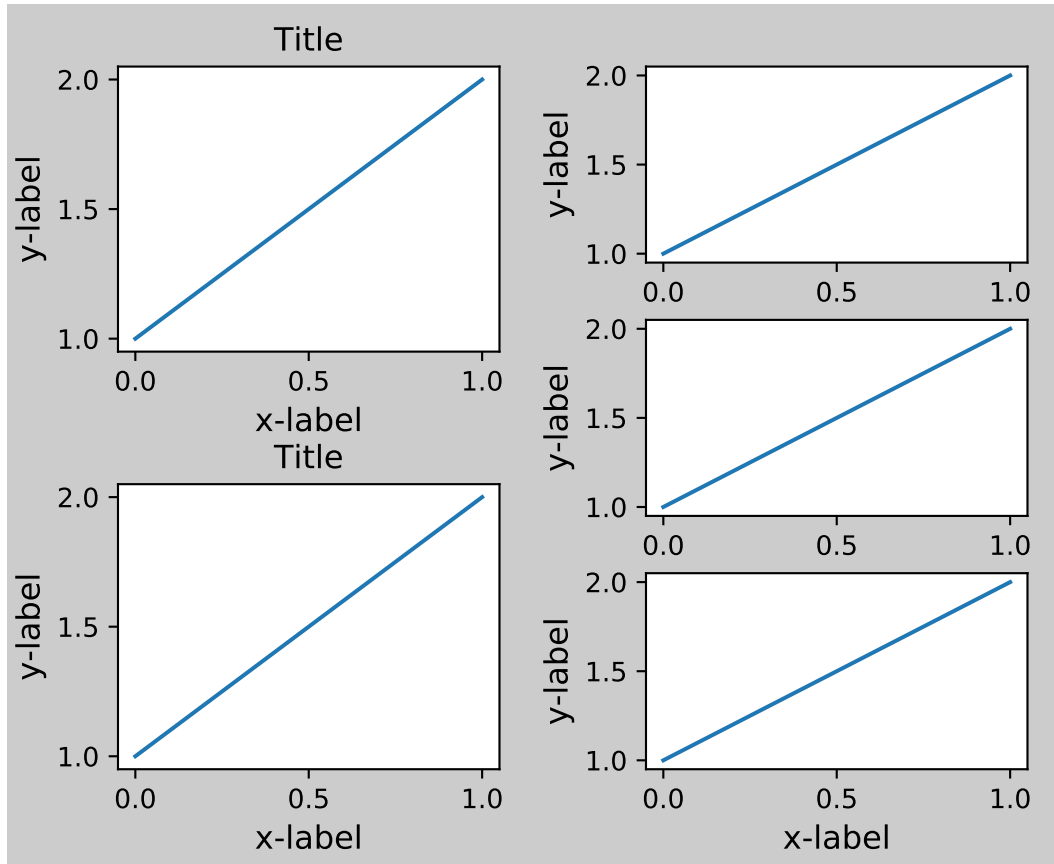

Use with AxesGrid1

While limited, the `axes_grid1` toolkit is also supported.

```
plt.close('all')
fig = plt.figure()

from mpl_toolkits.axes_grid1 import Grid
grid = Grid(fig, rect=111, nrows_ncols=(2,2),
            axes_pad=0.25, label_mode='L',
            )

for ax in grid:
    example_plot(ax)
    ax.title.set_visible(False)

plt.tight_layout()
```

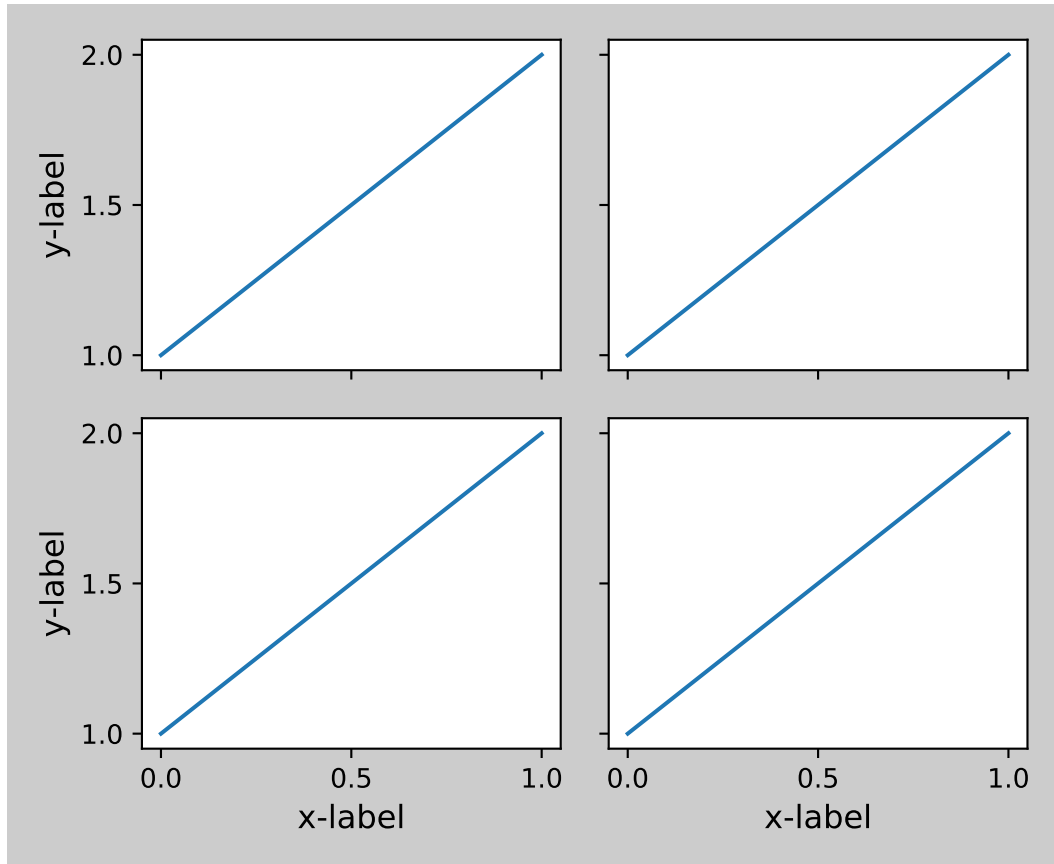

Colorbar

If you create a colorbar with the `colorbar()` command, the created colorbar is an instance of `Axes`, *not* `Subplot`, so `tight_layout` does not work. With Matplotlib v1.1, you may create a colorbar as a subplot using the `gridspec`.

```
plt.close('all')
arr = np.arange(100).reshape((10, 10))
fig = plt.figure(figsize=(4, 4))
im = plt.imshow(arr, interpolation="none")

plt.colorbar(im, use_gridspec=True)

plt.tight_layout()
```

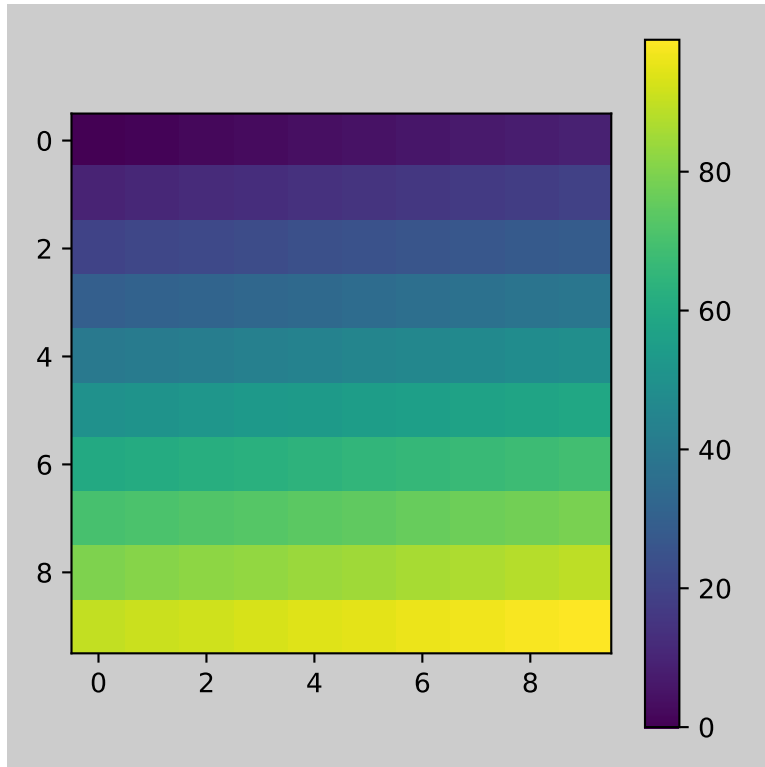

Another option is to use AxesGrid1 toolkit to explicitly create an axes for colorbar.

```
plt.close('all')
arr = np.arange(100).reshape((10,10))
fig = plt.figure(figsize=(4, 4))
im = plt.imshow(arr, interpolation="none")

from mpl_toolkits.axes_grid1 import make_axes_locatable
divider = make_axes_locatable(plt.gca())
cax = divider.append_axes("right", "5%", pad="3%")
plt.colorbar(im, cax=cax)

plt.tight_layout()
```

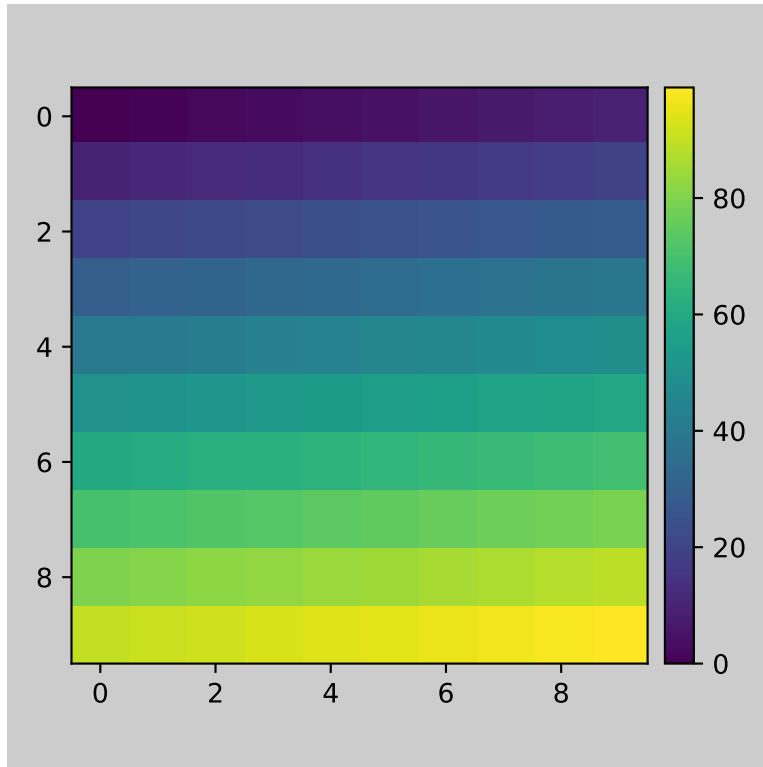

3.2 Intermediate

3.2.1 Artist tutorial

There are three layers to the matplotlib API. The `matplotlib.backend_bases.FigureCanvas` is the area onto which the figure is drawn, the `matplotlib.backend_bases.Renderer` is the object which knows how to draw on the `FigureCanvas`, and the `matplotlib.artist.Artist` is the object that knows how to use a renderer to paint onto the canvas. The `FigureCanvas` and `Renderer` handle all the details of talking to user interface toolkits like `wxPython` or drawing languages like PostScript®, and the `Artist` handles all the high level constructs like representing and laying out the figure, text, and lines. The typical user will spend 95% of their time working with the `Artists`.

There are two types of `Artists`: primitives and containers. The primitives represent the standard graphical objects we want to paint onto our canvas: `Line2D`, `Rectangle`, `Text`, `AxesImage`, etc., and the containers are places to put them (`Axis`, `Axes` and `Figure`). The standard use is to create a `Figure` instance, use the `Figure` to create one or more `Axis` or `Subplot` instances, and use the `Axis` instance helper methods to create the primitives. In the example below, we create a `Figure` instance using `matplotlib.pyplot.figure()`, which is a convenience method for instantiating `Figure` instances and connecting them with your user interface or drawing toolkit `FigureCanvas`. As we will discuss below, this is not necessary – you can work directly with PostScript, PDF Gtk+, or `wxPython` `FigureCanvas` instances, instantiate your `Figures` directly and connect them yourselves – but since we are focusing here on the `Artist` API we'll let `pyplot` handle some of those details for us:

```
import matplotlib.pyplot as plt
fig = plt.figure()
ax = fig.add_subplot(2,1,1) # two rows, one column, first plot
```

The `Axes` is probably the most important class in the matplotlib API, and the one you will be working with most of the time. This is because the `Axes` is the plotting area into which most of the objects go, and the `Axes` has many special helper methods (`plot()`, `text()`, `hist()`, `imshow()`) to create the most common graphics primitives (`Line2D`, `Text`, `Rectangle`, `Image`, respectively). These helper methods will take your data (e.g., numpy arrays and strings) and create primitive `Artist` instances as needed (e.g., `Line2D`), add them to the relevant containers, and draw them when requested. Most of you are probably familiar with the `Subplot`, which is just a special case of an `Axes` that lives on a regular rows by columns grid of `Subplot` instances. If you want to create an `Axes` at an arbitrary location, simply use the `add_axes()` method which takes a list of [`left`, `bottom`, `width`, `height`] values in 0-1 relative figure coordinates:

```
fig2 = plt.figure()
ax2 = fig2.add_axes([0.15, 0.1, 0.7, 0.3])
```

Continuing with our example:

```
import numpy as np
t = np.arange(0.0, 1.0, 0.01)
s = np.sin(2*np.pi*t)
line, = ax.plot(t, s, color='blue', lw=2)
```

In this example, `ax` is the `Axes` instance created by the `fig.add_subplot` call above (remember `Subplot` is just a subclass of `Axes`) and when you call `ax.plot`, it creates a `Line2D` instance and adds it to the `Axes.lines` list. In the interactive `ipython` session below, you can see that the `Axes.lines` list is length one and contains the same line that was returned by the `line, = ax.plot...` call:

```
In [101]: ax.lines[0]
Out[101]: <matplotlib.lines.Line2D instance at 0x19a95710>

In [102]: line
Out[102]: <matplotlib.lines.Line2D instance at 0x19a95710>
```

If you make subsequent calls to `ax.plot` (and the hold state is “on” which is the default) then additional lines will be added to the list. You can remove lines later simply by calling the list methods; either of these will work:

```
del ax.lines[0]
ax.lines.remove(line) # one or the other, not both!
```

The `Axes` also has helper methods to configure and decorate the x-axis and y-axis tick, tick labels and axis labels:

```
xtext = ax.set_xlabel('my xdata') # returns a Text instance
ytext = ax.set_ylabel('my ydata')
```

When you call `ax.set_xlabel`, it passes the information on the `Text` instance of the `XAxis`. Each `Axes` instance contains an `XAxis` and a `YAxis` instance, which handle the layout and drawing of the ticks, tick labels and axis labels.

Try creating the figure below.

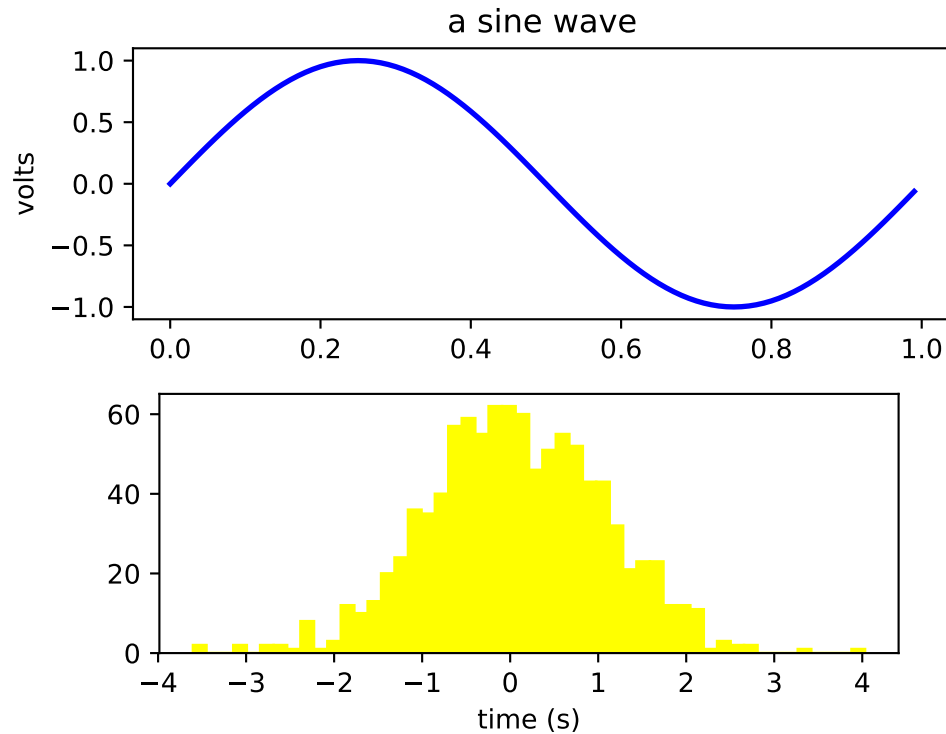

Customizing your objects

Every element in the figure is represented by a matplotlib *Artist*, and each has an extensive list of properties to configure its appearance. The figure itself contains a *Rectangle* exactly the size of the figure, which you can use to set the background color and transparency of the figures. Likewise, each *Axis* bounding box (the standard white box with black edges in the typical matplotlib plot, has a *Rectangle* instance that determines the color, transparency, and other properties of the Axes. These instances are stored as member variables `Figure.patch` and `Axes.patch` (“Patch” is a name inherited from MATLAB, and is a 2D “patch” of color on the figure, e.g., rectangles, circles and polygons). Every matplotlib *Artist* has the following properties

Property	Description
alpha	The transparency - a scalar from 0-1
animated	A boolean that is used to facilitate animated drawing
axes	The axes that the Artist lives in, possibly None
clip_box	The bounding box that clips the Artist
clip_on	Whether clipping is enabled
clip_path	The path the artist is clipped to
contains	A picking function to test whether the artist contains the pick point
figure	The figure instance the artist lives in, possibly None
label	A text label (e.g., for auto-labeling)
picker	A python object that controls object picking
transform	The transformation
visible	A boolean whether the artist should be drawn
zorder	A number which determines the drawing order
rasterized	Boolean; Turns vectors into rastergraphics: (for compression & eps transparency)

Each of the properties is accessed with an old-fashioned setter or getter (yes we know this irritates Pythonistas and we plan to support direct access via properties or traits but it hasn't been done yet). For example, to multiply the current alpha by a half:

```
a = o.get_alpha()
o.set_alpha(0.5*a)
```

If you want to set a number of properties at once, you can also use the `set` method with keyword arguments. For example:

```
o.set(alpha=0.5, zorder=2)
```

If you are working interactively at the python shell, a handy way to inspect the `Artist` properties is to use the `matplotlib.artist.getp()` function (simply `getp()` in pylab), which lists the properties and their values. This works for classes derived from `Artist` as well, e.g., `Figure` and `Rectangle`. Here are the `Figure` rectangle properties mentioned above:

```
In [149]: matplotlib.artist.getp(fig.patch)
alpha = 1.0
animated = False
antialiased or aa = True
axes = None
clip_box = None
clip_on = False
clip_path = None
contains = None
edgecolor or ec = w
facecolor or fc = 0.75
figure = Figure(8.125x6.125)
fill = 1
hatch = None
height = 1
label =
linewidth or lw = 1.0
picker = None
```



```

transform = <Affine object at 0x134cca84>
verts = ((0, 0), (0, 1), (1, 1), (1, 0))
visible = True
width = 1
window_extent = <Bbox object at 0x134acb2c>
x = 0
y = 0
zorder = 1

```

The docstrings for all of the classes also contain the `Artist` properties, so you can consult the interactive “help” or the *artist Module* for a listing of properties for a given object.

Object containers

Now that we know how to inspect and set the properties of a given object we want to configure, we need to know how to get at that object. As mentioned in the introduction, there are two kinds of objects: primitives and containers. The primitives are usually the things you want to configure (the font of a *Text* instance, the width of a *Line2D*) although the containers also have some properties as well – for example the *Axes Artist* is a container that contains many of the primitives in your plot, but it also has properties like the `xscale` to control whether the xaxis is ‘linear’ or ‘log’. In this section we’ll review where the various container objects store the `Artists` that you want to get at.

Figure container

The top level container `Artist` is the *matplotlib.figure.Figure*, and it contains everything in the figure. The background of the figure is a *Rectangle* which is stored in `Figure.patch`. As you add subplots (`add_subplot()`) and axes (`add_axes()`) to the figure these will be appended to the *Figure.axes*. These are also returned by the methods that create them:

```

In [156]: fig = plt.figure()

In [157]: ax1 = fig.add_subplot(211)

In [158]: ax2 = fig.add_axes([0.1, 0.1, 0.7, 0.3])

In [159]: ax1
Out[159]: <matplotlib.axes.Subplot instance at 0xd54b26c>

In [160]: print fig.axes
[<matplotlib.axes.Subplot instance at 0xd54b26c>, <matplotlib.axes.Axes instance at 0xd3f0b2c>]

```

Because the figure maintains the concept of the “current axes” (see *Figure.gca* and *Figure.sca*) to support the pylab/pyplot state machine, you should not insert or remove axes directly from the axes list, but rather use the `add_subplot()` and `add_axes()` methods to insert, and the `delaxes()` method to delete. You are free however, to iterate over the list of axes or index into it to get access to `Axes` instances you want to customize. Here is an example which turns all the axes grids on:

```
for ax in fig.axes:  
    ax.grid(True)
```

The figure also has its own text, lines, patches and images, which you can use to add primitives directly. The default coordinate system for the Figure will simply be in pixels (which is not usually what you want) but you can control this by setting the transform property of the Artist you are adding to the figure.

More useful is “figure coordinates” where (0, 0) is the bottom-left of the figure and (1, 1) is the top-right of the figure which you can obtain by setting the Artist transform to `fig.transFigure`:

```
In [191]: fig = plt.figure()  
  
In [192]: l1 = matplotlib.lines.Line2D([0, 1], [0, 1],  
    transform=fig.transFigure, figure=fig)  
  
In [193]: l2 = matplotlib.lines.Line2D([0, 1], [1, 0],  
    transform=fig.transFigure, figure=fig)  
  
In [194]: fig.lines.extend([l1, l2])  
  
In [195]: fig.canvas.draw()
```

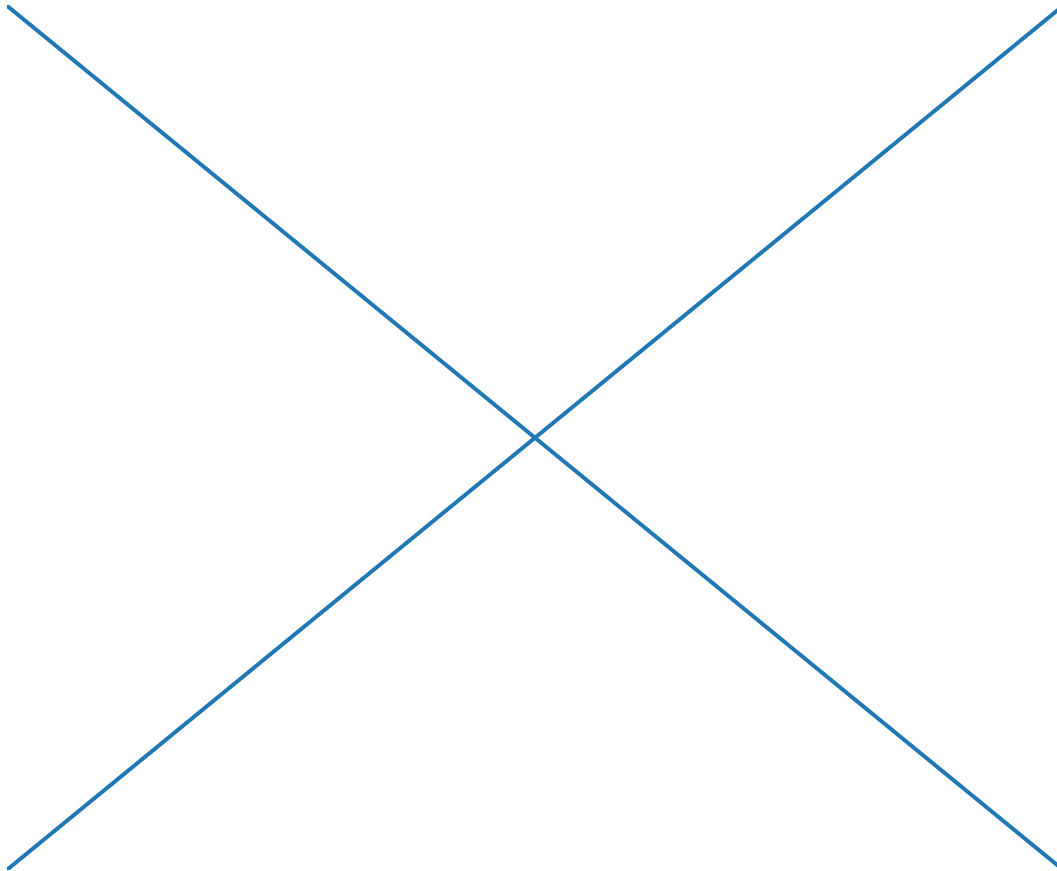

Here is a summary of the Artists the figure contains

Figure attribute	Description
axes	A list of Axes instances (includes Subplot)
patch	The Rectangle background
images	A list of FigureImage patches - useful for raw pixel display
legends	A list of Figure Legend instances (different from Axes.legends)
lines	A list of Figure Line2D instances (rarely used, see Axes.lines)
patches	A list of Figure patches (rarely used, see Axes.patches)
texts	A list Figure Text instances

Axes container

The `matplotlib.axes.Axes` is the center of the matplotlib universe – it contains the vast majority of all the `Artists` used in a figure with many helper methods to create and add these `Artists` to itself, as well as helper methods to access and customize the `Artists` it contains. Like the `Figure`, it contains a `Patch` patch which is a `Rectangle` for Cartesian coordinates and a `Circle` for polar coordinates; this patch determines the shape, background and border of the plotting region:

```
ax = fig.add_subplot(111)
rect = ax.patch # a Rectangle instance
rect.set_facecolor('green')
```

When you call a plotting method, e.g., the canonical `plot()` and pass in arrays or lists of values, the method will create a `matplotlib.lines.Line2D()` instance, update the line with all the `Line2D` properties passed as keyword arguments, add the line to the `Axes.lines` container, and returns it to you:

```
In [213]: x, y = np.random.rand(2, 100)
In [214]: line, = ax.plot(x, y, '-', color='blue', linewidth=2)
```

`plot` returns a list of lines because you can pass in multiple `x, y` pairs to plot, and we are unpacking the first element of the length one list into the line variable. The line has been added to the `Axes.lines` list:

```
In [229]: print ax.lines
[<matplotlib.lines.Line2D instance at 0xd378b0c>]
```

Similarly, methods that create patches, like `bar()` creates a list of rectangles, will add the patches to the `Axes.patches` list:

```
In [233]: n, bins, rectangles = ax.hist(np.random.randn(1000), 50, facecolor='yellow')
In [234]: rectangles
Out[234]: <a list of 50 Patch objects>
In [235]: print len(ax.patches)
```

You should not add objects directly to the `Axes.lines` or `Axes.patches` lists unless you know exactly what you are doing, because the `Axes` needs to do a few things when it creates and adds an object. It sets the figure and axes property of the `Artist`, as well as the default `Axes` transformation (unless a transformation is set). It also inspects the data contained in the `Artist` to update the data structures controlling auto-scaling,

so that the view limits can be adjusted to contain the plotted data. You can, nonetheless, create objects yourself and add them directly to the Axes using helper methods like `add_line()` and `add_patch()`. Here is an annotated interactive session illustrating what is going on:

```
In [261]: fig = plt.figure()

In [262]: ax = fig.add_subplot(111)

# create a rectangle instance
In [263]: rect = matplotlib.patches.Rectangle( (1,1), width=5, height=12)

# by default the axes instance is None
In [264]: print rect.get_axes()
None

# and the transformation instance is set to the "identity transform"
In [265]: print rect.get_transform()
<Affine object at 0x13695544>

# now we add the Rectangle to the Axes
In [266]: ax.add_patch(rect)

# and notice that the ax.add_patch method has set the axes
# instance
In [267]: print rect.get_axes()
Axes(0.125,0.1;0.775x0.8)

# and the transformation has been set too
In [268]: print rect.get_transform()
<Affine object at 0x15009ca4>

# the default axes transformation is ax.transData
In [269]: print ax.transData
<Affine object at 0x15009ca4>

# notice that the xlims of the Axes have not been changed
In [270]: print ax.get_xlim()
(0.0, 1.0)

# but the data limits have been updated to encompass the rectangle
In [271]: print ax.dataLim.bounds
(1.0, 1.0, 5.0, 12.0)

# we can manually invoke the auto-scaling machinery
In [272]: ax.autoscale_view()

# and now the xlim are updated to encompass the rectangle
In [273]: print ax.get_xlim()
(1.0, 6.0)

# we have to manually force a figure draw
In [274]: ax.figure.canvas.draw()
```

There are many, many `Axes` helper methods for creating primitive `Artists` and adding them to their respective containers. The table below summarizes a small sampling of them, the kinds of `Artist` they create, and where they store them

Helper method	Artist	Container
<code>ax.annotate</code> - text annotations	Annotate	<code>ax.texts</code>
<code>ax.bar</code> - bar charts	Rectangle	<code>ax.patches</code>
<code>ax.errorbar</code> - error bar plots	Line2D and Rectangle	<code>ax.lines</code> and <code>ax.patches</code>
<code>ax.fill</code> - shared area	Polygon	<code>ax.patches</code>
<code>ax.hist</code> - histograms	Rectangle	<code>ax.patches</code>
<code>ax.imshow</code> - image data	AxesImage	<code>ax.images</code>
<code>ax.legend</code> - axes legends	Legend	<code>ax.legend</code>
<code>ax.plot</code> - xy plots	Line2D	<code>ax.lines</code>
<code>ax.scatter</code> - scatter charts	PolygonCollection	<code>ax.collections</code>
<code>ax.text</code> - text	Text	<code>ax.texts</code>

In addition to all of these `Artists`, the `Axes` contains two important `Artist` containers: the `XAxis` and `YAxis`, which handle the drawing of the ticks and labels. These are stored as instance variables `xaxis` and `yaxis`. The `XAxis` and `YAxis` containers will be detailed below, but note that the `Axes` contains many helper methods which forward calls on to the `Axis` instances so you often do not need to work with them directly unless you want to. For example, you can set the font color of the `XAxis` ticklabels using the `Axes` helper method:

```
for label in ax.get_xticklabels():
    label.set_color('orange')
```

Below is a summary of the `Artists` that the `Axes` contains

Axes attribute	Description
<code>artists</code>	A list of <code>Artist</code> instances
<code>patch</code>	Rectangle instance for <code>Axes</code> background
<code>collections</code>	A list of <code>Collection</code> instances
<code>images</code>	A list of <code>AxesImage</code>
<code>legends</code>	A list of <code>Legend</code> instances
<code>lines</code>	A list of <code>Line2D</code> instances
<code>patches</code>	A list of <code>Patch</code> instances
<code>texts</code>	A list of <code>Text</code> instances
<code>xaxis</code>	<code>matplotlib.axis.XAxis</code> instance
<code>yaxis</code>	<code>matplotlib.axis.YAxis</code> instance

Axis containers

The `matplotlib.axis.Axis` instances handle the drawing of the tick lines, the grid lines, the tick labels and the axis label. You can configure the left and right ticks separately for the y-axis, and the upper and lower ticks separately for the x-axis. The `Axis` also stores the data and view intervals used in auto-scaling, panning and zooming, as well as the `Locator` and `Formatter` instances which control where the ticks are placed and how they are represented as strings.

Each `Axis` object contains a `label` attribute (this is what `pylab` modifies in calls to `xlabel()` and

ylabel()) as well as a list of major and minor ticks. The ticks are *XTick* and *YTick* instances, which contain the actual line and text primitives that render the ticks and ticklabels. Because the ticks are dynamically created as needed (e.g., when panning and zooming), you should access the lists of major and minor ticks through their accessor methods `get_major_ticks()` and `get_minor_ticks()`. Although the ticks contain all the primitives and will be covered below, *Axis* instances have accessor methods that return the tick lines, tick labels, tick locations etc.:

```
In [285]: axis = ax.xaxis

In [286]: axis.get_ticklocs()
Out[286]: array([ 0.,  1.,  2.,  3.,  4.,  5.,  6.,  7.,  8.,  9.])

In [287]: axis.get_ticklabels()
Out[287]: <a list of 10 Text major ticklabel objects>

# note there are twice as many ticklines as labels because by
# default there are tick lines at the top and bottom but only tick
# labels below the xaxis; this can be customized
In [288]: axis.get_ticklines()
Out[288]: <a list of 20 Line2D ticklines objects>

# by default you get the major ticks back
In [291]: axis.get_ticklines()
Out[291]: <a list of 20 Line2D ticklines objects>

# but you can also ask for the minor ticks
In [292]: axis.get_ticklines(minor=True)
Out[292]: <a list of 0 Line2D ticklines objects>
```

Here is a summary of some of the useful accessor methods of the *Axis* (these have corresponding setters where useful, such as `set_major_formatter`)

Accessor method	Description
<code>get_scale</code>	The scale of the axis, e.g., 'log' or 'linear'
<code>get_view_interval</code>	The interval instance of the axis view limits
<code>get_data_interval</code>	The interval instance of the axis data limits
<code>get_gridlines</code>	A list of grid lines for the Axis
<code>get_label</code>	The axis label - a Text instance
<code>get_ticklabels</code>	A list of Text instances - keyword <code>minor=True False</code>
<code>get_ticklines</code>	A list of Line2D instances - keyword <code>minor=True False</code>
<code>get_ticklocs</code>	A list of Tick locations - keyword <code>minor=True False</code>
<code>get_major_locator</code>	The <code>matplotlib.ticker.Locator</code> instance for major ticks
<code>get_major_formatter</code>	The <code>matplotlib.ticker.Formatter</code> instance for major ticks
<code>get_minor_locator</code>	The <code>matplotlib.ticker.Locator</code> instance for minor ticks
<code>get_minor_formatter</code>	The <code>matplotlib.ticker.Formatter</code> instance for minor ticks
<code>get_major_ticks</code>	A list of Tick instances for major ticks
<code>get_minor_ticks</code>	A list of Tick instances for minor ticks
<code>grid</code>	Turn the grid on or off for the major or minor ticks

Here is an example, not recommended for its beauty, which customizes the axes and tick properties

```
import numpy as np
import matplotlib.pyplot as plt

# plt.figure creates a matplotlib.figure.Figure instance
fig = plt.figure()
rect = fig.patch # a rectangle instance
rect.set_facecolor('lightgoldenrodyellow')

ax1 = fig.add_axes([0.1, 0.3, 0.4, 0.4])
rect = ax1.patch
rect.set_facecolor('lightslategray')

for label in ax1.xaxis.get_ticklabels():
    # label is a Text instance
    label.set_color('red')
    label.set_rotation(45)
    label.set_fontsize(16)

for line in ax1.yaxis.get_ticklines():
    # line is a Line2D instance
    line.set_color('green')
    line.set_markersize(25)
    line.set_markeredgewidth(3)

plt.show()
```

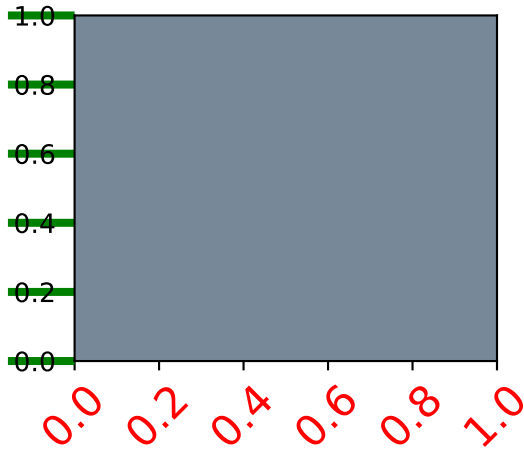

Tick containers

The `matplotlib.axis.Tick` is the final container object in our descent from the *Figure* to the *Axes* to the *Axis* to the *Tick*. The *Tick* contains the tick and grid line instances, as well as the label instances for the upper and lower ticks. Each of these is accessible directly as an attribute of the *Tick*. In addition, there are boolean variables that determine whether the upper labels and ticks are on for the x-axis and whether the right labels and ticks are on for the y-axis.

Tick attribute	Description
tick1line	Line2D instance
tick2line	Line2D instance
gridline	Line2D instance
label1	Text instance
label2	Text instance
gridOn	boolean which determines whether to draw the gridline
tick1On	boolean which determines whether to draw the 1st tickline
tick2On	boolean which determines whether to draw the 2nd tickline
label1On	boolean which determines whether to draw the 1st tick label
label2On	boolean which determines whether to draw the 2nd tick label

Here is an example which sets the formatter for the right side ticks with dollar signs and colors them green on the right side of the yaxis

```
import numpy as np
import matplotlib.pyplot as plt
import matplotlib.ticker as ticker

# Fixing random state for reproducibility
np.random.seed(19680801)

fig = plt.figure()
ax = fig.add_subplot(111)
ax.plot(100*np.random.rand(20))

formatter = ticker.FormatStrFormatter('%.1.2f')
ax.yaxis.set_major_formatter(formatter)

for tick in ax.yaxis.get_major_ticks():
    tick.label10n = False
    tick.label20n = True
    tick.label2.set_color('green')

plt.show()
```

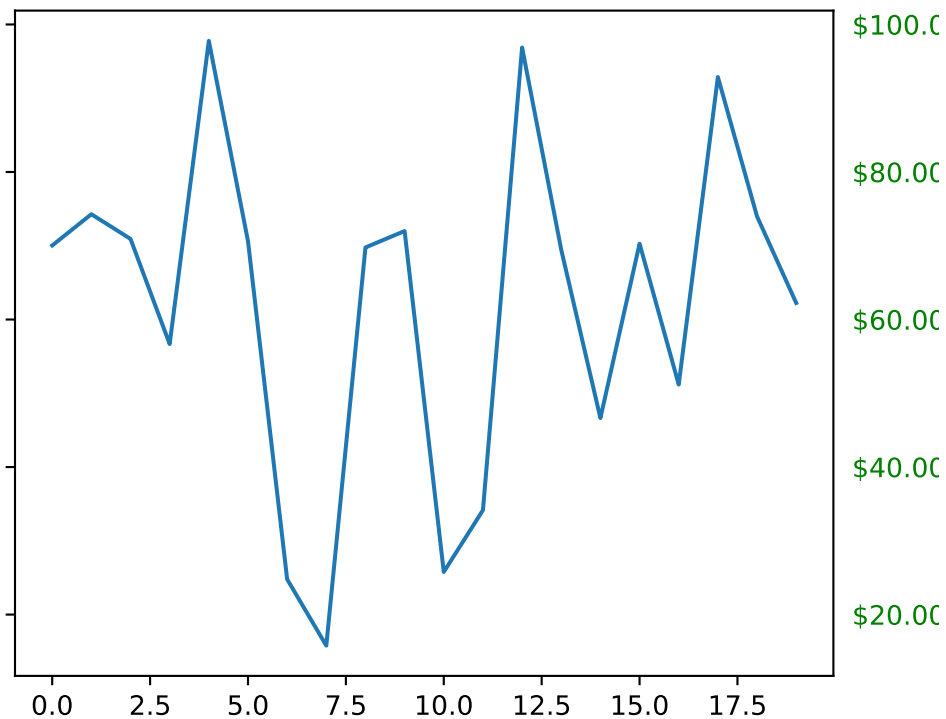

3.2.2 Legend guide

This legend guide is an extension of the documentation available at [legend\(\)](#) - please ensure you are familiar with contents of that documentation before proceeding with this guide.

This guide makes use of some common terms, which are documented here for clarity:

legend entry A legend is made up of one or more legend entries. An entry is made up of exactly one key and one label.

legend key The colored/patterned marker to the left of each legend label.

legend label The text which describes the handle represented by the key.

legend handle The original object which is used to generate an appropriate entry in the legend.

Controlling the legend entries

Calling [legend\(\)](#) with no arguments automatically fetches the legend handles and their associated labels. This functionality is equivalent to:

```
handles, labels = ax.get_legend_handles_labels()
ax.legend(handles, labels)
```

The [get_legend_handles_labels\(\)](#) function returns a list of handles/artists which exist on the Axes which can be used to generate entries for the resulting legend - it is worth noting however that not all artists can be added to a legend, at which point a “proxy” will have to be created (see [Creating artists specifically for adding to the legend \(aka. Proxy artists\)](#) for further details).

For full control of what is being added to the legend, it is common to pass the appropriate handles directly to [legend\(\)](#):

```
line_up, = plt.plot([1,2,3], label='Line 2')
line_down, = plt.plot([3,2,1], label='Line 1')
plt.legend(handles=[line_up, line_down])
```

In some cases, it is not possible to set the label of the handle, so it is possible to pass through the list of labels to [legend\(\)](#):

```
line_up, = plt.plot([1,2,3], label='Line 2')
line_down, = plt.plot([3,2,1], label='Line 1')
plt.legend([line_up, line_down], ['Line Up', 'Line Down'])
```

Creating artists specifically for adding to the legend (aka. Proxy artists)

Not all handles can be turned into legend entries automatically, so it is often necessary to create an artist which *can*. Legend handles don't have to exist on the Figure or Axes in order to be used.

Suppose we wanted to create a legend which has an entry for some data which is represented by a red color:

```
import matplotlib.patches as mpatches
import matplotlib.pyplot as plt

red_patch = mpatches.Patch(color='red', label='The red data')
plt.legend(handles=[red_patch])

plt.show()
```

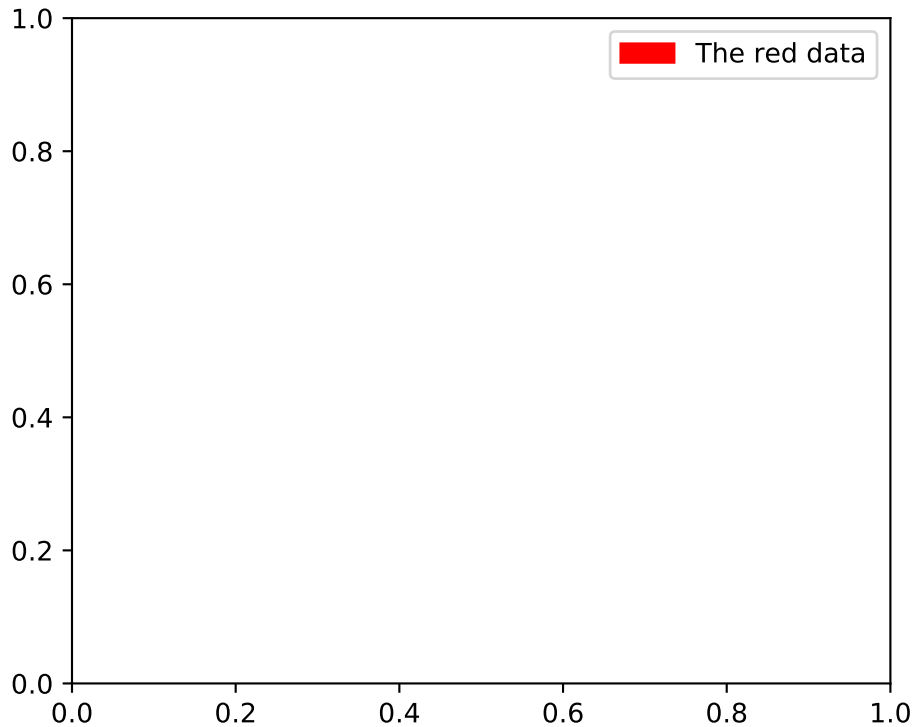

There are many supported legend handles, instead of creating a patch of color we could have created a line with a marker:

```
import matplotlib.lines as mlines
import matplotlib.pyplot as plt

blue_line = mlines.Line2D([], [], color='blue', marker='*',
                           markersize=15, label='Blue stars')
plt.legend(handles=[blue_line])

plt.show()
```

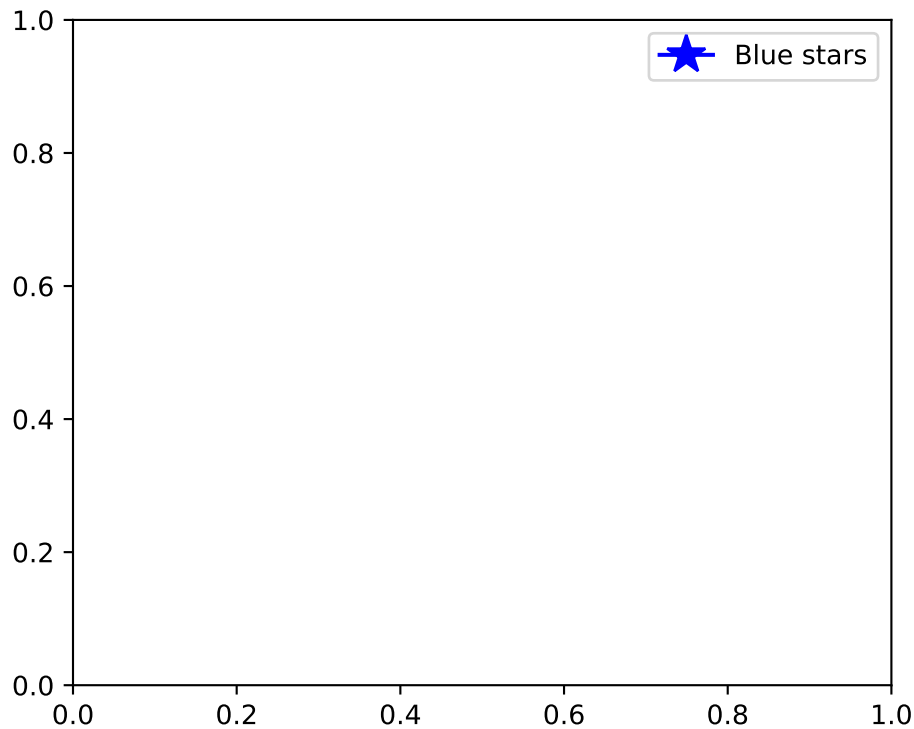

Legend location

The location of the legend can be specified by the keyword argument *loc*. Please see the documentation at [legend\(\)](#) for more details.

The `bbox_to_anchor` keyword gives a great degree of control for manual legend placement. For example, if you want your axes legend located at the figure's top right-hand corner instead of the axes' corner, simply specify the corner's location, and the coordinate system of that location:

```
plt.legend(bbox_to_anchor=(1, 1),
           bbox_transform=plt.gcf().transFigure)
```

More examples of custom legend placement:

```
import matplotlib.pyplot as plt

plt.subplot(211)
plt.plot([1,2,3], label="test1")
plt.plot([3,2,1], label="test2")
# Place a legend above this subplot, expanding itself to
# fully use the given bounding box.
plt.legend(bbox_to_anchor=(0., 1.02, 1., .102), loc=3,
           ncol=2, mode="expand", borderaxespad=0.)
```

```
plt.subplot(223)
plt.plot([1,2,3], label="test1")
plt.plot([3,2,1], label="test2")
# Place a legend to the right of this smaller subplot.
plt.legend(bbox_to_anchor=(1.05, 1), loc=2, borderaxespad=0.)

plt.show()
```

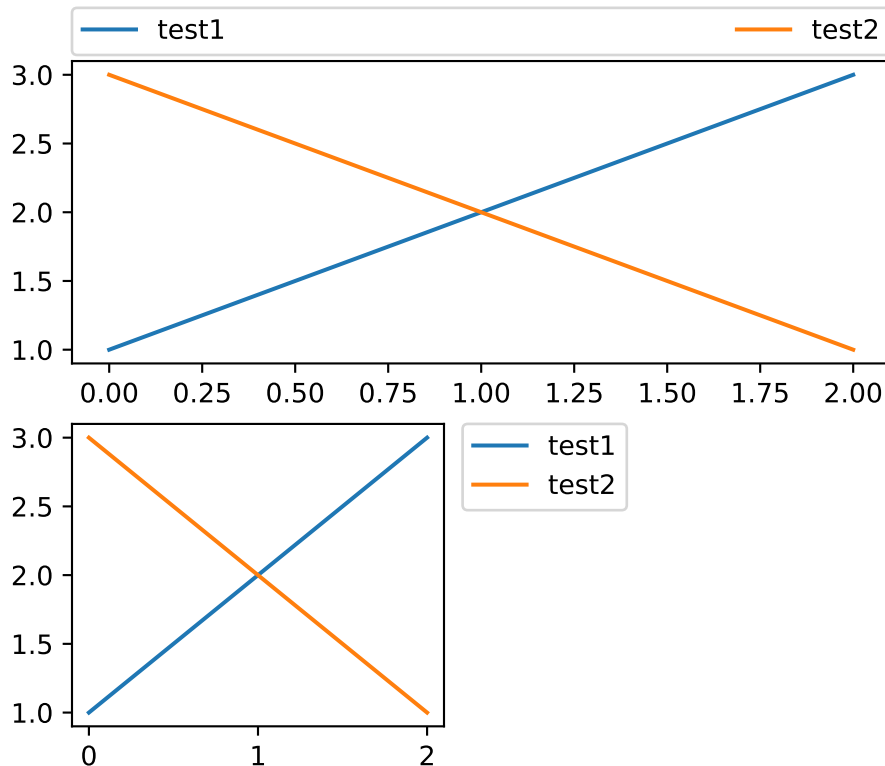

Multiple legends on the same Axes

Sometimes it is more clear to split legend entries across multiple legends. Whilst the instinctive approach to doing this might be to call the `legend()` function multiple times, you will find that only one legend ever exists on the Axes. This has been done so that it is possible to call `legend()` repeatedly to update the legend to the latest handles on the Axes, so to persist old legend instances, we must add them manually to the Axes:

```
import matplotlib.pyplot as plt

line1, = plt.plot([1,2,3], label="Line 1", linestyle='--')
line2, = plt.plot([3,2,1], label="Line 2", linewidth=4)

# Create a legend for the first line.
first_legend = plt.legend(handles=[line1], loc=1)
```

```
# Add the legend manually to the current Axes.  
ax = plt.gca().add_artist(first_legend)  
  
# Create another legend for the second line.  
plt.legend(handles=[line2], loc=4)  
  
plt.show()
```

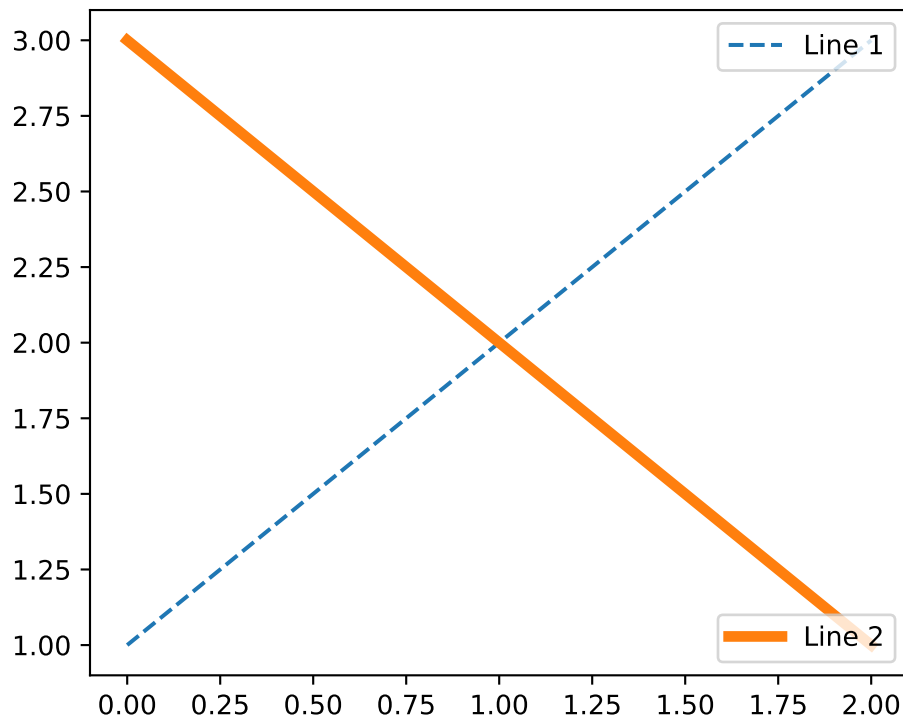

Legend Handlers

In order to create legend entries, handles are given as an argument to an appropriate *HandlerBase* subclass. The choice of handler subclass is determined by the following rules:

1. Update `get_legend_handler_map()` with the value in the `handler_map` keyword.
2. Check if the `handle` is in the newly created `handler_map`.
3. Check if the type of `handle` is in the newly created `handler_map`.
4. Check if any of the types in the `handle`'s mro is in the newly created `handler_map`.

For completeness, this logic is mostly implemented in `get_legend_handler()`.

All of this flexibility means that we have the necessary hooks to implement custom handlers for our own type of legend key.

The simplest example of using custom handlers is to instantiate one of the existing *HandlerBase* subclasses. For the sake of simplicity, let's choose `matplotlib.legend_handler.HandlerLine2D` which accepts a `numpoints` argument (note `numpoints` is a keyword on the `legend()` function for convenience). We can then pass the mapping of instance to Handler as a keyword to `legend`.

```
import matplotlib.pyplot as plt
from matplotlib.legend_handler import HandlerLine2D

line1, = plt.plot([3,2,1], marker='o', label='Line 1')
line2, = plt.plot([1,2,3], marker='o', label='Line 2')

plt.legend(handler_map={line1: HandlerLine2D(numpoints=4)})
```

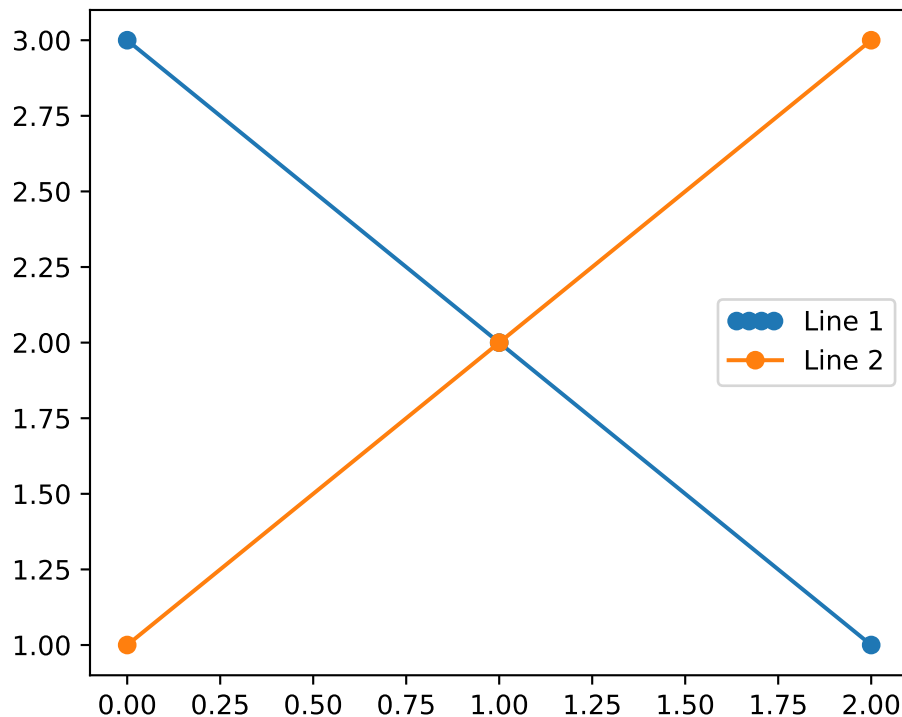

As you can see, “Line 1” now has 4 marker points, where “Line 2” has 2 (the default). Try the above code, only change the map’s key from `line1` to `type(line1)`. Notice how now both *Line2D* instances get 4 markers.

Along with handlers for complex plot types such as errorbars, stem plots and histograms, the default `handler_map` has a special tuple handler (*HandlerTuple*) which simply plots the handles on top of one another for each item in the given tuple. The following example demonstrates combining two legend keys on top of one another:

```

import matplotlib.pyplot as plt
from numpy.random import randn

z = randn(10)

red_dot, = plt.plot(z, "ro", markersize=15)
# Put a white cross over some of the data.
white_cross, = plt.plot(z[:5], "w+", markeredgewidth=3, markersize=15)

plt.legend([red_dot, (red_dot, white_cross)], ["Attr A", "Attr A+B"])

```

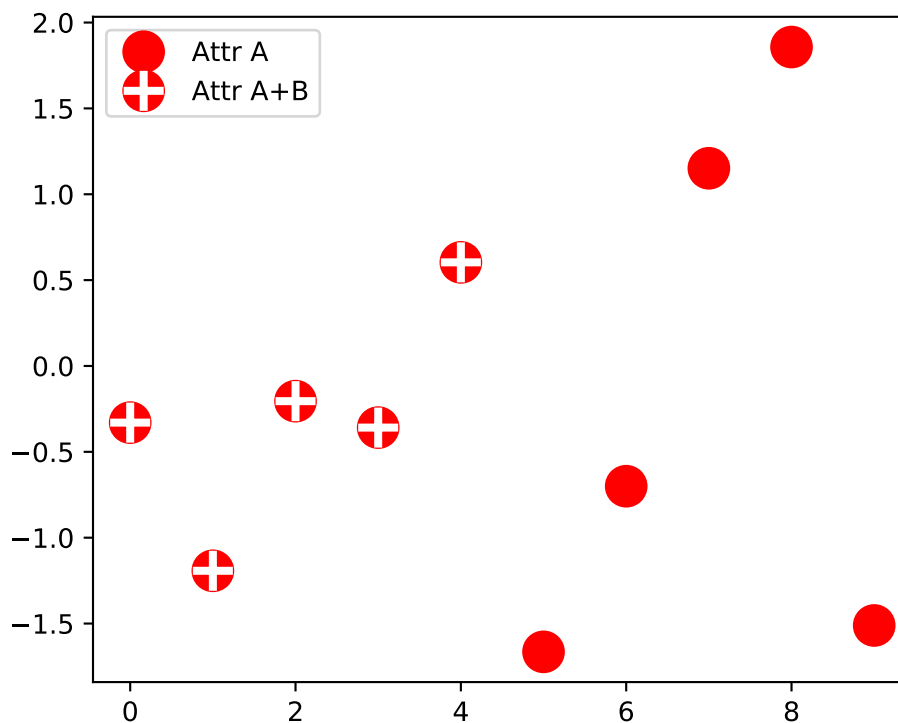

Implementing a custom legend handler

A custom handler can be implemented to turn any handle into a legend key (handles don't necessarily need to be matplotlib artists). The handler must implement a "legend_artist" method which returns a single artist for the legend to use. Signature details about the "legend_artist" are documented at [legend_artist\(\)](#).

```

import matplotlib.pyplot as plt
import matplotlib.patches as mpatches

class AnyObject(object):
    pass

```



```

class AnyObjectHandler(object):
    def legend_artist(self, legend, orig_handle, fontsize, handlebox):
        x0, y0 = handlebox.xdescent, handlebox.ydescent
        width, height = handlebox.width, handlebox.height
        patch = mpatches.Rectangle([x0, y0], width, height, facecolor='red',
                                   edgecolor='black', hatch='xx', lw=3,
                                   transform=handlebox.get_transform())
        handlebox.add_artist(patch)
        return patch

plt.legend([AnyObject()], ['My first handler'],
          handler_map={AnyObject: AnyObjectHandler()})

```

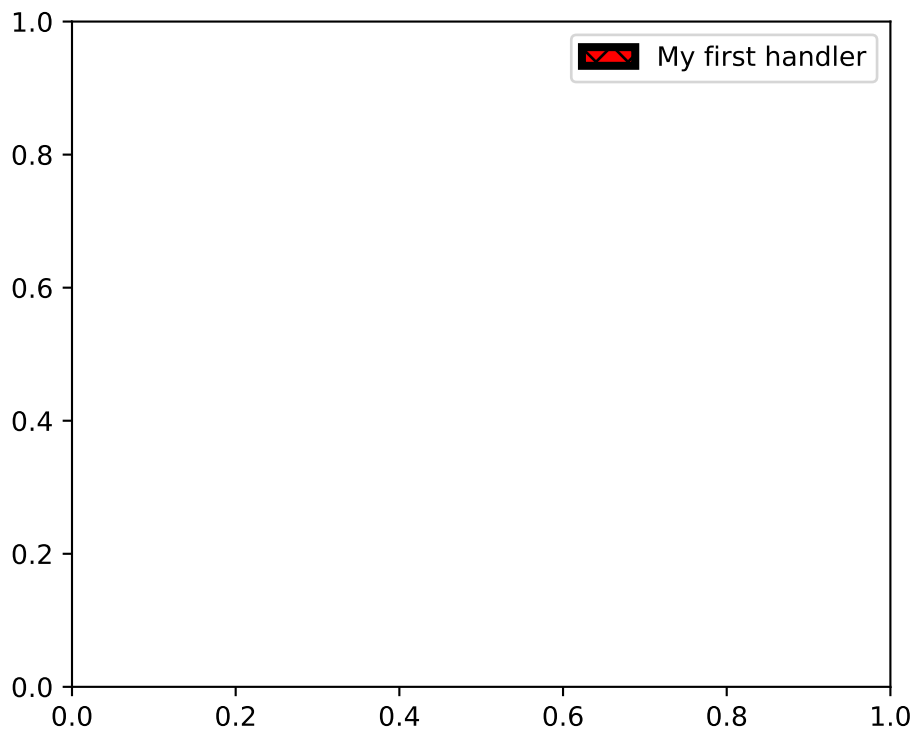

Alternatively, had we wanted to globally accept `AnyObject` instances without needing to manually set the `handler_map` keyword all the time, we could have registered the new handler with:

```

from matplotlib.legend import Legend
Legend.update_default_handler_map({AnyObject: AnyObjectHandler()})

```

Whilst the power here is clear, remember that there are already many handlers implemented and what you want to achieve may already be easily possible with existing classes. For example, to produce elliptical legend keys, rather than rectangular ones:

```

from matplotlib.legend_handler import HandlerPatch
import matplotlib.pyplot as plt

```

```

import matplotlib.patches as mpatches

class HandlerEllipse(HandlerPatch):
    def create_artists(self, legend, orig_handle,
                      xdescent, ydescent, width, height, fontsize, trans):
        center = 0.5 * width - 0.5 * xdescent, 0.5 * height - 0.5 * ydescent
        p = mpatches.Ellipse(xy=center, width=width + xdescent,
                             height=height + ydescent)
        self.update_prop(p, orig_handle, legend)
        p.set_transform(trans)
        return [p]

c = mpatches.Circle((0.5, 0.5), 0.25, facecolor="green",
                    edgecolor="red", linewidth=3)
plt.gca().add_patch(c)

plt.legend([c], ["An ellipse, not a rectangle"],
           handler_map={mpatches.Circle: HandlerEllipse()})

```

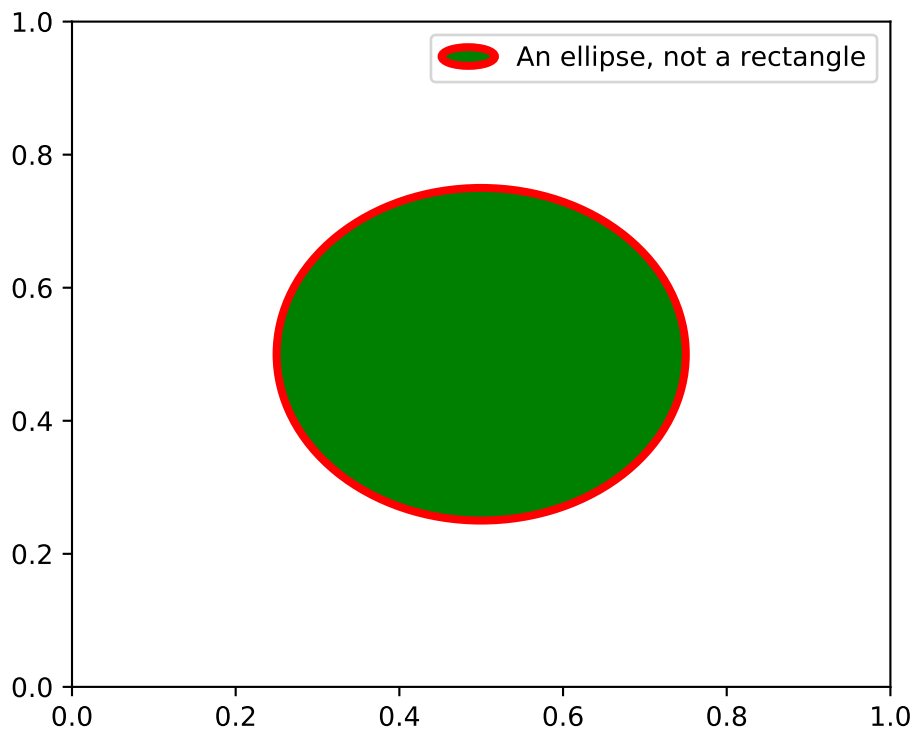

Known examples of using legend

Here is a non-exhaustive list of the examples available involving legend being used in various ways:

- *lines_bars_and_markers example code: scatter_with_legend.py*
- *api example code: legend_demo.py*
- *pylab_examples example code: contourf_hatching.py*
- *pylab_examples example code: figlegend_demo.py*
- *pylab_examples example code: scatter_symbol.py*

3.3 Advanced

3.3.1 Transformations Tutorial

Like any graphics packages, matplotlib is built on top of a transformation framework to easily move between coordinate systems, the userland data coordinate system, the axes coordinate system, the figure coordinate system, and the display coordinate system. In 95% of your plotting, you won't need to think about this, as it happens under the hood, but as you push the limits of custom figure generation, it helps to have an understanding of these objects so you can reuse the existing transformations matplotlib makes available to you, or create your own (see *matplotlib.transforms*). The table below summarizes the existing coordinate systems, the transformation object you should use to work in that coordinate system, and the description of that system. In the Transformation Object column, `ax` is a *Axes* instance, and `fig` is a *Figure* instance.

Co-ordinate	Transformation Object	Description
data	<code>ax.transData</code>	The userland data coordinate system, controlled by the <code>xlim</code> and <code>ylim</code>
axes	<code>ax.transAxes</code>	The coordinate system of the <i>Axes</i> ; (0,0) is bottom left of the axes, and (1,1) is top right of the axes.
figure	<code>fig.transFigure</code>	The coordinate system of the <i>Figure</i> ; (0,0) is bottom left of the figure, and (1,1) is top right of the figure.
display	None	This is the pixel coordinate system of the display; (0,0) is the bottom left of the display, and (width, height) is the top right of the display in pixels. Alternatively, the identity transform (<i>matplotlib.transforms.IdentityTransform()</i>) may be used instead of None.

All of the transformation objects in the table above take inputs in their coordinate system, and transform the input to the display coordinate system. That is why the display coordinate system has None for the Transformation Object column – it already is in display coordinates. The transformations also know how to invert themselves, to go from display back to the native coordinate system. This is particularly useful when processing events from the user interface, which typically occur in display space, and you want to know where the mouse click or key-press occurred in your data coordinate system.

Data coordinates

Let's start with the most commonly used coordinate, the data coordinate system. Whenever you add data to the axes, matplotlib updates the datalimits, most commonly updated with the `set_xlim()` and `set_ylim()` methods. For example, in the figure below, the data limits stretch from 0 to 10 on the x-axis, and -1 to 1 on the y-axis.

```
import numpy as np
import matplotlib.pyplot as plt

x = np.arange(0, 10, 0.005)
y = np.exp(-x/2.) * np.sin(2*np.pi*x)

fig = plt.figure()
ax = fig.add_subplot(111)
ax.plot(x, y)
ax.set_xlim(0, 10)
ax.set_ylim(-1, 1)

plt.show()
```

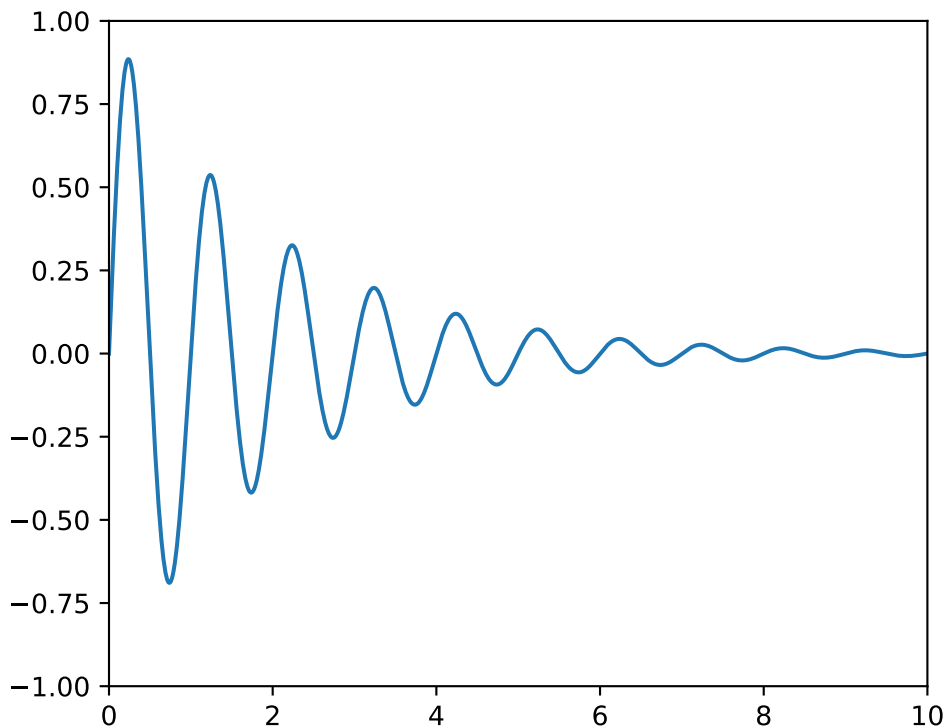

You can use the `ax.transData` instance to transform from your data to your display coordinate system, either a single point or a sequence of points as shown below:

```

In [14]: type(ax.transData)
Out[14]: <class 'matplotlib.transforms.CompositeGenericTransform'>

In [15]: ax.transData.transform((5, 0))
Out[15]: array([ 335.175,  247.   ])

In [16]: ax.transData.transform([(5, 0), (1,2)])
Out[16]:
array([[ 335.175,  247.   ],
       [ 132.435,  642.2  ]])

```

You can use the `inverted()` method to create a transform which will take you from display to data coordinates:

```

In [41]: inv = ax.transData.inverted()

In [42]: type(inv)
Out[42]: <class 'matplotlib.transforms.CompositeGenericTransform'>

In [43]: inv.transform((335.175, 247.))
Out[43]: array([ 5.,  0.])

```

If you are typing along with this tutorial, the exact values of the display coordinates may differ if you have a different window size or dpi setting. Likewise, in the figure below, the display labeled points are probably not the same as in the ipython session because the documentation figure size defaults are different.

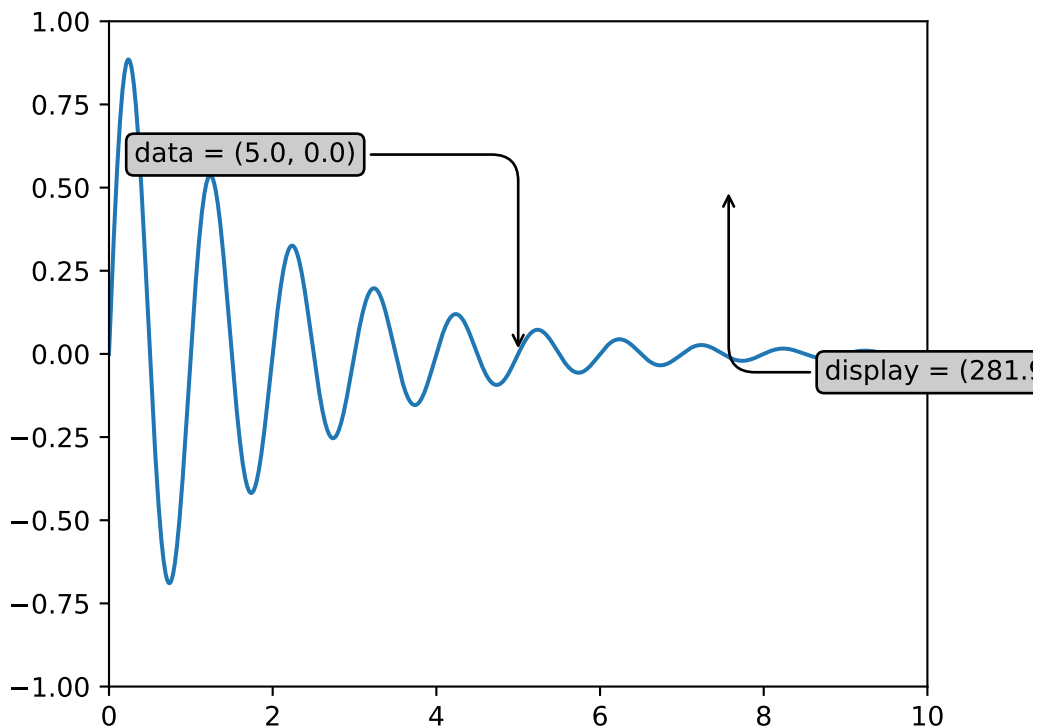

Note: If you run the source code in the example above in a GUI backend, you may also find that the two arrows for the data and `display` annotations do not point to exactly the same point. This is because the display point was computed before the figure was displayed, and the GUI backend may slightly resize the figure when it is created. The effect is more pronounced if you resize the figure yourself. This is one good reason why you rarely want to work in display space, but you can connect to the `'on_draw'` *Event* to update figure coordinates on figure draws; see *Event handling and picking*.

When you change the x or y limits of your axes, the data limits are updated so the transformation yields a new display point. Note that when we just change the `ylim`, only the y-display coordinate is altered, and when we change the `xlim` too, both are altered. More on this later when we talk about the *Bbox*.

```
In [54]: ax.transData.transform((5, 0))
Out[54]: array([ 335.175,  247.    ])

In [55]: ax.set_ylim(-1,2)
Out[55]: (-1, 2)

In [56]: ax.transData.transform((5, 0))
Out[56]: array([ 335.175      , 181.13333333])

In [57]: ax.set_xlim(10,20)
Out[57]: (10, 20)

In [58]: ax.transData.transform((5, 0))
Out[58]: array([-171.675      , 181.13333333])
```

Axes coordinates

After the data coordinate system, axes is probably the second most useful coordinate system. Here the point (0,0) is the bottom left of your axes or subplot, (0.5, 0.5) is the center, and (1.0, 1.0) is the top right. You can also refer to points outside the range, so (-0.1, 1.1) is to the left and above your axes. This coordinate system is extremely useful when placing text in your axes, because you often want a text bubble in a fixed, location, e.g., the upper left of the axes pane, and have that location remain fixed when you pan or zoom. Here is a simple example that creates four panels and labels them 'A', 'B', 'C', 'D' as you often see in journals.

```
import numpy as np
import matplotlib.pyplot as plt

fig = plt.figure()
for i, label in enumerate(('A', 'B', 'C', 'D')):
    ax = fig.add_subplot(2,2,i+1)
    ax.text(0.05, 0.95, label, transform=ax.transAxes,
           fontsize=16, fontweight='bold', va='top')

plt.show()
```

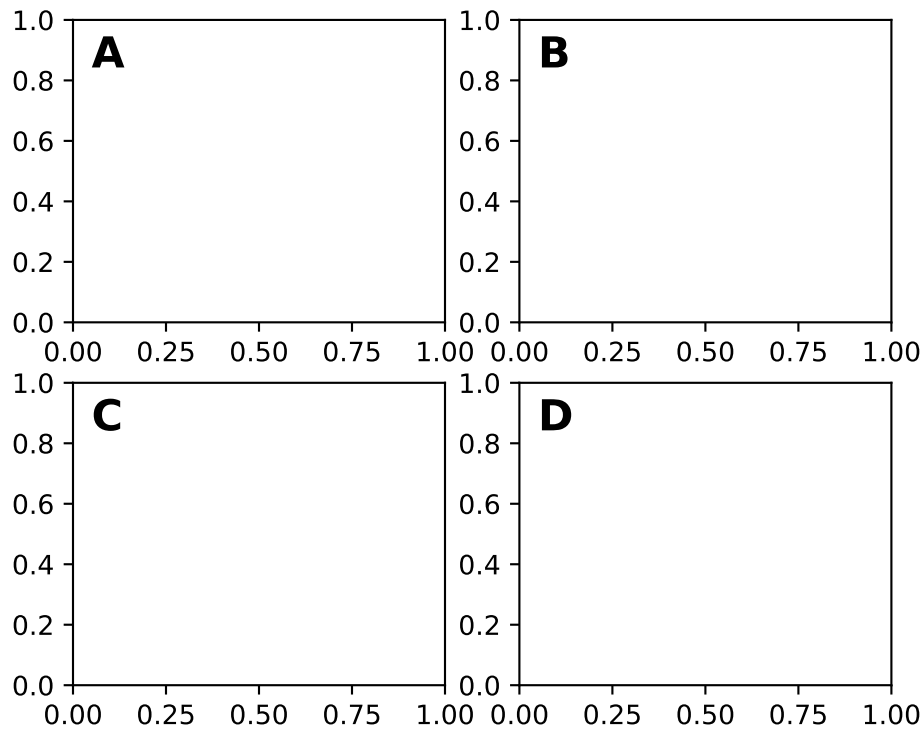

You can also make lines or patches in the axes coordinate system, but this is less useful in my experience than using `ax.transAxes` for placing text. Nonetheless, here is a silly example which plots some random dots in data space, and overlays a semi-transparent `Circle` centered in the middle of the axes with a radius one quarter of the axes – if your axes does not preserve aspect ratio (see `set_aspect()`), this will look like an ellipse. Use the pan/zoom tool to move around, or manually change the data `xlim` and `ylim`, and you will see the data move, but the circle will remain fixed because it is not in data coordinates and will always remain at the center of the axes.

```
import numpy as np
import matplotlib.pyplot as plt
import matplotlib.patches as patches
fig = plt.figure()
ax = fig.add_subplot(111)
x, y = 10*np.random.rand(2, 1000)
ax.plot(x, y, 'go') # plot some data in data coordinates

circ = patches.Circle((0.5, 0.5), 0.25, transform=ax.transAxes,
                      facecolor='yellow', alpha=0.5)
ax.add_patch(circ)

plt.show()
```

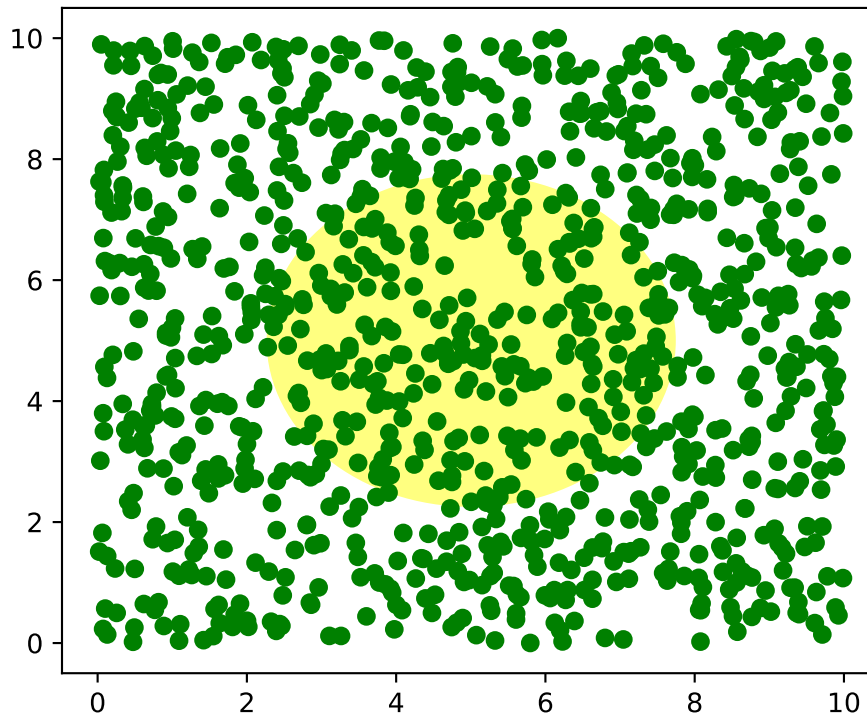

Blended transformations

Drawing in blended coordinate spaces which mix axes with data coordinates is extremely useful, for example to create a horizontal span which highlights some region of the y-data but spans across the x-axis regardless of the data limits, pan or zoom level, etc. In fact these blended lines and spans are so useful, we have built in functions to make them easy to plot (see `axhline()`, `axvline()`, `axhspan()`, `axvspan()`) but for didactic purposes we will implement the horizontal span here using a blended transformation. This trick only works for separable transformations, like you see in normal Cartesian coordinate systems, but not on inseparable transformations like the *PolarTransform*.

```
import numpy as np
import matplotlib.pyplot as plt
import matplotlib.patches as patches
import matplotlib.transforms as transforms

fig = plt.figure()
ax = fig.add_subplot(111)

x = np.random.randn(1000)

ax.hist(x, 30)
ax.set_title(r'$\sigma=1 \vee \dots \vee \sigma=2$', fontsize=16)

# the x coords of this transformation are data, and the
```



```

# y coord are axes
trans = transforms.blended_transform_factory(
    ax.transData, ax.transAxes)

# highlight the 1..2 stddev region with a span.
# We want x to be in data coordinates and y to
# span from 0..1 in axes coords
rect = patches.Rectangle((1,0), width=1, height=1,
                        transform=trans, color='yellow',
                        alpha=0.5)

ax.add_patch(rect)

plt.show()

```

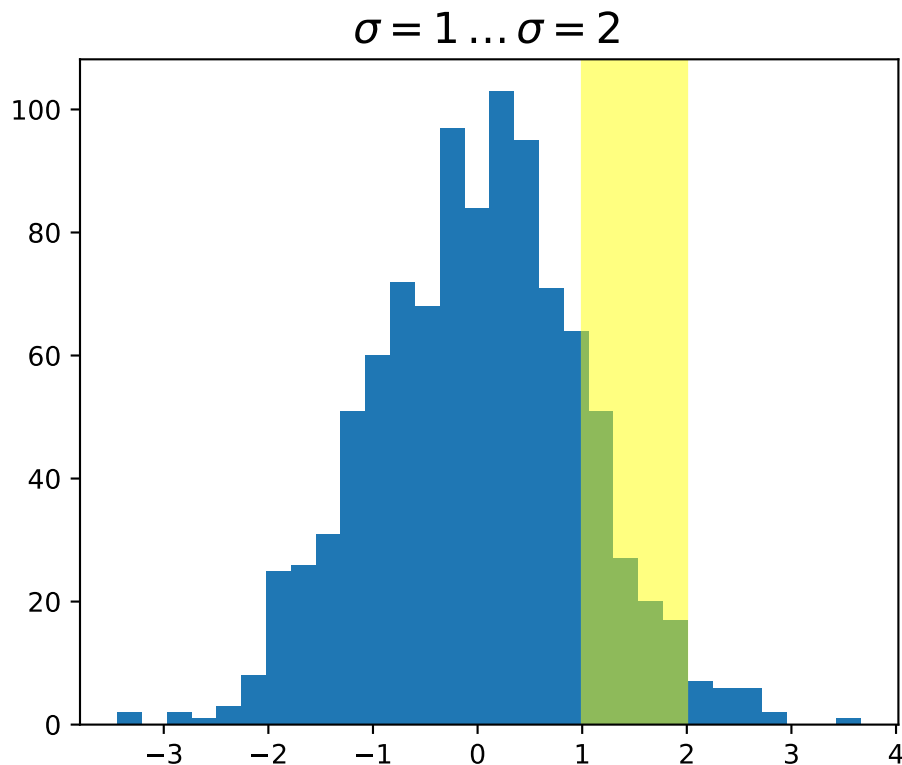

Note: The blended transformations where x is in data coords and y in axes coordinates is so useful that we have helper methods to return the versions `mpl` uses internally for drawing ticks, ticklabels, etc. The methods are `matplotlib.axes.Axes.get_xaxis_transform()` and `matplotlib.axes.Axes.get_yaxis_transform()`. So in the example above, the call to `blended_transform_factory()` can be replaced by `get_xaxis_transform`:

```
trans = ax.get_xaxis_transform()
```

Using offset transforms to create a shadow effect

One use of transformations is to create a new transformation that is offset from another transformation, e.g., to place one object shifted a bit relative to another object. Typically you want the shift to be in some physical dimension, like points or inches rather than in data coordinates, so that the shift effect is constant at different zoom levels and dpi settings.

One use for an offset is to create a shadow effect, where you draw one object identical to the first just to the right of it, and just below it, adjusting the zorder to make sure the shadow is drawn first and then the object it is shadowing above it. The transforms module has a helper transformation *ScaledTranslation*. It is instantiated with:

```
trans = ScaledTranslation(xt, yt, scale_trans)
```

where *xt* and *yt* are the translation offsets, and *scale_trans* is a transformation which scales *xt* and *yt* at transformation time before applying the offsets. A typical use case is to use the figure *fig.dpi_scale_trans* transformation for the *scale_trans* argument, to first scale *xt* and *yt* specified in points to display space before doing the final offset. The dpi and inches offset is a common-enough use case that we have a special helper function to create it in `matplotlib.transforms.offset_copy()`, which returns a new transform with an added offset. But in the example below, we'll create the offset transform ourselves. Note the use of the plus operator in:

```
offset = transforms.ScaledTranslation(dx, dy,
    fig.dpi_scale_trans)
shadow_transform = ax.transData + offset
```

showing that can chain transformations using the addition operator. This code says: first apply the data transformation `ax.transData` and then translate the data by *dx* and *dy* points. In typography, a 'point' https://en.wikipedia.org/wiki/Point_%28typography%29 is 1/72 inches, and by specifying your offsets in points, your figure will look the same regardless of the dpi resolution it is saved in.

```
import numpy as np
import matplotlib.pyplot as plt
import matplotlib.patches as patches
import matplotlib.transforms as transforms

fig = plt.figure()
ax = fig.add_subplot(111)

# make a simple sine wave
x = np.arange(0., 2., 0.01)
y = np.sin(2*np.pi*x)
line, = ax.plot(x, y, lw=3, color='blue')

# shift the object over 2 points, and down 2 points
dx, dy = 2/72., -2/72.
offset = transforms.ScaledTranslation(dx, dy,
    fig.dpi_scale_trans)
shadow_transform = ax.transData + offset

# now plot the same data with our offset transform;
# use the zorder to make sure we are below the line
```

```
ax.plot(x, y, lw=3, color='gray',
        transform=shadow_transform,
        zorder=0.5*line.get_zorder())

ax.set_title('creating a shadow effect with an offset transform')
plt.show()
```

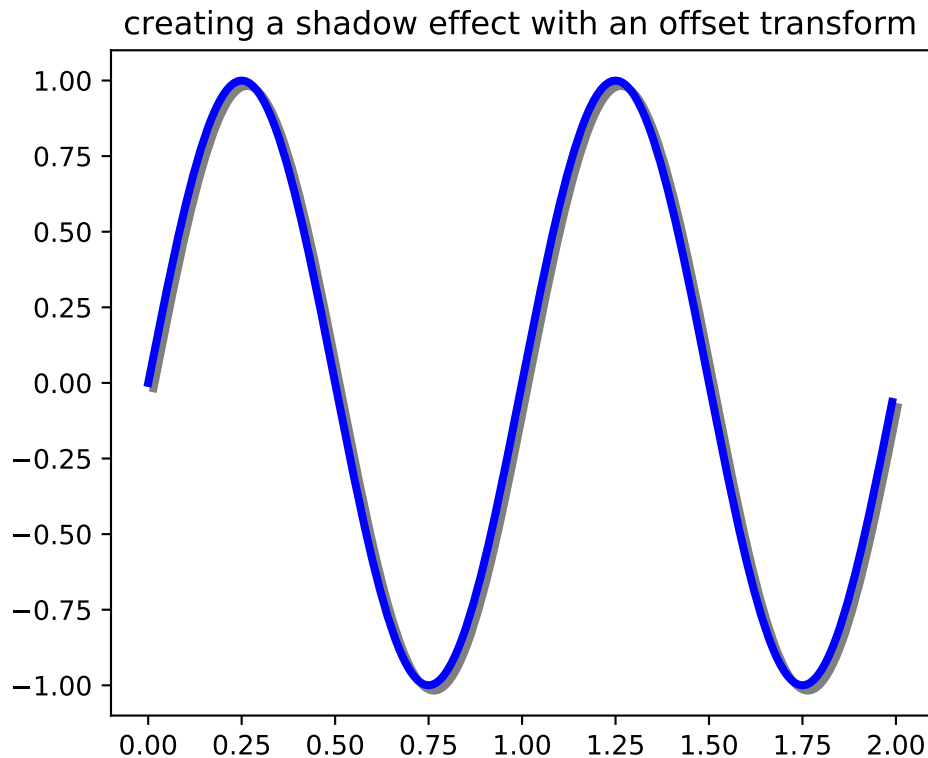

The transformation pipeline

The `ax.transData` transform we have been working with in this tutorial is a composite of three different transformations that comprise the transformation pipeline from data -> display coordinates. Michael Droettboom implemented the transformations framework, taking care to provide a clean API that segregated the nonlinear projections and scales that happen in polar and logarithmic plots, from the linear affine transformations that happen when you pan and zoom. There is an efficiency here, because you can pan and zoom in your axes which affects the affine transformation, but you may not need to compute the potentially expensive nonlinear scales or projections on simple navigation events. It is also possible to multiply affine transformation matrices together, and then apply them to coordinates in one step. This is not true of all possible transformations.

Here is how the `ax.transData` instance is defined in the basic separable axis `Axes` class:

```
self.transData = self.transScale + (self.transLimits + self.transAxes)
```

We've been introduced to the `transAxes` instance above in *Axes coordinates*, which maps the (0,0), (1,1) corners of the axes or subplot bounding box to display space, so let's look at these other two pieces.

`self.transLimits` is the transformation that takes you from data to axes coordinates; i.e., it maps your view `xlim` and `ylim` to the unit space of the axes (and `transAxes` then takes that unit space to display space). We can see this in action here

```
In [80]: ax = subplot(111)
In [81]: ax.set_xlim(0, 10)
Out[81]: (0, 10)
In [82]: ax.set_ylim(-1,1)
Out[82]: (-1, 1)
In [84]: ax.transLimits.transform((0,-1))
Out[84]: array([ 0.,  0.])
In [85]: ax.transLimits.transform((10,-1))
Out[85]: array([ 1.,  0.])
In [86]: ax.transLimits.transform((10,1))
Out[86]: array([ 1.,  1.])
In [87]: ax.transLimits.transform((5,0))
Out[87]: array([ 0.5,  0.5])
```

and we can use this same inverted transformation to go from the unit axes coordinates back to data coordinates.

```
In [90]: inv.transform((0.25, 0.25))
Out[90]: array([ 2.5, -0.5])
```

The final piece is the `self.transScale` attribute, which is responsible for the optional non-linear scaling of the data, e.g., for logarithmic axes. When an `Axis` is initially setup, this is just set to the identity transform, since the basic matplotlib axes has linear scale, but when you call a logarithmic scaling function like `semilogx()` or explicitly set the scale to logarithmic with `set_xscale()`, then the `ax.transScale` attribute is set to handle the nonlinear projection. The scales transforms are properties of the respective `xaxis` and `yaxis` `Axis` instances. For example, when you call `ax.set_xscale('log')`, the `xaxis` updates its scale to a `matplotlib.scale.LogScale` instance.

For non-separable axes the `PolarAxes`, there is one more piece to consider, the projection transformation. The `transData` `matplotlib.projections.polar.PolarAxes` is similar to that for the typical separable matplotlib `Axis`, with one additional piece `transProjection`:

```
self.transData = self.transScale + self.transProjection + \
    (self.transProjectionAffine + self.transAxes)
```

`transProjection` handles the projection from the space, e.g., latitude and longitude for map data, or radius and theta for polar data, to a separable Cartesian coordinate system. There are several projection examples in the `matplotlib.projections` package, and the best way to learn more is to open the source for those packages and see how to make your own, since matplotlib supports extensible axes and projections. Michael

Droettboom has provided a nice tutorial example of creating a hammer projection axes; see *api example code: custom_projection_example.py*.

3.3.2 Path Tutorial

The object underlying all of the `matplotlib.patch` objects is the `Path`, which supports the standard set of `moveto`, `lineto`, `curveto` commands to draw simple and compound outlines consisting of line segments and splines. The `Path` is instantiated with a (N,2) array of (x,y) vertices, and a N-length array of path codes. For example to draw the unit rectangle from (0,0) to (1,1), we could use this code

```
import matplotlib.pyplot as plt
from matplotlib.path import Path
import matplotlib.patches as patches

verts = [
    (0., 0.), # left, bottom
    (0., 1.), # left, top
    (1., 1.), # right, top
    (1., 0.), # right, bottom
    (0., 0.), # ignored
]

codes = [Path.MOVETO,
         Path.LINETO,
         Path.LINETO,
         Path.LINETO,
         Path.CLOSEPOLY,
         ]

path = Path(verts, codes)

fig = plt.figure()
ax = fig.add_subplot(111)
patch = patches.PathPatch(path, facecolor='orange', lw=2)
ax.add_patch(patch)
ax.set_xlim(-2,2)
ax.set_ylim(-2,2)
plt.show()
```

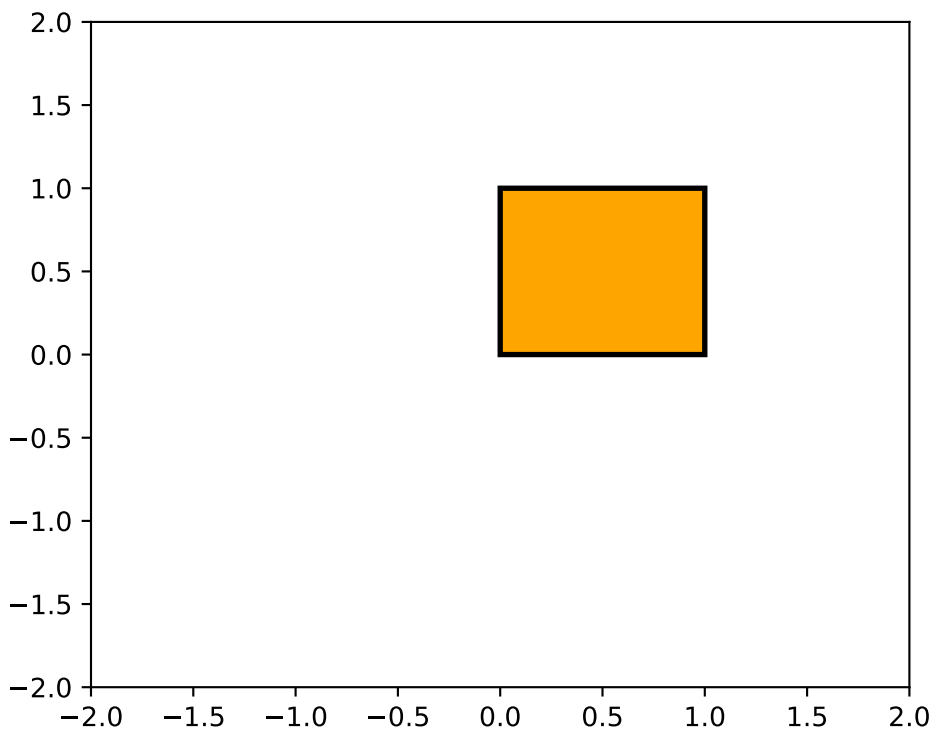

The following path codes are recognized

Code	Vertices	Description
STOP	1 (ignored)	A marker for the end of the entire path (currently not required and ignored)
MOVETO	1	Pick up the pen and move to the given vertex.
LINETO	1	Draw a line from the current position to the given vertex.
CURVE3	2 (1 control point, 1 endpoint)	Draw a quadratic Bézier curve from the current position, with the given control point, to the given end point.
CURVE4	3 (2 control points, 1 endpoint)	Draw a cubic Bézier curve from the current position, with the given control points, to the given end point.
CLOSEPOLY	(point itself is ignored)	Draw a line segment to the start point of the current polyline.

Bézier example

Some of the path components require multiple vertices to specify them: for example CURVE 3 is a *bézier* curve with one control point and one end point, and CURVE4 has three vertices for the two control points and the end point. The example below shows a CURVE4 Bézier spline – the *bézier* curve will be contained in the convex hull of the start point, the two control points, and the end point

```
import matplotlib.pyplot as plt
from matplotlib.path import Path
```

```
import matplotlib.patches as patches

verts = [
    (0., 0.), # P0
    (0.2, 1.), # P1
    (1., 0.8), # P2
    (0.8, 0.), # P3
]

codes = [Path.MOVETO,
         Path.CURVE4,
         Path.CURVE4,
         Path.CURVE4,
         ]

path = Path(verts, codes)

fig = plt.figure()
ax = fig.add_subplot(111)
patch = patches.PathPatch(path, facecolor='none', lw=2)
ax.add_patch(patch)

xs, ys = zip(*verts)
ax.plot(xs, ys, 'x--', lw=2, color='black', ms=10)

ax.text(-0.05, -0.05, 'P0')
ax.text(0.15, 1.05, 'P1')
ax.text(1.05, 0.85, 'P2')
ax.text(0.85, -0.05, 'P3')

ax.set_xlim(-0.1, 1.1)
ax.set_ylim(-0.1, 1.1)
plt.show()
```

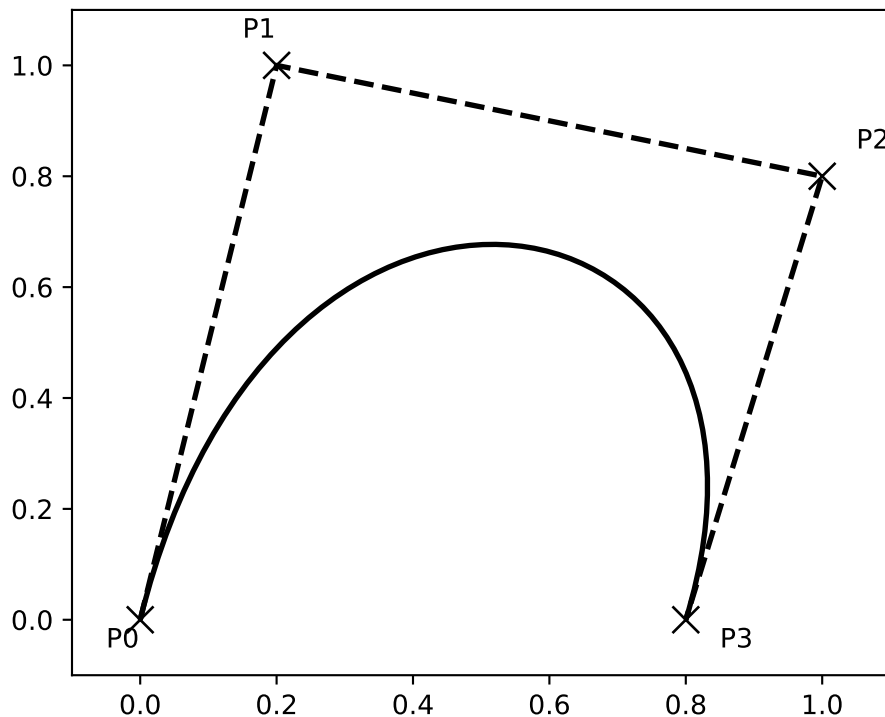

Compound paths

All of the simple patch primitives in matplotlib, Rectangle, Circle, Polygon, etc, are implemented with simple path. Plotting functions like `hist()` and `bar()`, which create a number of primitives, e.g., a bunch of Rectangles, can usually be implemented more efficiently using a compound path. The reason `bar` creates a list of rectangles and not a compound path is largely historical: the `Path` code is comparatively new and `bar` predates it. While we could change it now, it would break old code, so here we will cover how to create compound paths, replacing the functionality in `bar`, in case you need to do so in your own code for efficiency reasons, e.g., you are creating an animated bar plot.

We will make the histogram chart by creating a series of rectangles for each histogram bar: the rectangle width is the bin width and the rectangle height is the number of datapoints in that bin. First we'll create some random normally distributed data and compute the histogram. Because numpy returns the bin edges and not centers, the length of `bins` is 1 greater than the length of `n` in the example below:

```
# histogram our data with numpy
data = np.random.randn(1000)
n, bins = np.histogram(data, 100)
```

We'll now extract the corners of the rectangles. Each of the `left`, `bottom`, etc, arrays below is `len(n)`, where `n` is the array of counts for each histogram bar:

```
# get the corners of the rectangles for the histogram
left = np.array(bins[:-1])
right = np.array(bins[1:])
bottom = np.zeros(len(left))
top = bottom + n
```

Now we have to construct our compound path, which will consist of a series of MOVETO, LINETO and CLOSEPOLY for each rectangle. For each rectangle, we need 5 vertices: 1 for the MOVETO, 3 for the LINETO, and 1 for the CLOSEPOLY. As indicated in the table above, the vertex for the closepoly is ignored but we still need it to keep the codes aligned with the vertices:

```
nverts = nrects*(1+3+1)
verts = np.zeros((nverts, 2))
codes = np.ones(nverts, int) * path.Path.LINETO
codes[0::5] = path.Path.MOVETO
codes[4::5] = path.Path.CLOSEPOLY
verts[0::5,0] = left
verts[0::5,1] = bottom
verts[1::5,0] = left
verts[1::5,1] = top
verts[2::5,0] = right
verts[2::5,1] = top
verts[3::5,0] = right
verts[3::5,1] = bottom
```

All that remains is to create the path, attach it to a PathPatch, and add it to our axes:

```
barpath = path.Path(verts, codes)
patch = patches.PathPatch(barpath, facecolor='green',
    edgecolor='yellow', alpha=0.5)
ax.add_patch(patch)
```

Here is the result

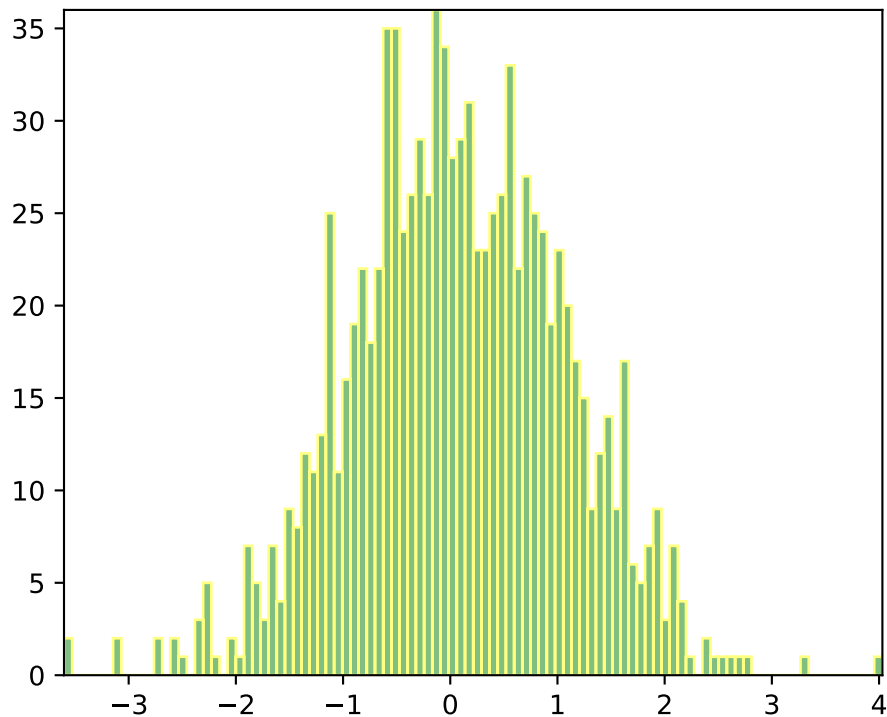

3.3.3 Path effects guide

Matplotlib's `patheffects` module provides functionality to apply a multiple draw stage to any Artist which can be rendered via a `Path`.

Artists which can have a path effect applied to them include `Patch`, `Line2D`, `Collection` and even `Text`. Each artist's path effects can be controlled via the `set_path_effects` method (`set_path_effects`), which takes an iterable of `AbstractPathEffect` instances.

The simplest path effect is the `Normal` effect, which simply draws the artist without any effect:

```
import matplotlib.pyplot as plt
import matplotlib.patheffects as path_effects

fig = plt.figure(figsize=(5, 1.5))
text = fig.text(0.5, 0.5, 'Hello path effects world!\nThis is the normal '
                'path effect.\nPretty dull, huh?',
                ha='center', va='center', size=20)
text.set_path_effects([path_effects.Normal()])
plt.show()
```

Hello path effects world!

This is the normal path effect.

Pretty dull, huh?

Whilst the plot doesn't look any different to what you would expect without any path effects, the drawing of the text now been changed to use the path effects framework, opening up the possibilities for more interesting examples.

Adding a shadow

A far more interesting path effect than *Normal* is the drop-shadow, which we can apply to any of our path based artists. The classes *SimplePatchShadow* and *SimpleLineShadow* do precisely this by drawing either a filled patch or a line patch below the original artist:

```
import matplotlib.pyplot as plt
import matplotlib.path_effects as path_effects

text = plt.text(0.5, 0.5, 'Hello path effects world!',
               path_effects=[path_effects.withSimplePatchShadow()])

plt.plot([0, 3, 2, 5], linewidth=5, color='blue',
        path_effects=[path_effects.SimpleLineShadow(),
                    path_effects.Normal()])

plt.show()
```

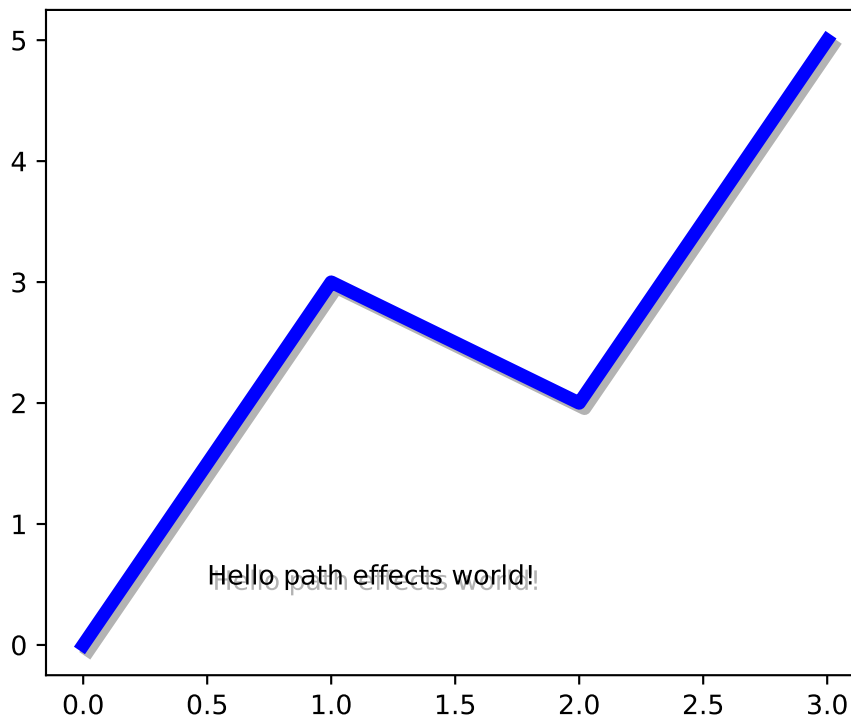

Notice the two approaches to setting the path effects in this example. The first uses the `with*` classes to include the desired functionality automatically followed with the “normal” effect, whereas the latter explicitly defines the two path effects to draw.

Making an artist stand out

One nice way of making artists visually stand out is to draw an outline in a bold color below the actual artist. The `Stroke` path effect makes this a relatively simple task:

```
import matplotlib.pyplot as plt
import matplotlib.path_effects as path_effects

fig = plt.figure(figsize=(7, 1))
text = fig.text(0.5, 0.5, 'This text stands out because of\n'
                    'its black border.', color='white',
                    ha='center', va='center', size=30)
text.set_path_effects([path_effects.Stroke(linewidth=3, foreground='black'),
                    path_effects.Normal()])
plt.show()
```

This text stands out because of its black border.

It is important to note that this effect only works because we have drawn the text path twice; once with a thick black line, and then once with the original text path on top.

You may have noticed that the keywords to *Stroke* and *SimplePatchShadow* and *SimpleLineShadow* are not the usual Artist keywords (such as `facecolor` and `edgecolor` etc.). This is because with these path effects we are operating at lower level of matplotlib. In fact, the keywords which are accepted are those for a `matplotlib.backend_bases.GraphicsContextBase` instance, which have been designed for making it easy to create new backends - and not for its user interface.

Greater control of the path effect artist

As already mentioned, some of the path effects operate at a lower level than most users will be used to, meaning that setting keywords such as `facecolor` and `edgecolor` raise an `AttributeError`. Luckily there is a generic *PathPatchEffect* path effect which creates a *PathPatch* class with the original path. The keywords to this effect are identical to those of *PathPatch*:

```
import matplotlib.pyplot as plt
import matplotlib.path_effects as path_effects

fig = plt.figure(figsize=(8, 1))
t = fig.text(0.02, 0.5, 'Hatch shadow', fontsize=75, weight=1000, va='center')
t.set_path_effects([path_effects.PathPatchEffect(offset=(4, -4), hatch='xxxx',
                                                facecolor='gray'),
                  path_effects.PathPatchEffect(edgecolor='white', linewidth=1.1,
                                                facecolor='black')])

plt.show()
```

Hatch shadow

WORKING WITH TEXT

4.1 Text introduction

matplotlib has extensive text support, including support for mathematical expressions, truetype support for raster and vector outputs, newline separated text with arbitrary rotations, and unicode support. Because it embeds fonts directly in output documents, e.g., for postscript or PDF, what you see on the screen is what you get in the hardcopy. *FreeType* support produces very nice, antialiased fonts, that look good even at small raster sizes. matplotlib includes its own *matplotlib.font_manager* (thanks to Paul Barrett), which implements a cross platform, W3C compliant font finding algorithm.

The user has a great deal of control over text properties (font size, font weight, text location and color, etc.) with sensible defaults set in the *rc file*. And significantly, for those interested in mathematical or scientific figures, matplotlib implements a large number of TeX math symbols and commands, supporting *mathematical expressions* anywhere in your figure.

4.2 Basic text commands

The following commands are used to create text in the pyplot interface

- *text()* - add text at an arbitrary location to the Axes; *matplotlib.axes.Axes.text()* in the API.
- *xlabel()* - add a label to the x-axis; *matplotlib.axes.Axes.set_xlabel()* in the API.
- *ylabel()* - add a label to the y-axis; *matplotlib.axes.Axes.set_ylabel()* in the API.
- *title()* - add a title to the Axes; *matplotlib.axes.Axes.set_title()* in the API.
- *figtext()* - add text at an arbitrary location to the Figure; *matplotlib.figure.Figure.text()* in the API.
- *suptitle()* - add a title to the Figure; *matplotlib.figure.Figure.suptitle()* in the API.
- *annotate()* - add an annotation, with optional arrow, to the Axes ; *matplotlib.axes.Axes.annotate()* in the API.

All of these functions create and return a *matplotlib.text.Text()* instance, which can be configured with a variety of font and other properties. The example below shows all of these commands in action.

```
# -*- coding: utf-8 -*-
import matplotlib.pyplot as plt

fig = plt.figure()
fig.suptitle('bold figure suptitle', fontsize=14, fontweight='bold')

ax = fig.add_subplot(111)
fig.subplots_adjust(top=0.85)
ax.set_title('axes title')

ax.set_xlabel('xlabel')
ax.set_ylabel('ylabel')

ax.text(3, 8, 'boxed italics text in data coords', style='italic',
        bbox={'facecolor':'red', 'alpha':0.5, 'pad':10})

ax.text(2, 6, r'an equation:  $E=mc^2$ ', fontsize=15)

ax.text(3, 2, u'unicode: Institut f\u00fcr Festk\u00f6rperphysik')

ax.text(0.95, 0.01, 'colored text in axes coords',
        verticalalignment='bottom', horizontalalignment='right',
        transform=ax.transAxes,
        color='green', fontsize=15)

ax.plot([2], [1], 'o')
ax.annotate('annotate', xy=(2, 1), xytext=(3, 4),
           arrowprops=dict(facecolor='black', shrink=0.05))

ax.axis([0, 10, 0, 10])

plt.show()
```

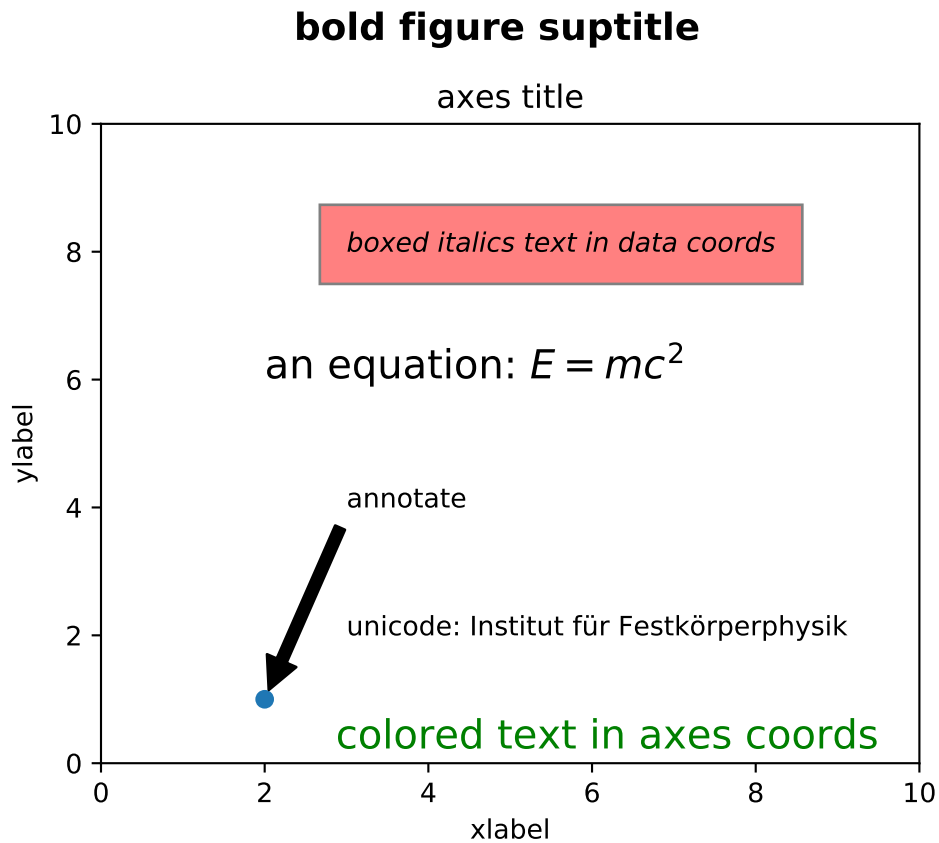
4.3 Text properties and layout

The `matplotlib.text.Text` instances have a variety of properties which can be configured via keyword arguments to the text commands (e.g., `title()`, `xlabel()` and `text()`).

Property	Value Type
alpha	float
backgroundcolor	any matplotlib <i>color</i>
bbox	<i>Rectangle</i> prop dict plus key 'pad' which is a pad in points
clip_box	a matplotlib.transform.Bbox instance
clip_on	[True False]
clip_path	a <i>Path</i> instance and a <i>Transform</i> instance, a <i>Patch</i>
color	any matplotlib <i>color</i>
family	['serif' 'sans-serif' 'cursive' 'fantasy' 'monospace']
fontproperties	a <i>FontProperties</i> instance
horizontalalignment or ha	['center' 'right' 'left']
label	any string
linespacing	float
multialignment	['left' 'right' 'center']
name or fontname	string e.g., ['Sans' 'Courier' 'Helvetica' ...]
picker	[None float boolean callable]
position	(x, y)
rotation	[angle in degrees 'vertical' 'horizontal']
size or fontsize	[size in points relative size, e.g., 'smaller', 'x-large']
style or fontstyle	['normal' 'italic' 'oblique']
text	string or anything printable with '%s' conversion
transform	a <i>Transform</i> instance
variant	['normal' 'small-caps']
verticalalignment or va	['center' 'top' 'bottom' 'baseline']
visible	[True False]
weight or fontweight	['normal' 'bold' 'heavy' 'light' 'ultrabold' 'ultralight']
x	float
y	float
zorder	any number

You can lay out text with the alignment arguments `horizontalalignment`, `verticalalignment`, and `multialignment`. `horizontalalignment` controls whether the x positional argument for the text indicates the left, center or right side of the text bounding box. `verticalalignment` controls whether the y positional argument for the text indicates the bottom, center or top side of the text bounding box. `multialignment`, for newline separated strings only, controls whether the different lines are left, center or right justified. Here is an example which uses the `text()` command to show the various alignment possibilities. The use of `transform=ax.transAxes` throughout the code indicates that the coordinates are given relative to the axes bounding box, with 0,0 being the lower left of the axes and 1,1 the upper right.

```
import matplotlib.pyplot as plt
import matplotlib.patches as patches

# build a rectangle in axes coords
left, width = .25, .5
bottom, height = .25, .5
right = left + width
```

```
top = bottom + height

fig = plt.figure()
ax = fig.add_axes([0,0,1,1])

# axes coordinates are 0,0 is bottom left and 1,1 is upper right
p = patches.Rectangle(
    (left, bottom), width, height,
    fill=False, transform=ax.transAxes, clip_on=False
)

ax.add_patch(p)

ax.text(left, bottom, 'left top',
        horizontalalignment='left',
        verticalalignment='top',
        transform=ax.transAxes)

ax.text(left, bottom, 'left bottom',
        horizontalalignment='left',
        verticalalignment='bottom',
        transform=ax.transAxes)

ax.text(right, top, 'right bottom',
        horizontalalignment='right',
        verticalalignment='bottom',
        transform=ax.transAxes)

ax.text(right, top, 'right top',
        horizontalalignment='right',
        verticalalignment='top',
        transform=ax.transAxes)

ax.text(right, bottom, 'center top',
        horizontalalignment='center',
        verticalalignment='top',
        transform=ax.transAxes)

ax.text(left, 0.5*(bottom+top), 'right center',
        horizontalalignment='right',
        verticalalignment='center',
        rotation='vertical',
        transform=ax.transAxes)

ax.text(left, 0.5*(bottom+top), 'left center',
        horizontalalignment='left',
        verticalalignment='center',
        rotation='vertical',
        transform=ax.transAxes)

ax.text(0.5*(left+right), 0.5*(bottom+top), 'middle',
        horizontalalignment='center',
        verticalalignment='center',
```

```

        fontsize=20, color='red',
        transform=ax.transAxes)

ax.text(right, 0.5*(bottom+top), 'centered',
        horizontalalignment='center',
        verticalalignment='center',
        rotation='vertical',
        transform=ax.transAxes)

ax.text(left, top, 'rotated\nwith newlines',
        horizontalalignment='center',
        verticalalignment='center',
        rotation=45,
        transform=ax.transAxes)

ax.set_axis_off()
plt.show()

```

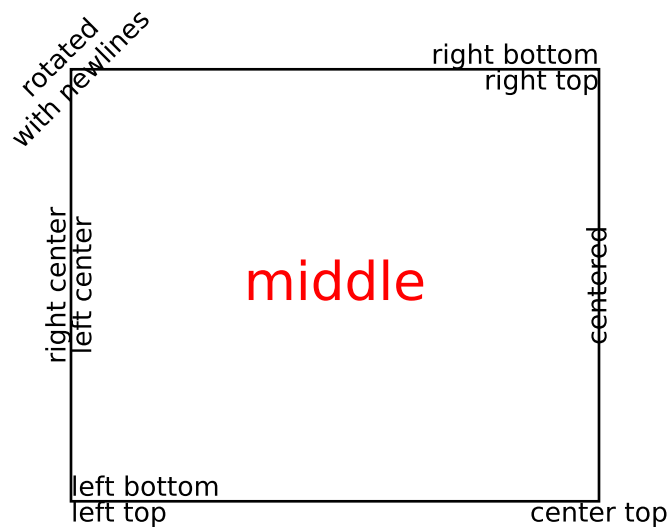

4.4 Default Font

The base default font is controlled by a set of rcParams:

rcParam	usage
'font.family'	List of either names of font or {'cursive', 'fantasy', 'monospace', 'sans', 'sans serif', 'sans-serif', 'serif'}.
'font.style'	The default style, ex 'normal', 'italic'.
'font.variant'	Default variant, ex 'normal', 'small-caps' (untested)
'font.stretch'	Default stretch, ex 'normal', 'condensed' (incomplete)
'font.weight'	Default weight. Either string or integer
'font.size'	Default font size in points. Relative font sizes ('large', 'x-small') are computed against this size.

The mapping between the family aliases ({'cursive', 'fantasy', 'monospace', 'sans', 'sans serif', 'sans-serif', 'serif'}) and actual font names is controlled by the following rcParams:

family alias	rcParam with mappings
'serif'	'font.serif'
'monospace'	'font.monospace'
'fantasy'	'font.fantasy'
'cursive'	'font.cursive'
{'sans', 'sans serif', 'sans-serif'}	'font.sans-serif'

which are lists of font names.

4.4.1 Text with non-latin glyphs

As of v2.0 the *default font* contains glyphs for many western alphabets, but still does not cover all of the glyphs that may be required by mpl users. For example, DejaVu has no coverage of Chinese, Korean, or Japanese.

To set the default font to be one that supports the code points you need, prepend the font name to 'font.family' or the desired alias lists

```
matplotlib.rcParams['font.sans-serif'] = ['Source Han Sans TW', 'sans-serif']
```

or set it in your `.matplotlibrc` file:

```
font.sans-serif: Source Han Sans TW, Ariel, sans-serif
```

To control the font used on per-artist basis use the 'name', 'fontname' or 'fontproperties' kwargs documented *above*.

On linux, `fc-list` can be a useful tool to discover the font name; for example

```
$ fc-list :lang=zh family
Noto to Sans Mono CJK TC,Noto Sans Mono CJK TC Bold
Noto Sans CJK TC,Noto Sans CJK TC Medium
Noto Sans CJK TC,Noto Sans CJK TC DemiLight
Noto Sans CJK KR,Noto Sans CJK KR Black
```

```
Noto Sans CJK TC,Noto Sans CJK TC Black
Noto Sans Mono CJK TC,Noto Sans Mono CJK TC Regular
Noto Sans CJK SC,Noto Sans CJK SC Light
```

lists all of the fonts that support Chinese.

4.5 Annotation

Table of Contents

- *Annotation*
 - *Basic annotation*
 - *Advanced Annotation*
 - * *Annotating with Text with Box*
 - * *Annotating with Arrow*
 - * *Placing Artist at the anchored location of the Axes*
 - * *Using Complex Coordinates with Annotations*
 - * *Using ConnectorPatch*
 - * *Zoom effect between Axes*
 - * *Define Custom BoxStyle*

4.5.1 Basic annotation

The uses of the basic `text()` will place text at an arbitrary position on the Axes. A common use case of text is to annotate some feature of the plot, and the `annotate()` method provides helper functionality to make annotations easy. In an annotation, there are two points to consider: the location being annotated represented by the argument `xy` and the location of the text `xytext`. Both of these arguments are `(x, y)` tuples.

```
import numpy as np
import matplotlib.pyplot as plt

fig = plt.figure()
ax = fig.add_subplot(111)

t = np.arange(0.0, 5.0, 0.01)
s = np.cos(2*np.pi*t)
line, = ax.plot(t, s, lw=2)

ax.annotate('local max', xy=(2, 1), xytext=(3, 1.5),
           arrowprops=dict(facecolor='black', shrink=0.05),
           )
```

```
ax.set_ylim(-2,2)
plt.show()
```

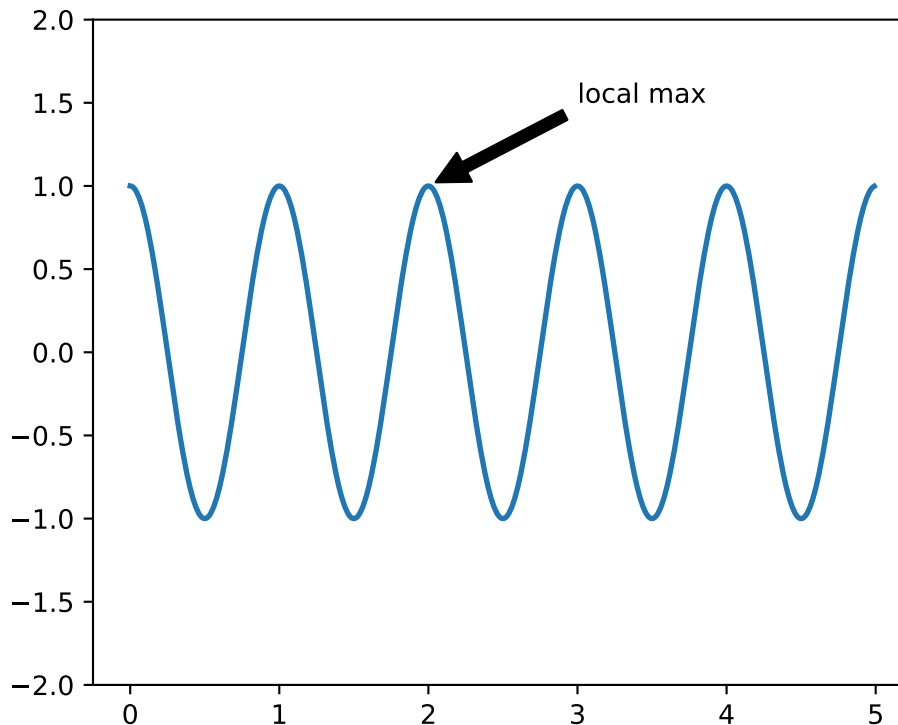

In this example, both the `xy` (arrow tip) and `xytext` locations (text location) are in data coordinates. There are a variety of other coordinate systems one can choose – you can specify the coordinate system of `xy` and `xytext` with one of the following strings for `xycoords` and `textcoords` (default is ‘data’)

argument	coordinate system
‘figure points’	points from the lower left corner of the figure
‘figure pixels’	pixels from the lower left corner of the figure
‘figure fraction’	0,0 is lower left of figure and 1,1 is upper right
‘axes points’	points from lower left corner of axes
‘axes pixels’	pixels from lower left corner of axes
‘axes fraction’	0,0 is lower left of axes and 1,1 is upper right
‘data’	use the axes data coordinate system

For example to place the text coordinates in fractional axes coordinates, one could do:

```
ax.annotate('local max', xy=(3, 1), xycoords='data',
            xytext=(0.8, 0.95), textcoords='axes fraction',
            arrowprops=dict(facecolor='black', shrink=0.05),
            horizontalalignment='right', verticalalignment='top',
            )
```

For physical coordinate systems (points or pixels) the origin is the bottom-left of the figure or axes.

Optionally, you can enable drawing of an arrow from the text to the annotated point by giving a dictionary of arrow properties in the optional keyword argument `arrowprops`.

arrowprops key	description
<code>width</code>	the width of the arrow in points
<code>frac</code>	the fraction of the arrow length occupied by the head
<code>headwidth</code>	the width of the base of the arrow head in points
<code>shrink</code>	move the tip and base some percent away from the annotated point and text
<code>**kwargs</code>	any key for <code>matplotlib.patches.Polygon</code> , e.g., <code>facecolor</code>

In the example below, the `xy` point is in native coordinates (`xycoords` defaults to 'data'). For a polar axes, this is in (theta, radius) space. The text in this example is placed in the fractional figure coordinate system. `matplotlib.text.Text` keyword args like `horizontalalignment`, `verticalalignment` and `fontsize` are passed from `annotate` to the `Text` instance.

```
import numpy as np
import matplotlib.pyplot as plt

fig = plt.figure()
ax = fig.add_subplot(111, polar=True)
r = np.arange(0,1,0.001)
theta = 2*2*np.pi*r
line, = ax.plot(theta, r, color='#ee8d18', lw=3)

ind = 800
thisr, thistheta = r[ind], theta[ind]
ax.plot([thistheta], [thisr], 'o')
ax.annotate('a polar annotation',
            xy=(thistheta, thisr), # theta, radius
            xytext=(0.05, 0.05), # fraction, fraction
            textcoords='figure fraction',
            arrowprops=dict(facecolor='black', shrink=0.05),
            horizontalalignment='left',
            verticalalignment='bottom',
            )
plt.show()
```

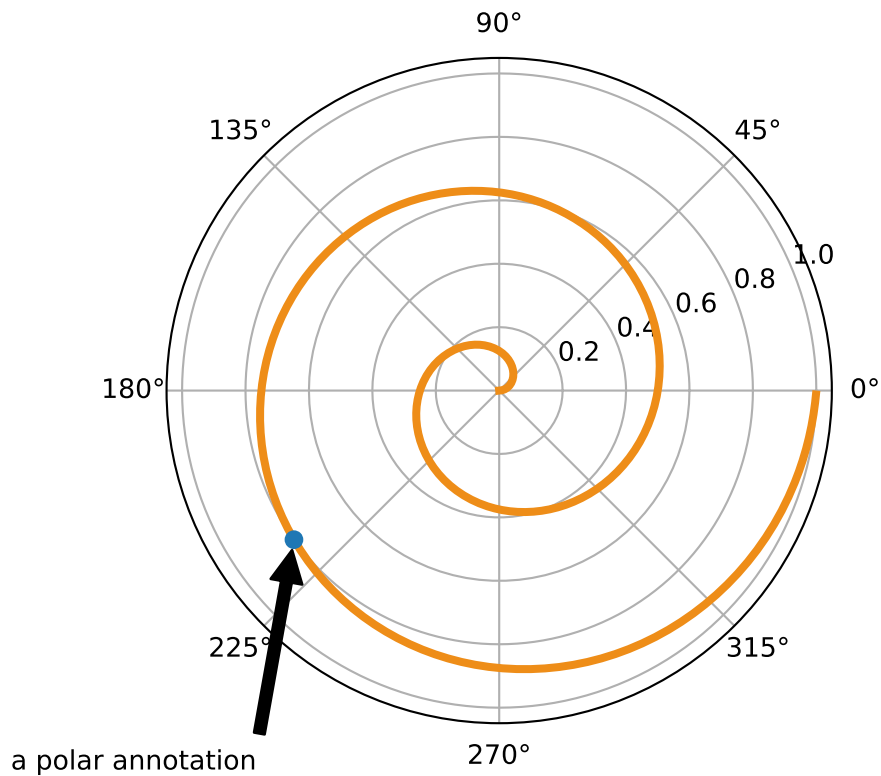
For more on all the wild and wonderful things you can do with annotations, including fancy arrows, see *Advanced Annotation* and *pylab_examples example code: annotation_demo.py*.

Do not proceed unless you have already read *Basic annotation*, `text()` and `annotate()`!

4.5.2 Advanced Annotation

Annotating with Text with Box

Let's start with a simple example.

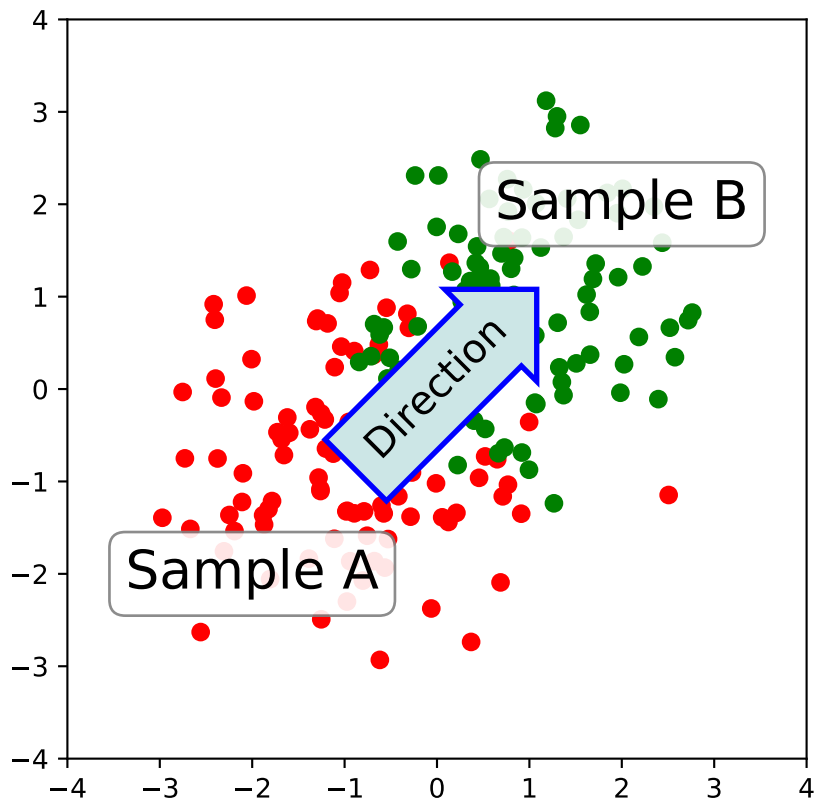

The `text()` function in the `pyplot` module (or `text` method of the `Axes` class) takes `bbox` keyword argument, and when given, a box around the text is drawn.

```

bbox_props = dict(boxstyle="rarrow,pad=0.3", fc="cyan", ec="b", lw=2)
t = ax.text(0, 0, "Direction", ha="center", va="center", rotation=45,
           size=15,
           bbox=bbox_props)

```

The patch object associated with the text can be accessed by:

```
bb = t.get_bbox_patch()
```

The return value is an instance of `FancyBboxPatch` and the patch properties like `facecolor`, `edgewidth`, etc. can be accessed and modified as usual. To change the shape of the box, use the `set_boxstyle` method.

```
bb.set_boxstyle("rarrow", pad=0.6)
```

The arguments are the name of the box style with its attributes as keyword arguments. Currently, following box styles are implemented.

Class	Name	Attrs
Circle	circle	pad=0.3
DArrow	darrow	pad=0.3
LArrow	larrow	pad=0.3
RArrow	rarrow	pad=0.3
Round	round	pad=0.3,rounding_size=None
Round4	round4	pad=0.3,rounding_size=None
Roundtooth	roundtooth	pad=0.3,tooth_size=None
Sawtooth	sawtooth	pad=0.3,tooth_size=None
Square	square	pad=0.3

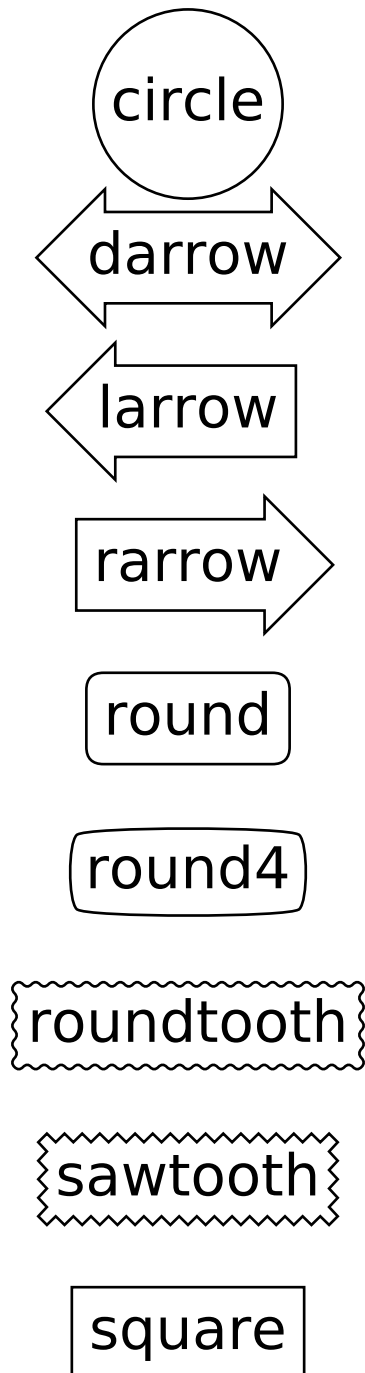

Note that the attribute arguments can be specified within the style name with separating comma (this form can be used as “boxstyle” value of bbox argument when initializing the text instance)

```
bb.set_boxstyle("rarrow,pad=0.6")
```

Annotating with Arrow

The `annotate()` function in the pyplot module (or `annotate` method of the Axes class) is used to draw an arrow connecting two points on the plot.

```
ax.annotate("Annotation",
            xy=(x1, y1), xycoords='data',
            xytext=(x2, y2), textcoords='offset points',
            )
```

This annotates a point at `xy` in the given coordinate (`xycoords`) with the text at `xytext` given in `textcoords`. Often, the annotated point is specified in the *data* coordinate and the annotating text in *offset points*. See `annotate()` for available coordinate systems.

An arrow connecting two points (`xy` & `xytext`) can be optionally drawn by specifying the `arrowprops` argument. To draw only an arrow, use empty string as the first argument.

```
ax.annotate("",
            xy=(0.2, 0.2), xycoords='data',
            xytext=(0.8, 0.8), textcoords='data',
            arrowprops=dict(arrowstyle="->",
                            connectionstyle="arc3"),
            )
```

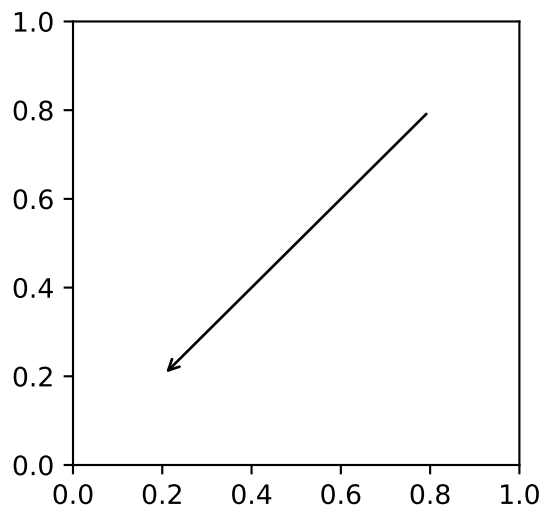

The arrow drawing takes a few steps.

1. a connecting path between two points are created. This is controlled by `connectionstyle` key value.
2. If patch object is given (`patchA` & `patchB`), the path is clipped to avoid the patch.
3. The path is further shrunk by given amount of pixels (`shrinkA` & `shrinkB`)
4. The path is transmuted to arrow patch, which is controlled by the `arrowstyle` key value.

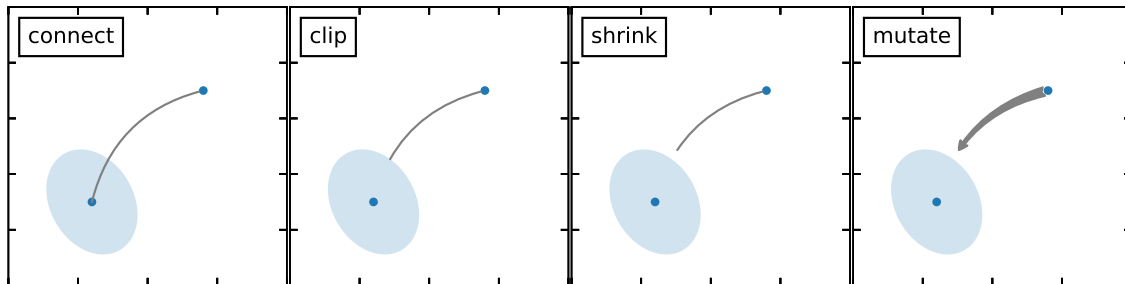

The creation of the connecting path between two points is controlled by `connectionstyle` key and the following styles are available.

Name	Attrs
<code>angle</code>	<code>angleA=90,angleB=0,rad=0.0</code>
<code>angle3</code>	<code>angleA=90,angleB=0</code>
<code>arc</code>	<code>angleA=0,angleB=0,armA=None,armB=None,rad=0.0</code>
<code>arc3</code>	<code>rad=0.0</code>
<code>bar</code>	<code>armA=0.0,armB=0.0,fraction=0.3,angle=None</code>

Note that “3” in `angle3` and `arc3` is meant to indicate that the resulting path is a quadratic spline segment (three control points). As will be discussed below, some arrow style options can only be used when the connecting path is a quadratic spline.

The behavior of each connection style is (limitedly) demonstrated in the example below. (Warning : The behavior of the `bar` style is currently not well defined, it may be changed in the future).

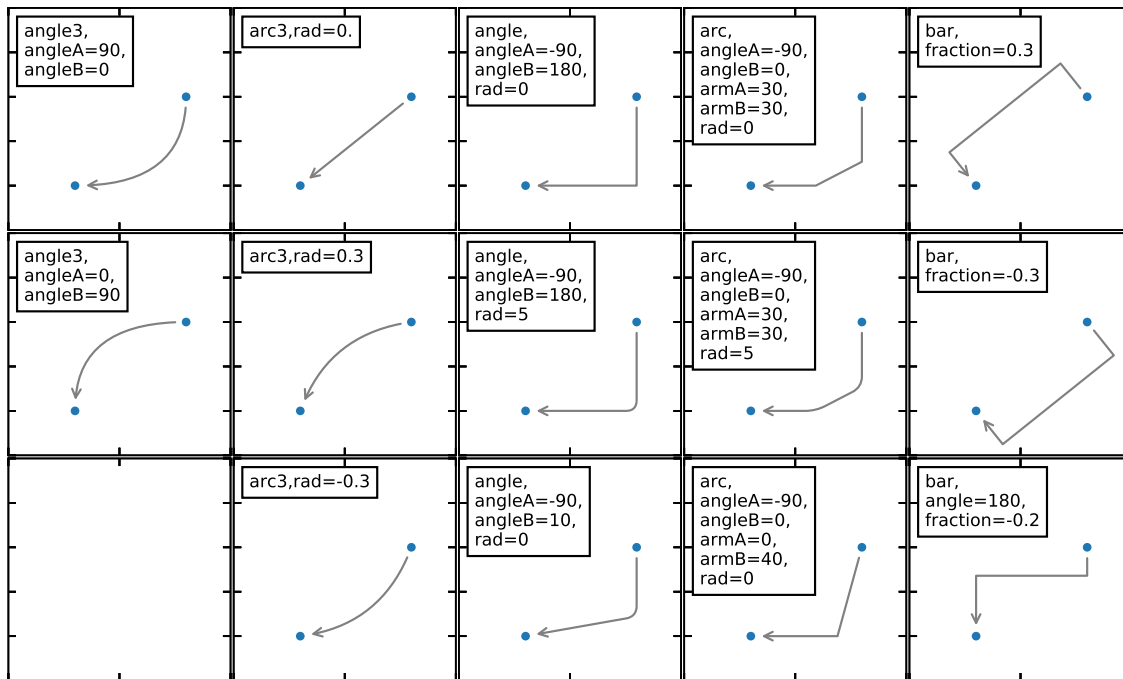

The connecting path (after clipping and shrinking) is then mutated to an arrow patch, according to the given `arrowstyle`.

Name	Attrs
-	None
->	head_length=0.4,head_width=0.2
-[widthB=1.0,lengthB=0.2,angleB=None
-	widthA=1.0,widthB=1.0
- >	head_length=0.4,head_width=0.2
<-	head_length=0.4,head_width=0.2
<->	head_length=0.4,head_width=0.2
< -	head_length=0.4,head_width=0.2
< - >	head_length=0.4,head_width=0.2
fancy	head_length=0.4,head_width=0.4,tail_width=0.4
simple	head_length=0.5,head_width=0.5,tail_width=0.2
wedge	tail_width=0.3,shrink_factor=0.5

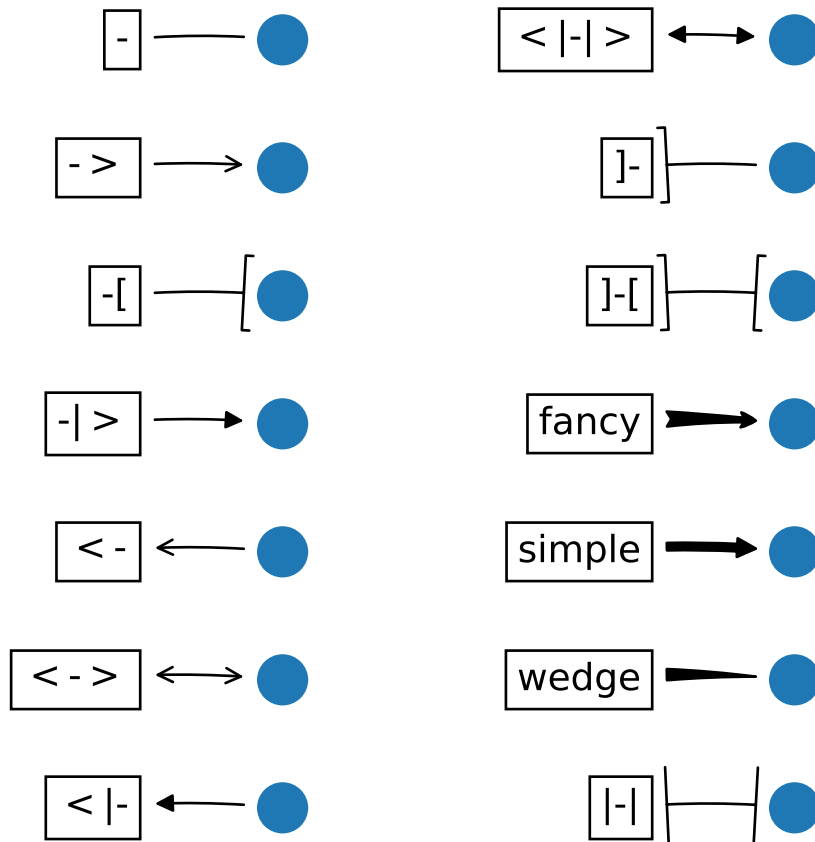

Some arrowstyles only work with connection styles that generate a quadratic-spline segment. They are `fancy`, `simple`, and `wedge`. For these arrow styles, you must use the “`angle3`” or “`arc3`” connection style.

If the annotation string is given, the `patchA` is set to the `bbox` patch of the text by default.

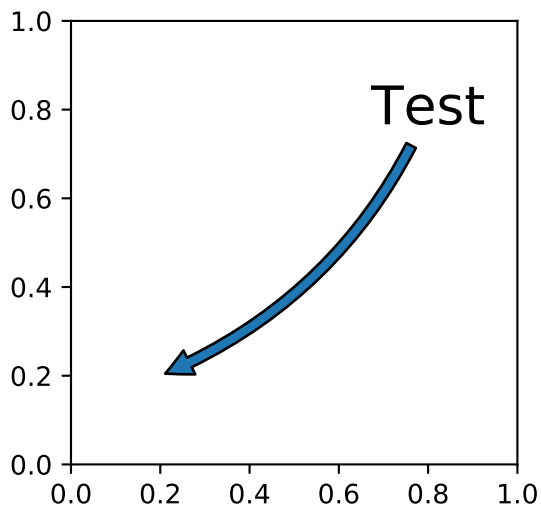

As in the text command, a box around the text can be drawn using the `bbox` argument.

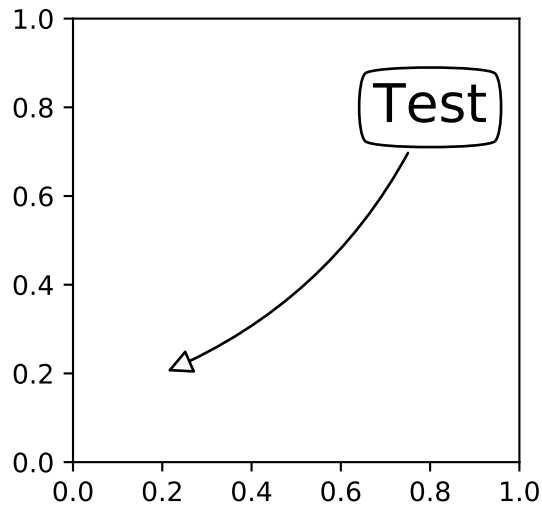

By default, the starting point is set to the center of the text extent. This can be adjusted with `relpos` key value. The values are normalized to the extent of the text. For example, (0,0) means lower-left corner and (1,1) means top-right.

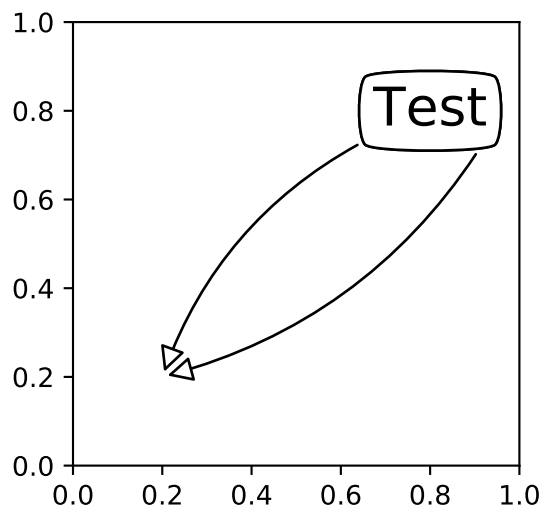

Placing Artist at the anchored location of the Axes

There are classes of artists that can be placed at an anchored location in the Axes. A common example is the legend. This type of artist can be created by using the `OffsetBox` class. A few predefined classes are available in `mpl_toolkits.axes_grid.anchored_artists`.

```
from mpl_toolkits.axes_grid.anchored_artists import AnchoredText
at = AnchoredText("Figure 1a",
```

```

        prop=dict(size=8), frameon=True,
        loc=2,
    )
at.patch.set_boxstyle("round,pad=0.,rounding_size=0.2")
ax.add_artist(at)

```

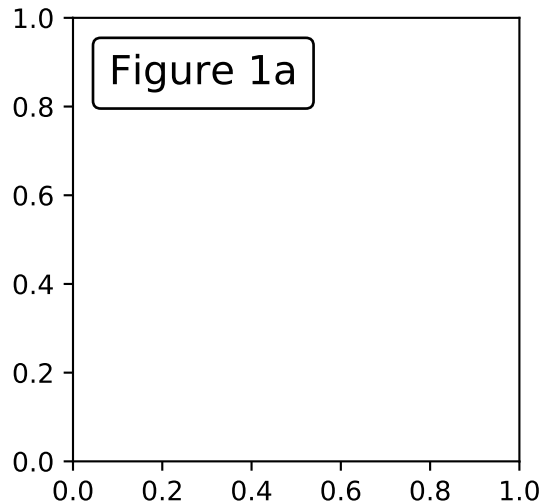

The *loc* keyword has same meaning as in the legend command.

A simple application is when the size of the artist (or collection of artists) is known in pixel size during the time of creation. For example, If you want to draw a circle with fixed size of 20 pixel x 20 pixel (radius = 10 pixel), you can utilize `AnchoredDrawingArea`. The instance is created with a size of the drawing area (in pixels), and arbitrary artists can be added to the drawing area. Note that the extents of the artists that are added to the drawing area are not related to the placement of the drawing area itself. Only the initial size matters.

```

from mpl_toolkits.axes_grid.anchored_artists import AnchoredDrawingArea

ada = AnchoredDrawingArea(20, 20, 0, 0,
                          loc=1, pad=0., frameon=False)
p1 = Circle((10, 10), 10)
ada.drawing_area.add_artist(p1)
p2 = Circle((30, 10), 5, fc="r")
ada.drawing_area.add_artist(p2)

```

The artists that are added to the drawing area should not have a transform set (it will be overridden) and the dimensions of those artists are interpreted as a pixel coordinate, i.e., the radius of the circles in above example are 10 pixels and 5 pixels, respectively.

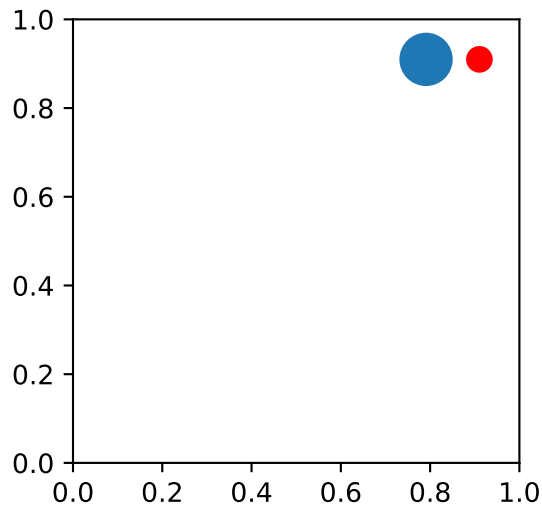

Sometimes, you want your artists to scale with the data coordinate (or coordinates other than canvas pixels). You can use `AnchoredAuxTransformBox` class. This is similar to `AnchoredDrawingArea` except that the extent of the artist is determined during the drawing time respecting the specified transform.

```
from mpl_toolkits.axes_grid.anchored_artists import AnchoredAuxTransformBox

box = AnchoredAuxTransformBox(ax.transData, loc=2)
el = Ellipse((0,0), width=0.1, height=0.4, angle=30) # in data coordinates!
box.drawing_area.add_artist(el)
```

The ellipse in the above example will have width and height corresponding to 0.1 and 0.4 in data coordinate and will be automatically scaled when the view limits of the axes change.

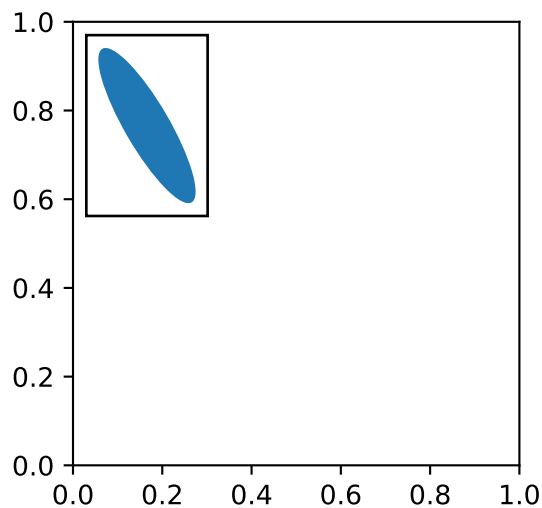

As in the legend, the `bbox_to_anchor` argument can be set. Using the `HParser` and `VParser`, you can have an arrangement(?) of artist as in the legend (as a matter of fact, this is how the legend is created).

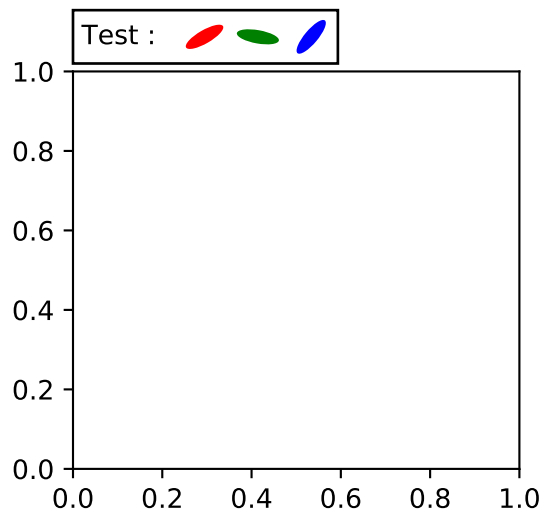

Note that unlike the legend, the `bbox_transform` is set to `IdentityTransform` by default.

Using Complex Coordinates with Annotations

The Annotation in matplotlib supports several types of coordinates as described in *Basic annotation*. For an advanced user who wants more control, it supports a few other options.

1. *Transform* instance. For example,

```
ax.annotate("Test", xy=(0.5, 0.5), xycoords=ax.transAxes)
```

is identical to

```
ax.annotate("Test", xy=(0.5, 0.5), xycoords="axes fraction")
```

With this, you can annotate a point in other axes.

```
ax1, ax2 = subplot(121), subplot(122)
ax2.annotate("Test", xy=(0.5, 0.5), xycoords=ax1.transData,
             xytext=(0.5, 0.5), textcoords=ax2.transData,
             arrowprops=dict(arrowstyle="->"))
```

2. *Artist* instance. The `xy` value (or `xytext`) is interpreted as a fractional coordinate of the `bbox` (return value of `get_window_extent`) of the artist.

```
an1 = ax.annotate("Test 1", xy=(0.5, 0.5), xycoords="data",
                 va="center", ha="center",
                 bbox=dict(boxstyle="round", fc="w"))
an2 = ax.annotate("Test 2", xy=(1, 0.5), xycoords=an1, # (1,0.5) of the an1's bbox
                 xytext=(30,0), textcoords="offset points",
                 va="center", ha="left",
                 bbox=dict(boxstyle="round", fc="w"),
                 arrowprops=dict(arrowstyle="->"))
```

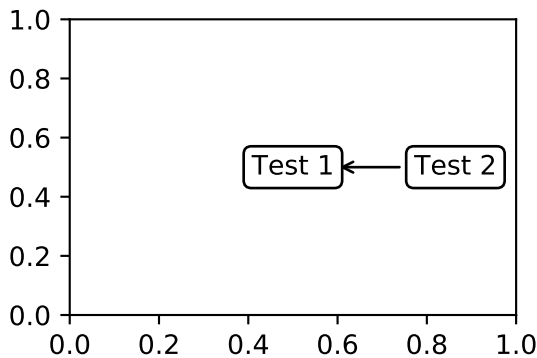

Note that it is your responsibility that the extent of the coordinate artist (*an1* in above example) is determined before *an2* gets drawn. In most cases, it means that *an2* needs to be drawn later than *an1*.

3. A callable object that returns an instance of either *BboxBase* or *Transform*. If a transform is returned, it is the same as 1 and if a *bbox* is returned, it is the same as 2. The callable object should take a single argument of the renderer instance. For example, the following two commands give identical results

```
an2 = ax.annotate("Test 2", xy=(1, 0.5), xycoords=an1,
                 xytext=(30,0), textcoords="offset points")
an2 = ax.annotate("Test 2", xy=(1, 0.5), xycoords=an1.get_window_extent(),
                 xytext=(30,0), textcoords="offset points")
```

4. A tuple of two coordinate specifications. The first item is for the x-coordinate and the second is for the y-coordinate. For example,

```
annotate("Test", xy=(0.5, 1), xycoords=("data", "axes fraction"))
```

0.5 is in data coordinates, and 1 is in normalized axes coordinates. You may use an artist or transform as with a tuple. For example,

```
import matplotlib.pyplot as plt

plt.figure(figsize=(3,2))
ax=plt.axes([0.1, 0.1, 0.8, 0.7])
an1 = ax.annotate("Test 1", xy=(0.5, 0.5), xycoords="data",
                 va="center", ha="center",
                 bbox=dict(boxstyle="round", fc="w"))

an2 = ax.annotate("Test 2", xy=(0.5, 1.), xycoords=an1,
                 xytext=(0.5,1.1), textcoords=(an1, "axes fraction"),
                 va="bottom", ha="center",
                 bbox=dict(boxstyle="round", fc="w"),
                 arrowprops=dict(arrowstyle="->"))

plt.show()
```

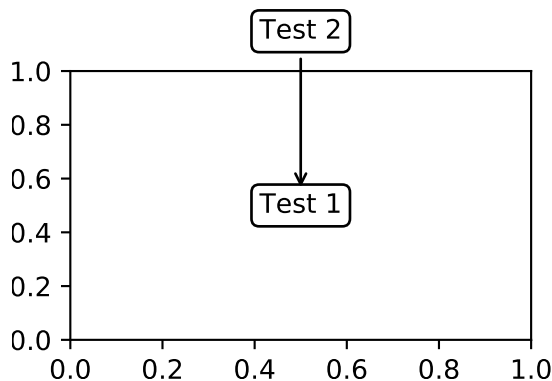

5. Sometimes, you want your annotation with some “offset points”, not from the annotated point but from some other point. `OffsetFrom` is a helper class for such cases.

```
import matplotlib.pyplot as plt

plt.figure(figsize=(3,2))
ax=plt.axes([0.1, 0.1, 0.8, 0.7])
an1 = ax.annotate("Test 1", xy=(0.5, 0.5), xycoords="data",
                  va="center", ha="center",
                  bbox=dict(boxstyle="round", fc="w"))

from matplotlib.text import OffsetFrom
offset_from = OffsetFrom(an1, (0.5, 0))
an2 = ax.annotate("Test 2", xy=(0.1, 0.1), xycoords="data",
                  xytext=(0, -10), textcoords=offset_from,
                  # xytext is offset points from "xy=(0.5, 0), xycoords=an1"
                  va="top", ha="center",
                  bbox=dict(boxstyle="round", fc="w"),
                  arrowprops=dict(arrowstyle="->"))

plt.show()
```

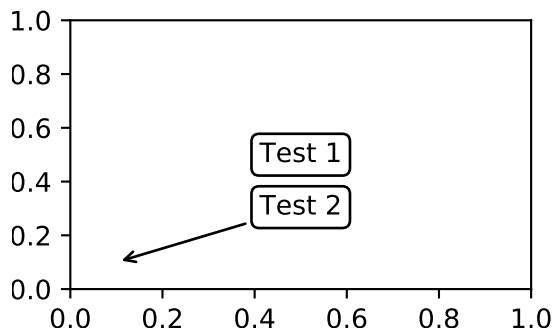

You may take a look at this example [pylab_examples example code: annotation_demo3.py](#).

Using ConnectorPatch

The `ConnectorPatch` is like an annotation without text. While the `annotate` function is recommended in most situations, the `ConnectorPatch` is useful when you want to connect points in different axes.

```

from matplotlib.patches import ConnectionPatch
xy = (0.2, 0.2)
con = ConnectionPatch(xyA=xy, xyB=xy, coordsA="data", coordsB="data",
                    axesA=ax1, axesB=ax2)
ax2.add_artist(con)

```

The above code connects point `xy` in the data coordinates of `ax1` to point `xy` in the data coordinates of `ax2`. Here is a simple example.

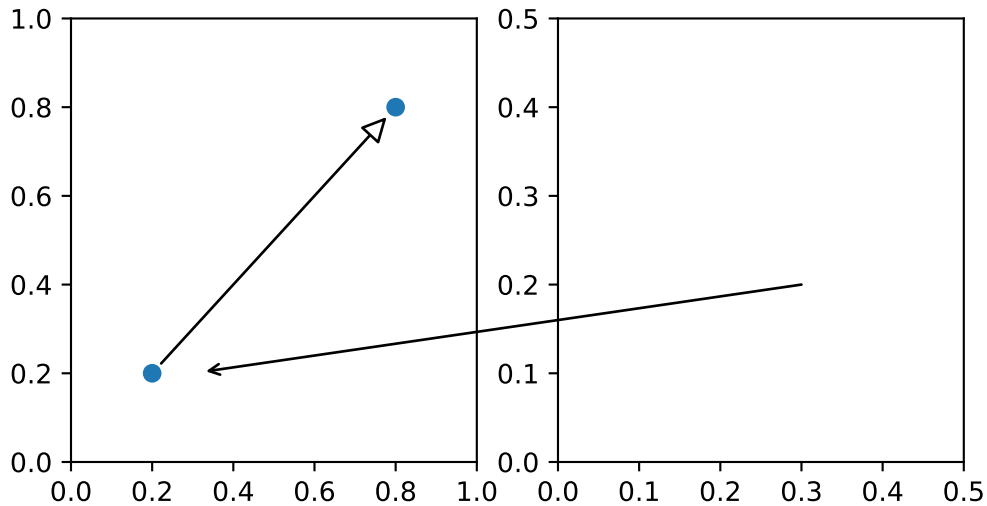

While the `ConnectionPatch` instance can be added to any axes, you may want to add it to the axes that is latest in drawing order to prevent overlap by other axes.

Advanced Topics

Zoom effect between Axes

`mpl_toolkits.axes_grid.inset_locator` defines some patch classes useful for interconnecting two axes. Understanding the code requires some knowledge of how `mpl`'s transform works. But, utilizing it will be straight forward.

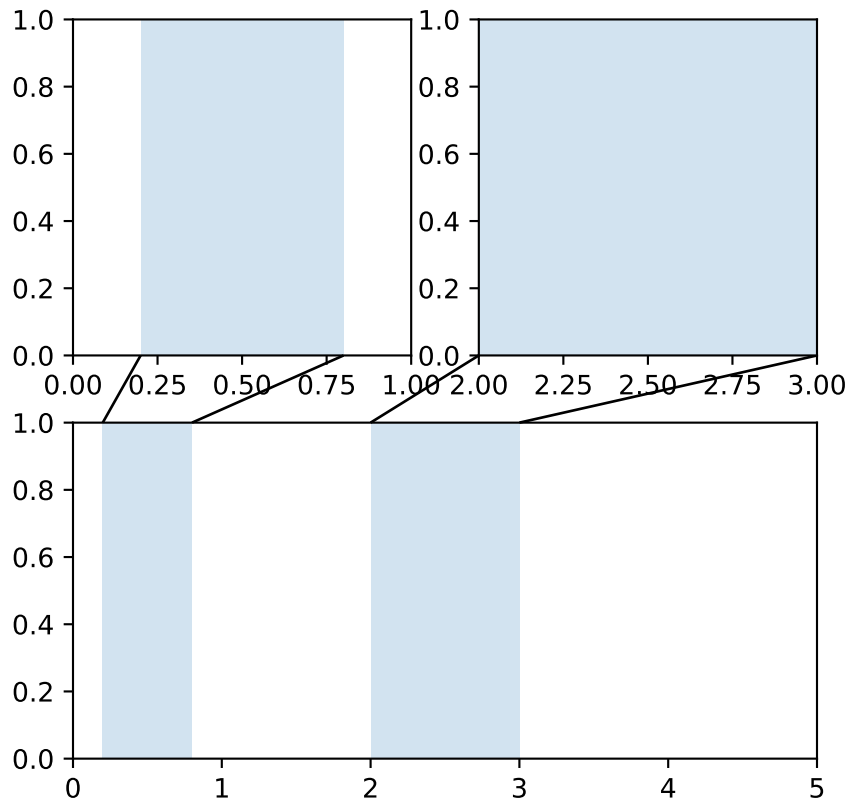

Define Custom BoxStyle

You can use a custom box style. The value for the `boxstyle` can be a callable object in the following forms.:

```
def __call__(self, x0, y0, width, height, mutation_size,
             aspect_ratio=1.):
    """
    Given the location and size of the box, return the path of
    the box around it.

    - *x0*, *y0*, *width*, *height* : location and size of the box
    - *mutation_size* : a reference scale for the mutation.
    - *aspect_ratio* : aspect-ratio for the mutation.
    """
    path = ...
    return path
```

Here is a complete example.

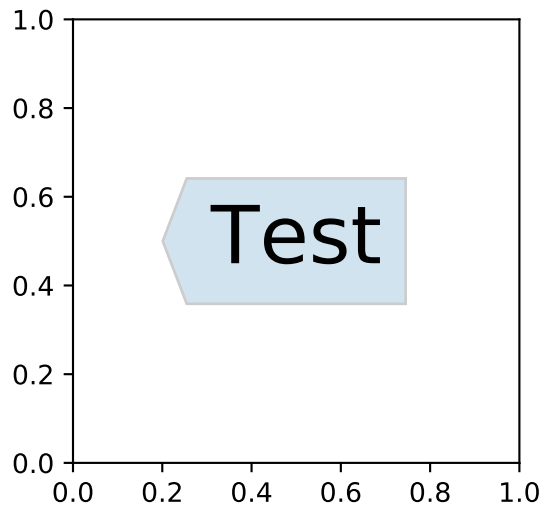

However, it is recommended that you derive from the `matplotlib.patches.BoxStyle._Base` as demonstrated below.

```

from matplotlib.path import Path
from matplotlib.patches import BoxStyle
import matplotlib.pyplot as plt

# we may derive from matplotlib.patches.BoxStyle._Base class.
# You need to override transmute method in this case.

class MyStyle(BoxStyle._Base):
    """
    A simple box.
    """

    def __init__(self, pad=0.3):
        """
        The arguments need to be floating numbers and need to have
        default values.

        *pad*
            amount of padding
        """

        self.pad = pad
        super(MyStyle, self).__init__()

    def transmute(self, x0, y0, width, height, mutation_size):
        """
        Given the location and size of the box, return the path of
        the box around it.

        - *x0*, *y0*, *width*, *height* : location and size of the box
        - *mutation_size* : a reference scale for the mutation.

```

```
Often, the mutation_size is the font size of the text.
You don't need to worry about the rotation as it is
automatically taken care of.
"""

# padding
pad = mutation_size * self.pad

# width and height with padding added.
width, height = width + 2.*pad, \
                height + 2.*pad,

# boundary of the padded box
x0, y0 = x0-pad, y0-pad,
x1, y1 = x0+width, y0 + height

cp = [(x0, y0),
      (x1, y0), (x1, y1), (x0, y1),
      (x0-pad, (y0+y1)/2.), (x0, y0),
      (x0, y0)]

com = [Path.MOVETO,
       Path.LINETO, Path.LINETO, Path.LINETO,
       Path.LINETO, Path.LINETO,
       Path.CLOSEPOLY]

path = Path(cp, com)

return path

# register the custom style
BoxStyle._style_list["angled"] = MyStyle

plt.figure(1, figsize=(3,3))
ax = plt.subplot(111)
ax.text(0.5, 0.5, "Test", size=30, va="center", ha="center", rotation=30,
        bbox=dict(boxstyle="angled,pad=0.5", alpha=0.2))

del BoxStyle._style_list["angled"]

plt.show()
```

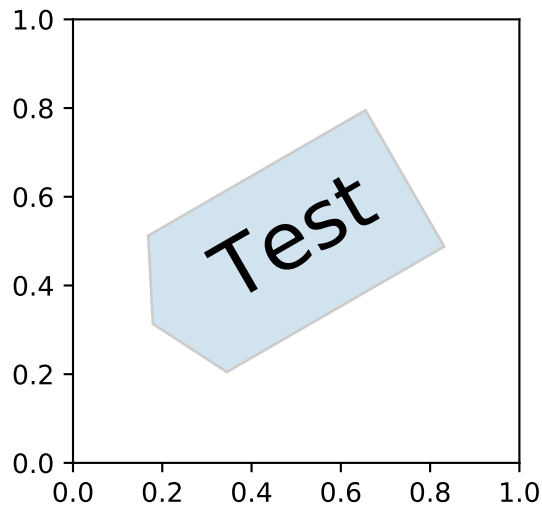

Similarly, you can define a custom `ConnectionStyle` and a custom `ArrowStyle`. See the source code of `lib/matplotlib/patches.py` and check how each style class is defined.

4.6 Writing mathematical expressions

You can use a subset TeX markup in any matplotlib text string by placing it inside a pair of dollar signs (\$).

Note that you do not need to have TeX installed, since matplotlib ships its own TeX expression parser, layout engine and fonts. The layout engine is a fairly direct adaptation of the layout algorithms in Donald Knuth's TeX, so the quality is quite good (matplotlib also provides a `usetex` option for those who do want to call out to TeX to generate their text (see *Text rendering With LaTeX*).

Any text element can use math text. You should use raw strings (precede the quotes with an 'r'), and surround the math text with dollar signs (\$), as in TeX. Regular text and `mathtext` can be interleaved within the same string. `Mathtext` can use DejaVu Sans (default), DejaVu Serif, the Computer Modern fonts (from (La)TeX), *STIX* fonts (with are designed to blend well with Times), or a Unicode font that you provide. The `mathtext` font can be selected with the customization variable `mathtext.fontset` (see *Customizing matplotlib*)

Note: On “*narrow*” builds of Python, if you use the *STIX* fonts you should also set `ps.fonttype` and `pdf.fonttype` to 3 (the default), not 42. Otherwise *some characters will not be visible*.

Here is a simple example:

```
# plain text
plt.title('alpha > beta')
```

produces “alpha > beta”.

Whereas this:

```
# math text
plt.title(r'$\alpha > \beta$')
```

produces “ $\alpha > \beta$ ”.

Note: Mathtext should be placed between a pair of dollar signs (\$). To make it easy to display monetary values, e.g., “\$100.00”, if a single dollar sign is present in the entire string, it will be displayed verbatim as a dollar sign. This is a small change from regular TeX, where the dollar sign in non-math text would have to be escaped (`\$`).

Note: While the syntax inside the pair of dollar signs (\$) aims to be TeX-like, the text outside does not. In particular, characters such as:

```
# $ % & ~ _ ^ \ { } \ ( \ ) \ [ \ ]
```

have special meaning outside of math mode in TeX. Therefore, these characters will behave differently depending on the rcParam `text.usetex` flag. See the *usetex tutorial* for more information.

4.6.1 Subscripts and superscripts

To make subscripts and superscripts, use the `'_'` and `'^'` symbols:

```
r'$\alpha_i > \beta_i$'
```

$$\alpha_i > \beta_i \tag{4.1}$$

Some symbols automatically put their sub/superscripts under and over the operator. For example, to write the sum of x_i from 0 to ∞ , you could do:

```
r'$\sum_{i=0}^{\infty} x_i$'
```

$$\sum_{i=0}^{\infty} x_i \tag{4.2}$$

4.6.2 Fractions, binomials and stacked numbers

Fractions, binomials and stacked numbers can be created with the `\frac{...}{...}`, `\binom{...}{...}` and `\stackrel{...}{...}` commands, respectively:

```
r'$\frac{3}{4} \binom{3}{4} \stackrel{3}{4}$'
```

produces

$$\frac{3}{4} \binom{3}{4} \stackrel{3}{4} \tag{4.3}$$

Fractions can be arbitrarily nested:

```
r'\frac{5 - \frac{1}{x}}{4}'
```

produces

$$\frac{5 - \frac{1}{x}}{4} \quad (4.4)$$

Note that special care needs to be taken to place parentheses and brackets around fractions. Doing things the obvious way produces brackets that are too small:

```
r'\(\frac{5 - \frac{1}{x}}{4})'
```

$$\left(\frac{5 - \frac{1}{x}}{4}\right) \quad (4.5)$$

The solution is to precede the bracket with `\left` and `\right` to inform the parser that those brackets encompass the entire object:

```
r'\left(\frac{5 - \frac{1}{x}}{4}\right)'
```

$$\left(\frac{5 - \frac{1}{x}}{4}\right) \quad (4.6)$$

4.6.3 Radicals

Radicals can be produced with the `\sqrt{[]}` command. For example:

```
r'\sqrt{2}'
```

$$\sqrt{2} \quad (4.7)$$

Any base can (optionally) be provided inside square brackets. Note that the base must be a simple expression, and can not contain layout commands such as fractions or sub/superscripts:

```
r'\sqrt[3]{x}'
```

$$\sqrt[3]{x} \quad (4.8)$$

4.6.4 Fonts

The default font is *italics* for mathematical symbols.

Note: This default can be changed using the `mathtext.default rcParam`. This is useful, for example, to use the same font as regular non-math text for math text, by setting it to `regular`.

To change fonts, e.g., to write “sin” in a Roman font, enclose the text in a font command:

```
r'$s(t) = \mathcal{A}\mathrm{sin}(2 \omega t)$'
```

$$s(t) = \mathcal{A}\sin(2\omega t) \quad (4.9)$$

More conveniently, many commonly used function names that are typeset in a Roman font have shortcuts. So the expression above could be written as follows:

```
r'$s(t) = \mathcal{A}\sin(2 \omega t)$'
```

$$s(t) = \mathcal{A}\sin(2\omega t) \quad (4.10)$$

Here “s” and “t” are variable in italics font (default), “sin” is in Roman font, and the amplitude “A” is in calligraphy font. Note in the example above the calligraphy A is squished into the sin. You can use a spacing command to add a little whitespace between them:

```
s(t) = \mathcal{A}\sin(2 \omega t)
```

$$s(t) = \mathcal{A}\sin(2\omega t) \quad (4.11)$$

The choices available with all fonts are:

Command	Result
<code>\mathrm{Roman}</code>	Roman
<code>\mathit{Italic}</code>	<i>Italic</i>
<code>\mathtt{Typewriter}</code>	Typewriter
<code>\mathcal{CALLIGRAPHY}</code>	<i>CALLIGRAPHY</i>

When using the STIX fonts, you also have the choice of:

Command	Result
<code>\mathbb{blackboard}</code>	\blackboard
<code>\mathrm{\mathbb{blackboard}}</code>	$\mathrm{\blackboard}$
<code>\mathfrak{Fraktur}</code>	$\mathfrak{Fraktur}$
<code>\mathsf{sansserif}</code>	$\mathsf{sansserif}$
<code>\mathrm{\mathsf{sansserif}}</code>	$\mathrm{\mathsf{sansserif}}$

There are also three global “font sets” to choose from, which are selected using the `mathtext.fontset` parameter in `matplotlibrc`.

cm: Computer Modern (TeX)

$$\mathcal{R} \prod_{i=\alpha_{i+1}}^{\infty} a_i \sin(2\pi f x_i)$$

stix: STIX (designed to blend well with Times)

$$\mathcal{R} \prod_{i=\alpha_{i+1}}^{\infty} a_i \sin(2\pi f x_i)$$

stixsans: STIX sans-serif

$$\mathcal{R} \prod_{i=\alpha_{j+1}}^{\infty} a_i \sin(2\pi f x_i)$$

Additionally, you can use `\mathdefault{...}` or its alias `\mathregular{...}` to use the font used for regular text outside of `mathtext`. There are a number of limitations to this approach, most notably that far fewer symbols will be available, but it can be useful to make math expressions blend well with other text in the plot.

Custom fonts

`mathtext` also provides a way to use custom fonts for math. This method is fairly tricky to use, and should be considered an experimental feature for patient users only. By setting the rcParam `mathtext.fontset` to `custom`, you can then set the following parameters, which control which font file to use for a particular set of math characters.

Parameter	Corresponds to
<code>mathtext.it</code>	<code>\mathit{}</code> or default italic
<code>mathtext.rm</code>	<code>\mathrm{}</code> Roman (upright)
<code>mathtext.tt</code>	<code>\mathtt{}</code> Typewriter (monospace)
<code>mathtext.bf</code>	<code>\mathbf{}</code> bold italic
<code>mathtext.cal</code>	<code>\mathcal{}</code> calligraphic
<code>mathtext.sf</code>	<code>\mathsf{}</code> sans-serif

Each parameter should be set to a fontconfig font descriptor (as defined in the yet-to-be-written font chapter).

The fonts used should have a Unicode mapping in order to find any non-Latin characters, such as Greek. If you want to use a math symbol that is not contained in your custom fonts, you can set the rcParam `mathtext.fallback_to_cm` to `True` which will cause the `mathtext` system to use characters from the default Computer Modern fonts whenever a particular character can not be found in the custom font.

Note that the math glyphs specified in Unicode have evolved over time, and many fonts may not have glyphs in the correct place for `mathtext`.

4.6.5 Accents

An accent command may precede any symbol to add an accent above it. There are long and short forms for some of them.

Command	Result
<code>\acute a</code> or <code>\'a</code>	á
<code>\bar a</code>	ā
<code>\breve a</code>	ă
<code>\ddot a</code> or <code>\"a</code>	ä
<code>\dot a</code> or <code>\.a</code>	à
<code>\grave a</code> or <code>\`a</code>	à
<code>\hat a</code> or <code>\^a</code>	â
<code>\tilde a</code> or <code>\~a</code>	ã
<code>\vec a</code>	→
<code>\overline{abc}</code>	abc

In addition, there are two special accents that automatically adjust to the width of the symbols below:

Command	Result
<code>\widehat{xyz}</code>	xyz
<code>\widetilde{xyz}</code>	xyz

Care should be taken when putting accents on lower-case i's and j's. Note that in the following `\imath` is used to avoid the extra dot over the i:

```
r"$\hat i \ \hat \imath$"
```

$$\hat{i} \ \hat{\imath} \tag{4.12}$$

4.6.6 Symbols

You can also use a large number of the TeX symbols, as in `\infty`, `\leftarrow`, `\sum`, `\int`.

Lower-case Greek

<code>\alpha</code>	<code>\beta</code>	<code>\chi</code>	<code>\delta</code>	<code>F</code> <code>\digamma</code>
<code>\epsilon</code>	<code>\eta</code>	<code>\gamma</code>	<code>\iota</code>	<code>\kappa</code>
<code>\lambda</code>	<code>\mu</code>	<code>\nu</code>	<code>\omega</code>	<code>\phi</code>
<code>\pi</code>	<code>\psi</code>	<code>\rho</code>	<code>\sigma</code>	<code>\tau</code>
<code>\theta</code>	<code>\upsilon</code>	<code>\varepsilon</code>	<code>\varkappa</code>	<code>\varphi</code>
<code>\varpi</code>	<code>\varrho</code>	<code>\varsigma</code>	<code>\vartheta</code>	<code>\xi</code>
<code>\zeta</code>				

Upper-case Greek

<code>\Delta</code>	<code>\Gamma</code>	<code>\Lambda</code>	<code>\Omega</code>	<code>\Phi</code>	<code>\Pi</code>
<code>\Psi</code>	<code>\Sigma</code>	<code>\Theta</code>	<code>\Upsilon</code>	<code>\Xi</code>	<code>\Upsilon</code>
<code>\nabla</code>					

Hebrew

<code>\aleph</code>	<code>\beth</code>	<code>\daleth</code>	<code>\gimel</code>
---------------------	--------------------	----------------------	---------------------

Delimiters

//	[[↓ \Downarrow	↑ \Uparrow	 \Vert	\	\backslash
↓ \downarrow	< \langle	⌈ \lceil	⌋ \lfloor	⌞ \llcorner	⌞ \lrcorner	
> \rangle	⌋ \rceil	⌋ \rfloor	⌞ \ulcorner	↑ \uparrow	⌞ \urcorner	
 \vert	{\}		}}]]		

Big symbols

\bigcap \bigcap	\bigcup \bigcup	\bigodot \bigodot	\bigoplus \bigoplus	\bigotimes \bigotimes
\biguplus \biguplus	\bigvee \bigvee	\bigwedge \bigwedge	\coprod \coprod	\int \int
\oint \oint	\prod \prod	\sum \sum		

Standard function names

\Pr \Pr	\arccos \arccos	\arcsin \arcsin	\arctan \arctan
\arg \arg	\cos \cos	\cosh \cosh	\cot \cot
\coth \coth	\csc \csc	\deg \deg	\det \det
\dim \dim	\exp \exp	\gcd \gcd	\hom \hom
\inf \inf	\ker \ker	\lg \lg	\lim \lim
\liminf \liminf	\limsup \limsup	\ln \ln	\log \log
\max \max	\min \min	\sec \sec	\sin \sin
\sinh \sinh	\sup \sup	\tan \tan	\tanh \tanh

Binary operation and relation symbols

\bumpeq \Bumpeq	\cap \Cap	\cup \Cup
\doteq \Doteq	\bowtie \Join	\subseteq \Subset
\supseteq \Supset	\Vdash \Vdash	\Vvdash \Vvdash
\approx \approx	\cong \congeq	$*$ \ast
\asymp \asymp	\backsimeq \backepsilon	\sim \backsim
\backsimeq \backsimeq	$\bar{\wedge}$ \barwedge	\because \because
\between \between	\bigcirc \bigcirc	\bigtriangledown \bigtriangledown
\bigtriangleup \bigtriangleup	\blacktriangleleft \blacktriangleleft	\blacktriangleright \blacktriangleright
\bot \bot	\bowtie \bowtie	\boxdot \boxdot
\boxminus \boxminus	\boxplus \boxplus	\boxtimes \boxtimes
\bullet \bullet	\bumpeq \bumpeq	\cap \cap
\cdot \cdot	\circ \circ	\doteq \doteq
\coloneqq \coloneq	\cong \cong	\cup \cup
\curlyeqprec \curlyeqprec	\curlyeqsucc \curlyeqsucc	\curlyvee \curlyvee
\curlywedge \curlywedge	\dagger \dagger	\dashv \dashv
\ddagger \ddagger	\diamond \diamond	\div \div
\divideontimes \divideontimes	\doteq \doteq	\doteqdot \doteqdot
\dotplus \dotplus	$\bar{\bar{\wedge}}$ \doublebarwedge	\eqcirc \eqcirc
\eqcolon \eqcolon	\eqsim \eqsim	\eqslantgtr \eqslantgtr
\eqslantless \eqslantless	\equiv \equiv	\fallingdotseq \fallingdotseq

\frown	\geq	\geq
\geqslant	\gg	\ggg
\gtrapprox	\gtrneqq	\gtrsim
\gtrapprox	\gtrdot	\gtrreqless
\gtrreqless	\gtrless	\gtrsim
\in	\intercal	\leftthreetimes
\leq	\leqq	\leqslant
\lessapprox	\lessdot	\lesseqgtr
\lesseqgtr	\lessgtr	\lesssim
\ll	\lll	\lnapprox
\lneqq	\lnsim	\ltimes
\mid	\models	\mp
\nVDash	\nVdash	\napprox
\ncong	\ne	\neq
\neq	\nequiv	\ngeq
\ngtr	\ni	\nleq
\nless	\nmid	\notin
\nparallel	\nprec	\nsim
\nsubset	\nsubseteq	\nsucc
\nsupset	\nsupseteq	\ntriangleleft

\ntrianglelefteq	\ntriangleright	\ntrianglerighteq
\nvDash	\nvdash	\odot
\ominus	\oplus	\oslash
\otimes	\parallel	\perp
\pitchfork	\pm	\prec
\preccurlyeq	\preccurlyeq	\preceq
\precnapprox	\precnsim	\precsim
\propto	\rightthreetimes	\risingdotseq
\rtimes	\sim	\simeq
\slash	\smile	\sqcap
\sqcup	\sqsubset	\sqsubset
\sqsubseteq	\sqsupset	\sqsupset
\sqsupseteq	\star	\subset
\subseteq	\subseteq	\subseteq
\subsetneqq	\succ	\succapprox
\succcurlyeq	\succeq	\succnapprox
\succnsim	\succsim	\supset
\supseteq	\supseteq	\supseteq
\supsetneqq	\therefore	\times
\top	\triangleleft	\trianglelefteq

\triangleleft	\triangleright	\trianglerighteq
\uplus	\vDash	\varpropto
\vartriangleleft	\vartriangleright	\vDash
\vee	\veebar	\wedge
\wr		

Arrow symbols

\Downarrow <code>\Downarrow</code>	\Leftarrow <code>\Leftarrow</code>
\Leftrightarrow <code>\Leftrightarrow</code>	\Lleftarrow <code>\Lleftarrow</code>
\Longleftarrow <code>\Longleftarrow</code>	\Lrightrightarrow <code>\Lrightrightarrow</code>
\Longrightarrow <code>\Longrightarrow</code>	\Lsh <code>\Lsh</code>
\nearrow <code>\nearrow</code>	\Nwarrow <code>\Nwarrow</code>
\Rightarrow <code>\Rightarrow</code>	\Rrightarrow <code>\Rrightarrow</code>
\Rsh <code>\Rsh</code>	\searrow <code>\searrow</code>
\swarrow <code>\swarrow</code>	\Uparrow <code>\Uparrow</code>
\Updownarrow <code>\Updownarrow</code>	\circlearrowleft <code>\circlearrowleft</code>
\circlearrowright <code>\circlearrowright</code>	\curvearrowleft <code>\curvearrowleft</code>
\curvearrowright <code>\curvearrowright</code>	\dashleftarrow <code>\dashleftarrow</code>
\dashrightarrow <code>\dashrightarrow</code>	\downarrow <code>\downarrow</code>
\downdownarrows <code>\downdownarrows</code>	\downharpoonleft <code>\downharpoonleft</code>
\downharpoonright <code>\downharpoonright</code>	\hookleftarrow <code>\hookleftarrow</code>
\hookrightarrow <code>\hookrightarrow</code>	\leadsto <code>\leadsto</code>
\leftarrow <code>\leftarrow</code>	\leftarrowtail <code>\leftarrowtail</code>
\leftharpoondown <code>\leftharpoondown</code>	\leftharpoonup <code>\leftharpoonup</code>
\leftleftarrows <code>\leftleftarrows</code>	\leftrightarrows <code>\leftrightarrows</code>
\leftrightarrows <code>\leftrightarrows</code>	\leftrightharpoons <code>\leftrightharpoons</code>
\leftrightsquigarrow <code>\leftrightsquigarrow</code>	\leftsquigarrow <code>\leftsquigarrow</code>

\longleftarrow <code>\longleftarrow</code>	\longleftrightarrow <code>\longleftrightarrow</code>
\longmapsto <code>\longmapsto</code>	\longrightarrow <code>\longrightarrow</code>
\looparrowleft <code>\looparrowleft</code>	\looparrowright <code>\looparrowright</code>
\mapsto <code>\mapsto</code>	\multimap <code>\multimap</code>
\nLeftarrow <code>\nLeftarrow</code>	\nLeftrightarrow <code>\nLeftrightarrow</code>
\nrightarrow <code>\nrightarrow</code>	\nearrow <code>\nearrow</code>
\nleftarrow <code>\nleftarrow</code>	\nletrightarrow <code>\nletrightarrow</code>
\nrightarrow <code>\nrightarrow</code>	\nwarrow <code>\nwarrow</code>
\rightarrow <code>\rightarrow</code>	\rightarrowtail <code>\rightarrowtail</code>
\rightharpoondown <code>\rightharpoondown</code>	\rightharpoonup <code>\rightharpoonup</code>
\rightleftarrows <code>\rightleftarrows</code>	\rightleftarrows <code>\rightleftarrows</code>
\rightleftharpoons <code>\rightleftharpoons</code>	\rightleftharpoons <code>\rightleftharpoons</code>
\rightrightarrows <code>\rightrightarrows</code>	\rightrightarrows <code>\rightrightarrows</code>
\rightsquigarrow <code>\rightsquigarrow</code>	\searrow <code>\searrow</code>
\swarrow <code>\swarrow</code>	\to <code>\to</code>
\twoheadleftarrow <code>\twoheadleftarrow</code>	\twoheadrightarrow <code>\twoheadrightarrow</code>
\uparrow <code>\uparrow</code>	\updownarrow <code>\updownarrow</code>
\updownarrow <code>\updownarrow</code>	\upharpoonleft <code>\upharpoonleft</code>
\upharpoonright <code>\upharpoonright</code>	\upuparrows <code>\upuparrows</code>



Miscellaneous symbols

$\$$ \ \$	\AA \ AA	\Finv
\Game	\Im	\P
\Re	\S	\angle
\backprime	\bigstar	\blacksquare
\blacktriangle	$\text{\blacktriangledown}$	\cdots
\checkmark	\circledR	\circledS
\clubsuit	\complement	\copyright
\ddots	\diamondsuit	ℓ \ ell
\emptyset	\eth	\exists \ exists
\flat	\forall \ forall	\hbar \ hbar
\heartsuit	\hslash	\iiint \ iiint
\iint \ iint	\iint \ iint	\imath \ imath
\infty \ infty	\jmath \ jmath	\ldots \ ldots
\measuredangle	\natural	\neg \ neg
\nexists	\oiiint	\partial \ partial
\prime \ prime	\sharp \ sharp	\spadesuit
\sphericalangle	\ss	\triangledown
\varnothing \ varnothing	\vartriangle \ vartriangle	\vdots \ vdots
\wp	\yen	

If a particular symbol does not have a name (as is true of many of the more obscure symbols in the STIX fonts), Unicode characters can also be used:

```
ur'$\u23ce$'
```

4.6.7 Example

Here is an example illustrating many of these features in context.

```
import numpy as np
import matplotlib.pyplot as plt
t = np.arange(0.0, 2.0, 0.01)
s = np.sin(2*np.pi*t)

plt.plot(t,s)
plt.title(r'$\alpha_i > \beta_i$', fontsize=20)
plt.text(1, -0.6, r'$\sum_{i=0}^{\infty} x_i$', fontsize=20)
plt.text(0.6, 0.6, r'$\mathcal{A}\mathrm{sin}(2 \omega t)$',
        fontsize=20)
plt.xlabel('time (s)')
plt.ylabel('volts (mV)')
plt.show()
```

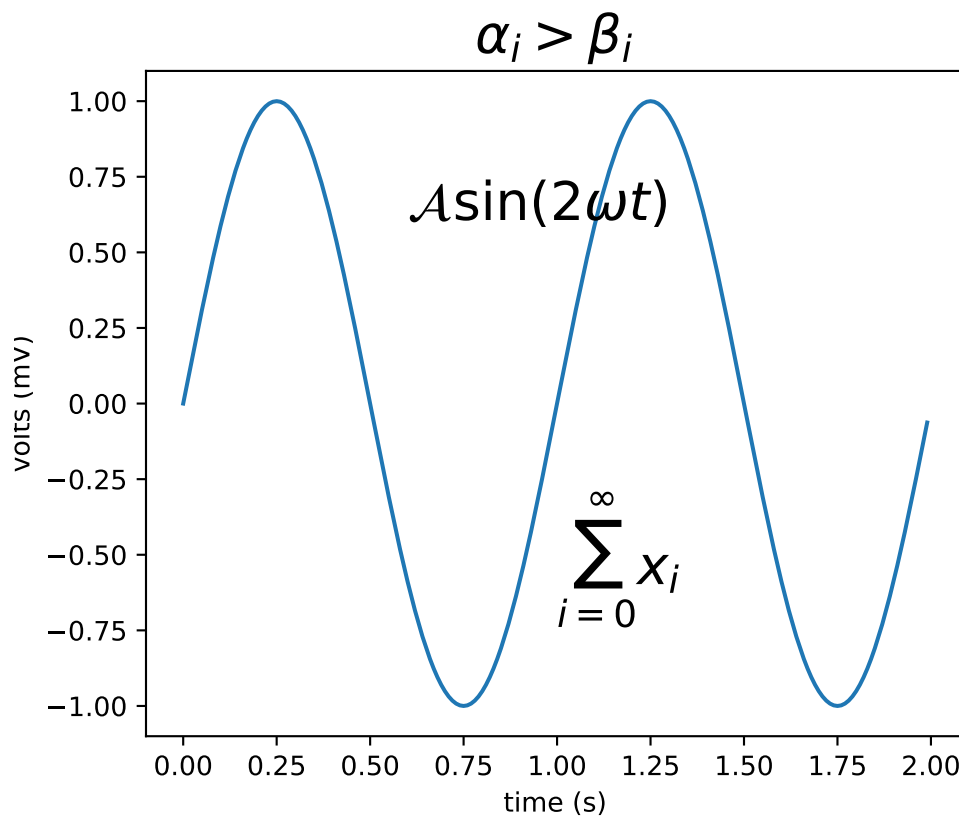

4.7 Text rendering With LaTeX

Matplotlib has the option to use LaTeX to manage all text layout. This option is available with the following backends:

- Agg
- PS
- PDF

The LaTeX option is activated by setting `text.usetex` : `True` in your rc settings. Text handling with matplotlib's LaTeX support is slower than matplotlib's very capable *mathtext*, but is more flexible, since different LaTeX packages (font packages, math packages, etc.) can be used. The results can be striking, especially when you take care to use the same fonts in your figures as in the main document.

Matplotlib's LaTeX support requires a working LaTeX installation, `dvipng` (which may be included with your LaTeX installation), and `Ghostscript` (GPL Ghostscript 8.60 or later is recommended). The executables for these external dependencies must all be located on your *PATH*.

There are a couple of options to mention, which can be changed using *rc settings*. Here is an example matplotlibrc file:

```
font.family      : serif
font.serif       : Times, Palatino, New Century Schoolbook, Bookman, Computer Modern,
↳Roman
font.sans-serif  : Helvetica, Avant Garde, Computer Modern Sans serif
font.cursive     : Zapf Chancery
font.monospace   : Courier, Computer Modern Typewriter

text.usetex      : true
```

The first valid font in each family is the one that will be loaded. If the fonts are not specified, the Computer Modern fonts are used by default. All of the other fonts are Adobe fonts. Times and Palatino each have their own accompanying math fonts, while the other Adobe serif fonts make use of the Computer Modern math fonts. See the [PSNFSS](#) documentation for more details.

To use LaTeX and select Helvetica as the default font, without editing matplotlibrc use:

```
from matplotlib import rc
rc('font', **{'family':'sans-serif','sans-serif':['Helvetica']})
## for Palatino and other serif fonts use:
rc('font', **{'family':'serif','serif':['Palatino']})
rc('text', usetex=True)
```

Here is the standard example, `tex_demo.py`:

```
"""
Demo of TeX rendering.

You can use TeX to render all of your matplotlib text if the rc
parameter text.usetex is set. This works currently on the agg and ps
backends, and requires that you have tex and the other dependencies
described at http://matplotlib.org/users/usetex.html
properly installed on your system. The first time you run a script
you will see a lot of output from tex and associated tools. The next
time, the run may be silent, as a lot of the information is cached in
~/.tex.cache

"""
import numpy as np
import matplotlib.pyplot as plt

# Example data
t = np.arange(0.0, 1.0 + 0.01, 0.01)
s = np.cos(4 * np.pi * t) + 2

plt.rc('text', usetex=True)
plt.rc('font', family='serif')
plt.plot(t, s)

plt.xlabel(r'\textbf{time} (s)')
plt.ylabel(r'\textit{voltage} (mV)', fontsize=16)
plt.title(r"\TeX\ is Number "
          r"$\displaystyle\sum_{n=1}^{\infty}\frac{-e^{i\pi}}{2^n}$!",
```

```

    fontsize=16, color='gray')
# Make room for the ridiculously large title.
plt.subplots_adjust(top=0.8)

plt.savefig('tex_demo')
plt.show()

```

$$\text{\TeX is Number } \sum_{n=1}^{\infty} \frac{-e^{i\pi}}{2^n}!$$

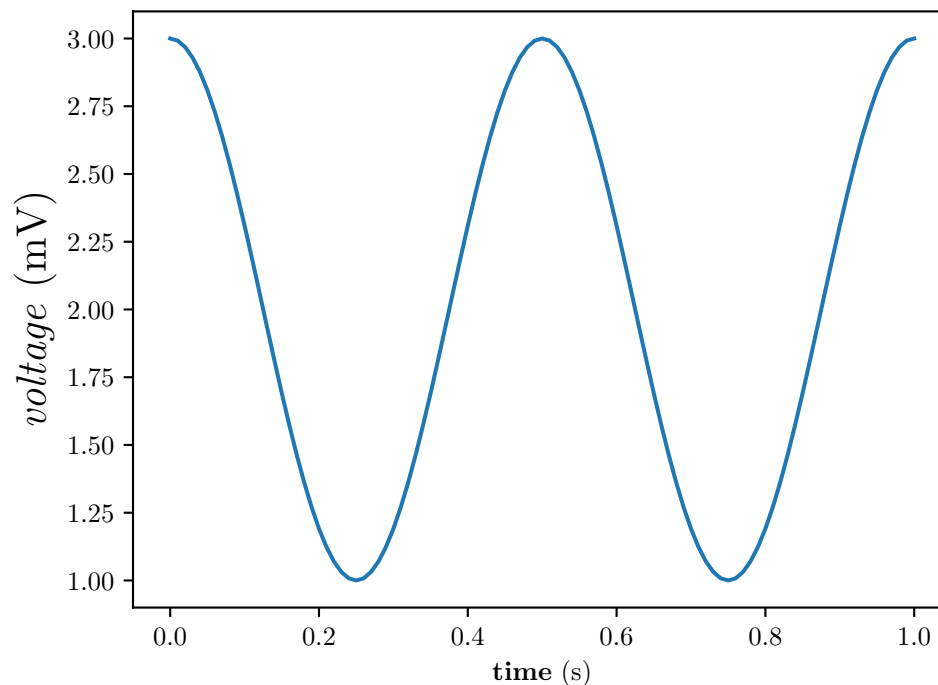

Note that display math mode ($e=mc^2$) is not supported, but adding the command `\displaystyle`, as in `tex_demo.py`, will produce the same results.

Note: Certain characters require special escaping in TeX, such as:

```
# $ % & ~ _ ^ \ { } \ ( \ ) \ [ \ ]
```

Therefore, these characters will behave differently depending on the rcParam `text.usetex` flag.

4.7.1 usetex with unicode

It is also possible to use unicode strings with the LaTeX text manager, here is an example taken from `tex_unicode_demo.py`:

```

# -*- coding: utf-8 -*-
"""
This demo is tex_demo.py modified to have unicode. See that file for
more information.
"""

from __future__ import unicode_literals
import numpy as np
import matplotlib
matplotlib.rcParams['text.usetex'] = True
matplotlib.rcParams['text.latex.unicode'] = True
import matplotlib.pyplot as plt

plt.figure(1, figsize=(6, 4))
ax = plt.axes([0.1, 0.1, 0.8, 0.7])
t = np.arange(0.0, 1.0 + 0.01, 0.01)
s = np.cos(2*2*np.pi*t) + 2
plt.plot(t, s)

plt.xlabel(r'\textbf{time (s)}')
plt.ylabel(r'\textit{Velocity (\u00B0/sec)}', fontsize=16)
plt.title(r'TeX is Number  $\sum_{n=1}^{\infty} \frac{-e^{i\pi}}{2^n}!$ ',
          r'\frac{-e^{i\pi}}{2^n}!', fontsize=16, color='r')
plt.grid(True)
plt.show()

```

$$\text{TeX is Number } \sum_{n=1}^{\infty} \frac{-e^{i\pi}}{2^n}!$$

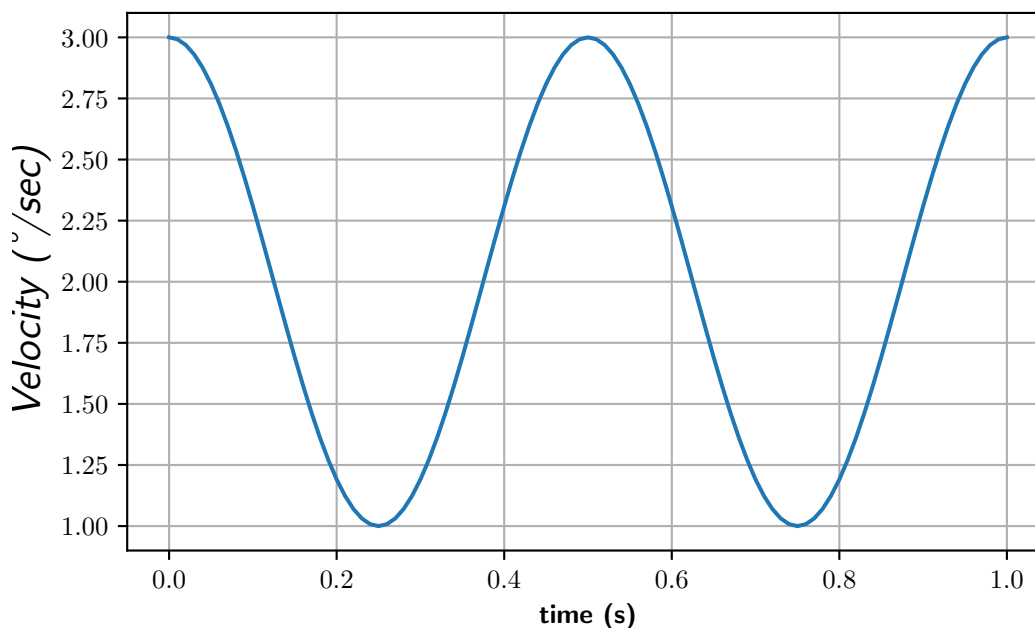

4.7.2 Postscript options

In order to produce encapsulated postscript files that can be embedded in a new LaTeX document, the default behavior of matplotlib is to distill the output, which removes some postscript operators used by LaTeX that are illegal in an eps file. This step produces results which may be unacceptable to some users, because the text is coarsely rasterized and converted to bitmaps, which are not scalable like standard postscript, and the text is not searchable. One workaround is to set `ps.distiller.res` to a higher value (perhaps 6000) in your rc settings, which will produce larger files but may look better and scale reasonably. A better workaround, which requires [Poppler](#) or [Xpdf](#), can be activated by changing the `ps.usedistiller` rc setting to `xpdf`. This alternative produces postscript without rasterizing text, so it scales properly, can be edited in Adobe Illustrator, and searched text in pdf documents.

4.7.3 Possible hangups

- On Windows, the `PATH` environment variable may need to be modified to include the directories containing the latex, dvipng and ghostscript executables. See [Environment Variables](#) and [Setting environment variables in windows](#) for details.
- Using MiKTeX with Computer Modern fonts, if you get odd *Agg and PNG results, go to MiKTeX/Options and update your format files
- The fonts look terrible on screen. You are probably running Mac OS, and there is some funny business with older versions of dvipng on the mac. Set `text.dvipnghack : True` in your matplotlibrc file.
- On Ubuntu and Gentoo, the base texlive install does not ship with the `type1cm` package. You may need to install some of the extra packages to get all the goodies that come bundled with other latex distributions.
- Some progress has been made so matplotlib uses the dvi files directly for text layout. This allows latex to be used for text layout with the pdf and svg backends, as well as the *Agg and PS backends. In the future, a latex installation may be the only external dependency.

4.7.4 Troubleshooting

- Try deleting your `.matplotlib/tex.cache` directory. If you don't know where to find `.matplotlib`, see [matplotlib configuration and cache directory locations](#).
- Make sure LaTeX, dvipng and ghostscript are each working and on your `PATH`.
- Make sure what you are trying to do is possible in a LaTeX document, that your LaTeX syntax is valid and that you are using raw strings if necessary to avoid unintended escape sequences.
- Most problems reported on the mailing list have been cleared up by upgrading [Ghostscript](#). If possible, please try upgrading to the latest release before reporting problems to the list.
- The `text.latex.preamble` rc setting is not officially supported. This option provides lots of flexibility, and lots of ways to cause problems. Please disable this option before reporting problems to the mailing list.
- If you still need help, please see [Getting help](#)

4.8 Typesetting With XeLaTeX/LuaLaTeX

Using the `pgf` backend, matplotlib can export figures as `pgf` drawing commands that can be processed with `pdflatex`, `xelatex` or `lualatex`. XeLaTeX and LuaLaTeX have full unicode support and can use any font that is installed in the operating system, making use of advanced typographic features of OpenType, AAT and Graphite. Pgf pictures created by `plt.savefig('figure.pgf')` can be embedded as raw commands in LaTeX documents. Figures can also be directly compiled and saved to PDF with `plt.savefig('figure.pdf')` by either switching to the backend

```
matplotlib.use('pgf')
```

or registering it for handling pdf output

```
from matplotlib.backends.backend_pgf import FigureCanvasPgf
matplotlib.backend_bases.register_backend('pdf', FigureCanvasPgf)
```

The second method allows you to keep using regular interactive backends and to save `xelatex`, `lualatex` or `pdflatex` compiled PDF files from the graphical user interface.

Matplotlib’s `pgf` support requires a recent LaTeX installation that includes the TikZ/PGF packages (such as [TeXLive](#)), preferably with XeLaTeX or LuaLaTeX installed. If either `pdftocairo` or `ghostscript` is present on your system, figures can optionally be saved to PNG images as well. The executables for all applications must be located on your `PATH`.

Rc parameters that control the behavior of the `pgf` backend:

Parameter	Documentation
<code>pgf.preamble</code>	Lines to be included in the LaTeX preamble
<code>pgf.rcfonts</code>	Setup fonts from rc params using the <code>fontspec</code> package
<code>pgf.texsystem</code>	Either “ <code>xelatex</code> ” (default), “ <code>lualatex</code> ” or “ <code>pdflatex</code> ”

Note: TeX defines a set of special characters, such as:

```
# $ % & ~ _ ^ \ { }
```

Generally, these characters must be escaped correctly. For convenience, some characters (`_`, `^`, `%`) are automatically escaped outside of math environments.

4.8.1 Font specification

The fonts used for obtaining the size of text elements or when compiling figures to PDF are usually defined in the matplotlib rc parameters. You can also use the LaTeX default Computer Modern fonts by clearing the lists for `font.serif`, `font.sans-serif` or `font.monospace`. Please note that the glyph coverage of these fonts is very limited. If you want to keep the Computer Modern font face but require extended unicode support, consider installing the [Computer Modern Unicode](#) fonts *CMU Serif*, *CMU Sans Serif*, etc.

When saving to `.pgf`, the font configuration matplotlib used for the layout of the figure is included in the header of the text file.

```
# -*- coding: utf-8 -*-

import matplotlib as mpl
mpl.use("pgf")
pgf_with_rc_fonts = {
    "font.family": "serif",
    "font.serif": [], # use latex default serif font
    "font.sans-serif": ["DejaVu Sans"], # use a specific sans-serif font
}
mpl.rcParams.update(pgf_with_rc_fonts)

import matplotlib.pyplot as plt
plt.figure(figsize=(4.5,2.5))
plt.plot(range(5))
plt.text(0.5, 3., "serif")
plt.text(0.5, 2., "monospace", family="monospace")
plt.text(2.5, 2., "sans-serif", family="sans-serif")
plt.text(2.5, 1., "comic sans", family="Comic Sans MS")
plt.xlabel(u"μ is not μ")
plt.tight_layout(.5)
```

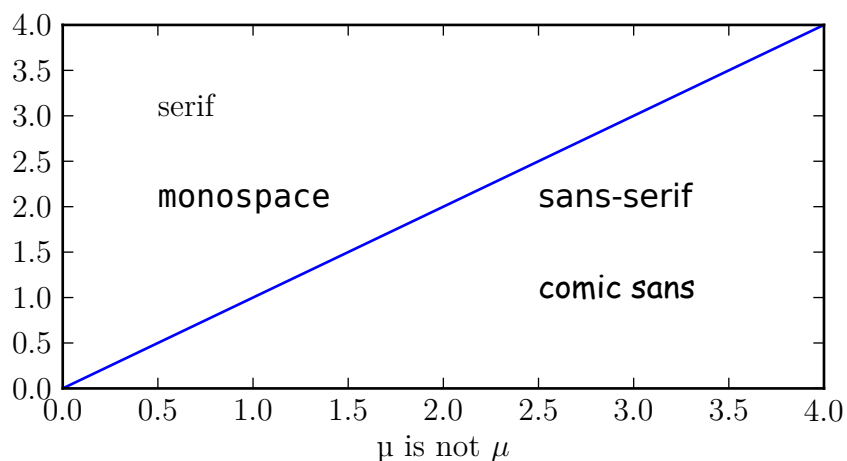

4.8.2 Custom preamble

Full customization is possible by adding your own commands to the preamble. Use the `pgf.preamble` parameter if you want to configure the math fonts, using `unicode-math` for example, or for loading additional packages. Also, if you want to do the font configuration yourself instead of using the fonts specified in the rc parameters, make sure to disable `pgf.rcfonts`.

```
# -*- coding: utf-8 -*-
from __future__ import (absolute_import, division, print_function,
                        unicode_literals)

import six
```

```

import matplotlib as mpl
mpl.use("pgf")
pgf_with_custom_preamble = {
    "font.family": "serif", # use serif/main font for text elements
    "text.usetex": True,    # use inline math for ticks
    "pgf.rcfonts": False,   # don't setup fonts from rc parameters
    "pgf.preamble": [
        "\\usepackage{units}",          # load additional packages
        "\\usepackage{metalogo}",
        "\\usepackage{unicode-math}", # unicode math setup
        r"\setmathfont{xits-math.otf}",
        r"\setmainfont{DejaVu Serif}", # serif font via preamble
    ]
}
mpl.rcParams.update(pgf_with_custom_preamble)

```

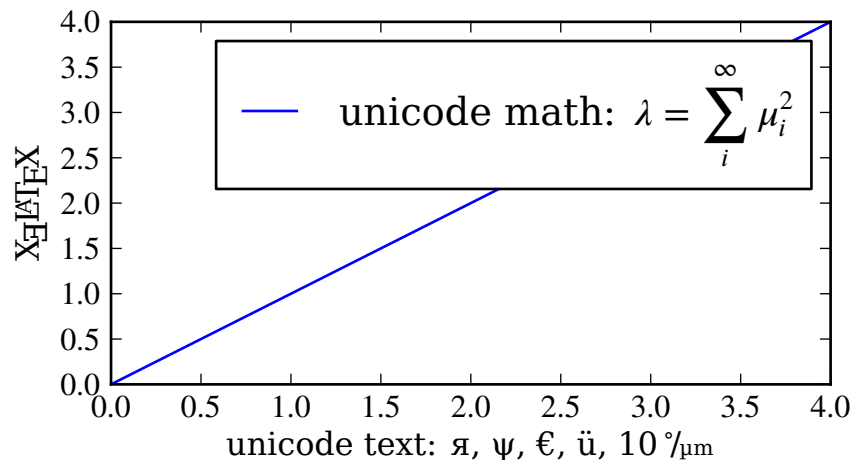

4.8.3 Choosing the TeX system

The TeX system to be used by matplotlib is chosen by the `pgf.texsystem` parameter. Possible values are 'xelatex' (default), 'lualatex' and 'pdflatex'. Please note that when selecting `pdflatex` the fonts and unicode handling must be configured in the preamble.

```

# -*- coding: utf-8 -*-

import matplotlib as mpl
mpl.use("pgf")
pgf_with_pdflatex = {
    "pgf.texsystem": "pdflatex",
    "pgf.preamble": [
        r"\usepackage[utf8x]{inputenc}",
        r"\usepackage[T1]{fontenc}",
        r"\usepackage{cmbright}",
    ]
}

```

```

mpl.rcParams.update(pgf_with_pdflatex)

import matplotlib.pyplot as plt
plt.figure(figsize=(4.5,2.5))
plt.plot(range(5))
plt.text(0.5, 3., "serif", family="serif")
plt.text(0.5, 2., "monospace", family="monospace")
plt.text(2.5, 2., "sans-serif", family="sans-serif")
plt.xlabel(u"μ is not μ")
plt.tight_layout(.5)

```

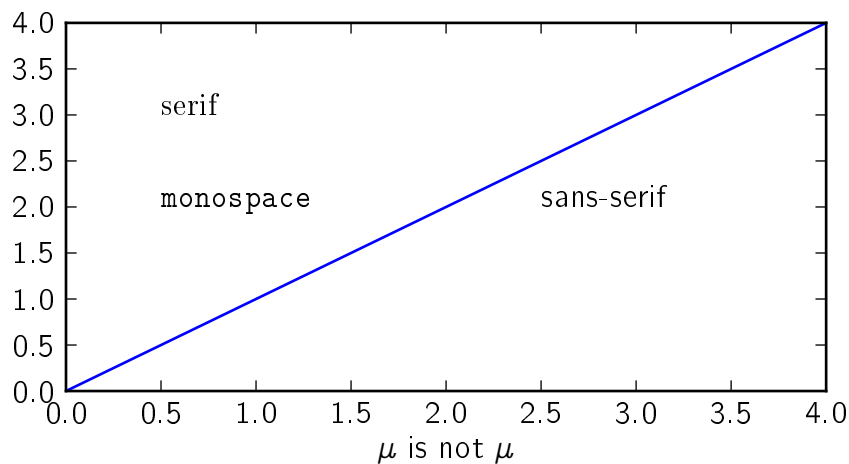

4.8.4 Troubleshooting

- Please note that the TeX packages found in some Linux distributions and MiKTeX installations are dramatically outdated. Make sure to update your package catalog and upgrade or install a recent TeX distribution.
- On Windows, the `PATH` environment variable may need to be modified to include the directories containing the latex, dvipng and ghostscript executables. See *Environment Variables* and *Setting environment variables in windows* for details.
- A limitation on Windows causes the backend to keep file handles that have been opened by your application open. As a result, it may not be possible to delete the corresponding files until the application closes (see #1324).
- Sometimes the font rendering in figures that are saved to png images is very bad. This happens when the pdftocairo tool is not available and ghostscript is used for the pdf to png conversion.
- Make sure what you are trying to do is possible in a LaTeX document, that your LaTeX syntax is valid and that you are using raw strings if necessary to avoid unintended escape sequences.
- The `pgf.preamble` rc setting provides lots of flexibility, and lots of ways to cause problems. When experiencing problems, try to minimize or disable the custom preamble.

- Configuring an `unicode-math` environment can be a bit tricky. The TeXLive distribution for example provides a set of math fonts which are usually not installed system-wide. XeTeX, unlike LuaLatex, cannot find these fonts by their name, which is why you might have to specify `\setmathfont{xits-math.otf}` instead of `\setmathfont{XITS Math}` or alternatively make the fonts available to your OS. See this tex.stackexchange.com question for more details.
- If the font configuration used by matplotlib differs from the font setting in your LaTeX document, the alignment of text elements in imported figures may be off. Check the header of your `.pgf` file if you are unsure about the fonts matplotlib used for the layout.
- Vector images and hence `.pgf` files can become bloated if there are a lot of objects in the graph. This can be the case for image processing or very big scatter graphs. In an extreme case this can cause TeX to run out of memory: “TeX capacity exceeded, sorry” You can configure latex to increase the amount of memory available to generate the `.pdf` image as discussed on tex.stackexchange.com. Another way would be to “rasterize” parts of the graph causing problems using either the `rasterized=True` keyword, or `.set_rasterized(True)` as per [this example](#).
- If you still need help, please see [Getting help](#)

5.1 Specifying Colors

In almost all places in matplotlib where a color can be specified by the user it can be provided as:

- an RGB or RGBA tuple of float values in $[0, 1]$ (e.g., $(0.1, 0.2, 0.5)$ or $(0.1, 0.2, 0.5, 0.3)$)
- a hex RGB or RGBA string (e.g., `'#0F0F0F'` or `'#0F0F0F0F'`)
- a string representation of a float value in $[0, 1]$ inclusive for gray level (e.g., `'0.5'`)
- one of `{'b', 'g', 'r', 'c', 'm', 'y', 'k', 'w'}`
- a X11/CSS4 color name
- a name from the [xkcd color survey](#) prefixed with `'xkcd:'` (e.g., `'xkcd:sky blue'`)
- one of `{'C0', 'C1', 'C2', 'C3', 'C4', 'C5', 'C6', 'C7', 'C8', 'C9'}`
- one of `{'tab:blue', 'tab:orange', 'tab:green', 'tab:red', 'tab:purple', 'tab:brown', 'tab:pink', 'tab:gray', 'tab:olive', 'tab:cyan'}` which are the Tableau Colors from the 'T10' categorical palette (which is the default color cycle).

All string specifications of color are case-insensitive.

5.1.1 'CN' color selection

Color can be specified by a string matching the regex `C[0-9]`. This can be passed any place that a color is currently accepted and can be used as a 'single character color' in format-string to `matplotlib.Axes.plot`.

The single digit is the index into the default property cycle (`matplotlib.rcParams['axes.prop_cycle']`). If the property cycle does not include 'color' then black is returned. The color is evaluated when the artist is created. For example,

```
import numpy as np
import matplotlib.pyplot as plt
import matplotlib as mpl
th = np.linspace(0, 2*np.pi, 128)
```

```
def demo(sty):
    mpl.style.use(sty)
    fig, ax = plt.subplots(figsize=(3, 3))

    ax.set_title('style: {!r}'.format(sty), color='C0')

    ax.plot(th, np.cos(th), 'C1', label='C1')
    ax.plot(th, np.sin(th), 'C2', label='C2')
    ax.legend()

demo('default')
demo('seaborn')
```

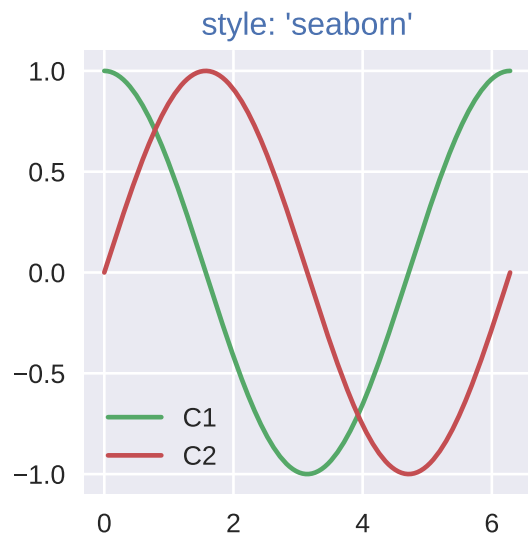
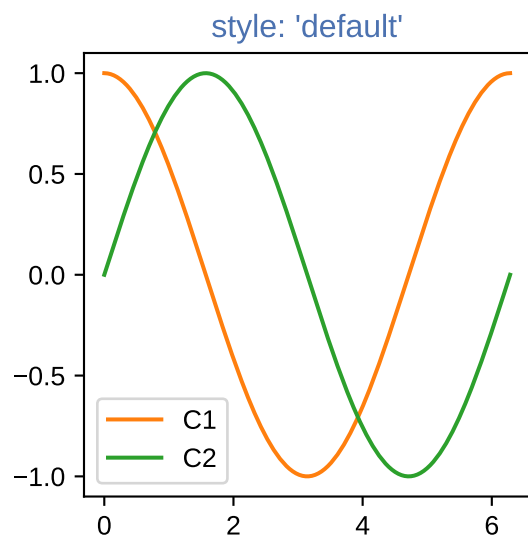

will use the first color for the title and then plot using the second and third colors of each style's `mpl.rcParams['axes.prop_cycle']`.

5.1.2 xkcd v X11/CSS4

The xkcd colors are derived from a user survey conducted by the webcomic xkcd. [Details of the survey are available on the xkcd blog.](#)

Out of 148 colors in the CSS color list, there are 95 name collisions between the X11/CSS4 names and the xkcd names, all but 3 of which have different hex values. For example 'blue' maps to '#0000FF' where as 'xkcd:blue' maps to '#0343DF'. Due to these name collisions all of the xkcd colors have 'xkcd:' prefixed. As noted in the blog post, while it might be interesting to re-define the X11/CSS4 names based on such a survey, we do not do so unilaterally.

The name collisions are shown in the table below; the color names where the hex values agree are shown in bold.

X11	xkcd	
		aqua
		aquamarine
		azure
		beige
		black
		blue
		brown
		chartreuse
		chocolate
		coral
		crimson
		cyan
		darkblue
		darkgreen
		fuchsia
		gold
		goldenrod
		green
		grey
		indigo
		ivory
		khaki
		lavender
		lightblue
		lightgreen
		lime
		magenta
		maroon
		navy
		olive

5.2 Choosing Colormaps

5.2.1 Overview

The idea behind choosing a good colormap is to find a good representation in 3D colorspace for your data set. The best colormap for any given data set depends on many things including:

- Whether representing form or metric data (*[Ware]*)
- Your knowledge of the data set (*e.g.*, is there a critical value from which the other values deviate?)
- If there is an intuitive color scheme for the parameter you are plotting
- If there is a standard in the field the audience may be expecting

For many applications, a perceptually uniform colormap is the best choice — one in which equal steps in data are perceived as equal steps in the color space. Researchers have found that the human brain perceives changes in the lightness parameter as changes in the data much better than, for example, changes in hue. Therefore, colormaps which have monotonically increasing lightness through the colormap will be better interpreted by the viewer. A wonderful example of perceptually uniform colormaps is *[colorcet]*.

Color can be represented in 3D space in various ways. One way to represent color is using CIELAB. In CIELAB, color space is represented by lightness, L^* ; red-green, a^* ; and yellow-blue, b^* . The lightness parameter L^* can then be used to learn more about how the matplotlib colormaps will be perceived by viewers.

An excellent starting resource for learning about human perception of colormaps is from *[IBM]*.

5.2.2 Classes of colormaps

Colormaps are often split into several categories based on their function (see, *e.g.*, *[Moreland]*):

1. Sequential: change in lightness and often saturation of color incrementally, often using a single hue; should be used for representing information that has ordering.
2. Diverging: change in lightness and possibly saturation of two different colors that meet in the middle at an unsaturated color; should be used when the information being plotted has a critical middle value, such as topography or when the data deviates around zero.
3. Qualitative: often are miscellaneous colors; should be used to represent information which does not have ordering or relationships.

5.2.3 Lightness of matplotlib colormaps

Here we examine the lightness values of the matplotlib colormaps. Note that some documentation on the colormaps is available (*[list-colormaps]*).

Sequential

For the Sequential plots, the lightness value increases monotonically through the colormaps. This is good. Some of the L^* values in the colormaps span from 0 to 100 (binary and the other grayscale), and others start around $L^* = 20$. Those that have a smaller range of L^* will accordingly have a smaller perceptual range. Note also that the L^* function varies amongst the colormaps: some are approximately linear in L^* and others are more curved.

Sequential2

Many of the L^* values from the Sequential2 plots are monotonically increasing, but some (autumn, cool, spring, and winter) plateau or even go both up and down in L^* space. Others (afmhot, copper, gist_heat, and hot) have kinks in the L^* functions. Data that is being represented in a region of the colormap that is at a plateau or kink will lead to a perception of banding of the data in those values in the colormap (see [*mycarta-banding*] for an excellent example of this).

Diverging

For the Diverging maps, we want to have monotonically increasing L^* values up to a maximum, which should be close to $L^* = 100$, followed by monotonically decreasing L^* values. We are looking for approximately equal minimum L^* values at opposite ends of the colormap. By these measures, BrBG and RdBu are good options. coolwarm is a good option, but it doesn't span a wide range of L^* values (see grayscale section below).

Qualitative

Qualitative colormaps are not aimed at being perceptual maps, but looking at the lightness parameter can verify that for us. The L^* values move all over the place throughout the colormap, and are clearly not monotonically increasing. These would not be good options for use as perceptual colormaps.

Miscellaneous

Some of the miscellaneous colormaps have particular uses for which they have been created. For example, gist_earth, ocean, and terrain all seem to be created for plotting topography (green/brown) and water depths (blue) together. We would expect to see a divergence in these colormaps, then, but multiple kinks may not be ideal, such as in gist_earth and terrain. CMRmap was created to convert well to grayscale, though it does appear to have some small kinks in L^* . cubehelix was created to vary smoothly in both lightness and hue, but appears to have a small hump in the green hue area.

The often-used jet colormap is included in this set of colormaps. We can see that the L^* values vary widely throughout the colormap, making it a poor choice for representing data for viewers to see perceptually. See an extension on this idea at [*mycarta-jet*].

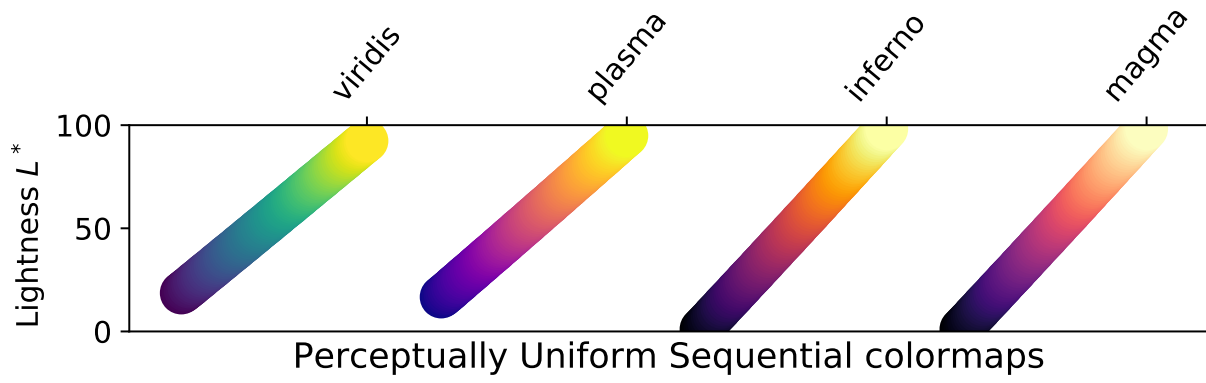

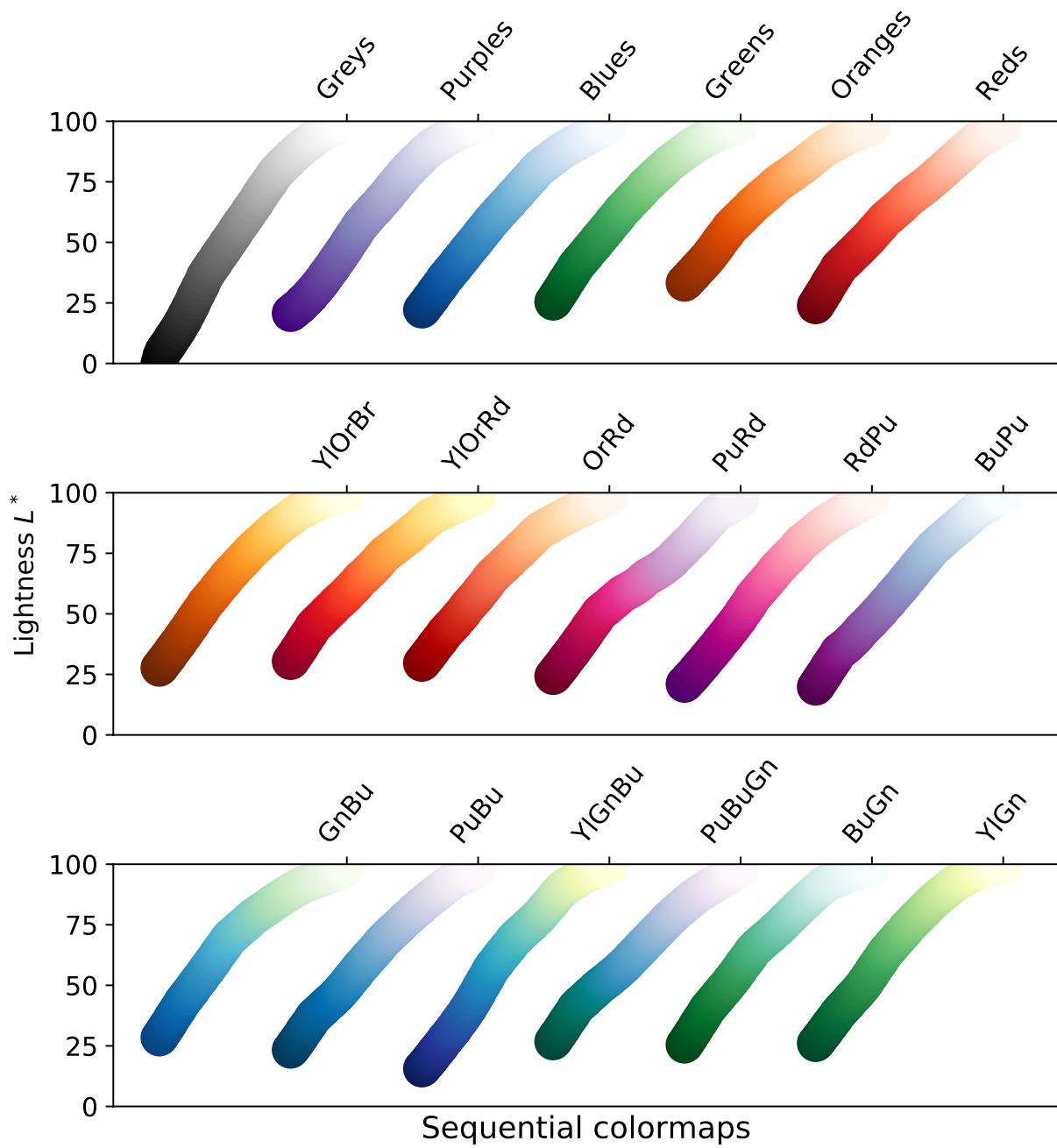

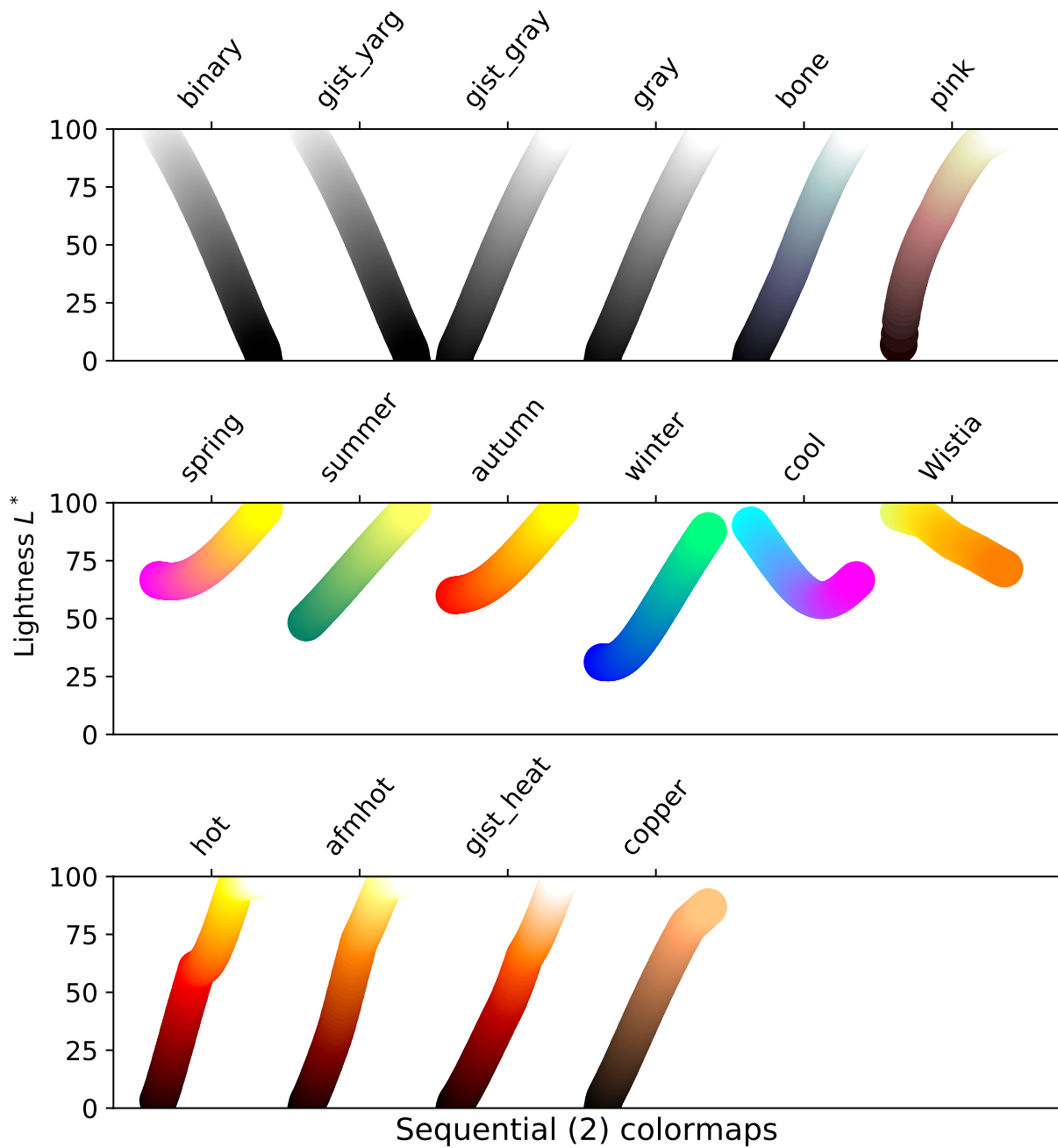

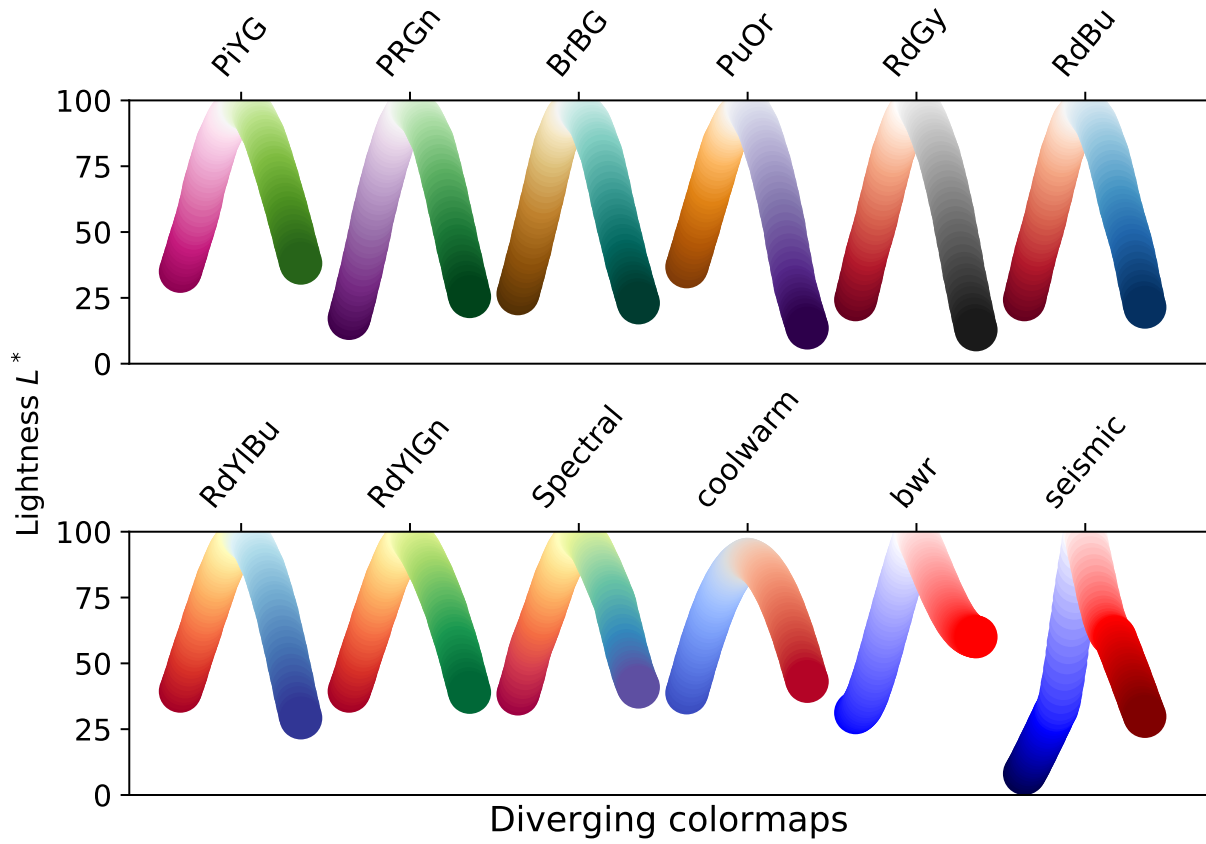

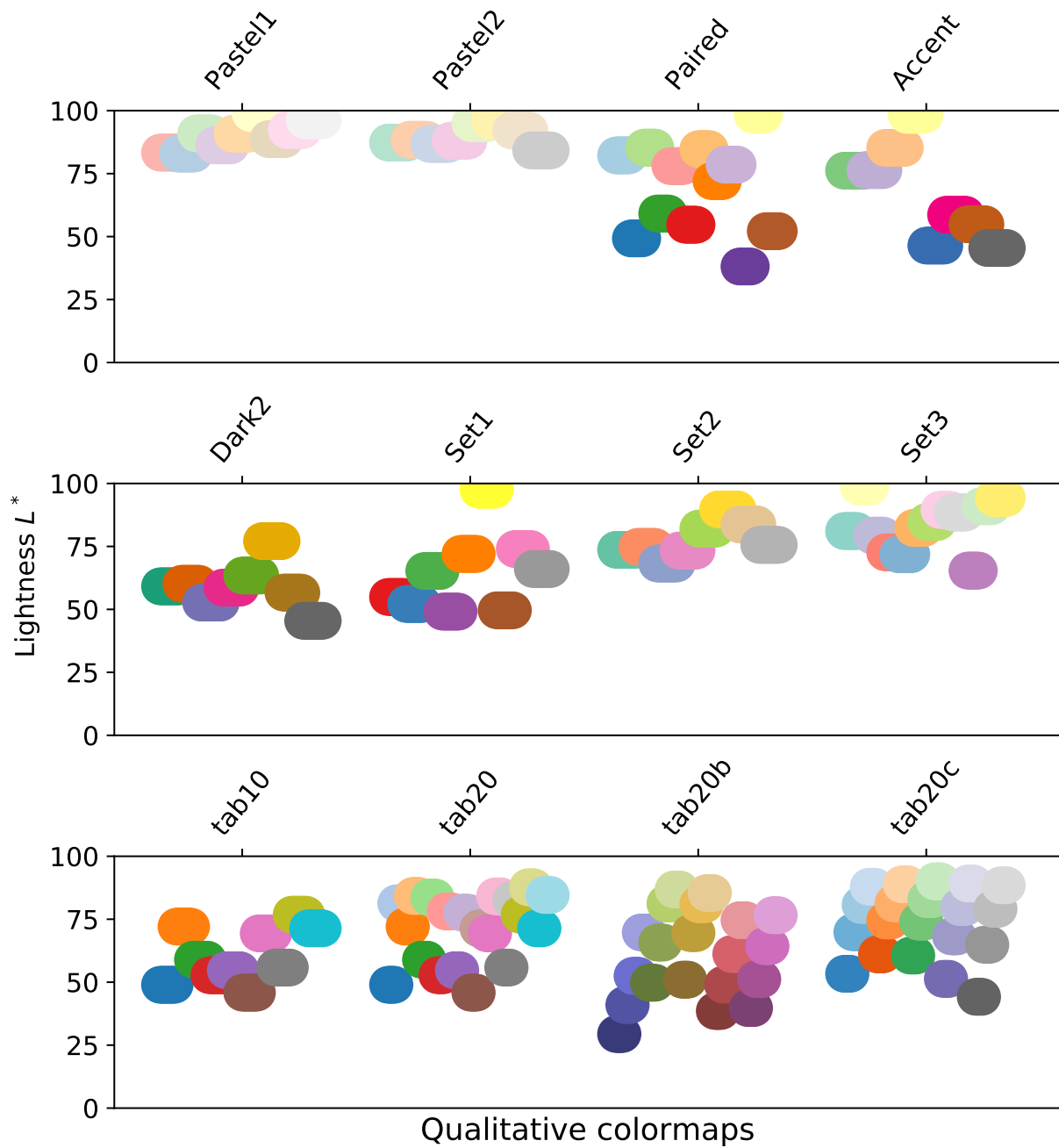

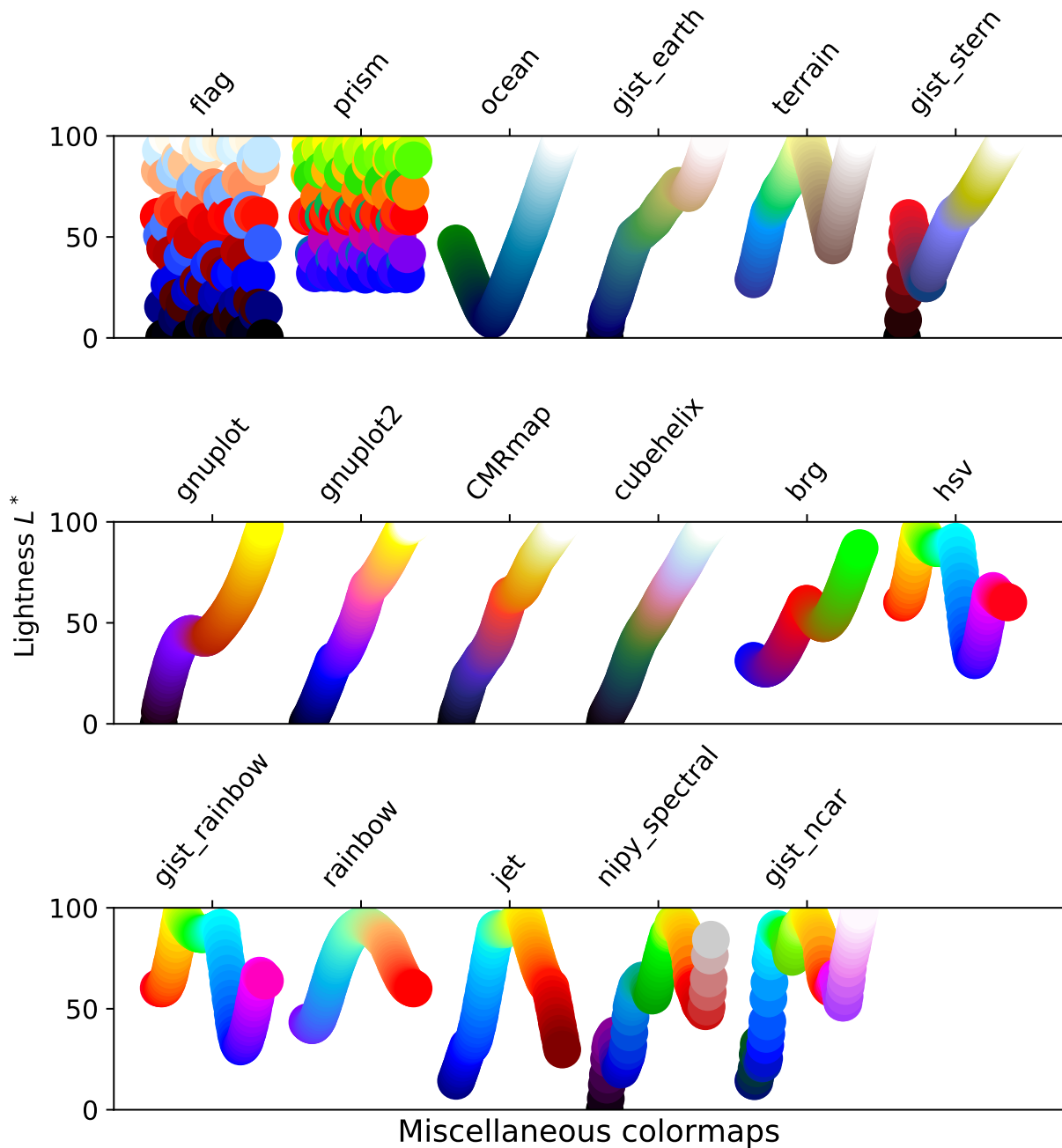

5.2.4 Grayscale conversion

It is important to pay attention to conversion to grayscale for color plots, since they may be printed on black and white printers. If not carefully considered, your readers may end up with indecipherable plots because the grayscale changes unpredictably through the colormap.

Conversion to grayscale is done in many different ways [bw]. Some of the better ones use a linear combination of the rgb values of a pixel, but weighted according to how we perceive color intensity. A nonlinear

method of conversion to grayscale is to use the L^* values of the pixels. In general, similar principles apply for this question as they do for presenting one's information perceptually; that is, if a colormap is chosen that is monotonically increasing in L^* values, it will print in a reasonable manner to grayscale.

With this in mind, we see that the Sequential colormaps have reasonable representations in grayscale. Some of the Sequential2 colormaps have decent enough grayscale representations, though some (autumn, spring, summer, winter) have very little grayscale change. If a colormap like this was used in a plot and then the plot was printed to grayscale, a lot of the information may map to the same gray values. The Diverging colormaps mostly vary from darker gray on the outer edges to white in the middle. Some (PuOr and seismic) have noticeably darker gray on one side than the other and therefore are not very symmetric. coolwarm has little range of gray scale and would print to a more uniform plot, losing a lot of detail. Note that overlaid, labeled contours could help differentiate between one side of the colormap vs. the other since color cannot be used once a plot is printed to grayscale. Many of the Qualitative and Miscellaneous colormaps, such as Accent, hsv, and jet, change from darker to lighter and back to darker gray throughout the colormap. This would make it impossible for a viewer to interpret the information in a plot once it is printed in grayscale.

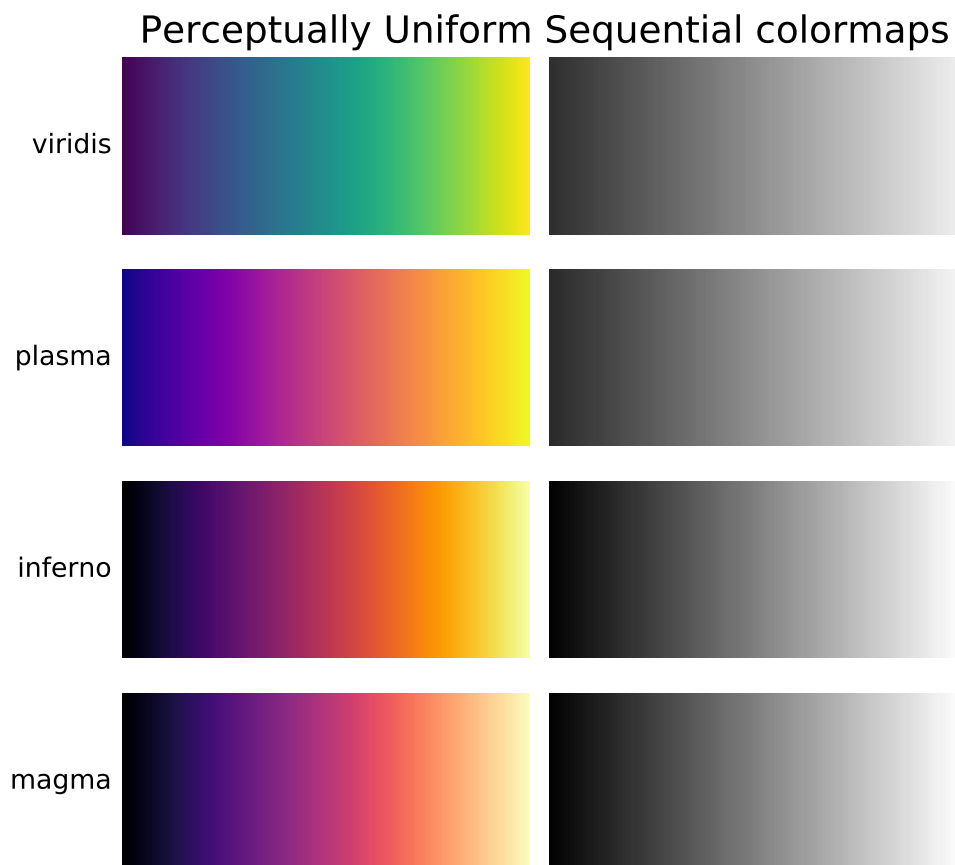

Sequential colormaps

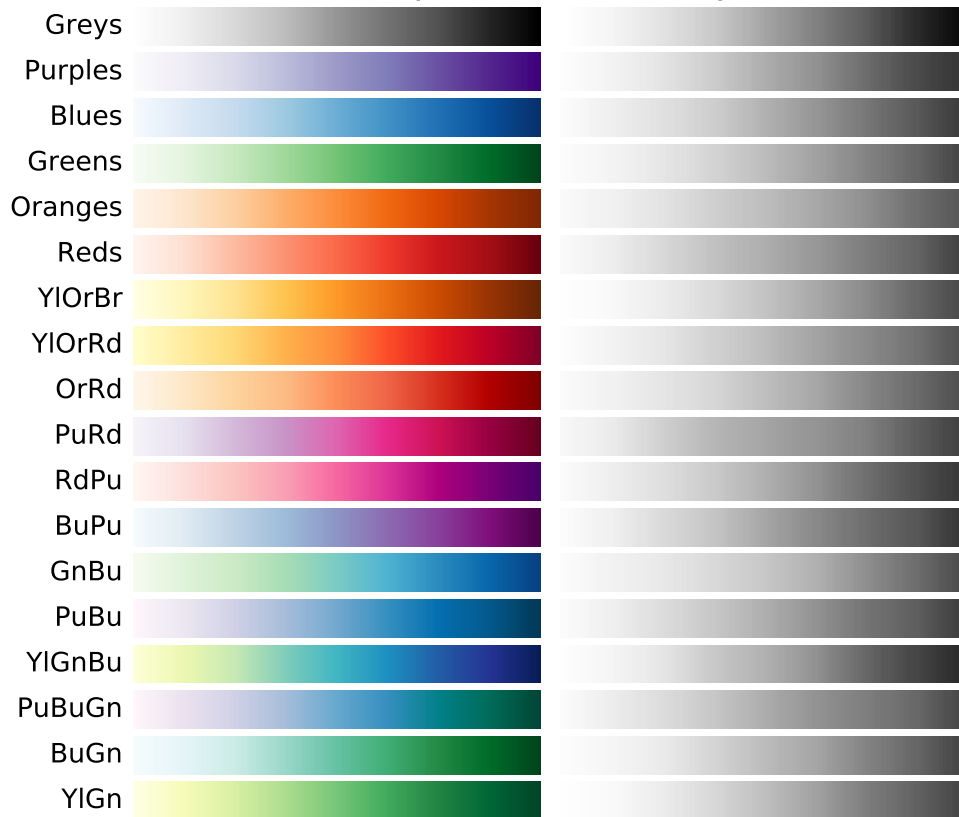

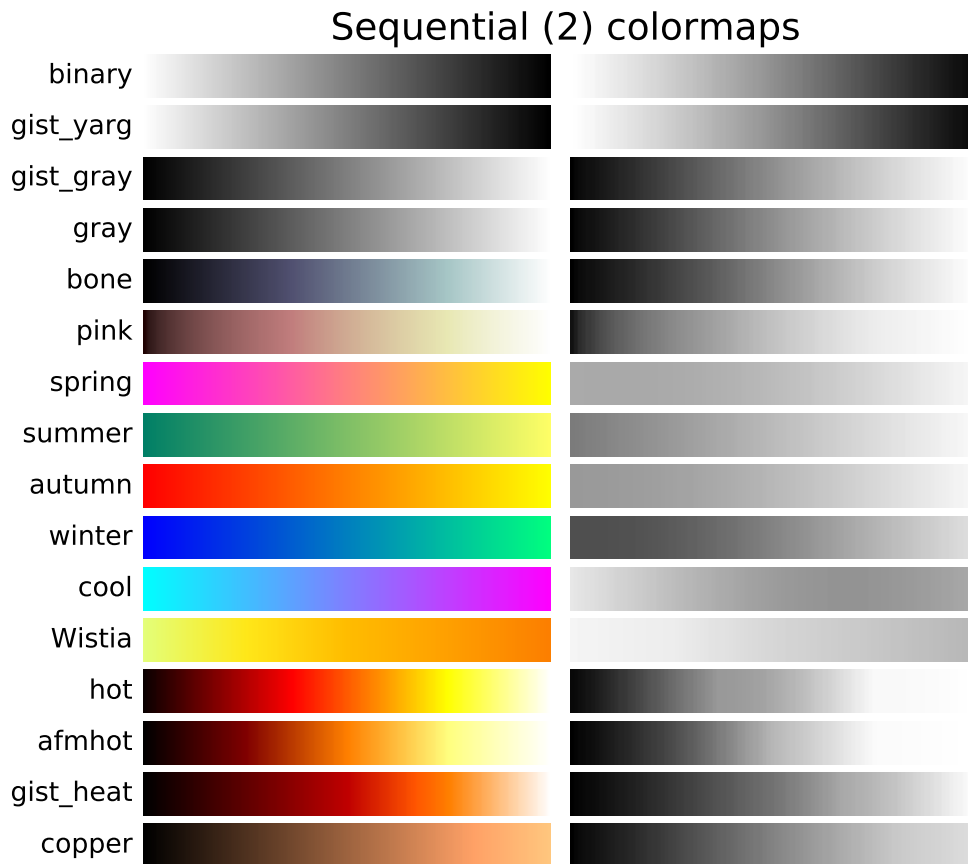

Diverging colormaps

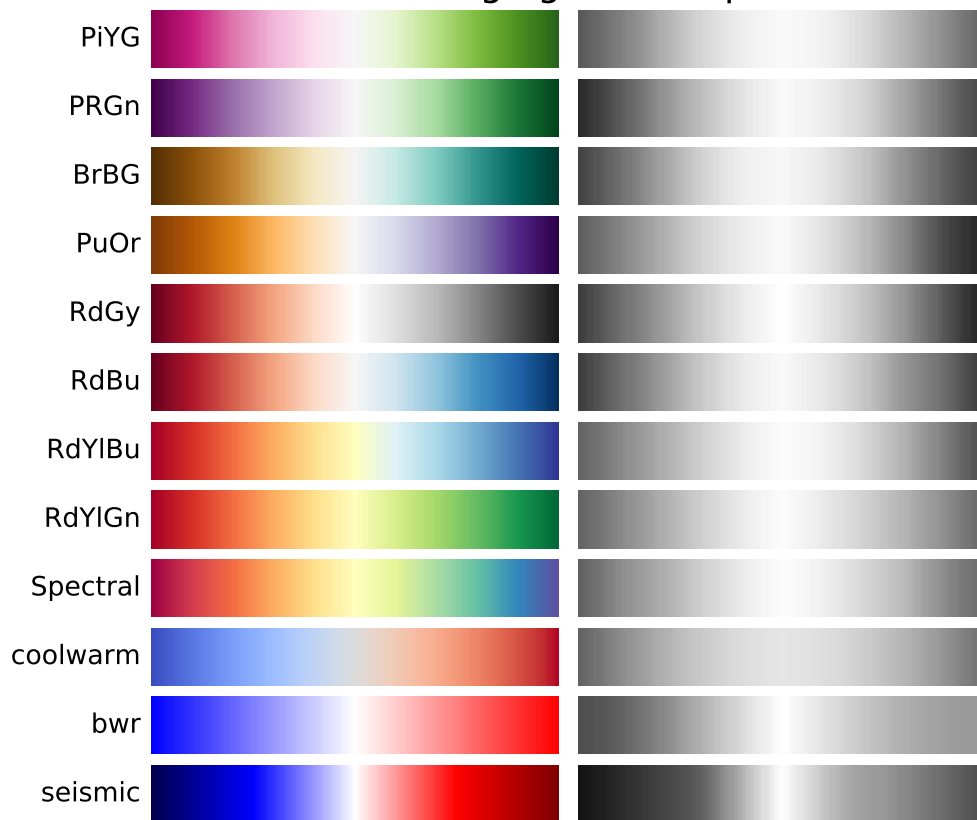

Qualitative colormaps

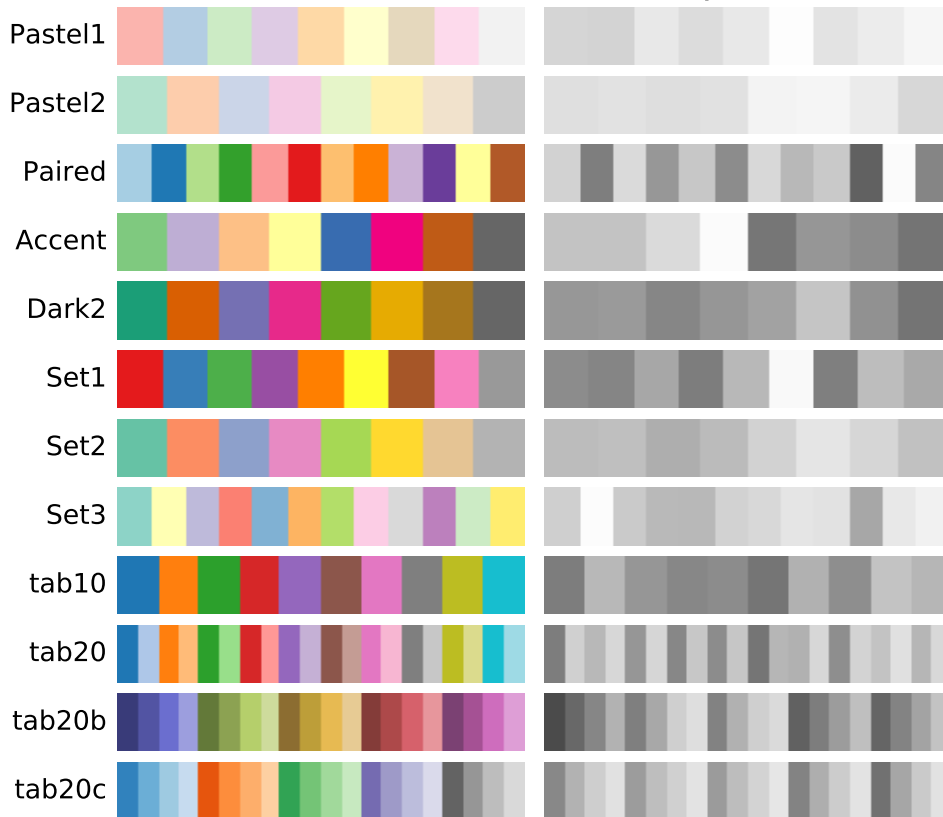

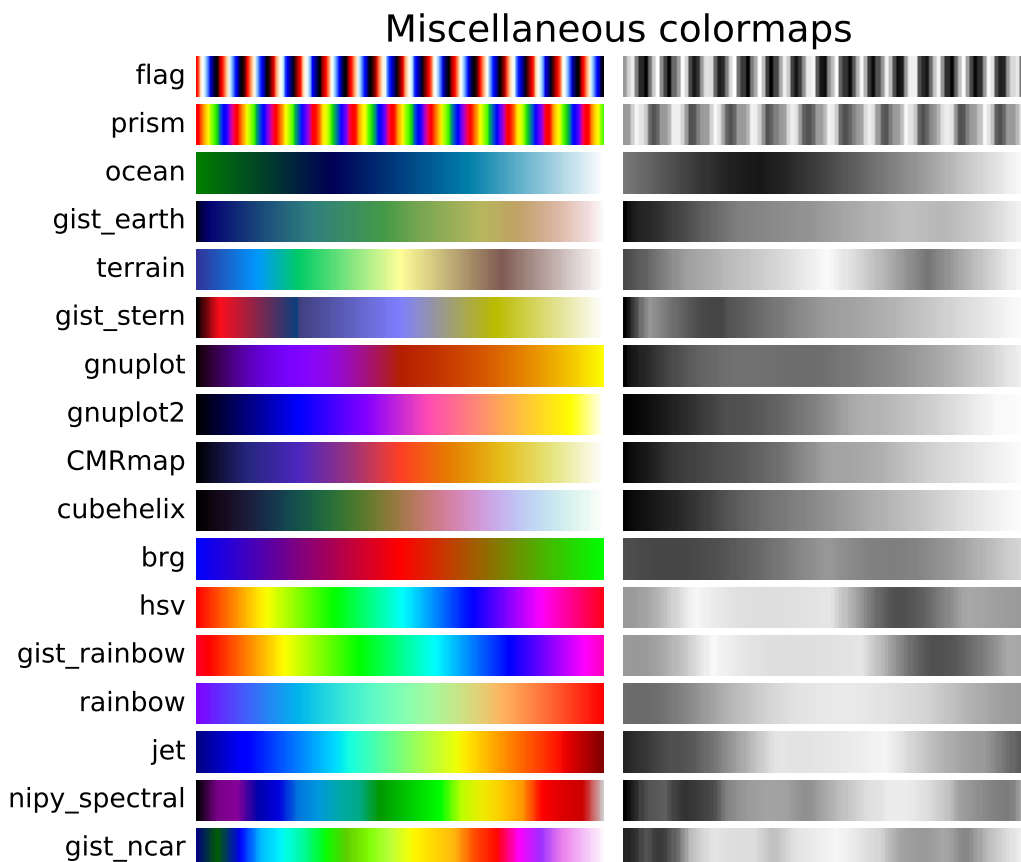

5.2.5 Color vision deficiencies

There is a lot of information available about color blindness (*e.g.*, [[colorblindness](#)]). Additionally, there are tools available to convert images to how they look for different types of color vision deficiencies (*e.g.*, [[vischeck](#)]).

The most common form of color vision deficiency involves differentiating between red and green. Thus, avoiding colormaps with both red and green will avoid many problems in general.

5.2.6 References

5.3 Colormap Normalization

Objects that use colormaps by default linearly map the colors in the colormap from data values v_{min} to v_{max} . For example:

```
pcm = ax.pcolormesh(x, y, Z, vmin=-1., vmax=1., cmap='RdBu_r')
```

will map the data in Z linearly from -1 to +1, so $Z=0$ will give a color at the center of the colormap *RdBu_r* (white in this case).

Matplotlib does this mapping in two steps, with a normalization from [0,1] occurring first, and then mapping onto the indices in the colormap. Normalizations are classes defined in the `matplotlib.colors()` module. The default, linear normalization is `matplotlib.colors.Normalize()`.

Artists that map data to color pass the arguments `vmin` and `vmax` to construct a `matplotlib.colors.Normalize()` instance, then call it:

```
In [1]: import matplotlib as mpl
In [2]: norm = mpl.colors.Normalize(vmin=-1.,vmax=1.)
In [3]: norm(0.)
Out[3]: 0.5
```

However, there are sometimes cases where it is useful to map data to colormaps in a non-linear fashion.

5.3.1 Logarithmic

One of the most common transformations is to plot data by taking its logarithm (to the base-10). This transformation is useful to display changes across disparate scales. Using `colors.LogNorm()` normalizes the data via \log_{10} . In the example below, there are two bumps, one much smaller than the other. Using `colors.LogNorm()`, the shape and location of each bump can clearly be seen:

```
"""
Demonstration of using norm to map colormaps onto data in non-linear ways.
"""

import numpy as np
import matplotlib.pyplot as plt
import matplotlib.colors as colors
from matplotlib.mlab import bivariate_normal

"""
Lognorm: Instead of pcolor log10(Z1) you can have colorbars that have
the exponential labels using a norm.
"""
N = 100
X, Y = np.mgrid[-3:3:complex(0, N), -2:2:complex(0, N)]

# A low hump with a spike coming out of the top right. Needs to have
# z/colour axis on a log scale so we see both hump and spike. linear
# scale only shows the spike.
Z1 = bivariate_normal(X, Y, 0.1, 0.2, 1.0, 1.0) + \
     0.1 * bivariate_normal(X, Y, 1.0, 1.0, 0.0, 0.0)

fig, ax = plt.subplots(2, 1)

pcm = ax[0].pcolor(X, Y, Z1,
                  norm=colors.LogNorm(vmin=Z1.min(), vmax=Z1.max()),
                  cmap='PuBu_r')
fig.colorbar(pcm, ax=ax[0], extend='max')
```

```
pcm = ax[1].pcolor(X, Y, Z1, cmap='PuBu_r')
fig.colorbar(pcm, ax=ax[1], extend='max')
fig.show()
```

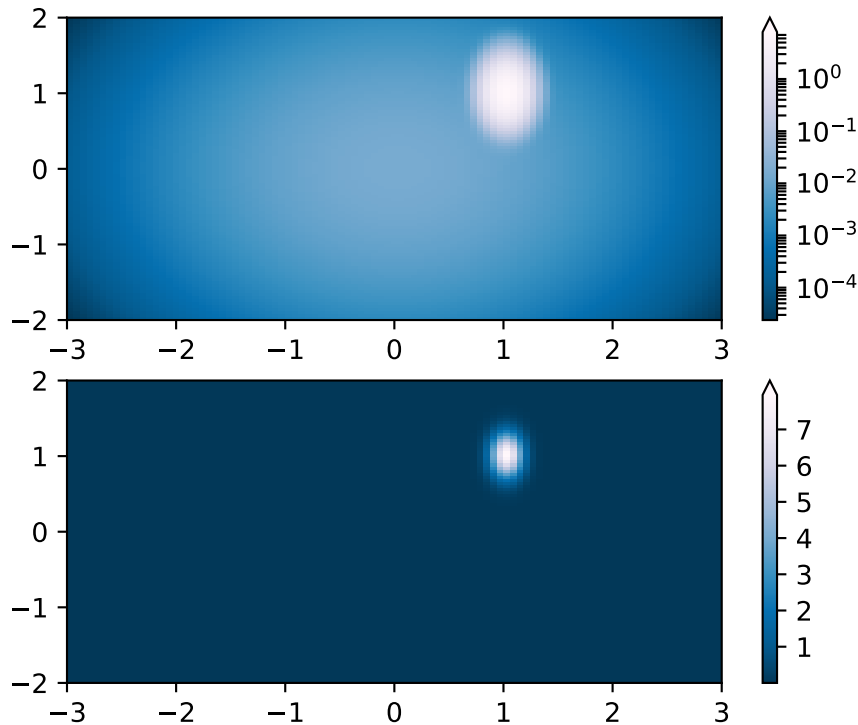

5.3.2 Symmetric logarithmic

Similarly, it sometimes happens that there is data that is positive and negative, but we would still like a logarithmic scaling applied to both. In this case, the negative numbers are also scaled logarithmically, and mapped to smaller numbers; e.g., if $v_{\min} = -v_{\max}$, then they the negative numbers are mapped from 0 to 0.5 and the positive from 0.5 to 1.

Since the logarithm of values close to zero tends toward infinity, a small range around zero needs to be mapped linearly. The parameter *linthresh* allows the user to specify the size of this range (*-linthresh*, *linthresh*). The size of this range in the colormap is set by *linscale*. When *linscale* == 1.0 (the default), the space used for the positive and negative halves of the linear range will be equal to one decade in the logarithmic range.

```
"""
Demonstration of using norm to map colormaps onto data in non-linear ways.
"""

import numpy as np
import matplotlib.pyplot as plt
```

```

import matplotlib.colors as colors
from matplotlib.mlab import bivariate_normal

"""
SymLogNorm: two humps, one negative and one positive, The positive
with 5-times the amplitude. Linearly, you cannot see detail in the
negative hump. Here we logarithmically scale the positive and
negative data separately.

Note that colorbar labels do not come out looking very good.
"""
N=100
X, Y = np.mgrid[-3:3:complex(0, N), -2:2:complex(0, N)]
Z1 = (bivariate_normal(X, Y, 1., 1., 1.0, 1.0))**2 \
     - 0.4 * (bivariate_normal(X, Y, 1.0, 1.0, -1.0, 0.0))**2
Z1 = Z1/0.03

fig, ax = plt.subplots(2, 1)

pcm = ax[0].pcolormesh(X, Y, Z1,
                      norm=colors.SymLogNorm(linthresh=0.03, linscale=0.03,
                                             vmin=-1.0, vmax=1.0),
                      cmap='RdBu_r')
fig.colorbar(pcm, ax=ax[0], extend='both')

pcm = ax[1].pcolormesh(X, Y, Z1, cmap='RdBu_r', vmin=-np.max(Z1))
fig.colorbar(pcm, ax=ax[1], extend='both')
fig.show()

```

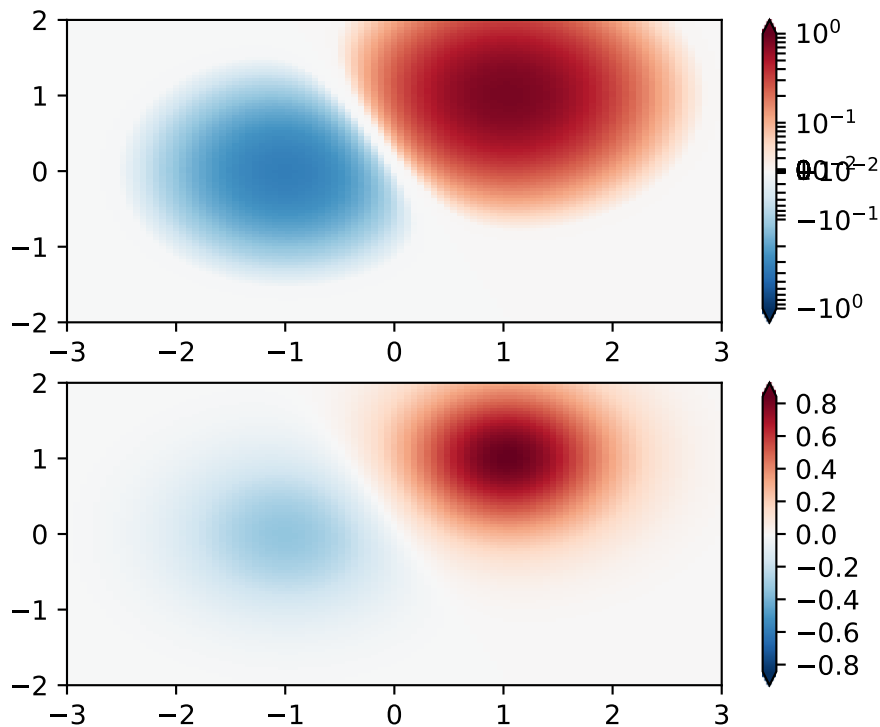

5.3.3 Power-law

Sometimes it is useful to remap the colors onto a power-law relationship (i.e. $y = x^\gamma$, where γ is the power). For this we use the `colors.PowerNorm()`. It takes as an argument *gamma* (*gamma* == 1.0 will just yield the default linear normalization):

Note: There should probably be a good reason for plotting the data using this type of transformation. Technical viewers are used to linear and logarithmic axes and data transformations. Power laws are less common, and viewers should explicitly be made aware that they have been used.

```

"""
Demonstration of using norm to map colormaps onto data in non-linear ways.
"""

import numpy as np
import matplotlib.pyplot as plt
import matplotlib.colors as colors
from matplotlib.mlab import bivariate_normal

N = 100
X, Y = np.mgrid[-3:3:complex(0, N), -2:2:complex(0, N)]

```

```

"""
PowerNorm: Here a power-law trend in X partially obscures a rectified
sine wave in Y. We can remove the power law using a PowerNorm.
"""
X, Y = np.mgrid[0:3:complex(0, N), 0:2:complex(0, N)]
Z1 = (1 + np.sin(Y * 10.)) * X**(2.)

fig, ax = plt.subplots(2, 1)

pcm = ax[0].pcolormesh(X, Y, Z1, norm=colors.PowerNorm(gamma=1./2.),
                      cmap='PuBu_r')
fig.colorbar(pcm, ax=ax[0], extend='max')

pcm = ax[1].pcolormesh(X, Y, Z1, cmap='PuBu_r')
fig.colorbar(pcm, ax=ax[1], extend='max')
fig.show()

```

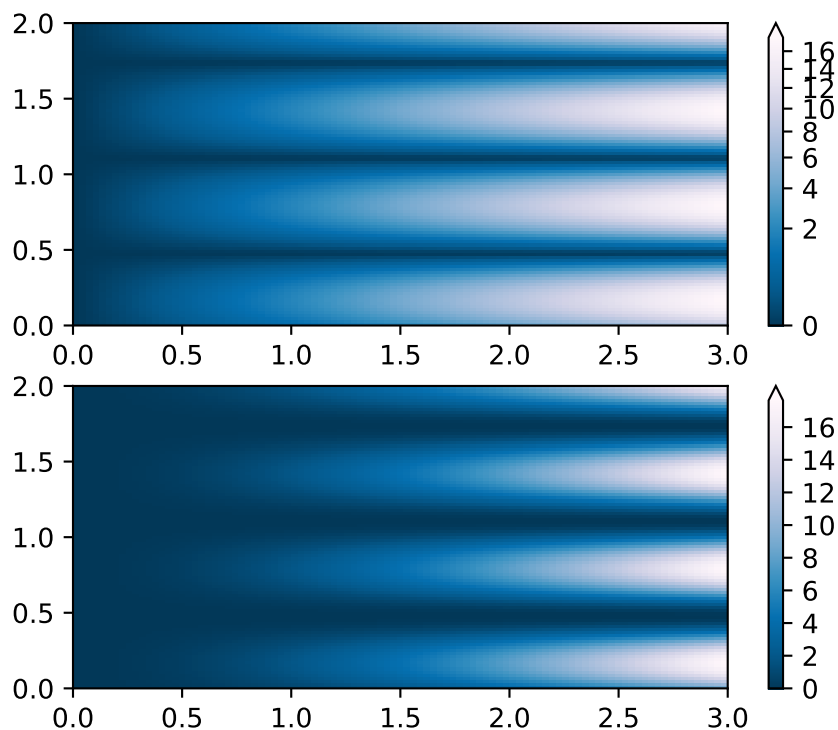

5.3.4 Discrete bounds

Another normalization that comes with matplotlib is `colors.BoundaryNorm()`. In addition to `vmin` and `vmax`, this takes as arguments boundaries between which data is to be mapped. The colors are then linearly distributed between these “bounds”. For instance:

```
In [4]: import matplotlib.colors as colors

In [5]: bounds = np.array([-0.25, -0.125, 0, 0.5, 1])

In [6]: norm = colors.BoundaryNorm(boundaries=bounds, ncolors=4)

In [7]: print(norm([-0.2, -0.15, -0.02, 0.3, 0.8, 0.99]))
[0 0 1 2 3 3]
```

Note unlike the other norms, this norm returns values from 0 to *ncolors*-1.

```
"""
Demonstration of using norm to map colormaps onto data in non-linear ways.
"""

import numpy as np
import matplotlib.pyplot as plt
import matplotlib.colors as colors
from matplotlib.mlab import bivariate_normal

N = 100
X, Y = np.mgrid[-3:3:complex(0, N), -2:2:complex(0, N)]
Z1 = (bivariate_normal(X, Y, 1., 1., 1.0, 1.0))**2 \
     - 0.4 * (bivariate_normal(X, Y, 1.0, 1.0, -1.0, 0.0))**2
Z1 = Z1/0.03

"""
BoundaryNorm: For this one you provide the boundaries for your colors,
and the Norm puts the first color in between the first pair, the
second color between the second pair, etc.
"""

fig, ax = plt.subplots(3, 1, figsize=(8, 8))
ax = ax.flatten()
# even bounds gives a contour-like effect
bounds = np.linspace(-1, 1, 10)
norm = colors.BoundaryNorm(boundaries=bounds, ncolors=256)
pcm = ax[0].pcolormesh(X, Y, Z1,
                      norm=norm,
                      cmap='RdBu_r')
fig.colorbar(pcm, ax=ax[0], extend='both', orientation='vertical')

# uneven bounds changes the colormapping:
bounds = np.array([-0.25, -0.125, 0, 0.5, 1])
norm = colors.BoundaryNorm(boundaries=bounds, ncolors=256)
pcm = ax[1].pcolormesh(X, Y, Z1, norm=norm, cmap='RdBu_r')
fig.colorbar(pcm, ax=ax[1], extend='both', orientation='vertical')

pcm = ax[2].pcolormesh(X, Y, Z1, cmap='RdBu_r', vmin=-np.max(Z1))
fig.colorbar(pcm, ax=ax[2], extend='both', orientation='vertical')
fig.show()
```

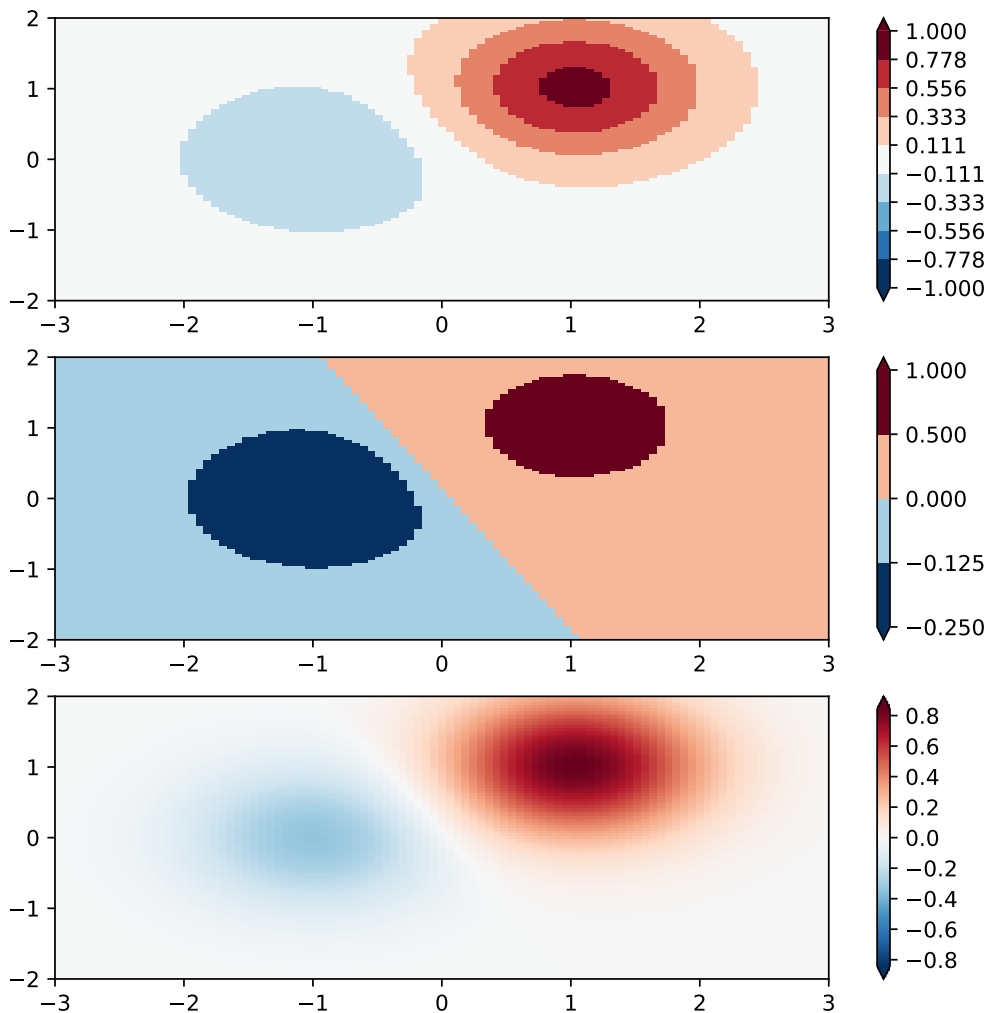

5.3.5 Custom normalization: Two linear ranges

It is possible to define your own normalization. In the following example, we modify `colors.SymLogNorm()` to use different linear maps for the negative data values and the positive. (Note that this example is simple, and does not validate inputs or account for complex cases such as masked data)

Note: This may appear soon as `colors.OffsetNorm()`.

As above, non-symmetric mapping of data to color is non-standard practice for quantitative data, and should only be used advisedly. A practical example is having an ocean/land colormap where the land and ocean

data span different ranges.

```

"""
Demonstration of using norm to map colormaps onto data in non-linear ways.
"""

import numpy as np
import matplotlib.pyplot as plt
import matplotlib.colors as colors
from matplotlib.mlab import bivariate_normal

N = 100
"""
Custom Norm: An example with a customized normalization. This one
uses the example above, and normalizes the negative data differently
from the positive.
"""
X, Y = np.mgrid[-3:3:complex(0, N), -2:2:complex(0, N)]
Z1 = (bivariate_normal(X, Y, 1., 1., 1.0, 1.0))**2 \
     - 0.4 * (bivariate_normal(X, Y, 1.0, 1.0, -1.0, 0.0))**2
Z1 = Z1/0.03

# Example of making your own norm. Also see matplotlib.colors.
# From Joe Kington: This one gives two different linear ramps:

class MidpointNormalize(colors.Normalize):
    def __init__(self, vmin=None, vmax=None, midpoint=None, clip=False):
        self.midpoint = midpoint
        colors.Normalize.__init__(self, vmin, vmax, clip)

    def __call__(self, value, clip=None):
        # I'm ignoring masked values and all kinds of edge cases to make a
        # simple example...
        x, y = [self.vmin, self.midpoint, self.vmax], [0, 0.5, 1]
        return np.ma.masked_array(np.interp(value, x, y))

#####
fig, ax = plt.subplots(2, 1)

pcm = ax[0].pcolormesh(X, Y, Z1,
                      norm=MidpointNormalize(midpoint=0.),
                      cmap='RdBu_r')
fig.colorbar(pcm, ax=ax[0], extend='both')

pcm = ax[1].pcolormesh(X, Y, Z1, cmap='RdBu_r', vmin=-np.max(Z1))
fig.colorbar(pcm, ax=ax[1], extend='both')
fig.show()

```

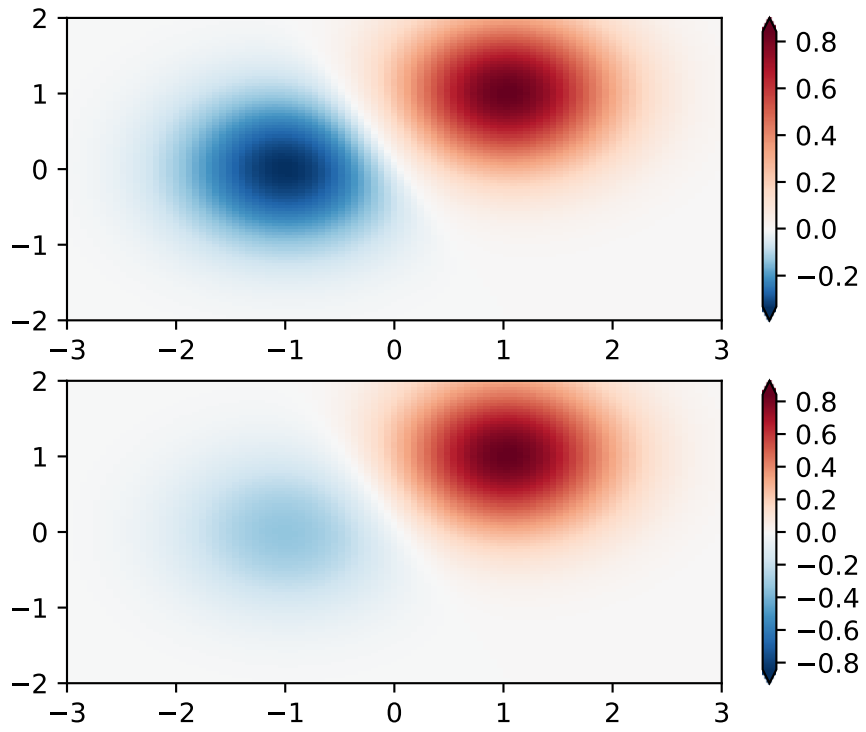
CUSTOMIZING MATPLOTLIB

6.1 Using style sheets

The `style` package adds support for easy-to-switch plotting “styles” with the same parameters as a `matplotlibrc` file (which is read at startup to configure matplotlib).

There are a number of pre-defined styles provided by matplotlib. For example, there’s a pre-defined style called “ggplot”, which emulates the aesthetics of `ggplot` (a popular plotting package for R). To use this style, just add:

```
>>> import matplotlib.pyplot as plt
>>> plt.style.use('ggplot')
```

To list all available styles, use:

```
>>> print(plt.style.available)
```

6.1.1 Defining your own style

You can create custom styles and use them by calling `style.use` with the path or URL to the style sheet. Additionally, if you add your `<style-name>.mplstyle` file to `mpl_configdir/stylelib`, you can reuse your custom style sheet with a call to `style.use(<style-name>)`. By default `mpl_configdir` should be `~/.config/matplotlib`, but you can check where yours is with `matplotlib.get_configdir()`; you may need to create this directory. You also can change the directory where matplotlib looks for the `stylelib/` folder by setting the `MPLCONFIGDIR` environment variable, see *matplotlib configuration and cache directory locations*.

Note that a custom style sheet in `mpl_configdir/stylelib` will override a style sheet defined by matplotlib if the styles have the same name.

For example, you might want to create `mpl_configdir/stylelib/presentation.mplstyle` with the following:

```
axes.titlesize : 24
axes.labelsize : 20
lines.linewidth : 3
lines.markersize : 10
```

```
xtick.labelsize : 16
ytick.labelsize : 16
```

Then, when you want to adapt a plot designed for a paper to one that looks good in a presentation, you can just add:

```
>>> import matplotlib.pyplot as plt
>>> plt.style.use('presentation')
```

6.1.2 Composing styles

Style sheets are designed to be composed together. So you can have a style sheet that customizes colors and a separate style sheet that alters element sizes for presentations. These styles can easily be combined by passing a list of styles:

```
>>> import matplotlib.pyplot as plt
>>> plt.style.use(['dark_background', 'presentation'])
```

Note that styles further to the right will overwrite values that are already defined by styles on the left.

6.1.3 Temporary styling

If you only want to use a style for a specific block of code but don't want to change the global styling, the style package provides a context manager for limiting your changes to a specific scope. To isolate your styling changes, you can write something like the following:

```
>>> import numpy as np
>>> import matplotlib.pyplot as plt
>>>
>>> with plt.style.context('dark_background'):
>>>     plt.plot(np.sin(np.linspace(0, 2 * np.pi)), 'r-o')
>>>
>>> # Some plotting code with the default style
>>>
>>> plt.show()
```

6.2 matplotlib rcParams

6.2.1 Dynamic rc settings

You can also dynamically change the default rc settings in a python script or interactively from the python shell. All of the rc settings are stored in a dictionary-like variable called `matplotlib.rcParams`, which is global to the matplotlib package. rcParams can be modified directly, for example:

```
import matplotlib as mpl
mpl.rcParams['lines.linewidth'] = 2
mpl.rcParams['lines.color'] = 'r'
```

Matplotlib also provides a couple of convenience functions for modifying rc settings. The `matplotlib.rc()` command can be used to modify multiple settings in a single group at once, using keyword arguments:

```
import matplotlib as mpl
mpl.rc('lines', linewidth=2, color='r')
```

The `matplotlib.rcdefaults()` command will restore the standard matplotlib default settings.

There is some degree of validation when setting the values of rcParams, see `matplotlib.rcsetup` for details.

6.2.2 The matplotlibrc file

matplotlib uses matplotlibrc configuration files to customize all kinds of properties, which we call rc settings or rc parameters. You can control the defaults of almost every property in matplotlib: figure size and dpi, line width, color and style, axes, axis and grid properties, text and font properties and so on. matplotlib looks for matplotlibrc in four locations, in the following order:

1. matplotlibrc in the current working directory, usually used for specific customizations that you do not want to apply elsewhere.
2. \$MATPLOTLIBRC/matplotlibrc.
3. It next looks in a user-specific place, depending on your platform:
 - On Linux and FreeBSD, it looks in `.config/matplotlib/matplotlibrc` (or `$XDG_CONFIG_HOME/matplotlib/matplotlibrc`) if you've customized your environment.
 - On other platforms, it looks in `.matplotlib/matplotlibrc`.

See *matplotlib configuration and cache directory locations*.

4. `INSTALL/matplotlib/mpl-data/matplotlibrc`, where `INSTALL` is something like `/usr/lib/python3.5/site-packages` on Linux, and maybe `C:\Python35\Lib\site-packages` on Windows. Every time you install matplotlib, this file will be overwritten, so if you want your customizations to be saved, please move this file to your user-specific matplotlib directory.

To display where the currently active matplotlibrc file was loaded from, one can do the following:

```
>>> import matplotlib
>>> matplotlib.matplotlib_fname()
'/home/foo/.config/matplotlib/matplotlibrc'
```

See below for a sample *matplotlibrc file*.

A sample matplotlibrc file

```
### MATPLOTLIBRC FORMAT

# This is a sample matplotlib configuration file - you can find a copy
# of it on your system in
# site-packages/matplotlib/mpl-data/matplotlibrc. If you edit it
# there, please note that it will be overwritten in your next install.
# If you want to keep a permanent local copy that will not be
# overwritten, place it in the following location:
# unix/linux:
#     $HOME/.config/matplotlib/matplotlibrc or
#     $XDG_CONFIG_HOME/matplotlib/matplotlibrc (if $XDG_CONFIG_HOME is set)
# other platforms:
#     $HOME/.matplotlib/matplotlibrc
#
# See http://matplotlib.org/users/customizing.html#the-matplotlibrc-file for
# more details on the paths which are checked for the configuration file.
#
# This file is best viewed in a editor which supports python mode
# syntax highlighting. Blank lines, or lines starting with a comment
# symbol, are ignored, as are trailing comments. Other lines must
# have the format
#     key : val # optional comment
#
# Colors: for the color values below, you can either use - a
# matplotlib color string, such as r, k, or b - an rgb tuple, such as
# (1.0, 0.5, 0.0) - a hex string, such as ff00ff - a scalar
# grayscale intensity such as 0.75 - a legal html color name, e.g., red,
# blue, darkslategray

#### CONFIGURATION BEGINS HERE

# The default backend; one of GTK GTKAgg GTKCairo GTK3Agg GTK3Cairo
# MacOSX Qt4Agg Qt5Agg TkAgg WX WXAgg Agg Cairo GDK PS PDF SVG
# Template.
# You can also deploy your own backend outside of matplotlib by
# referring to the module name (which must be in the PYTHONPATH) as
# 'module://my_backend'.
backend      : TkAgg

# If you are using the Qt4Agg backend, you can choose here
# to use the PyQt4 bindings or the newer PySide bindings to
# the underlying Qt4 toolkit.
#backend.qt4 : PyQt4          # PyQt4 | PySide

# Note that this can be overridden by the environment variable
# QT_API used by Enthought Tool Suite (ETS); valid values are
# "pyqt" and "pyside". The "pyqt" setting has the side effect of
# forcing the use of Version 2 API for QString and QVariant.

# The port to use for the web server in the WebAgg backend.
# webagg.port : 8888
```

```

# If webagg.port is unavailable, a number of other random ports will
# be tried until one that is available is found.
# webagg.port_retries : 50

# When True, open the webbrowser to the plot that is shown
# webagg.open_in_browser : True

# When True, the figures rendered in the nbagg backend are created with
# a transparent background.
# nbagg.transparent : False

# if you are running pyplot inside a GUI and your backend choice
# conflicts, we will automatically try to find a compatible one for
# you if backend_fallback is True
#backend_fallback: True

#interactive : False
#toolbar      : toolbar2 # None | toolbar2 ("classic" is deprecated)
#timezone     : UTC      # a pytz timezone string, e.g., US/Central or Europe/Paris

# Where your matplotlib data lives if you installed to a non-default
# location. This is where the matplotlib fonts, bitmaps, etc reside
#datapath : /home/jdhunter/mpldata

### LINES
# See http://matplotlib.org/api/artist\_api.html#module-matplotlib.lines for more
# information on line properties.
#lines.linewidth : 1.5 # line width in points
#lines.linestyle : - # solid line
#lines.color : C0 # has no affect on plot(); see axes.prop_cycle
#lines.marker : None # the default marker
#lines.markeredgewidth : 1.0 # the line width around the marker symbol
#lines.markersize : 6 # markersize, in points
#lines.dash_joinstyle : miter # miter|round|bevel
#lines.dash_capstyle : butt # butt|round|projecting
#lines.solid_joinstyle : miter # miter|round|bevel
#lines.solid_capstyle : projecting # butt|round|projecting
#lines.antialiased : True # render lines in antialiased (no jaggies)

# The three standard dash patterns. These are scaled by the linewidth.
#lines.dashed_pattern : 2.8, 1.2
#lines.dashdot_pattern : 4.8, 1.2, 0.8, 1.2
#lines.dotted_pattern : 1.1, 1.1
#lines.scale_dashes : True

#markers.fillstyle: full # full|left|right|bottom|top|none

### PATCHES
# Patches are graphical objects that fill 2D space, like polygons or
# circles. See
# http://matplotlib.org/api/artist\_api.html#module-matplotlib.patches

```

```
# information on patch properties
#patch.linewidth      : 1      # edge width in points.
#patch.facecolor     : C0
#patch.edgecolor     : black  # if forced, or patch is not filled
#patch.force_edgecolor : False # True to always use edgecolor
#patch.antialiased   : True   # render patches in antialiased (no jaggies)

### HATCHES
#hatch.color         : k
#hatch.linewidth    : 1.0

### Boxplot
#boxplot.notch      : False
#boxplot.vertical   : True
#boxplot.whiskers   : 1.5
#boxplot.bootstrap : None
#boxplot.patchartist : False
#boxplot.showmeans  : False
#boxplot.showcaps   : True
#boxplot.showbox    : True
#boxplot.showfliers : True
#boxplot.meanline   : False

#boxplot.flierprops.color      : 'k'
#boxplot.flierprops.marker     : 'o'
#boxplot.flierprops.markerfacecolor : 'none'
#boxplot.flierprops.markeredgecolor : 'k'
#boxplot.flierprops.markersize  : 6
#boxplot.flierprops.linestyle   : 'none'
#boxplot.flierprops.linewidth   : 1.0

#boxplot.boxprops.color      : 'k'
#boxplot.boxprops.linewidth  : 1.0
#boxplot.boxprops.linestyle  : '-'

#boxplot.whiskerprops.color   : 'k'
#boxplot.whiskerprops.linewidth : 1.0
#boxplot.whiskerprops.linestyle : '-'

#boxplot.capprops.color      : 'k'
#boxplot.capprops.linewidth  : 1.0
#boxplot.capprops.linestyle  : '-'

#boxplot.medianprops.color   : 'C1'
#boxplot.medianprops.linewidth : 1.0
#boxplot.medianprops.linestyle : '-'

#boxplot.meanprops.color     : 'C2'
#boxplot.meanprops.marker    : '^'
#boxplot.meanprops.markerfacecolor : 'C2'
#boxplot.meanprops.markeredgecolor : 'C2'
#boxplot.meanprops.markersize  : 6
#boxplot.meanprops.linestyle  : 'none'
```



```

#boxplot.meanprops.linewidth      : 1.0

### FONT
#
# font properties used by text.Text.  See
# http://matplotlib.org/api/font\_manager\_api.html for more
# information on font properties.  The 6 font properties used for font
# matching are given below with their default values.
#
# The font.family property has five values: 'serif' (e.g., Times),
# 'sans-serif' (e.g., Helvetica), 'cursive' (e.g., Zapf-Chancery),
# 'fantasy' (e.g., Western), and 'monospace' (e.g., Courier).  Each of
# these font families has a default list of font names in decreasing
# order of priority associated with them.  When text.usetex is False,
# font.family may also be one or more concrete font names.
#
# The font.style property has three values: normal (or roman), italic
# or oblique.  The oblique style will be used for italic, if it is not
# present.
#
# The font.variant property has two values: normal or small-caps.  For
# TrueType fonts, which are scalable fonts, small-caps is equivalent
# to using a font size of 'smaller', or about 83%% of the current font
# size.
#
# The font.weight property has effectively 13 values: normal, bold,
# bolder, lighter, 100, 200, 300, ..., 900.  Normal is the same as
# 400, and bold is 700.  bolder and lighter are relative values with
# respect to the current weight.
#
# The font.stretch property has 11 values: ultra-condensed,
# extra-condensed, condensed, semi-condensed, normal, semi-expanded,
# expanded, extra-expanded, ultra-expanded, wider, and narrower.  This
# property is not currently implemented.
#
# The font.size property is the default font size for text, given in pts.
# 10 pt is the standard value.
#
#font.family      : sans-serif
#font.style       : normal
#font.variant     : normal
#font.weight      : medium
#font.stretch     : normal
# note that font.size controls default text sizes.  To configure
# special text sizes tick labels, axes, labels, title, etc, see the rc
# settings for axes and ticks.  Special text sizes can be defined
# relative to font.size, using the following values: xx-small, x-small,
# small, medium, large, x-large, xx-large, larger, or smaller
#font.size        : 10.0
#font.serif       : DejaVu Serif, Bitstream Vera Serif, New Century Schoolbook,
↳Century Schoolbook L, Utopia, ITC Bookman, Bookman, Nimbus Roman No9 L, Times New
↳Roman, Times, Palatino, Charter, serif
#font.sans-serif  : DejaVu Sans, Bitstream Vera Sans, Lucida Grande, Verdana, Geneva,
↳Lucid, Arial, Helvetica, Avant Garde, sans-serif

```

```

#font.cursive      : Apple Chancery, Textile, Zapf Chancery, Sand, Script MT, Felipa,
↳cursive
#font.fantasy      : Comic Sans MS, Chicago, Charcoal, Impact, Western, Humor Sans,
↳xkcd, fantasy
#font.monospace    : DejaVu Sans Mono, Bitstream Vera Sans Mono, Andale Mono, Nimbus,
↳Mono L, Courier New, Courier, Fixed, Terminal, monospace

### TEXT
# text properties used by text.Text. See
# http://matplotlib.org/api/artist_api.html#module-matplotlib.text for more
# information on text properties

#text.color        : black

### LaTeX customizations. See http://wiki.scipy.org/Cookbook/Matplotlib/UsingTex
#text.usetex       : False # use latex for all text handling. The following fonts
# are supported through the usual rc parameter settings:
# new century schoolbook, bookman, times, palatino,
# zapf chancery, charter, serif, sans-serif, helvetica,
# avant garde, courier, monospace, computer modern roman,
# computer modern sans serif, computer modern typewriter
# If another font is desired which can loaded using the
# LaTeX \usepackage command, please inquire at the
# matplotlib mailing list

#text.latex.unicode : False # use "ucs" and "inputenc" LaTeX packages for handling
# unicode strings.

#text.latex.preamble : # IMPROPER USE OF THIS FEATURE WILL LEAD TO LATEX FAILURES
# AND IS THEREFORE UNSUPPORTED. PLEASE DO NOT ASK FOR HELP
# IF THIS FEATURE DOES NOT DO WHAT YOU EXPECT IT TO.
# preamble is a comma separated list of LaTeX statements
# that are included in the LaTeX document preamble.
# An example:
# text.latex.preamble : \usepackage{bm},\usepackage{euler}
# The following packages are always loaded with usetex, so
# beware of package collisions: color, geometry, graphicx,
# type1cm, textcomp. Adobe Postscript (PSSNFS) font packages
# may also be loaded, depending on your font settings

#text.dvipnghack : None # some versions of dvipng don't handle alpha
# channel properly. Use True to correct
# and flush ~/.matplotlib/tex.cache
# before testing and False to force
# correction off. None will try and
# guess based on your dvipng version

#text.hinting : auto # May be one of the following:
# 'none': Perform no hinting
# 'auto': Use FreeType's autohinter
# 'native': Use the hinting information in the
# font file, if available, and if your
# FreeType library supports it
# 'either': Use the native hinting information,
# or the autohinter if none is available.

```

```

        # For backward compatibility, this value may also be
        # True == 'auto' or False == 'none'.
#text.hinting_factor : 8 # Specifies the amount of softness for hinting in the
        # horizontal direction. A value of 1 will hint to full
        # pixels. A value of 2 will hint to half pixels etc.

#text.antialiased : True # If True (default), the text will be antialiased.
        # This only affects the Agg backend.

# The following settings allow you to select the fonts in math mode.
# They map from a TeX font name to a fontconfig font pattern.
# These settings are only used if mathtext.fontset is 'custom'.
# Note that this "custom" mode is unsupported and may go away in the
# future.
#mathtext.cal : cursive
#mathtext.rm : serif
#mathtext.tt : monospace
#mathtext.it : serif:italic
#mathtext.bf : serif:bold
#mathtext.sf : sans
#mathtext.fontset : dejavusans # Should be 'dejavusans' (default),
        # 'dejavuserif', 'cm' (Computer Modern), 'stix',
        # 'stixsans' or 'custom'
#mathtext.fallback_to_cm : True # When True, use symbols from the Computer Modern
        # fonts when a symbol can not be found in one of
        # the custom math fonts.

#mathtext.default : it # The default font to use for math.
        # Can be any of the LaTeX font names, including
        # the special name "regular" for the same font
        # used in regular text.

### AXES
# default face and edge color, default tick sizes,
# default fontsizes for ticklabels, and so on. See
# http://matplotlib.org/api/axes\_api.html#module-matplotlib.axes
#axes.facecolor : white # axes background color
#axes.edgecolor : black # axes edge color
#axes.linewidth : 0.8 # edge linewidth
#axes.grid : False # display grid or not
#axes.titlesize : large # fontsize of the axes title
#axes.titlepad : 6.0 # pad between axes and title in points
#axes.labelsize : medium # fontsize of the x any y labels
#axes.labelpad : 4.0 # space between label and axis
#axes.labelweight : normal # weight of the x and y labels
#axes.labelcolor : black
#axes.axisbelow : 'line' # draw axis gridlines and ticks below
        # patches (True); above patches but below
        # lines ('line'); or above all (False)

#axes.formatter.limits : -7, 7 # use scientific notation if log10
        # of the axis range is smaller than the
        # first or larger than the second

```

```

#axes.formatter.use_locale : False # When True, format tick labels
#                               # according to the user's locale.
#                               # For example, use ',' as a decimal
#                               # separator in the fr_FR locale.
#axes.formatter.use_mathtext : False # When True, use mathtext for scientific
#                                   # notation.
#axes.formatter.useoffset      : True  # If True, the tick label formatter
#                                   # will default to labeling ticks relative
#                                   # to an offset when the data range is
#                                   # small compared to the minimum absolute
#                                   # value of the data.
#axes.formatter.offset_threshold : 4  # When useoffset is True, the offset
#                                   # will be used when it can remove
#                                   # at least this number of significant
#                                   # digits from tick labels.

# axes.spines.left      : True  # display axis spines
# axes.spines.bottom   : True
# axes.spines.top      : True
# axes.spines.right    : True

#axes.unicode_minus      : True     # use unicode for the minus symbol
#                               # rather than hyphen. See
#                               # http://en.wikipedia.org/wiki/Plus\_and\_minus\_signs

↪#Character_codes
#axes.prop_cycle         : cycler('color',
#                               ['1f77b4', 'ff7f0e', '2ca02c', 'd62728',
#                               '9467bd', '8c564b', 'e377c2', '7f7f7f',
#                               'bcbd22', '17becf])
#                               # color cycle for plot lines
#                               # as list of string colorspecs:
#                               # single letter, long name, or
#                               # web-style hex
#axes.autolimit_mode    : data     # How to scale axes limits to the data.
#                               # Use "data" to use data limits, plus some margin
#                               # Use "round_number" move to the nearest "round" number
#axes.xmargin           : .05     # x margin. See `axes.Axes.margins`
#axes.ymargin           : .05     # y margin See `axes.Axes.margins`

#polaraxes.grid        : True     # display grid on polar axes
#axes3d.grid            : True     # display grid on 3d axes

### DATES
# These control the default format strings used in AutoDateFormatter.
# Any valid format datetime format string can be used (see the python
# `datetime` for details). For example using '%x' will use the locale date representation
# '%X' will use the locale time representation and '%c' will use the full locale datetime
# representation.
# These values map to the scales:
# { 'year': 365, 'month': 30, 'day': 1, 'hour': 1/24, 'minute': 1 / (24 * 60)}

# date.autoformatter.year : %Y

```

```

# date.autoformatter.month      : %Y-%m
# date.autoformatter.day       : %Y-%m-%d
# date.autoformatter.hour      : %m-%d %H
# date.autoformatter.minute    : %d %H:%M
# date.autoformatter.second    : %H:%M:%S
# date.autoformatter.microsecond : %M:%S.%f

### TICKS
# see http://matplotlib.org/api/axis\_api.html#matplotlib.axis.Tick
#xtick.top      : False # draw ticks on the top side
#xtick.bottom   : True  # draw ticks on the bottom side
#xtick.major.size : 3.5 # major tick size in points
#xtick.minor.size : 2   # minor tick size in points
#xtick.major.width : 0.8 # major tick width in points
#xtick.minor.width : 0.6 # minor tick width in points
#xtick.major.pad  : 3.5 # distance to major tick label in points
#xtick.minor.pad  : 3.4 # distance to the minor tick label in points
#xtick.color      : k   # color of the tick labels
#xtick.labelsize  : medium # fontsize of the tick labels
#xtick.direction  : out  # direction: in, out, or inout
#xtick.minor.visible : False # visibility of minor ticks on x-axis
#xtick.major.top   : True # draw x axis top major ticks
#xtick.major.bottom : True # draw x axis bottom major ticks
#xtick.minor.top   : True # draw x axis top minor ticks
#xtick.minor.bottom : True # draw x axis bottom minor ticks

#ytick.left     : True  # draw ticks on the left side
#ytick.right    : False # draw ticks on the right side
#ytick.major.size : 3.5 # major tick size in points
#ytick.minor.size : 2   # minor tick size in points
#ytick.major.width : 0.8 # major tick width in points
#ytick.minor.width : 0.6 # minor tick width in points
#ytick.major.pad  : 3.5 # distance to major tick label in points
#ytick.minor.pad  : 3.4 # distance to the minor tick label in points
#ytick.color      : k   # color of the tick labels
#ytick.labelsize  : medium # fontsize of the tick labels
#ytick.direction  : out  # direction: in, out, or inout
#ytick.minor.visible : False # visibility of minor ticks on y-axis
#ytick.major.left  : True # draw y axis left major ticks
#ytick.major.right : True # draw y axis right major ticks
#ytick.minor.left  : True # draw y axis left minor ticks
#ytick.minor.right : True # draw y axis right minor ticks

### GRIDS
#grid.color      : b0b0b0 # grid color
#grid.linestyle  : -      # solid
#grid.linewidth  : 0.8    # in points
#grid.alpha      : 1.0    # transparency, between 0.0 and 1.0

### Legend
#legend.loc      : best
#legend.frameon  : True   # if True, draw the legend on a background patch

```

```

#legend.framealpha      : 0.8      # legend patch transparency
#legend.facecolor      : inherit   # inherit from axes.facecolor; or color spec
#legend.edgecolor      : 0.8      # background patch boundary color
#legend.fancybox       : True      # if True, use a rounded box for the
#                           # legend background, else a rectangle
#legend.shadow         : False     # if True, give background a shadow effect
#legend.numpoints      : 1        # the number of marker points in the legend line
#legend.scatterpoints  : 1        # number of scatter points
#legend.markerscale    : 1.0      # the relative size of legend markers vs. original
#legend.fontsize       : medium
# Dimensions as fraction of fontsize:
#legend.borderpad      : 0.4      # border whitespace
#legend.labelspacing   : 0.5      # the vertical space between the legend entries
#legend.handlelength   : 2.0      # the length of the legend lines
#legend.handleheight   : 0.7      # the height of the legend handle
#legend.handletextpad  : 0.8      # the space between the legend line and legend text
#legend.borderaxespac  : 0.5      # the border between the axes and legend edge
#legend.columnspacing  : 2.0      # column separation

### FIGURE
# See http://matplotlib.org/api/figure\_api.html#matplotlib.figure.Figure
#figure.titlesize      : large     # size of the figure title (Figure.suptitle())
#figure.titleweight    : normal    # weight of the figure title
#figure.figsize        : 6.4, 4.8  # figure size in inches
#figure.dpi            : 100       # figure dots per inch
#figure.facecolor      : white     # figure facecolor; 0.75 is scalar gray
#figure.edgecolor      : white     # figure edgecolor
#figure.autolayout     : False     # When True, automatically adjust subplot
#                           # parameters to make the plot fit the figure
#figure.max_open_warning : 20     # The maximum number of figures to open through
#                           # the pyplot interface before emitting a warning.
#                           # If less than one this feature is disabled.

# The figure subplot parameters. All dimensions are a fraction of the
#figure.subplot.left    : 0.125    # the left side of the subplots of the figure
#figure.subplot.right   : 0.9      # the right side of the subplots of the figure
#figure.subplot.bottom  : 0.11     # the bottom of the subplots of the figure
#figure.subplot.top     : 0.88     # the top of the subplots of the figure
#figure.subplot.wspace  : 0.2      # the amount of width reserved for blank space between
↳subplots,
#                           # expressed as a fraction of the average axis width
#figure.subplot.hspace  : 0.2      # the amount of height reserved for white space between
↳subplots,
#                           # expressed as a fraction of the average axis height

### IMAGES
#image.aspect          : equal      # equal | auto | a number
#image.interpolation   : nearest    # see help(imshow) for options
#image.cmap            : viridis    # A colormap name, gray etc...
#image.lut             : 256        # the size of the colormap lookup table
#image.origin          : upper      # lower | upper
#image.resample        : True

```

```

#image.composite_image : True      # When True, all the images on a set of axes are
                                     # combined into a single composite image before
                                     # saving a figure as a vector graphics file,
                                     # such as a PDF.

### CONTOUR PLOTS
#contour.negative_linestyle : dashed # dashed | solid
#contour.corner_mask       : True   # True | False | legacy

### ERRORBAR PLOTS
#errorbar.capsize : 0              # length of end cap on error bars in pixels

### HISTOGRAM PLOTS
#hist.bins : 10                   # The default number of histogram bins.
                                     # If Numpy 1.11 or later is
                                     # installed, may also be `auto`

### SCATTER PLOTS
#scatter.marker : 0               # The default marker type for scatter plots.

### Agg rendering
### Warning: experimental, 2008/10/10
#agg.path.chunksize : 0           # 0 to disable; values in the range
                                     # 10000 to 100000 can improve speed slightly
                                     # and prevent an Agg rendering failure
                                     # when plotting very large data sets,
                                     # especially if they are very gappy.
                                     # It may cause minor artifacts, though.
                                     # A value of 20000 is probably a good
                                     # starting point.

### SAVING FIGURES
#path.simplify : True            # When True, simplify paths by removing "invisible"
                                     # points to reduce file size and increase rendering
                                     # speed
#path.simplify_threshold : 0.1   # The threshold of similarity below which
                                     # vertices will be removed in the simplification
                                     # process
#path.snap : True               # When True, rectilinear axis-aligned paths will be snapped to
                                     # the nearest pixel when certain criteria are met. When False,
                                     # paths will never be snapped.
#path.sketch : None             # May be none, or a 3-tuple of the form (scale, length,
                                     # randomness).
                                     # *scale* is the amplitude of the wiggle
                                     # perpendicular to the line (in pixels). *length*
                                     # is the length of the wiggle along the line (in
                                     # pixels). *randomness* is the factor by which
                                     # the length is randomly scaled.

# the default savefig params can be different from the display params
# e.g., you may want a higher resolution, or to make the figure
# background white
#savefig.dpi      : figure      # figure dots per inch or 'figure'
#savefig.facecolor : white      # figure facecolor when saving

```



```

#savefig.edgecolor : white # figure edgecolor when saving
#savefig.format : png # png, ps, pdf, svg
#savefig.bbox : standard # 'tight' or 'standard'.
# 'tight' is incompatible with pipe-based animation
# backends but will workd with temporary file based ones:
# e.g. setting animation.writer to ffmpeg will not work,
# use ffmpeg_file instead
#savefig.pad_inches : 0.1 # Padding to be used when bbox is set to 'tight'
#savefig.jpeg_quality: 95 # when a jpeg is saved, the default quality parameter.
#savefig.directory : ~ # default directory in savefig dialog box,
# leave empty to always use current working directory
#savefig.transparent : False # setting that controls whether figures are saved with a
# transparent background by default

# tk backend params
#tk.window_focus : False # Maintain shell focus for TkAgg

# ps backend params
#ps.papersize : letter # auto, letter, legal, ledger, A0-A10, B0-B10
#ps.useafm : False # use of afm fonts, results in small files
#ps.usedistiller : False # can be: None, ghostscript or xpdf
# Experimental: may produce smaller files.
# xpdf intended for production of publication_
quality files,
# but requires ghostscript, xpdf and ps2eps

#ps.distiller.res : 6000 # dpi
#ps.fonttype : 3 # Output Type 3 (Type3) or Type 42 (TrueType)

# pdf backend params
#pdf.compression : 6 # integer from 0 to 9
# 0 disables compression (good for debugging)
#pdf.fonttype : 3 # Output Type 3 (Type3) or Type 42 (TrueType)

# svg backend params
#svg.image_inline : True # write raster image data directly into the svg file
#svg.fonttype : 'path' # How to handle SVG fonts:
# 'none': Assume fonts are installed on the machine where the SVG will be viewed.
# 'path': Embed characters as paths -- supported by most SVG renderers
# 'svgfont': Embed characters as SVG fonts -- supported only by Chrome,
# Opera and Safari
#svg.hashsalt : None # if not None, use this string as hash salt
# instead of uuid4

# docstring params
#docstring.hardcopy = False # set this when you want to generate hardcopy docstring

# Set the verbose flags. This controls how much information
# matplotlib gives you at runtime and where it goes. The verbosity
# levels are: silent, helpful, debug, debug-annoying. Any level is
# inclusive of all the levels below it. If your setting is "debug",
# you'll get all the debug and helpful messages. When submitting
# problems to the mailing-list, please set verbose to "helpful" or "debug"
# and paste the output into your report.

```



```

#
# The "fileo" gives the destination for any calls to verbose.report.
# These objects can a filename, or a filehandle like sys.stdout.
#
# You can override the rc default verbosity from the command line by
# giving the flags --verbose-LEVEL where LEVEL is one of the legal
# levels, e.g., --verbose-helpful.
#
# You can access the verbose instance in your code
# from matplotlib import verbose.
#verbose.level : silent      # one of silent, helpful, debug, debug-annoying
#verbose.fileo : sys.stdout # a log filename, sys.stdout or sys.stderr

# Event keys to interact with figures/plots via keyboard.
# Customize these settings according to your needs.
# Leave the field(s) empty if you don't need a key-map. (i.e., fullscreen : ")

#keymap.fullscreen : f, ctrl+f      # toggling
#keymap.home : h, r, home           # home or reset mnemonic
#keymap.back : left, c, backspace   # forward / backward keys to enable
#keymap.forward : right, v          # left handed quick navigation
#keymap.pan : p                      # pan mnemonic
#keymap.zoom : o                    # zoom mnemonic
#keymap.save : s                    # saving current figure
#keymap.quit : ctrl+w, cmd+w        # close the current figure
#keymap.grid : g                    # switching on/off a grid in current axes
#keymap.yscale : l                  # toggle scaling of y-axes ('log'/'linear')
#keymap.xscale : L, k               # toggle scaling of x-axes ('log'/'linear')
#keymap.all_axes : a                # enable all axes

# Control location of examples data files
#examples.directory : " # directory to look in for custom installation

###ANIMATION settings
#animation.html : 'none'             # How to display the animation as HTML in
                                     # the IPython notebook. 'html5' uses
                                     # HTML5 video tag.
#animation.writer : ffmpeg           # MovieWriter 'backend' to use
#animation.codec : h264              # Codec to use for writing movie
#animation.bitrate: -1               # Controls size/quality tradeoff for movie.
                                     # -1 implies let utility auto-determine
#animation.frame_format: 'png'       # Controls frame format used by temp files
#animation.ffmpeg_path: 'ffmpeg'    # Path to ffmpeg binary. Without full path
                                     # $PATH is searched
#animation.ffmpeg_args: "           # Additional arguments to pass to ffmpeg
#animation.avconv_path: 'avconv'    # Path to avconv binary. Without full path
                                     # $PATH is searched
#animation.avconv_args: "           # Additional arguments to pass to avconv
#animation.mencoder_path: 'mencoder'
                                     # Path to mencoder binary. Without full path
                                     # $PATH is searched
#animation.mencoder_args: "         # Additional arguments to pass to mencoder
#animation.convert_path: 'convert'  # Path to ImageMagick's convert binary.

```

```
# On Windows use the full path since convert  
# is also the name of a system tool.
```

INTERACTIVE PLOTS

7.1 Interactive navigation



All figure windows come with a navigation toolbar, which can be used to navigate through the data set. Here is a description of each of the buttons at the bottom of the toolbar



The Home, Forward and Back buttons These are akin to a web browser's home, forward and back controls. Forward and Back are used to navigate back and forth between previously defined views. They have no meaning unless you have already navigated somewhere else using the pan and zoom buttons. This is analogous to trying to click Back on your web browser before visiting a new page or Forward before you have gone back to a page – nothing happens. Home always takes you to the first, default view of your data. Again, all of these buttons should feel very familiar to any user of a web browser.

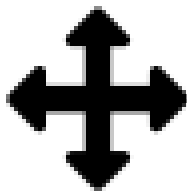

The Pan/Zoom button This button has two modes: pan and zoom. Click the toolbar button to activate panning and zooming, then put your mouse somewhere over an axes. Press the left mouse button and hold it to pan the figure, dragging it to a new position. When you release it, the data under the point where you pressed will be moved to the point where you released. If you press ‘x’ or ‘y’ while panning the motion will be constrained to the x or y axis, respectively. Press the right mouse button to zoom, dragging it to a new position. The x axis will be zoomed in proportionately to the rightward movement and zoomed out proportionately to the leftward movement. The same is true for the y axis and up/down motions. The point under your mouse when you begin the zoom remains stationary, allowing you to zoom in or out around that point as much as you wish. You can use the modifier keys ‘x’, ‘y’ or ‘CONTROL’ to constrain the zoom to the x axis, the y axis, or aspect ratio preserve, respectively.

With polar plots, the pan and zoom functionality behaves differently. The radius axis labels can be dragged using the left mouse button. The radius scale can be zoomed in and out using the right mouse button.



The Zoom-to-rectangle button Click this toolbar button to activate this mode. Put your mouse somewhere over an axes and press the left mouse button. Drag the mouse while holding the button to a new location and release. The axes view limits will be zoomed to the rectangle you have defined. There is also an experimental ‘zoom out to rectangle’ in this mode with the right button, which will place your entire axes in the region defined by the zoom out rectangle.

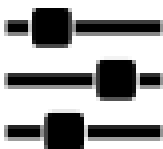

The Subplot-configuration button Use this tool to configure the appearance of the subplot: you can stretch or compress the left, right, top, or bottom side of the subplot, or the space between the rows or space between the columns.



The Save button Click this button to launch a file save dialog. You can save files with the following extensions: png, ps, eps, svg and pdf.

7.1.1 Navigation Keyboard Shortcuts

The following table holds all the default keys, which can be overwritten by use of your matplotlibrc (#keymap.*).

Command	Keyboard Shortcut(s)
Home/Reset	h or r or home
Back	c or left arrow or backspace
Forward	v or right arrow
Pan/Zoom	p
Zoom-to-rect	o
Save	ctrl + s
Toggle fullscreen	f or ctrl + f
Close plot	ctrl + w
Constrain pan/zoom to x axis	hold x when panning/zooming with mouse
Constrain pan/zoom to y axis	hold y when panning/zooming with mouse
Preserve aspect ratio	hold CONTROL when panning/zooming with mouse
Toggle grid	g when mouse is over an axes
Toggle x axis scale (log/linear)	L or k when mouse is over an axes
Toggle y axis scale (log/linear)	l when mouse is over an axes

If you are using `matplotlib.pyplot` the toolbar will be created automatically for every figure. If you are writing your own user interface code, you can add the toolbar as a widget. The exact syntax depends on your UI, but we have examples for every supported UI in the `matplotlib/examples/user_interfaces` directory. Here is some example code for GTK:

```
import gtk

from matplotlib.figure import Figure
from matplotlib.backends.backend_gtkagg import FigureCanvasGTKAgg as FigureCanvas
from matplotlib.backends.backend_gtkagg import NavigationToolbar2GTKAgg as
↳NavigationToolbar

win = gtk.Window()
win.connect("destroy", lambda x: gtk.main_quit())
win.set_default_size(400,300)
win.set_title("Embedding in GTK")

vbox = gtk.VBox()
win.add(vbox)

fig = Figure(figsize=(5,4), dpi=100)
ax = fig.add_subplot(111)
ax.plot([1,2,3])

canvas = FigureCanvas(fig) # a gtk.DrawingArea
vbox.pack_start(canvas)
```

```
toolbar = NavigationToolbar(canvas, win)
vbox.pack_start(toolbar, False, False)

win.show_all()
gtk.main()
```

7.2 Using matplotlib in a python shell

Warning: This page is significantly out of date

By default, matplotlib defers drawing until the end of the script because drawing can be an expensive operation, and you may not want to update the plot every time a single property is changed, only once after all the properties have changed.

But when working from the python shell, you usually do want to update the plot with every command, e.g., after changing the `xlabel()`, or the marker style of a line. While this is simple in concept, in practice it can be tricky, because matplotlib is a graphical user interface application under the hood, and there are some tricks to make the applications work right in a python shell.

7.2.1 IPython to the rescue

Note: The mode described here still exists for historical reasons, but it is highly advised not to use. It pollutes namespaces with functions that will shadow python built-in and can lead to hard to track bugs. To get IPython integration without imports the use of the `%matplotlib` magic is preferred. See [ipython documentation](#).

Fortunately, `ipython`, an enhanced interactive python shell, has figured out all of these tricks, and is matplotlib aware, so when you start `ipython` in the `pylab` mode.

```
johnh@flag:~> ipython
Python 2.4.5 (#4, Apr 12 2008, 09:09:16)
IPython 0.9.0 -- An enhanced Interactive Python.

In [1]: %pylab

Welcome to pylab, a matplotlib-based Python environment.
For more information, type 'help(pylab)'.

In [2]: x = randn(10000)

In [3]: hist(x, 100)
```

it sets everything up for you so interactive plotting works as you would expect it to. Call `figure()` and a figure window pops up, call `plot()` and your data appears in the figure window.

Note in the example above that we did not import any matplotlib names because in pylab mode, ipython will import them automatically. ipython also turns on *interactive* mode for you, which causes every pyplot command to trigger a figure update, and also provides a matplotlib aware run command to run matplotlib scripts efficiently. ipython will turn off interactive mode during a run command, and then restore the interactive state at the end of the run so you can continue tweaking the figure manually.

There has been a lot of recent work to embed ipython, with pylab support, into various GUI applications, so check on the ipython mailing [list](#) for the latest status.

7.2.2 Other python interpreters

If you can't use ipython, and still want to use matplotlib/pylab from an interactive python shell, e.g., the plain-ole standard python interactive interpreter, you are going to need to understand what a matplotlib backend is *What is a backend?*.

With the TkAgg backend, which uses the Tkinter user interface toolkit, you can use matplotlib from an arbitrary non-gui python shell. Just set your backend : TkAgg and interactive : True in your matplotlibrc file (see *Customizing matplotlib*) and fire up python. Then:

```
>>> from pylab import *
>>> plot([1,2,3])
>>> xlabel('hi mom')
```

should work out of the box. This is also likely to work with recent versions of the qt4agg and gtkagg backends, and with the macosx backend on the Macintosh. Note, in batch mode, i.e. when making figures from scripts, interactive mode can be slow since it redraws the figure with each command. So you may want to think carefully before making this the default behavior via the matplotlibrc file instead of using the functions listed in the next section.

Gui shells are at best problematic, because they have to run a mainloop, but interactive plotting also involves a mainloop. Ipython has sorted all this out for the primary matplotlib backends. There may be other shells and IDEs that also work with matplotlib in interactive mode, but one obvious candidate does not: the python IDLE IDE is a Tkinter gui app that does not support pylab interactive mode, regardless of backend.

7.2.3 Controlling interactive updating

The *interactive* property of the pyplot interface controls whether a figure canvas is drawn on every pyplot command. If *interactive* is *False*, then the figure state is updated on every plot command, but will only be drawn on explicit calls to *draw()*. When *interactive* is *True*, then every pyplot command triggers a draw.

The pyplot interface provides 4 commands that are useful for interactive control.

isinteractive() returns the interactive setting *True|False*

ion() turns interactive mode on

ioff() turns interactive mode off

draw() forces a figure redraw

When working with a big figure in which drawing is expensive, you may want to turn matplotlib's interactive setting off temporarily to avoid the performance hit:

```
>>> #create big-expensive-figure
>>> ioff()      # turn updates off
>>> title('now how much would you pay?')
>>> xticklabels(fontsize=20, color='green')
>>> draw()     # force a draw
>>> savefig('alldone', dpi=300)
>>> close()
>>> ion()      # turn updating back on
>>> plot(rand(20), mfc='g', mec='r', ms=40, mew=4, ls='--', lw=3)
```

7.3 Event handling and picking

matplotlib works with a number of user interface toolkits (wxpython, tkinter, qt4, gtk, and macosx) and in order to support features like interactive panning and zooming of figures, it is helpful to the developers to have an API for interacting with the figure via key presses and mouse movements that is “GUI neutral” so we don't have to repeat a lot of code across the different user interfaces. Although the event handling API is GUI neutral, it is based on the GTK model, which was the first user interface matplotlib supported. The events that are triggered are also a bit richer vis-a-vis matplotlib than standard GUI events, including information like which `matplotlib.axes.Axes` the event occurred in. The events also understand the matplotlib coordinate system, and report event locations in both pixel and data coordinates.

7.3.1 Event connections

To receive events, you need to write a callback function and then connect your function to the event manager, which is part of the `FigureCanvasBase`. Here is a simple example that prints the location of the mouse click and which button was pressed:

```
fig = plt.figure()
ax = fig.add_subplot(111)
ax.plot(np.random.rand(10))

def onclick(event):
    print('button=%d, x=%d, y=%d, xdata=%f, ydata=%f' %
          (event.button, event.x, event.y, event.xdata, event.ydata))

cid = fig.canvas.mpl_connect('button_press_event', onclick)
```

The `FigureCanvas` method `mpl_connect()` returns a connection id which is simply an integer. When you want to disconnect the callback, just call:

```
fig.canvas.mpl_disconnect(cid)
```

Note: The canvas retains only weak references to the callbacks. Therefore if a callback is a method of

a class instance, you need to retain a reference to that instance. Otherwise the instance will be garbage-collected and the callback will vanish.

Here are the events that you can connect to, the class instances that are sent back to you when the event occurs, and the event descriptions

Event name	Class and description
'button_press_event'	<i>MouseEvent</i> - mouse button is pressed
'button_release_event'	<i>MouseEvent</i> - mouse button is released
'draw_event'	<i>DrawEvent</i> - canvas draw
'key_press_event'	<i>KeyEvent</i> - key is pressed
'key_release_event'	<i>KeyEvent</i> - key is released
'motion_notify_event'	<i>MouseEvent</i> - mouse motion
'pick_event'	<i>PickEvent</i> - an object in the canvas is selected
'resize_event'	<i>ResizeEvent</i> - figure canvas is resized
'scroll_event'	<i>MouseEvent</i> - mouse scroll wheel is rolled
'figure_enter_event'	<i>LocationEvent</i> - mouse enters a new figure
'figure_leave_event'	<i>LocationEvent</i> - mouse leaves a figure
'axes_enter_event'	<i>LocationEvent</i> - mouse enters a new axes
'axes_leave_event'	<i>LocationEvent</i> - mouse leaves an axes

7.3.2 Event attributes

All matplotlib events inherit from the base class `matplotlib.backend_bases.Event`, which store the attributes:

name the event name

canvas the FigureCanvas instance generating the event

guiEvent the GUI event that triggered the matplotlib event

The most common events that are the bread and butter of event handling are key press/release events and mouse press/release and movement events. The *KeyEvent* and *MouseEvent* classes that handle these events are both derived from the *LocationEvent*, which has the following attributes

x x position - pixels from left of canvas

y y position - pixels from bottom of canvas

inaxes the *Axes* instance if mouse is over axes

xdata x coord of mouse in data coords

ydata y coord of mouse in data coords

Let's look a simple example of a canvas, where a simple line segment is created every time a mouse is pressed:

```
from matplotlib import pyplot as plt

class LineBuilder:
```

```

def __init__(self, line):
    self.line = line
    self.xs = list(line.get_xdata())
    self.ys = list(line.get_ydata())
    self.cid = line.figure.canvas.mpl_connect('button_press_event', self)

def __call__(self, event):
    print('click', event)
    if event.inaxes!=self.line.axes: return
    self.xs.append(event.xdata)
    self.ys.append(event.ydata)
    self.line.set_data(self.xs, self.ys)
    self.line.figure.canvas.draw()

fig = plt.figure()
ax = fig.add_subplot(111)
ax.set_title('click to build line segments')
line, = ax.plot([0], [0]) # empty line
linebuilder = LineBuilder(line)

plt.show()

```

The `MouseEvent` that we just used is a `MouseEvent`, so we have access to the data and pixel coordinates in `event.x` and `event.xdata`. In addition to the `MouseEvent` attributes, it has

button button pressed: None, 1, 2, 3, 'up', 'down' (up and down are used for scroll events)

key the key pressed: None, any character, 'shift', 'win', or 'control'

Draggable rectangle exercise

Write a draggable rectangle class that is initialized with a `Rectangle` instance but will move its x,y location when dragged. Hint: you will need to store the original xy location of the rectangle which is stored as `rect.xy` and connect to the press, motion and release mouse events. When the mouse is pressed, check to see if the click occurs over your rectangle (see `matplotlib.patches.Rectangle.contains()`) and if it does, store the rectangle xy and the location of the mouse click in data coords. In the motion event callback, compute the `deltax` and `deltay` of the mouse movement, and add those deltas to the origin of the rectangle you stored. Redraw the figure. On the button release event, just reset all the button press data you stored as `None`.

Here is the solution:

```

import numpy as np
import matplotlib.pyplot as plt

class DraggableRectangle:
    def __init__(self, rect):
        self.rect = rect
        self.press = None

    def connect(self):
        'connect to all the events we need'

```

```

self.cidpress = self.rect.figure.canvas.mpl_connect(
    'button_press_event', self.on_press)
self.cidrelease = self.rect.figure.canvas.mpl_connect(
    'button_release_event', self.on_release)
self.cidmotion = self.rect.figure.canvas.mpl_connect(
    'motion_notify_event', self.on_motion)

def on_press(self, event):
    'on button press we will see if the mouse is over us and store some data'
    if event.inaxes != self.rect.axes: return

    contains, attrd = self.rect.contains(event)
    if not contains: return
    print('event contains', self.rect.xy)
    x0, y0 = self.rect.xy
    self.press = x0, y0, event.xdata, event.ydata

def on_motion(self, event):
    'on motion we will move the rect if the mouse is over us'
    if self.press is None: return
    if event.inaxes != self.rect.axes: return
    x0, y0, xpress, ypress = self.press
    dx = event.xdata - xpress
    dy = event.ydata - ypress
    #print('x0=%f, xpress=%f, event.xdata=%f, dx=%f, x0+dx=%f' %
    #      (x0, xpress, event.xdata, dx, x0+dx))
    self.rect.set_x(x0+dx)
    self.rect.set_y(y0+dy)

    self.rect.figure.canvas.draw()

def on_release(self, event):
    'on release we reset the press data'
    self.press = None
    self.rect.figure.canvas.draw()

def disconnect(self):
    'disconnect all the stored connection ids'
    self.rect.figure.canvas.mpl_disconnect(self.cidpress)
    self.rect.figure.canvas.mpl_disconnect(self.cidrelease)
    self.rect.figure.canvas.mpl_disconnect(self.cidmotion)

fig = plt.figure()
ax = fig.add_subplot(111)
rects = ax.bar(range(10), 20*np.random.rand(10))
drs = []
for rect in rects:
    dr = DraggableRectangle(rect)
    dr.connect()
    drs.append(dr)

plt.show()

```

Extra credit: use the animation blit techniques discussed in the [animations recipe](#) to make the animated drawing faster and smoother.

Extra credit solution:

```
# draggable rectangle with the animation blit techniques; see
# http://www.scipy.org/Cookbook/Matplotlib/Animations
import numpy as np
import matplotlib.pyplot as plt

class DraggableRectangle:
    lock = None # only one can be animated at a time
    def __init__(self, rect):
        self.rect = rect
        self.press = None
        self.background = None

    def connect(self):
        'connect to all the events we need'
        self.cidpress = self.rect.figure.canvas.mpl_connect(
            'button_press_event', self.on_press)
        self.cidrelease = self.rect.figure.canvas.mpl_connect(
            'button_release_event', self.on_release)
        self.cidmotion = self.rect.figure.canvas.mpl_connect(
            'motion_notify_event', self.on_motion)

    def on_press(self, event):
        'on button press we will see if the mouse is over us and store some data'
        if event.inaxes != self.rect.axes: return
        if DraggableRectangle.lock is not None: return
        contains, attrd = self.rect.contains(event)
        if not contains: return
        print('event contains', self.rect.xy)
        x0, y0 = self.rect.xy
        self.press = x0, y0, event.xdata, event.ydata
        DraggableRectangle.lock = self

        # draw everything but the selected rectangle and store the pixel buffer
        canvas = self.rect.figure.canvas
        axes = self.rect.axes
        self.rect.set_animated(True)
        canvas.draw()
        self.background = canvas.copy_from_bbox(self.rect.axes.bbox)

        # now redraw just the rectangle
        axes.draw_artist(self.rect)

        # and blit just the redrawn area
        canvas.blit(axes.bbox)

    def on_motion(self, event):
        'on motion we will move the rect if the mouse is over us'
        if DraggableRectangle.lock is not self:
            return
```

```

    if event.inaxes != self.rect.axes: return
    x0, y0, xpress, ypress = self.press
    dx = event.xdata - xpress
    dy = event.ydata - ypress
    self.rect.set_x(x0+dx)
    self.rect.set_y(y0+dy)

    canvas = self.rect.figure.canvas
    axes = self.rect.axes
    # restore the background region
    canvas.restore_region(self.background)

    # redraw just the current rectangle
    axes.draw_artist(self.rect)

    # blit just the redrawn area
    canvas.blit(axes.bbox)

def on_release(self, event):
    'on release we reset the press data'
    if DraggableRectangle.lock is not self:
        return

    self.press = None
    DraggableRectangle.lock = None

    # turn off the rect animation property and reset the background
    self.rect.set_animated(False)
    self.background = None

    # redraw the full figure
    self.rect.figure.canvas.draw()

def disconnect(self):
    'disconnect all the stored connection ids'
    self.rect.figure.canvas.mpl_disconnect(self.cidpress)
    self.rect.figure.canvas.mpl_disconnect(self.cidrelease)
    self.rect.figure.canvas.mpl_disconnect(self.cidmotion)

fig = plt.figure()
ax = fig.add_subplot(111)
rects = ax.bar(range(10), 20*np.random.rand(10))
drs = []
for rect in rects:
    dr = DraggableRectangle(rect)
    dr.connect()
    drs.append(dr)

plt.show()

```

7.3.3 Mouse enter and leave

If you want to be notified when the mouse enters or leaves a figure or axes, you can connect to the figure/axes enter/leave events. Here is a simple example that changes the colors of the axes and figure background that the mouse is over:

```
"""
Illustrate the figure and axes enter and leave events by changing the
frame colors on enter and leave
"""
import matplotlib.pyplot as plt

def enter_axes(event):
    print('enter_axes', event.inaxes)
    event.inaxes.patch.set_facecolor('yellow')
    event.canvas.draw()

def leave_axes(event):
    print('leave_axes', event.inaxes)
    event.inaxes.patch.set_facecolor('white')
    event.canvas.draw()

def enter_figure(event):
    print('enter_figure', event.canvas.figure)
    event.canvas.figure.patch.set_facecolor('red')
    event.canvas.draw()

def leave_figure(event):
    print('leave_figure', event.canvas.figure)
    event.canvas.figure.patch.set_facecolor('grey')
    event.canvas.draw()

fig1 = plt.figure()
fig1.suptitle('mouse hover over figure or axes to trigger events')
ax1 = fig1.add_subplot(211)
ax2 = fig1.add_subplot(212)

fig1.canvas.mpl_connect('figure_enter_event', enter_figure)
fig1.canvas.mpl_connect('figure_leave_event', leave_figure)
fig1.canvas.mpl_connect('axes_enter_event', enter_axes)
fig1.canvas.mpl_connect('axes_leave_event', leave_axes)

fig2 = plt.figure()
fig2.suptitle('mouse hover over figure or axes to trigger events')
ax1 = fig2.add_subplot(211)
ax2 = fig2.add_subplot(212)

fig2.canvas.mpl_connect('figure_enter_event', enter_figure)
fig2.canvas.mpl_connect('figure_leave_event', leave_figure)
fig2.canvas.mpl_connect('axes_enter_event', enter_axes)
fig2.canvas.mpl_connect('axes_leave_event', leave_axes)

plt.show()
```

7.3.4 Object picking

You can enable picking by setting the `picker` property of an *Artist* (e.g., a matplotlib *Line2D*, *Text*, *Patch*, *Polygon*, *AxesImage*, etc...)

There are a variety of meanings of the `picker` property:

None picking is disabled for this artist (default)

boolean if True then picking will be enabled and the artist will fire a pick event if the mouse event is over the artist

float if `picker` is a number it is interpreted as an epsilon tolerance in points and the artist will fire off an event if its data is within epsilon of the mouse event. For some artists like lines and patch collections, the artist may provide additional data to the pick event that is generated, e.g., the indices of the data within epsilon of the pick event.

function if `picker` is callable, it is a user supplied function which determines whether the artist is hit by the mouse event. The signature is `hit, props = picker(artist, mouseevent)` to determine the hit test. If the mouse event is over the artist, return `hit=True` and `props` is a dictionary of properties you want added to the *PickEvent* attributes

After you have enabled an artist for picking by setting the `picker` property, you need to connect to the figure canvas `pick_event` to get pick callbacks on mouse press events. e.g.:

```
def pick_handler(event):
    mouseevent = event.mouseevent
    artist = event.artist
    # now do something with this...
```

The *PickEvent* which is passed to your callback is always fired with two attributes:

mouseevent the mouse event that generate the pick event. The mouse event in turn has attributes like `x` and `y` (the coords in display space, e.g., pixels from left, bottom) and `xdata`, `ydata` (the coords in data space). Additionally, you can get information about which buttons were pressed, which keys were pressed, which *Axes* the mouse is over, etc. See *matplotlib.backend_bases.MouseEvent* for details.

artist the *Artist* that generated the pick event.

Additionally, certain artists like *Line2D* and *PatchCollection* may attach additional meta data like the indices into the data that meet the picker criteria (e.g., all the points in the line that are within the specified epsilon tolerance)

Simple picking example

In the example below, we set the line picker property to a scalar, so it represents a tolerance in points (72 points per inch). The `onpick` callback function will be called when the pick event is within the tolerance distance from the line, and has the indices of the data vertices that are within the pick distance tolerance. Our `onpick` callback function simply prints the data that are under the pick location. Different matplotlib Artists can attach different data to the *PickEvent*. For example, *Line2D* attaches the `ind` property, which are

the indices into the line data under the pick point. See `pick()` for details on the `PickEvent` properties of the line. Here is the code:

```
import numpy as np
import matplotlib.pyplot as plt

fig = plt.figure()
ax = fig.add_subplot(111)
ax.set_title('click on points')

line, = ax.plot(np.random.rand(100), 'o', picker=5) # 5 points tolerance

def onpick(event):
    thisline = event.artist
    xdata = thisline.get_xdata()
    ydata = thisline.get_ydata()
    ind = event.ind
    points = tuple(zip(xdata[ind], ydata[ind]))
    print('onpick points:', points)

fig.canvas.mpl_connect('pick_event', onpick)

plt.show()
```

Picking exercise

Create a data set of 100 arrays of 1000 Gaussian random numbers and compute the sample mean and standard deviation of each of them (hint: numpy arrays have a `mean` and `std` method) and make a xy marker plot of the 100 means vs the 100 standard deviations. Connect the line created by the plot command to the pick event, and plot the original time series of the data that generated the clicked on points. If more than one point is within the tolerance of the clicked on point, you can use multiple subplots to plot the multiple time series.

Exercise solution:

```
"""
compute the mean and stddev of 100 data sets and plot mean vs stddev.
When you click on one of the mu, sigma points, plot the raw data from
the dataset that generated the mean and stddev
"""

import numpy as np
import matplotlib.pyplot as plt

X = np.random.rand(100, 1000)
xs = np.mean(X, axis=1)
ys = np.std(X, axis=1)

fig = plt.figure()
ax = fig.add_subplot(111)
ax.set_title('click on point to plot time series')
line, = ax.plot(xs, ys, 'o', picker=5) # 5 points tolerance
```



```
def onpick(event):  
  
    if event.artist!=line: return True  
  
    N = len(event.ind)  
    if not N: return True  
  
    figi = plt.figure()  
    for subplotnum, dataind in enumerate(event.ind):  
        ax = figi.add_subplot(N,1,subplotnum+1)  
        ax.plot(X[dataind])  
        ax.text(0.05, 0.9, 'mu=%1.3f\nsigma=%1.3f'%(xs[dataind], ys[dataind]),  
              transform=ax.transAxes, va='top')  
        ax.set_ylim(-0.5, 1.5)  
    figi.show()  
    return True  
  
fig.canvas.mpl_connect('pick_event', onpick)  
  
plt.show()
```



SELECTED EXAMPLES

8.1 Screenshots

Here you'll find a host of example plots with the code that generated them.

8.1.1 Simple Plot

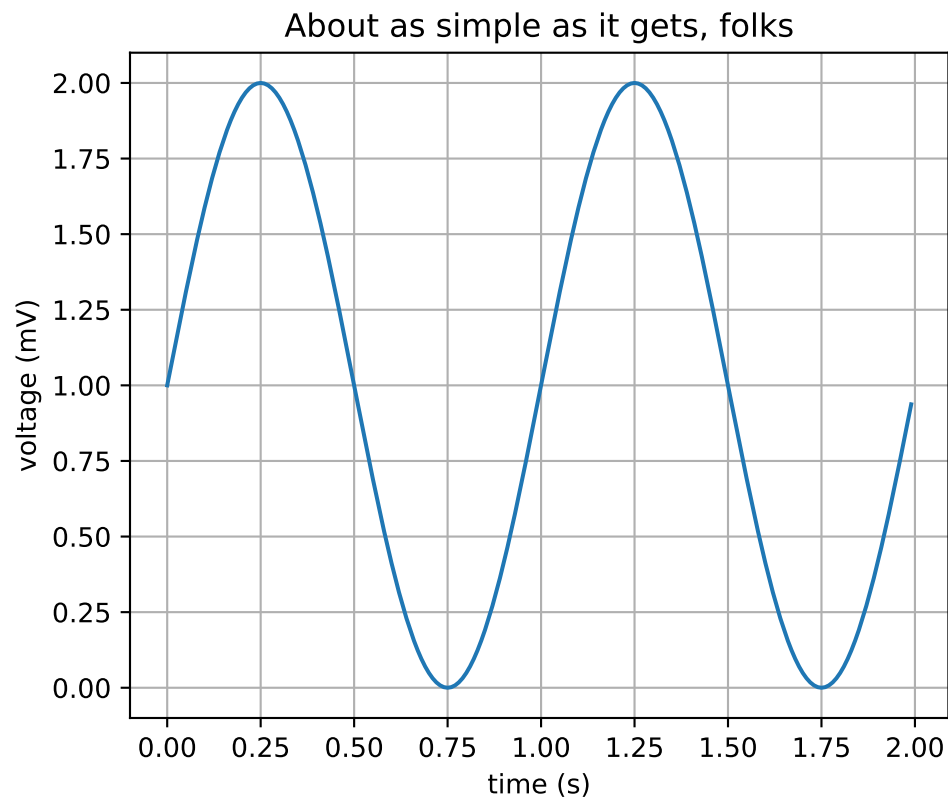
Here's a very basic `plot()` with text labels:



8.1.2 Subplot demo

Multiple axes (i.e. subplots) are created with the `subplot()` command:

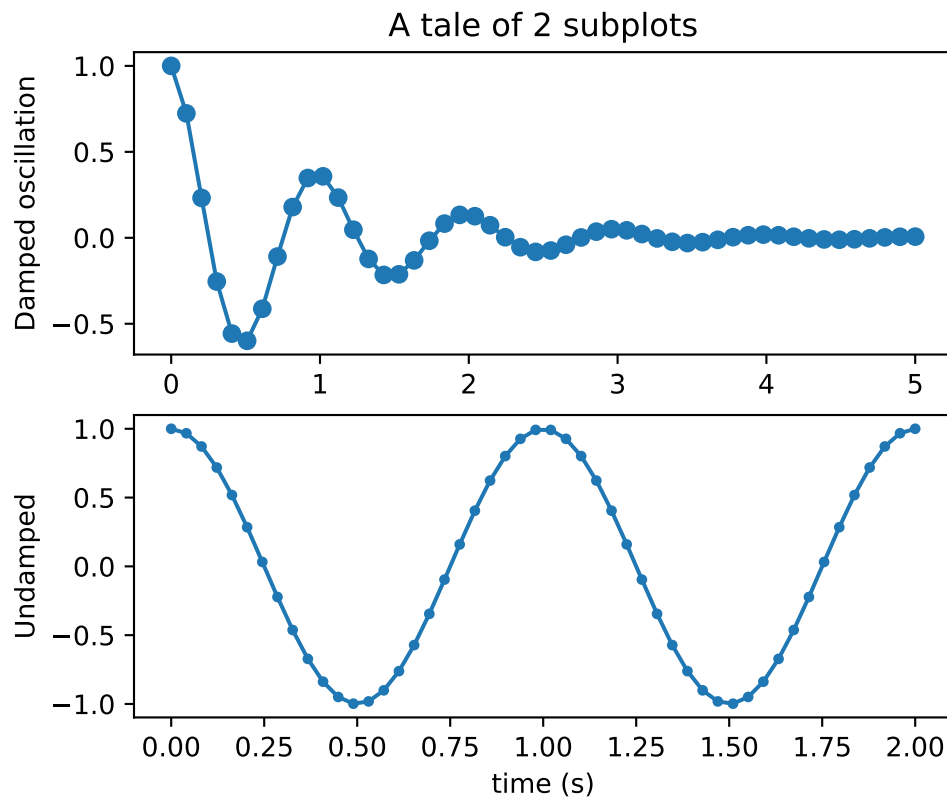

8.1.3 Histograms

The `hist()` command automatically generates histograms and returns the bin counts or probabilities:

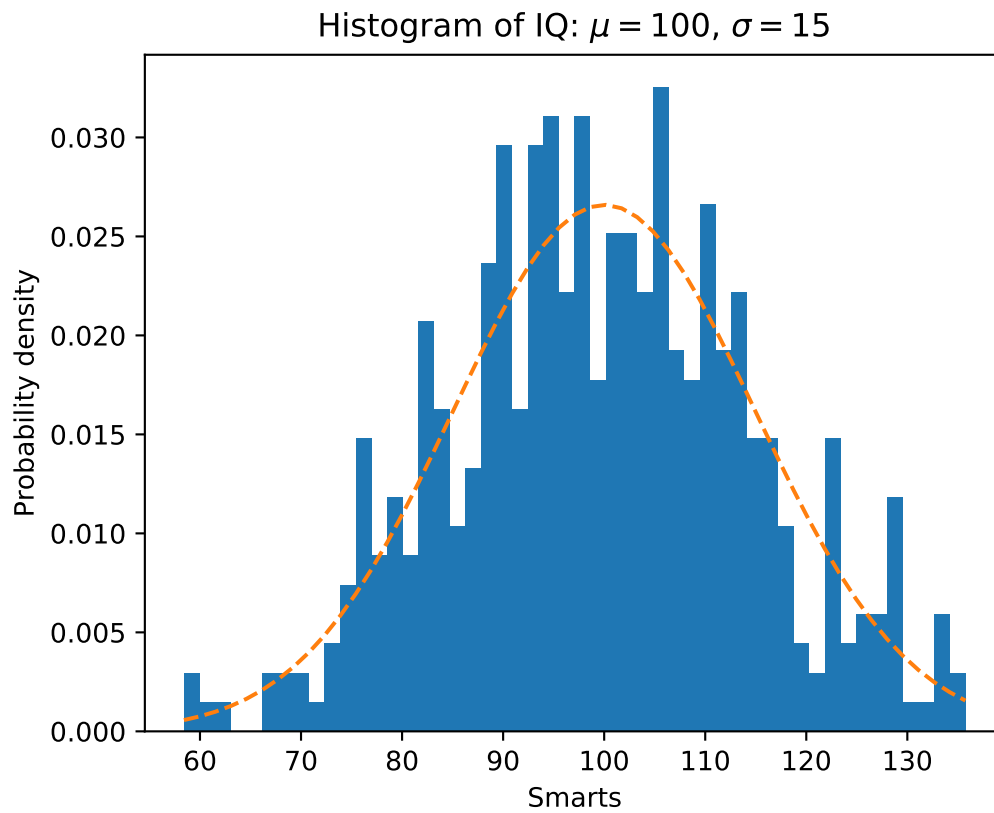

8.1.4 Path demo

You can add arbitrary paths in matplotlib using the `matplotlib.path` module:

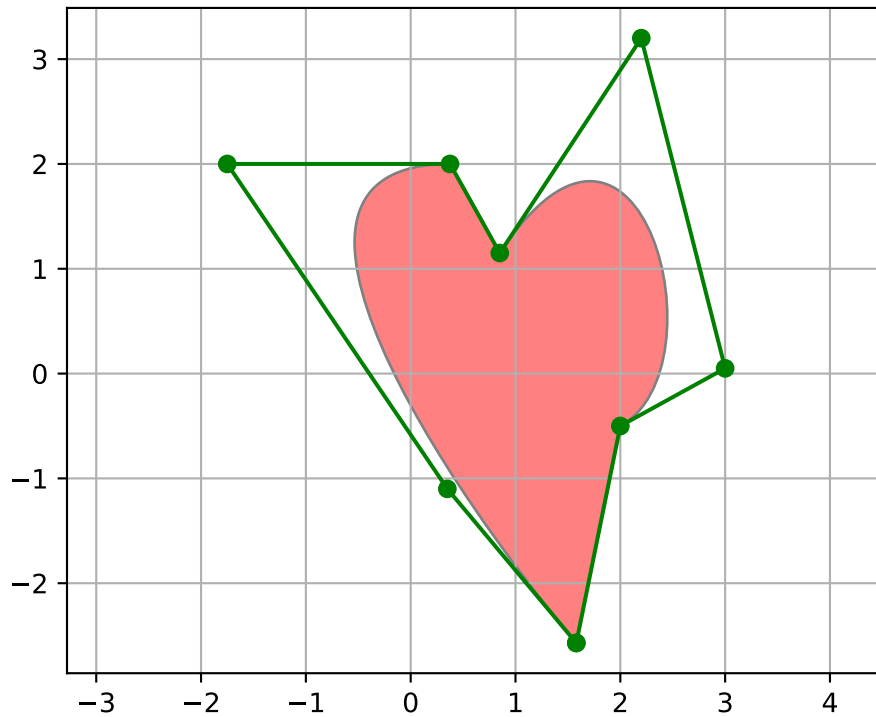

8.1.5 mplot3d

The `mplot3d` toolkit (see [mplot3d tutorial](#) and [mplot3d Examples](#)) has support for simple 3d graphs including surface, wireframe, scatter, and bar charts.

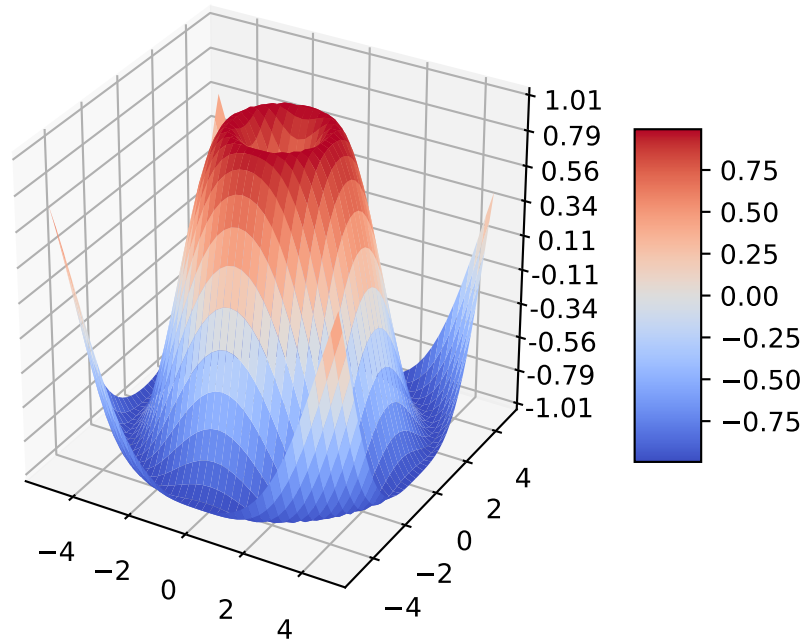

Thanks to John Porter, Jonathon Taylor, Reinier Heeres, and Ben Root for the `mplot3d` toolkit. This toolkit is included with all standard matplotlib installs.

8.1.6 Streamplot

The `streamplot()` function plots the streamlines of a vector field. In addition to simply plotting the streamlines, it allows you to map the colors and/or line widths of streamlines to a separate parameter, such as the speed or local intensity of the vector field.

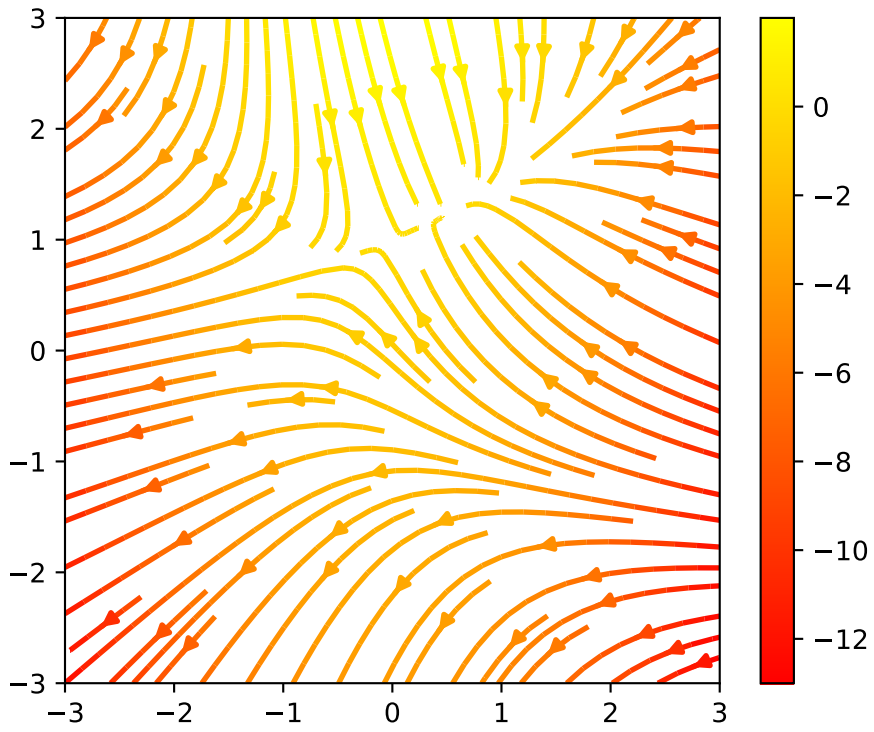

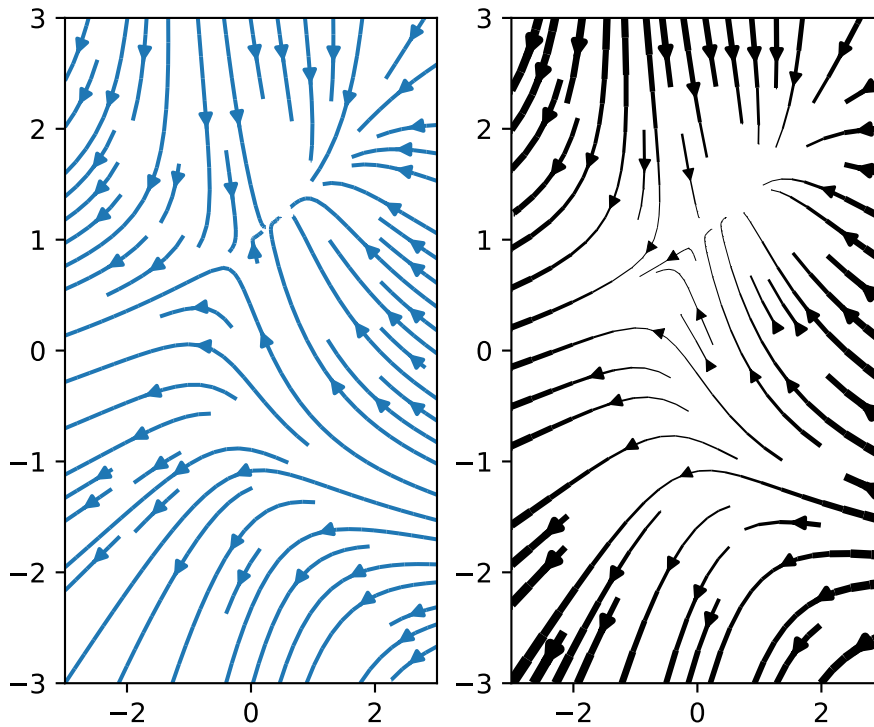

This feature complements the `quiver()` function for plotting vector fields. Thanks to Tom Flanagan and Tony Yu for adding the streamplot function.

8.1.7 Ellipses

In support of the [Phoenix](#) mission to Mars (which used matplotlib to display ground tracking of spacecraft), Michael Droettboom built on work by Charlie Moad to provide an extremely accurate 8-spline approximation to elliptical arcs (see [Arc](#)), which are insensitive to zoom level.

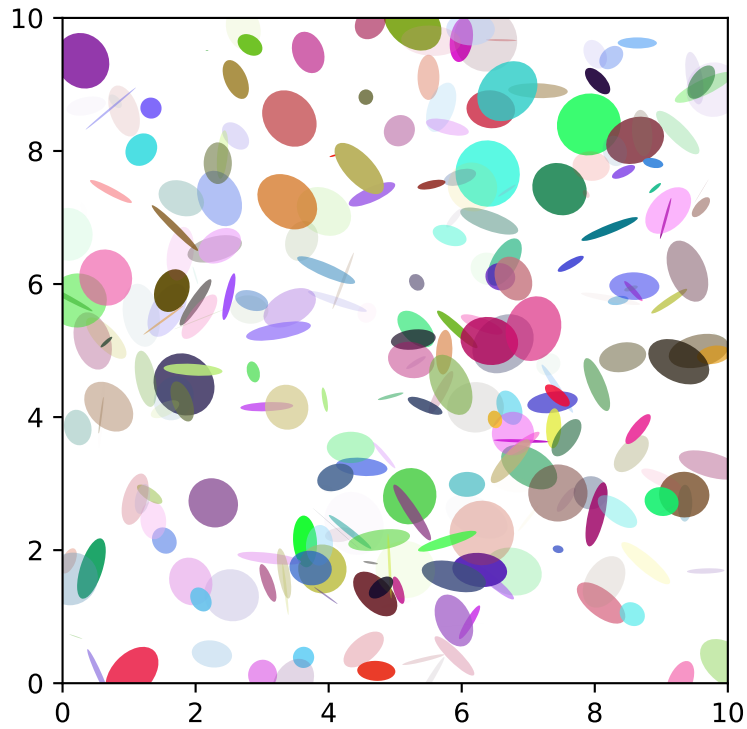

8.1.8 Bar charts

Bar charts are simple to create using the `bar()` command, which includes customizations such as error bars:

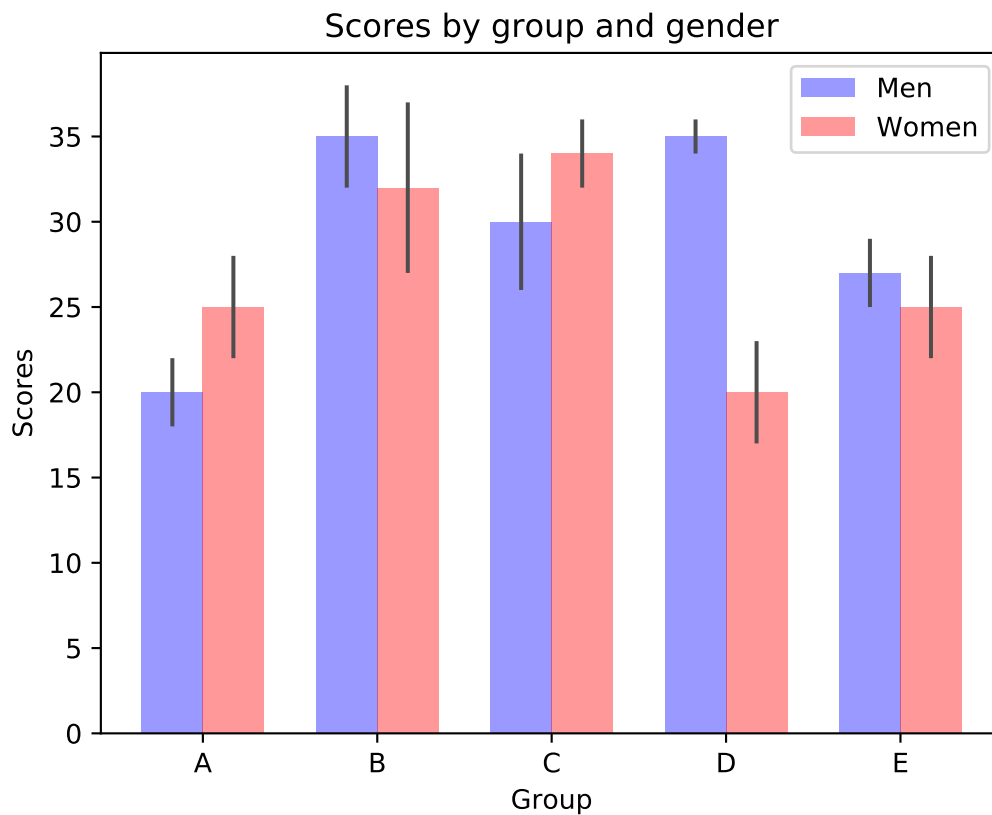

It's also simple to create stacked bars (`bar_stacked.py`), or horizontal bar charts (`barh_demo.py`).

8.1.9 Pie charts

The `pie()` command allows you to easily create pie charts. Optional features include auto-labeling the percentage of area, exploding one or more wedges from the center of the pie, and a shadow effect. Take a close look at the attached code, which generates this figure in just a few lines of code.

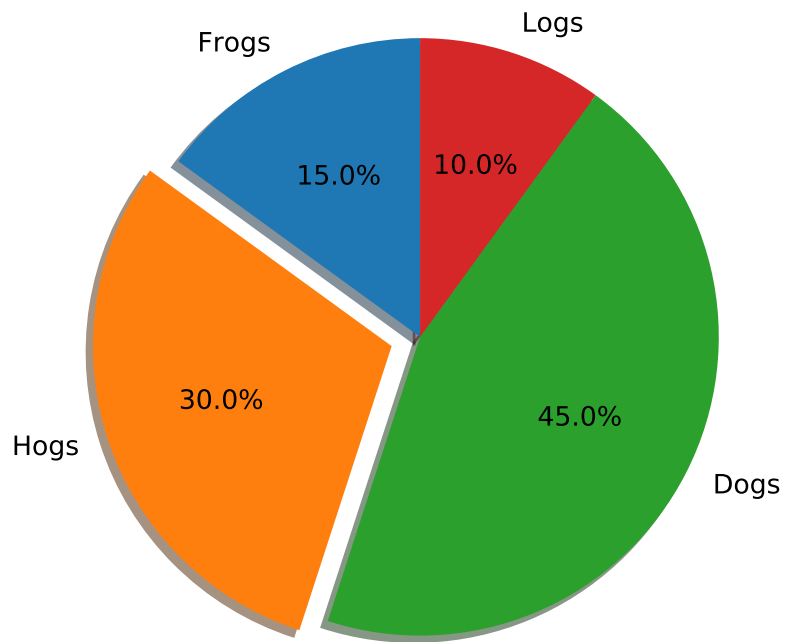

8.1.10 Table demo

The `table()` command adds a text table to an axes.

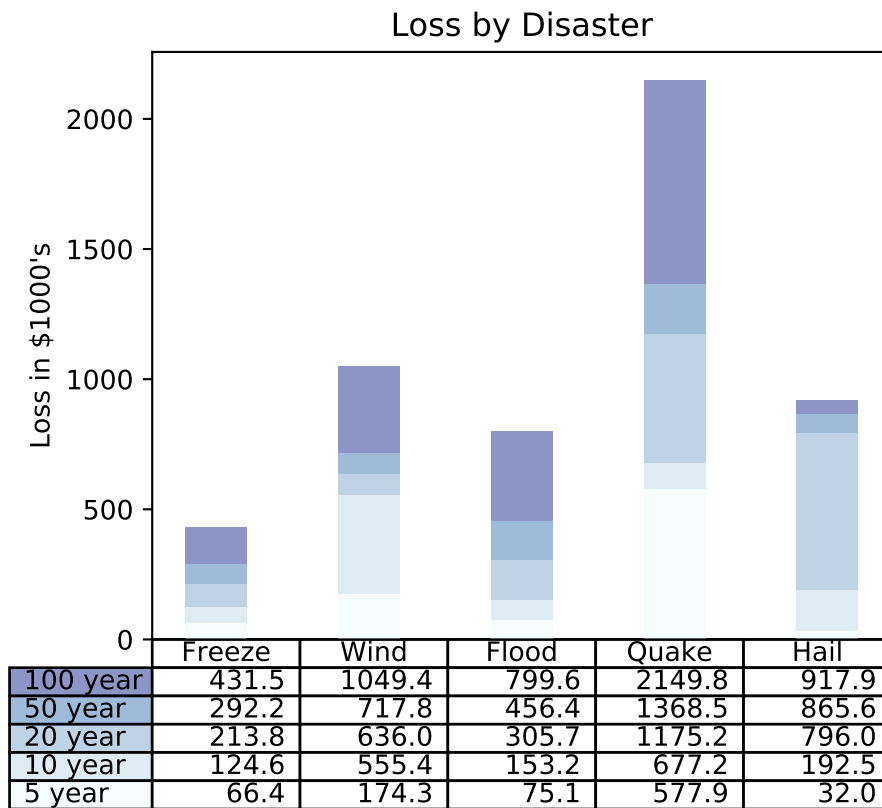

8.1.11 Scatter demo

The `scatter()` command makes a scatter plot with (optional) size and color arguments. This example plots changes in Google's stock price, with marker sizes reflecting the trading volume and colors varying with time. Here, the alpha attribute is used to make semitransparent circle markers.

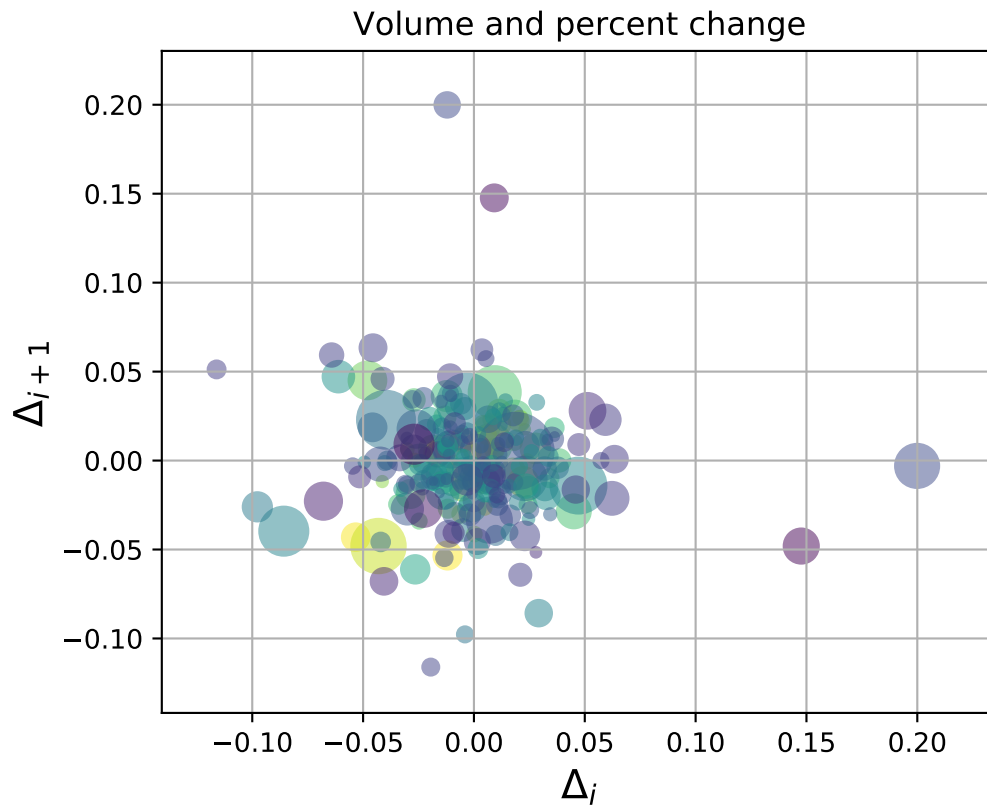

8.1.12 Slider demo

Matplotlib has basic GUI widgets that are independent of the graphical user interface you are using, allowing you to write cross GUI figures and widgets. See [matplotlib.widgets](#) and the widget examples.

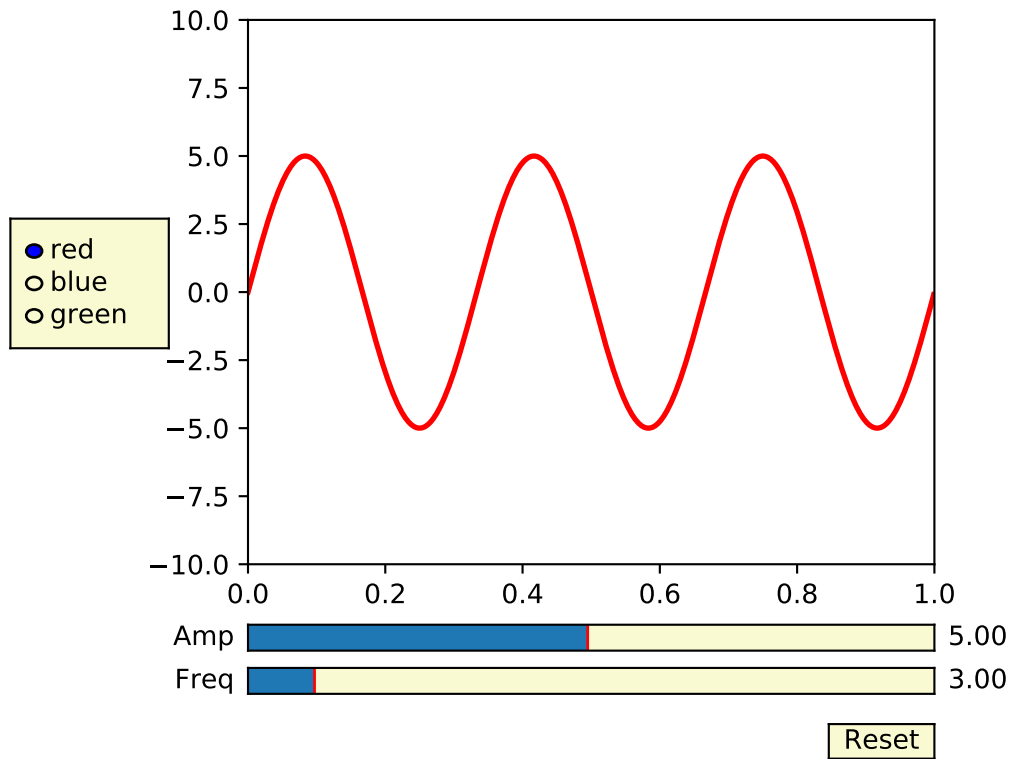

8.1.13 Fill demo

The `fill()` command lets you plot filled curves and polygons:

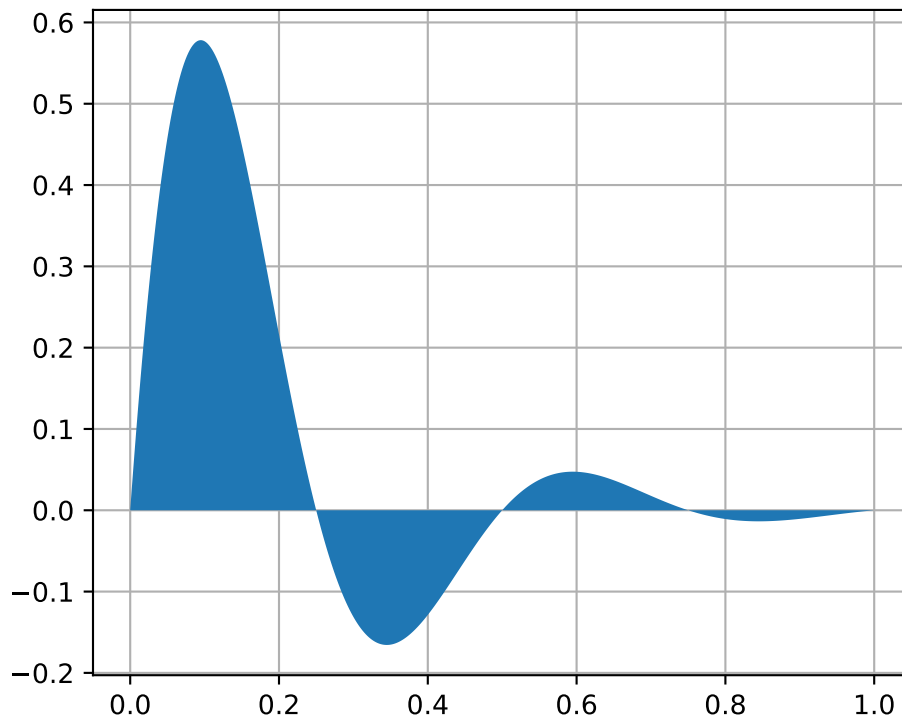

Thanks to Andrew Straw for adding this function.

8.1.14 Date demo

You can plot date data with major and minor ticks and custom tick formatters for both.



See `matplotlib.ticker` and `matplotlib.dates` for details and usage.

8.1.15 Log plots

The `semilogx()`, `semilogy()` and `loglog()` functions simplify the creation of logarithmic plots.

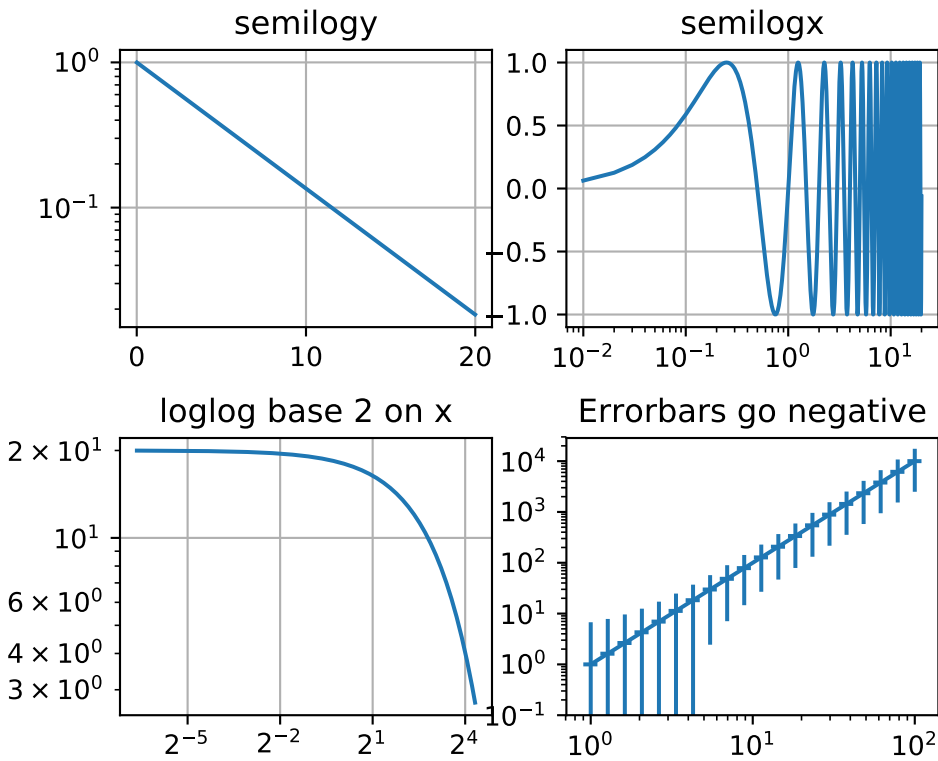

Thanks to Andrew Straw, Darren Dale and Gregory Liens for contributions log-scaling infrastructure.

8.1.16 Polar plots

The `polar()` command generates polar plots.

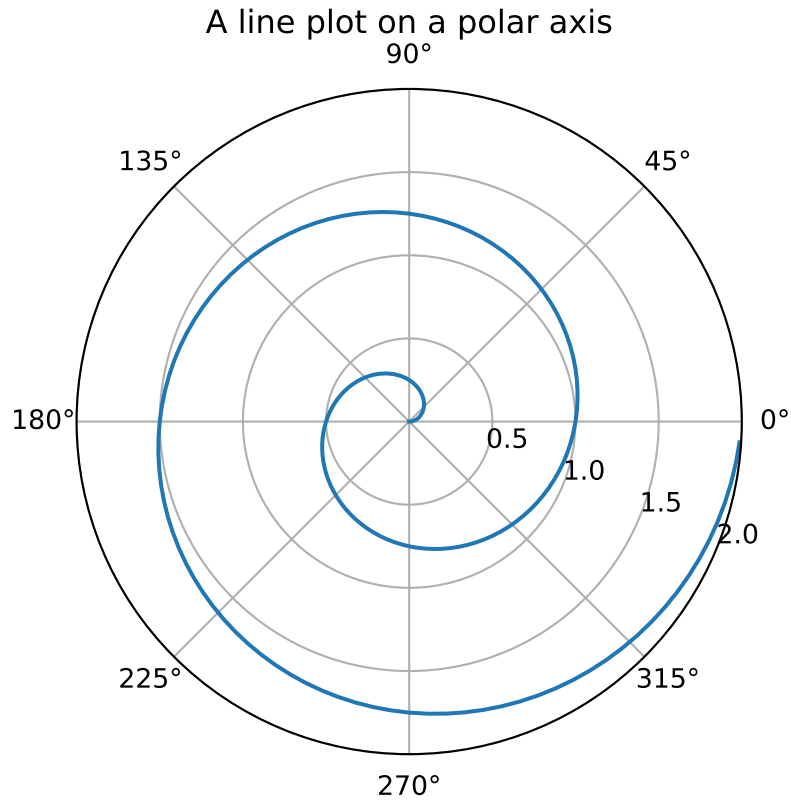

8.1.17 Legends

The `legend()` command automatically generates figure legends, with MATLAB-compatible legend placement commands.

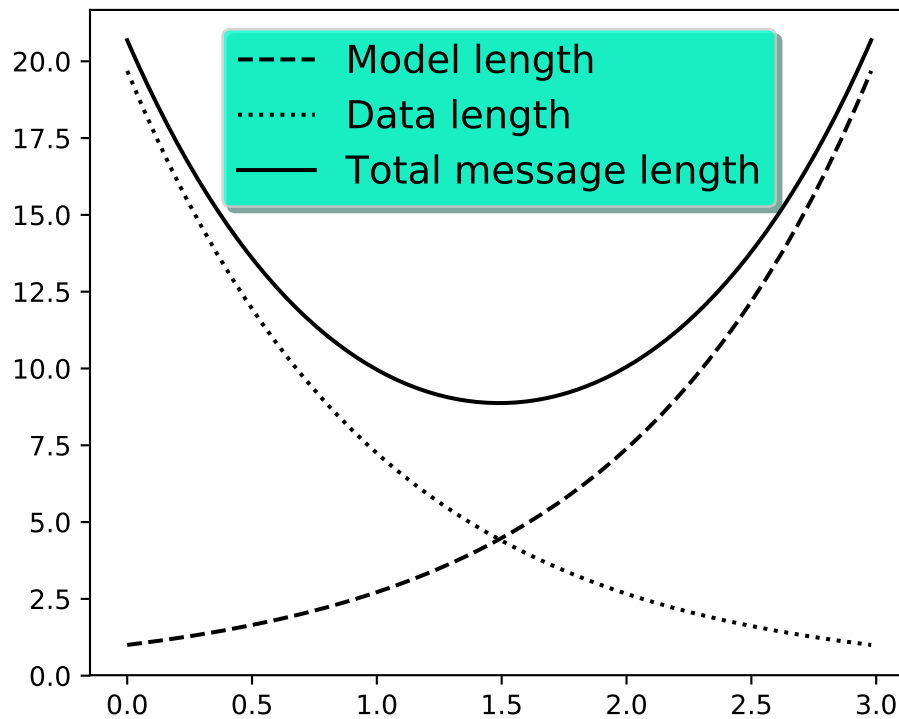

Thanks to Charles Twardy for input on the legend command.

8.1.18 Mathtext_examples

Below is a sampling of the many TeX expressions now supported by matplotlib's internal mathtext engine. The mathtext module provides TeX style mathematical expressions using [FreeType](#) and the DejaVu, BaKoMa computer modern, or [STIX](#) fonts. See the [matplotlib.mathtext](#) module for additional details.

Matplotlib's math rendering engine

$$W_{\delta_1 \rho_1 \sigma_2}^{3\beta} = U_{\delta_1 \rho_1}^{3\beta} + \frac{1}{8\pi^2} \int_{\alpha_2}^{\alpha_2} d\alpha'_2 \left[\frac{U_{\delta_1 \rho_1}^{2\beta} - \alpha'_2 U_{\rho_1 \sigma_2}^{1\beta}}{U_{\rho_1 \sigma_2}^{0\beta}} \right]$$

Subscripts and superscripts:

$$\alpha_i > \beta_i, \alpha_{i+1}^j = \sin(2\pi f_j t_i) e^{-5t_i/\tau}, \dots$$

Fractions, binomials and stacked numbers:

$$\frac{3}{4}, \binom{3}{4}, \frac{3}{4}, \left(\frac{5 - \frac{1}{x}}{4} \right), \dots$$

Radicals:

$$\sqrt{2}, \sqrt[3]{x}, \dots$$

Fonts:

Roman , *Italic* , Typewriter or *CALLIGRAPHY*

Accents:

á, ā, ă, à, ä, ù, â, ã, ǎ, \widehat{xyz} , \widetilde{xyz} , ...

Greek, Hebrew:

$\alpha, \beta, \chi, \delta, \lambda, \mu, \Delta, \Gamma, \Omega, \Phi, \Pi, \Upsilon, \nabla, \aleph, \beth, \gamma, \daleth,$

Delimiters, functions and Symbols:

$\sqcup, \int, \oint, \prod, \sum, \log, \sin, \approx, \oplus, \star, \alpha, \infty, \partial, \Re,$

Matplotlib's mathtext infrastructure is an independent implementation and does not require TeX or any external packages installed on your computer. See the tutorial at [Writing mathematical expressions](#).

8.1.19 Native TeX rendering

Although matplotlib's internal math rendering engine is quite powerful, sometimes you need TeX. Matplotlib supports external TeX rendering of strings with the `usetex` option.

$$\text{\TeX is Number } \sum_{n=1}^{\infty} \frac{-e^{i\pi}}{2^n}!$$

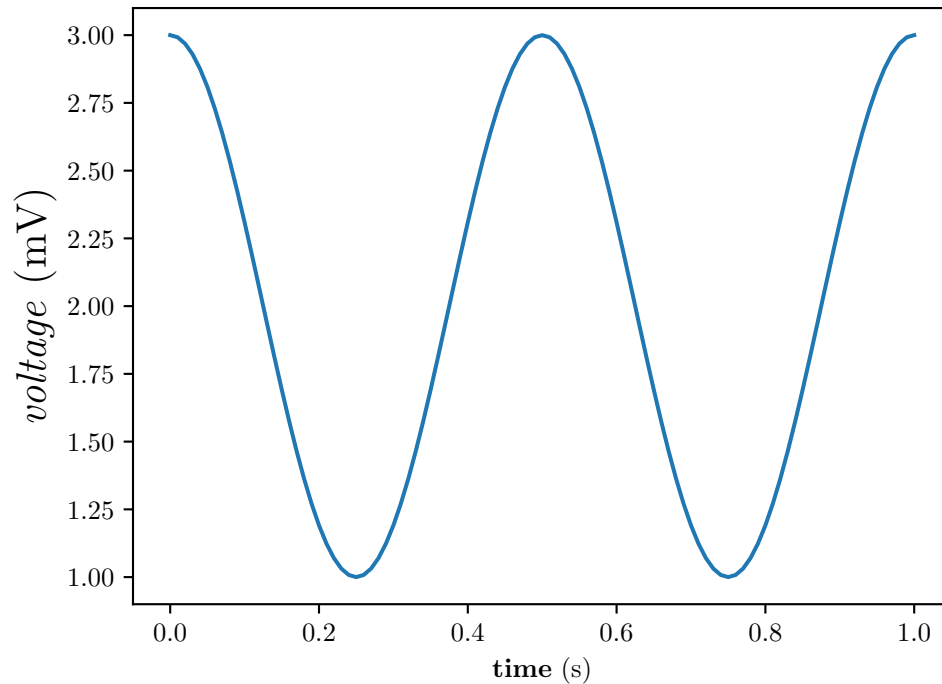

8.1.20 EEG demo

You can embed matplotlib into pygtk, wx, Tk, or Qt applications. Here is a screenshot of an EEG viewer called `pbrain`.

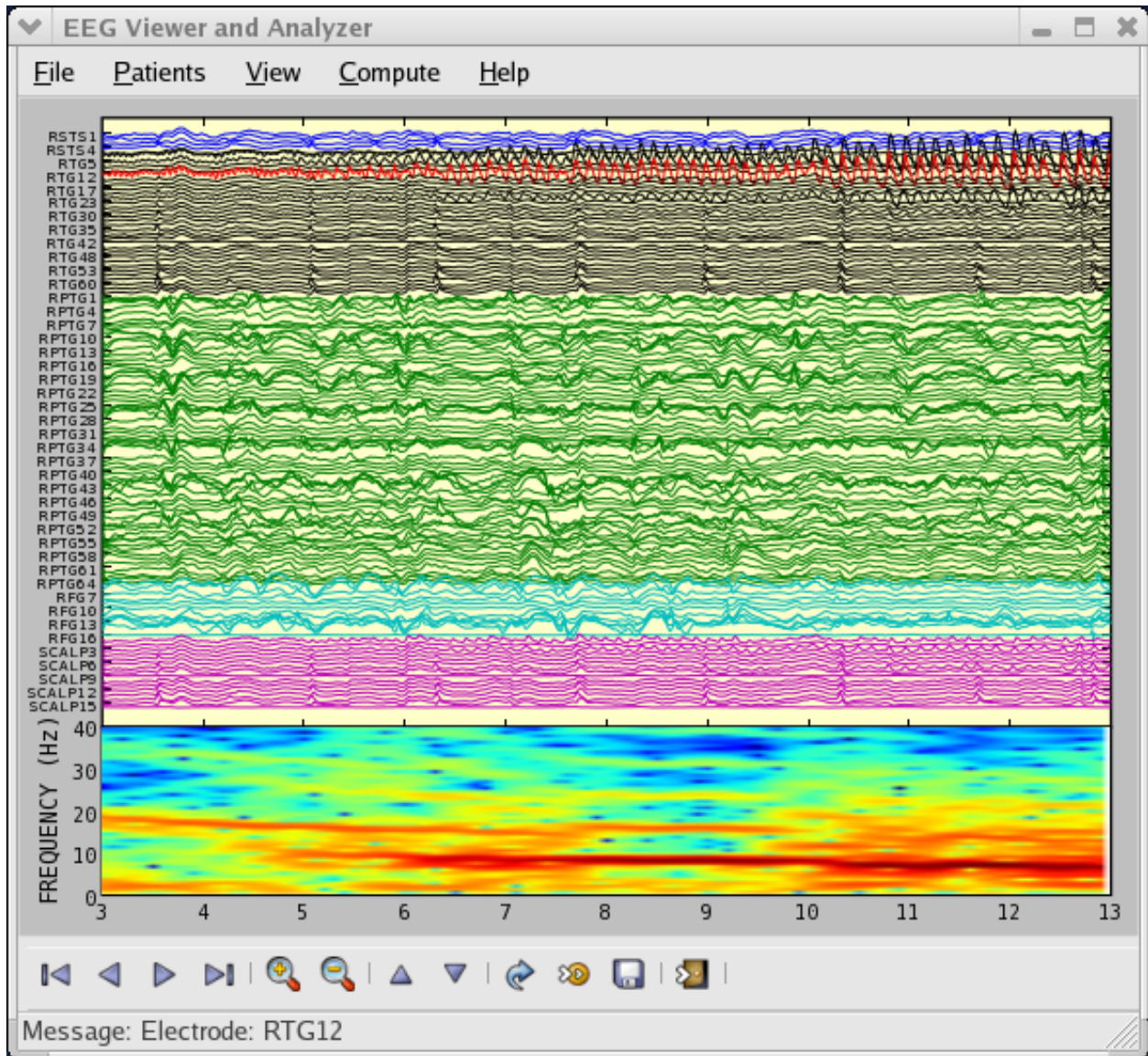

The lower axes uses `specgram()` to plot the spectrogram of one of the EEG channels.

For examples of how to embed matplotlib in different toolkits, see:

- *user_interfaces example code: embedding_in_gtk2.py*
- *user_interfaces example code: embedding_in_wx2.py*
- *user_interfaces example code: mpl_with_glade.py*
- *user_interfaces example code: embedding_in_qt4.py*
- *user_interfaces example code: embedding_in_tk.py*

8.1.21 XKCD-style sketch plots

matplotlib supports plotting in the style of xkcd.

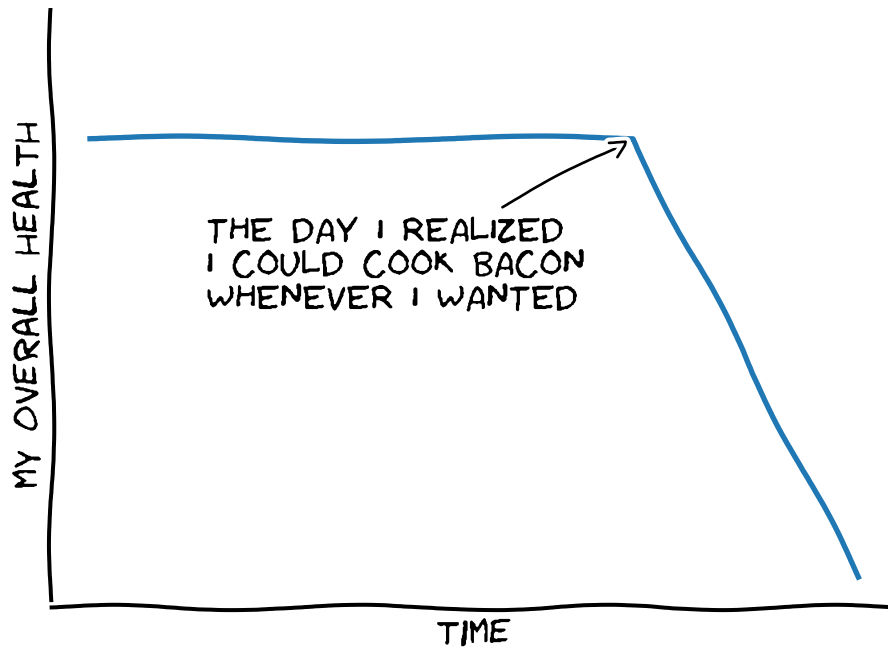

"STOVE OWNERSHIP" FROM XKCD BY RANDALL MONROE

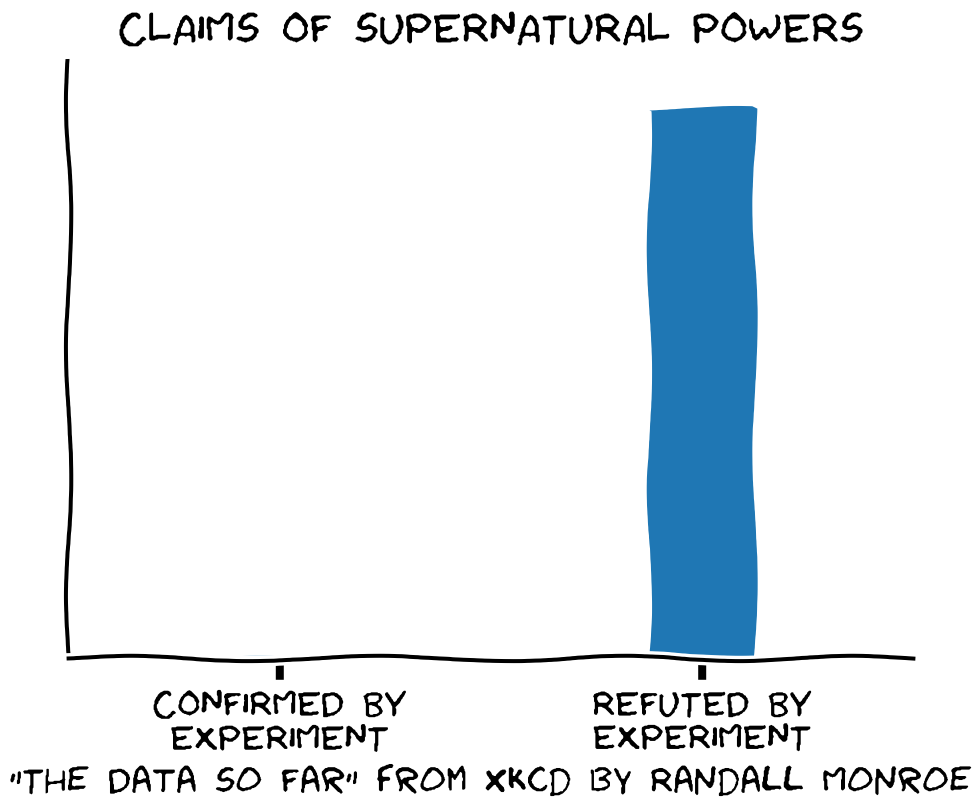

8.2 Our Favorite Recipes

Here is a collection of short tutorials, examples and code snippets that illustrate some of the useful idioms and tricks to make snazzier figures and overcome some matplotlib warts.

8.2.1 Sharing axis limits and views

It's common to make two or more plots which share an axis, e.g., two subplots with time as a common axis. When you pan and zoom around on one, you want the other to move around with you. To facilitate this, matplotlib Axes support a `sharex` and `sharey` attribute. When you create a `subplot()` or `axes()` instance, you can pass in a keyword indicating what axes you want to share with

```
In [96]: t = np.arange(0, 10, 0.01)
```

```
In [97]: ax1 = plt.subplot(211)
```

```
In [98]: ax1.plot(t, np.sin(2*np.pi*t))
```

```
Out[98]: [<matplotlib.lines.Line2D object at 0x98719ec>]
```

```
In [99]: ax2 = plt.subplot(212, sharex=ax1)
```

```
In [100]: ax2.plot(t, np.sin(4*np.pi*t))
Out[100]: [<matplotlib.lines.Line2D object at 0xb7d8fec>]
```

8.2.2 Easily creating subplots

In early versions of matplotlib, if you wanted to use the pythonic API and create a figure instance and from that create a grid of subplots, possibly with shared axes, it involved a fair amount of boilerplate code. e.g.

```
# old style
fig = plt.figure()
ax1 = fig.add_subplot(221)
ax2 = fig.add_subplot(222, sharex=ax1, sharey=ax1)
ax3 = fig.add_subplot(223, sharex=ax1, sharey=ax1)
ax3 = fig.add_subplot(224, sharex=ax1, sharey=ax1)
```

Fernando Perez has provided a nice top level method to create in `subplots()` (note the “s” at the end) everything at once, and turn on x and y sharing for the whole bunch. You can either unpack the axes individually:

```
# new style method 1; unpack the axes
fig, ((ax1, ax2), (ax3, ax4)) = plt.subplots(2, 2, sharex=True, sharey=True)
ax1.plot(x)
```

or get them back as a `numrows x numcolumns` object array which supports numpy indexing:

```
# new style method 2; use an axes array
fig, axs = plt.subplots(2, 2, sharex=True, sharey=True)
axs[0,0].plot(x)
```

8.2.3 Fixing common date annoyances

matplotlib allows you to natively plots python datetime instances, and for the most part does a good job picking tick locations and string formats. There are a couple of things it does not handle so gracefully, and here are some tricks to help you work around them. We’ll load up some sample date data which contains `datetime.date` objects in a numpy record array:

```
In [63]: datafile = cbook.get_sample_data('goog.npy')

In [64]: r = np.load(datafile).view(np.recarray)

In [65]: r.dtype
Out[65]: dtype([('date', '<f8'), ('', '<f8'), ('open', '<f8'),
                ('high', '<f8'), ('low', '<f8'), ('close', '<f8'),
                ('volume', '<i8'), ('adj_close', '<f8')])

In [66]: r.date
Out[66]:
array([[2004-08-19, 2004-08-20, 2004-08-23, ..., 2008-10-10, 2008-10-13,
        2008-10-14], dtype=object)
```

The dtype of the numpy record array for the field date is |O4 which means it is a 4-byte python object pointer; in this case the objects are datetime.date instances, which we can see when we print some samples in the ipython terminal window.

If you plot the data,

```
In [67]: plot(r.date, r.close)
Out[67]: [<matplotlib.lines.Line2D object at 0x92a6b6c>]
```

you will see that the x tick labels are all squashed together.

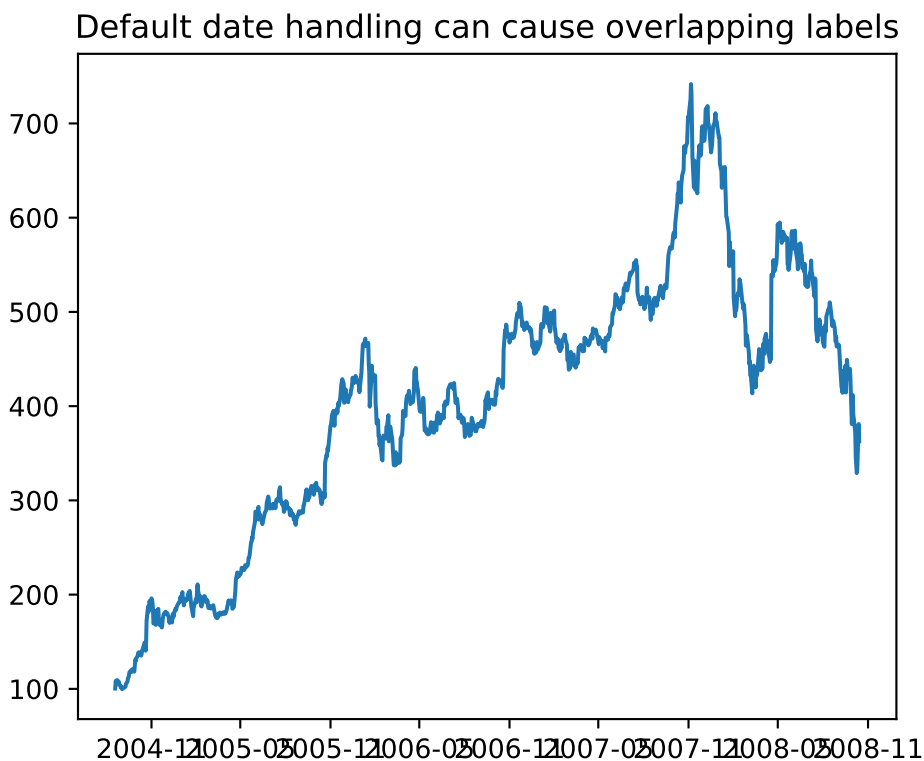

Another annoyance is that if you hover the mouse over the window and look in the lower right corner of the matplotlib toolbar (*Interactive navigation*) at the x and y coordinates, you see that the x locations are formatted the same way the tick labels are, e.g., “Dec 2004”. What we’d like is for the location in the toolbar to have a higher degree of precision, e.g., giving us the exact date our mouse is hovering over. To fix the first problem, we can use `matplotlib.figure.Figure.autofmt_xdate()` and to fix the second problem we can use the `ax.fmt_xdata` attribute which can be set to any function that takes a scalar and returns a string. matplotlib has a number of date formatters built in, so we’ll use one of those.

```
plt.close('all')
fig, ax = plt.subplots(1)
ax.plot(r.date, r.close)

# rotate and align the tick labels so they look better
fig.autofmt_xdate()
```

```
# use a more precise date string for the x axis locations in the
# toolbar
import matplotlib.dates as mdates
ax.fmt_xdata = mdates.DateFormatter('%Y-%m-%d')
plt.title('fig.autofmt_xdate fixes the labels')
```

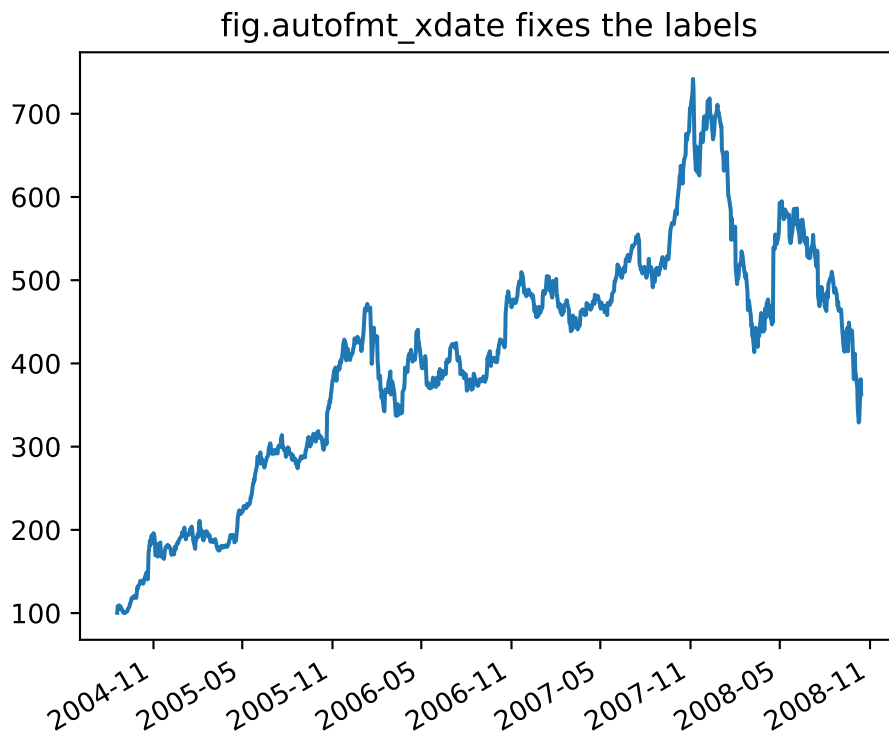

Now when you hover your mouse over the plotted data, you'll see date format strings like 2004-12-01 in the toolbar.

8.2.4 Fill Between and Alpha

The `fill_between()` function generates a shaded region between a min and max boundary that is useful for illustrating ranges. It has a very handy `where` argument to combine filling with logical ranges, e.g., to just fill in a curve over some threshold value.

At its most basic level, `fill_between` can be used to enhance a graph's visual appearance. Let's compare two graphs of a financial time series with a simple line plot on the left and a filled line on the right.

```
import matplotlib.pyplot as plt
import numpy as np

import matplotlib.cbook as cbook
```

```
# load up some sample financial data
datafile = cbook.get_sample_data('goog.npy')
try:
    # Python3 cannot load python2 .npy files with datetime(object) arrays
    # unless the encoding is set to bytes. However this option was
    # not added until numpy 1.10 so this example will only work with
    # python 2 or with numpy 1.10 and later.
    r = np.load(datafile, encoding='bytes').view(np.recarray)
except TypeError:
    r = np.load(datafile).view(np.recarray)
# create two subplots with the shared x and y axes
fig, (ax1, ax2) = plt.subplots(1,2, sharex=True, sharey=True)

pricemin = r.close.min()

ax1.plot(r.date, r.close, lw=2)
ax2.fill_between(r.date, pricemin, r.close, facecolor='blue', alpha=0.5)

for ax in ax1, ax2:
    ax.grid(True)

ax1.set_ylabel('price')
for label in ax2.get_yticklabels():
    label.set_visible(False)

fig.suptitle('Google (GOOG) daily closing price')
fig.autofmt_xdate()
```

Google (GOOG) daily closing price

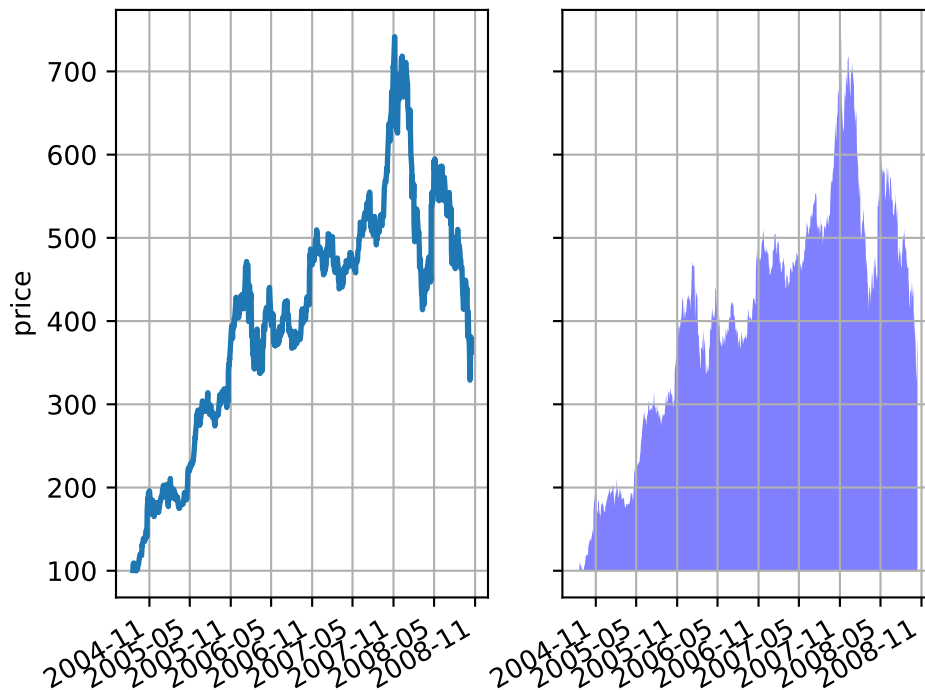

The alpha channel is not necessary here, but it can be used to soften colors for more visually appealing plots. In other examples, as we'll see below, the alpha channel is functionally useful as the shaded regions can overlap and alpha allows you to see both. Note that the postscript format does not support alpha (this is a postscript limitation, not a matplotlib limitation), so when using alpha save your figures in PNG, PDF or SVG.

Our next example computes two populations of random walkers with a different mean and standard deviation of the normal distributions from which the steps are drawn. We use shared regions to plot +/- one standard deviation of the mean position of the population. Here the alpha channel is useful, not just aesthetic.

```
import matplotlib.pyplot as plt
import numpy as np

Nsteps, Nwalkers = 100, 250
t = np.arange(Nsteps)

# an (Nsteps x Nwalkers) array of random walk steps
S1 = 0.002 + 0.01*np.random.randn(Nsteps, Nwalkers)
S2 = 0.004 + 0.02*np.random.randn(Nsteps, Nwalkers)

# an (Nsteps x Nwalkers) array of random walker positions
X1 = S1.cumsum(axis=0)
X2 = S2.cumsum(axis=0)
```

```

# Nsteps length arrays empirical means and standard deviations of both
# populations over time
mu1 = X1.mean(axis=1)
sigma1 = X1.std(axis=1)
mu2 = X2.mean(axis=1)
sigma2 = X2.std(axis=1)

# plot it!
fig, ax = plt.subplots(1)
ax.plot(t, mu1, lw=2, label='mean population 1', color='blue')
ax.plot(t, mu2, lw=2, label='mean population 2', color='yellow')
ax.fill_between(t, mu1+sigma1, mu1-sigma1, facecolor='blue', alpha=0.5)
ax.fill_between(t, mu2+sigma2, mu2-sigma2, facecolor='yellow', alpha=0.5)
ax.set_title('random walkers empirical  $\mu$  and  $\pm\sigma$  interval')
ax.legend(loc='upper left')
ax.set_xlabel('num steps')
ax.set_ylabel('position')
ax.grid()

```

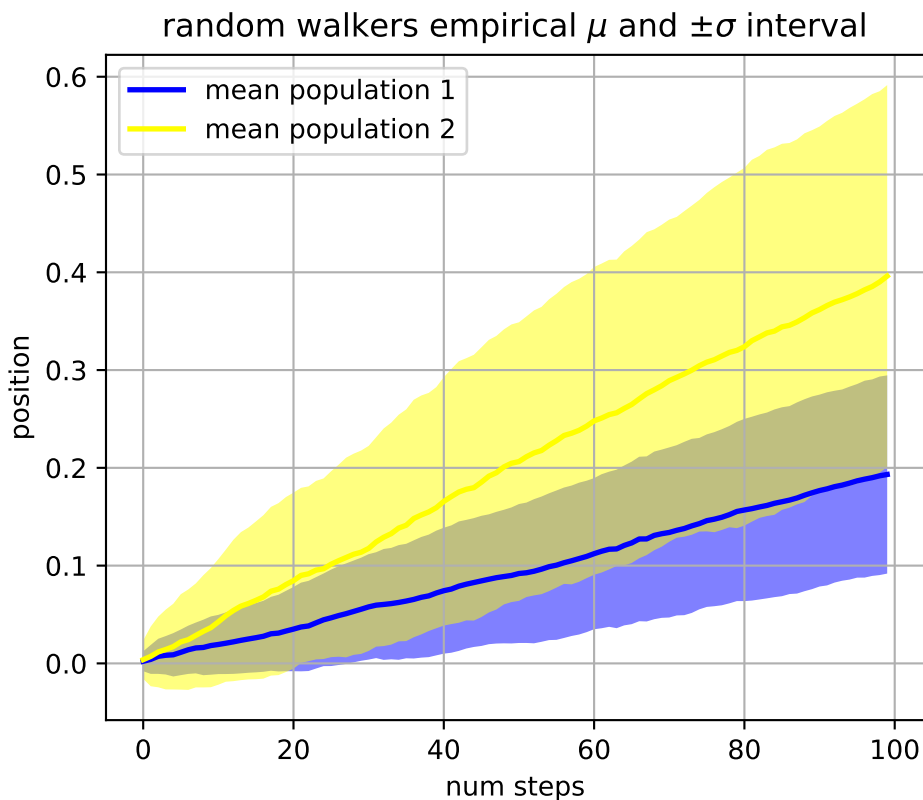

The `where` keyword argument is very handy for highlighting certain regions of the graph. `where` takes a boolean mask the same length as the `x`, `ymin` and `ymax` arguments, and only fills in the region where the boolean mask is `True`. In the example below, we simulate a single random walker and compute the analytic mean and standard deviation of the population positions. The population mean is shown as the black dashed line, and the plus/minus one sigma deviation from the mean is shown as the yellow filled region. We use the `where` mask `X > upper_bound` to find the region where the walker is above the one sigma boundary, and

shade that region blue.

```
np.random.seed(1234)

Nsteps = 500
t = np.arange(Nsteps)

mu = 0.002
sigma = 0.01

# the steps and position
S = mu + sigma*np.random.randn(Nsteps)
X = S.cumsum()

# the 1 sigma upper and lower analytic population bounds
lower_bound = mu*t - sigma*np.sqrt(t)
upper_bound = mu*t + sigma*np.sqrt(t)

fig, ax = plt.subplots(1)
ax.plot(t, X, lw=2, label='walker position', color='blue')
ax.plot(t, mu*t, lw=1, label='population mean', color='black', ls='--')
ax.fill_between(t, lower_bound, upper_bound, facecolor='yellow', alpha=0.5,
               label='1 sigma range')
ax.legend(loc='upper left')

# here we use the where argument to only fill the region where the
# walker is above the population 1 sigma boundary
ax.fill_between(t, upper_bound, X, where=X>upper_bound, facecolor='blue', alpha=0.5)
ax.set_xlabel('num steps')
ax.set_ylabel('position')
ax.grid()
```

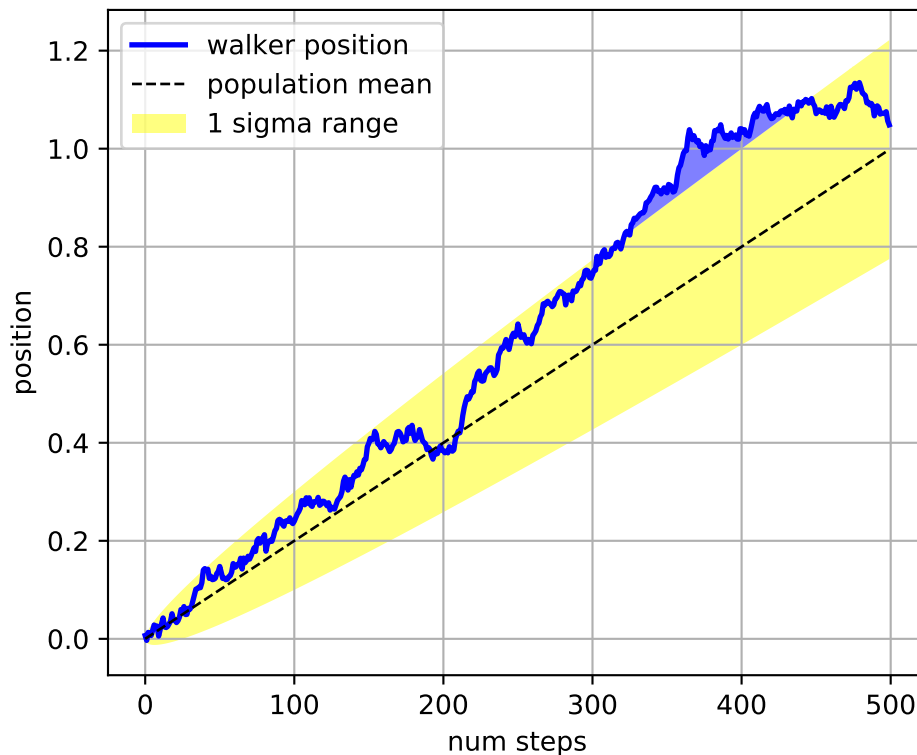
Another handy use of filled regions is to highlight horizontal or vertical spans of an axes – for that matplotlib has some helper functions `axhspan()` and `axvspan()` and example *pylab_examples example code: [axhspan_demo.py](#)*.

8.2.5 Transparent, fancy legends

Sometimes you know what your data looks like before you plot it, and may know for instance that there won't be much data in the upper right hand corner. Then you can safely create a legend that doesn't overlay your data:

```
ax.legend(loc='upper right')
```

Other times you don't know where your data is, and `loc='best'` will try and place the legend:

```
ax.legend(loc='best')
```

but still, your legend may overlap your data, and in these cases it's nice to make the legend frame transparent.

```
np.random.seed(1234)
fig, ax = plt.subplots(1)
ax.plot(np.random.randn(300), 'o-', label='normal distribution')
ax.plot(np.random.rand(300), 's-', label='uniform distribution')
ax.set_ylim(-3, 3)
ax.legend(loc='best', fancybox=True, framealpha=0.5)
```

```
ax.set_title('fancy, transparent legends')
```

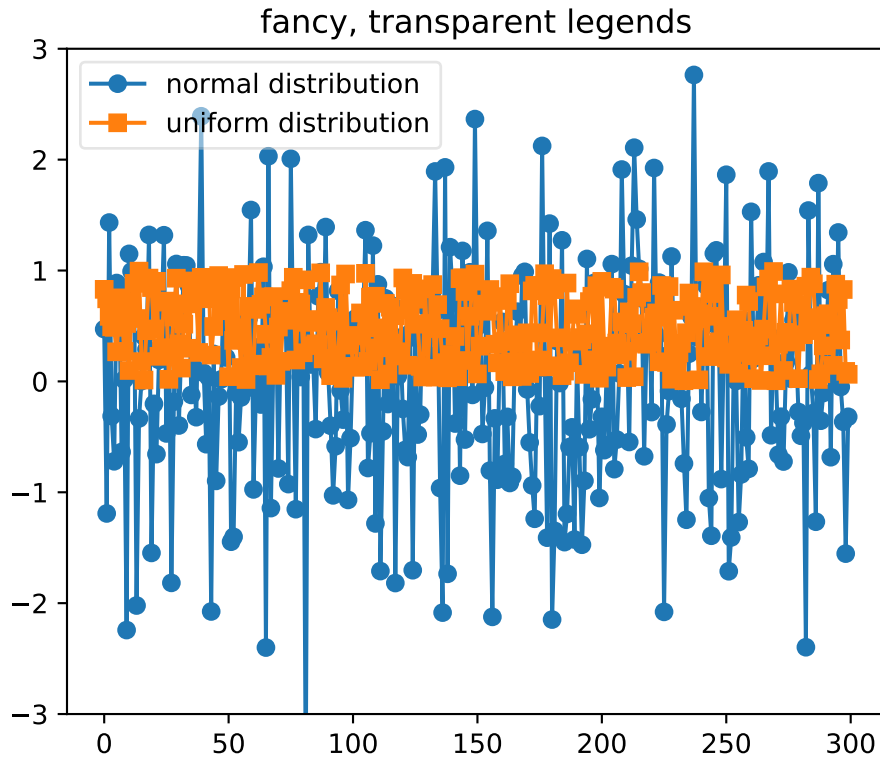

8.2.6 Placing text boxes

When decorating axes with text boxes, two useful tricks are to place the text in axes coordinates (see *Transformations Tutorial*), so the text doesn't move around with changes in x or y limits. You can also use the `bbox` property of text to surround the text with a *Patch* instance – the `bbox` keyword argument takes a dictionary with keys that are Patch properties.

```
np.random.seed(1234)
fig, ax = plt.subplots(1)
x = 30*np.random.randn(10000)
mu = x.mean()
median = np.median(x)
sigma = x.std()
textstr = '$\mu=%.2f$\n$\mathrm{median}=%.2f$\n$\sigma=%.2f$'%(mu, median, sigma)

ax.hist(x, 50)
# these are matplotlib.patch.Patch properties
props = dict(boxstyle='round', facecolor='wheat', alpha=0.5)

# place a text box in upper left in axes coords
```

```
ax.text(0.05, 0.95, textstr, transform=ax.transAxes, fontsize=14,  
        verticalalignment='top', bbox=props)
```

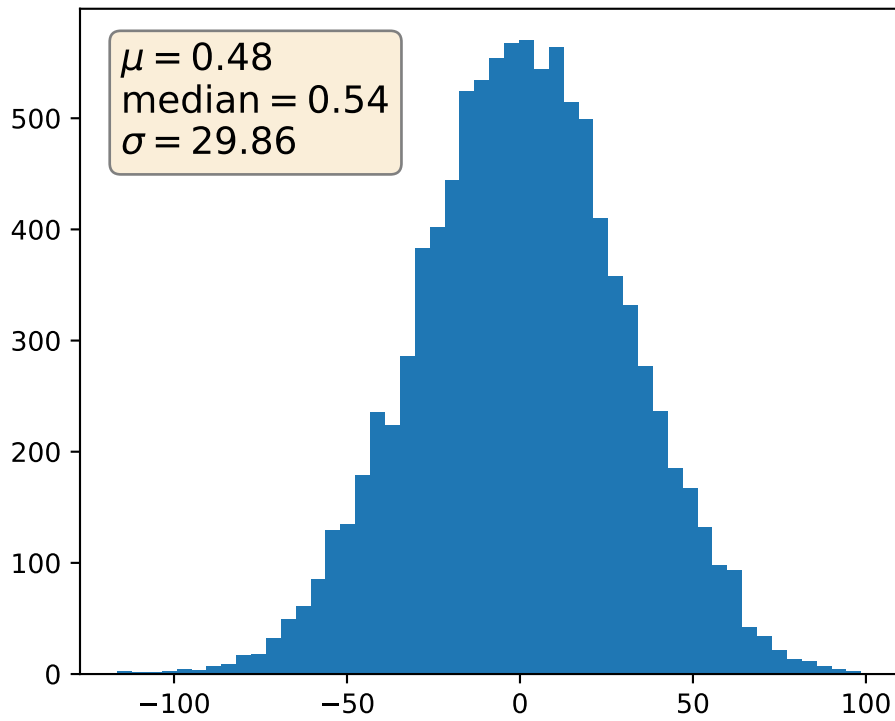

WHAT'S NEW IN MATPLOTLIB

For a list of all of the issues and pull requests since the last revision, see the *GitHub Stats*.

Table of Contents

- *What's new in matplotlib*
 - *New in matplotlib 2.0*
 - * *Default style changes*
 - * *Improved color conversion API and RGBA support*
 - * *New Configuration (rcParams)*
 - * *Qualitative colormaps*
 - * *Axis offset label now responds to labelcolor*
 - * *Improved offset text choice*
 - * *Style parameter blacklist*
 - * *Change in default font*
 - * *Faster text rendering*
 - * *Improvements for the Qt figure options editor*
 - * *Improved image support*
 - * *Support for HiDPI (Retina) displays in the NbAgg and WebAgg backends*
 - * *Change in the default animation codec*
 - * *Deprecated support for mencoder in animation*
 - * *Boxplot Zorder Keyword Argument*
 - * *Filled + and x markers*
 - * *rcount and ccount for plot_surface()*
 - * *Streamplot Zorder Keyword Argument Changes*
 - * *Extension to matplotlib.backend_bases.GraphicsContextBase*

9.1 New in matplotlib 2.0

Note: matplotlib 2.0 supports Python 2.7, and 3.4+

9.1.1 Default style changes

The major changes in v2.0 are related to overhauling the default styles.

Changes to the default style

The most important changes in matplotlib 2.0 are the changes to the default style.

While it is impossible to select the best default for all cases, these are designed to work well in the most common cases.

A ‘classic’ style sheet is provided so reverting to the 1.x default values is a single line of python

```
mpl.style.use('classic')
```

See *The matplotlibrc file* for details about how to persistently and selectively revert many of these changes.

Table of Contents

- *Colors, color cycles, and color maps*
 - *Colors in default property cycle*
 - *Colormap*
 - *Interactive figures*
 - *Grid lines*
- *Figure size, font size, and screen dpi*
- *Plotting functions*
 - *scatter*
 - *plot*
 - *errorbar*
 - *boxplot*
 - *fill_between and fill_betweenx*

- *Patch edges and color*
 - *bar and barh*
- *Hatching*
- *Fonts*
 - *Normal text*
 - *Math text*
- *Legends*
- *Image*
 - *Interpolation*
 - *Colormapping pipeline*
 - *Shading*
- *Plot layout*
 - *Auto limits*
 - *Z-order*
 - *Ticks*
 - *Tick label formatting*
- *mplot3d*

Colors, color cycles, and color maps

Colors in default property cycle

The colors in the default property cycle have been changed from ['b', 'g', 'r', 'c', 'm', 'y', 'k'] to the category10 color palette used by Vega and d3 originally developed at Tableau.

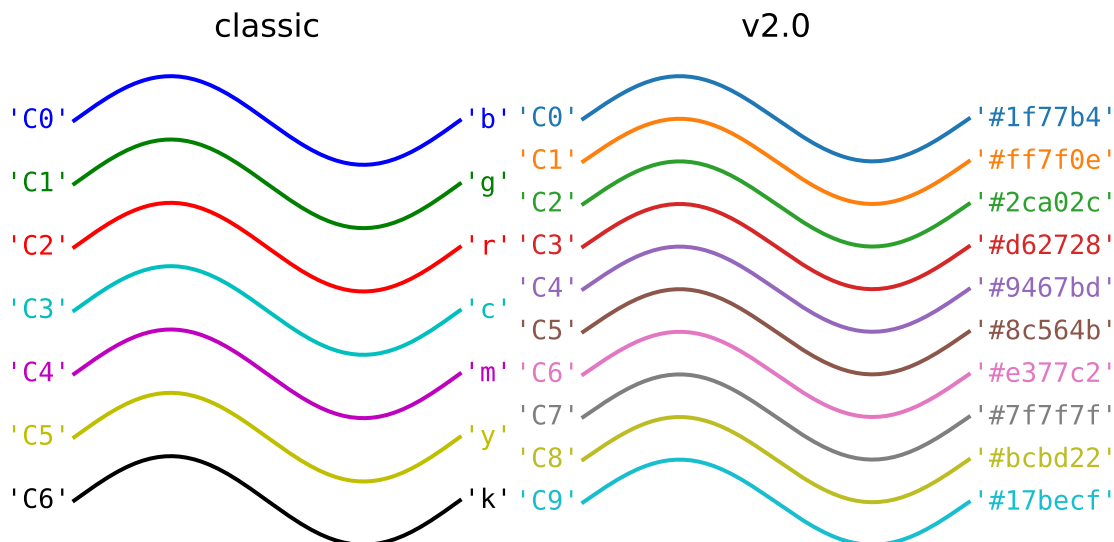

In addition to changing the colors, an additional method to specify colors was added. Previously, the default colors were the single character short-hand notations for red, green, blue, cyan, magenta, yellow, and black. This made them easy to type and usable in the abbreviated style string in `plot`, however the new default colors are only specified via hex values. To access these colors outside of the property cycling the notation for colors `'CN'`, where `N` takes values 0-9, was added to denote the first 10 colors in `mpl.rcParams['axes.prop_cycle']`. See *Specifying Colors* for more details.

To restore the old color cycle use

```
from cycler import cycler
mpl.rcParams['axes.prop_cycle'] = cycler(color='bgrcmyk')
```

or set

```
axes.prop_cycle : cycler('color', 'bgrcmyk')
```

in your `matplotlibrc` file.

Colormap

The new default color map used by `matplotlib.cm.ScalarMappable` instances is `'viridis'` (aka option D).

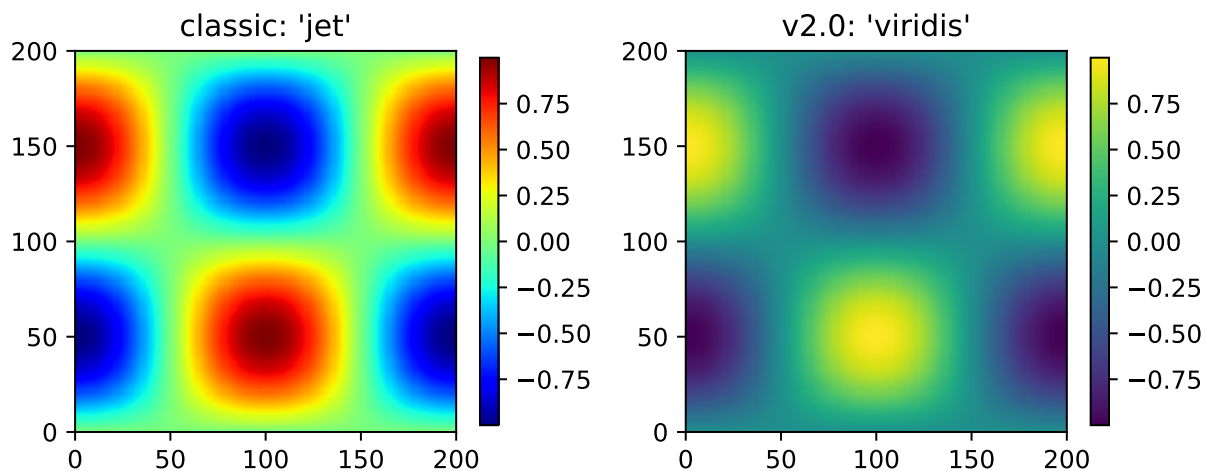

For an introduction to color theory and how ‘viridis’ was generated watch Nathaniel Smith and Stéfan van der Walt’s talk from SciPy2015. See [here](#) for many more details about the other alternatives and the tools used to create the color map. For details on all of the color maps available in matplotlib see *Choosing Colormaps*.

The previous default can be restored using

```
mpl.rcParams['image.cmap'] = 'jet'
```

or setting

```
image.cmap : 'jet'
```

in your `matplotlibrc` file; however this is strongly discouraged.

Interactive figures

The default interactive figure background color has changed from grey to white, which matches the default background color used when saving.

The previous defaults can be restored by

```
mpl.rcParams['figure.facecolor'] = '0.75'
```

or by setting

```
figure.facecolor : '0.75'
```

in your `matplotlibrc` file.

Grid lines

The default style of grid lines was changed from black dashed lines to thicker solid light grey lines.

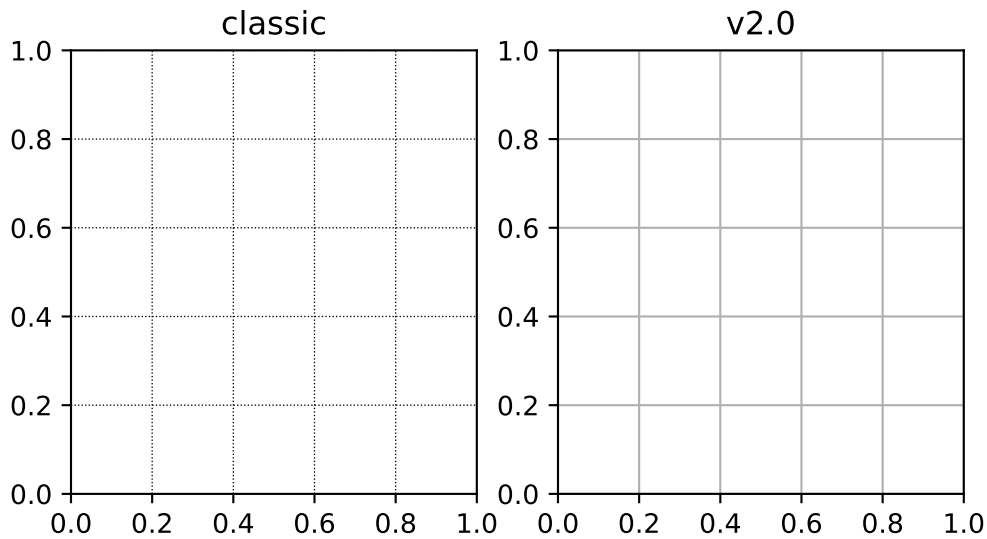

The previous default can be restored by using:

```
mpl.rcParams['grid.color'] = 'k'
mpl.rcParams['grid.linestyle'] = ':'
mpl.rcParams['grid.linewidth'] = 0.5
```

or by setting:

```
grid.color      : k      # grid color
grid.linestyle  : :      # dotted
grid.linewidth  : 0.5    # in points
```

in your `matplotlibrc` file.

Figure size, font size, and screen dpi

The default dpi used for on-screen display was changed from 80 dpi to 100 dpi, the same as the default dpi for saving files. Due to this change, the on-screen display is now more what-you-see-is-what-you-get for saved files. To keep the figure the same size in terms of pixels, in order to maintain approximately the same size on the screen, the default figure size was reduced from 8x6 inches to 6.4x4.8 inches. As a consequence of this the default font sizes used for the title, tick labels, and axes labels were reduced to maintain their size relative to the overall size of the figure. By default the dpi of the saved image is now the dpi of the *Figure* instance being saved.

This will have consequences if you are trying to match text in a figure directly with external text.

The previous defaults can be restored by

```
mpl.rcParams['figure.figsize'] = [8.0, 6.0]
mpl.rcParams['figure.dpi'] = 80
mpl.rcParams['savefig.dpi'] = 100

mpl.rcParams['font.size'] = 12
```

```
mpl.rcParams['legend.fontsize'] = 'large'
mpl.rcParams['figure.titlesize'] = 'medium'
```

or by setting:

```
figure(figsize : [8.0, 6.0]
figure.dpi    : 80
savefig.dpi   : 100

font.size     : 12.0
legend.fontsize : 'large'
figure.titlesize : 'medium'
```

In your `matplotlibrc` file.

In addition, the forward kwarg to `set_size_inches` now defaults to `True` to improve the interactive experience. Backend canvases that adjust the size of their bound `matplotlib.figure.Figure` must pass `forward=False` to avoid circular behavior. This default is not configurable.

Plotting functions

scatter

The following changes were made to the default behavior of `scatter`

- The default size of the elements in a scatter plot is now based on the rcParam `lines.markersize` so it is consistent with `plot(X, Y, 'o')`. The old value was 20, and the new value is 36 (6^2).
- scatter markers no longer have a black edge.
- if the color of the markers is not specified it will follow the property cycle, pulling from the ‘patches’ cycle on the Axes.

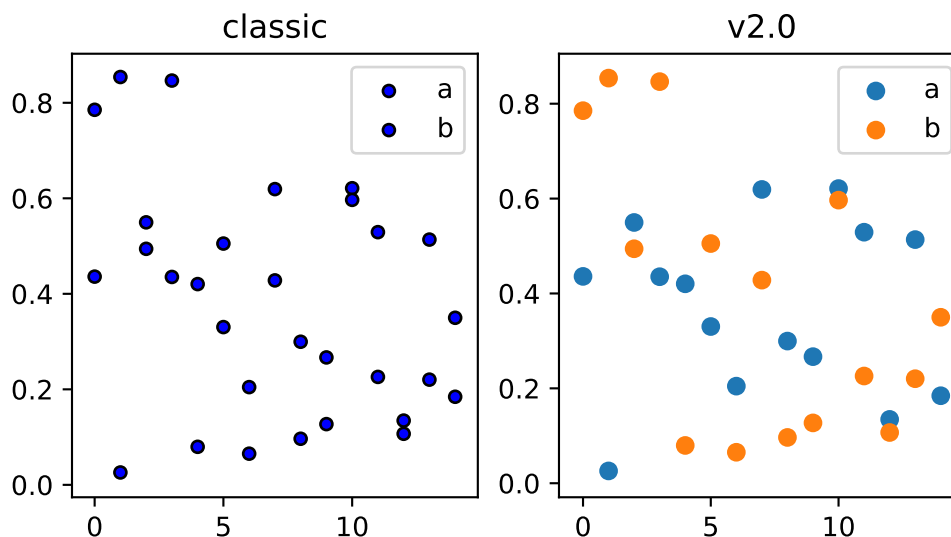

The classic default behavior of `scatter` can only be recovered through `mpl.style.use('classic')`. The marker size can be recovered via

```
mpl.rcParams['lines.markersize'] = np.sqrt(20)
```

however, this will also affect the default marker size of `plot`. To recover the classic behavior on a per-call basis pass the following kwargs:

```
classic_kwargs = {'s': 20, 'edgecolors': 'k', 'c': 'b'}
```

plot

The following changes were made to the default behavior of `plot`

- the default linewidth increased from 1 to 1.5
- the dash patterns associated with `--`, `:-`, and `-.` have changed
- the dash patterns now scale with line width

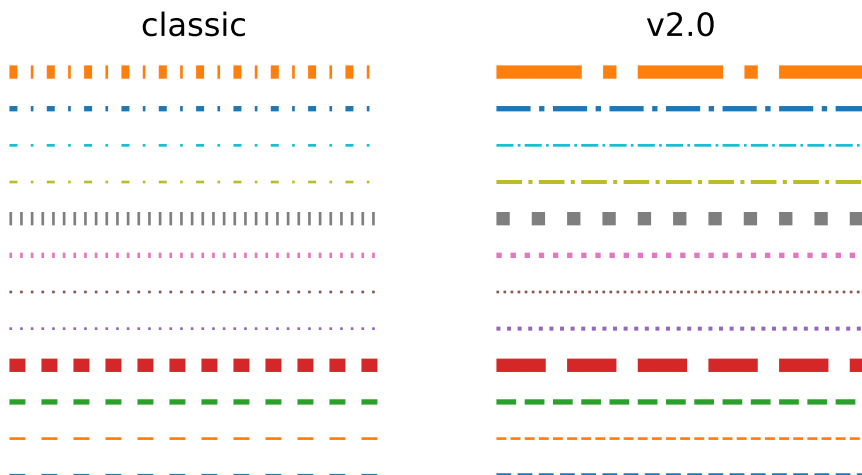

The previous defaults can be restored by setting:

```
mpl.rcParams['lines.linewidth'] = 1.0
mpl.rcParams['lines.dashed_pattern'] = [6, 6]
mpl.rcParams['lines.dashdot_pattern'] = [3, 5, 1, 5]
mpl.rcParams['lines.dotted_pattern'] = [1, 3]
mpl.rcParams['lines.scale_dashes'] = False
```

or by setting:

```
lines.linewidth : 1.0
lines.dashed_pattern : 6, 6
lines.dashdot_pattern : 3, 5, 1, 5
```

```
lines.dotted_pattern : 1, 3
lines.scale_dashes: False
```

in your `matplotlibrc` file.

errorbar

By default, caps on the ends of errorbars are not present.

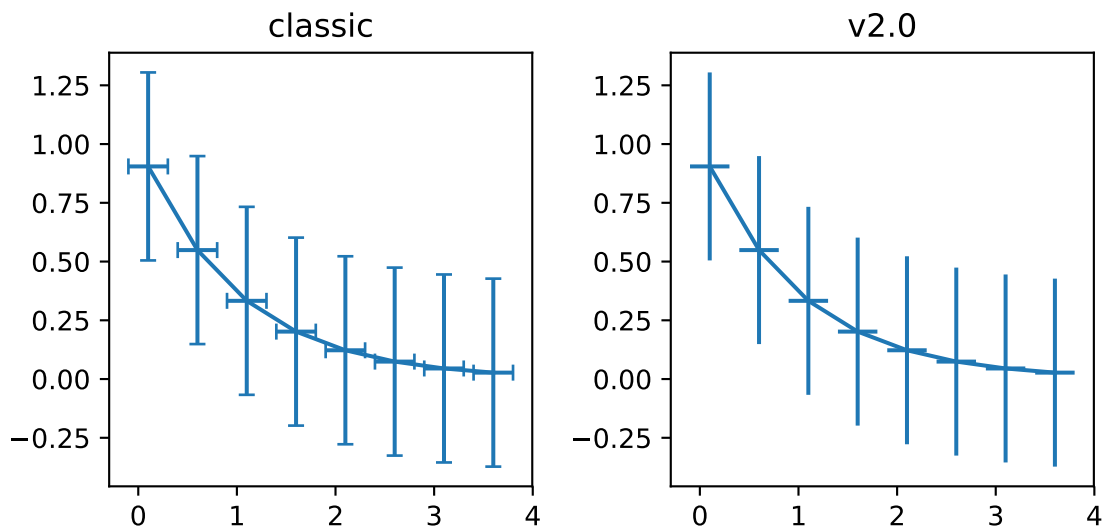

This also changes the return value of `errorbar()` as the list of ‘caplines’ will be empty by default.

The previous defaults can be restored by setting:

```
mpl.rcParams['errorbar.capsize'] = 3
```

or by setting

```
errorbar.capsize : 3
```

in your `matplotlibrc` file.

boxplot

Previously, boxplots were composed of a mish-mash of styles that were, for better for worse, inherited from Matlab. Most of the elements were blue, but the medians were red. The fliers (outliers) were black plus-symbols (+) and the whiskers were dashed lines, which created ambiguity if the (solid and black) caps were not drawn.

For the new defaults, everything is black except for the median and mean lines (if drawn), which are set to the first two elements of the current color cycle. Also, the default flier markers are now hollow circles, which maintain the ability of the plus-symbols to overlap without obscuring data too much.

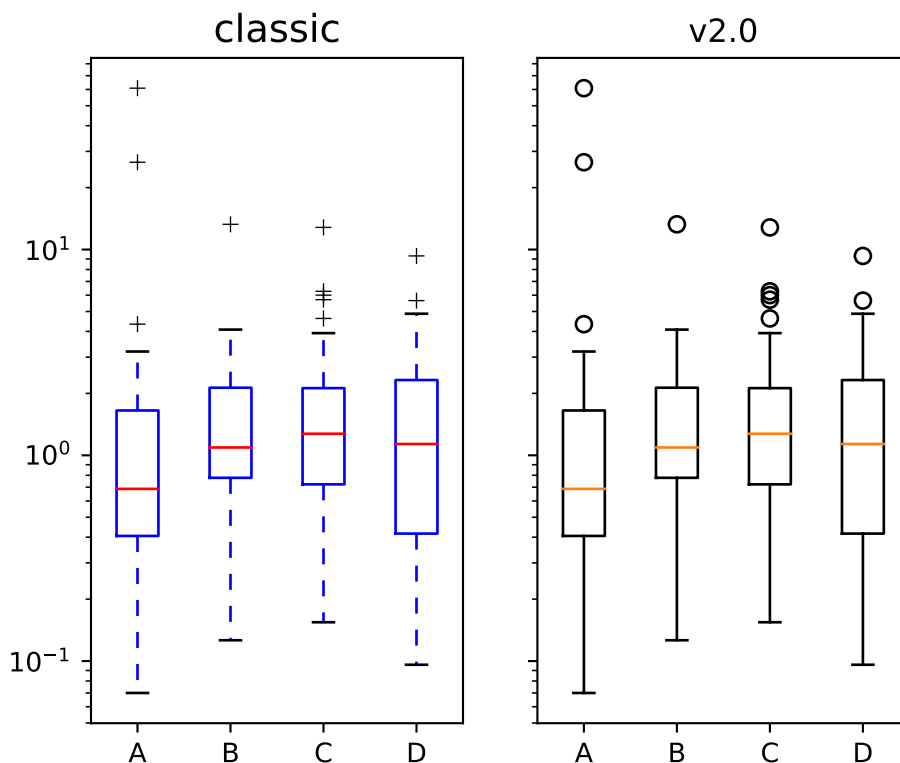

The previous defaults can be restored by setting:

```
mpl.rcParams['boxplot.flierprops.color'] = 'k'
mpl.rcParams['boxplot.flierprops.marker'] = '+'
mpl.rcParams['boxplot.flierprops.markerfacecolor'] = 'none'
mpl.rcParams['boxplot.flierprops.markeredgecolor'] = 'k'
mpl.rcParams['boxplot.boxprops.color'] = 'b'
mpl.rcParams['boxplot.whiskerprops.color'] = 'b'
mpl.rcParams['boxplot.whiskerprops.linestyle'] = '--'
mpl.rcParams['boxplot.medianprops.color'] = 'r'
mpl.rcParams['boxplot.meanprops.color'] = 'r'
mpl.rcParams['boxplot.meanprops.marker'] = '^'
mpl.rcParams['boxplot.meanprops.markerfacecolor'] = 'r'
mpl.rcParams['boxplot.meanprops.markeredgecolor'] = 'k'
mpl.rcParams['boxplot.meanprops.markersize'] = 6
mpl.rcParams['boxplot.meanprops.linestyle'] = '--'
mpl.rcParams['boxplot.meanprops.linewidth'] = 1.0
```

or by setting:

```
boxplot.flierprops.color:      'k'
boxplot.flierprops.marker:    '+'
boxplot.flierprops.markerfacecolor: 'none'
boxplot.flierprops.markeredgecolor: 'k'
boxplot.boxprops.color:      'b'
boxplot.whiskerprops.color:  'b'
```

```

boxplot.whiskerprops.linestyle:  '--'
boxplot.medianprops.color:      'r'
boxplot.meanprops.color:        'r'
boxplot.meanprops.marker:       '^'
boxplot.meanprops.markerfacecolor: 'r'
boxplot.meanprops.markeredgecolor: 'k'
boxplot.meanprops.markersize:    6
boxplot.meanprops.linestyle:     '--'
boxplot.meanprops.linewidth:    1.0

```

in your `matplotlibrc` file.

`fill_between` and `fill_betweenx`

`fill_between` and `fill_betweenx` both follow the patch color cycle.

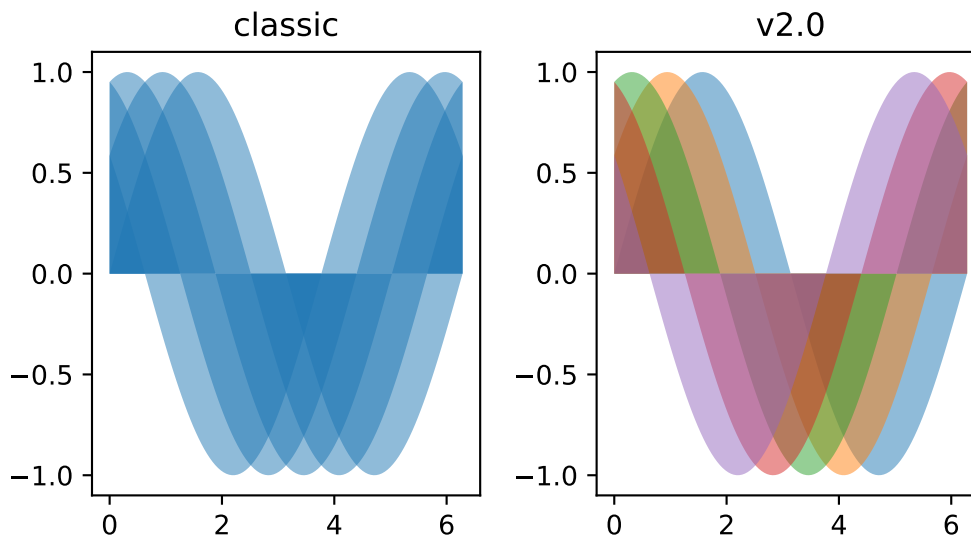

If the `facecolor` is set via the `facecolors` or `color` keyword argument, then the color is not cycled.

To restore the previous behavior, explicitly pass the keyword argument `facecolors='C0'` to the method call.

Patch edges and color

Most artists drawn with a patch (`~matplotlib.axes.Axes.bar`, `~matplotlib.axes.Axes.pie`, etc) no longer have a black edge by default. The default face color is now `'C0'` instead of `'b'`.

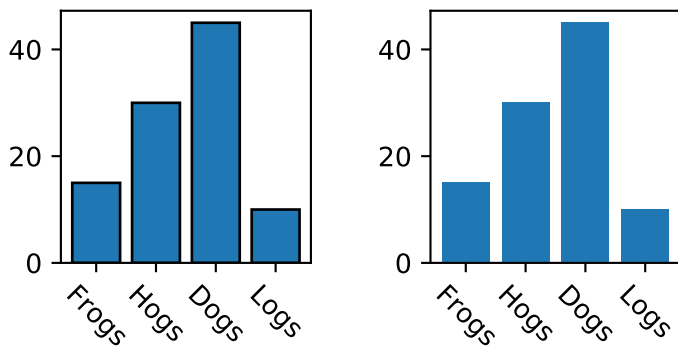
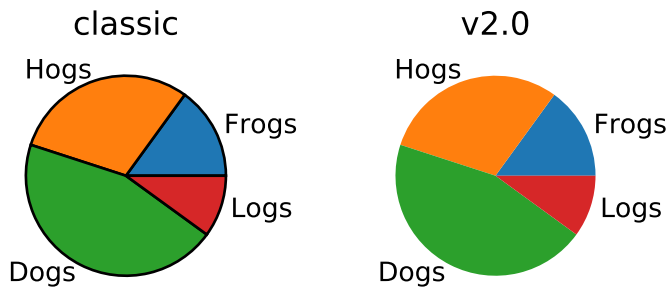

The previous defaults can be restored by setting:

```
mpl.rcParams['patch.force_edgecolor'] = True
mpl.rcParams['patch.facecolor'] = 'b'
```

or by setting:

```
patch.facecolor      : b
patch.force_edgecolor : True
```

in your matplotlibrc file.

bar and barh

The default value of the align kwarg for both bar and barh is changed from 'edge' to 'center'.

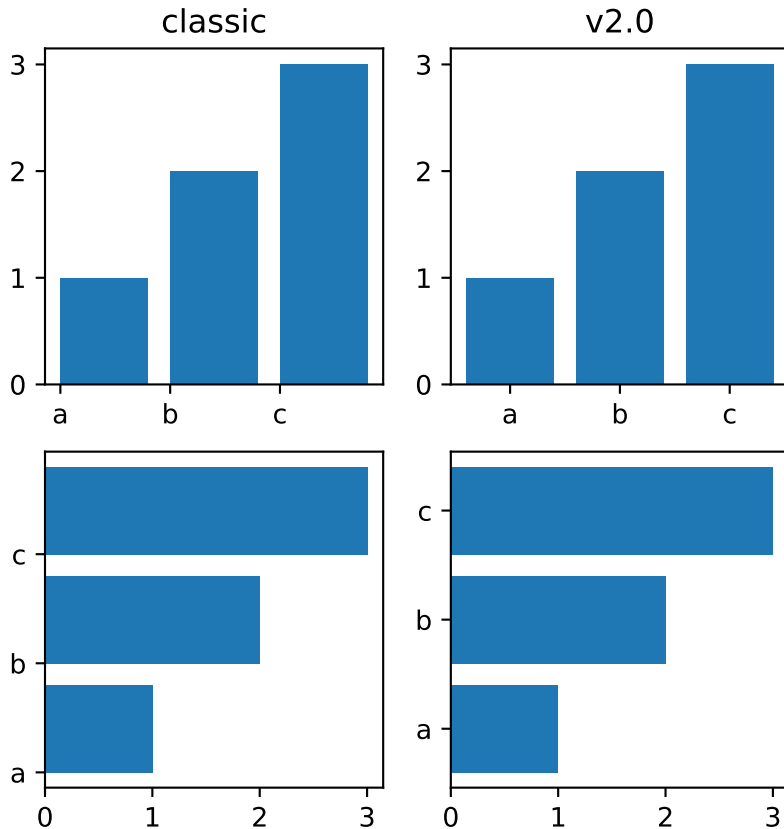

To restore the previous behavior explicitly pass the keyword argument `align='edge'` to the method call.

Hatching

The color of the lines in the hatch is now determined by

- If an edge color is explicitly set, use that for the hatch color
- If the edge color is not explicitly set, use `rcParam['hatch.color']` which is looked up at artist creation time.

The width of the lines in a hatch pattern is now configurable by the rcParams `hatch.linewidth`, which defaults to 1 point. The old behavior for the line width was different depending on backend:

- PDF: 0.1 pt
- SVG: 1.0 pt
- PS: 1 px
- Agg: 1 px

The old line width behavior can not be restored across all backends simultaneously, but can be restored for a single backend by setting:

```
mpl.rcParams['hatch.linewidth'] = 0.1 # previous pdf hatch linewidth
mpl.rcParams['hatch.linewidth'] = 1.0 # previous svg hatch linewidth
```

The behavior of the PS and Agg backends was DPI dependent, thus:

```
mpl.rcParams['figure.dpi'] = dpi
mpl.rcParams['savefig.dpi'] = dpi # or leave as default 'figure'
mpl.rcParams['hatch.linewidth'] = 1.0 / dpi # previous ps and Agg hatch linewidth
```

There is no direct API level control of the hatch color or linewidth.

Hatching patterns are now rendered at a consistent density, regardless of DPI. Formerly, high DPI figures would be more dense than the default, and low DPI figures would be less dense. This old behavior cannot be directly restored, but the density may be increased by repeating the hatch specifier.

Fonts

Normal text

The default font has changed from “Bitstream Vera Sans” to “DejaVu Sans”. DejaVu Sans has additional international and math characters, but otherwise has the same appearance as Bitstream Vera Sans. Latin, Greek, Cyrillic, Armenian, Georgian, Hebrew, and Arabic are **all supported** (but right-to-left rendering is still not handled by matplotlib). In addition, DejaVu contains a sub-set of emoji symbols.

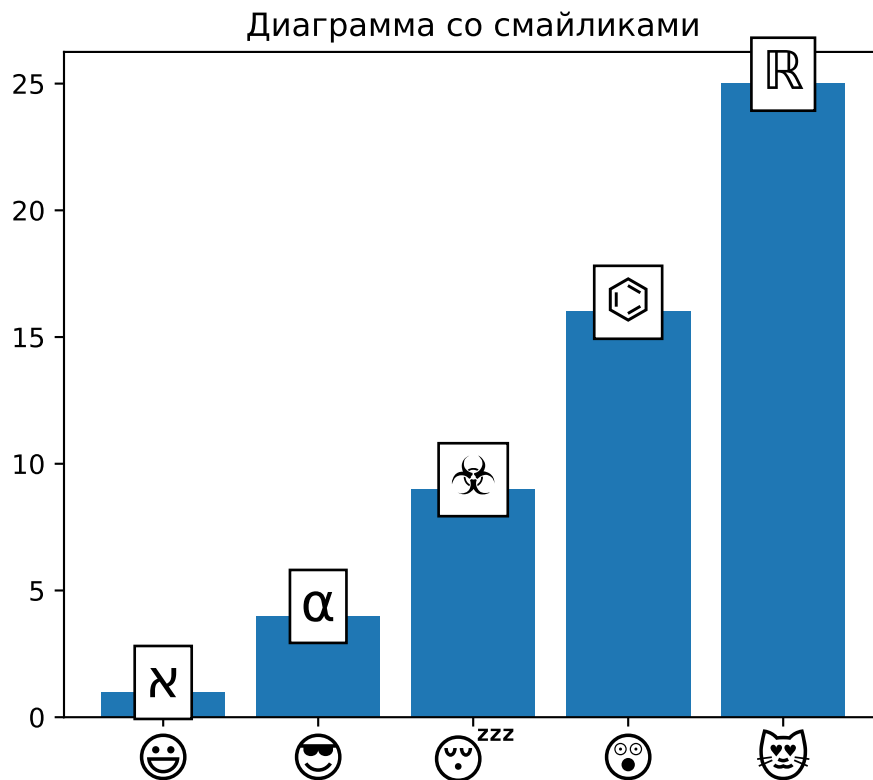

See the [DejaVu Sans PDF sample](#) for full coverage.

Math text

The default math font when using the built-in math rendering engine (`mathtext`) has changed from “Computer Modern” (i.e. LaTeX-like) to “DejaVu Sans”. This change has no effect if the TeX backend is used (i.e. `text.usestex` is True).

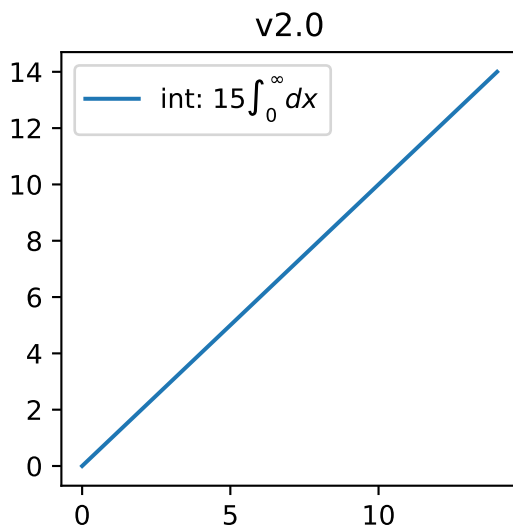
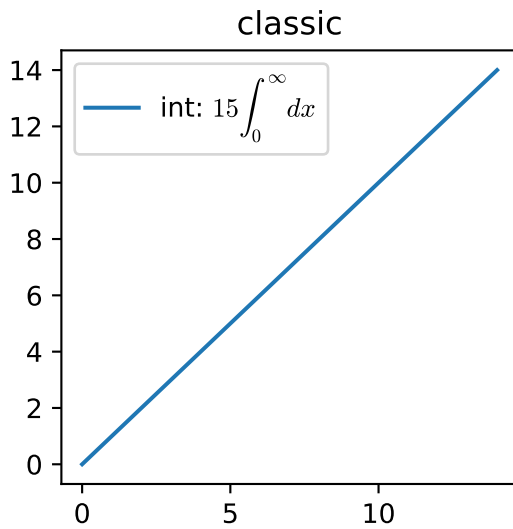

To revert to the old behavior set the:

```
mpl.rcParams['mathtext.fontset'] = 'cm'  
mpl.rcParams['mathtext.rm'] = 'serif'
```

or set:

```
mathtext.fontset: cm  
mathtext.rm : serif
```

in your `matplotlibrc` file.

This `rcParam` is consulted when the text is drawn, not when the artist is created. Thus all `mathtext` on a given canvas will use the same fontset.

Legends

- By default, the number of points displayed in a legend is now 1.
- The default legend location is 'best', so the legend will be automatically placed in a location to minimize overlap with data.
- The legend defaults now include rounded corners, a lighter boundary, and partially transparent boundary and background.

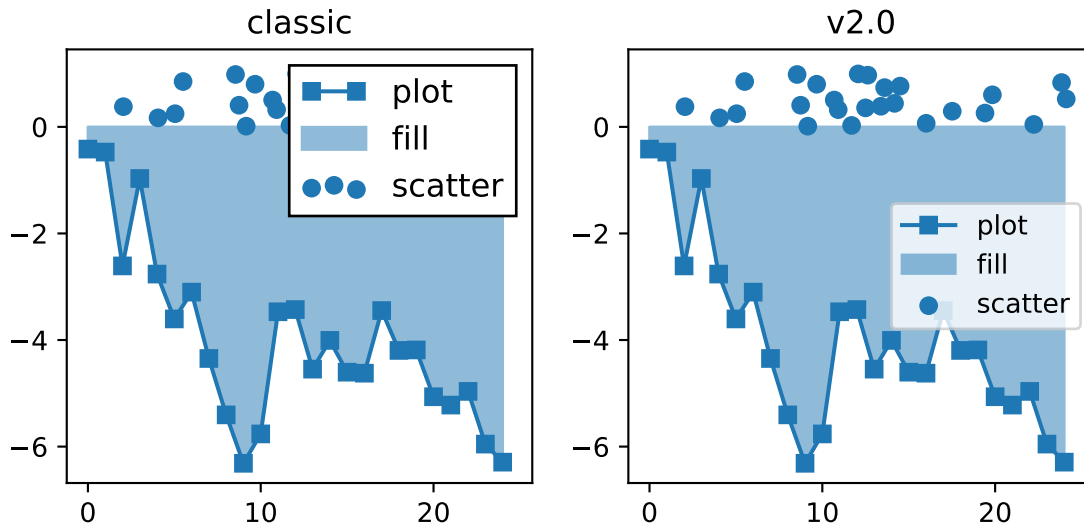

The previous defaults can be restored by setting:

```
mpl.rcParams['legend.fancybox'] = False
mpl.rcParams['legend.loc'] = 'upper right'
mpl.rcParams['legend.numpoints'] = 2
mpl.rcParams['legend.fontsize'] = 'large'
mpl.rcParams['legend.framealpha'] = None
mpl.rcParams['legend.scatterpoints'] = 3
mpl.rcParams['legend.edgecolor'] = 'inherit'
```

or by setting:

```
legend.fancybox      : False
legend.loc           : upper right
legend.numpoints     : 2      # the number of points in the legend line
legend.fontsize      : large
legend.framealpha    : None   # opacity of legend frame
legend.scatterpoints : 3     # number of scatter points
legend.edgecolor     : inherit # legend edge color ('inherit'
                               # means it uses axes.edgecolor)
```

in your `matplotlibrc` file.

Image

Interpolation

The default interpolation method for `imshow` is now 'nearest' and by default it resamples the data (both up and down sampling) before color mapping.

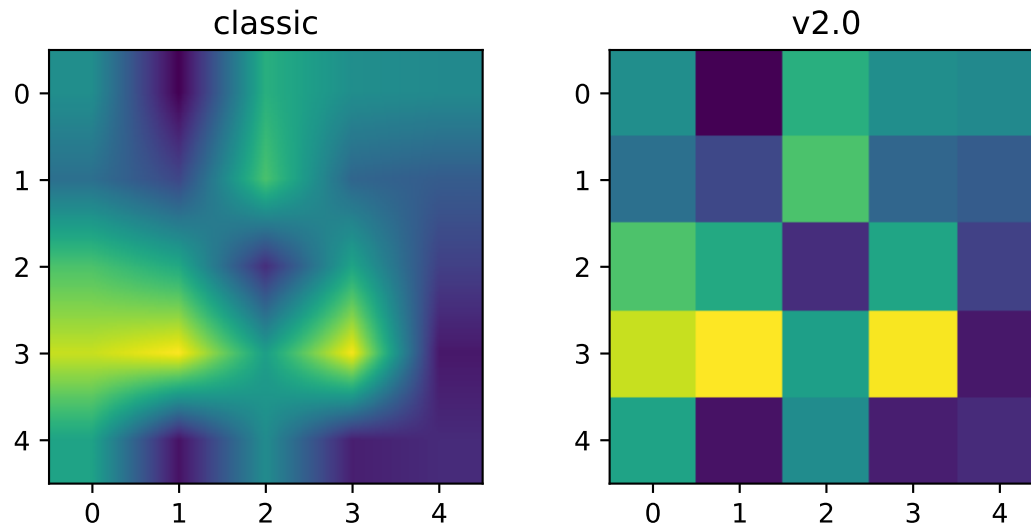

To restore the previous behavior set:

```
mpl.rcParams['image.interpolation'] = 'bilinear'
mpl.rcParams['image.resample'] = False
```

or set:

```
image.interpolation : bilinear # see help(imshow) for options
image.resample      : False
```

in your `matplotlibrc` file.

Colormapping pipeline

Previously, the input data was normalized, then color mapped, and then resampled to the resolution required for the screen. This meant that the final resampling was being done in color space. Because the color maps are not generally linear in RGB space, colors not in the color map may appear in the final image. This bug was addressed by an almost complete overhaul of the image handling code.

The input data is now normalized, then resampled to the correct resolution (in normalized dataspace), and then color mapped to RGB space. This ensures that only colors from the color map appear in the final image. (If your viewer subsequently resamples the image, the artifact may reappear.)

The previous behavior cannot be restored.

Shading

- The default shading mode for light source shading, in `matplotlib.colors.LightSource.shade`, is now `overlay`. Formerly, it was `hsv`.

Plot layout

Auto limits

The previous auto-scaling behavior was to find ‘nice’ round numbers as view limits that enclosed the data limits, but this could produce bad plots if the data happened to fall on a vertical or horizontal line near the chosen ‘round number’ limit. The new default sets the view limits to 5% wider than the data range.

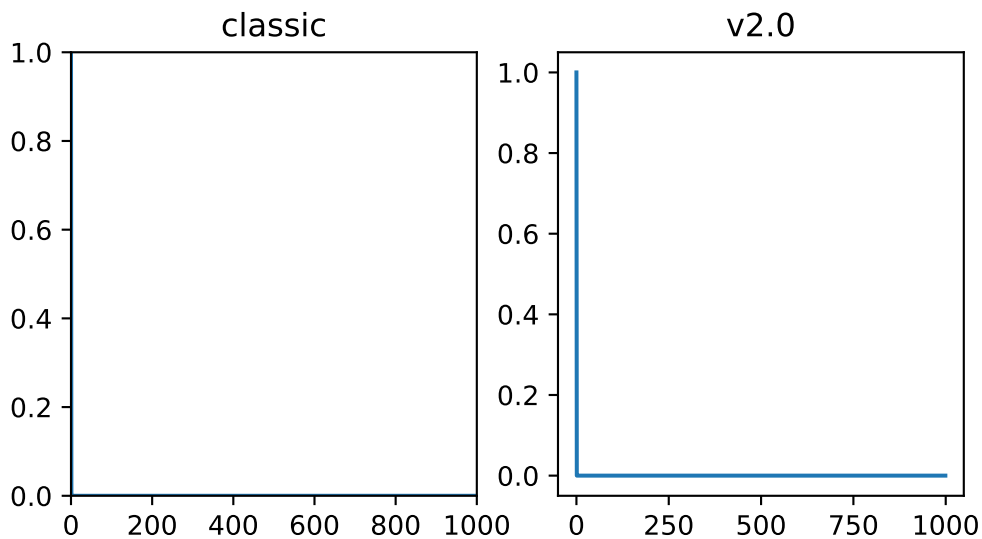

The size of the padding in the x and y directions is controlled by the `'axes.xmargin'` and `'axes.ymargin'` rcParams respectively. Whether the view limits should be ‘round numbers’ is controlled by the `'axes.autolimit_mode'` rcParam. In the original `'round_number'` mode, the view limits coincide with ticks.

The previous default can be restored by using:

```
mpl.rcParams['axes.autolimit_mode'] = 'round_numbers'
mpl.rcParams['axes.xmargin'] = 0
mpl.rcParams['axes.ymargin'] = 0
```

or setting:

```
axes.autolimit_mode: round_numbers
axes.xmargin: 0
axes.ymargin: 0
```

in your `matplotlibrc` file.

Z-order

- Ticks and grids are now plotted above solid elements such as filled contours, but below lines. To return to the previous behavior of plotting ticks and grids above lines, set `rcParams['axes.axisbelow'] = False`.

Ticks

Direction

To reduce the collision of tick marks with data, the default ticks now point outward by default. In addition, ticks are now drawn only on the bottom and left spines to prevent a porcupine appearance, and for a cleaner separation between subplots.

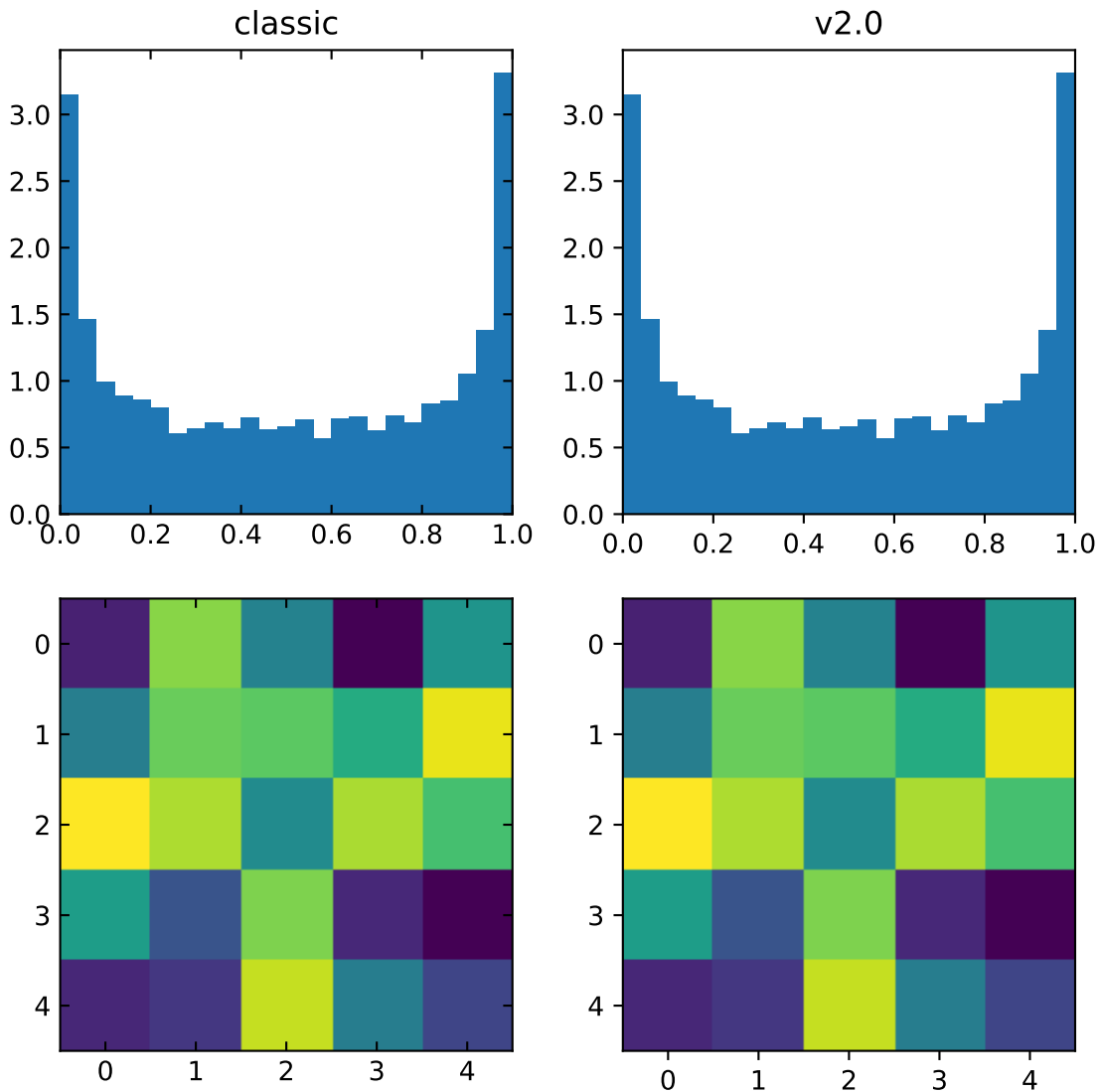

To restore the previous behavior set:

```
mpl.rcParams['xtick.direction'] = 'in'
mpl.rcParams['ytick.direction'] = 'in'
mpl.rcParams['xtick.top'] = True
mpl.rcParams['ytick.right'] = True
```

or set:

```
xtick.top: True
xtick.direction: in

ytick.right: True
ytick.direction: in
```

in your matplotlibrc file.

Number of ticks

The default *Locator* used for the x and y axis is *AutoLocator* which tries to find, up to some maximum number, ‘nicely’ spaced ticks. The locator now includes an algorithm to estimate the maximum number of ticks that will leave room for the tick labels. By default it also ensures that there are at least two ticks visible.

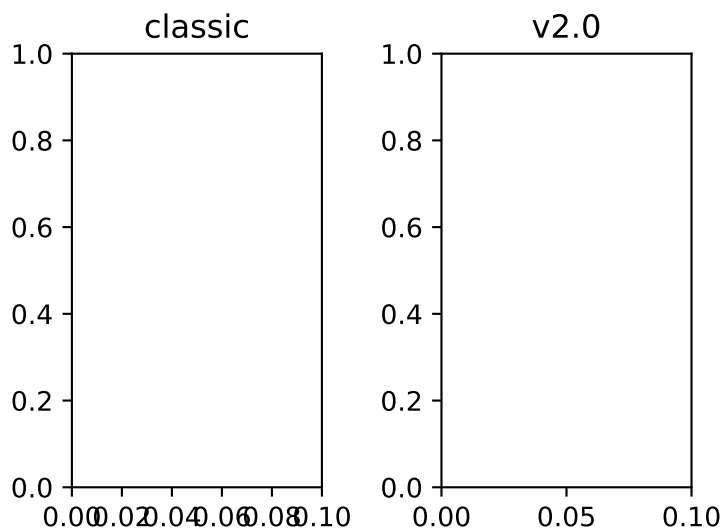

There is no way, other than using `mpl.style.use('classic')`, to restore the previous behavior as the default. On an axis-by-axis basis you may either control the existing locator via:

```
ax.xaxis.get_major_locator().set_params(nbins=9, steps=[1, 2, 5, 10])
```

or create a new *MaxNLocator*:

```
import matplotlib.ticker as mticker
ax.set_major_locator(mticker.MaxNLocator(nbins=9, steps=[1, 2, 5, 10]))
```

The algorithm used by *MaxNLocator* has been improved, and this may change the choice of tick locations in some cases. This also affects *AutoLocator*, which uses *MaxNLocator* internally.

For a log-scaled axis the default locator is the *LogLocator*. Previously the maximum number of ticks was set to 15, and could not be changed. Now there is a `numticks` kwarg for setting the maximum to any integer value, to the string 'auto', or to its default value of None which is equivalent to 'auto'. With the 'auto' setting the maximum number will be no larger than 9, and will be reduced depending on the length of the axis in units of the tick font size. As in the case of the *AutoLocator*, the heuristic algorithm reduces the incidence of overlapping tick labels but does not prevent it.

Tick label formatting

LogFormatter labeling of minor ticks

Minor ticks on a log axis are now labeled when the axis view limits span a range less than or equal to the interval between two major ticks. See *LogFormatter* for details. The minor tick labeling is turned off when using `mpl.style.use('classic')`, but cannot be controlled independently via `rcParams`.

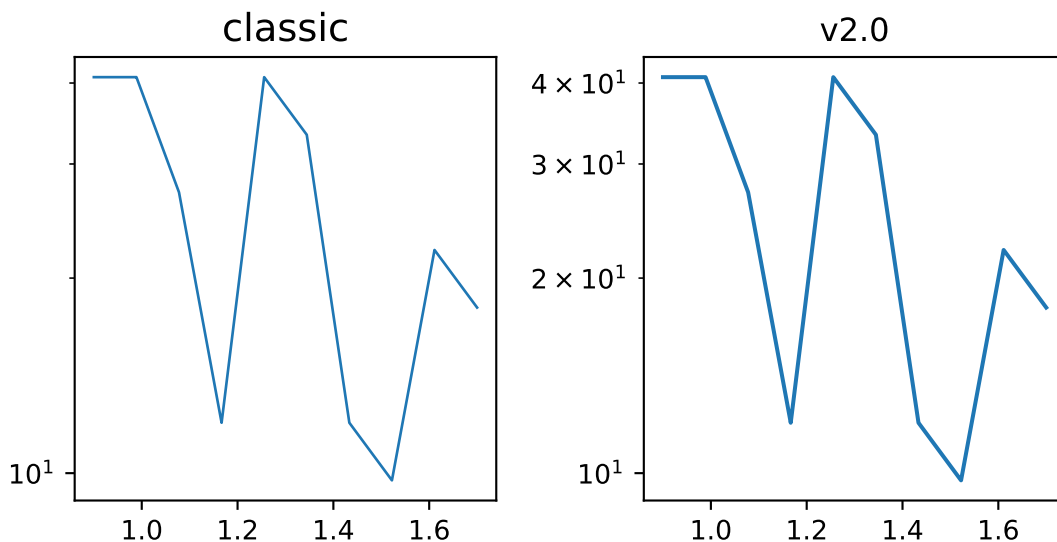

ScalarFormatter tick label formatting with offsets

With the default of `rcParams['axes.formatter.useoffset'] = True`, an offset will be used when it will save 4 or more digits. This can be controlled with the new `rcParam`, `axes.formatter.offset_threshold`. To restore the previous behavior of using an offset to save 2 or more digits, use `rcParams['axes.formatter.offset_threshold'] = 2`.

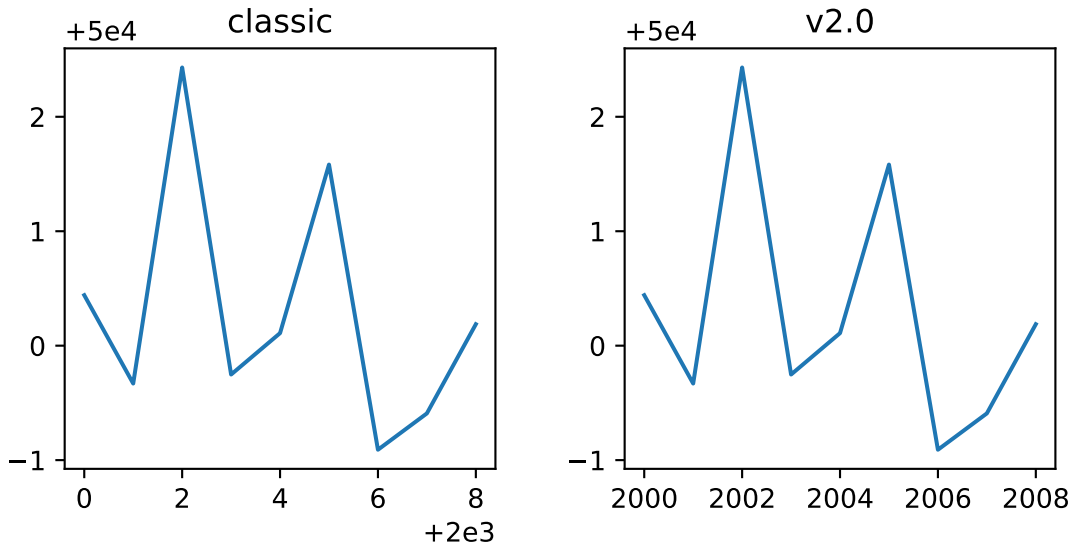

AutoDateFormatter format strings

The default date formats are now all based on ISO format, i.e., with the slowest-moving value first. The date formatters are configurable through the `date.autoformatter.*rcParams`.

Threshold (tick interval >= than)	rcParam	classic	v2.0
365 days	'date.autoformatter.year'	'%Y'	'%Y'
30 days	'date.autoformatter.month'	'%b %Y'	'%Y-%m'
1 day	'date.autoformatter.day'	'%b %d %Y'	'%Y-%m-%d'
1 hour	'date.autoformatter.hour'	'%H:%M:%S'	'%H:%M'
1 minute	'date.autoformatter.minute'	'%H:%M:%S. %f'	'%H:%M:%S'
1 second	'date.autoformatter.second'	'%H:%M:%S. %f'	'%H:%M:%S'
1 microsecond	'date.autoformatter. microsecond'	'%H:%M:%S. %f'	'%H:%M:%S. %f'

Python's `%x` and `%X` date formats may be of particular interest to format dates based on the current locale.

The previous default can be restored by:

```
mpl.rcParams['date.autoformatter.year'] = '%Y'
mpl.rcParams['date.autoformatter.month'] = '%b %Y'
mpl.rcParams['date.autoformatter.day'] = '%b %d %Y'
mpl.rcParams['date.autoformatter.hour'] = '%H:%M:%S'
mpl.rcParams['date.autoformatter.minute'] = '%H:%M:%S.%f'
mpl.rcParams['date.autoformatter.second'] = '%H:%M:%S.%f'
mpl.rcParams['date.autoformatter.microsecond'] = '%H:%M:%S.%f'
```

or setting

```
date.autoformatter.year      : %Y
date.autoformatter.month    : %b %Y
date.autoformatter.day      : %b %d %Y
date.autoformatter.hour     : %H:%M:%S
date.autoformatter.minute   : %H:%M:%S.%f
date.autoformatter.second   : %H:%M:%S.%f
date.autoformatter.microsecond : %H:%M:%S.%f
```

in your `matplotlibrc` file.

mplot3d

- `mplot3d` now obeys some style-related `rcParams`, rather than using hard-coded defaults. These include:
 - `xtick.major.width`
 - `ytick.major.width`
 - `xtick.color`
 - `ytick.color`
 - `axes.linewidth`
 - `axes.edgecolor`
 - `grid.color`
 - `grid.linewidth`
 - `grid.linestyle`

9.1.2 Improved color conversion API and RGBA support

The `colors` gained a new color conversion API with full support for the alpha channel. The main public functions are `is_color_like()`, `matplotlib.colors.to_rgba()`, `matplotlib.colors.to_rgba_array()` and `to_hex()`. RGBA quadruplets are encoded in hex format as `#rrggbbaa`.

A side benefit is that the Qt options editor now allows setting the alpha channel of the artists as well.

9.1.3 New Configuration (rcParams)

New `rcparams` added

Parameter	Description
<code>date.autoformatter.year</code>	format string for ‘year’ scale dates
<code>date.autoformatter.month</code>	format string for ‘month’ scale dates
<code>date.autoformatter.day</code>	format string for ‘day’ scale dates
<code>date.autoformatter.hour</code>	format string for ‘hour’ scale times
<code>date.autoformatter.minute</code>	format string for ‘minute’ scale times
<code>date.autoformatter.second</code>	format string for ‘second’ scale times
<code>date.autoformatter.microsecond</code>	format string for ‘microsecond’ scale times
<code>scatter.marker</code>	default marker for scatter plot
<code>svg.hashsalt</code>	see note
<code>xtick.top</code> , <code>xtick.minor.top</code> , <code>xtick.major.top</code> , <code>xtick.bottom</code> , <code>xtick.minor.bottom</code> , <code>xtick.major.bottom</code> <code>ytick.left</code> , <code>ytick.minor.left</code> , <code>ytick.major.left</code> , <code>ytick.right</code> , <code>ytick.minor.right</code> , <code>ytick.major.right</code>	Control where major and minor ticks are drawn. The global values are and ed with the corresponding major/minor values.
<code>hist.bins</code>	The default number of bins to use in <i>hist</i> . This can be an <code>int</code> , a list of floats, or ‘auto’ if <code>numpy >= 1.11</code> is installed.
<code>lines.scale_dashes</code>	Whether the line dash patterns should scale with linewidth.
<code>axes.formatter.offset_threshold</code>	Minimum number of digits saved in tick labels that triggers using an offset.

Added `svg.hashsalt` key to `rcParams`

If `svg.hashsalt` is `None` (which it is by default), the `svg` backend uses `uuid4` to generate the hash salt. If it is not `None`, it must be a string that is used as the hash salt instead of `uuid4`. This allows for deterministic SVG output.

Removed the `svg.image_noscale` `rcParam`

As a result of the extensive changes to image handling, the `svg.image_noscale` `rcParam` has been removed. The same functionality may be achieved by setting `interpolation='none'` on individual images or globally using the `image.interpolation` `rcParam`.

9.1.4 Qualitative colormaps

ColorBrewer’s “qualitative” colormaps (“Accent”, “Dark2”, “Paired”, “Pastel1”, “Pastel2”, “Set1”, “Set2”, “Set3”) were intended for discrete categorical data, with no implication of value, and therefore have been converted to `ListedColormap` instead of `LinearSegmentedColormap`, so the colors will no longer be interpolated and they can be used for choropleths, labeled image features, etc.

9.1.5 Axis offset label now responds to `labelcolor`

Axis offset labels are now colored the same as axis tick markers when `labelcolor` is altered.

9.1.6 Improved offset text choice

The default offset-text choice was changed to only use significant digits that are common to all ticks (e.g. 1231..1239 -> 1230, instead of 1231), except when they straddle a relatively large multiple of a power of ten, in which case that multiple is chosen (e.g. 1999..2001->2000).

9.1.7 Style parameter blacklist

In order to prevent unexpected consequences from using a style, style files are no longer able to set parameters that affect things unrelated to style. These parameters include:

```
'interactive', 'backend', 'backend.qt4', 'webagg.port',  
'webagg.port_retries', 'webagg.open_in_browser', 'backend_fallback',  
'toolbar', 'timezone', 'datapath', 'figure.max_open_warning',  
'savefig.directory', 'tk.window_focus', 'docstring.hardcopy'
```

9.1.8 Change in default font

The default font used by matplotlib in text has been changed to DejaVu Sans and DejaVu Serif for the sans-serif and serif families, respectively. The DejaVu font family is based on the previous matplotlib default –Bitstream Vera– but includes a much wider range of characters.

The default `mathtext` font has been changed from Computer Modern to the DejaVu family to maintain consistency with regular text. Two new options for the `mathtext.fontset` configuration parameter have been added: `dejavusans` (default) and `dejavuserif`. Both of these options use DejaVu glyphs whenever possible and fall back to STIX symbols when a glyph is not found in DejaVu. To return to the previous behavior, set the rcParam `mathtext.fontset` to `cm`.

9.1.9 Faster text rendering

Rendering text in the Agg backend is now less fuzzy and about 20% faster to draw.

9.1.10 Improvements for the Qt figure options editor

Various usability improvements were implemented for the Qt figure options editor, among which:

- Line style entries are now sorted without duplicates.
- The colormap and normalization limits can now be set for images.
- Line edits for floating values now display only as many digits as necessary to avoid precision loss. An important bug was also fixed regarding input validation using Qt5 and a locale where the decimal separator is ”,”.

- The axes selector now uses shorter, more user-friendly names for axes, and does not crash if there are no axes.
- Line and image entries using the default labels (“_lineX”, “_imageX”) are now sorted numerically even when there are more than 10 entries.

9.1.11 Improved image support

Prior to version 2.0, matplotlib resampled images by first applying the color map and then resizing the result. Since the resampling was performed on the colored image, this introduced colors in the output image that didn't actually exist in the color map. Now, images are resampled first (and entirely in floating-point, if the input image is floating-point), and then the color map is applied.

In order to make this important change, the image handling code was almost entirely rewritten. As a side effect, image resampling uses less memory and fewer datatype conversions than before.

The experimental private feature where one could “skew” an image by setting the private member `_image_skew_coordinate` has been removed. Instead, images will obey the transform of the axes on which they are drawn.

Non-linear scales on image plots

`imshow()` now draws data at the requested points in data space after the application of non-linear scales.

The image on the left demonstrates the new, correct behavior. The old behavior can be recreated using `pcolormesh()` as demonstrated on the right.

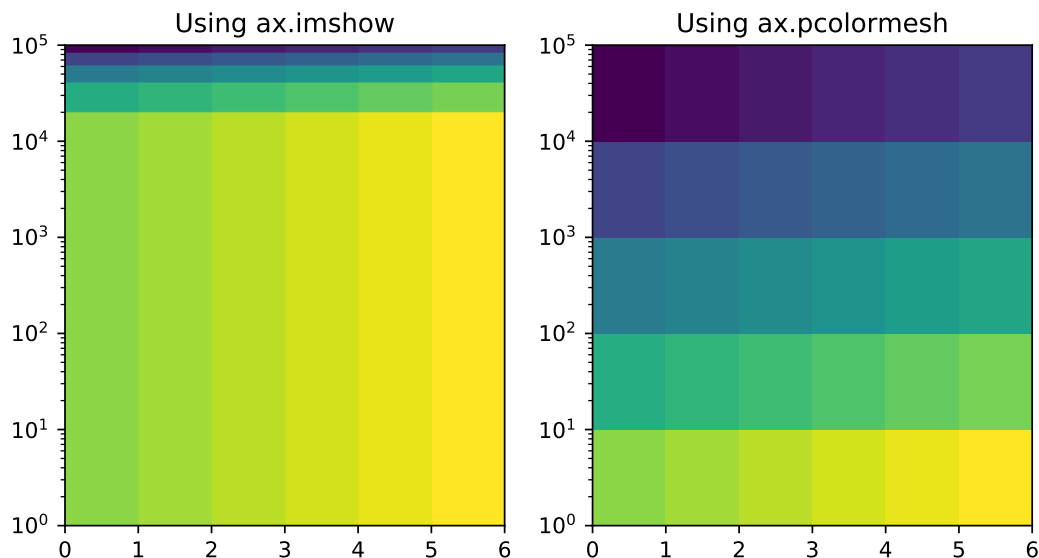

This can be understood by analogy to plotting a histogram with linearly spaced bins with a logarithmic x-axis. Equal sized bins will be displayed as wider for small x and narrower for large x .

9.1.12 Support for HiDPI (Retina) displays in the NbAgg and WebAgg backends

The NbAgg and WebAgg backends will now use the full resolution of your high-pixel-density display.

9.1.13 Change in the default animation codec

The default animation codec has been changed from mpeg4 to h264, which is more efficient. It can be set via the `animation.codec` rcParam.

9.1.14 Deprecated support for mencoder in animation

The use of mencoder for writing video files with mpl is problematic; switching to ffmpeg is strongly advised. All support for mencoder will be removed in version 2.2.

9.1.15 Boxplot Zorder Keyword Argument

The `zorder` parameter now exists for `boxplot()`. This allows the `zorder` of a boxplot to be set in the plotting function call.

```
boxplot(np.arange(10), zorder=10)
```

9.1.16 Filled + and x markers

New fillable *plus* and *x* markers have been added. See the [markers](#) module and [marker reference](#) examples.

9.1.17 rcount and ccount for plot_surface()

As of v2.0, `mplot3d`'s `plot_surface()` now accepts `rcount` and `ccount` arguments for controlling the sampling of the input data for plotting. These arguments specify the maximum number of evenly spaced samples to take from the input data. These arguments are also the new default sampling method for the function, and is considered a style change.

The old `rstride` and `cstride` arguments, which specified the size of the evenly spaced samples, become the default when 'classic' mode is invoked, and are still available for use. There are no plans for deprecating these arguments.

9.1.18 Streamplot Zorder Keyword Argument Changes

The `zorder` parameter for `streamplot()` now has default value of `None` instead of `2`. If `None` is given as `zorder`, `streamplot()` has a default `zorder` of `matplotlib.lines.Line2D.zorder`.

9.1.19 Extension to `matplotlib.backend_bases.GraphicsContextBase`

To support standardizing hatch behavior across the backends we ship the `matplotlib.backend_bases.GraphicsContextBase.get_hatch_color` method as added to `matplotlib.backend_bases.GraphicsContextBase`. This is only used during the render process in the backends we ship so will not break any third-party backends.

If you maintain a third-party backend which extends `GraphicsContextBase` this method is now available to you and should be used to color hatch patterns.

9.2 Previous Whats New

9.2.1 New in matplotlib 0.98.4

Table of Contents

- *New in matplotlib 0.98.4*
 - *Legend enhancements*
 - *Fancy annotations and arrows*
 - *Native OS X backend*
 - *psd amplitude scaling*
 - *Fill between*
 - *Lots more*

It's been four months since the last matplotlib release, and there are a lot of new features and bug-fixes.

Thanks to Charlie Moad for testing and preparing the source release, including binaries for OS X and Windows for python 2.4 and 2.5 (2.6 and 3.0 will not be available until numpy is available on those releases). Thanks to the many developers who contributed to this release, with contributions from Jae-Joon Lee, Michael Droettboom, Ryan May, Eric Firing, Manuel Metz, Jouni K. Seppänen, Jeff Whitaker, Darren Dale, David Kaplan, Michiel de Hoon and many others who submitted patches

Legend enhancements

Jae-Joon has rewritten the legend class, and added support for multiple columns and rows, as well as fancy box drawing. See `legend()` and `matplotlib.legend.Legend`.

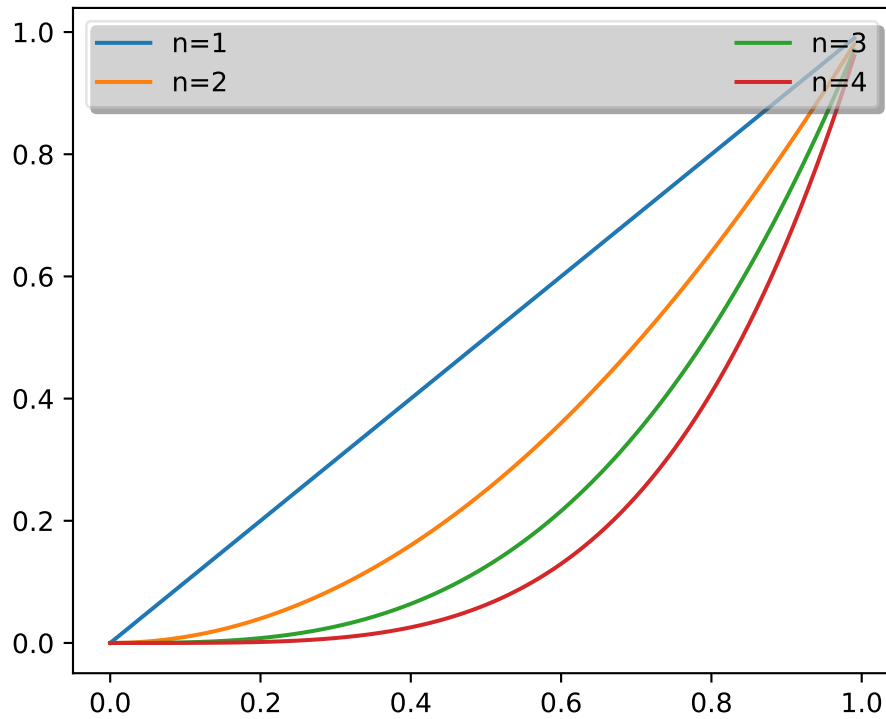

Fancy annotations and arrows

Jae-Joon has added lots of support to annotations for drawing fancy boxes and connectors in annotations. See `annotate()` and `BoxStyle`, `ArrowStyle`, and `ConnectionStyle`.

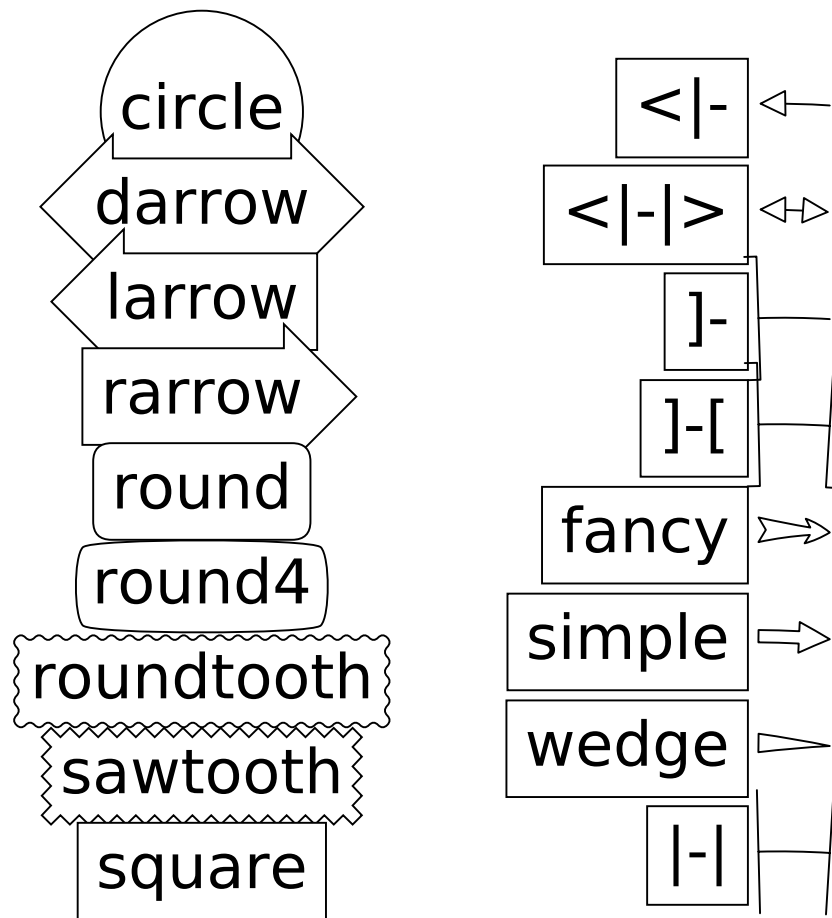

Native OS X backend

Michiel de Hoon has provided a native Mac OSX backend that is almost completely implemented in C. The backend can therefore use Quartz directly and, depending on the application, can be orders of magnitude faster than the existing backends. In addition, no third-party libraries are needed other than Python and NumPy. The backend is interactive from the usual terminal application on Mac using regular Python. It hasn't been tested with ipython yet, but in principle it should to work there as well. Set 'backend : macosx' in your matplotlibrc file, or run your script with:

```
> python myfile.py -dmacosx
```

psd amplitude scaling

Ryan May did a lot of work to rationalize the amplitude scaling of `psd()` and friends. See *pylab_examples example code: psd_demo2.py*. and *pylab_examples example code: psd_demo3.py*. The changes should increase MATLAB compatibility and increase scaling options.

Fill between

Added a `fill_between()` function to make it easier to do shaded region plots in the presence of masked data. You can pass an `x` array and a `ylower` and `yupper` array to fill between, and an optional `where` argument which is a logical mask where you want to do the filling.

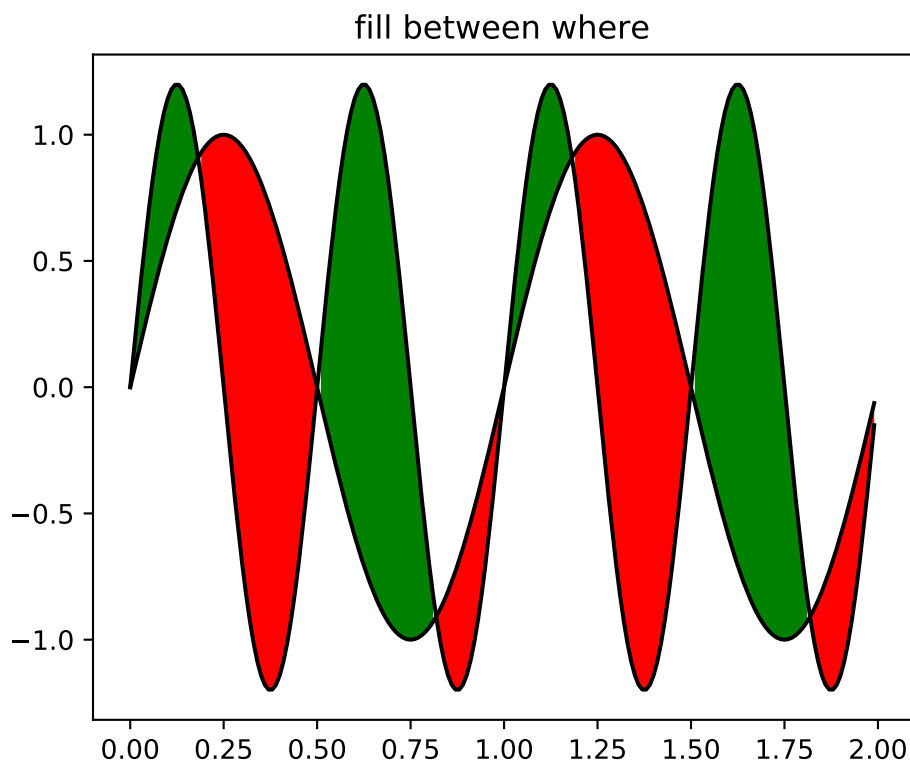

Lots more

Here are the 0.98.4 notes from the CHANGELOG:

```
Added mdehoon's native macosx backend from sf patch 2179017 - JDH
```

```
Removed the prints in the set_*style commands. Return the list of pretty-printed strings instead - JDH
```

```
Some of the changes Michael made to improve the output of the
```

`property` tables `in` the rest docs broke or made difficult to use some of the interactive doc helpers, e.g., `setp` `and` `getp`. Having `all` the rest markup `in` the ipython shell also confused the docstrings. I added a new rc param `docstring.harcopy`, to `format` the docstrings differently `for` `hardcopy` `and` other use. The `ArtistInspector` could use a little refactoring now since there `is` duplication of effort between the rest out put `and` the non-rest output - JDH

Updated spectral methods (`psd`, `csd`, etc.) to scale one-sided densities by a factor of `2` `and`, optionally, scale `all` densities by the sampling frequency. This gives better MATLAB compatibility. -RM

Fixed alignment of ticks `in` colorbars. -MGD

drop the deprecated `"new"` keyword of `np.histogram()` `for` `numpy 1.2` `or` later. -JJL

Fixed a bug `in` `svg` backend that `new_figure_manager()` ignores keywords arguments such `as` `figsize`, etc. -JJL

Fixed a bug that the `handlelength` of the new legend `class set` too short when `numpoints=1` -JJL

Added support `for` data `with` units (e.g., dates) to `Axes.fill_between`. -RM

Added `fancybox` keyword to legend. Also applied some changes `for` better look, including baseline adjustment of the multiline texts so that it `is` center aligned. -JJL

The `transmuter` classes `in` the `patches.py` are reorganized `as` subclasses of the `Style` classes. A few more box `and` arrow styles are added. -JJL

Fixed a bug `in` the new legend `class` that didn't allowed a tuple of coordinate values `as` `loc`. -JJL

Improve checks `for` external dependencies, using `subprocess` (instead of deprecated `popen*`) `and` `distutils` (`for` version checking) - DSD

Reimplementation of the legend which supports baseline alignment, multi-column, `and` `expand` mode. - JJL

Fixed histogram autoscaling bug when bins `or` `range` are given explicitly (fixes Debian bug 503148) - MM

Added rcParam `axes.unicode_minus` which allows plain hyphen `for` minus when `False` - JDH

Added scatterpoints support `in` Legend. patch by Erik Tollerud - JJL

Fix crash **in** log ticking. - MGD

Added static helper method BrokenHBarCollection.span_where **and** Axes/pyplot method fill_between. See examples/pylab/fill_between.py - JDH

Add x_isdata **and** y_isdata attributes to Artist instances, **and** use them to determine whether either **or** both coordinates are used when updating dataLim. This **is** used to fix autoscaling problems that had been triggered by axhline, axhspan, axvline, axvspan. - EF

Update the psd(), csd(), cohere(), **and** specgram() methods of Axes **and** the csd() cohere(), **and** specgram() functions **in** mlab to be **in** sync **with** the changes to psd(). In fact, under the hood, these **all** call the same core to do computations. - RM

Add 'pad_to' **and** 'sides' parameters to mlab.psd() to allow controlling of zero padding **and** returning of negative frequency components, respectively. These are added **in** a way that does **not** change the API. - RM

Fix handling of c kwarg by scatter; generalize is_string_like to accept numpy **and** numpy.ma string array scalars. - RM **and** EF

Fix a possible EINTR problem **in** dviread, which might help when saving pdf files **from the** qt backend. - JKS

Fix bug **with** zoom to rectangle **and** twin axes - MGD

Added Jae Joon's fancy arrow, box **and** annotation enhancements -- see examples/pylab_examples/annotation_demo2.py

Autoscaling **is** now supported **with** shared axes - EF

Fixed exception **in** dviread that happened **with** Minion - JKS

set_xlim, ylim now **return** a copy of the viewlim array to avoid modify inplace surprises

Added image thumbnail generating function matplotlib.image.thumbnail. See examples/misc/image_thumbnail.py - JDH

Applied scatleg patch based on ideas **and** work by Erik Tollerud **and** Jae-Joon Lee. - MM

Fixed bug **in** pdf backend: **if** you **pass** a file **object for** output instead of a filename, e.g., **in** a web app, we now flush the **object** at the end. - JKS

Add path simplification support to paths **with** gaps. - EF

Fix problem **with** AFM files that don't specify the font's full name **or** family name. - JKS

Added 'scilimits' kwarg to Axes.ticklabel_format() method, **for** easy access to the set_powerlimits method of the major ScalarFormatter. - EF

Experimental new kwarg borderpad to replace pad **in** legend, based on suggestion by Jae-Joon Lee. - EF

Allow spy to ignore zero values **in** sparse arrays, based on patch by Tony Yu. Also fixed plot to handle empty data arrays, **and** fixed handling of markers **in** figlegend. - EF

Introduce drawstyles **for** lines. Transparently split linestyles like 'steps--' into drawstyle 'steps' **and** linestyle '--'. Legends always use drawstyle 'default'. - MM

Fixed quiver **and** quiverkey bugs (failure to scale properly when resizing) **and** added additional methods **for** determining the arrow angles - EF

Fix polar interpolation to handle negative values of theta - MGD

Reorganized cbook **and** mlab methods related to numerical calculations that have little to do **with** the goals of those two modules into a separate module numerical_methods.py Also, added ability to select points **and** stop point selection **with** keyboard **in** ginput **and** manual contour labeling code. Finally, fixed contour labeling bug. - DMK

Fix backtick **in** Postscript output. - MGD

[2089958] Path simplification **for** vector output backends
Leverage the simplification code exposed through path_to_polygons to simplify certain well-behaved paths **in** the vector backends (PDF, PS **and** SVG). "path.simplify" must be set to True **in** matplotlibrc **for** this to work. - MGD

Add "filled" kwarg to Path.intersects_path **and** Path.intersects_bbox. - MGD

Changed full arrows slightly to avoid an xpdf rendering problem reported by Friedrich Hagedorn. - JKS

Fix conversion of quadratic to cubic Bezier curves **in** PDF **and** PS backends. Patch by Jae-Joon Lee. - JKS

Added 5-point star marker to plot command q- EF

Fix hatching **in** PS backend - MGD

Fix log **with** base 2 - MGD

Added support **for** bilinear interpolation **in** NonUniformImage; patch by Gregory Lielens. - EF

Added support **for** multiple histograms **with** data of different length - MM

Fix step plots **with** log scale - MGD

Fix masked arrays **with** markers **in** non-Agg backends - MGD

Fix clip_on kwarg so it actually works correctly - MGD

Fix locale problems **in** SVG backend - MGD

fix quiver so masked values are **not** plotted - JSW

improve interactive pan/zoom **in** qt4 backend on windows - DSD

Fix more bugs **in** NaN/inf handling. In particular, path simplification (which does **not** handle NaNs **or** infs) will be turned off automatically when infs **or** NaNs are present. Also masked arrays are now converted to arrays **with** NaNs **for** consistent handling of masks **and** NaNs - MGD **and** EF

Added support **for** arbitrary rasterization resolutions to the SVG backend. - MW

9.2.2 New in matplotlib 0.99

Table of Contents

- *New in matplotlib 0.99*
 - *New documentation*
 - *mplot3d*
 - *axes grid toolkit*
 - *Axis spine placement*

New documentation

Jae-Joon Lee has written two new guides *Legend guide* and *Advanced Annotation*. Michael Sarahan has written *Image tutorial*. John Hunter has written two new tutorials on working with paths and transformations: *Path Tutorial* and *Transformations Tutorial*.

mplot3d

Reinier Heeres has ported John Porter's `mplot3d` over to the new matplotlib transformations framework, and it is now available as a toolkit `mpl_toolkits.mplot3d` (which now comes standard with all mpl installs). See [mplot3d Examples](#) and [mplot3d tutorial](#)

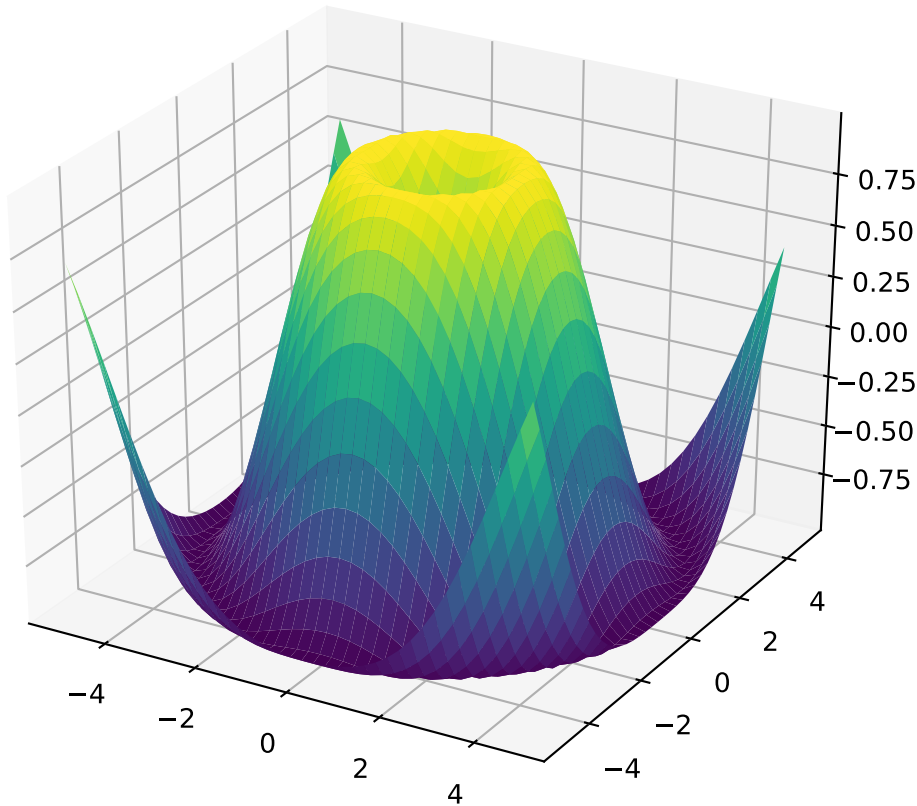

axes grid toolkit

Jae-Joon Lee has added a new toolkit to ease displaying multiple images in matplotlib, as well as some support for curvilinear grids to support the world coordinate system. The toolkit is included standard with all new mpl installs. See [axes_grid Examples](#) and [The Matplotlib AxesGrid Toolkit User's Guide](#).

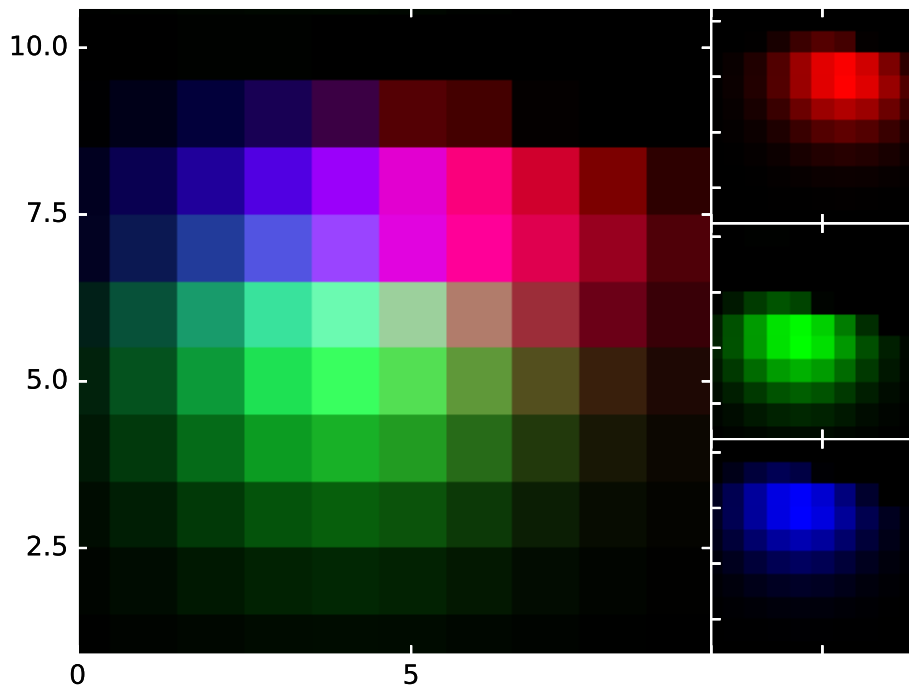

Axis spine placement

Andrew Straw has added the ability to place “axis spines” – the lines that denote the data limits – in various arbitrary locations. No longer are your axis lines constrained to be a simple rectangle around the figure – you can turn on or off left, bottom, right and top, as well as “detach” the spine to offset it away from the data. See [*pylab_examples example code: spine_placement_demo.py*](#) and [*matplotlib.spines.Spine*](#).

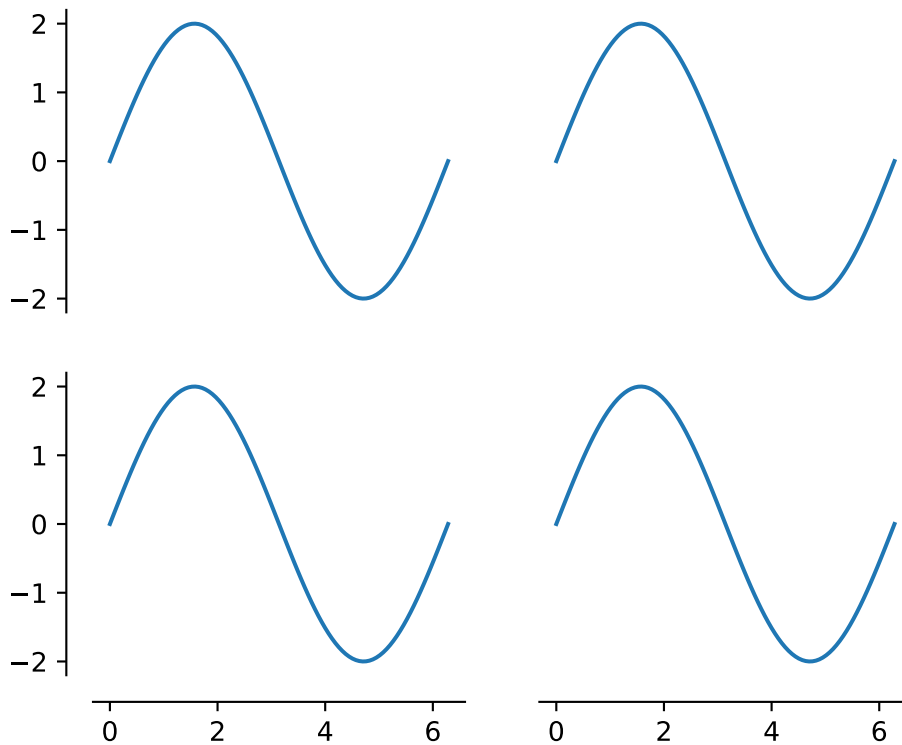

9.2.3 New in matplotlib 1.0

Table of Contents

- *New in matplotlib 1.0*
 - *HTML5/Canvas backend*
 - *Sophisticated subplot grid layout*
 - *Easy pythonic subplots*
 - *Contour fixes and and triplot*
 - *multiple calls to show supported*
 - *mplot3d graphs can be embedded in arbitrary axes*
 - *tick_params*
 - *Lots of performance and feature enhancements*
 - *Much improved software carpentry*
 - *Bugfix marathon*

HTML5/Canvas backend

Simon Ratcliffe and Ludwig Schwardt have released an [HTML5/Canvas](#) backend for matplotlib. The backend is almost feature complete, and they have done a lot of work comparing their html5 rendered images with our core renderer Agg. The backend features client/server interactive navigation of matplotlib figures in an html5 compliant browser.

Sophisticated subplot grid layout

Jae-Joon Lee has written [gridspec](#), a new module for doing complex subplot layouts, featuring row and column spans and more. See [Customizing Location of Subplot Using GridSpec](#) for a tutorial overview.

subplot2grid

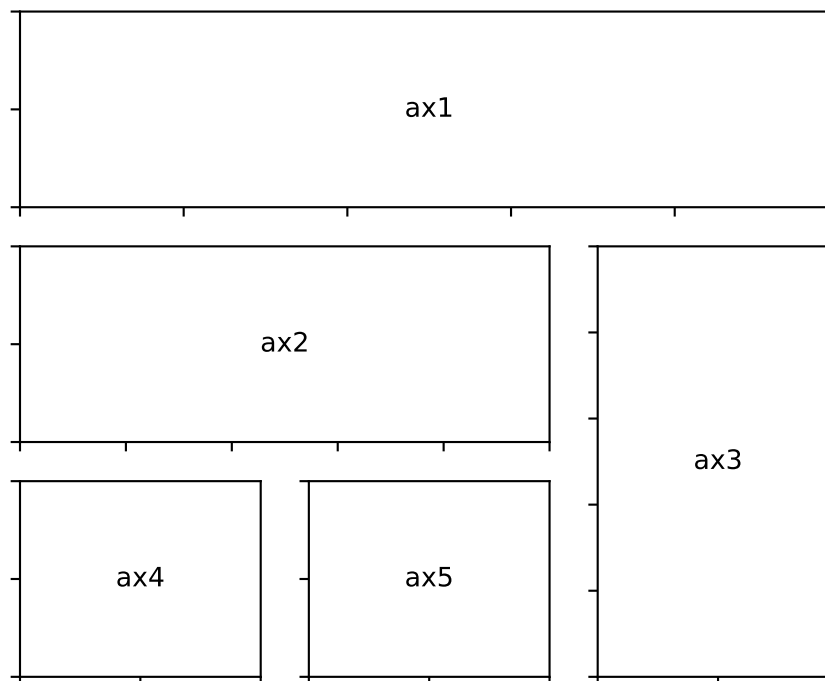

Easy pythonic subplots

Fernando Perez got tired of all the boilerplate code needed to create a figure and multiple subplots when using the matplotlib API, and wrote a [subplots\(\)](#) helper function. Basic usage allows you to create the figure and an array of subplots with numpy indexing (starts with 0). e.g.:

```
fig, axarr = plt.subplots(2, 2)
axarr[0,0].plot([1,2,3]) # upper, left
```

See [pylab_examples example code: subplots_demo.py](#) for several code examples.

Contour fixes and and triplot

Ian Thomas has fixed a long-standing bug that has vexed our most talented developers for years. `contourf()` now handles interior masked regions, and the boundaries of line and filled contours coincide.

Additionally, he has contributed a new module `tri` and helper function `triplot()` for creating and plotting unstructured triangular grids.

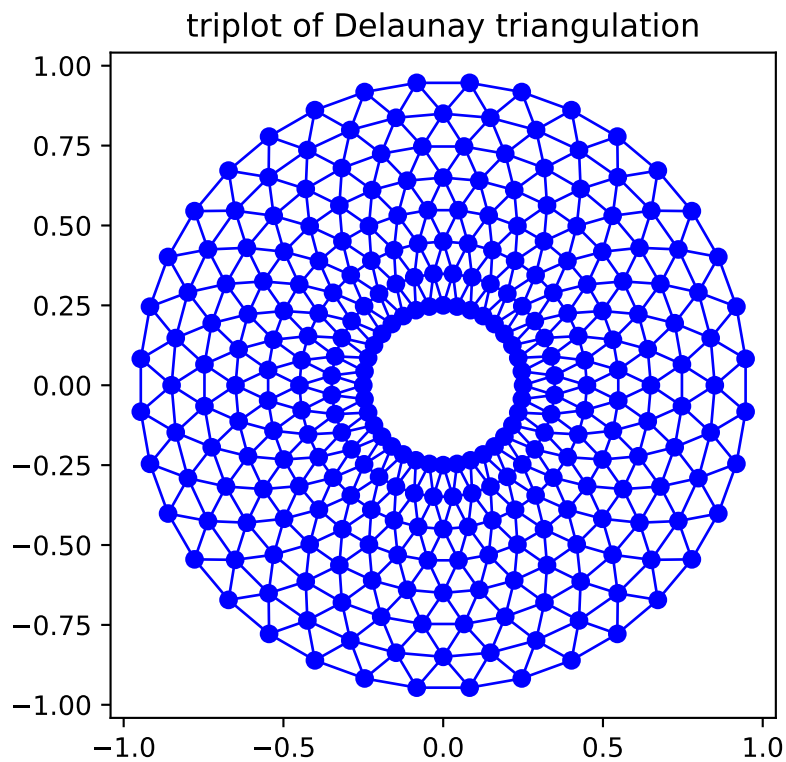

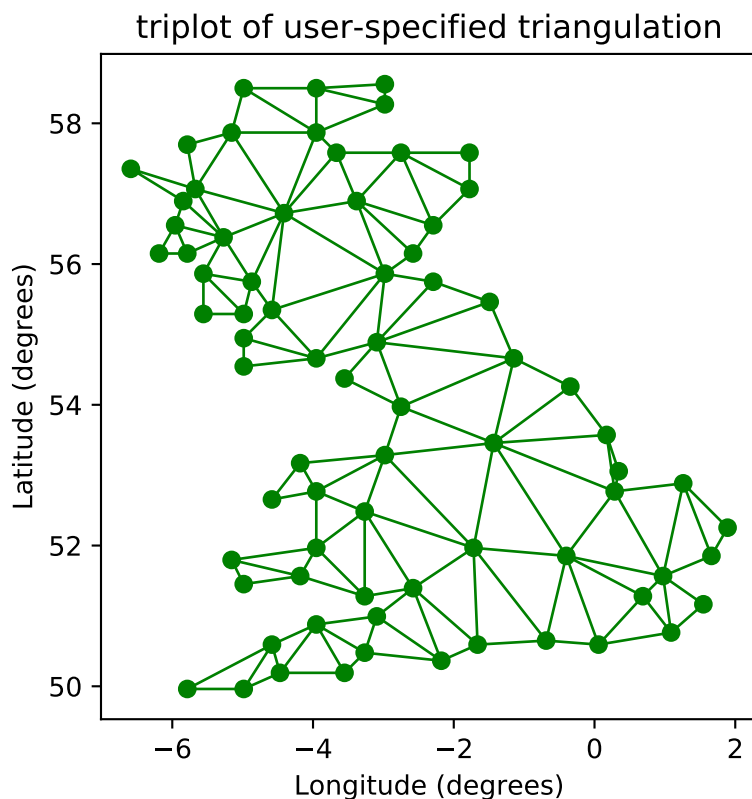

multiple calls to show supported

A long standing request is to support multiple calls to `show()`. This has been difficult because it is hard to get consistent behavior across operating systems, user interface toolkits and versions. Eric Firing has done a lot of work on rationalizing show across backends, with the desired behavior to make show raise all newly created figures and block execution until they are closed. Repeated calls to show should raise newly created figures since the last call. Eric has done a lot of testing on the user interface toolkits and versions and platforms he has access to, but it is not possible to test them all, so please report problems to the [mailing list](#) and [bug tracker](#).

mplot3d graphs can be embedded in arbitrary axes

You can now place an `mplot3d` graph into an arbitrary axes location, supporting mixing of 2D and 3D graphs in the same figure, and/or multiple 3D graphs in a single figure, using the “projection” keyword argument to `add_axes` or `add_subplot`. Thanks Ben Root.

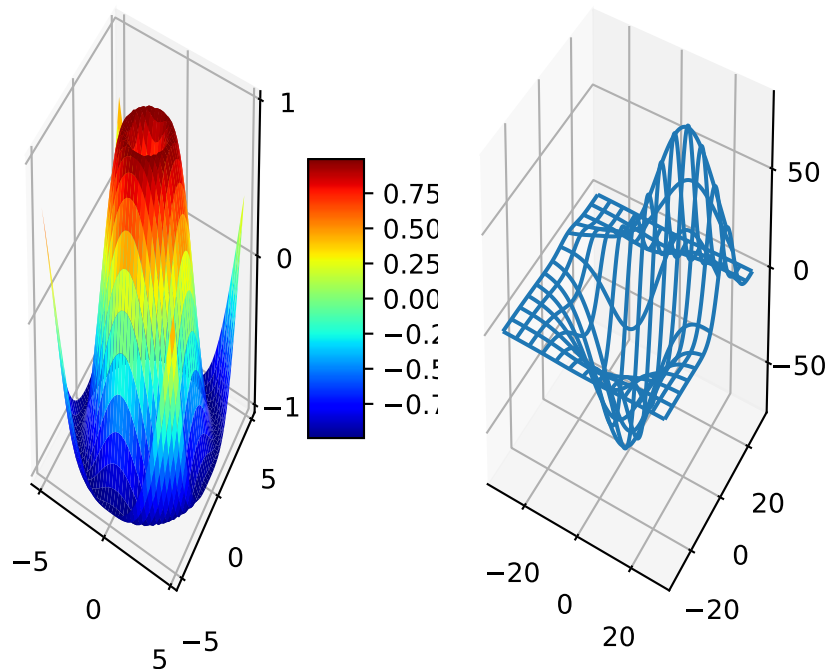

tick_params

Eric Firing wrote `tick_params`, a convenience method for changing the appearance of ticks and tick labels. See `pyplot` function `tick_params()` and associated `Axes` method `tick_params()`.

Lots of performance and feature enhancements

- Faster magnification of large images, and the ability to zoom in to a single pixel
- Local installs of documentation work better
- Improved “widgets” – mouse grabbing is supported
- More accurate snapping of lines to pixel boundaries
- More consistent handling of color, particularly the alpha channel, throughout the API

Much improved software carpentry

The matplotlib trunk is probably in as good a shape as it has ever been, thanks to improved [software carpentry](#). We now have a `buildbot` which runs a suite of `nose` regression tests on every svn commit, auto-generating a set of images and comparing them against a set of known-goods, sending emails to developers on failures

with a pixel-by-pixel image comparison. Releases and release bugfixes happen in branches, allowing active new feature development to happen in the trunk while keeping the release branches stable. Thanks to Andrew Straw, Michael Droettboom and other matplotlib developers for the heavy lifting.

Bugfix marathon

Eric Firing went on a bug fixing and closing marathon, closing over 100 bugs on the [bug tracker](#) with help from Jae-Joon Lee, Michael Droettboom, Christoph Gohlke and Michiel de Hoon.

9.2.4 New in matplotlib 1.1

Table of Contents

- *New in matplotlib 1.1*
 - *Sankey Diagrams*
 - *Animation*
 - *Tight Layout*
 - *PyQT4, PySide, and IPython*
 - *Legend*
 - *mplot3d*
 - *Numerix support removed*
 - *Markers*
 - *Other improvements*

Note: matplotlib 1.1 supports Python 2.4 to 2.7

Sankey Diagrams

Kevin Davies has extended Yannick Copin's original Sankey example into a module (*sankey*) and provided new examples (*api example code: sankey_demo_basics.py*, *api example code: sankey_demo_links.py*, *api example code: sankey_demo_rankine.py*).

Rankine Power Cycle: Example 8.6 from Moran and Shapiro
 "Fundamentals of Engineering Thermodynamics ", 6th ed., 2008

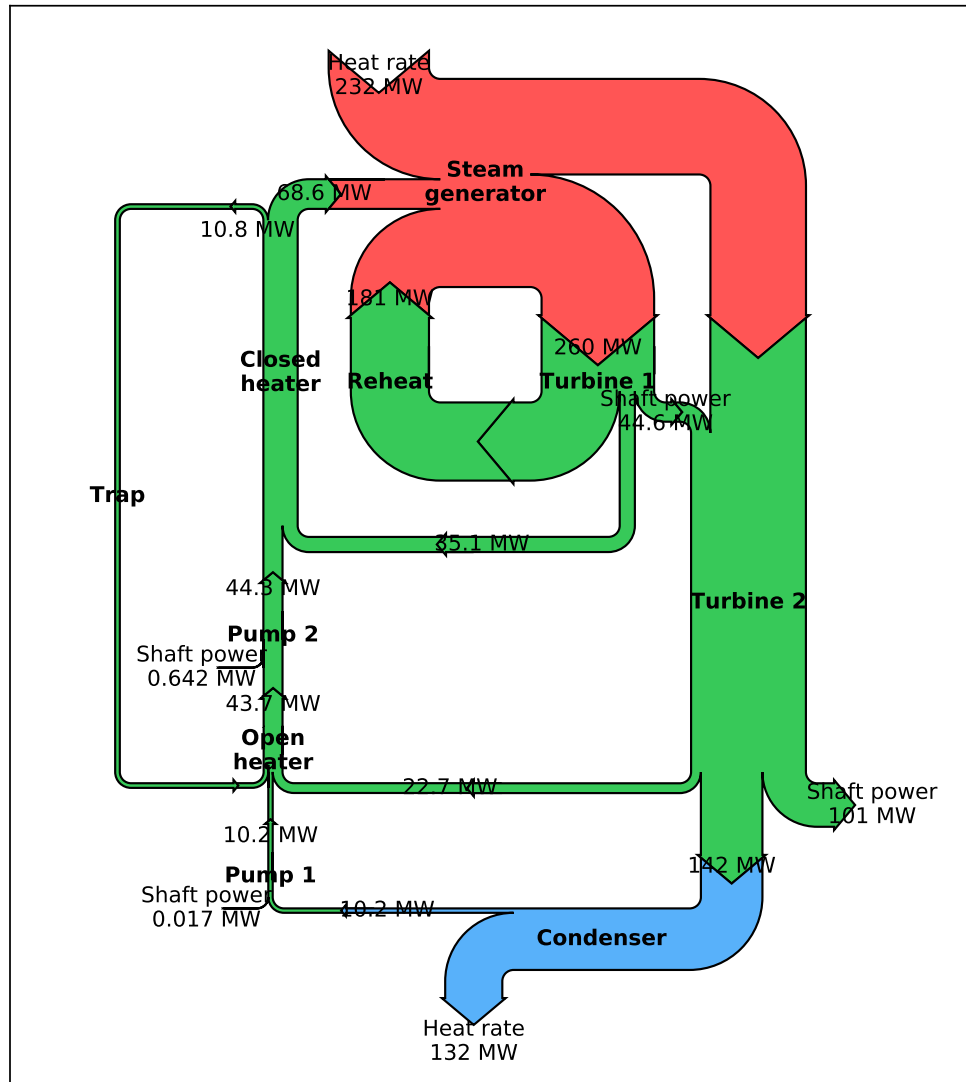

Animation

Ryan May has written a backend-independent framework for creating animated figures. The `animation` module is intended to replace the backend-specific examples formerly in the `Matplotlib Examples` listings. Examples using the new framework are in `animation Examples`; see the entrancing `double pendulum` which uses `matplotlib.animation.Animation.save()` to create the movie below.

This should be considered as a beta release of the framework; please try it and provide feedback.

Tight Layout

A frequent issue raised by users of matplotlib is the lack of a layout engine to nicely space out elements of the plots. While matplotlib still adheres to the philosophy of giving users complete control over the placement of plot elements, Jae-Joon Lee created the `tight_layout` module and introduced a new command `tight_layout()` to address the most common layout issues.

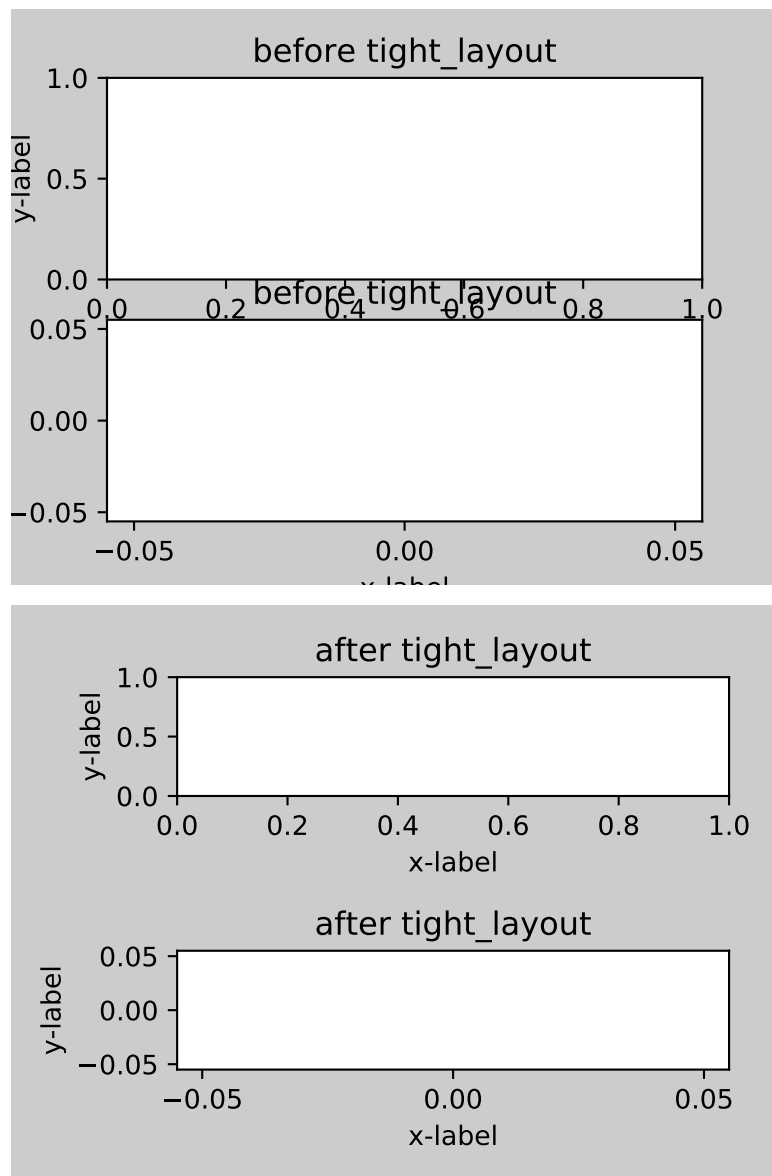

The usage of this functionality can be as simple as

```
plt.tight_layout()
```

and it will adjust the spacing between subplots so that the axis labels do not overlap with neighboring subplots. A *Tight Layout guide* has been created to show how to use this new tool.

PyQT4, PySide, and IPython

Gerald Storer made the Qt4 backend compatible with PySide as well as PyQt4. At present, however, PySide does not support the `PyOS_InputHook` mechanism for handling gui events while waiting for text input, so it cannot be used with the new version 0.11 of `IPython`. Until this feature appears in PySide, IPython users should use the PyQt4 wrapper for Qt4, which remains the matplotlib default.

An rcParam entry, “`backend.qt4`”, has been added to allow users to select PyQt4, PyQt4v2, or PySide. The latter two use the Version 2 Qt API. In most cases, users can ignore this rcParam variable; it is available to aid in testing, and to provide control for users who are embedding matplotlib in a PyQt4 or PySide app.

Legend

Jae-Joon Lee has improved plot legends. First, legends for complex plots such as `stem()` plots will now display correctly. Second, the ‘best’ placement of a legend has been improved in the presence of NaNs.

See the [Legend guide](#) for more detailed explanation and examples.

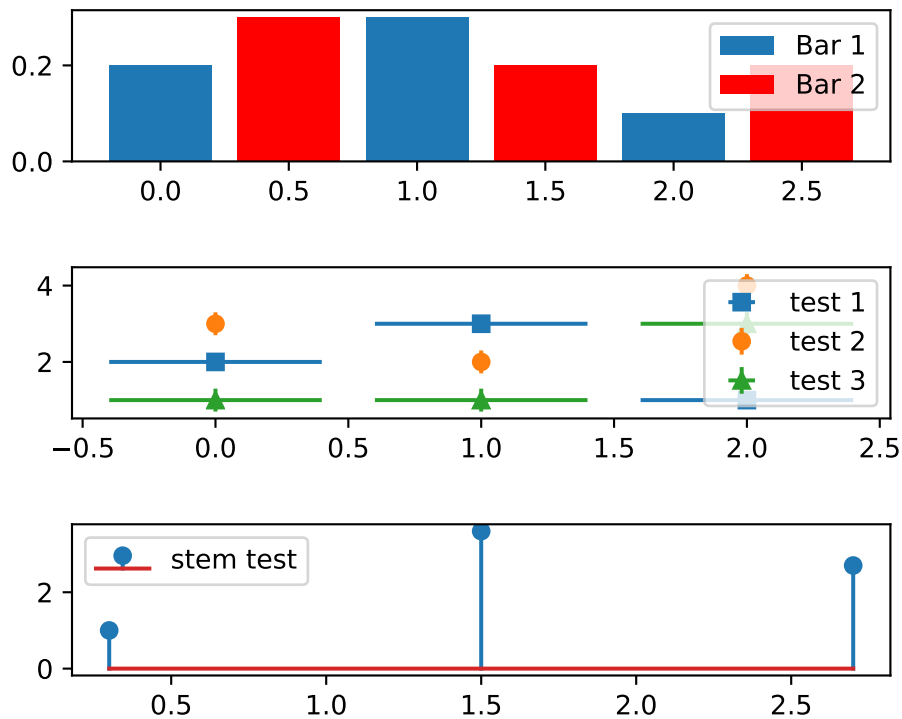

mplot3d

In continuing the efforts to make 3D plotting in matplotlib just as easy as 2D plotting, Ben Root has made several improvements to the `mplot3d` module.

- `Axes3D` has been improved to bring the class towards feature-parity with regular Axes objects
- Documentation for `mplot3d` was significantly expanded
- Axis labels and orientation improved
- Most 3D plotting functions now support empty inputs
- Ticker offset display added:

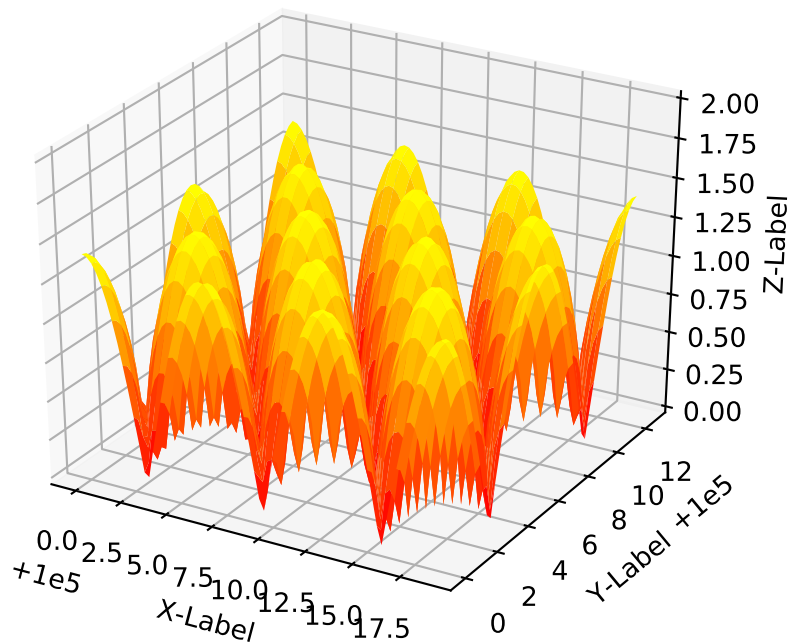

- `contourf()` gains `zdir` and `offset` kwargs. You can now do this:

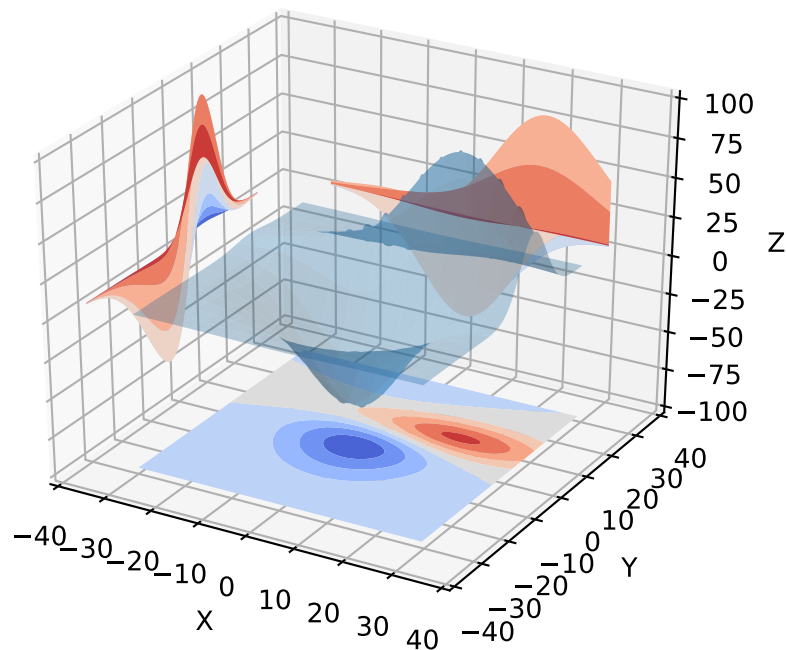

Numerix support removed

After more than two years of deprecation warnings, Numerix support has now been completely removed from matplotlib.

Markers

The list of available markers for `plot()` and `scatter()` has now been merged. While they were mostly similar, some markers existed for one function, but not the other. This merge did result in a conflict for the ‘d’ diamond marker. Now, ‘d’ will be interpreted to always mean “thin” diamond while ‘D’ will mean “regular” diamond.

Thanks to Michael Droettboom for this effort.

Other improvements

- Unit support for polar axes and `arrow()`
- `PolarAxes` gains getters and setters for “theta_direction”, and “theta_offset” to allow for theta to go in either the clock-wise or counter-clockwise direction and to specify where zero degrees should be placed. `set_theta_zero_location()` is an added convenience function.

- Fixed error in argument handling for tri-functions such as `tripcolor()`
- `axes.labelweight` parameter added to `rcParams`.
- For `imshow()`, `interpolation='nearest'` will now always perform an interpolation. A “none” option has been added to indicate no interpolation at all.
- An error in the Hammer projection has been fixed.
- `clabel` for `contour()` now accepts a callable. Thanks to Daniel Hyams for the original patch.
- Jae-Joon Lee added the `HBox` and `VBox` classes.
- Christoph Gohlke reduced memory usage in `imshow()`.
- `scatter()` now accepts empty inputs.
- The behavior for ‘symlog’ scale has been fixed, but this may result in some minor changes to existing plots. This work was refined by ssyr.
- Peter Butterworth added named figure support to `figure()`.
- Michiel de Hoon has modified the MacOSX backend to make its interactive behavior consistent with the other backends.
- Pim Schellart added a new colormap called “cubehelix”. Sameer Grover also added a colormap called “coolwarm”. See it and all other colormaps [here](#).
- Many bug fixes and documentation improvements.

9.2.5 New in matplotlib 1.2

Table of Contents

- *New in matplotlib 1.2*
 - *Python 3.x support*
 - *PGF/TikZ backend*
 - *Locator interface*
 - *Tri-Surface Plots*
 - *Control the lengths of colorbar extensions*
 - *Figures are picklable*
 - *Set default bounding box in matplotlibrc*
 - *New Boxplot Functionality*
 - *New RC parameter functionality*
 - *Streamplot*
 - *New hist functionality*

- *Updated shipped dependencies*
- *Face-centred colors in tripcolor plots*
- *Hatching patterns in filled contour plots, with legends*
- *Known issues in the matplotlib 1.2 release*

Note: matplotlib 1.2 supports Python 2.6, 2.7, and 3.1

Python 3.x support

Matplotlib 1.2 is the first version to support Python 3.x, specifically Python 3.1 and 3.2. To make this happen in a reasonable way, we also had to drop support for Python versions earlier than 2.6.

This work was done by Michael Droettboom, the Cape Town Python Users' Group, many others and supported financially in part by the SAGE project.

The following GUI backends work under Python 3.x: Gtk3Cairo, Qt4Agg, TkAgg and MacOSX. The other GUI backends do not yet have adequate bindings for Python 3.x, but continue to work on Python 2.6 and 2.7, particularly the Qt and QtAgg backends (which have been deprecated). The non-GUI backends, such as PDF, PS and SVG, work on both Python 2.x and 3.x.

Features that depend on the Python Imaging Library, such as JPEG handling, do not work, since the version of PIL for Python 3.x is not sufficiently mature.

PGF/TikZ backend

Peter Würtz wrote a backend that allows matplotlib to export figures as drawing commands for LaTeX. These can be processed by PdfLaTeX, XeLaTeX or LuaLaTeX using the PGF/TikZ package. Usage examples and documentation are found in *Typesetting With XeLaTeX/LuaLaTeX*.

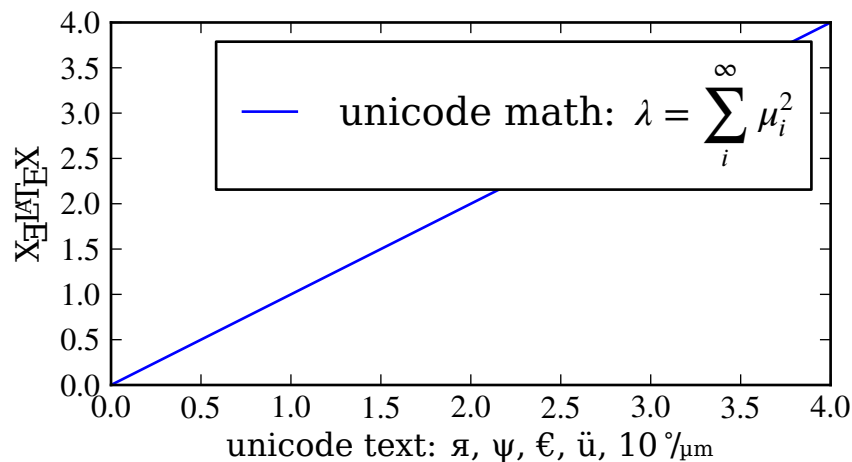

Locator interface

Philip Elson exposed the intelligence behind the tick Locator classes with a simple interface. For instance, to get no more than 5 sensible steps which span the values 10 and 19.5:

```
>>> import matplotlib.ticker as mticker
>>> locator = mticker.MaxNLocator(nbins=5)
>>> print(locator.tick_values(10, 19.5))
[ 10.  12.  14.  16.  18.  20.]
```

Tri-Surface Plots

Damon McDougall added a new plotting method for the `mplot3d` toolkit called `plot_trisurf()`.

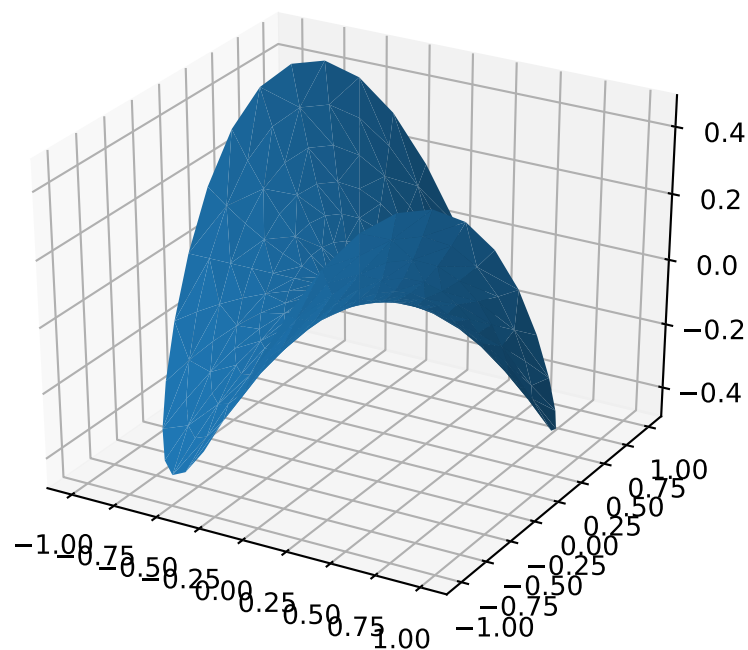

Control the lengths of colorbar extensions

Andrew Dawson added a new keyword argument `extendfrac` to `colorbar()` to control the length of minimum and maximum colorbar extensions.

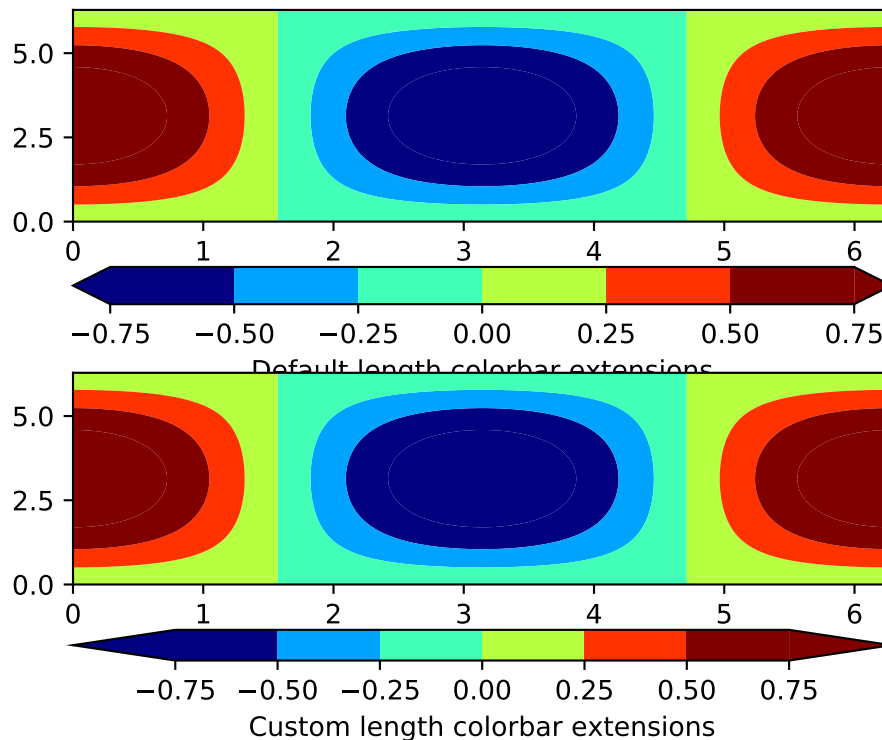

Figures are picklable

Philip Elson added an experimental feature to make figures picklable for quick and easy short-term storage of plots. Pickle files are not designed for long term storage, are unsupported when restoring a pickle saved in another matplotlib version and are insecure when restoring a pickle from an untrusted source. Having said this, they are useful for short term storage for later modification inside matplotlib.

Set default bounding box in matplotlibrc

Two new defaults are available in the matplotlibrc configuration file: `savefig.bbox`, which can be set to 'standard' or 'tight', and `savefig.pad_inches`, which controls the bounding box padding.

New Boxplot Functionality

Users can now incorporate their own methods for computing the median and its confidence intervals into the `boxplot()` method. For every column of data passed to `boxplot`, the user can specify an accompanying median and confidence interval.

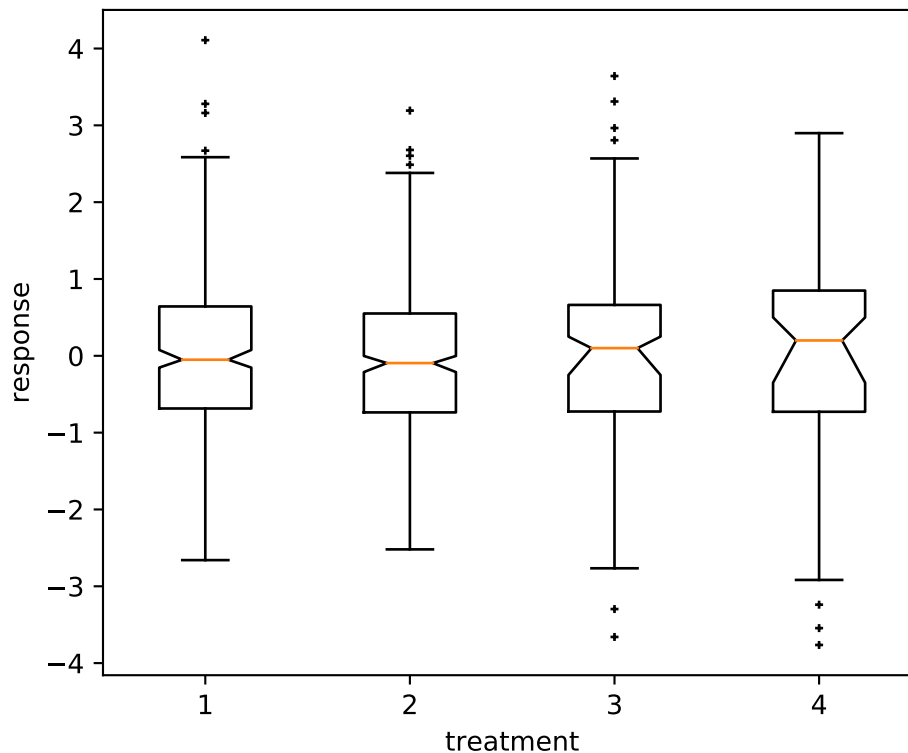

New RC parameter functionality

Matthew Emmett added a function and a context manager to help manage RC parameters: `rc_file()` and `rc_context`. To load RC parameters from a file:

```
>>> mpl.rc_file('mpl.rc')
```

To temporarily use RC parameters:

```
>>> with mpl.rc_context(fname='mpl.rc', rc={'text.usetex': True}):
>>>     ...
```

Streamplot

Tom Flannaghan and Tony Yu have added a new `streamplot()` function to plot the streamlines of a vector field. This has been a long-requested feature and complements the existing `quiver()` function for plotting vector fields. In addition to simply plotting the streamlines of the vector field, `streamplot()` allows users to map the colors and/or line widths of the streamlines to a separate parameter, such as the speed or local intensity of the vector field.

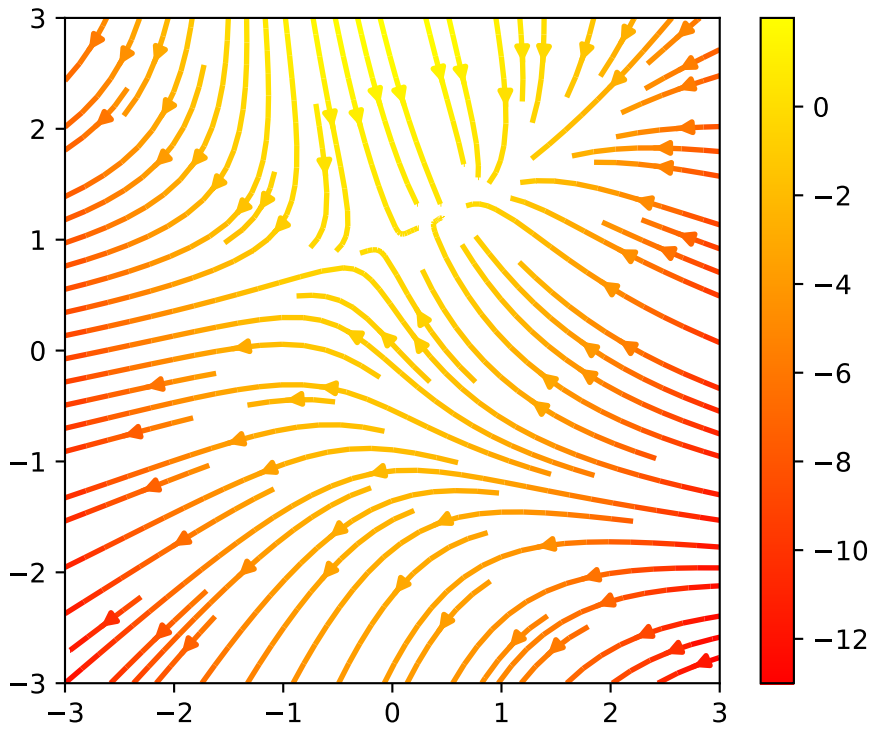

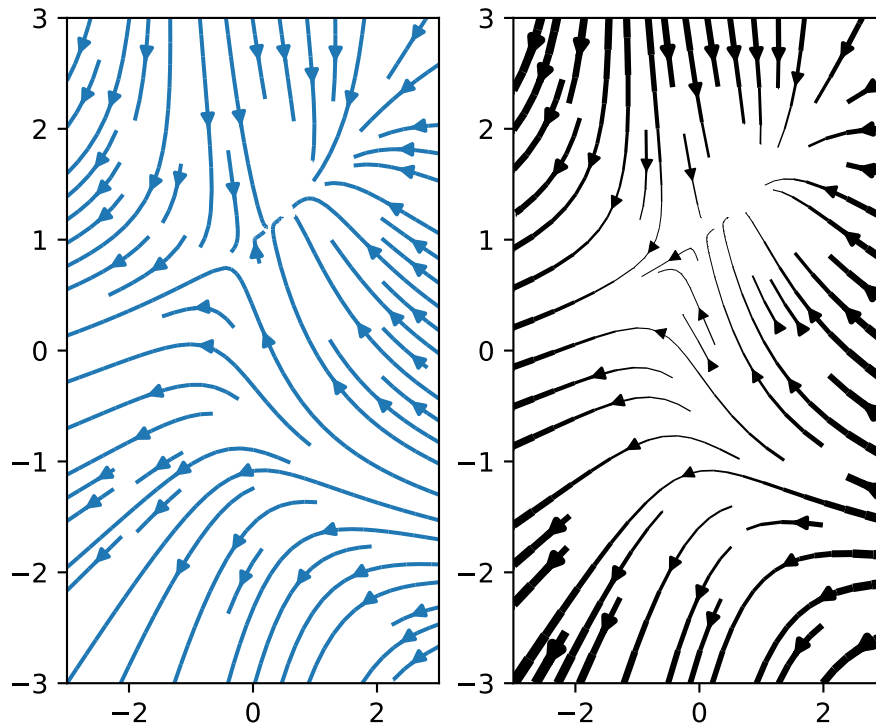

New hist functionality

Nic Eggert added a new `stacked` kwarg to `hist()` that allows creation of stacked histograms using any of the histogram types. Previously, this functionality was only available by using the `barstacked` histogram type. Now, when `stacked=True` is passed to the function, any of the histogram types can be stacked. The `barstacked` histogram type retains its previous functionality for backwards compatibility.

Updated shipped dependencies

The following dependencies that ship with matplotlib and are optionally installed alongside it have been updated:

- `pytz` 2012d
- `dateutil` 1.5 on Python 2.x, and 2.1 on Python 3.x

Face-centred colors in tripcolor plots

Ian Thomas extended `tripcolor()` to allow one color value to be specified for each triangular face rather than for each point in a triangulation.

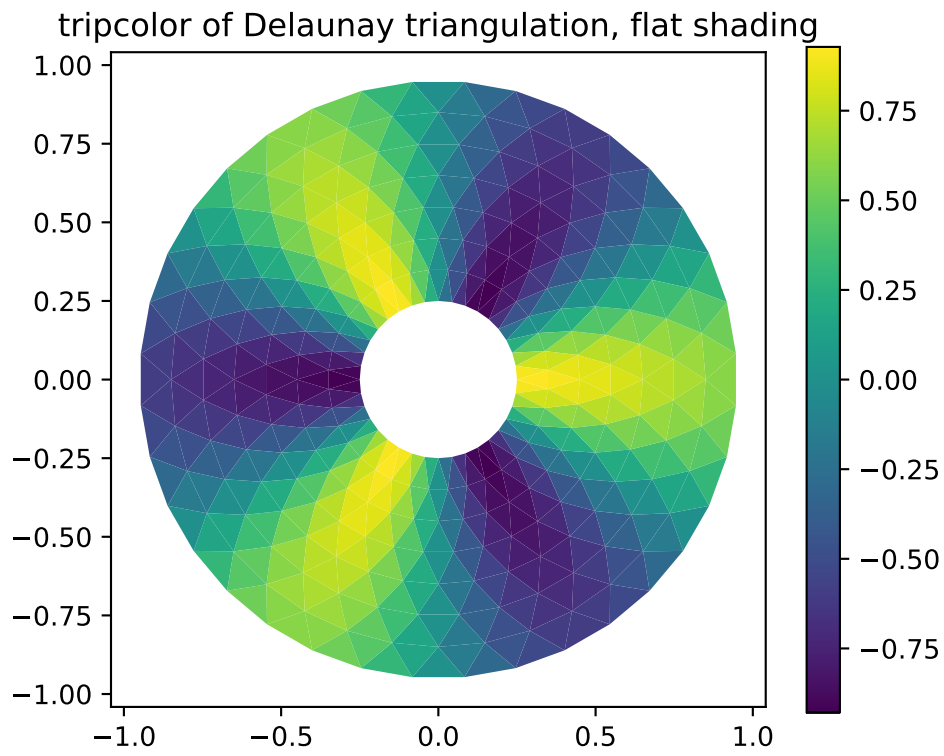

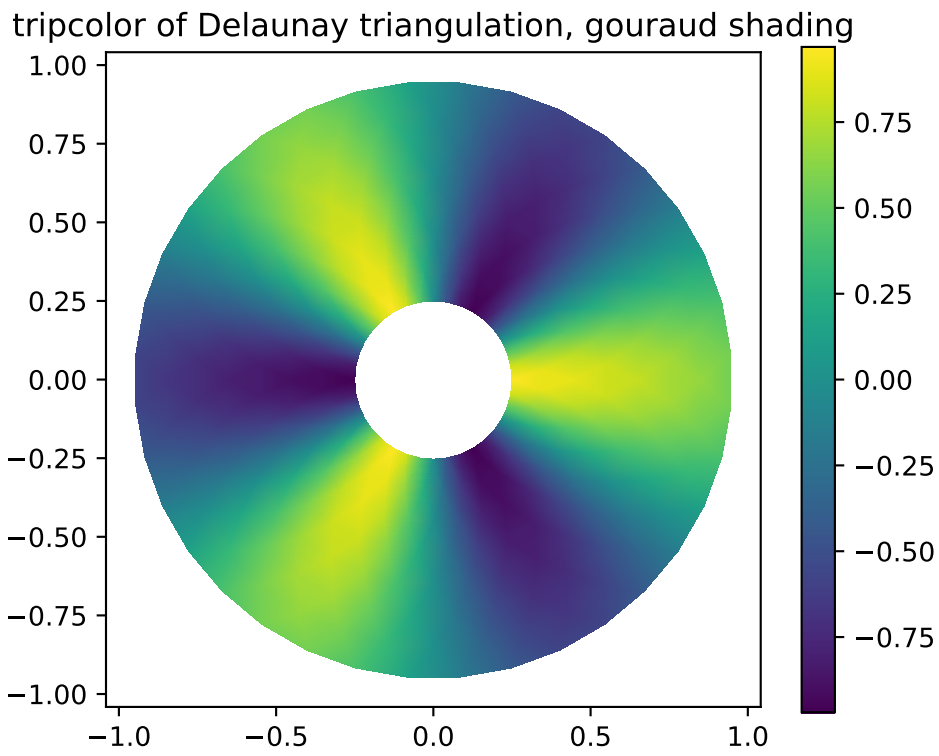

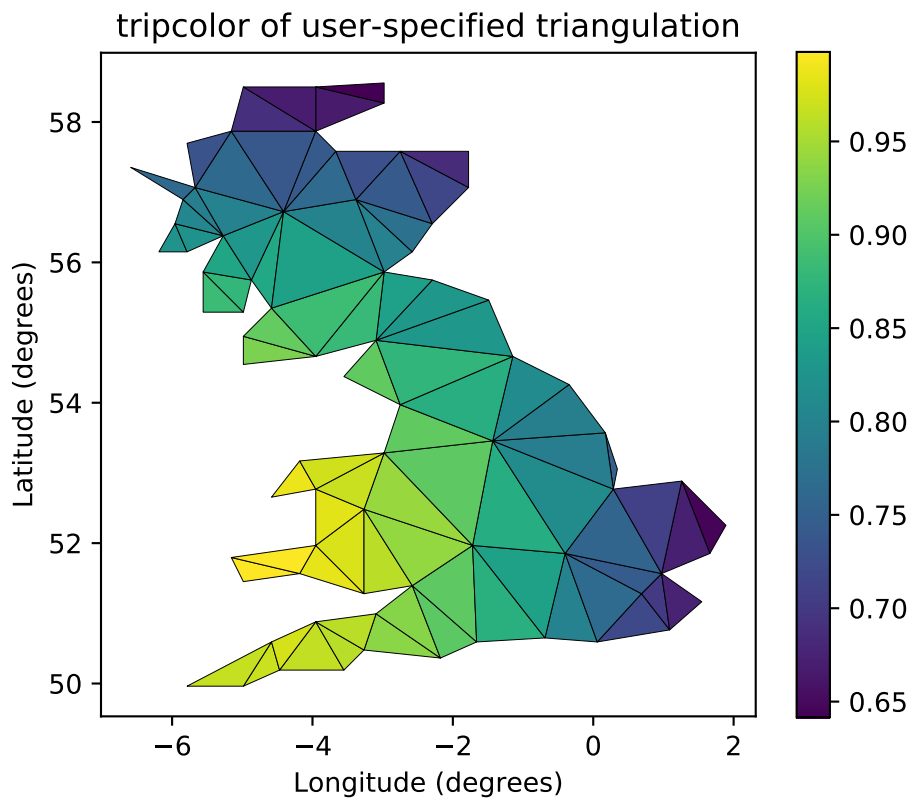

Hatching patterns in filled contour plots, with legends

Phil Elson added support for hatching to `contourf()`, together with the ability to use a legend to identify contoured ranges.

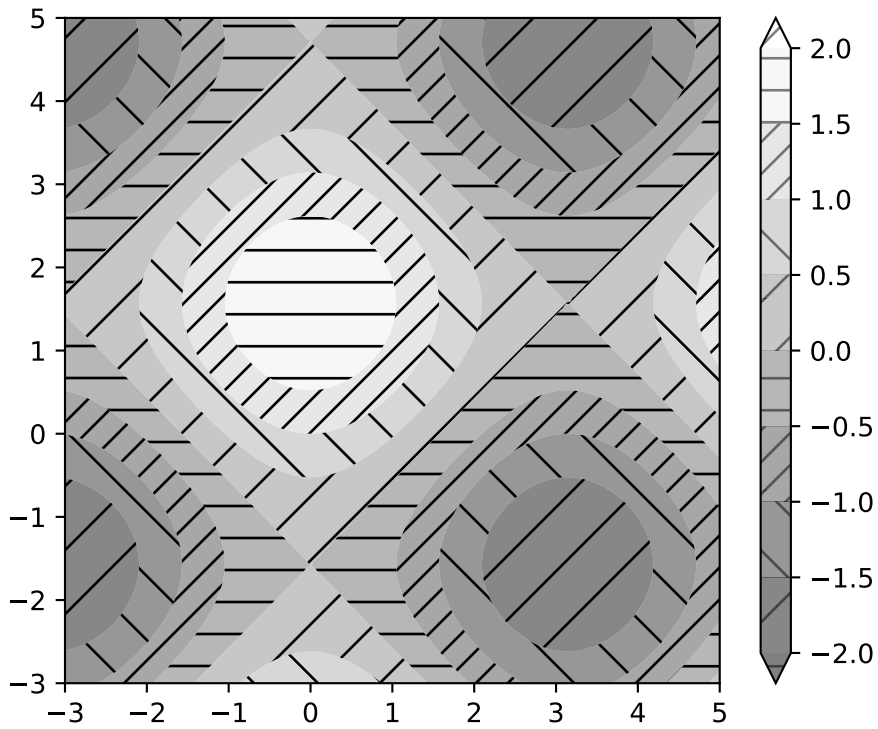

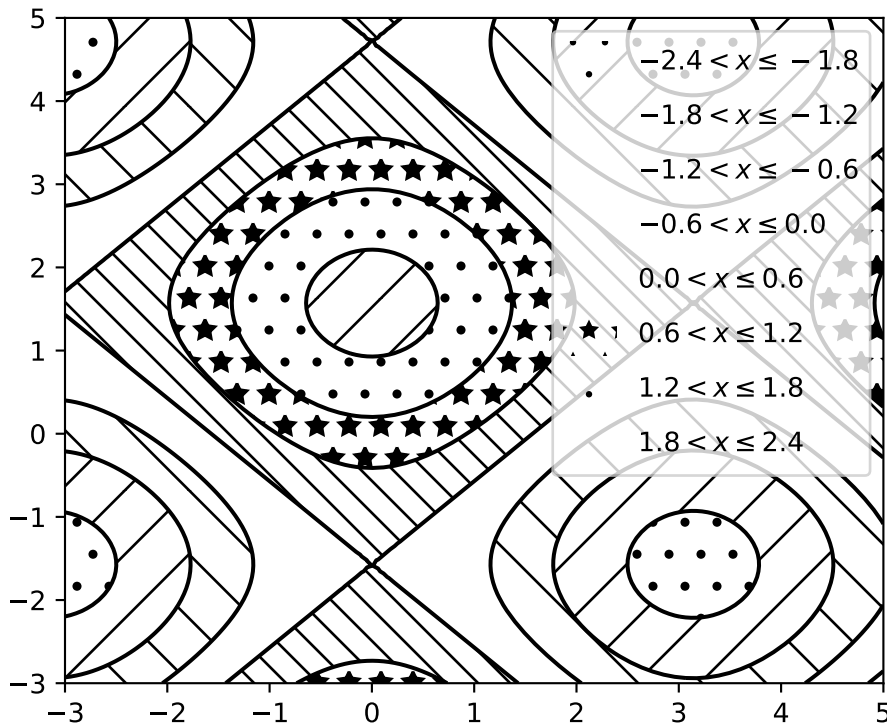

Known issues in the matplotlib 1.2 release

- When using the Qt4Agg backend with IPython 0.11 or later, the save dialog will not display. This should be fixed in a future version of IPython.

9.2.6 New in matplotlib 1.2.2

Table of Contents

- *New in matplotlib 1.2.2*
 - *Improved collections*
 - *Multiple images on same axes are correctly transparent*

Improved collections

The individual items of a collection may now have different alpha values and be rendered correctly. This also fixes a bug where collections were always filled in the PDF backend.

Multiple images on same axes are correctly transparent

When putting multiple images onto the same axes, the background color of the axes will now show through correctly.

9.2.7 New in matplotlib 1.3

Table of Contents

- *New in matplotlib 1.3*
 - *New in 1.3.1*
 - *New plotting features*
 - *Updated Axes3D.contour methods*
 - *Drawing*
 - *Text*
 - *Configuration (rcParams)*
 - *Backends*
 - *Documentation and examples*
 - *Infrastructure*

Note: matplotlib 1.3 supports Python 2.6, 2.7, 3.2, and 3.3

New in 1.3.1

1.3.1 is a bugfix release, primarily dealing with improved setup and handling of dependencies, and correcting and enhancing the documentation.

The following changes were made in 1.3.1 since 1.3.0.

Enhancements

- Added a context manager for creating multi-page pdfs (see `matplotlib.backends.backend_pdf.PdfPages`).
- The WebAgg backend should now have lower latency over heterogeneous Internet connections.

Bug fixes

- Histogram plots now contain the endline.
- Fixes to the Mollweide projection.
- Handling recent fonts from Microsoft and Macintosh-style fonts with non-ascii metadata is improved.
- Hatching of fill between plots now works correctly in the PDF backend.
- Tight bounding box support now works in the PGF backend.
- Transparent figures now display correctly in the Qt4Agg backend.
- Drawing lines from one subplot to another now works.
- Unit handling on masked arrays has been improved.

Setup and dependencies

- Now works with any version of pyparsing 1.5.6 or later, without displaying hundreds of warnings.
- Now works with 64-bit versions of Ghostscript on MS-Windows.
- When installing from source into an environment without Numpy, Numpy will first be downloaded and built and then used to build matplotlib.
- Externally installed backends are now always imported using a fully-qualified path to the module.
- Works with newer version of wxPython.
- Can now build with a PyCXX installed globally on the system from source.
- Better detection of Gtk3 dependencies.

Testing

- Tests should now work in non-English locales.
- PEP8 conformance tests now report on locations of issues.

New plotting features

xkcd-style sketch plotting

To give your plots a sense of authority that they may be missing, Michael Droettboom (inspired by the work of many others in [PR #1329](#)) has added an *xkcd-style* sketch plotting mode. To use it, simply call `matplotlib.pyplot.xkcd()` before creating your plot. For really fine control, it is also possible to modify each artist's sketch parameters individually with `matplotlib.artist.Artist.set_sketch_params()`.

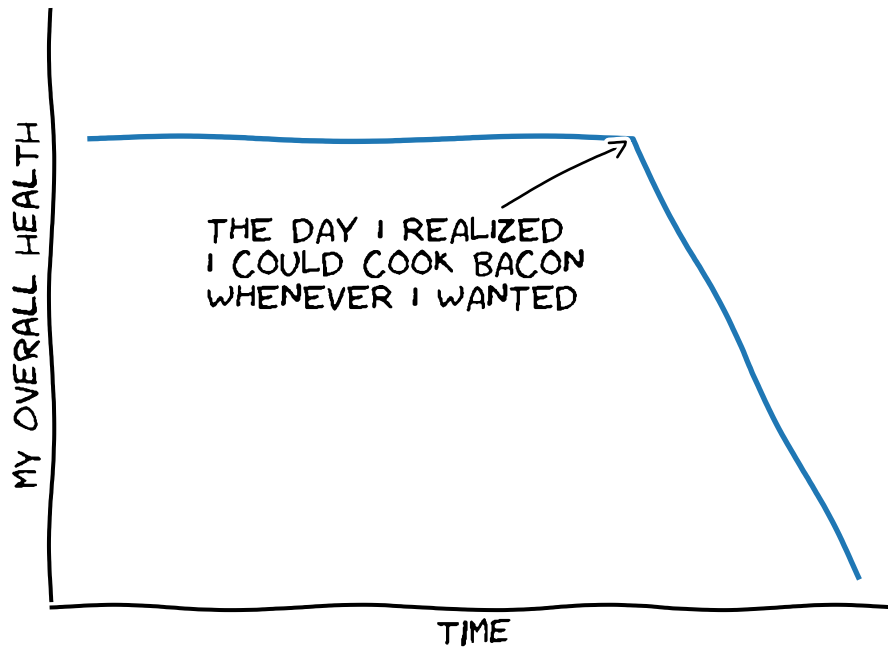

"STOVE OWNERSHIP" FROM XKCD BY RANDALL MONROE

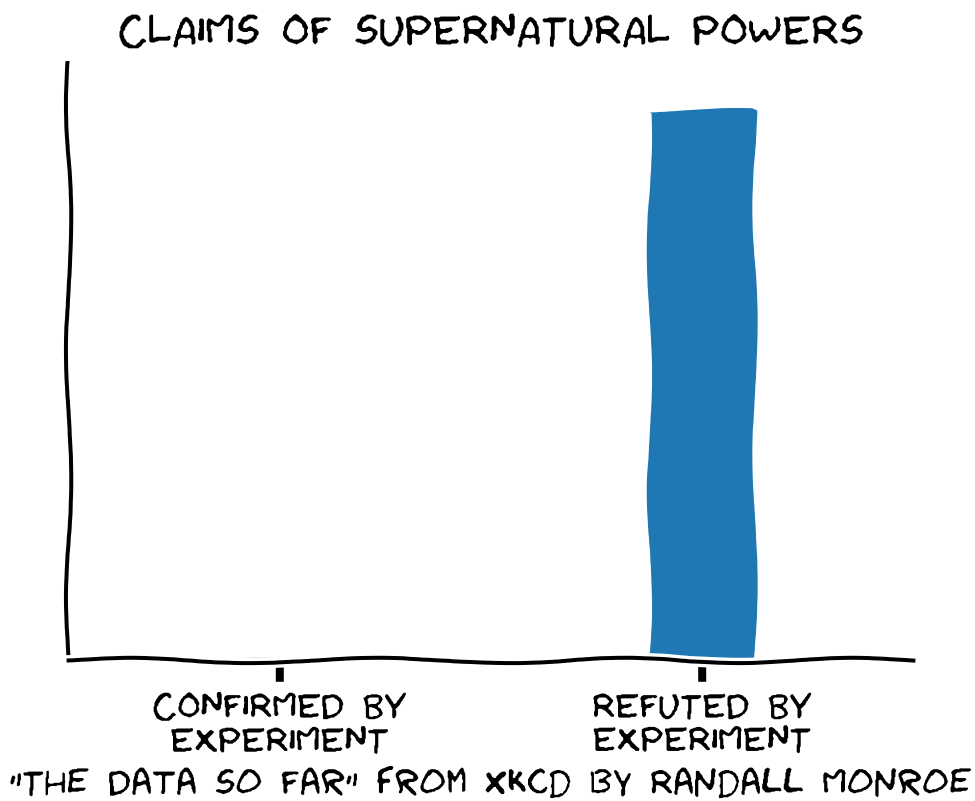

Updated Axes3D.contour methods

Damon McDougall updated the `tricontour()` and `tricontourf()` methods to allow 3D contour plots on arbitrary unstructured user-specified triangulations.

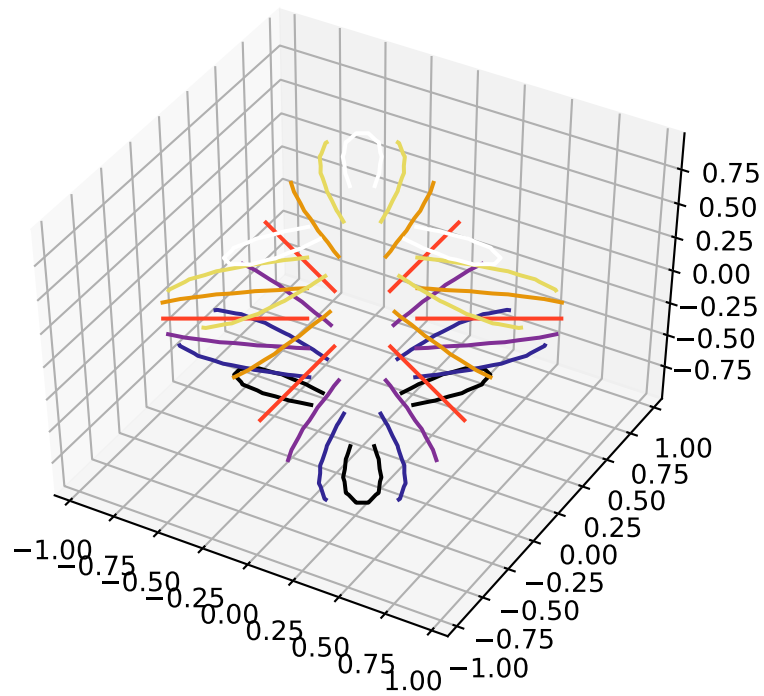

New eventplot plot type

Todd Jennings added a `eventplot()` function to create multiple rows or columns of identical line segments

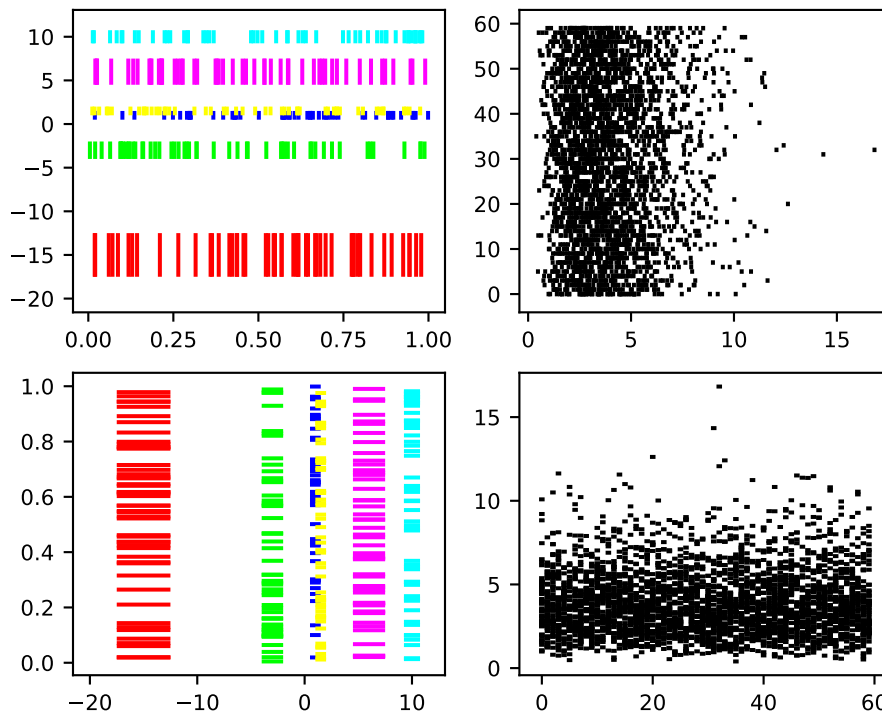

As part of this feature, there is a new *EventCollection* class that allows for plotting and manipulating rows or columns of identical line segments.

Triangular grid interpolation

Geoffroy Billotey and Ian Thomas added classes to perform interpolation within triangular grids: (*LinearTriInterpolator* and *CubicTriInterpolator*) and a utility class to find the triangles in which points lie (*TrapezoidMapTriFinder*). A helper class to perform mesh refinement and smooth contouring was also added (*UniformTriRefiner*). Finally, a class implementing some basic tools for triangular mesh improvement was added (*TriAnalyzer*).

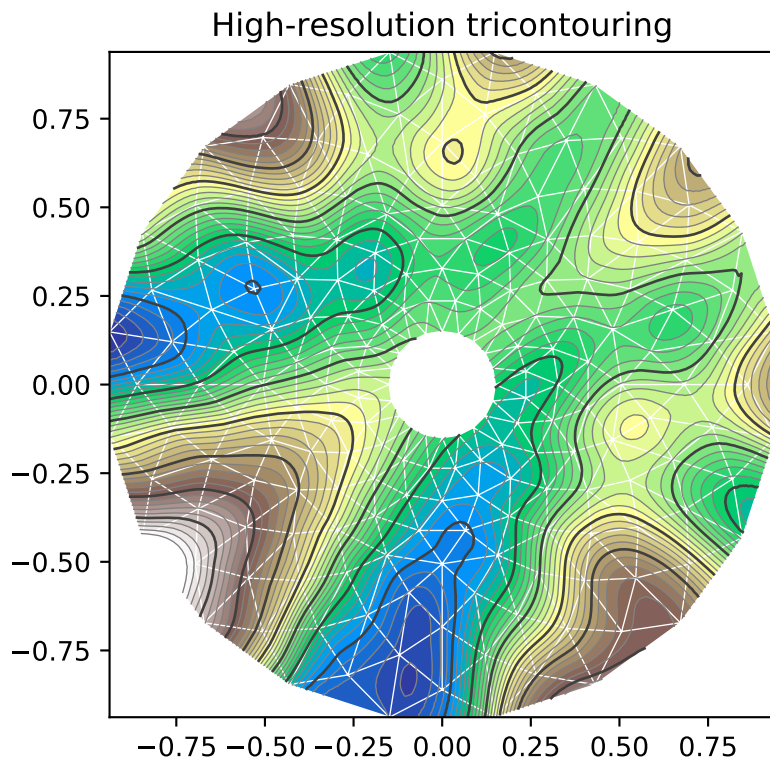

Baselines for `stackplot`

Till Stensitzki added non-zero baselines to `stackplot()`. They may be symmetric or weighted.

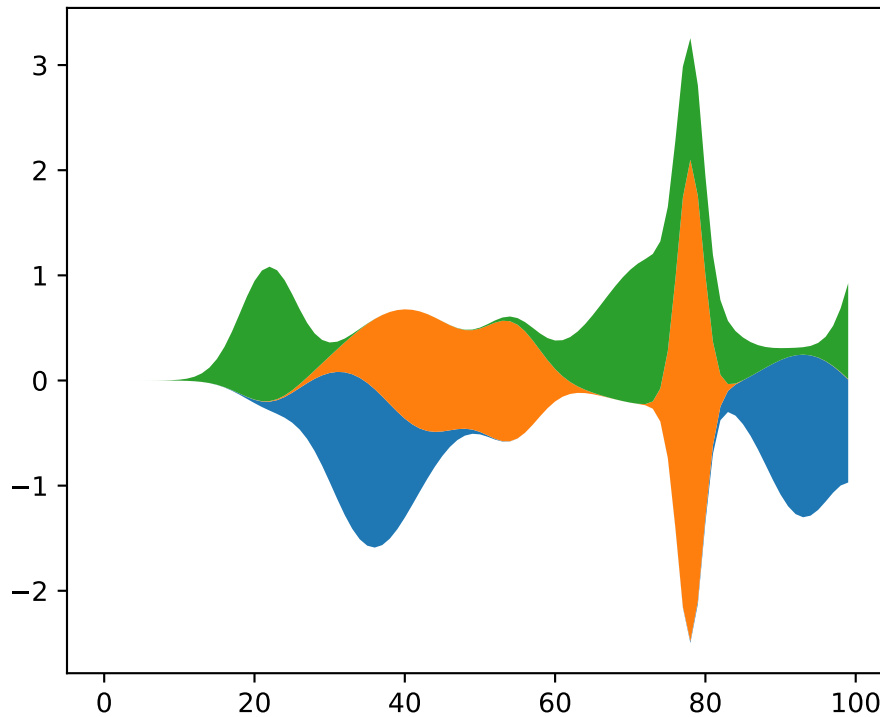

Rectangular colorbar extensions

Andrew Dawson added a new keyword argument *extendrect* to `colorbar()` to optionally make colorbar extensions rectangular instead of triangular.

More robust boxplots

Paul Hobson provided a fix to the `boxplot()` method that prevent whiskers from being drawn inside the box for oddly distributed data sets.

Calling `subplot()` without arguments

A call to `subplot()` without any arguments now acts the same as `subplot(111)` or `subplot(1,1,1)` – it creates one axes for the whole figure. This was already the behavior for both `axes()` and `subplots()`, and now this consistency is shared with `subplot()`.

Drawing

Independent alpha values for face and edge colors

Wes Campaigne modified how *Patch* objects are drawn such that (for backends supporting transparency) you can set different alpha values for faces and edges, by specifying their colors in RGBA format. Note that if you set the alpha attribute for the patch object (e.g. using `set_alpha()` or the `alpha` keyword argument), that value will override the alpha components set in both the face and edge colors.

Path effects on lines

Thanks to Jae-Joon Lee, path effects now also work on plot lines.

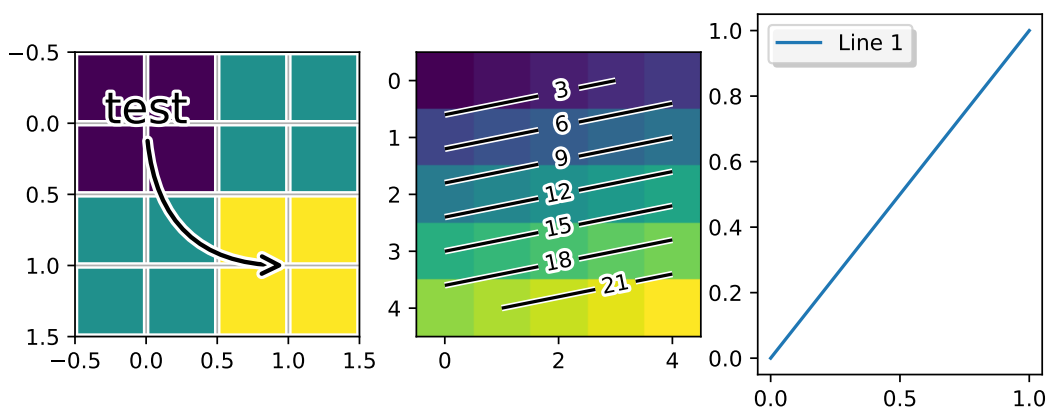

Easier creation of colormap and normalizer for levels with colors

Phil Elson added the `matplotlib.colors.from_levels_and_colors()` function to easily create a colormap and normalizer for representation of discrete colors for plot types such as `matplotlib.pyplot.pcolormesh()`, with a similar interface to that of `contourf()`.

Full control of the background color

Wes Campaigne and Phil Elson fixed the Agg backend such that PNGs are now saved with the correct background color when `fig.patch.get_alpha()` is not 1.

Improved `bbox_inches="tight"` functionality

Passing `bbox_inches="tight"` through to `plt.save()` now takes into account *all* artists on a figure - this was previously not the case and led to several corner cases which did not function as expected.

Initialize a rotated rectangle

Damon McDougall extended the *Rectangle* constructor to accept an `angle` kwarg, specifying the rotation of a rectangle in degrees.

Text

Anchored text support

The `svg` and `pgf` backends are now able to save text alignment information to their output formats. This allows to edit text elements in saved figures, using Inkscape for example, while preserving their intended position. For `svg` please note that you'll have to disable the default text-to-path conversion (`mpl.rcParams['svg', 'fonttype']='none'`)).

Better vertical text alignment and multi-line text

The vertical alignment of text is now consistent across backends. You may see small differences in text placement, particularly with rotated text.

If you are using a custom backend, note that the `draw_text` renderer method is now passed the location of the baseline, not the location of the bottom of the text bounding box.

Multi-line text will now leave enough room for the height of very tall or very low text, such as superscripts and subscripts.

Left and right side axes titles

Andrew Dawson added the ability to add axes titles flush with the left and right sides of the top of the axes using a new keyword argument `loc` to `title()`.

Improved manual contour plot label positioning

Brian Mattern modified the manual contour plot label positioning code to interpolate along line segments and find the actual closest point on a contour to the requested position. Previously, the closest path vertex was used, which, in the case of straight contours was sometimes quite distant from the requested location. Much more precise label positioning is now possible.

Configuration (rcParams)

Quickly find rcParams

Phil Elson made it easier to search for rcParameters by passing a valid regular expression to `matplotlib.RcParams.find_all()`. `matplotlib.RcParams` now also has a pretty repr and str representation so that search results are printed prettily:

```
>>> import matplotlib
>>> print(matplotlib.rcParams.find_all('\.size'))
RcParams({'font.size': 12,
          'xtick.major.size': 4,
          'xtick.minor.size': 2,
          'ytick.major.size': 4,
          'ytick.minor.size': 2})
```

axes.xmargin and axes.ymargin added to rcParams

rcParam values (`axes.xmargin` and `axes.ymargin`) were added to configure the default margins used. Previously they were hard-coded to default to 0, default value of both rcParam values is 0.

Changes to font rcParams

The `font.*` rcParams now affect only text objects created after the rcParam has been set, and will not retroactively affect already existing text objects. This brings their behavior in line with most other rcParams.

savefig.jpeg_quality added to rcParams

rcParam value `savefig.jpeg_quality` was added so that the user can configure the default quality used when a figure is written as a JPEG. The default quality is 95; previously, the default quality was 75. This change minimizes the artifacting inherent in JPEG images, particularly with images that have sharp changes in color as plots often do.

Backends

WebAgg backend

Michael Droettboom, Phil Elson and others have developed a new backend, WebAgg, to display figures in a web browser. It works with animations as well as being fully interactive.

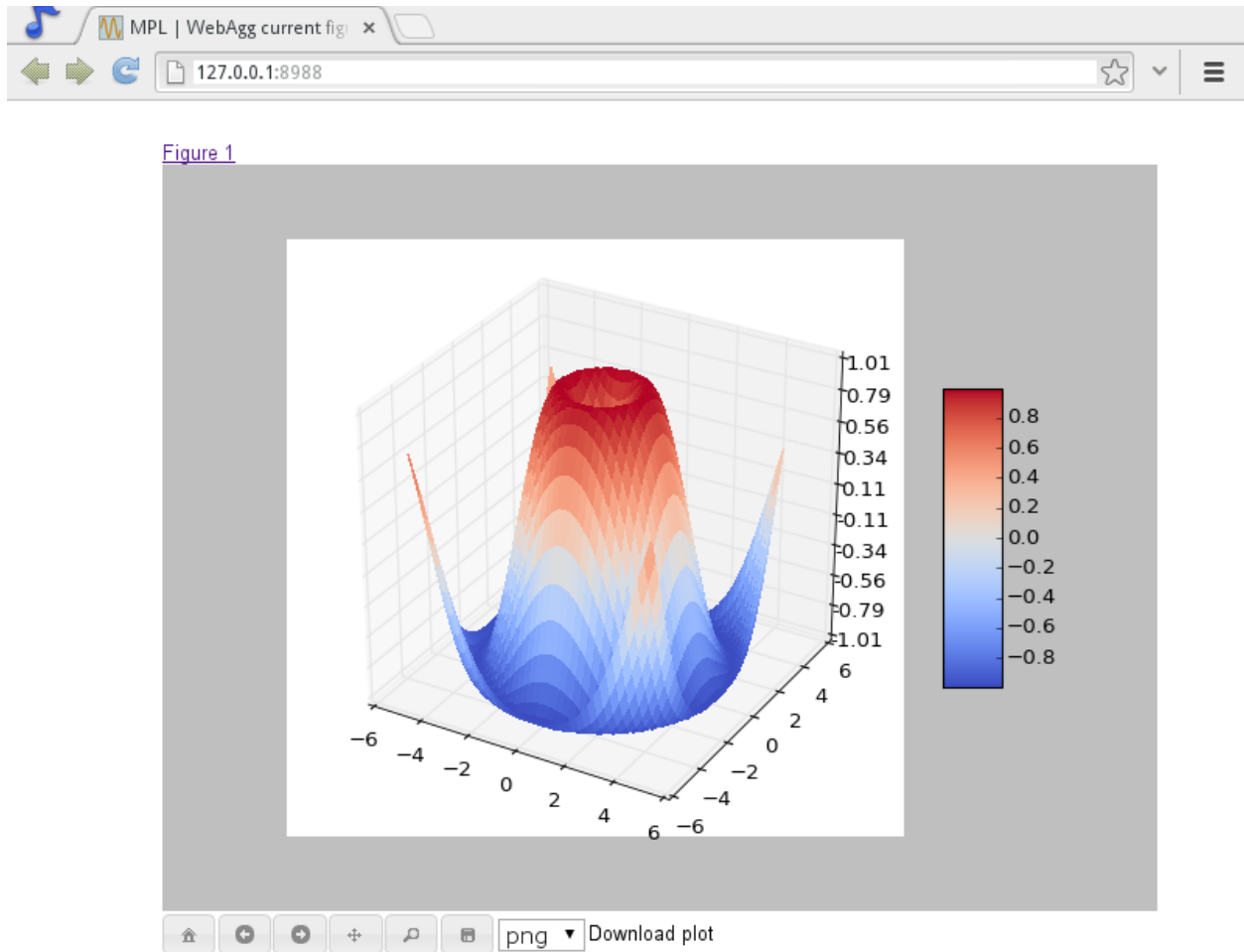

Future versions of matplotlib will integrate this backend with the IPython notebook for a fully web browser based plotting frontend.

Remember save directory

Martin Spacek made the save figure dialog remember the last directory saved to. The default is configurable with the new `savefig.directory rcParam` in `matplotliblibrc`.

Documentation and examples

Numpydoc docstrings

Nelle Varoquaux has started an ongoing project to convert matplotlib's docstrings to numpydoc format. See [MEP10](#) for more information.

Example reorganization

Tony Yu has begun work reorganizing the examples into more meaningful categories. The new gallery page is the fruit of this ongoing work. See [MEP12](#) for more information.

Examples now use `subplots()`

For the sake of brevity and clarity, most of the *examples* now use the newer `subplots()`, which creates a figure and one (or multiple) axes object(s) in one call. The old way involved a call to `figure()`, followed by one (or multiple) `subplot()` calls.

Infrastructure

Housecleaning

A number of features that were deprecated in 1.2 or earlier, or have not been in a working state for a long time have been removed. Highlights include removing the Qt version 3 backends, and the FltkAgg and Emf backends. See *Changes in 1.3.x* for a complete list.

New setup script

matplotlib 1.3 includes an entirely rewritten setup script. We now ship fewer dependencies with the tarballs and installers themselves. Notably, `pytz`, `dateutil`, `pyparsing` and `six` are no longer included with matplotlib. You can either install them manually first, or let `pip` install them as dependencies along with matplotlib. It is now possible to not include certain subcomponents, such as the unit test data, in the install. See `setup.cfg.template` for more information.

XDG base directory support

On Linux, matplotlib now uses the XDG base directory specification to find the `matplotlibrc` configuration file. `matplotlibrc` should now be kept in `config/matplotlib`, rather than `matplotlib`. If your configuration is found in the old location, it will still be used, but a warning will be displayed.

Catch opening too many figures using `pyplot`

Figures created through `pyplot.figure` are retained until they are explicitly closed. It is therefore common for new users of matplotlib to run out of memory when creating a large series of figures in a loop without closing them.

matplotlib will now display a `RuntimeWarning` when too many figures have been opened at once. By default, this is displayed for 20 or more figures, but the exact number may be controlled using the `figure.max_open_warning` rcParam.

9.2.8 New in matplotlib 1.4

Thomas A. Caswell served as the release manager for the 1.4 release.

Table of Contents

- *New in matplotlib 1.4*
 - *New colormap*
 - *The nbagg backend*
 - *New plotting features*
 - *Date handling*
 - *Configuration (rcParams)*
 - *style package added*
 - *Backends*
 - *Text*
 - *Sphinx extensions*
 - *Legend and PathEffects documentation*
 - *Widgets*
 - *GAE integration*

Note: matplotlib 1.4 supports Python 2.6, 2.7, 3.3, and 3.4

New colormap

In heatmaps, a green-to-red spectrum is often used to indicate intensity of activity, but this can be problematic for the red/green colorblind. A new, colorblind-friendly colormap is now available at `matplotlib.cm.Wistia`. This colormap maintains the red/green symbolism while achieving deuteranopic legibility through brightness variations. See [here](#) for more information.

The nbagg backend

Phil Elson added a new backend, named “nbagg”, which enables interactive figures in a live IPython notebook session. The backend makes use of the infrastructure developed for the webagg backend, which itself gives standalone server backed interactive figures in the browser, however nbagg does not require a dedicated matplotlib server as all communications are handled through the IPython Comm machinery.

As with other backends nbagg can be enabled inside the IPython notebook with:

```
import matplotlib
matplotlib.use('nbagg')
```

Once figures are created and then subsequently shown, they will be placed in an interactive widget inside the notebook allowing panning and zooming in the same way as any other matplotlib backend. Because figures require a connection to the IPython notebook server for their interactivity, once the notebook is saved, each figure will be rendered as a static image - thus allowing non-interactive viewing of figures on services such as `nbviewer`.

New plotting features

Power-law normalization

Ben Gamari added a power-law normalization method, `PowerNorm`. This class maps a range of values to the interval $[0,1]$ with power-law scaling with the exponent provided by the constructor's `gamma` argument. Power law normalization can be useful for, e.g., emphasizing small populations in a histogram.

Fully customizable boxplots

Paul Hobson overhauled the `boxplot()` method such that it is now completely customizable in terms of the styles and positions of the individual artists. Under the hood, `boxplot()` relies on a new function (`boxplot_stats()`), which accepts any data structure currently compatible with `boxplot()`, and returns a list of dictionaries containing the positions for each element of the boxplots. Then a second method, `bxp()` is called to draw the boxplots based on the stats.

The `boxplot()` function can be used as before to generate boxplots from data in one step. But now the user has the flexibility to generate the statistics independently, or to modify the output of `boxplot_stats()` prior to plotting with `bxp()`.

Lastly, each artist (e.g., the box, outliers, cap, notches) can now be toggled on or off and their styles can be passed in through individual kwargs. See the examples: *statistics example code: `boxplot_demo.py`* and *statistics example code: `bxp_demo.py`*

Added a bool kwarg, `manage_xticks`, which if `False` disables the management of the ticks and limits on the x-axis by `bxp()`.

Support for datetime axes in 2d plots

Andrew Dawson added support for datetime axes to `contour()`, `contourf()`, `pcolormesh()` and `pcolor()`.

Support for additional spectrum types

Todd Jennings added support for new types of frequency spectrum plots: `magnitude_spectrum()`, `phase_spectrum()`, and `angle_spectrum()`, as well as corresponding functions in `mlab`.

He also added these spectrum types to `specgram()`, as well as adding support for linear scaling there (in addition to the existing dB scaling). Support for additional spectrum types was also added to `specgram()`.

He also increased the performance for all of these functions and plot types.

Support for detrending and windowing 2D arrays in mlab

Todd Jennings added support for 2D arrays in the `detrend_mean()`, `detrend_none()`, and `detrend()`, as well as adding `apply_window()` which support windowing 2D arrays.

Support for strides in mlab

Todd Jennings added some functions to mlab to make it easier to use numpy strides to create memory-efficient 2D arrays. This includes `stride_repeat()`, which repeats an array to create a 2D array, and `stride_windows()`, which uses a moving window to create a 2D array from a 1D array.

Formatter for new-style formatting strings

Added `FormatStrFormatterNewStyle` which does the same job as `FormatStrFormatter`, but accepts new-style formatting strings instead of printf-style formatting strings

Consistent grid sizes in streamplots

`streamplot()` uses a base grid size of 30x30 for both `density=1` and `density=(1, 1)`. Previously a grid size of 30x30 was used for `density=1`, but a grid size of 25x25 was used for `density=(1, 1)`.

Get a list of all tick labels (major and minor)

Added the kwarg 'which' to `get_xticklabels()`, `get_yticklabels()` and `get_ticklabels()`. 'which' can be 'major', 'minor', or 'both' select which ticks to return, like `set_ticks_position()`. If 'which' is `None` then the old behaviour (controlled by the bool `minor`).

Separate horizontal/vertical axes padding support in ImageGrid

The kwarg 'axes_pad' to `mpl_toolkits.axes_grid1.ImageGrid` can now be a tuple if separate horizontal/vertical padding is needed. This is supposed to be very helpful when you have a labelled legend next to every subplot and you need to make some space for legend's labels.

Support for skewed transformations

The `Affine2D` gained additional methods `skew` and `skew_deg` to create skewed transformations. Additionally, matplotlib internals were cleaned up to support using such transforms in `Axes`. This transform is important for some plot types, specifically the Skew-T used in meteorology.

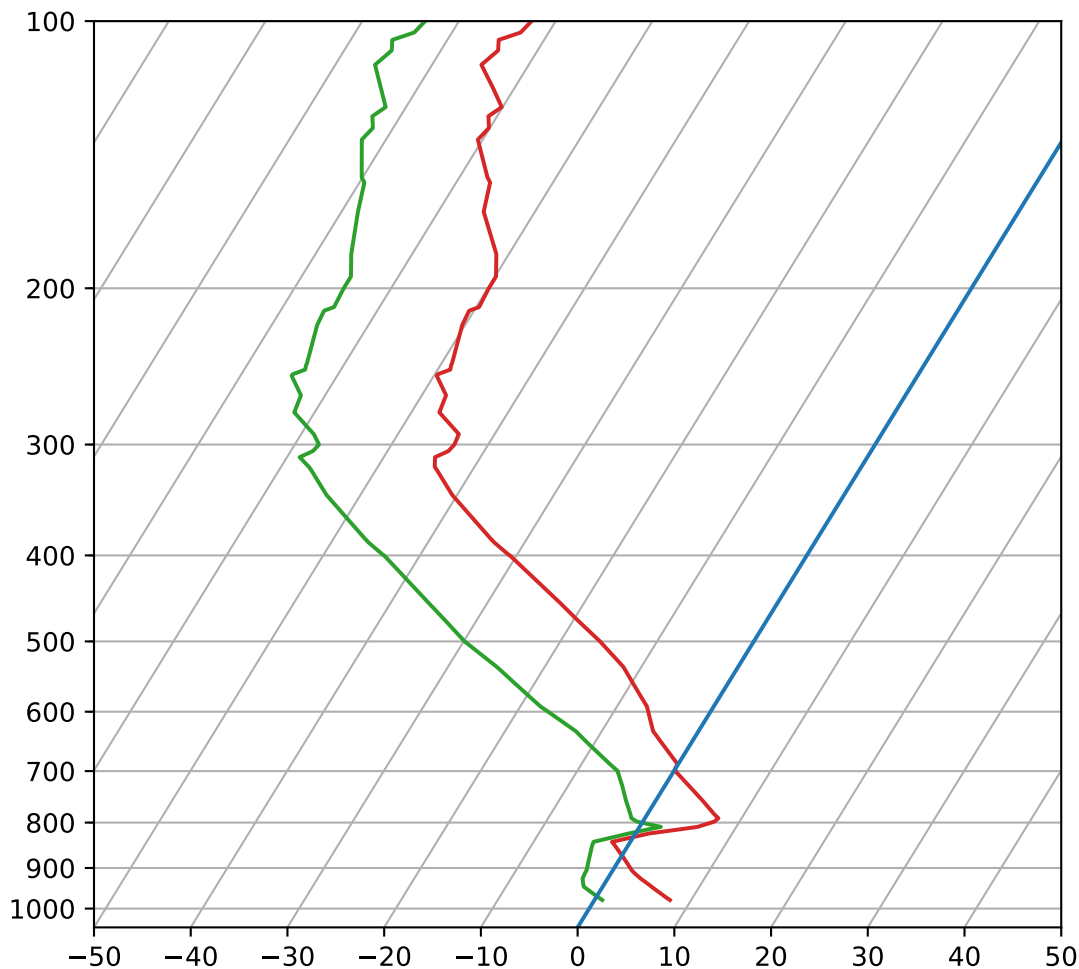

Support for specifying properties of wedge and text in pie charts.

Added the kwargs `'wedgeprops'` and `'textprops'` to `pie()` to accept properties for wedge and text objects in a pie. For example, one can specify `wedgeprops = {'linewidth':3}` to specify the width of the borders of the wedges in the pie. For more properties that the user can specify, look at the docs for the wedge and text objects.

Fixed the direction of errorbar upper/lower limits

Larry Bradley fixed the `errorbar()` method such that the upper and lower limits (`lolims`, `uplims`, `xlolims`, `xuplims`) now point in the correct direction.

More consistent add-object API for Axes

Added the Axes method `add_image` to put image handling on a par with artists, collections, containers, lines, patches, and tables.

Violin Plots

Per Parker, Gregory Kelsie, Adam Ortiz, Kevin Chan, Geoffrey Lee, Deokjae Donald Seo, and Taesu Terry Lim added a basic implementation for violin plots. Violin plots can be used to represent the distribution of sample data. They are similar to box plots, but use a kernel density estimation function to present a smooth approximation of the data sample used. The added features are:

`violin()` - Renders a violin plot from a collection of statistics. `violin_stats()` - Produces a collection of statistics suitable for rendering a violin plot. `violinplot()` - Creates a violin plot from a set of sample data. This method makes use of `violin_stats()` to process the input data, and `violin_stats()` to do the actual rendering. Users are also free to modify or replace the output of `violin_stats()` in order to customize the violin plots to their liking.

This feature was implemented for a software engineering course at the University of Toronto, Scarborough, run in Winter 2014 by Anya Tafliovich.

More markevery options to show only a subset of markers

Rohan Walker extended the `markevery` property in `Line2D`. You can now specify a subset of markers to show with an int, slice object, numpy fancy indexing, or float. Using a float shows markers at approximately equal display-coordinate-distances along the line.

Added size related functions to specialized Collections

Added the `get_size` and `set_size` functions to control the size of elements of specialized collections (`AsteriskPolygonCollection` `BrokenBarHCollection` `CircleCollection` `PathCollection` `PolyCollection` `RegularPolyCollection` `StarPolygonCollection`).

Fixed the mouse coordinates giving the wrong theta value in Polar graph

Added code to `transform_non_affine()` to ensure that the calculated theta value was between the range of 0 and $2 * \pi$ since the problem was that the value can become negative after applying the direction and rotation to the theta calculation.

Simple quiver plot for mplot3d toolkit

A team of students in an *Engineering Large Software Systems* course, taught by Prof. Anya Taffiovich at the University of Toronto, implemented a simple version of a quiver plot in 3D space for the mplot3d toolkit as one of their term project. This feature is documented in `quiver()`. The team members are: Ryan Steve D'Souza, Victor B, xbtsw, Yang Wang, David, Caradec Bisesar and Vlad Vassilovski.

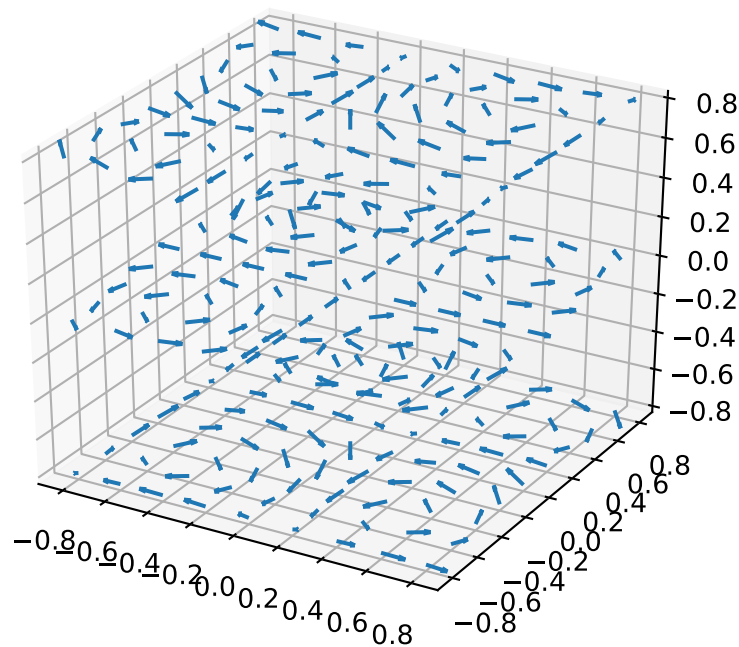

polar-plot r-tick locations

Added the ability to control the angular position of the r-tick labels on a polar plot via `set_rlabel_position()`.

Date handling

n-d array support for date conversion

Andrew Dawson added support for n-d array handling to `matplotlib.dates.num2date()`, `matplotlib.dates.date2num()` and `matplotlib.dates.datestr2num()`. Support is also added to the unit conversion interfaces `matplotlib.dates.DateConverter` and `matplotlib.units.Registry`.

Configuration (rcParams)

`savefig.transparent` added

Controls whether figures are saved with a transparent background by default. Previously `savefig` always defaulted to a non-transparent background.

`axes.titleweight`

Added rcParam to control the weight of the title

`axes.formatter.useoffset` added

Controls the default value of `useOffset` in `ScalarFormatter`. If `True` and the data range is much smaller than the data average, then an offset will be determined such that the tick labels are meaningful. If `False` then the full number will be formatted in all conditions.

`nbagg.transparent` added

Controls whether `nbagg` figures have a transparent background. `nbagg.transparent` is `True` by default.

XDG compliance

Matplotlib now looks for configuration files (both `rcparams` and `style`) in XDG compliant locations.

`style` package added

You can now easily switch between different styles using the new `style` package:

```
>>> from matplotlib import style
>>> style.use('dark_background')
```

Subsequent plots will use updated colors, sizes, etc. To list all available styles, use:

```
>>> print style.available
```

You can add your own custom `<style name>.mplstyle` files to `~/.matplotlib/stylelib` or call `use` with a URL pointing to a file with `matplotlibrc` settings.

Note that this is an experimental feature, and the interface may change as users test out this new feature.

Backends

Qt5 backend

Martin Fitzpatrick and Tom Badran implemented a Qt5 backend. The differences in namespace locations between Qt4 and Qt5 was dealt with by shimming Qt4 to look like Qt5, thus the Qt5 implementation is the primary implementation. Backwards compatibility for Qt4 is maintained by wrapping the Qt5 implementation.

The Qt5Agg backend currently does not work with IPython's `%matplotlib` magic.

The 1.4.0 release has a known bug where the toolbar is broken. This can be fixed by:

```
cd path/to/installed/matplotlib
wget https://github.com/matplotlib/matplotlib/pull/3322.diff
# unix2dos 3322.diff (if on windows to fix line endings)
patch -p2 < 3322.diff
```

Qt4 backend

Rudolf Höfler changed the appearance of the subplottool. All sliders are vertically arranged now, buttons for tight layout and reset were added. Furthermore, the subplottool is now implemented as a modal dialog. It was previously a QMainWindow, leaving the SPT open if one closed the plot window.

In the figure options dialog one can now choose to (re-)generate a simple automatic legend. Any explicitly set legend entries will be lost, but changes to the curves' label, linestyle, et cetera will now be updated in the legend.

Interactive performance of the Qt4 backend has been dramatically improved under windows.

The mapping of key-signals from Qt to values matplotlib understands was greatly improved (For both Qt4 and Qt5).

Cairo backends

The Cairo backends are now able to use the [cairoffi bindings](#) which are more actively maintained than the [pycairo bindings](#).

Gtk3Agg backend

The Gtk3Agg backend now works on Python 3.x, if the [cairoffi bindings](#) are installed.

PDF backend

Added context manager for saving to multi-page PDFs.

Text

Text URLs supported by SVG backend

The `svg` backend will now render `Text` objects' `url` as a link in output SVGs. This allows one to make clickable text in saved figures using the `url` kwarg of the `Text` class.

Anchored sizebar font

Added the `fontproperties` kwarg to `AnchoredSizeBar` to control the font properties.

Sphinx extensions

The `:context:` directive in the `plot_directive` Sphinx extension can now accept an optional `reset` setting, which will cause the context to be reset. This allows more than one distinct context to be present in documentation. To enable this option, use `:context: reset` instead of `:context:` any time you want to reset the context.

Legend and PathEffects documentation

The *Legend guide* and *Path effects guide* have both been updated to better reflect the full potential of each of these powerful features.

Widgets

Span Selector

Added an option `span_stays` to the `SpanSelector` which makes the selector rectangle stay on the axes after you release the mouse.

GAE integration

Matplotlib will now run on google app engine.

9.2.9 New in matplotlib 1.5

Table of Contents

- *New in matplotlib 1.5*
 - *Interactive OO usage*

- *Working with labeled data like pandas DataFrames*
- *Added axes.prop_cycle key to rcParams*
- *New Colormaps*
- *Styles*
- *Backends*
- *Configuration (rcParams)*
- *Widgets*
- *New plotting features*
- *ToolManager*
- *cbook.is_sequence_of_strings recognizes string objects*
- *New close-figs argument for plot directive*
- *Support for URL string arguments to imread*
- *Display hook for animations in the IPython notebook*
- *Prefixed pkg-config for building*

Note: matplotlib 1.5 supports Python 2.7, 3.4, and 3.5

Interactive OO usage

All `Artists` now keep track of if their internal state has been changed but not reflected in the display ('stale') by a call to `draw`. It is thus possible to pragmatically determine if a given `Figure` needs to be re-drawn in an interactive session.

To facilitate interactive usage a `draw_all` method has been added to `pyplot` which will redraw all of the figures which are 'stale'.

To make this convenient for interactive use matplotlib now registers a function either with IPython's 'post_execute' event or with the displayhook in the standard python REPL to automatically call `plt.draw_all` just before control is returned to the REPL. This ensures that the draw command is deferred and only called once.

The upshot of this is that for interactive backends (including `%matplotlib notebook`) in interactive mode (with `plt.ion()`)

```
In [1]: import matplotlib.pyplot as plt
In [2]: fig, ax = plt.subplots()
In [3]: ln, = ax.plot([0, 1, 4, 9, 16])
```



```
In [4]: plt.show()
```

```
In [5]: ln.set_color('g')
```

will automatically update the plot to be green. Any subsequent modifications to the `Artist` objects will do likewise.

This is the first step of a larger consolidation and simplification of the pyplot internals.

Working with labeled data like pandas DataFrames

Plot methods which take arrays as inputs can now also work with labeled data and unpack such data.

This means that the following two examples produce the same plot:

Example

```
df = pandas.DataFrame({"var1": [1,2,3,4,5,6], "var2": [1,2,3,4,5,6]})
plt.plot(df["var1"], df["var2"])
```

Example

```
plt.plot("var1", "var2", data=df)
```

This works for most plotting methods, which expect arrays/sequences as inputs. `data` can be anything which supports `__getitem__` (`dict`, `pandas.DataFrame`, `h5py`, ...) to access array like values with string keys.

In addition to this, some other changes were made, which makes working with labeled data (ex `pandas.Series`) easier:

- For plotting methods with `label` keyword argument, one of the data inputs is designated as the label source. If the user does not supply a `label` that value object will be introspected for a label, currently by looking for a `name` attribute. If the value object does not have a `name` attribute but was specified by as a key into the data kwarg, then the key is used. In the above examples, this results in an implicit `label="var2"` for both cases.
- `plot()` now uses the index of a `Series` instead of `np.arange(len(y))`, if no `x` argument is supplied.

Added `axes.prop_cycle` key to `rcParams`

This is a more generic form of the now-deprecated `axes.color_cycle` param. Now, we can cycle more than just colors, but also linestyles, hatches, and just about any other artist property. Cycler notation is used for defining property cycles. Adding cyclers together will be like you are `zip()`-ing together two or more property cycles together:

```
axes.prop_cycle: cyclers('color', 'rgb') + cyclers('lw', [1, 2, 3])
```

You can even multiply cyclers, which is like using `itertools.product()` on two or more property cycles. Remember to use parentheses if writing a multi-line `prop_cycle` parameter.

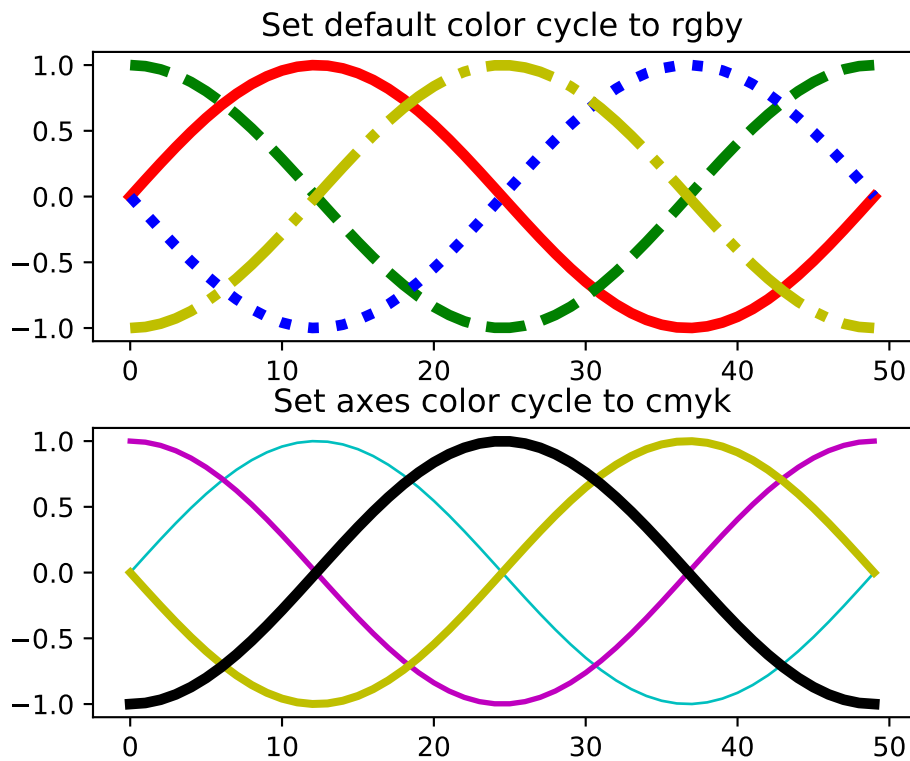

New Colormaps

All four of the colormaps proposed as the new default are available as 'viridis' (the new default in 2.0), 'magma', 'plasma', and 'inferno'

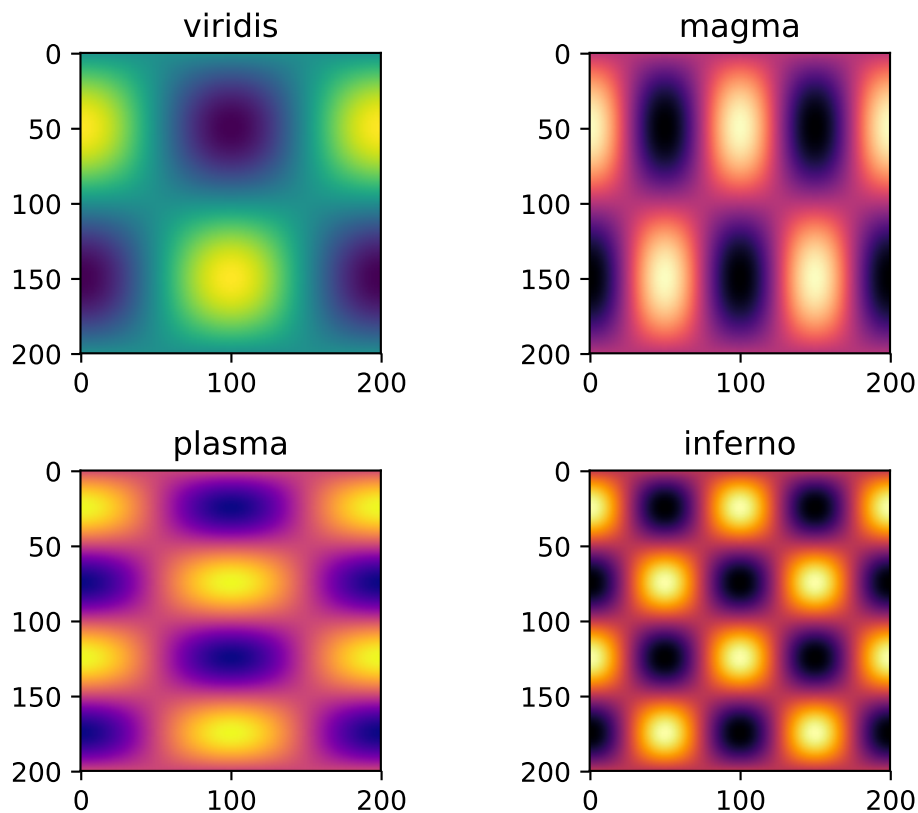

Styles

Several new styles have been added, including many styles from the Seaborn project. Additionally, in order to prep for the upcoming 2.0 style-change release, a ‘classic’ and ‘default’ style has been added. For this release, the ‘default’ and ‘classic’ styles are identical. By using them now in your scripts, you can help ensure a smooth transition during future upgrades of matplotlib, so that you can upgrade to the snazzy new defaults when you are ready!

```
import matplotlib.style
matplotlib.style.use('classic')
```

The ‘default’ style will give you matplotlib’s latest plotting styles:

```
matplotlib.style.use('default')
```

Backends

New backend selection

The environment variable `MPLBACKEND` can now be used to set the matplotlib backend.

wx backend has been updated

The wx backend can now be used with both wxPython classic and [Phoenix](#).

wxPython classic has to be at least version 2.8.12 and works on Python 2.x. As of May 2015 no official release of wxPython Phoenix is available but a current snapshot will work on Python 2.7+ and 3.4+.

If you have multiple versions of wxPython installed, then the user code is responsible setting the wxPython version. How to do this is explained in the comment at the beginning of the example `examplesuser_interfacesembedding_in_wx2.py`.

Configuration (rcParams)

Some parameters have been added, others have been improved.

Parameter	Description
<code>{x,y}axis. labelpad</code>	mplot3d now respects these parameters
<code>axes. labelpad</code>	Default space between the axis and the label
<code>errorbar. capsize</code>	Default length of end caps on error bars
<code>{x,y}tick. minor. visible</code>	Default visibility of minor x/y ticks
<code>legend. framealpha</code>	Default transparency of the legend frame box
<code>legend. facecolor</code>	Default facecolor of legend frame box (or 'inherit' from <code>axes.facecolor</code>)
<code>legend. edgecolor</code>	Default edgecolor of legend frame box (or 'inherit' from <code>axes.edgecolor</code>)
<code>figure. titlesize</code>	Default font size for figure subtitles
<code>figure. titleweight</code>	Default font weight for figure subtitles
<code>image. composite_image</code>	Whether a vector graphics backend should composite several images into a single image or not when saving. Useful when needing to edit the files further in Inkscape or other programs.
<code>markers. fillstyle</code>	Default fillstyle of markers. Possible values are 'full' (the default), 'left', 'right', 'bottom', 'top' and 'none'
<code>toolbar</code>	Added 'toolmanager' as a valid value, enabling the experimental ToolManager feature.

Widgets

Active state of Selectors

All selectors now implement `set_active` and `get_active` methods (also called when accessing the `active` property) to properly update and query whether they are active.

Moved `ignore`, `set_active`, and `get_active` methods to base class `Widget`

Pushes up duplicate methods in child class to parent class to avoid duplication of code.

Adds `enable/disable` feature to `MultiCursor`

A `MultiCursor` object can be disabled (and enabled) after it has been created without destroying the object. Example:

```
multi_cursor.active = False
```

Improved `RectangleSelector` and new `EllipseSelector` `Widget`

Adds an `interactive` keyword which enables visible handles for manipulating the shape after it has been drawn.

Adds keyboard modifiers for:

- Moving the existing shape (default key = 'space')
- Making the shape square (default 'shift')
- Make the initial point the center of the shape (default 'control')
- Square and center can be combined

Allow Artists to Display Pixel Data in Cursor

Adds `get_pixel_data` and `format_pixel_data` methods to artists which can be used to add `zdata` to the cursor display in the status bar. Also adds an implementation for `Images`.

New plotting features

Auto-wrapping Text

Added the keyword argument "wrap" to `Text`, which automatically breaks long lines of text when being drawn. Works for any rotated text, different modes of alignment, and for text that are either labels or titles. This breaks at the `Figure`, not `Axes` edge.

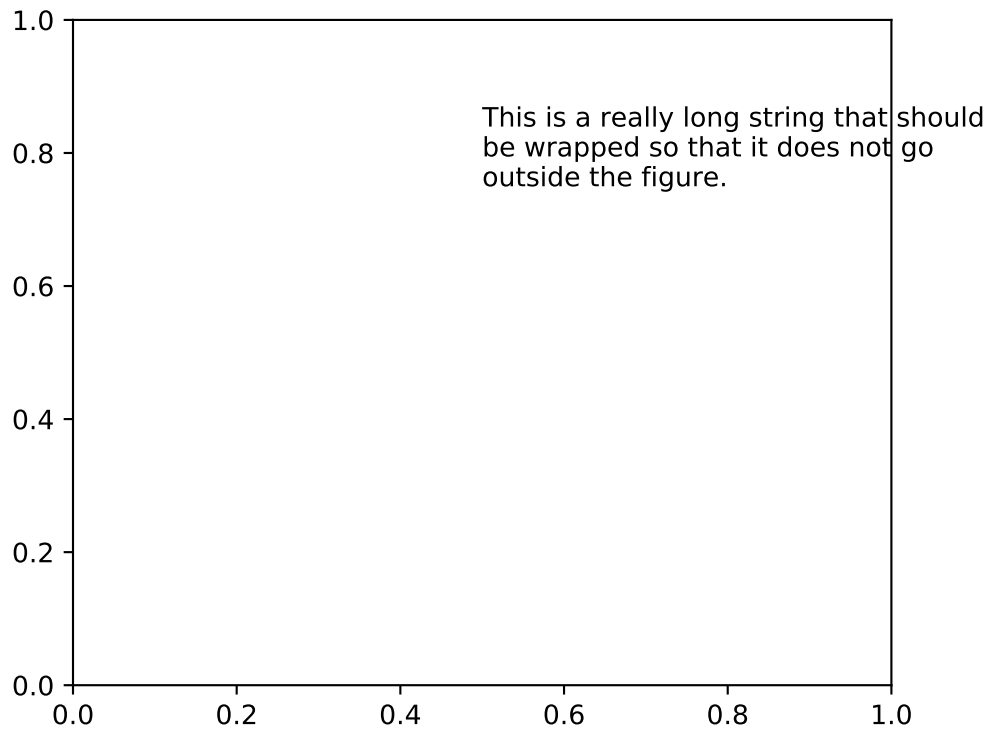

Contour plot corner masking

Ian Thomas rewrote the C++ code that calculates contours to add support for corner masking. This is controlled by a new keyword argument `corner_mask` in the functions `contour()` and `contourf()`. The previous behaviour, which is now obtained using `corner_mask=False`, was for a single masked point to completely mask out all four quads touching that point. The new behaviour, obtained using `corner_mask=True`, only masks the corners of those quads touching the point; any triangular corners comprising three unmasked points are contoured as usual. If the `corner_mask` keyword argument is not specified, the default value is taken from `rcParams`.

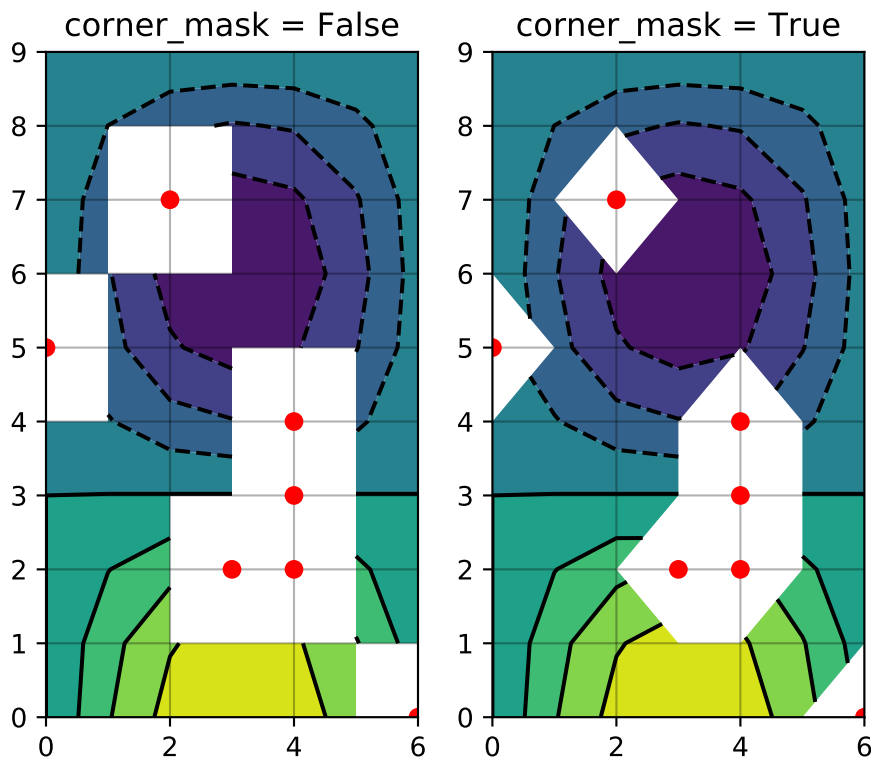

Mostly unified linestyles for Line2D, Patch and Collection

The handling of linestyles for Lines, Patches and Collections has been unified. Now they all support defining linestyles with short symbols, like "--", as well as with full names, like "dashed". Also the definition using a dash pattern (`([0., [3., 3.]])`) is supported for all methods using `Line2D`, `Patch` or `Collection`.

Legend marker order

Added ability to place the label before the marker in a legend box with `markerfirst` keyword

Support for legend for PolyCollection and stackplot

Added a `legend_handler` for `PolyCollection` as well as a `labels` argument to `stackplot()`.

Support for alternate pivots in mplot3d quiver plot

Added a `pivot` kwarg to `quiver()` that controls the pivot point around which the quiver line rotates. This also determines the placement of the arrow head along the quiver line.

Logit Scale

Added support for the ‘logit’ axis scale, a nonlinear transformation

$$x \rightarrow \log_{10}(x/(1-x)) \tag{9.1}$$

for data between 0 and 1 excluded.

Add step kwargs to fill_between

Added step kwarg to `Axes.fill_between` to allow to fill between lines drawn using the ‘step’ draw style. The values of step match those of the where kwarg of `Axes.step`. The asymmetry of of the kwargs names is not ideal, but `Axes.fill_between` already has a `where` kwarg.

This is particularly useful for plotting pre-binned histograms.

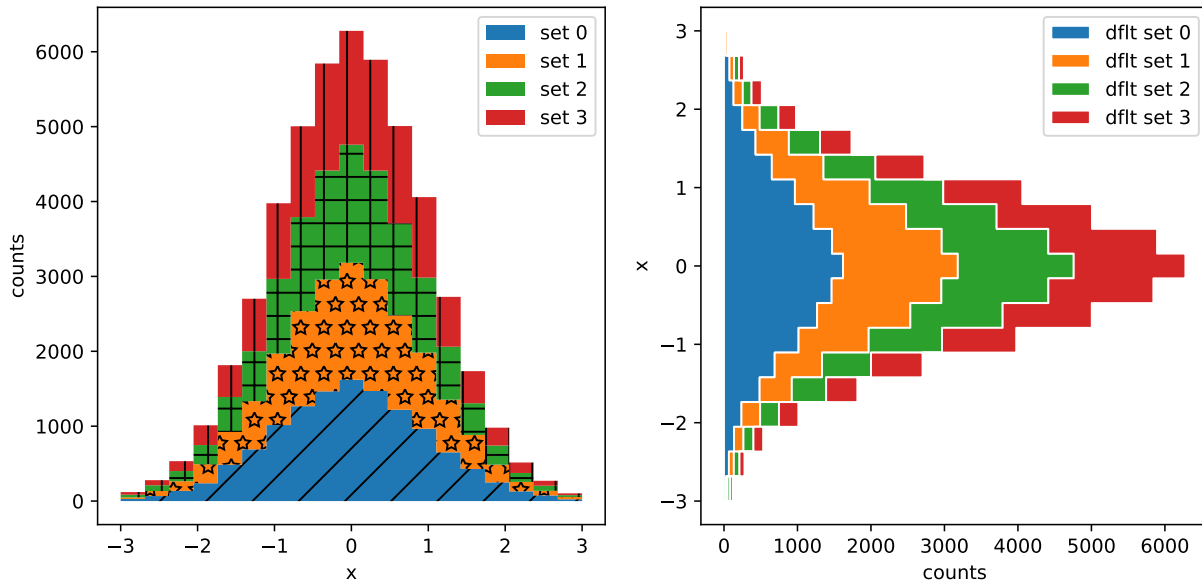

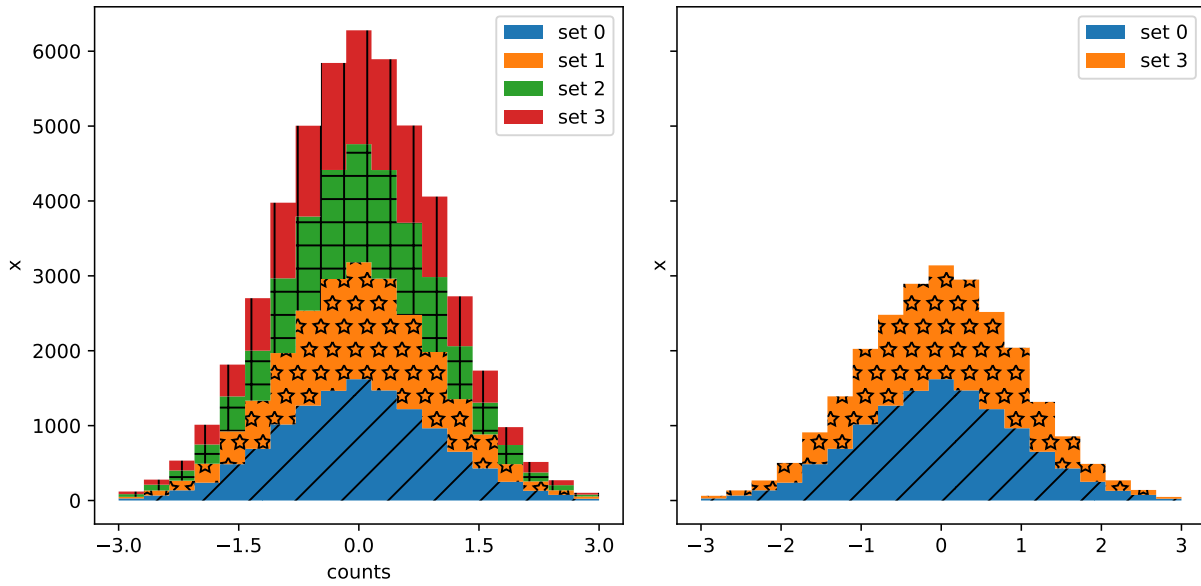

Square Plot

Implemented square plots feature as a new parameter in the axis function. When argument 'square' is specified, equal scaling is set, and the limits are set such that $x_{max}-x_{min} == y_{max}-y_{min}$.

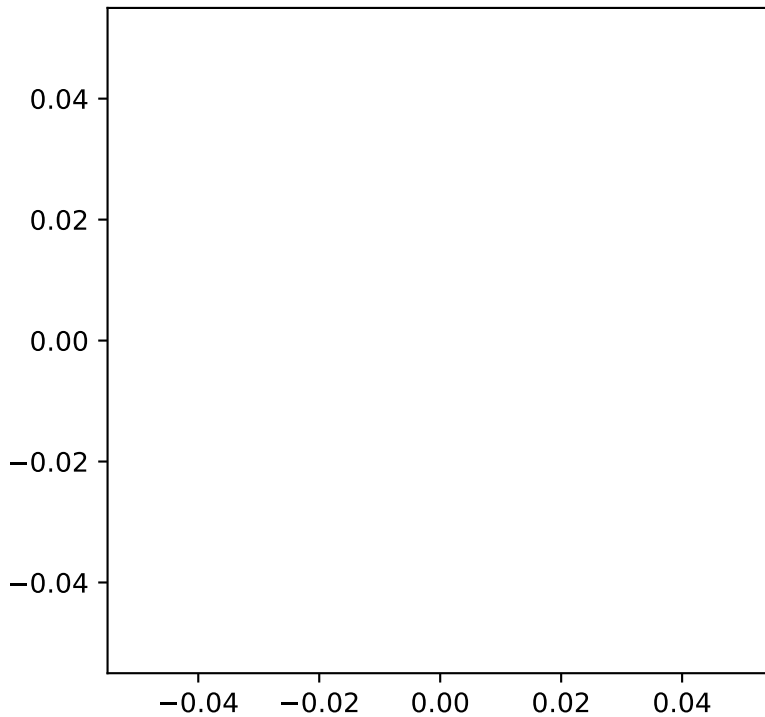

Updated figimage to take optional resize parameter

Added the ability to plot simple 2D-Array using `plt.figimage(X, resize=True)`. This is useful for plotting simple 2D-Array without the Axes or whitespacing around the image.



Updated Figure.savefig() can now use figure's dpi

Added support to save the figure with the same dpi as the figure on the screen using `dpi='figure'`.

Example:

```
f = plt.figure(dpi=25)           # dpi set to 25
S = plt.scatter([1,2,3],[4,5,6])
f.savefig('output.png', dpi='figure')  # output savefig dpi set to 25 (same as figure)
```

Updated Table to control edge visibility

Added the ability to toggle the visibility of lines in Tables. Functionality added to the `pyplot.table()` factory function under the keyword argument “edges”. Values can be the strings “open”, “closed”, “horizon-

tal”, “vertical” or combinations of the letters “L”, “R”, “T”, “B” which represent left, right, top, and bottom respectively.

Example:

```
table(..., edges="open") # No line visible
table(..., edges="closed") # All lines visible
table(..., edges="horizontal") # Only top and bottom lines visible
table(..., edges="LT") # Only left and top lines visible.
```

Zero r/cstride support in plot_wireframe

Adam Hughes added support to mplot3d’s plot_wireframe to draw only row or column line plots.

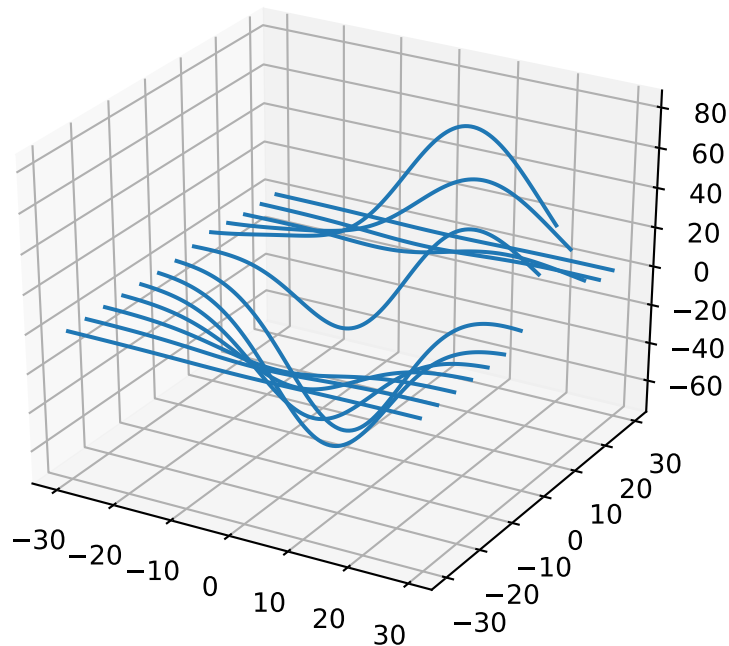

Plot bar and barh with labels

Added kwarg “tick_label” to bar and barh to support plotting bar graphs with a text label for each bar.

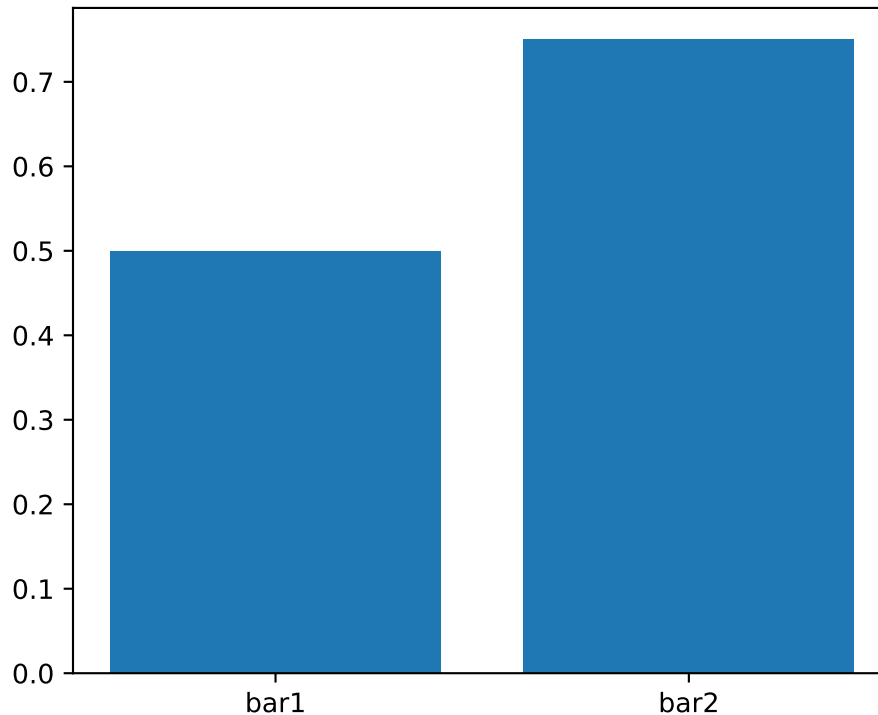

Added center and frame kwargs to pie

These control where the center of the pie graph are and if the Axes frame is shown.

Fixed 3D filled contour plot polygon rendering

Certain cases of 3D filled contour plots that produce polygons with multiple holes produced improper rendering due to a loss of path information between *PolyCollection* and *Poly3DCollection*. A function `set_verts_and_codes()` was added to allow path information to be retained for proper rendering.

Dense colorbars are rasterized

Vector file formats (pdf, ps, svg) are efficient for many types of plot element, but for some they can yield excessive file size and even rendering artifacts, depending on the renderer used for screen display. This is a problem for colorbars that show a large number of shades, as is most commonly the case. Now, if a colorbar is showing 50 or more colors, it will be rasterized in vector backends.

DateFormatter strftime

`strftime` method will format a `datetime.datetime` object with the format string passed to the formatter's constructor. This method accepts datetimes with years before 1900, unlike `datetime.datetime.strftime()`.

Artist-level `{get,set}_usetex` for text

Add `{get,set}_usetex` methods to `Text` objects which allow artist-level control of LaTeX rendering vs the internal `math` rendering.

`ax.remove()` works as expected

As with artists added to an `Axes`, `Axes` objects can be removed from their figure via `remove()`.

API Consistency fix within Locators `set_params()` function

`set_params()` function, which sets parameters within a `Locator` type instance, is now available to all `Locator` types. The implementation also prevents unsafe usage by strictly defining the parameters that a user can set.

To use, call `set_params()` on a `Locator` instance with desired arguments:

```
loc = matplotlib.ticker.LogLocator()
# Set given attributes for loc.
loc.set_params(numticks=8, numdecs=8, subs=[2.0], base=8)
# The below will error, as there is no such parameter for LogLocator
# named foo
# loc.set_params(foo='bar')
```

Date Locators

Date Locators (derived from `DateLocator`) now implement the `tick_values()` method. This is expected of all `Locator` derived from `Locator`.

The Date Locators can now be used easily without creating axes

```
from datetime import datetime
from matplotlib.dates import YearLocator
t0 = datetime(2002, 10, 9, 12, 10)
tf = datetime(2005, 10, 9, 12, 15)
loc = YearLocator()
values = loc.tick_values(t0, tf)
```

OffsetBoxes now support clipping

Artists draw onto objects of type `OffsetBox` through `DrawingArea` and `TextArea`. The `TextArea` calculates the required space for the text and so the text is always within the bounds, for this nothing has changed.

However, `DrawingArea` acts as a parent for zero or more `Artists` that draw on it and may do so beyond the bounds. Now child `Artists` can be clipped to the bounds of the `DrawingArea`.

OffsetBoxes now considered by `tight_layout`

When `tight_layout()` or `Figure.tight_layout()` or `GridSpec.tight_layout()` is called, `OffsetBoxes` that are anchored outside the axes will not get chopped out. The `OffsetBoxes` will also not get overlapped by other axes in case of multiple subplots.

Per-page pdf notes in multi-page pdfs (`PdfPages`)

Add a new method `attach_note()` to the `PdfPages` class, allowing the attachment of simple text notes to pages in a multi-page pdf of figures. The new note is visible in the list of pdf annotations in a viewer that has this facility (Adobe Reader, OSX Preview, Skim, etc.). Per default the note itself is kept off-page to prevent it to appear in print-outs.

`PdfPages.attach_note` needs to be called before `savefig()` in order to be added to the correct figure.

Updated `fignum_exists` to take figure name

Added the ability to check the existence of a figure using its name instead of just the figure number. Example:

```
figure('figure')
fignum_exists('figure') #true
```

ToolManager

Federico Ariza wrote the new *ToolManager* that comes as replacement for `NavigationToolbar2`

`ToolManager` offers a new way of looking at the user interactions with the figures. Before we had the `NavigationToolbar2` with its own tools like `zoom/pan/home/save/...` and also we had the shortcuts like `yscale/grid/quit/...`. `Toolmanager` relocate all those actions as `Tools` (located in *backend_tools*), and defines a way to `access/trigger/reconfigure` them.

The `Toolbars` are replaced for `ToolContainers` that are just GUI interfaces to `trigger` the tools. But don't worry the default backends include a `ToolContainer` called `toolbar`

Note: At the moment, we release this primarily for feedback purposes and should be treated as experimental until further notice as API changes will occur. For the moment the `ToolManager` works only with the `GTK3` and `Tk` backends. Make sure you use one of those. Port for the rest of the backends is coming soon.

To activate the ToolManager include the following at the top of your file

```
>>> matplotlib.rcParams['toolbar'] = 'toolmanager'
```

Interact with the ToolContainer

The most important feature is the ability to easily reconfigure the ToolContainer (aka toolbar). For example, if we want to remove the “forward” button we would just do.

```
>>> fig.canvas.manager.toolmanager.remove_tool('forward')
```

Now if you want to programmatically trigger the “home” button

```
>>> fig.canvas.manager.toolmanager.trigger_tool('home')
```

New Tools for ToolManager

It is possible to add new tools to the ToolManager

A very simple tool that prints “You’re awesome” would be:

```
from matplotlib.backend_tools import ToolBase
class AwesomeTool(ToolBase):
    def trigger(self, *args, **kwargs):
        print("You're awesome")
```

To add this tool to ToolManager

```
>>> fig.canvas.manager.toolmanager.add_tool('Awesome', AwesomeTool)
```

If we want to add a shortcut (“d”) for the tool

```
>>> fig.canvas.manager.toolmanager.update_keymap('Awesome', 'd')
```

To add it to the toolbar inside the group ‘foo’

```
>>> fig.canvas.manager.toolbar.add_tool('Awesome', 'foo')
```

There is a second class of tools, “Toggleable Tools”, this are almost the same as our basic tools, just that belong to a group, and are mutually exclusive inside that group. For tools derived from ToolToggleBase there are two basic methods enable and disable that are called automatically whenever it is toggled.

A full example is located in *user_interfaces example code: toolmanager.py*

cbook.is_sequence_of_strings recognizes string objects

This is primarily how pandas stores a sequence of strings

```
import pandas as pd
import matplotlib.cbook as cbook

a = np.array(['a', 'b', 'c'])
print(cbook.is_sequence_of_strings(a)) # True

a = np.array(['a', 'b', 'c'], dtype=object)
print(cbook.is_sequence_of_strings(a)) # True

s = pd.Series(['a', 'b', 'c'])
print(cbook.is_sequence_of_strings(s)) # True
```

Previously, the last two prints returned false.

New close-figs argument for plot directive

Matplotlib has a sphinx extension `plot_directive` that creates plots for inclusion in sphinx documents. Matplotlib 1.5 adds a new option to the plot directive - `close-figs` - that closes any previous figure windows before creating the plots. This can help avoid some surprising duplicates of plots when using `plot_directive`.

Support for URL string arguments to `imread`

The `imread()` function now accepts URL strings that point to remote PNG files. This circumvents the generation of a `HTTPResponse` object directly.

Display hook for animations in the IPython notebook

`Animation` instances gained a `_repr_html_` method to support inline display of animations in the notebook. The method used to display is controlled by the `animation.html rc` parameter, which currently supports values of `none` and `html5`. `none` is the default, performing no display. `html5` converts the animation to an h264 encoded video, which is embedded directly in the notebook.

Users not wishing to use the `_repr_html_` display hook can also manually call the `to_html5_video` method to get the HTML and display using IPython's HTML display class:

```
from IPython.display import HTML
HTML(anim.to_html5_video())
```

Prefixed pkg-config for building

Handling of `pkg-config` has been fixed in so far as it is now possible to set it using the environment variable `PKG_CONFIG`. This is important if your toolchain is prefixed. This is done in a similar way as setting `CC` or `CXX` before building. An example follows.

```
export PKG_CONFIG=x86_64-pc-linux-gnu-pkg-config
```

GITHUB STATS

GitHub stats for 2015/10/29 - 2017/05/09 (tag: v1.5.0)

These lists are automatically generated, and may be incomplete or contain duplicates.

We closed 1130 issues and merged 1003 pull requests.

The following 292 authors contributed 4014 commits.

- 4over7
- Aashil Patel
- AbdealiJK
- Acanthostega
- Adam
- Adam Williamson
- Adrian Price-Whelan
- Adrien Chardon
- Adrien F. Vincent
- Alan Bernstein
- Alberto
- alcinos
- Aleksey Bilogur
- Alex Rothberg
- Alexander Buchkovsky
- Alexis Bienvenüe
- Ali Uneri
- Alvaro Sanchez
- alvarosg
- AndersonDaniel

- Andreas Hilboll
- Andreas Mayer
- aneda
- Anthony Scopatz
- Anton Akhmerov
- Antony Lee
- Arvind
- bduick
- Ben Root
- Benedikt Daurer
- Benedikt J. Daurer
- Benjamin Berg
- Benjamin Congdon
- BHT
- Björn Dahlgren
- Bruno Zohreh
- BTWS
- buefox
- Cameron Davidson-Pilon
- Cameron Fackler
- Chen Karako
- Chris Holdgraf
- Christian Stadel-Schuldt
- Christoph Deil
- Christoph Gohlke
- Christopher Holdgraf
- Cimarron Mittelsteadt
- CJ Carey
- Colin
- Conner R. Phillips
- DaCoEx
- Dan Hickstein

- Daniel C. Marcu
- Daniel Laidig
- danielballan
- Danny Hermes
- DaveL17
- David A
- David Kent
- David Stansby
- deenes
- Devashish Deshpande
- Diego Mora Cespedes
- Dietrich Brunn
- dlmccaffrey
- Dmitry Shachnev
- Dora Fraeman
- DoriekeMG
- Drew J. Sonne
- Dylan Evans
- 5. (a) Patrick Bos
- Egor Panfilov
- Elliott Sales de Andrade
- Elvis Stansvik
- endolith
- Eric Dill
- Eric Firing
- Eric Larson
- Erin Pintozi
- Eugene Yurtsev
- Fabian-Robert Stöter
- FedeMiorelli
- Federico Ariza
- Felix Yan

- fibersnet
- Florencia Noriega
- Florian Le Bourdais
- Francoise Provencher
- Frank Yu
- Gauravjeet
- Gaute Hope
- gcallah
- Geoffrey Spear
- gepcel
- goldstarwebs
- greg-roper
- Grillard
- Guillermo Breto
- Gustavo Goretkin
- Hakan Kucukdereli
- hannah
- Hans Moritz Günther
- Hassan Kibirige
- Hastings Greer
- Heath Henley
- Heiko Oberdiek
- Henning Pohl
- Herbert Kruitbosch
- herilalaina
- Herilalaina Rakotoarison
- Ian Thomas
- Ilia Kurenkov
- Ilya Flyamer
- ImSoErgodic
- Isa Hassen
- Isaac Schwabacher

- Isaac Slavitt
- 10. Goutin
- Jaap Versteegh
- Jacob McDonald
- jacob-on-github
- Jae-Joon Lee
- James A. Bednar
- Jan Schlüter
- Jan Schulz
- Jarrod Millman
- Jason King
- Jason Zheng
- Jeffrey Hokanson @ Loki
- Jens Hedegaard Nielsen
- jli
- Johannes Wienke
- John Vandenberg
- JojoBoulix
- jonchar
- Joseph Fox-Rabinovitz
- Joseph Jon Booker
- Jouni K. Seppänen
- Juan Nunez-Iglesias
- juan.gonzalez
- Julia Sprenger
- Julian Mehne
- Julian V. Modesto
- Julien L
- Julien Lhermitte
- Julien Schueller
- Jun Tan
- Kacper Kowalik (Xarthisius)

- kalagau
- Kanchana Ranasinghe
- Kanwar245
- Keerysanth Sribaskaran
- Kenneth Ma
- Kevin Keating
- khyox
- Kjartan Myrdal
- Klara Gerlei
- klaus
- klonuo
- Kristen M. Thyng
- kshramt
- Kyle Bridgemohansingh
- Kyler Brown
- Laptop11_ASPP2016
- Iboogaard
- Leo Singer
- Levi Kilcher
- lspvic
- Luis Pedro Coelho
- Izk Kelley
- Maarten Baert
- Magnus Nord
- mamrehn
- Manuel Jung
- Massimo Santini
- Matt Hancock
- Matthew Brett
- Matthew Newville
- Matthias Bussonnier
- Matthias Lüthi

- Maximilian Albert
- Maximilian Maahn
- Mher Kazandjian
- Michael Droettboom
- Michiel de Hoon
- Mike Henninger
- Mike Jarvis
- MinRK
- mitch
- mlub
- mobando
- muahah
- myyc
- Naoya Kanai
- Nathan Goldbaum
- Nathan Musoke
- nbrunett
- Nelle Varoquaux
- nepix32
- Nicolas P. Rougier
- Nicolas Tessore
- Nikita Kniazev
- Nils Werner
- Ninad Bhat
- OceanWolf
- Orso Meneghini
- Pankaj Pandey
- patniharshit
- Paul Ganssle
- Paul Hobson
- Paul Ivanov
- Paul Kirow

- Paul Romano
- Pavol Juhas
- Pete Huang
- Pete Peterson
- Peter Iannucci
- Peter Mortensen
- Peter Würtz
- Petr Danecek
- Phil Elson
- Phil Ruffwind
- Pierre de Buyl
- productivememberofsociety666
- Przemysław Dąbek
- Qingpeng “Q.P.” Zhang
- RAKOTOARISON Herilalaina
- Ramiro Gómez
- Randy Olson
- rebot
- Rishikesh
- rishikksh20
- Robin Dunn
- Robin Wilson
- Ronald Hartley-Davies
- Rui Lopes
- Ryan May
- RyanPan
- Salganos
- Salil Vanvari
- Samson
- Samuel St-Jean
- Sander
- scls19fr

- Scott Howard
- scott-vsi
- Sebastian Raschka
- Sebastián Vanrell
- Seraphim Alvanides
- serv-inc
- shaunwbell
- Simon Gibbons
- sindunuragarp
- Stefan Pfenninger
- Stephan Erb
- Sterling Smith
- Steven Silvester
- Steven Tilley
- Tadeo Corradi
- Terrence J. Katzenbaer
- Terrence Katzenbaer
- The Gitter Badger
- Thomas A Caswell
- Thomas Hisch
- Thomas Robitaille
- Thomas Spura
- Thorsten Liebig
- Tian Xia
- Till Stensitzki
- tmdavison
- Tobias Froehlich
- tomoemon
- Trish Gillett-Kawamoto
- Truong Pham
- Tuan
- Tuan333

- [u55](#)
- [ultra-andy](#)
- [Valentin Schmidt](#)
- [Vedant Nanda](#)
- [Victor Zabalza](#)
- [Vidur Satija](#)
- [vraelvrangr](#)
- [V́ctor Zabalza](#)
- [Warren Weckesser](#)
- [Wieland Hoffmann](#)
- [Will Silva](#)
- [William Granados](#)
- [Xufeng Wang](#)
- [yinleon](#)
- [Zbigniew Jędrzejewski-Szmek](#)
- [Zohreh](#)

GitHub issues and pull requests:

Pull Requests (1003):

- [PR #8594](#): Missing return in `_num_to_string()`
- [PR #8584](#): Add pandas to python 3.6 build
- [PR #8583](#): Fix pandas datetime test on pandas 0.20
- [PR #8566](#): adding keyword plotting
- [PR #8567](#): Minor pytest parametrization
- [PR #8554](#): added basic_units download link to units examples
- [PR #8545](#): Add tutorials
- [PR #8176](#): Custom error message for `draw_path`. issues : [#8131](#) (bad error message from `pyplot.plot`)
- [PR #8185](#): Implement blocking Qt event loop.
- [PR #8346](#): Use some more pytest plugins: warnings & rerunfailures
- [PR #8536](#): Update doc build.
- [PR #8544](#): updating developer docs
- [PR #8548](#): fixing scatter doc
- [PR #8546](#): nested pie example

- PR #8539: Fix rectangular patches to be properly transformed on polar axes
- PR #8525: Sphinx Gallery API pages + deprecating old examples folder
- PR #8538: Update doc/thirdpartypackages/index.rst
- PR #8535: Remove use of (deprecated) `is_string_like` in `mplot3d`.
- PR #8526: Clarify docs for `rcdefaults` and `friends`.
- PR #8513: Fix autoscaling with `twinx` and `vspans`: consider axis with one pair of finite limits ONLY
- PR #8523: Update conda patch for AppVeyor build.
- PR #8522: adding `backreferences_dir` param
- PR #8491: Remove `codecov` coverage targets.
- PR #8518: Discourage omitting backend in `matplotlibrc`
- PR #8486: changed inherited `Axes` calls to `super`
- PR #8511: Update front page so there's only one gallery
- PR #8510: MNT: update GH issue template [ci skip]
- PR #8478: Fixed Error: local variable 'xdata' referenced before assignment" in `legend_handler.py`
- PR #8502: Update PR template to encourage PRs off not master.
- PR #8495: Fix incorrect text line spacing.
- PR #8472: migrate examples to sphinx-gallery
- PR #8488: Build docs with oldest numpy on 2.7.
- PR #8377: Clean up unit examples
- PR #8011: Deprecate `is_string_like`, `is_sequence_of_strings`
- PR #7990: Added a workaround for Jupyter notebooks
- PR #8324: Update `svg_tooltip.py`
- PR #8380: Make `image_comparison` more `pytest-y`
- PR #8485: FIX `markevery` only accepts builtin integers, not numpy integers
- PR #8489: Fix markup in `plt.subplots` docstring.
- PR #8490: Clarify that `Path.contains_x` implicitly closes the `Path`.
- PR #8492: Remove useless, confusing check in `hist()`.
- PR #7931: The font with the same weight name as the user specified weight name ...
- PR #8256: [DOC] Clean up `bar_demo2`
- PR #8455: Added axes inversion to `cla()`
- PR #8474: Check for non-finite axis limits placed on `converted_limit`
- PR #8482: Modified PR Template

- [PR #7572](#): Overhaul external process calls
- [PR #8394](#): Unify WM_CLASS across backends
- [PR #8447](#): Let imshow handle float128 data.
- [PR #8476](#): Pull Request template
- [PR #8450](#): Don't bother disconnecting signals in QTimerQt.__del__.
- [PR #8468](#): Clarify that Image.set_data doesn't update normalization.
- [PR #8403](#): New Feature - PolygonSelector Widget
- [PR #8157](#): add which kwarg to autofmt_xdate
- [PR #8022](#): Fixed Issue #7460: Raised an error if argument to xlim is invalid
- [PR #8336](#): Merged streamline examples
- [PR #8399](#): Fix % formatting and Transform equality.
- [PR #8319](#): FancyArrowPatch docstring overhaul
- [PR #8452](#): Revert #5392
- [PR #8344](#): Add simple ax.arrow test
- [PR #8462](#): Add container module to API docs
- [PR #8456](#): Migration to sphinx-gallery
- [PR #8454](#): Finish deprecating idle_event; style cleanups to backend_bases
- [PR #8326](#): Orthographic projection for mplot3d
- [PR #8453](#): Manually collect lines on checkbox example
- [PR #8446](#): Download the depsy.org badge when building the html documentation
- [PR #8435](#): Improve hist2d docstring by inlining properties.
- [PR #8376](#): Remove exceltools and gtktools from docs
- [PR #8322](#): Use scalars below a certain exponent in labels of log-scales axis
- [PR #8374](#): DOC update build dependencies
- [PR #8339](#): Give wide code blocks a scrollbar on website
- [PR #8253](#): Handle floating point round-off error when converting to pixels for h264 animations
- [PR #8156](#): DOC: Add missing cmaps to perception doc (fix for #8073)
- [PR #8373](#): [DOC] Updated the documentation
- [PR #8391](#): DOC: Update MEP 28
- [PR #8340](#): Refactor code duplication in matplotlib.markers
- [PR #8396](#): DOC: Show off FuncFormatter as a decorator
- [PR #8383](#): Merge v2.0.x into master

- PR #8372: MNT: cleanup whitespace around @_preprocess decorator
- PR #6310: Make checkbuttons with all plotted lines with correct visibility automatically
- PR #7786: Don't reshape offsets into the correct shape.
- PR #8254: Adding headers for examples/units for MEP12/sphinx-gallery compliance
- PR #8369: Use cbook._reshape_2D in hist.
- PR #8371: DOC: Clean up the pie docstring PR
- PR #8343: Make ArrowStyle docstrings numpydoc compatible
- PR #8368: Cleanup appveyor.yml.
- PR #8334: Fix Appveyor build.
- PR #8367: symlog + minor ticks = exception
- PR #8258: DOC: Clean up equal-aspect example
- PR #8116: Simplify _reshape_2D.
- PR #8240: DOC refactored installation instruction
- PR #8363: DOC: update link to mpl-probscale
- PR #8362: Add adjustText to the list of third party packages
- PR #7691: ENH: Optional 3d bar shading
- PR #8264: Fix leaky ps
- PR #8338: Renamed all 'mtrans' into more common 'mtransforms'
- PR #8331: Don't index into __builtins__ (not supported by PyPy).
- PR #8311: DOC api's transition to sphinx-gallery is now complete
- PR #8287: FIX: add __setstate__ function
- PR #8281: Fix testing with tests.py on Py3.6.
- PR #8149: Fix check for DISPLAY on PyQt5.
- PR #7844: Fix containment test with nonlinear transforms.
- PR #8306: DOC added titles to the rest of the 3D plots
- PR #8328: Use neutral pronoun in docs.
- PR #8295: Removes OldScalarFormatter #7956
- PR #8310: DOC shapes and collections is fully SG compatible
- PR #8304: Remove executable bit from examples and headers.
- PR #8229: MEP12 ganged example
- PR #8301: STY: fix whitespace in the tests
- PR #8248: Inkscape shell mode.

- PR #8298: Fix sphinx required version
- PR #8276: MAINT moved some maintenance and helper python scripts to tools/
- PR #8275: DOC moved changelog to the documentation
- PR #8262: TST: fail on missing baseline file
- PR #8244: BUG Ignore invisible axes in computing tight_layout
- PR #8018: Cleanup visual_tests and disable browser opening
- PR #8268: DOC moved spines examples sphinx-gallery
- PR #8239: changes in travis's build environment
- PR #8274: Removed obsolete license.py file
- PR #8165: FIX: Remove type checking for strings in '_validate_linestyle'
- PR #8261: Set __name__ for list validators in rcsetup.
- PR #8217: Add option to rotate labels in a pie chart (#2304)
- PR #8227: Contouring 1x1 array (issue #8197)
- PR #8269: Use sys.executable -msphinx instead of sphinx-build.
- PR #8252: Memoize parse_fontconfig_pattern; speeds up test suite by ~1min.
- PR #8047: Correct theta values when drawing a non-circular arc
- PR #8245: DOC: sphinx-gallery histograms
- PR #8241: Remove image with non-free color calibration profile
- PR #7878: Update vlines example with axes wide lines.
- PR #8237: Fix pep8 violation
- PR #8224: Implement Path.intersects_bbox in C++ to speed up legend positioning.
- PR #8228: MEP12 text alignment example
- PR #8179: TST: Enable cache directories on AppVeyor.
- PR #8211: Mep12 text labels and annotations
- PR #8234: fix gitter badge
- PR #8233: changes to MEP12/sphinx-gallery compliant
- PR #8196: Issue #8141: Dash validator allowing None values in addition to floats
- PR #8154: merge fill_demo and fill_demo_features
- PR #8213: TST: skip fc-list related tests if not installed
- PR #8172: [MRG+1] [DOC] Turn ginput dostring into a numpydocstring
- PR #8173: [MRG+1] Simplify and clean multicolor_line example
- PR #8221: Early check for dot binary (from graphviz) when building the doc (fixes #8207)

- PR #8215: Mep12 showcase
- PR #8212: Mep12 ticks and spines
- PR #8219: [DOC] Plural of axis is axes
- PR #7744: Added axis limit check for non-finite values
- PR #5691: Update documentation of stem to mention StemContainer
- PR #8175: Add autoclass entry for Artist API doc.
- PR #8158: Fix layout of spectrum_demo.py
- PR #8190: add gitter link in README
- PR #8007: Clean up BoundaryNorm docstring
- PR #8178: Addresses #8177, Readme badges
- PR #8166: MAINT: mappingview check for Python 3.4
- PR #8171: DOC: Fix small typos in 'eventplot' docstring
- PR #8167: Fixes typos in Artist tutorial
- PR #8161: Add a code block in 'installing' docs.
- PR #8150: Deprecate Axes.axesPatch, Figure.figurePatch.
- PR #8148: Remove support for -dbackend argv.
- PR #8137: Regenerate the gitwash docs.
- PR #6977: Handle dvi font names as ASCII bytestrings
- PR #8066: Clean up and move text rotation example
- PR #8134: Update Slider docs and type check slidermin and slidermax.
- PR #8139: DOC: Fixed x, y, docstring in errorbar
- PR #8133: Disable network tests on AppVeyor.
- PR #8065: Clean up and move accented text example
- PR #8119: Drop None from Container.get_children().
- PR #8115: Add branch coverage; exclude _version.py from coverage.
- PR #7995: Set sticky_edges correctly for negative height bar().
- PR #8118: Deprecate matplotlib.tests.assert_str_equal.
- PR #7394: Cleanup transforms.py.
- PR #8036: Tweak coverage
- PR #8110: Mrg2.0.x
- PR #8103: Use XDG config path on FreeBSD
- PR #8026: Pytest documentation + build tweaks

- PR #8101: Named Matplotlib module in windows instructions
- PR #8099: Update examples/README.txt.
- PR #8094: Remove example of matrix of size (12, 12) and (64, 64)
- PR #8040: ENH: Stricter validation of line style rcParams (and extended accepted types for `grid.linestyle`)
- PR #8097: use `plt.gca` instead of `plt.axes` for already existing implicit axes
- PR #8096: Improve error message for `image_comparison` decorator.
- PR #8085: Fix PYTHONHASHSEED setup on OS X.
- PR #8086: DOC: add SOURCELINK_SUFFIX for compatibility with Sphinx 1.5
- PR #8063: Update MovieWriter dpi default
- PR #8084: Add link to scipython book
- PR #7871: Use `backports.functools_lru_cache` instead of `functools32`
- PR #8070: Switch to `suppress` option to `True` in `setup.cfg.template`.
- PR #4997: The url of downloading historical prices of Yahoo Finance has changed
- PR #8043: Fix `pyplot.axis(ax)` when `ax` is in other figure.
- PR #8055: Undeprecate `is_scalar_or_string`.
- PR #8060: Added `tight_layout()` to example.
- PR #7968: Fix `cohere-demo`
- PR #8033: Update inline comment in `set_and_get.py`
- PR #7985: Catch `specgram` warnings during tests
- PR #7965: ENH: Fixed `PercentFormatter` usage with `latex`
- PR #8014: do not ignore “closed” parameter in `Poly3DCollection`
- PR #7933: Cleanup: use `is not` instead of `not ... is`, etc.
- PR #7981: Clarify `backports` documentation
- PR #8020: Allow choosing `logit` scale in `qt` figure options.
- PR #8003: Coverage config
- PR #7974: Switch testing to `pytest` completely
- PR #8001: Switch to `pytest-pep8`.
- PR #7993: MAINT: Updated tick and category test formatting
- PR #8002: Remove `pytest_pycollect_makeitem`.
- PR #7925: Fix a number of `Deprecated/Invalid` escape sequences
- PR #7999: More `cbook` deprecations.

- [PR #7973](#): Convert test decorators to pytest fixtures
- [PR #7996](#): Simplify implementation of `is_numlike` & `is_string_like`.
- [PR #7998](#): Display relative image paths when tests fail.
- [PR #7997](#): Default `cmap` is not jet anymore...
- [PR #7809](#): Fix for marker verts bug
- [PR #7987](#): Add vega deprecations to tests on master
- [PR #7625](#): Legend aut positioning with “spiraling” lines.
- [PR #7983](#): Remove `assert_true` calls from new PRs.
- [PR #7980](#): Coding Guide Edits
- [PR #7959](#): Allow zero sized ticks
- [PR #7767](#): Don’t check `iterable()` before `len()`.
- [PR #7913](#): Clean up quiver docstring + add simple quiver example
- [PR #7023](#): Add `clf` kwarg to `plt.figure()`
- [PR #7857](#): Fix/hide some deprecations
- [PR #7961](#): Compute glyph widths similarly in Type 42 as in Type 3
- [PR #7972](#): MAINT cleaning up of gallery examples.
- [PR #7952](#): MEP12 of showcase’s examples + other folders.
- [PR #7904](#): `twinx` / `twiny` inherit autoscale behavior for shared axis
- [PR #7935](#): Finish removing nose
- [PR #7859](#): Fix typo in `Axes3D.set_autoscalez_on`.
- [PR #7947](#): MAINT `testing.nose` -> `testing._nose` to make it explicitly private
- [PR #7960](#): Don’t try to build for py34 on appveyor
- [PR #7949](#): Remove `sharex_foreign` example, now useless.
- [PR #7843](#): MAINT: add ability to specify recursionlimit
- [PR #7941](#): Cleanup: remove unused variable/assignment/expression and debug comments
- [PR #7944](#): Improve hexbin performance
- [PR #7938](#): Fix typo in toolkits docs
- [PR #7752](#): bugfix for wx backend: release mouse on loss of focus and before trying to recapture
- [PR #7914](#): Fix unpickling of `CallbackRegistry` on Py2.
- [PR #7929](#): Remove a dead code (`font_manager.ttfdict_fnames`)
- [PR #7932](#): Convert remaining tests to pytest
- [PR #7926](#): Stop codecov from posting messages

- PR #7892: Configure AppVeyor to fail fast
- PR #7934: Run animation smoketest in a temporary directory.
- PR #7872: Convert font/text tests to pytest
- PR #7915: Convert sphinxext tests to pytest.
- PR #7898: MAINT moved g-i-l* modules to pytest
- PR #7897: MAINT moved all remaining “f” modules to pytest
- PR #7863: Convert backend tests to use pytest
- PR #7907: BUG: Add a newline separator in fc-list call
- PR #7920: Convert preprocess tests to pytest
- PR #7887: Convert mpl toolkits tests to pytest + minor cleanup
- PR #7918: Convert test_s* files to pytest and flake8 them
- PR #7916: Convert test_[ab]* files to pytest.
- PR #7923: Fix leak of filedescrptor if fontsize cannot be set.
- PR #7900: DOC MEP12: pie/polar and color examples + style sheets fix
- PR #7818: Tripcolor.py: Remove documentation rendering error
- PR #7896: Reject floatlike strings in mcolors.to_rgba.
- PR #7830: MAINT moved _backports to cbook module
- PR #7883: Convert mlab tests to pytest
- PR #7885: MAINT moved all “d” modules to pytest.
- PR #7889: Convert remaining test_t* files to pytest.
- PR #7748: MAINT: Deterministic SVG and PDF tests
- PR #7884: MAINT moved “c” modules to pytest
- PR #7890: DOC Convert style sheet examples to MEP12
- PR #7888: Transform test updates (pytest + cleanup)
- PR #7882: MAINT pytest now exit on first failure on travis
- PR #7327: DOC MEP12 - converted lines, bars and markers to SG/MEP12 compatible
- PR #7811: Allow figure.legend to be called without arguments
- PR #7854: !B [#7852] fix for _rrule maximum recursion depth exceeded on multiprocessing usage
- PR #7861: Make radio and check buttons visible
- PR #7868: MNT: reference the proper variable in bootstrapper
- PR #7817: better input validation on fill_between
- PR #7864: Minor simplification of inset_locator_demo.

- [PR #7865](#): FIX Preserve title case when saving through GUI (issue #7824)
- [PR #7850](#): Allow AnchoredOffset to take a string-like location code
- [PR #7845](#): Fixed bug with default parameters NFFT and noverlap in specgram()
- [PR #7800](#): DOC: explain non-linear scales and imshow (closes #7661)
- [PR #7639](#): Enh color names
- [PR #7829](#): MAINT tests should not use relative imports
- [PR #7828](#): MAINT added early checks for dependencies for doc building
- [PR #7424](#): Numpy Doc Format
- [PR #7821](#): DOC: Changes to screenshots plots.
- [PR #7644](#): Allow scalar height for plt.bar
- [PR #7838](#): Merge v2.x
- [PR #7823](#): MAINT matplotlib -> Matplotlib
- [PR #7833](#): Deprecate unused verification code.
- [PR #7827](#): Cast stackplot input to float when required.
- [PR #7834](#): Remove deprecated get_example_data.
- [PR #7826](#): Remove invalid dimension checking in axes_rgb.
- [PR #7831](#): Function wrapper for examples/api/two_scales.py
- [PR #7801](#): Add short-circuit return to matplotlib.artist.setp if input is length 0
- [PR #7740](#): Beautified frontpage plots and two pylab examples
- [PR #7730](#): Fixed GraphicsContextBase linestyle getter
- [PR #7747](#): Update qhull to 2015.2
- [PR #7645](#): Clean up stock sample data.
- [PR #7753](#): Clarify the uses of whiskers float parameter.
- [PR #7765](#): TST: Clean up figure tests
- [PR #7729](#): For make raw_input compatible with python3
- [PR #7783](#): Raise exception if negative height or width is passed to axes()
- [PR #7727](#): DOC: Fix invalid nose argument in testing.rst
- [PR #7731](#): Check origin when saving image to PNG
- [PR #7782](#): Fix some more integer type inconsistencies in Freetype code
- [PR #7781](#): Fix integer types for font metrics in PyGlyph class
- [PR #7791](#): Use reliable int type for mesh size in draw_quad_mesh (#7788)
- [PR #7796](#): Only byte-swap 16-bit PNGs on little-endian (#7792)

- PR #7794: Ignore images that doc build produces
- PR #7790: Adjust markdown and text in ISSUE_TEMPLATE.md
- PR #7773: Fix more invalid escapes sequences.
- PR #7769: Remove redundant pep8 entry in .travis.yml.
- PR #7760: DOC: Correct subplot() doc
- PR #7768: Convert unicode index to long, not int, in get_char_index
- PR #7770: BUG: improve integer step selection in MaxNLocator
- PR #7766: Invalid escape sequences are deprecated in Py3.6.
- PR #7758: fix axes barh default align option document
- PR #7749: DOC: Sync keyboard shortcuts for fullscreen toggle
- PR #7757: By default, don't include tests in binary distributions.
- PR #7762: DOC: Fix finance depr docs to point to mpl_finance
- PR #7737: Ensure that pyenv command is in a literal block
- PR #7732: Add rcsetup_api.rst, fix typo for rcsetup.cycler
- PR #7726: FIX: Clean up in the new quiverkey test; make new figs in scale tests
- PR #7620: Add warning context
- PR #7719: Add angle kwarg to quiverkey
- PR #7701: DOC: Add bug report reqs and template to contributing guide
- PR #7723: Use mplDeprecation class for all deprecations.
- PR #7676: Makes eventplot legend work
- PR #7714: TST: switch from 3.6-dev to 3.6
- PR #7713: Declare Python 3.6 support via classifier in setup.py
- PR #7693: Change majority of redirected links in docs
- PR #7705: Fixes tzname return type
- PR #7703: BF: Convert namespace path to list
- PR #7702: DOC: Add link to bokeh/colorcet in colormaps.rst
- PR #7700: DOC: Add gitter to home page
- PR #7692: Corrected default values of xextent in specgram(). Fixes Bug #7666.
- PR #7698: Update INSTALL for Python 3.6
- PR #7694: Fix a few broken links in docs
- PR #7349: Add support for png_text metadata, allow to customize metadata for other backends.
- PR #7670: Decode error messages from image converters.

- [PR #7677](#): Make new default style examples consistent
- [PR #7674](#): Serialize comparison of multiple baseline images.
- [PR #7665](#): FIX: Fix super call for Python 2.7
- [PR #7668](#): Save SVG test directly to file instead of its name.
- [PR #7549](#): Cleanup: sorted, dict iteration, array.{ndim,size}, ...
- [PR #7667](#): FIX: Fix missing package
- [PR #7651](#): BUG,ENH: make deprecated decorator work (and more flexibly)
- [PR #7658](#): Avoid comparing numpy array to strings in two places
- [PR #7657](#): Fix warning when setting markeredgecolor to a numpy array
- [PR #7659](#): DOC: Original documentation was misleading
- [PR #6780](#): Call `_transform_vmin_vmax` during `SymLogNorm.__init__`
- [PR #7646](#): Improve deprecation documentation. Closes [#7643](#)
- [PR #7604](#): Warn if different axis projection requested
- [PR #7568](#): Deprecate unused functions in cbook.
- [PR #6428](#): Give a better error message on missing PostScript fonts
- [PR #7585](#): Fix a bug in `TextBox` where shortcut keys were not being reenabled
- [PR #7628](#): picker may not be callable.
- [PR #7464](#): ENH: `_StringFuncParser` to get numerical functions callables from strings
- [PR #7622](#): Mrg animation merge
- [PR #7618](#): DOC: fixed typo in `mlab.py`
- [PR #7596](#): Delay `fc-list` warning by 5s.
- [PR #7607](#): TST: regenerate `patheffect2`
- [PR #7608](#): Don't call `np.min` on generator.
- [PR #7570](#): Correctly skip colors for nan points given to scatter
- [PR #7605](#): Make bars stick to explicitly-specified edges.
- [PR #6597](#): Reproducible PS/PDF output (master)
- [PR #7546](#): Deprecate `update_datalim_numerix&update_from_data`.
- [PR #7574](#): Docs edits
- [PR #7538](#): Don't work out packages to install if user requests information from `setup.p`
- [PR #7577](#): Spelling fix: `corosponding` -> `corresponding`
- [PR #7536](#): Rectangle patch angle attribute and patch `__str__` improvements
- [PR #7547](#): Additional cleanups

- [PR #7544](#): Cleanups
- [PR #7548](#): Clarify to_rgba docstring.
- [PR #7476](#): Sticky margins
- [PR #7552](#): Correctly extend a lognormed colorbar
- [PR #7499](#): Improve the the marker table in markers_api documentation
- [PR #7468](#): TST: Enable pytest-xdist
- [PR #7530](#): MAINT: TkAgg default backend depends on tkinter
- [PR #7531](#): double tolerance for test_png.py/pngsuite on Windows
- [PR #7533](#): FIX chinese character are hard to deal with in latex
- [PR #7525](#): Avoid division by zero if headlength=0 for quiver
- [PR #7522](#): Check at least one argument is provided for plt.table
- [PR #7520](#): Fix table.py bug
- [PR #7397](#): Numpydoc for backends
- [PR #7513](#): Doc: Typo in gridspec example subtitle
- [PR #7494](#): Remove some numpy 1.6 workarounds
- [PR #7500](#): Set hexbin default linecolor to 'face'
- [PR #7498](#): Fix double running of explicitly chosen tests.
- [PR #7475](#): Remove deprecated "shading" option to pcolor.
- [PR #7436](#): DOC: Fixed Unicode error in gallery template cache
- [PR #7496](#): Commit to fix a broken link
- [PR #6062](#): Add maximum streamline length property.
- [PR #7470](#): Clarify cross correlation documentation #1835
- [PR #7481](#): Minor cleanup of hist().
- [PR #7474](#): FIX/API: regenerate test figure due to hatch changes
- [PR #7469](#): TST: Added codecov
- [PR #7467](#): TST: Fixed part of a test that got displaced in all the changes somehow
- [PR #7447](#): Showcase example: (kind of mandatory) Mandelbrot set
- [PR #7463](#): Added additional coverage excludes
- [PR #7449](#): Clarify documentation of pyplot.draw
- [PR #7454](#): Avoid temporaries when preparing step plots.
- [PR #7455](#): Update two_scales.py example.
- [PR #7456](#): Add pytest's .cache to .gitignore.

- PR #7453: TST: Fixed `test_log_margins` test
- PR #7144: Cleanup scales
- PR #7442: Added spacer to Tk toolbar
- PR #7444: Enhance `annotation_demoX` examples
- PR #7439: MEP12 API examples
- PR #7416: MAINT deprecated 'spectral' in favor of 'nipy_spectral'
- PR #7435: restore test that was inadvertently removed by 5901b38
- PR #7363: Add appropriate error on color size mismatch in `scatter`
- PR #7433: FIX: search for tkinter first in builtins
- PR #7362: Added `-j` shortcut for `--processes=`
- PR #7408: Handle nan/masked values `Axes.vlines` and `hlines`
- PR #7409: FIX: MPL should not use new tool manager unless explicitly asked for. Closes #7404
- PR #7389: DOC Convert axes docstrings to numpydoc: #7205
- PR #7417: Merge from v2.x
- PR #7398: Moved python files from `doc/pyplots` to `examples` folder
- PR #7291: MEP 29: Markup text
- PR #6560: `Fillbetween`
- PR #7399: Clarify `wspace/hspace` in documentation/comments
- PR #7400: fix ReST tag
- PR #7381: Updating the readme
- PR #7384: change `hardcopy.docstring` to `docstring.hardcopy`
- PR #7386: ENH examples are now reproducible
- PR #7395: Drop code that supports numpy pre-1.6.
- PR #7385: remove unused `random` import
- PR #7236: ENH Improving the contribution guidelines
- PR #7370: Add example use of `axes.spines.SIDE` prop in `matplotlibrc`
- PR #7367: Warn on invalid log axis limits, per issue #7299
- PR #7360: Updated violin plot example as per suggestions in issue #7251
- PR #7357: Added notes on how to use matplotlib in `pyenv`
- PR #7329: DOC MEP12 - converted animation to SG/MEP12 compatible
- PR #7337: FIX `symlog` scale now shows negative labels.
- PR #7354: fix small error in `poly_editor` example

- PR #7310: TST: Make proj3d tests into real tests
- PR #7331: MEP12 improvements for statistics plots
- PR #7340: DOC: Normalize symlink target
- PR #7328: TST: Fixed rparams test_Issue_1713 test
- PR #7303: Traceback to help fixing double-calls to mpl.use.
- PR #7346: DOC: Fix annotation position (issue #7345)
- PR #5392: BUG: arrowhead drawing code
- PR #7318: Convert a few test files to Pytest
- PR #7323: Fix #6448: set xmin/ymin even without non-zero bins in 'step' hist
- PR #7326: Enable coverage sending on pytest build
- PR #7321: Remove bundled virtualenv module
- PR #7290: Remove deprecated stuff schedule for removal.
- PR #7324: DOC: Boxplot color demo update
- PR #6476: Add a common example to compare style sheets
- PR #7309: MEP28: fix rst syntax for code blocks
- PR #7250: Adds docstrings to demo_curvelinear_grid.py and demo_curvelinear_grid...
- PR #4128: Code removal for post 1.5/2.1
- PR #7308: Fix travis nightly build
- PR #7282: Draft version of MEP28: Simplification of boxplots
- PR #7304: DOC: Remove duplicate documentation from last merge.
- PR #7249: add docstring to example: axisartist/demo_floating_axes.py
- PR #7296: MAINT removing docstring dedent_interpd when possible
- PR #7298: Changed Examples for Pep8 Compliance
- PR #7295: MAINT finance module is deprecated
- PR #7214: FIX: Only render single patch for scatter
- PR #7297: MAINT docstring appending doesn't mess with rendering anymore.
- PR #6907: Filled + and x markers
- PR #7288: Style typos fixes
- PR #7277: MEP12 - added sphinx-gallery docstrings
- PR #7286: DOC: Fix for #7283 by adding a trailing underscore to misrendered URLs
- PR #7285: added some fixes to the documentation of the functions
- PR #6690: Tidying up and tweaking mplot3d examples [MEP12]

- PR #7273: Fix image watermark example where image was hidden by axes (#7265)
- PR #7276: FIX: don't compute flier positions if not showing
- PR #7267: DOC: changed documentation for axvspan to numpydoc format
- PR #7268: DOC Numpydoc documentation for def fill()
- PR #7272: Don't use `__builtins__` (an impl. detail) in pylab.
- PR #7241: Categorical support for NumPy string arrays.
- PR #7232: DOC improved subplots' docstring
- PR #7256: CI: skip failing test on appveyor
- PR #7255: CI: pin to qt4
- PR #7229: DOC: instructions on installing matplotlib for dev
- PR #7252: ENH: improve PySide2 loading
- PR #7245: TST: Always produce image comparison test result images
- PR #6677: Remove a copy in pcolormesh.
- PR #6814: Customize violin plot demo, see #6723
- PR #7067: DOC: OO interface in api and other examples
- PR #6790: BUG: fix C90 warning -> error in new tkagg code
- PR #7242: Add mplcursors to third-party packages.
- PR #7222: Catch IO errors when building font cache
- PR #7220: Fix innocent typo in comments
- PR #7192: DOC: switch pylab example `mri_with_eeg.py` to OO interface + cosmetick fixes
- PR #6583: Fix default parameters of FancyArrow
- PR #7195: remove check under linux for `~/.matplotlib`
- PR #6753: Don't warn when legend() finds no labels.
- PR #7178: Boxplot zorder kwarg
- PR #6327: Fix captions for plot directive in latex target
- PR #7188: Remove hard-coded streamplot zorder kwarg
- PR #7170: DOC updated hexbin documentation to numpydoc format.
- PR #7031: DOC Replaced documentation with numpydoc for semilogx
- PR #7029: [WIP] DOC Updated documentation of arrow function to numpy docs format.
- PR #7167: Less stringent normalization test for float128.
- PR #7169: Remove unused variable.
- PR #7066: DOC: switch to O-O interface in basic examples

- PR #7084: [DOC] Tick locators & formatters examples
- PR #7152: Showcase example: Bézier curves & SVG
- PR #7019: Check for fontproperties in figure.suptitle.
- PR #7145: Add style to api doc; fix capitalization.
- PR #7097: image_comparison decorator refactor
- PR #7096: DOC refer to plot in the scatter plot doc
- PR #7140: FIX added matplotlib.testing.nose.plugins to setupext.py
- PR #5112: OffsetImage: use dpi_cor in get_extent
- PR #7136: DOC: minor fix in development_workflow.rst
- PR #7137: DOC: improve engineering formatter example
- PR #7131: Fix branch name in “Deleting a branch on GitHub_” section
- PR #6521: Issue #6429 fix
- PR #7111: [DOC] Fix example following comments in issue #6865
- PR #7118: PR # 7038 rebased (DOC specgram() documentation now in numpy style)
- PR #7117: PR #7030 rebased
- PR #6618: Small improvements to legend’s docstring.
- PR #7102: Adding the artist data on mouse move event message
- PR #7110: [DOC] Apply comments from issue #7017
- PR #7087: [DOC] Example of user-defined linestyle (TikZ linestyle)
- PR #7108: Typos in ticker.py
- PR #7035: DOC Update semilogy docstring to numpy doc format
- PR #7033: DOC Updated plot_date to NumPy/SciPy style
- PR #7032: DOC: Updating docstring to numpy doc format for errorbar
- PR #7094: TST: Restore broken test_use14corefonts
- PR #6995: Turn off minor grids when interactively turning off major grids.
- PR #7072: [DOC] New figure for the gallery (showcase section)
- PR #7077: label_outer() should remove inner minor ticks too.
- PR #7037: DOC change axhspan to numpydoc format
- PR #7047: DOC - SpanSelector widget documentation
- PR #7049: Documentated dependencies to the doc and remove unnecessary dependencies.
- PR #7063: Tweak tol for test_hist_steplog to fix tests on appveyor
- PR #7055: FIX: testings.nose was not installed

- PR #7058: Minor animation fixes
- PR #7057: FIX: Removed financial demos that stalled because of yahoo requests
- PR #7052: Uncaught exns are fatal for PyQt5, so catch them.
- PR #7048: FIX: remove unused variable
- PR #7042: FIX: ticks filtered by Axis, not in Tick.draw
- PR #7026: Merge 2.x to master
- PR #6988: Text box widget, take over of PR5375
- PR #6957: DOC: clearing out some instances of using pylab in the docs
- PR #7012: Don't blacklist test_usetex using pytest
- PR #7011: TST: Fixed skip_if_command_unavailable decorator problem
- PR #6918: enable previously leftout test_usetex
- PR #7006: FIX: sphinx 1.4.0 details
- PR #6900: Enh: break website screenshot banner into 4 pieces and introduce a responsive layout
- PR #6997: FIX: slow plots of pandas objects (Second try)
- PR #6792: PGF Backend: Support interpolation='none'
- PR #6983: Catch invalid interactive switch to log scale.
- PR #6491: Don't warn in Collections.contains if picker is not numlike.
- PR #6978: Add link to O'Reilly video course covering matplotlib
- PR #6930: BUG: PcolorImage handles non-contiguous arrays, provides data readout
- PR #6889: support for updating axis ticks for categorical data
- PR #6974: Fixed wrong expression
- PR #6730: Add Py.test testing framework support
- PR #6904: Use edgecolor rather than linewidth to control edge display.
- PR #6919: Rework MaxNLocator, eliminating infinite loop; closes #6849
- PR #6955: Add parameter checks to DayLocator initiator
- PR #5161: Proposed change to default log scale tick formatting
- PR #6875: Add keymap (default: G) to toggle minor grid.
- PR #6920: Prepare for cross-framework test suite
- PR #6944: Restore cbook.report_memory, which was deleted in d063dee.
- PR #6961: remove extra "a"
- PR #6947: Changed error message. Issue #6933
- PR #6923: Make sure nose is only imported when needed

- PR #6851: Do not restrict coverage to `matplotlib` module only
- PR #6938: Image interpolation selector in Qt figure options.
- PR #6787: Python3.5 dictview support
- PR #6407: adding default toggled state for toggle tools
- PR #6898: Fix read mode when loading cached AFM fonts
- PR #6892: Don't force `anncoords` to `fig coords` upon dragging.
- PR #6895: Prevent forced alpha in figureoptions.
- PR #6877: Fix Path `deepcopy` signature
- PR #6822: Use travis native cache
- PR #6821: Break reference cycle `Line2D` <-> `Line2D._lineFunc`.
- PR #6879: Delete font cache in one of the configurations
- PR #6832: Fix for ylabel title in example `tex_unicode_demo.py`
- PR #6848: `test_tinypages`: pytest compatible module level setup
- PR #6881: add doi to bibtex entry for Hunter (2007)
- PR #6842: Clarify `Axes.hexbin extent` docstring
- PR #6861: Update ggplot URLs
- PR #6878: DOC: use `venv` instead of `virtualenv` on python 3
- PR #6837: Fix `Normalize(<signed integer array>)`.
- PR #6874: Update `bachelors_degree_by_gender` example.
- PR #6867: Mark `make_all_2d_testfuncs` as not a test
- PR #6854: Fix for PyQt5.7 support.
- PR #6862: Change default doc image format to png and pdf
- PR #6819: Add `mpl_toolkits` to `coveragerc`.
- PR #6840: Fixed broken `test_pickle.test_complete` test
- PR #6841: DOC: Switch to OO code style & ensure fixed y-range in `psd_demo3`
- PR #6843: DOC: Fix `psd_demo_complex` similarly to `psd_demo3`
- PR #6829: Tick label rotation via `set_tick_params`
- PR #6799: Allow creating annotation arrows w/ default props.
- PR #6262: Properly handle UTC conversion in `date2num`.
- PR #6777: Raise lock timeout as actual exception
- PR #6817: DOC: Fix a few typos and formulations
- PR #6826: Clarify doc for “norm” kwarg to `imshow`.

- PR #6807: Deprecate `{get, set}_cursorprops`.
- PR #6811: Add xkcd font as one of the options
- PR #6815: Rename tests in `test_mlab.py`
- PR #6808: Don't forget to disconnect callbacks for dragging.
- PR #6803: better freetype version checking
- PR #6778: Added contribute information to readme
- PR #6786: 2.0 Examples fixes. See #6762
- PR #6774: Appveyor: use newer conda packages and only run all tests on one platform
- PR #6779: Fix tutorial pyplot scales (issue #6775)
- PR #6768: Takeover #6535
- PR #6763: Invalidate test cache on gs/inkscape version
- PR #6765: Get more rcParams for 3d
- PR #6764: Support returning polylines from `to_polygons`
- PR #6760: DOC: clean up of `demo_annotation_box.py`
- PR #6735: Added missing side tick rcParams
- PR #6761: Fixed warnings catching and counting with `warnings.catch_warnings`
- PR #5349: Add a Gitter chat badge to README.rst
- PR #6755: PEP: fix minor formatting issues
- PR #6699: Warn if `MPLBACKEND` is invalid.
- PR #6754: Fixed error handling in `ImageComparisonTest.setup_class`
- PR #6734: register IPython's eventloop integration in `plt.install_repl_displayhook`
- PR #6745: DOC: typo in `broken_axis` pylab example
- PR #6747: Also output the actual error on svg backend tests using `subprocess`
- PR #6744: Add workaround for failures due to newer miktex
- PR #6741: Missing cleanup decorator in `test_subplots.test_exceptions`
- PR #6736: doc: fix unescaped backslash
- PR #6733: Merge v2.x to master
- PR #6729: Fix crash if byte-compiled level 2
- PR #6575: `setup.py`: Recommend installation command for pkgs
- PR #6645: Fix containment and subslice optim. for steps.
- PR #6619: Hide "inner" `{x,y}` labels in `label_outer` too.
- PR #6639: Simplify `get_legend_handler` method

- PR #6694: Improve Line2D and MarkerStyle instantiation
- PR #6692: Remove explicit children invalidation in update_position method
- PR #6703: DOC: explain behavior of notches beyond quartiles
- PR #6707: Call gc.collect after each test only if the user asks for it
- PR #6711: Added support for mgs to Ghostscript dependency checker
- PR #6700: Don't convert vmin, vmax to floats.
- PR #6714: fixed font_manager.is_opentype_cff_font()
- PR #6701: Colours like 'XeYYYY' don't get recognised properly if X, Y's are numbers
- PR #6512: Add computer modern font family
- PR #6383: Qt editor alpha
- PR #6381: Fix canonical name for "None" linestyle.
- PR #6689: Str Categorical Axis Support
- PR #6686: Merged _bool from axis into cbook._string_to_bool
- PR #6683: New entry in .mailmap
- PR #6520: Appveyor overhaul
- PR #6697: Fixed path caching bug in Path.unit_regular_star
- PR #6688: DOC: fix radial increase of size & OO style in polar_scatter_demo
- PR #6681: Fix #6680 (minor typo in IdentityTransform docstring)
- PR #6676: Fixed AppVeyor building script
- PR #6672: Fix example of streamplot start_points option
- PR #6601: BF: protect against locale in sphinext text
- PR #6662: adding from_list to custom cmap tutorial
- PR #6666: Guard against too-large figures
- PR #6659: Fix image alpha
- PR #6642: Fix rectangle selector release bug
- PR #6652: Minor doc updates.
- PR #6653: DOC: Incorrect rendering of dashes
- PR #6648: adding a new color and editing an existing color in fivethirtyeight.mplstyle
- PR #6548: Fix typo.
- PR #6628: fix the swab bug to compile on solaris system
- PR #6622: colors: ensure masked array data is an ndarray
- PR #6625: DOC: Found a typo.

- PR #6614: Fix docstring for PickEvent.
- PR #6554: Update mpl_toolkits.gtktools.
- PR #6564: Cleanup for drawstyles.
- PR #6577: Fix mlab.rec_join.
- PR #6596: Added a new example to create error boxes using a PatchCollection
- PR #2370: Implement draw_markers in the cairo backend.
- PR #6599: Drop conditional import of figureoptions.
- PR #6573: Some general cleanups
- PR #6568: Add OSX to travis tests
- PR #6600: Typo: markeredgewidth -> markeredgewidth
- PR #6526: ttconv: Also replace carriage return with spaces.
- PR #6530: Update make.py
- PR #6405: ToolManager/Tools adding methods to set figure after initialization
- PR #6553: Drop prettyplotlib from the list of toolkits.
- PR #6557: Merge 2.x to master
- PR #5626: New toolbar icons
- PR #6555: Fix docstrings for warn_deprecated.
- PR #6544: Fix typo in margins handling.
- PR #6014: Patch for issue #6009
- PR #6517: Fix conversion of string grays with alpha.
- PR #6522: DOC: made sure boxplot demos share y-axes
- PR #6529: TST Remove plt.show() from test_axes.test_dash_offset
- PR #6519: Fix FigureCanvasAgg.print_raw(...)
- PR #6481: Default boxplot style rebase
- PR #6504: Patch issue 6035 rebase
- PR #5593: ENH: errorbar color cycle clean up
- PR #6497: Line2D._path obeys drawstyle.
- PR #6487: Added docstring to scatter_with_legend.py [MEP12]
- PR #6485: Barchart demo example clean up [MEP 12]
- PR #6472: Install all dependencies from pypi
- PR #6482: Skip test broken with numpy 1.11
- PR #6475: Do not turn on interactive mode on in example script

- [PR #6442](#): loading TCL / Tk symbols dynamically
- [PR #6467](#): ENH: add unified seaborn style sheet
- [PR #6465](#): updated boxplot figure
- [PR #6462](#): CI: Use Miniconda already installed on AppVeyor.
- [PR #6456](#): FIX: unbreak master after 2.x merge
- [PR #6445](#): Offset text colored by labelcolor param
- [PR #6417](#): Showraise gtk gtk3
- [PR #6423](#): TST: splitlines in rec2txt test
- [PR #6427](#): Output pdf dicts in deterministic order
- [PR #6431](#): Merge from v2.x
- [PR #6433](#): Make the frameworkpython script compatible with Python 3
- [PR #6358](#): Stackplot weighted_wiggle zero-area fix
- [PR #6382](#): New color conversion machinery.
- [PR #6372](#): DOC: add whats_new for qt configuration editor.
- [PR #6415](#): removing unused DialogLineprops from gtk3
- [PR #6390](#): Use xkcd: prefix to avoid color name clashes.
- [PR #6397](#): key events handler return value to True to stop propagation
- [PR #6402](#): more explicit message for missing image
- [PR #5785](#): Better choice of offset-text.
- [PR #6302](#): FigureCanvasQT key auto repeat
- [PR #6334](#): ENH: webagg: Handle ioloop shutdown correctly
- [PR #5267](#): AutoMinorLocator and logarithmic axis
- [PR #6386](#): Minor improvements concerning #6353 and #6357
- [PR #6388](#): Remove wrongly committed test.txt
- [PR #6379](#): Install basemap from git trying to fix build issue with docs
- [PR #6369](#): Update demo_floating_axes.py with comments
- [PR #6377](#): Remove unused variable in GeoAxes class
- [PR #6373](#): Remove misspelled and unused variable in GeoAxes class
- [PR #6376](#): Update index.rst - add Windrose as third party tool
- [PR #6371](#): Set size of static figure to match widget on hidp displays
- [PR #6370](#): Restore webagg backend following the merge of widget nbagg backend
- [PR #6366](#): Sort default labels numerically in Qt editor.

- PR #6367: Remove stray nonascii char from nbagg
- PR #5754: IPython Widget
- PR #6146: ticker.LinearLocator view_limits algorithm improvement closes #6142
- PR #6287: ENH: add axisbelow option 'line', make it the default
- PR #6339: Fix #6335: Queue boxes to update
- PR #6347: Allow setting image clims in Qt options editor.
- PR #6354: Update events handling documentation to work with Python 3.
- PR #6356: Merge 2.x to master
- PR #6304: Updating animation file writer to allow keyword arguments when using with construct
- PR #6328: Add default scatter marker option to rcParams
- PR #6342: Remove shebang lines from all examples. [MEP12]
- PR #6337: Add a 'useMathText' param to method 'ticklabel_format'
- PR #6346: Avoid duplicate cmap in image options.
- PR #6253: MAINT: Updates to formatters in `matplotlib.ticker`
- PR #6291: Color cycle handling
- PR #6340: BLD: make minimum cycler version 0.10.0
- PR #6322: Typo fixes and wording modifications (minor)
- PR #6319: Add PyUpSet as extension
- PR #6314: Only render markers on a line when markersize > 0
- PR #6303: DOC Clean up on about half the Mplot3d examples
- PR #6311: Seaborn sheets
- PR #6300: Remake of #6286
- PR #6297: removed duplicate word in Choosing Colormaps documentation
- PR #6200: Tick vertical alignment
- PR #6203: Fix #5998: Support fallback font correctly
- PR #6198: Make hatch linewidth an rcParam
- PR #6275: Fix cycler validation
- PR #6283: Use `figure.stale` instead of internal member in `macosx`
- PR #6247: DOC: Clarify `fillbetween_x` example.
- PR #6251: ENH: Added a `PercentFormatter` class to `matplotlib.ticker`
- PR #6267: MNT: trap inappropriate use of color kwarg in scatter; closes #6266
- PR #6249: Adjust test tolerance to pass for me on OSX

- [PR #6263](#): TST: skip broken test
- [PR #6260](#): Bug fix and general touch ups for hist3d_demo example (#1702)
- [PR #6239](#): Clean warnings in examples
- [PR #6170](#): getter for ticks for colorbar
- [PR #6246](#): Merge v2.x into master
- [PR #6238](#): Fix sphinx 1.4.0 issues
- [PR #6241](#): Force Qt validator to use C locale.
- [PR #6234](#): Limit Sphinx to 1.3.6 for the time being
- [PR #6178](#): Use Agg for rendering in the Mac OSX backend
- [PR #6232](#): MNT: use stdlib tools in allow_rasterization
- [PR #6211](#): A method added to Colormap classes to reverse the colormap
- [PR #6205](#): Use io.BytesIO instead of io.StringIO in examples
- [PR #6229](#): Add a locator to AutoDateFormatters example code
- [PR #6222](#): ENH: Added file keyword to setp to redirect output
- [PR #6217](#): BUG: Made setp accept arbitrary iterables
- [PR #6154](#): Some small cleanups based on Quantified code
- [PR #4446](#): Label outer offset text
- [PR #6218](#): DOC: fix typo
- [PR #6202](#): Fix #6136: Don't hardcode default scatter size
- [PR #6195](#): Documentation bug #6180
- [PR #6194](#): Documentation bug fix: #5517
- [PR #6011](#): Fix issue #6003
- [PR #6179](#): Issue #6105: Adds targetfig parameter to the subplot2grid function
- [PR #6185](#): Fix to csv2rec bug for review
- [PR #6192](#): More precise choice of axes limits.
- [PR #6176](#): DOC: Updated docs for rc_context
- [PR #5617](#): Legend tuple handler improve
- [PR #6188](#): Merge 2x into master
- [PR #6158](#): Fix: pandas series of strings
- [PR #6156](#): Bug: Fixed regression of drawstyle=None
- [PR #5343](#): Boxplot stats w/ equal quartiles
- [PR #6132](#): Don't check if in range if the caller passed norm

- PR #6091: Fix for issue 5575 along with testing
- PR #6123: docstring added
- PR #6145: BUG: Allowing unknown drawstyles
- PR #6148: Fix: Pandas indexing Error in collections
- PR #6140: clarified color argument in scatter
- PR #6137: Fixed outdated link to thirdparty packages, and simplified the page
- PR #6095: Bring back the module level 'backend'
- PR #6124: Fix about dialog on Qt 5
- PR #6110: Fixes matplotlib/matplotlib#1235
- PR #6122: MNT: improve image array argument checking in to_rgba. Closes #2499.
- PR #6047: bug fix related #5479
- PR #6119: added comment on "usetex=False" to aide debugging when latex not ava...
- PR #6073: fixed bug 6028
- PR #6116: CI: try explicitly including msvc_runtime
- PR #6100: Update INSTALL
- PR #6099: Fix #6069. Handle image masks correctly
- PR #6079: Fixed Issue 4346
- PR #6102: Update installing_faq.rst
- PR #6101: Update INSTALL
- PR #6074: Fixes an error in the documentation, linestyle is dash_dot and should be dashdot
- PR #6068: Text class: changed __str__ method and added __repr__ method
- PR #6018: Added get_status() function to the CheckButtons widget
- PR #6013: Mnt cleanup pylab setup
- PR #5984: Suggestion for Rasterization to docs pgf-backend
- PR #5911: Fix #5895: Properly clip MOVETO commands
- PR #6039: DOC: added missing import to navigation_toolbar.rst
- PR #6036: BUG: fix ListedColormap._resample, hence plt.get_cmap; closes #6025
- PR #6029: TST: Always use / in URLs for visual results.
- PR #6022: Make @cleanup *really* support generative tests.
- PR #6024: Add Issue template with some guidelines
- PR #5718: Rewrite of image infrastructure
- PR #3973: WIP: BUG: Convert qualitative colormaps to ListedColormap

- [PR #6005](#): FIX: do not short-cut all white-space strings
- [PR #5727](#): Refresh pgf baseline images.
- [PR #5975](#): ENH: add kwarg normalization function to cbook
- [PR #5931](#): use `locale.getpreferredencoding()` to prevent OS X locale issues
- [PR #5972](#): add support for PySide2, #5971
- [PR #5625](#): DOC: add FAQ about `np.datetime64`
- [PR #5131](#): fix #4854: set default numpoints of legend entries to 1
- [PR #5926](#): Fix #5917. New dash patterns. Scale dashes by `lw`
- [PR #5976](#): Lock calls to latex in texmanager
- [PR #5628](#): Reset the available animation movie writer on `rcParam` change
- [PR #5951](#): tkagg: raise each new window; partially addresses #596
- [PR #5958](#): TST: add a test for tilde in tempfile for the PS backend
- [PR #5957](#): Win: add `mgs` as a name for ghostscript executable
- [PR #5928](#): fix for latex call on PS backend (Issue #5895)
- [PR #5954](#): Fix issues with getting `tempdir` when unknown uid
- [PR #5922](#): Fixes for Windows test failures on appveyor
- [PR #5953](#): Fix typos in `Axes.boxplot` and `Axes.bxp` docstrings
- [PR #5947](#): Fix #5944: Fix PNG writing from notebook backend
- [PR #5936](#): Merge 2x to master
- [PR #5629](#): WIP: more windows build and CI changes
- [PR #5914](#): Make barbs draw correctly (Fixes #5803)
- [PR #5906](#): Merge v2x to master
- [PR #5809](#): Support generative tests in `@cleanup`.
- [PR #5910](#): Fix reading/writing from `urllib.request` objects
- [PR #5882](#): `mathtext`: Fix comma behaviour at start of string
- [PR #5880: `mathtext`: Fix bugs in conversion of apostrophes to primes](#)
- [PR #5872](#): Fix issue with Sphinx 1.3.4
- [PR #5894](#): Boxplot concept figure update
- [PR #5870](#): Docs / examples fixes.
- [PR #5892](#): Fix `gridspec.Gridspec`: check ratios for consistency with rows and columns
- [PR #5901](#): Fixes incorrect ipython sourcecode
- [PR #5893](#): Show significant digits by default in `QLineEdit`.

- [PR #5881](#): Allow build children to run
- [PR #5886](#): Revert “Build the docs with python 3.4 which should fix the Traitlets...
- [PR #5877](#): DOC: added blurb about external mpl-proscale package
- [PR #5879](#): Build the docs with python 3.4 which should fix the Traitlets/IPython...
- [PR #5871](#): Fix sized delimiters for regular-sized mathtext (#5863)
- [PR #5852](#): FIX: create `_dashSeq` and `_dashOffset` before use
- [PR #5832](#): Rerwordings for normalizations docs.
- [PR #5849](#): Update `setupext.py` to solve issue #5846
- [PR #5853](#): Typo: fix some typos in `patches.FancyArrowPatch`
- [PR #5842](#): Allow image comparison outside tests module
- [PR #5845](#): V2.x merge to master
- [PR #5813](#): `mathtext`: no space after comma in brackets
- [PR #5828](#): FIX: overzealous clean up of imports
- [PR #5826](#): Strip spaces in properties doc after newline.
- [PR #5815](#): Properly minimize the rasterized layers
- [PR #5752](#): Reorganise `mpl_toolkits` documentation
- [PR #5788](#): Fix `ImportError`: No module named ‘StringIO’ on Python 3
- [PR #5797](#): Build docs on python3.5 with `linkcheck` running on python 2.7
- [PR #5778](#): Fix #5777. Don’t warn when applying default style
- [PR #4857](#): Toolbars keep history if axes change (`navtoolbar2` + `toolmanager`)
- [PR #5790](#): Fix `ImportError`: No module named ‘Tkinter’ on Python 3
- [PR #5789](#): `Index.html` template. Only insert snippet if found
- [PR #5783](#): MNT: remove reference to deleted example
- [PR #5780](#): Choose offset text from ticks, not axes limits.
- [PR #5776](#): Add `.noseids` to `.gitignore`.
- [PR #5466](#): Fixed issue with `rasterized` not working for errorbar
- [PR #5773](#): Fix `eb` rasterize
- [PR #5440](#): Fix #4855: Blacklist `rcParams` that aren’t style
- [PR #5764](#): BUG: make `clabel` obey `fontsize` kwarg
- [PR #5771](#): Remove no longer used Scikit image code
- [PR #5766](#): Deterministic LaTeX text in SVG images
- [PR #5762](#): Don’t fallback to old `ipython_console_highlighting`

- [PR #5728](#): Use custom RNG for sketch path
- [PR #5454](#): ENH: Create an abstract base class for movie writers.
- [PR #5600](#): Fix [#5572](#): Allow passing empty range to `broken_barh`
- [PR #4874](#): Document `mpl_toolkits.axes_grid1.anchored_artists`
- [PR #5746](#): Clarify that `easy_install` may be used to install all dependencies
- [PR #5739](#): Silence labeled data warning in tests
- [PR #5732](#): RF: fix annoying parens bug
- [PR #5735](#): Correct regex in filterwarnings
- [PR #5640](#): Warning message prior to `fc-list` command
- [PR #5686](#): Remove banner about updating styles in 2.0
- [PR #5676](#): Fix [#5646](#): bump the font manager version
- [PR #5719](#): Fix [#5693](#): Implemented `is_sorted` in C
- [PR #5721](#): Remove unused broken doc example `axes_zoom_effect`
- [PR #5664](#): Low-hanging performance improvements
- [PR #5709](#): Addresses issue [#5704](#). Makes usage of parameters clearer
- [PR #5716](#): Fix [#5715](#).
- [PR #5690](#): Fix [#5687](#): Don't pass unicode to `QApplication()`
- [PR #5707](#): Fix string format substitution key missing error
- [PR #5706](#): Fix `SyntaxError` on Python 3
- [PR #5700](#): BUG: handle colorbar ticks with boundaries and `NoNorm`; closes [#5673](#)
- [PR #5702](#): Add missing substitution value
- [PR #5701](#): `str.formatter` invalid
- [PR #5697](#): TST: add missing decorator
- [PR #5683](#): Include outward ticks in bounding box
- [PR #5688](#): Improved documentation for `FuncFormatter` formatter class
- [PR #5469](#): Image options
- [PR #5677](#): Fix [#5573](#): Use SVG in docs
- [PR #4864](#): Add documentation for `mpl_toolkits.axes_grid1.inset_locator`
- [PR #5434](#): Remove `setup.py` tests and adapt docs to use `tests.py`
- [PR #5586](#): Fix errorbar extension arrows
- [PR #5653](#): Update banner logo on main website
- [PR #5667](#): Nicer axes names in selector for figure options.

- [PR #5672](#): Fix #5670. No double endpoints in Path.to_polygon
- [PR #5553](#): qt: raise each new window
- [PR #5594](#): FIX: formatting in LogFormatterExponent
- [PR #5588](#): Adjust number of ticks based on length of axis
- [PR #5671](#): Deterministic svg
- [PR #5659](#): Change savefig.dpi and figure.dpi defaults
- [PR #5662](#): Bugfix for test_triage tool on Python 2
- [PR #5661](#): Fix #5660. No FileNotFoundError on Py2
- [PR #4921](#): Add a quit_all key to the default keymap
- [PR #5651](#): Shorter svg files
- [PR #5656](#): Fix #5495. Combine two tests to prevent race cond
- [PR #5383](#): Handle HiDPI displays in WebAgg/NbAgg backends
- [PR #5307](#): Lower test tolerance
- [PR #5631](#): WX/WXagg backend add code that zooms properly on a Mac with a Retina display
- [PR #5644](#): Fix typo in pyplot_scales.py
- [PR #5639](#): Test if a frame is not already being deleted before trying to Destroy.
- [PR #5583](#): Use data limits plus a little padding by default
- [PR #4702](#): sphinxext/plot_directive does not accept a caption
- [PR #5612](#): mathtext: Use DejaVu display symbols when available
- [PR #5374](#): MNT: Mailmap fixes and simplification
- [PR #5516](#): OSX virtualenv fixing by creating a simple alias
- [PR #5546](#): Fix #5524: Use large, but finite, values for contour extensions
- [PR #5621](#): Tst up coverage
- [PR #5620](#): FIX: quiver key pivot location
- [PR #5607](#): Clarify error when plot() args have bad shapes.
- [PR #5604](#): WIP: testing on windows and conda packages/ wheels for master
- [PR #5611](#): Update colormap user page
- [PR #5587](#): No explicit mathdefault in log formatter
- [PR #5591](#): fixed ordering of lightness plots and changed from getting lightness ...
- [PR #5605](#): Fix DeprecationWarning in stackplot.py
- [PR #5603](#): Draw markers around center of pixels
- [PR #5596](#): No edges on filled things by default

- [PR #5249](#): Keep references to modules required in pgf LatexManager destructor
- [PR #5589](#): return extension metadata
- [PR #5566](#): DOC: Fix typo in Axes.bxp.__doc__
- [PR #5570](#): use base64.encodestring on python2.7
- [PR #5578](#): Fix #5576: Handle CPLUS_INCLUDE_PATH
- [PR #5555](#): Use shorter float repr in figure options dialog.
- [PR #5552](#): Dep contourset vminmax
- [PR #5433](#): ENH: pass dash_offset through to gc for Line2D
- [PR #5342](#): Sort and uniquify style entries in figure options.
- [PR #5484](#): fix small typo in documentation about CheckButtons.
- [PR #5547](#): Fix #5545: Fix collection scale in data space
- [PR #5500](#): Fix #5475: Support tolerance when picking patches
- [PR #5501](#): Use facecolor instead of axisbg/axis_bgcolor
- [PR #5544](#): Revert “Fix #5524. Use finfo.max instead of np.inf”
- [PR #5146](#): Move impl. of plt.subplots to Figure.add_subplots.
- [PR #5534](#): Fix #5524. Use finfo.max instead of np.inf
- [PR #5521](#): Add test triage tool
- [PR #5537](#): Fix for broken matplotlib.test function
- [PR #5539](#): Fix docstring of violin{,plot} for return value.
- [PR #5515](#): Fix some theoretical problems with png reading
- [PR #5526](#): Add boxplot params to rctemplate
- [PR #5533](#): Fixes #5522, bug in custom scale example
- [PR #5514](#): adding str to force string in format
- [PR #5512](#): V2.0.x
- [PR #5465](#): Better test for isarray in figaspect(). Closes #5464.
- [PR #5503](#): Fix #4487: Take hist bins from rcParam
- [PR #5485](#): Contour levels must be increasing
- [PR #4678](#): TST: Enable coveralls/codecov code coverage
- [PR #5437](#): Make “classic” style have effect
- [PR #5458](#): Removed normalization of arrows in 3D quiver
- [PR #5480](#): make sure an autoreleasepool is in place
- [PR #5451](#): [Bug] masking of NaN Z values in pcolormesh

- PR #5453: Force frame rate of FFMpegFileWriter input
- PR #5452: Fix axes.set_prop_cycle to handle any generic iterable sequence.
- PR #5448: Fix #5444: do not access subsuper nucleus _metrics if not available
- PR #5439: Use DejaVu Sans as default fallback font
- PR #5204: Minor cleanup work on navigation, text, and customization files.
- PR #5432: Don't draw text when it's completely clipped away
- PR #5426: MNT: examples: Set the aspect ratio to "equal" in the double pendulum animation.
- PR #5214: Use DejaVu fonts as default for text and mathtext
- PR #5306: Use a specific version of Freetype for testing
- PR #5410: Remove uses of font.get_charmap
- PR #5407: DOC: correct indentation
- PR #4863: [mpl_toolkits] Allow "figure" kwarg for host functions in parasite_axes
- PR #5166: [BUG] Don't allow 1d-arrays in plot_surface.
- PR #5360: Add a new memleak script that does everything
- PR #5361: Fix #347: Faster text rendering in Agg
- PR #5373: Remove various Python 2.6 related workarounds
- PR #5398: Updating 2.0 schedule
- PR #5389: Faster image generation in WebAgg/NbAgg backends
- PR #4970: Fixed ZoomPanBase to work with log plots
- PR #5387: Fix #3314 assert mods.pop(0) fails
- PR #5385: Faster event delegation in WebAgg/NbAgg backends
- PR #5384: BUG: Make webagg work without IPython installed
- PR #5358: Fix #5337. Turn off --no-capture (-s) on nose
- PR #5379: DOC: Fix typo, broken link in references
- PR #5371: DOC: Add what's new entry for TransformedPatchPath.
- PR #5299: Faster character mapping
- PR #5356: Replace numpy funcs for scalars.
- PR #5359: Fix memory leaks found by memleak_hawaii3.py
- PR #5357: Fixed typo
- PR #4920: ENH: Add TransformedPatchPath for clipping.

Issues (1130):

- #8599: Pie Chart from CSV File

- #8586: update errorbar in Matplotlib 2.0.0
- #8463: wrong hatch color in legend
- #8558: Rendering really large image
- #8312: Matplotlib attempts to import PyQt4 when PyQt5 is not available
- #3528: PS backend is not tested
- #4389: Windows installer does not run -> restarts itself continually
- #8592: Qt4 backend (PySide) seemingly tries to use Qt5
- #8579: Python 2.7 travis build failing
- #8349: [feature request] Accepting `slice` arguments in `ax.set_xlim()` (Python 3)
- #4379: for the root example page, please provide more description
- #8571: `plt.subplots` return is inconsistent
- #8570: release 2.0.1 has qt4-incompatible code in `backend_qt5.py`
- #8569: Superimposed markers when `scatterpoints=1`
- #8565: Unexpected mixing of `qt4backend` and `qt5backend`
- #8563: `mpl2.0.1` seems to have broken `Qt4Agg`
- #8562: 'QPixmap' object has no attribute 'setDevicePixelRatio'
- #8560: Calling `close()` on a figure doesn't seem to close it
- #8174: Update list of dependencies to build docs
- #8557: Log scale on `pcolor` plot with only one tick
- #7412: Documentation guidelines improvements 2
- #8541: Generate a `tutorials` sphinx gallery
- #8223: need to backport docathon PRs
- #7793: Add `pillow` and `graphviz` to doc build dependencies
- #8501: Remove false deprecation warning
- #7206: All examples should be `MEP12/sphinx-gallery` compliant
- #6457: The first subplot is missized after `savefig` to a `png` file.
- #8521: Rectangle patch not transformed correctly in polar plot
- #8542: Inconsistent image size with `savefig(...,type='png')`
- #8445: Cannot display `np.array` with `dtype = np.float128`
- #8508: `%matplotlib` notebook show nothing, both 2d and 3d plot
- #7289: `ipython` loses `auto-show/auto-redraw` behavior after call to `plt.rcdefaults()`
- #6284: `ax.twinx().plot()` will reset the `x_limits` if only an `axvspan` was used on `ax`

- #8527: Confusing docstring in matplotlib.pyplot.bar() in version 2.0.0
- #8316: Matplotlib User Interface Example Breaks With More Than Three Patches
- #7835: Deprecate is_string_like
- #8524: Errorbar limits arrow heads point in wrong direction on inverted axis
- #8520: Documentation builds are failing due to sphinx-gallery changes
- #8514: Can't plot with empty markers
- #8516: .set_data() errors if number of points change
- #8517: Log-scale ignores Formatter
- #8506: text object clipping
- #6921: "Error: local variable 'xdata' referenced before assignment" in legend_handler.py
- #8505: plot window hangs and/or is generally unresponsive
- #8500: plot disappears when moved to second monitor
- #7523: Multi-line text instances differing in linespacing not rendered correctly
- #7725: is_string_like returns True for numpy object arrays
- #8057: markevery only accepts builtin integers, not numpy integers
- #8078: plt.subplots crashes when handed fig_kw argument
- #8038: Question on Path.contains_point/s
- #7688: Edit axis with multiple figures causes freeze with Qt5 on Windows
- #7754: Forgotten restore bounds?
- #5510: autoscale context manager
- #6649: UnboundLocalError in hist(x, bins, histtype='step', normed=1) on double entries in bins
- #6805: Axes.hist with no data in range raises UnboundLocalError
- #7512: ImportError: No module named Tkinter
- #6704: Spacing in math text is broken (AIX specific)
- #8050: Version 2.0.0_1 breaks OpenType font character spacing on PDF save
- #7924: Python 3.6 deprecated escape sequences.
- #8030: Unable to install matplotlib package using whl
- #8079: Inconsistency between " and ' in the code
- #8128: figure.Figure.autofmt_xdate applied to major xtick labels only
- #8168: From matplotlib.font_manager, ImportError: cannot import name get_font
- #8220: "search" doesn't find cmocean
- #8296: Remove idle_event from examples/event_handling/idle_and_timeout.py

- #8242: Investigate alternative svg renderers for the test suite
- #8424: does matplotlib install in virtual environment work ?
- #8460: matplotlib API docs missing container module
- #8467: initialise imshow with zero array has unexpected side effects
- #7460: Raise error if argument to xlim is invalid, e.g., nan
- #8465: zorder values as a sequence are not respected by LineCollection
- #8457: Allow to change base of LogNorm?
- #8406: FancyArrow, error in the polygon coordinates for shape 'full'
- #8431: Hatches filling an empty color contour not saved in pdf
- #7989: 300% CPU on Raspberry Pi
- #537: Orthogonal projection for mplot3d
- #8443: No version when building from github archive
- #8444: Matplotlib hangs with runtime error
- #8441: ImportError: No module named _backend_gdk
- #8302: Invalid certificate at <https://matplotlib.org>.
- #8432: asd
- #8153: Long lines in literal blocks run off the edge of the page
- #8160: Using plt.ion with startup commands
- #8428: Documentation: matplotlibrc example file confuses x and yticks.
- #8425: MaxNLocator prune isn't working with decimals
- #8421: Consistent deprecation of the hold kwarg of hlines and vlines
- #8427: Matplotlib cannot find default matplotlib fonts on Scientific linux
- #7903: Regression: imshow on geo axes produces an empty plot in matplotlib 2.0.0
- #8419: Incorrect display of minor ticks in Log Scale plot with large font size
- #8418: Matplotlib defaults to and bundles vera fonts that do not contain Greek letters
- #8073: Please add Vega in perception documentation
- #8272: Convert docstring of Axes.pie() into numpydoc
- #8416: Python 3.4 image comparison test failure for mathtext_cm_52-expected.png
- #8402: plotting with TkAgg backend becomes unresponsive after a certain qt5agg backend import command
- #8412: Data points not rendered for figures saved in vector formats
- #8397: pyplot.subplots did not return the type of object specified in the documentation

- #8409: loading pickled figure gives: AttributeError: 'CallbackRegistry' object has no attribute 'callbacks'
- #8111: Issue with sub-setting minor-ticks at intermediate number of decades
- #8401: weird bug when using custom formatter; tick labels overlapping
- #8398: restore rebase documentation
- #7227: Path effects for text outline is missing corners
- #3517: Issue with non-ascii paths in font look up
- #8208: make.py should not use `os.system("sphinx-build ...")`
- #8386: setting log major ticks leaves interfering minor tick labels
- #8370: Simpler code for common plot setting (e.g. legend, label, title, figsize)?
- #8385: Make checkbox rectangles in CheckButtons widget have an edge outline
- #7785: Passing a transposed array to `patch.set_offsets()`
- #8378: `ColorbarBase()` is dpi dependent
- #8342: Make `ArrowStyle` docstrings numpydoc compatible
- #7683: Please add `<shade = True>` parameter to `bar3d`
- #8337: axes `set_position` ignored if using `tight_layout`
- #8260: `test_backend_ps.py` leaves temporary files in `/tmp`
- #8355: Artifact at border with `tricontourf` and `float32` positions
- #8330: PyPy compatibility - `__builtin__` is not iterable
- #8017: Font family is not set on log-scaled tick labels
- #8317: Fonts not changed in LaTeX mode (since version 2.0.0)
- #7293: Isolated points missing in pdf
- #8348: `style.use` not working for some cases
- #7655: Event picking does not seem to work on polar bar plots
- #3540: Pick events broken in log axes
- #8124: Actually deprecate `Axes.axesPatch`, `Figure.figurePatch`
- #8290: six environment polluted when misuse of `matplotlib` import
- #8230: cache local freetype source
- #8332: Importing Issue: "No module named externals"
- #8327: Inconsistency between documentation and actual effect of the `bar` plot function
- #8197: Matplotlib 2.0.0 crashes on plotting contour of array with two dimensions of size 1 in Python 3.4
- #8054: `is_scalar_or_string` deprecated too early

- #8284: Markers have compression artifacts
- #8294: x marker is too big
- #8288: che
- #7951: matplotlib 2.0.0 not using matplotlibrc file in IPython
- #8012: imshow interpolation uses masked values
- #8117: Trying to plot only error bars (with no line connecting data points) results in empty plot
- #7953: Cannot import _tkagg on windows 64 bits on 2.7
- #8225: tight_layout does not work with set_visible(False)
- #8145: Warning treated as error while generating docs
- #2304: Add an argument rotate_labels to pie chart
- #8046: Arc patch with starting and ending angle
- #8263: error saving pcolormesh with shading=gouraud to eps
- #8034: necked_tensile_specimen.png contains non-free color calibration profile
- #8231: gitter badge at top of README.rst is broken
- #8141: breaking change in dash verification in 2.0.0
- #8207: Add early check for “dot” binary (graphviz) when building docs
- #8194: Sample data not found
- #8186: Put back gitter plain text link on README.rst
- #8198: ticklabel font changes when using logscale
- #7616: make ‘dpi’ optional for animation.MovieWriter.setup
- #8192: %matplotlib inline doesn’t work well with ipywidgets 6.0 interact
- #8189: pip install matpoblib broken
- #8177: Add badges to README.rst
- #8180: icu version problem with matplotlib 2
- #8169: Autowrapping text doesn’t work in “What’s New in Matplotlib 1.5” example
- #8164: Remove yield tests (now deprecated in pytest)
- #8159: Doc: Restructure environment variables in Installing from source docs
- #8123: Regenerate gitwash docs for improved syntax highlighting of non-python code sections
- #8147: Use Agg backend by default if DISPLAY is not set
- #8146: How to display D-stroke symbol in matplotlib
- #7905: ytick locations different for 1.5.3 and 2.0.0
- #8121: PNG output with PGF backend fails with pdftocairo exit code 99

- #8136: If division by zero, python cannot convert float infinity to integer in `get_tick_space()`
- #8067: Coordinates of text not properly set in pgf files
- #8112: Deprecate `assert_str_equal`
- #8122: keyword `labelrotation` is not recognized
- #5151: Horizontal lines in colorbars in PDF
- #4984: errorbar incorrectly accepts and plots Nx2 shaped yerr
- #6593: Feature request: filled error bar
- #7992: Hatching doesn't respect alpha
- #7991: Dotted grid lines in matplotlib v2.0.0 appear dashed
- #8015: Document new testing procedure
- #8106: Error in demo scripts: `to_rgba`: Invalid rgba arg "2" in `style_sheets_reference.py`
- #8105: calling `plt.hist()` with `np.nan` value raises confusing error message
- #5320: Some searches in documentation result in no results
- #6042: return `_text` property as `__repr__` for Text class
- #7171: `axes.boxplot` does not have `zorder` kwarg
- #8098: `matplotlibrc` doesn't work
- #8091: Bug with `plt.hist` when `min==max` and values are `>= 2**53`
- #8087: `zorder` is not respected by all parts of errorbar #1622 problem in matplotlib 2.0.0
- #7877: add link to scipython book
- #8053: save animation to mp4 fail
- #8076: Matplotlib hatch color broken
- #8077: ImportError: No module named 'matplotlib.rcsetup'
- #7686: 'Extend' keyword produces colorbar of zero width
- #7886: empty `imshow` crashes python
- #7901: Allow multiple hatch colors in same figure
- #6708: `KnownFailure` becomes an error with `--processes=1` flag
- #7899: Behaviour of `c=None` is inconsistent in 2.0
- #8058: Updating matplotlib to 2.0.0 causing problems when plotting: error/warning message "failed to get the current screen resources"
- #8051: includes not-really-free BaKoMa fonts
- #8049: Matplotlib 3D projection axis cannot be created because of missing `rcParam[u'_internal.classic_mode']`
- #6285: `plt.subplots()` does not remove existing subplots when called on existing figure

- #8023: numpy array not accepted for log scaled minor ticks
- #7967: Catch or stop specgram warnings during tests
- #7813: Qt5Agg backend not rendering nicely on Windows HiDPI display
- #6891: Greek letter display error [1.5.1]
- #6393: Pair of floats breaks plotting renderer (weirdest bug I've ever seen)
- #8027: Log Scale Ticklabels Refuse to Die (Data Dependent)
- #5859: savefig() as PNG get a different result than the image shown in ipython notebook(SVG probably)
- #5210: Unexpected replacement of right) with exclamation point in MathTextParser output
- #6902: Include test files in coverage report
- #7756: Cannot install the matplotlib 1.5.3 or 2.0.0rc2 on Mac OS Sierra, Python 3.6.0
- #5325: Migrate to py.test
- #8016: Unexpected HOME behavior after axis change
- #8009: Need Python 3.6 wheels for matplotlib 1.5.1 on PyPI
- #8005: Hex colours with alpha
- #7807: ValueError when specifying marker vertices
- #7937: Large TrueType font does not render correctly when saving in .pdf
- #7615: Subscript/superscript sequence is too long with \$left. X right|\$
- #5287: Warnings in doc build
- #6860: The original xlim changed by twinx
- #6064: specgram(x) should warn if x.size < 256
- #7964: BUG: AxesImage.set_data([[[]]]) causes FloatingPointException
- #7963: savefig PDF removing the negative sign from yticklabels
- #7955: Failed install with "OSError: [Errno 12] Cannot allocate memory"
- #7958: Matplotlib 2.0 cannot find PyQt5 (Windows)
- #7943: ValueError when plotting Pandas Dataframe Summary
- #7940: saving a square image constrained to the extent of axis without any border doesn't work
- #7636: WX mouseevent assertion errors
- #7902: Saving an unpickled figure.
- #6048: AttributeError (no attribute 'callbacks') when setting attributes on pickle-loaded PatchCollection
- #7930: KeyboardInterrupt while Matplotlib is displaying >= 2 figures causes X server crash
- #7874: wheels not picking correct default backend

- #7906: font_manager.get_fontconfig_fonts() reports a single item of all fonts concatenated
- #7922: FT2Font do not close open file, leads to delayed ResourceWarning
- #7803: tripcolor documentation rendering error .
- #7891: pyplot.bar does not cycle through colors (>2.0.0b1)
- #7912: matplotlib doesn't work with numpy+mkl
- #7921: Text rendered with MathText looks really ugly (version 2.0 vs. 1.5)
- #7919: ~/.matplotlib/matplotlibrc not being read
- #7909: Unit length quiver arrow not drawn with a unit length
- #7852: _rrule maximum recursion depth exceeded on multiprocessing usage
- #7501: Segmentation fault in QuadMeshGenerator on ppc64
- #7879: UTF-8 error on import of matplotlib 1.5.1
- #7601: color_cycle deprecation warning could provide more context to user
- #7875: qt shims: QFontMetrics missing on PyQt5
- #7860: widget radio buttons and check buttons no longer display outlines
- #7870: DOC: FAQ out-of-date
- #7510: better input validation on fill_between
- #7867: pyplot import error when current directory contains a file named sip.py
- #7248: Adding names to the color in the new (Vega) default color cycle
- #6207: axes_grid1.zoomed_inset_axes does not accept location as string
- #7775: Locator tick_values for images
- #7810: Dimensions sanity check in axes_rgb swaps x and y of shape when checking, prevents use with non-square images.
- #7704: screenshots in the front page of devdocs are ugly
- #7746: imshow should silence warnings on invalid values, at least when masked
- #7661: document that imshow now respects scale
- #6820: nonsensical error message for invalid input to plt.bar
- #7814: Legend for lines created using LineCollection show different handle line scale.
- #7816: re-enable or delete xmllint tests
- #7802: plt.stackplot not working for integer input with non-default 'baseline' parameters
- #6149: travis dedup
- #7822: Weird stroke join with patheffects
- #7784: Simple IndexError in artist.setp if empty list is passed

- #3354: Unnecessary argument in GraphicsContextBase get_linestyle
- #7820: Figure.savefig() not respecting bbox_inches='tight' when dpi specified
- #7715: Can't import pyplot in matplotlib 2.0 rc2
- #7745: Wheel distributables include unnecessary files
- #7812: On MacOS Sierra with IPython, inconsistent results with %gui, %matplotlib magic commands and -gui, and -matplotlib command-line options for ipython and qtconsole; complete failure of qtconsole inline figures
- #7808: Basemap uses deprecated methods
- #7487: Funny things happen when a rectangle with negative width/height is passed to axes()
- #7649: -nose-verbose isn't a correct option for nose
- #7656: imsave ignores origin option
- #7792: test_png.test_pngsuite.test fails on ppc64 (big-endian)
- #7788: Colorbars contain no colors when created on ppc64 (big-endian)
- #4285: plt.yscale("log") gives FloatingPointError: underflow encountered in multiply
- #7724: Can't import Matplotlib.widgets.TextBox
- #7798: test_psd_csd_equal fails for 12 (but not all) of the test_mlab.spectral_testcases on ppc64 (big-endian)
- #7778: Different font size between math mode and regular text
- #7777: mpl_toolkits.basemap: ValueError: level must be >= 0
- #4353: different behaviour of zoom while using ginput with MouseEvent vs KeyEvent
- #4380: horizontalalignment 'left' and 'right' do not handle spacing consistently
- #7393: subplot(): incorrect description of deletion of overlapping axes in the docs
- #7759: matplotlib dynamic plotting
- #2025: TkAgg build seems to favor Framework Tcl/Tk on OS-X
- #3991: SIGINT is ignored by MacOSX backend
- #2722: limited number of grid lines in matplotlib?
- #3983: Issue when trying to plot points with transform that requires more/fewer coordinates than it returns
- #7734: inconsistent doc regarding keymap.fullscreen default value
- #7761: Deprecation warning for finance is very unclear
- #7223: matplotlib.rcsetup docs
- #3917: OS X Cursor Not working on command line
- #4038: Hist Plot Normalization should allow a 'Per Bin' Normalization

- #3486: Update Selection Widgets
- #7457: Improvements to `pylab_examples/stock_demo.py`
- #7755: Can't open figure
- #7299: Raise an error or a warning when `ylim`'s `min == 0` and `yscale == "log"`
- #4977: Improve resolution of canvas on HiDPI with PyQt5 backend
- #7495: Missing `facecolor2d` attribute
- #3727: `plot_date()` does not work with x values of type `pandas.Timestamp` (pandas version 0.15.0)?
- #3368: Variable number of ticks with `LogLocator` for a fixed number of tick labels displayed
- #1835: docstrings of cross-correlation functions (`acorr` and `xcorr`) need clarification
- #6972: `quiverkey` problem when `angles=array`
- #6617: Problem of fonts with LaTeX rendering due to `fonts-lyx` package
- #7717: make all deprecation warnings be `mplDeprecation` instances
- #7662: `eventplot` legend fails (`linewidth`)
- #7673: Baseline image reuse breaks parallel testing
- #7666: Default scaling of x-axis in `specgram()` is incorrect (i.e. the default value for the `xextent` parameter)
- #7709: Running into problems in `seaborn` after upgrading `matplotlib`
- #7684: 3-D scatter plot disappears when overlaid over a 3-D surface plot.
- #7630: Unicode issue in `matplotlib.dates`
- #7678: add link to `bokeh/colorcet`
- #2078: linespacing of multiline texts.
- #6727: `scipy` 2016 sprint ideas
- #3212: Why are `numpoints` and `scatterpoints` two different keywords?
- #7697: Update `INSTALL` file to include `py3.6`
- #4428: Hyphen as a subscript doesn't appear at certain font sizes
- #2886: The wrong Game symbol is used
- #7603: `scatter color` vs `c`
- #7660: 2.0rc2: title too close to frame?
- #7672: standardize `classic/v2.x` order in docs
- #7680: `OverflowError`: Python int too large to convert to C long during plotting simple numbers on debian testing
- #7664: BUG: `super` requires at least 1 argument
- #7669: rc on conda-forge

- #5363: Warnings from `test_contour.test_corner_mask`
- #7663: BUG: Can't import `matplotlib._backports`
- #7647: Decorator for deprecation ignores arguments other than 'message'
- #5806: FutureWarning with Numpy 1.10
- #6480: Setting `markeredgecolor` raises a warning
- #7653: legend doesn't show all markers
- #7643: Matplotlib 2.0 deprecations
- #7642: `imshow` seems to "shift" grid.
- #7633: All attempts to plot fail with "OverflowError: Python int too large to convert to C long"
- #7637: Stacked 2D plots with interconnections in Matplotlib
- #7353: auto legend position changes upon saving the figure
- #7626: Saturation mask for `imshow()`
- #7623: potential bug with `plt.arrow` and `plt.annotate` when setting `linestyle` via tuples
- #7005: `rcParams['font.size']` is consulted at render time
- #7587: BUG: shared log axes lose `_minpos` and revert to default
- #7493: Plotting zero values with logarithmic axes triggers `OverflowError`, Matplotlib hangs permanently
- #7595: math domain error using `symlog` norm
- #7588: 2.0.0rc1 cannot import name `'_macosx'`
- #2051: Consider making default `verticalalignment` `baseline`
- #4867: Add additional minor labels in log axis with a span less than two decades
- #7489: Too small axis arrow when `savefig` to png
- #7611: `UnicodeDecodeError` when using `matplotlib` save SVG file and open it again
- #7592: font cache: a possibility to disable building it
- #5836: Repeated warning about `fc-list`
- #7609: The best channel to ask questions related to using `matplotlib`
- #7141: Feature request: auto locate minor ticks on log scaled color bar
- #3489: `matplotlib` scatter shifts color codes when NaN is present
- #4414: Specifying `histtype='stepfilled'` and `normed=True` when using `plt.hist` causes `ymin` to be set incorrectly
- #7597: python complain about "This application failed to start because it could not find or load the Qt platform plugin 'xcb' " after an update of `matplotlib`
- #7578: Validate steps input to `MaxNLocator`

- #7590: Subtick labels are not disabled in classic style
- #6317: PDF file generation is not deterministic - results in different outputs on the same input
- #6543: Why does fill_betweenx not have interpolate?
- #7437: Broken path to example with strptime2num
- #7593: Issue: Applying Axis Limits
- #7591: Number of subplots in mpl.axes.Subplot object
- #7056: setup.py --name and friends broken
- #7044: location of convert in rparams on windows
- #6813: avoid hiding edge pixels of images
- #7579: OS X libpng incompatibility
- #7576: v2.0.0rc1 conda-forge dependency issue
- #7558: Colorbar becomes 0 to 1 after colorbar ax.yaxis.set_major_formatter
- #7526: Cannot Disable TkAgg Backend
- #6565: Questionable margin-cancellation logic
- #7175: new margin system doesn't handle negative values in bars
- #5201: issue with colorbar using LogNorm and extend='min'
- #6580: Ensure install requirements in documentation are up to date before release
- #5654: Update static images in docs to reflect new style
- #7553: fringe returns a last value greater than limit
- #5961: track bdist_wheel release and remove the workaround when 0.27 is released
- #7554: TeX formula rendering broken
- #6885: Check if ~/.matplotlib/ is a symlink to ~/.config/matplotlib/
- #7202: Colorbar with SymmetricalLogLocator : issue when handling only negative values
- #7542: Plotting masked array lose data points
- #6678: dead links in docs
- #7534: nbagg doesn't change figure's facecolor
- #7535: Set return of type Axes in Numpydoc docstring return type hint for Figure.add_subplot and Figure.add_axes to help jedi introspection
- #7443: pdf doc build is sort of broken
- #7521: Figure.show() fails with Qt5Agg on Windows (plt.show() works)
- #7423: Latex cache error when building docs
- #7519: plt.table() without any kwargs throws exception

- #3070: remove hold logic from library
- #1910: Pylab contourf plot using Mollweide projection create artefacts
- #5350: Minor Bug on table.py
- #7518: Incorrect transData in a simple plot
- #6985: Animation of contourf becomes extremely slow
- #7508: Legend not displayed
- #7484: Remove numpy 1.6 specific work-arounds
- #6746: Matplotlib.pyplot 2.0.0b2 fails to import with Conda Python 3.5 on OS X
- #7505: Default color cycler for plots should have more than 8 colors
- #7185: Hexbin default edgecolors kwarg is misnamed
- #7478: 'alpha' kwarg overrides facecolor='none' when plotting circle
- #7375: Patch edgecolor of a legend item does not follow look of figure
- #6873: examples/api/skewt.py is not displaying the right part of the grid by default
- #6773: Shifted image extents in 2.0.0.b3
- #7350: Colors drawn outside axis for hist2d
- #7485: Is there a way to subclass the zoom() function from the NavigationToolbar backends and modify its mouse button definition?
- #7396: Bump numpy minimal version to 1.7.0?
- #7466: missing trigger for autoscale
- #7477: v2.0.0b4 fails to build with python-3.5: Requires pygtk
- #7113: Problems with anatomy figure on v2.x
- #6722: Text: rotation inconsistency
- #7244: Codecov instead of coveralls?
- #5076: RuntimeError: LaTeX was not able to process the following string: 'z= $\mathregular{\{\}^{\{\}_\{\}}}$ ' in matplotlib
- #7450: Using Matplotlib in Abaqus
- #7314: Better error message in scatter plot when len(x) != len(c)
- #7432: Failure to re-render after Line2D.set_color
- #6695: support markdown or similar
- #6228: Rasterizing patch changes filling of hatches in pdf backend
- #3023: contourf hatching and saving to pdf
- #4108: Hatch pattern changes with dpi
- #6968: autoscale differences between 1.5.1 and 2.0.0b3

- #7452: `test_log_margins` test failure
- #7143: spurious warning with nans in log-scale plot
- #7448: Relative lengths in 3d quiver plots
- #7426: `prop_cycler` validation over-zealous
- #6899: `savefig` has sideeffects
- #7440: Confusing examples in `annotation_demo2`
- #7441: Loading a matplotlib figure pickle within a tkinter GUI
- #6643: Incorrect margins in log scale
- #7356: `plt.hist` does not obey the `hist.bins` rparams
- #6845: SVG backend: anomaly in gallery scatter legend
- #6527: Documentation issues
- #7315: Spectral vs spectral Deprecation warning
- #7428: from `matplotlib.backends import _tkagg` raises `AttributeError: 'module' object has no attribute '__file__'`
- #7431: `%matplotlib notebook` offsetting `sns.palplot`
- #7361: add multi-process flag as `-j` to `test.py`
- #7406: NaN causes `plt.vlines` to not scale y limits
- #7104: set offset threshold to 4
- #7404: obnoxious double warning at each script startup
- #7373: Regression in `imshow`
- #7166: Hatching in legends is broken
- #6939: `wspace` is not “The amount of width reserved for blank space between subplots” as documented
- #4026: control hatch linewidth and fill border linewidth separately
- #7390: MAINT move the examples from `doc/pyplots` to `examples` and make them reproducible
- #7198: style blacklist includes `hardcopy.docstring` but it should be `docstring.hardcopy`
- #7391: How to apply `ax.margins` to current axes limits?
- #7234: Improving documentation: Tests failing on a osx setup
- #7379: Mp4's generated by movie writer do not appear work in browser
- #6870: Figure is unpicklable after `savefig`
- #6181: When using Agg driver, pickling fails with `TypeError` after writing figure to PDF
- #6926: SVG backend closes `BytesIO` on print if were `usetex=True` and `cleanup` decorator used
- #3899: Pickle not working in interactive ipython session

- #7251: Improve violin plot demo
- #7146: symlog scale no longer shows labels on the negative side
- #3420: simple plotting of numpy 2d-arrays
- #7287: Make matplotlib.use() report where the backend was set first, in case of conflict
- #7305: RuntimeError In FT2Font with NISC18030.ttf
- #7351: Interactive mode seems to be broken on MacOSX
- #7313: Axes3D.plot_surface with meshgrid args stopped working
- #7281: rcparam encoding test is broken
- #7345: Annotation minor issue in the example linestyles.py
- #7210: variable frame size support in animation is a misfeature
- #5222: legend-plot handle association
- #7312: get_facecolors() reports incorrect colors
- #7332: plot range
- #1719: Can't pickle bar plots: Failed to pickle attribute "gridline"
- #6348: When I run a file that uses matplotlib animation, I keep getting this error. Using OS X, Python 2.7, installed Python from python.org then used homebrew. Matplotlib install from pip.
- #5386: Error loading fonts on OSX 10.11
- #6448: hist step UnboundLocalError
- #6958: Document the verts kwarg to scatter
- #7204: Integrate sphinx-gallery to our user documentation
- #7325: Anaconda broken after trying to install matplotlib 2.0 beta (ubuntu)
- #7218: v1.5.3: marker=None no longer works in plot()
- #7271: BUG: symmetric kwarg in locator is not honored by contourf
- #7095: _preprocess_data interferes in the docstrings Notes section
- #7283: DOC: Misrendered URLs in the development_workflow section of devdocs.
- #7109: backport #7108 to v2.x
- #7265: Image watermark hidden by Axes in example
- #7263: axes.bxp fails without fliers
- #7274: Latex greek letters in axis labels
- #7186: matplotlib 1.5.3 raise TypeError: 'module' object is not subscriptable on pylab.py
- #6865: custom_projection_example.py is completely out of date
- #7224: FancyArrowPatch linestyle always solid

- #7215: BUG: bar deals with bytes and string x data in different manners, both that are unexpected
- #7270: Pylab import
- #7230: subplots docstring: no example of NxN grid
- #7269: documentation: texinfo markup error in matplotlib 1.4.3 and matplotlib 1.5.3
- #7264: matplotlib dependency cycle matplotlib <- ipython <- matplotlib - how to resolve?
- #7261: Legend not displayed in Plot-Matplot lib
- #7260: Unknown exception in resize
- #7259: autoscaling of yaxis fails
- #7257: How can plot a figure with matplotlib like this?
- #3959: setting up matplotlib for development
- #7240: New tests without baseline images never produce a result
- #7156: Inverted imshow using Cairo backend
- #6723: How to customize violinplots?
- #5423: fill_between wrong edge line color
- #5999: Math accents are not correctly aligned
- #1039: Cairo backend marker/line style
- #7174: default value of lines.dash_capstyle
- #7246: Inconsistent behaviour of subplots for one and more-than-one axes
- #7228: axes tick_params label color not respected when showing scientific notation for axes scale
- #7225: get_geometry() wrong if subplots are nested (e.g., subplots with colorbars)
- #7221: Why does pyplot display wrong grayscale image?
- #7191: BUG: Animation bugs fixed in master should be backported to 2.x
- #7017: Doc typos in “Our favorite recipes”
- #3343: Issues with imshow and RGBA values
- #7157: should fill_between Cycle?
- #7159: test_colors.test_Normalize fails in 2.0.0b4 on Fedora rawhide/aarch64 (ARMv8)
- #7201: RGBA values produce different result for imshow and for markers
- #3232: Navigation API Needed
- #7001: Default log ticker can make too many ticks
- #806: Provide an option for the Animation class to retain the previously rendered frames
- #6135: matplotlib.animate writes png frames in cwd instead of temp files
- #7189: graph not showing when I set format to line

- #7080: Difference in symbol sizes using `MathText` with `stixsans`
- #7162: `_axes.py` `linestyle_map` unused
- #7163: `pyplot.subplots()` is slow
- #7161: `matplotlib.ticker.FormatStrFormatter` clashes with `ax2.set_yticklabels` when dual y-axis is used
- #6549: Log scale tick labels are overlapping
- #7154: bar graph with nan values leads to “No current point in closepath” in `evince`
- #7149: unable to save `.eps` plot
- #7090: fix building pdf docs
- #6996: `FontProperties` size and weight ignored by `figure.suptitle`
- #7139: `float128s` everywhere for dates?
- #7083: DOC: Clarify the relationship between `plot` and `scatter`
- #7125: Import Error on `matplotlib.pyplot: PyQt4`
- #7124: Updated `matplotlib 1.5.3` broken in default Anaconda channel
- #6429: Segfault when calling `show()` after using `Popen` (test code inside)
- #7114: BUG: `ax.tick_params` change in tick length does not adjust tick labels
- #7120: Polar plot `cos(2x)`
- #7081: enh: additional colorblind-friendly colormaps
- #7103: Problem with discrete `ListedColormaps` when more than 4 colors are present
- #7115: Using `matplotlib` without `Tkinter`
- #7106: Wrong reader in `mathext.py`
- #7078: `imshow()` does not interpret aspect/extent when `interpolation='none'` in `svg` output
- #6616: Keyboard shortcuts for toggling minor ticks grid and opening `figureoptions` window
- #7105: Can't pickle <type 'instancemethod'>
- #7086: DOC (released) style is badly broken on the user doc.
- #7065: backport #7049
- #7091: `v2.0.0b4` breaks `viscm`
- #7043: BUG: `LogLocator.set_params` is broken
- #7070: `autoscale` does not work for axes added by `fig.add_axes()`
- #3645: Proposal: Add `rc` setting to control dash spacing
- #7009: No good way to disable `SpanSelector`
- #7040: It is getting increasingly difficult to build the `matplotlib` documentation

- #6964: Docstring for ArtistAnimation is incorrect
- #6965: ArtistAnimation cannot animate Figure-only artists
- #7062: remove the contour on a Basemap object
- #7061: remove the contour on Basemap
- #7054: Whether the new version 2.0 will support high-definition screen?
- #7053: When will release 2.0 official version?
- #6797: Undefined Symbol Error On Ubuntu
- #6523: matplotlib-2.0.0b1 test errors on Windows
- #4753: rubber band in qt5agg slow
- #6959: extra box on histogram plot with a single value
- #6816: Segmentation fault on Qt5Agg when using the wrong linestyle
- #4212: Hist showing wrong first bin
- #4602: bar / hist : gap between first bar and other bars with lw=0.0
- #6641: Edge ticks sometimes disappear
- #7041: Python 3.5.2 crashes when launching matplotlib 1.5.1
- #7028: Latex Greek fonts not working in legend
- #6998: dash pattern scaling with linewidth should get it's own rcParam
- #7021: How to prevent matplotlib from importing qt4 libraries when only
- #7020: Using tick_right() removes any styling applied to tick labels.
- #7018: Website Down
- #6785: Callbacks of draggable artists should check that they have not been removed
- #6783: Draggable annotations specified in offset coordinates switch to figure coordinates after dragging
- #7015: pcolor() not using "data" keyword argument
- #7014: matplotlib works well in ipython note book but can't display in a terminal running
- #6999: cycycler 0.10 is required due to change_key() usage
- #6794: Incorrect text clipping in presence of multiple subplots
- #7004: Zooming with a large range in y-values while using the linestyle "-" is very slow
- #6828: Spikes in small wedges of a pie chart
- #6940: large memory leak in new contour routine
- #6894: bar(..., linewidth=None) doesn't display bar edges with mpl2.0b3
- #6989: bar3d no longer allows default colors

- #6980: problem accessing canvas on MacOS 10.11.6 with matplotlib 2.0.0b3
- #6804: Histogram of xarray.DataArray can be extremely slow
- #6859: Update URL for links to ggplot
- #6852: Switching to log scale when there is no positive data crashes the Qt5 backend, causes inconsistent internal state in others
- #6740: PGF Backend: Support interpolation='none'?
- #6665: regression: builtin latex rendering doesn't find the right mathematical fonts
- #6984: plt.annotate(): segmentation fault when coordinates are too high
- #6979: plot won't show with plt.show(block=False)
- #6981: link to ggplot is broken...
- #6975: [Feature request] Simple ticks generator for given range
- #6905: pcolorfast results in invalid cursor data
- #6970: quiver problems when angles is an array of values rather than 'uv' or 'xy'
- #6966: No Windows wheel available on PyPI for new version of matplotlib (1.5.2)
- #6721: Font cache building of matplotlib blocks requests made to HTTPd
- #6844: scatter edgecolor is broken in Matplotlib 2.0.0b3
- #6849: BUG: endless loop with MaxNLocator integer kwarg and short axis
- #6935: matplotlib.dates.DayLocator cannot handle invalid input
- #6951: Ring over A in AA is too high in Matplotlib 1.5.1
- #6960: axvline is sometimes not shown
- #6473: Matplotlib manylinux wheel - ready to ship?
- #5013: Add Hershey Fonts a la IDL
- #6953: ax.vlines adds unwanted padding, changes ticks
- #6946: No Coveralls reports on GitHub
- #6933: Misleading error message for matplotlib.pyplot.errorbar()
- #6945: Matplotlib 2.0.0b3 wheel can't load libpng in OS X 10.6
- #3865: Improvement suggestions for matplotlib.Animation.save('video.mp4')
- #6932: Investigate issue with pyparsing 2.1.6
- #6941: Interfering with yahoo_finance
- #6913: Cant get currency from yahoo finance with matplotlib
- #6901: Add API function for removing legend label from graph
- #6510: 2.0 beta: Boxplot patches zorder differs from lines

- #6911: freetype build won't become local
- #6866: examples/misc/longshort.py is outdated
- #6912: Matplotlib fail to compile matplotlib._png
- #1711: Autoscale to automatically include a tiny margin with `Axes.errorbar()`
- #6903: `RuntimeError('Invalid DISPLAY variable')` - With docker and django
- #6888: Can not maintain zoom level when left key is pressed
- #6855: imsave-generated PNG files missing edges for certain resolutions
- #6479: Hexbin with log scale takes extent range as logarithm of the data along the log axis
- #6795: suggestion: `set_xticklabels` and `set_yticklabels` default to current labels
- #6825: I broke `imshow(<signed integer array>)` :-)
- #6858: PyQt5 pyplot error
- #6853: PyQt5 (v5.7) backend - `TypeError` upon calling `figure()`
- #6835: Which image formats to build in docs.
- #6856: Incorrect plotting for versions > 1.3.1 and GTK.
- #6838: Figures not showing in interactive mode with macosx backend
- #6846: GTK Warning
- #6839: Test `test_pickle.test_complete` is broken
- #6691: `rcParam` missing tick side parameters
- #6833: plot contour with levels from discrete data
- #6636: DOC: gallery supplies 2 pngs, neither of which is default
- #3896: `dates.date2num` bug with daylight switching hour
- #6685: 2.0 dev legend breaks on scatterplot
- #3655: ensure removal of font cache on version upgrade
- #6818: Failure to build docs: unknown property
- #6798: clean and regenerate travis cache
- #6782: 2.x: Contour level count is not respected
- #6796: plot/lines not working for datetime objects that span old dates
- #6660: cell focus/cursor issue when plotting to `nbgg`
- #6775: Last figure in http://matplotlib.org/users/pyplot_tutorial.html is not displayed correctly
- #5981: Increased tick width in 3D plots looks odd
- #6771: `ImportError: No module named artist`
- #6289: Grids are not rendered in backend implementation

- #6621: Change in the result of `test_markevery_linear_scales_zoomed`
- #6515: Dotted grid lines in v2.0.0b1
- #6511: Dependencies in installation of 2.0.0b1
- #6668: “Bachelor’s degrees...” picture in the gallery is cropped
- #6751: Tableau style
- #6742: `import matplotlib.pyplot as plt` throws an error
- #6097: anaconda package missing nose dependency
- #6299: `savefig()` to eps/pdf does not work
- #6387: `import matplotlib` causes `UnicodeDecodeError`
- #6471: Colorbar label position different when executing a block of code
- #6732: Adding `pairplot` functionality?
- #6749: Step diagram does not support `xlim()` and `yylim()`
- #6748: Step diagram does not support
- #6615: Bad event index for step plots
- #6588: Different line styles between PNG and PDF exports.
- #6693: `linestyle="None"` argument for `fill_between()` doesn't work
- #6592: Linestyle pattern depends on current style, not style set at creation
- #5430: Linestyle: dash tuple with offset
- #6728: Can't install matplotlib with specific python version
- #6546: Recommendation to install packages for various OS
- #6536: `get_sample_data()` in `cbook.py` duplicates code from `_get_data_path() __init__.py`
- #3631: Better document meaning of notches in boxplots
- #6705: The test suite spends 20% of its time in `gc.collect()`
- #6698: Axes3D scatter crashes without alpha keyword
- #5860: Computer Modern Roman should be the default serif when using TeX backend
- #6702: Bad fonts crashes matplotlib on startup
- #6671: Issue plotting big endian images
- #6196: Qt properties editor discards color alpha
- #6509: pylab `image_masked` is broken
- #6657: appveyor is failing on pre-install
- #6610: Icons for Tk are not antialiased.
- #6687: Small issues with the example `polar_scatter_demo.py`

- #6541: Time to deprecate the GTK backend
- #6680: Minor typo in the docstring of `IdentityTransform`?
- #6670: `plt.text` object updating incorrectly with `blit=False`
- #6646: Incorrect `fill_between` chart when use `set_xscale('log')`
- #6540: `imshow(..., alpha=0.5)` produces different results in 2.x
- #6650: `fill_between()` not working properly
- #6566: Regression: `Path.contains_points` now returns `uint` instead of `bool`
- #6624: bus error: `fc-list`
- #6655: Malware found on matplotlib components
- #6623: `RectangleSelector` disappears after resizing
- #6629: matplotlib version error
- #6638: `get_ticklabels` returns `'` in `ipython/python` interpreter
- #6631: can't build matplotlib on smartos system(`open solaris`)
- #6562: 2.x: Cairo backends cannot render images
- #6507: custom scatter marker demo broken
- #6591: DOC: update static image for `interpolation_none_vs_nearest.py` example
- #6607: BUG: saving image to png changes colors
- #6587: please copy <http://matplotlib.org/devdocs/users/colormaps.html> to <http://matplotlib.org/users>
- #6594: Documentation Typo
- #5784: dynamic ticking (#5588) should avoid (if possible) single ticks
- #6492: `mpl_toolkits.mplot3d` has a null byte somewhere
- #5862: Some Microsoft fonts produce unreadable EPS
- #6537: bundled six 1.9.0 causes `ImportError: No module named 'winreg'` in Pympler
- #6563: `pyplot.errorbar` attempts to plot 0 on a log axis in SVGs
- #6571: Unexpected behavior with `ttk.Notebook` - graph not loaded unless tab preselected
- #6570: Unexpected behavior with `ttk.Notebook` - graph not loaded unless tab preselected
- #6539: network tests are not skipped when running `tests.py` with `-no-network`
- #6567: `qt_compat` fails to identify `PyQt5`
- #6559: `mpl` 1.5.1 requires `pyqt` even with a `wx` backend
- #6009: No space before unit symbol when there is no SI prefix in `ticker.EngFormatter`
- #6528: Fail to install matplotlib by “`pip install`” on SmartOS(like `open solaris` system)
- #6531: Segmentation fault with any backend (matplotlib 1.4.3 and 1.5.1) when calling `pyplot.show()`

- #6513: Using gray shade from string ignores alpha parameters
- #6477: Savefig() to pdf renders markers differently than show()
- #6525: PS export issue with custom font
- #6514: LaTeX axis labels can no longer have custom fonts
- #2663: Multi Cursor disable broken
- #6083: Figure linewidth default in reparams
- #1069: Add a donation information page
- #6035: Issue(?): head size of FancyArrowPatch changes between interactive figure and picture export
- #6495: new figsize is bad for subplots with fontsize 12
- #6493: Stepped color cycle for background and edge different
- #6380: Implicit addition of “color” to property_cycle breaks semantics
- #6447: Line2D.contains does not take drawstyle into account.
- #6257: option for default space between title and axes
- #5868: tight_layout doesn’t leave enough space between outwards ticks and axes title
- #5987: Outward ticks cause labels to be clipped by default
- #5269: Default changes: legend
- #6489: Test errors with numpy 1.11.1rc1
- #5960: Misplaced shadows when using FilteredArtistList
- #6452: Please add a generic “seaborn” style
- #6469: Test failures testing matplotlib 1.5.1 manylinux wheels
- #5854: New cyler does not work with bar plots
- #5977: legend needs logic to deal with new linestyle scaling by linewidth
- #6365: Default format time series xtick labels changed
- #6104: docs: latex required for PDF plotting?
- #6451: Inequality error on web page http://matplotlib.org/faq/howto_faq.html
- #6459: use conda already installed on appveyor
- #6043: Advanced hillshading example looks strange with new defaults.
- #6440: BUG: set_tick_params labelcolor should apply to offset
- #6458: Wrong package name in INSTALL file
- #2842: matplotlib.tests.test_basic.test_override_builtins() fails with Python >=3.4
- #2375: matplotlib 1.3.0 doesn’t compile with Solaris Studio 12.1 CC
- #2667: matplotlib.tests.test_mathtext.test_mathtext_{cm,stix,stixsans}_{37,53}.test are failing

- #2243: axes limits with aspect='equal'
- #1758: y limit with dashed or dotted lines hangs with somewhat big data
- #5994: Points annotation coords not working in 2.x
- #6444: matplotlib.path.contains_points is a LOT slower in 1.51
- #5461: Feature request: allow a default line alpha to be set in mpl.rcParams
- #5132: ENH: Set the alpha value for plots in rcParams
- #6449: axhline and axvline linestyle as on-off seq doesn't work if set directly in function call
- #6416: animation with 'ffmpeg' backend and 'savefig.bbox = tight' garbles video
- #6437: Improperly spaced time axis
- #5974: scatter is not changing color in Axes3D
- #6436: clabels plotting outside of projection limb
- #6438: Cant get emoji working in Pie chart legend with google app engine. Need help.
- #6362: greyscale scatter points appearing blue
- #6301: tricky bug in ticker due to special behaviour of numpy
- #6276: Ticklabel format not preserved after editing plot limits
- #6173: linestyle parameter does not support default cyler through None, crashes instead.
- #6109: colorbar _ticker + _locate bug
- #6231: Segfault when figures are deleted in random order
- #6432: micro sign doesn't show in EngFormatter
- #6057: Infinite Loop: LogLocator Colorbar & update_ticks
- #6270: pyplot.contour() not working with matplotlib.ticker.LinearLocator()
- #6058: "Configure subplots" tool is initialized very inefficiently in the Qt backends
- #6363: Change legend to accept alpha instead of (only) framealpha.
- #6394: Severe bug in ``imshow`` when plotting images with small values
- #6368: Bug: matplotlib.pyplot.spy: does not work correctly for sparse matrices with many entries ($\geq 2^{*32}$)
- #6419: Imshow does not copy data array but determines colormap values upon call
- #3615: mouse scroll event in Gtk3 backend
- #3373: add link to gtk embedding cookbook to website
- #6121: opening the configure subplots menu moves the axes by a tiny amount
- #2511: NavigationToolbar breaks if axes are added during use.
- #6349: Down arrow on GTK3 backends selects toolbar, which eats further keypress events

- #6408: minor ticks don't respect rcParam `xtick.top` / `ytick.right`
- #6398: sudden install error with pip (pyparsing 2.1.2 related)
- #5819: 1.5.1rc1: dont use absolute links in the “new updates” on the homepage
- #5969: urgent bug after 1.5.0: offset of `LineCollection` when apply `agg_filter`
- #5767: axes limits (in old “round_numbers” mode) affected by floating point issues
- #5755: Better choice of axes offset value
- #5938: possible bug with `ax.set_yscale('log')` when all values in array are zero
- #6399: pyparsing version 2.1.2 not supported (2.1.1 works though)
- #5884: numpy as no Attribute `string0`
- #6395: Deprecation warning for `axes.color_cycle`
- #6385: Possible division by zero in new `get_tick_space()` methods; is rotation ignored?
- #6344: Installation issue
- #6315: Qt properties editor could sort lines labels using `natsort`
- #5219: Notebook backend: possible to remove javascript/html when figure is closed?
- #5111: nbagg backend captures exceptions raised by callbacks
- #4940: `NBAgg` figure management issues
- #4582: Matplotlib IPython Widget
- #6142: `matplotlib.ticker.LinearLocator.view_limits` algorithm improvement?
- #6326: Unicode invisible after image saved
- #5980: Gridlines on top of plot by default in 2.0?
- #6272: Ability to set default scatter marker in `matplotlibrc`
- #6335: subplots animation example is broken on OS X with `qt4agg`
- #6357: `pyplot.hist`: normalization fails
- #6352: `clim` doesn't update after draw
- #6353: `hist` won't norm for small numbers
- #6343: `prop_cycle` breaks keyword aliases
- #6226: Issue saving figure as eps when using `gouraud` shaded triangulation
- #6330: `ticklabel_format` reset to default by `ScalarFormatter`
- #4975: Non-default `color_cycle` not working in Pie plot
- #5990: Scatter markers do not follow new colour cycle
- #5577: Handling of “next color in cycle” should be handled differently
- #5489: Special color names to pull colors from the currently active color cycle

- #6325: Master requires cycler 0.10.0
- #6278: imshow with pgf backend does not render transparency
- #5945: Figures in the notebook backend are too large following DPI changes
- #6332: Animation with blit broken
- #6331: matplotlib pcolormesh seems to slide some data around on the plot
- #6307: Seaborn style sheets don't edit `patch.facecolor`
- #6294: Zero size ticks show up as single pixels in rendered pdf
- #6318: Cannot import `mpl_toolkits` in Python3
- #6316: `Viridis` exists but not in `plt.cm.datad.keys()`
- #6082: Cannot interactively edit axes limits using Qt5 backend
- #6309: Make `CheckButtons` based on subplots automatically
- #6306: Can't show images when `plt.show()` was executed
- #2527: Vertical alignment of text is too high
- #4827: Pickled Figure Loses `sharedx` Properties
- #5998: `math??{ }` font styles are ignored in 2.x
- #6293: matplotlib notebook magic cells with output plots - skips next cell for computation
- #235: hatch linewidth patch
- #5875: Manual linestyle specification ignored if `'prop_cycle'` contains `'ls'`
- #5959: imshow rendering issue
- #6237: MacOSX agg version: doesn't redraw after `keymap.grid` keypress
- #6266: Better fallback when color is a float
- #6002: Potential bug with `'start_points'` argument of `'pyplot.streamplot'`
- #6265: Document how to set `viridis` as default colormap in mpl 1.x
- #6258: Rendering vector graphics: parsing polygons?
- #1702: Bug in 3D histogram documentation
- #5937: `xticks/yticks` default behaviour
- #4706: Documentation - Basemap
- #6255: Can't build `matplotlib.ft2font` in cygwin
- #5792: Not easy to get colorbar tick mark locations
- #6233: `ImportError` from Sphinx `plot_directive` from Cython
- #6235: Issue with building docs with Sphinx 1.4.0
- #4383: xkcd color names

- #6219: Example embedding_in_tk.py freezes in Python3.5.1
- #5067: improve whats_new entry for prop cyclor
- #4614: Followup items from the matplotlib 2.0 BoF
- #5986: mac osx backend does not scale dashes by linewidth
- #4680: Set forward=True by default when setting the figure size
- #4597: use mkdtemp in _create_tmp_config_dir
- #3437: Interactive save should respect 'savefig.facecolor' rcParam.
- #2467: Improve default colors and layouts
- #4194: matplotlib crashes on OS X when saving to JPEG and then displaying the plot
- #4320: Pyplot.imshow() "None" interpolation is not supported on Mac OSX
- #1266: Draggable legend results RuntimeError and AttributeError on Mac OS 10.8.1
- #5442: xkcd plots rendered as regular plots on Mac OS X
- #2697: Path snapping does not respect quantization scale appropriate for Retina displays
- #6049: Incorrect TextPath display under interactive mode
- #1319: macosx backend lacks support for cursor-type widgets
- #531: macosx backend does not work with blitting
- #5964: slow rendering with backend_macosx on El Capitan
- #5847: macosx backend color rendering
- #6224: References to non-existing class FancyBoxPatch
- #781: macosx backend doesn't find fonts the same way as other backends
- #4271: general colormap reverser
- #6201: examples svg_histogram.html failes with UnicodeEncodeError
- #6212: ENH? BUG? pyplot.setp/Artist.setp does not accept non-indexable iterables of handles.
- #4445: Two issues with the axes offset indicator
- #6209: Qt4 backend uses Qt5 backend
- #6136: Feature request: configure default scatter plot marker size
- #6180: Minor typos in the style sheets users' guide
- #5517: "interactive example" not working with PySide
- #4607: bug in font_manager.FontManager.score_family()
- #4400: Setting annotation background covers arrow
- #596: Add "bring window to front" functionality

- #4674: Default marker edge width in plot vs. scatter
- #5988: rainbow_text example is missing some text
- #6165: MacOSX backend hangs drawing lines with many dashes/dots
- #6155: Deprecation warnings with Dateutil 2.5
- #6003: In 'pyplot.streamplot', starting points near the same streamline raise 'InvalidIndexError'
- #6105: Accepting figure argument in subplot2grid
- #6184: csv2rec handles dates differently to datetimes when datefirst is specified.
- #6164: Unable to use PySide with gui=qt
- #6166: legends do not refresh
- #3897: bug: inconsistent types accepted in DateLocator subclasses
- #6160: EPS issues with rc parameters used in seaborn library on Win 8.1
- #6163: Can't make matplotlib run in my computer
- #5331: Boxplot with zero IQR sets whiskers to max and min and leaves no outliers
- #5575: plot_date() ignores timezone
- #6143: drawstyle accepts anything as default rather than raising
- #6151: Matplotlib 1.5.1 ignores annotation_clip parameter
- #6147: colormaps issue
- #5916: Headless get_window_extent or equivalent
- #6141: Matplotlib subplots and datetime x-axis functionality not working as intended?
- #6138: No figure shows, no error
- #6134: Cannot plot a line of width=1 without antialiased
- #6120: v2.x failures on travis
- #6092: %matplotlib notebook broken with current matplotlib master
- #1235: Legend placement bug
- #2499: Showing np.uint16 images of the form (h,w,3) is broken
- #5479: Table: auto_set_column_width not working
- #6028: Appearance of non-math hyphen changes with math in text
- #6113: ValueError after moving legend and rcParams.update
- #6111: patches fails when data are array, not list
- #6108: Plot update issue within event callback for multiple updates
- #6069: imshow no longer correctly handles 'bad' (nan) values
- #6103: ticklabels empty when not interactive

- #6084: Despined figure is cropped
- #6067: pyplot.savefig doesn't expand ~ (tilde) in path
- #4754: Change default color cycle
- #6063: Axes.relim() seems not to work when copying Line2D objects
- #6065: Proposal to change color – 'indianred'
- #6056: quiver plot in polar projection - how to make the quiver density latitude-dependent ?
- #6051: Matplotlib v1.5.1 apparently not compatible with python-dateutil 2.4.2
- #5513: Call get_backend in pylab_setup
- #5983: Option to Compress Graphs for pgf-backend
- #5895: Polar Projection PDF Issue
- #5948: tilted line visible in generated pdf file
- #5737: matplotlib 1.5 compatibility with wxPython
- #5645: Missing line in a self-sufficient example in navigation_toolbar.rst :: a minor bug in docs
- #6037: Matplotlib xtick appends .%f after %H:%M:%S on chart
- #6025: Exception in Tkinter/to_rgb with new colormaps
- #6034: colormap name is broken for ListedColormap?
- #5982: Styles need update after default style changes
- #6017: Include tests.py in archive of release
- #5520: 'nearest' interpolation not working with low dpi
- #4280: imsave reduces 1row from the image
- #3057: DPI-connected bug of imshow when using multiple masked arrays
- #5490: Don't interpolate images in RGB space
- #5996: 2.x: Figure.add_axes(..., facecolor='color') does not set axis background colour
- #4760: Default linewidth thicker than axes linewidth
- #2698: ax.text() fails to draw a box if the text content is full of blank spaces and linefeeds.
- #3948: a weird thing in the source code comments
- #5921: test_backend.pgf.check_for(texsystem) does not do what it says...
- #4295: Draggable annotation position wrong with negative x/y
- #1986: Importing pyplot messes with command line argument parsing
- #5885: matplotlib stepfilled histogram breaks at the value 10^{-1} on xubuntu
- #5050: pandas v0.17.0rc1
- #3658: axes.locator_params fails with LogLocator (and most Locator subclasses)

- #3742: Square plots
- #3900: debugging Segmentation fault with Qt5 backend
- #4192: Error when color value is None
- #4210: segfault: fill_between with Python3
- #4325: FancyBboxPatch wrong size
- #4340: Histogram gap artifacts
- #5096: Add `xtick.top.visible`, `xtick.bottom.visible`, `ytick.left.visible`, `ytick.right.visible` to `rcParams`
- #5120: custom axis scale doesn't work in 1.4.3
- #5212: shifted(?) bin positions when plotting multiple histograms at the same time
- #5293: Qt4Agg: RuntimeError: call `__init__` twice
- #5971: Add support for PySide2 (Qt5)
- #5993: Basemap `readshapefile` should read `shapefile` for the `long/lat` specified in the Basemap instance.
- #5991: basemap crashes with no error message when passed numpy nan's
- #5883: New colormaps : Inferno, Viridis, ...
- #5841: extra label for non-existent tick
- #4502: Default style proposal: outward tick marks
- #875: Replace "jet" as the default colormap
- #5047: Don't draw end caps on error bars by default
- #4700: Overlay blend mode
- #4671: Change default legend location to 'best'.
- #5419: Default setting of figure transparency in NbAgg is a performance problem
- #4815: Set default axis limits in 2D-plots to the limits of the data
- #4854: set `numpoints` to 1
- #5917: improved dash styles
- #5900: Incorrect Image Tutorial Inline Sample Code
- #5965: xkcd example in gallery
- #5616: Better error message if no animation writer is available
- #5920: How to rotate secondary y axis label so it doesn't overlap with y-ticks, matplotlib
- #5966: SEGFAULT if `pyp1ot` is imported
- #5967: `savefig` SVG and PDF output for scatter plots is excessively complex, crashses Inkscape
- #1943: legend doesn't work with `stackplot`

- #5923: Windows usetex=True error in long usernames
- #5940: KeyError: 'getpwuid(): uid not found: 5001'
- #5748: Windows test failures on appveyor
- #5944: Notebook backend broken on Master
- #5946: Calling subplots_adjust breaks savefig output
- #5929: Fallback font doesn't work on windows?
- #5925: Data points beyond axes range plotted when saved to SVG
- #5918: Pyplot.savefig is very slow with some combinations of data/ylim scales
- #5919: Error when trying to import matplotlib into IPython notebook
- #5803: Barbs broken
- #5846: setupext.py: problems parsing setup.cfg (not updated to changes in configparser)
- #5309: Differences between function and keywords for savefig.bbox and axes.facecolor
- #5889: Factual errors in HowTo FAQ Box Plot Image
- #5618: New rcParams requests
- #5810: Regression in test_remove_shared_axes
- #5281: plt.tight_layout(pad=0) cuts away outer ticks
- #5909: The documentation for LinearLocator's presets keyword is unclear
- #5864: mathtext mishandling of certain exponents
- #5869: doc build fails with mpl-1.5.1 and sphinx-1.3.4 (sphinx-1.3.3 is fine)
- #5835: gridspec.Gridspec doesn't check for consistency in arguments
- #5867: No transparency in *.pgf file when using pgf Backend.
- #5863: left(... right) are too small
- #5850: prop_cycler for custom dashes – linestyle such as (<offset>, (<on>, <off>)) throws error
- #5861: Marker style request
- #5851: Bar and box plots use the 'default' matplotlib colormap, even if the style is changed
- #5857: FAIL: matplotlib.tests.test_coding_standards.test_pep8_conformance_examples
- #5831: tests.py is missing from pypi tarball
- #5829: test_rasterize_dpi fails with 1.5.1
- #5843: what is the source code of ax.pcolormesh(T, R, Z, vmin=0, vmax=255, cmap='jet') ?
- #5799: mathtext kerning around comma
- #2841: There is no set_linestyle_cycle in the matplotlib axes API
- #5821: Consider using an offline copy of Raleway font

- #5822: FuncAnimation.save() only saving 1 frame
- #5449: Incomplete dependency list for installation from source
- #5793: GTK backends
- #5814: Adding colorbars to row subplots doesn't render the main plots when saving to .eps in 1.5.0
- #5816: matplotlib.pyplot.boxplot ignored showmeans keyword
- #5086: Default date format for axis formatting
- #4808: AutoDateFormatter shows too much precision
- #5812: Widget event issue
- #5794: --no-network not recognized as valid option for tests.py
- #5801: No such file or directory: '/usr/share/matplotlib/stylelib'
- #5777: Using default style raises warnings about non style parameters
- #5738: Offset text should be computed based on lowest and highest ticks, not actual axes limits
- #5403: Document minimal MovieWriter sub-class
- #5558: The link to the John Hunter Memorial fund is a 404
- #5757: Several axes_grid1 and axisartist examples broken on master
- #5557: plt.hist throws KeyError when passed a pandas.Series without 0 in index
- #5550: Plotting datetime values from Pandas dataframe
- #4855: Limit what style.use can affect?
- #5765: import matplotlib._png as _png ImportError: libpng16.so.16: cannot open shared object
- #5753: Handling of zero in log shared axes depends on whether axes are shared
- #5756: 3D rendering, scatterpoints disappear near edges of surfaces
- #5747: Figure.suptitle does not respect size argument
- #5641: plt.errorbar error with empty list
- #5476: annotate doesn't trigger redraw
- #5572: Matplotlib 1.5 broken_barh fails on empty data.
- #5089: axes.properties calls get_axes internally
- #5745: Using internal qhull despite the presence of pyqhull installed in the system
- #5744: cycler is required, is missing, yet build succeeds.
- #5592: Problem with _init_func in ArtistAnimation
- #5729: Test matplotlib.tests.test_backend_svg.test_determinism fails on OSX in virtual envs.
- #4756: font_manager.py takes multiple seconds to import
- #5435: Unable to upgrade matplotlib 1.5.0 through pip

- #5636: Generating legend from figure options panel of qt backend raise exception for large number of plots
- #5365: Warning in test_lines.test_nan_is_sorted
- #5646: Version the font cache
- #5692: Can't remove StemContainer
- #5635: RectangleSelector creates not wanted lines in axes
- #5427: BUG? Normalize modifies pandas Series inplace
- #5693: Invalid caching of long lines with nans
- #5705: doc/users/plotting/examples/axes_zoom_effect.py is not a Python file
- #4359: savefig crashes with malloc error on os x
- #5715: Minor error in set up fork
- #5687: Segfault on plotting with PySide as backend.qt4
- #5708: Segfault with Qt4Agg backend in 1.5.0
- #5704: Issue with xy and xytext
- #5673: colorbar labelling bug (1.5 regression)
- #4491: Document how to get a framework build in a virtual env
- #5468: axes selection in axes editor
- #5684: AxesGrid demo exception with LogNorm: 'XAxis' object has no attribute 'set_scale'
- #5663: AttributeError: 'NoneType' object has no attribute 'canvas'
- #5573: Support HiDPI (retina) displays in docs
- #5680: SpanSelector span_stays fails with use_blit=True
- #5679: Y-axis switches to log scale when an X-axis is shared multiple times.
- #5655: Problems installing basemap behind a proxy
- #5670: Doubling of coordinates in polygon clipping
- #4725: change set_adjustable for share axes with aspect ratio of 1
- #5488: The default number of ticks should be based on the length of the axis
- #5543: num2date ignoring tz in v1.5.0
- #305: Change canvas.print_figure default resolution
- #5660: Cannot raise FileNotFoundError in python2
- #5658: A way to remove the image of plt.figimage()?
- #5495: Something fishy in png reading
- #5549: test_streamplot:test_colormap test broke unintentionally

- #5381: HiDPI support in Notebook backend
- #5531: test_mplot3d:test_quiver3d broke unintentionally
- #5530: test_axes:test_polar_unit broke unintentionally
- #5525: Comparison failure in text_axes:test_phase_spectrum_freqs
- #5650: Wrong backend selection with PyQt4
- #5649: Documentation metadata (release version) does not correspond with some of the ‘younger’ documentation content
- #5648: Some tests require non-zero tolerance
- #3980: zoom in wx with retina behaves badly
- #5642: Mistype in pyplot_scales.py of pyplot_tutorial.rst :: a minor bug in docs
- #3316: wx crashes on exit if figure not shown and not explicitly closed
- #5624: Cannot manually close matplotlib plot window in Mac OS X Yosemite
- #4891: Better auto-selection of axis limits
- #5633: No module named externals
- #5634: No module named ‘matplotlib.tests’
- #5473: Strange OS warning when import pyplot after upgrading to 1.5.0
- #5524: Change in colorbar extensions
- #5627: Followup for Windows CI stuff
- #5613: Quiverkey() positions arrow incorrectly with labelpos ‘N’ or ‘S’
- #5615: tornado now a requirement?
- #5582: FuncAnimation crashes the interpreter (win7, 64bit)
- #5610: Testfailures on windows
- #5595: automatically build windows conda packages and wheels in master
- #5535: test_axes:test_rc_grid image comparison test has always been broken
- #4396: Qt5 is not mentioned in backends list in doc
- #5205: pcolor does not handle non-array C data
- #4839: float repr in axes parameter editing window (aka the green tick button)
- #5542: Bad superscript positioning for some fonts
- #3791: Update colormap examples.
- #4679: Relationship between line-art markers and the markeredgewidth parameter
- #5601: Scipy/matplotlib recipe with plt.connect() has trouble in python 3 (AnnotateFinder)
- #4211: Axes3D quiver: variable length arrows

- #773: mplot3d enhancement
- #395: need 3D examples for tricontour and tricontourf
- #186: Axes3D with PolyCollection broken
- #178: Incorrect mplot3d contourf rendering
- #5508: Animation.to_html5_video requires python3 base64 module
- #5576: Improper reliance upon pkg-config when C_INCLUDE_PATH is set
- #5369: Change in zorder of streamplot between 1.3.1 and 1.4.0
- #5569: Stackplot does not handle NaNs
- #5565: label keyword is not interpreted properly in errorbar() for pandas.DataFrame-like objects
- #5561: interactive mode doesn't display images with standard python interpreter
- #5559: Setting window titles when in interactive mode
- #5554: Cropping text to axes
- #5545: EllipseCollection renders incorrectly when passed a sequence of widths
- #5475: artist picker tolerance has no effect
- #5529: Wrong image/code for legend_demo (pylab)
- #5139: plt.subplots for already existing Figure
- #5497: violin{,plot} return value
- #5441: boxplot rcParams are not in matplotlibrc.template
- #5522: axhline fails on custom scale example
- #5528: ρ in text for plots erroring
- #4799: Probability axes scales
- #5487: Trouble importing image_comparison decorator in v1.5
- #5464: figaspect not working with numpy floats
- #4487: Should default hist() bins be changed in 2.0?
- #5499: UnicodeDecodeError in IPython Notebook caused by negative numbers in plt.legend()
- #5498: Labels' collisions while plotting named DataFrame iterrows
- #5491: clippedline.py example should be removed
- #5482: RuntimeError: could not open display
- #5481: value error : unknown locale: UTF-8
- #4780: Non-interactive backend calls draw more than 100 times
- #5470: colorbar values could take advantage of offsetting and/or scientific notation
- #5471: FuncAnimation video saving results in one frame file

- #5457: Example of new colormaps is misleading
- #3920: Please fix pip install, so that plt.show() etc works correctly
- #5418: install backend gtk in Cygwin
- #5368: New axes.set_prop_cycle method cannot handle any generic iterable
- #5446: Tests fail to run (killed manually after 7000 sec)
- #5225: Rare race condition in makedirs with parallel processes
- #5444: overline and subscripts/superscripts in mathtext
- #4859: Call `tight_layout()` by default
- #5429: Segfault in `matplotlib.tests.test_image:test_get_window_extent_for_AxisImage` on python3.5
- #5431: Matplotlib 1.4.3 broken on Windows
- #5409: Match zdata cursor display scalling with colorbar ?
- #5128: ENH: Better default font
- #5420: [Mac OS X 10.10.5] Macports install error :unknown locale: UTF-8
- #3867: OSX compile broken since CXX removal (conda only?)
- #5411: XKCD style fails except for inline mode
- #5406: Hangs on OS X 10.11.1: No such file or directory: `~/matplotlib/fontList.json`
- #3116: mplot3d: argument checking in `plot_surface` should be improved.
- #347: Faster Text drawing needed
- #5399: `FuncAnimation` w/o `init_func` breaks when saving
- #5395: Style changes doc has optimistic release date
- #5393: wrong legend in errorbar plot for pandas series
- #5396: `fill_between()` with gradient
- #5221: infinite range for `hist(histtype="step")`
- #4901: Error running double pendulum animation example
- #3314: `assert mods.pop(0) == 'tests'` errors for multiprocessing tests on OSX
- #5337: Remove `-nocapture` from nosetests on `.travis.yml`?
- #5378: errorbar fails with pandas data frame
- #5367: histogram and digitize do not agree on the definition of a bin
- #5314: `ValueError: insecure string pickle`
- #5347: Problem with importing `matplotlib.animation`
- #4788: Modified axes patch will not re-clip artists
- #4968: Lasso-ing in `WxAgg` causes flickering of the entire figure

Matplotlib only uses BSD compatible code, and its license is based on the [PSF](#) license. See the Open Source Initiative [licenses page](#) for details on individual licenses. Non-BSD compatible licenses (e.g., LGPL) are acceptable in matplotlib toolkits. For a discussion of the motivations behind the licencing choice, see *Licenses*.

11.1 Copyright Policy

John Hunter began matplotlib around 2003. Since shortly before his passing in 2012, Michael Droettboom has been the lead maintainer of matplotlib, but, as has always been the case, matplotlib is the work of many.

Prior to July of 2013, and the 1.3.0 release, the copyright of the source code was held by John Hunter. As of July 2013, and the 1.3.0 release, matplotlib has moved to a shared copyright model.

matplotlib uses a shared copyright model. Each contributor maintains copyright over their contributions to matplotlib. But, it is important to note that these contributions are typically only changes to the repositories. Thus, the matplotlib source code, in its entirety, is not the copyright of any single person or institution. Instead, it is the collective copyright of the entire matplotlib Development Team. If individual contributors want to maintain a record of what changes/contributions they have specific copyright on, they should indicate their copyright in the commit message of the change, when they commit the change to one of the matplotlib repositories.

The Matplotlib Development Team is the set of all contributors to the matplotlib project. A full list can be obtained from the git version control logs.

11.2 License agreement for matplotlib 2.0.2

1. This LICENSE AGREEMENT is between the Matplotlib Development Team (“MDT”), and the Individual or Organization (“Licensee”) accessing and otherwise using matplotlib software in source or binary form and its associated documentation.
2. Subject to the terms and conditions of this License Agreement, MDT hereby grants Licensee a nonexclusive, royalty-free, world-wide license to reproduce, analyze, test, perform and/or display publicly, prepare derivative works, distribute, and otherwise use matplotlib 2.0.2 alone or in any derivative version, provided, however, that MDT’s License Agreement and MDT’s notice of copyright, i.e., “Copyright (c) 2012-2013

Matplotlib Development Team; All Rights Reserved” are retained in matplotlib 2.0.2 alone or in any derivative version prepared by Licensee.

3. In the event Licensee prepares a derivative work that is based on or incorporates matplotlib 2.0.2 or any part thereof, and wants to make the derivative work available to others as provided herein, then Licensee hereby agrees to include in any such work a brief summary of the changes made to matplotlib 2.0.2.

4. MDT is making matplotlib 2.0.2 available to Licensee on an “AS IS” basis. MDT MAKES NO REPRESENTATIONS OR WARRANTIES, EXPRESS OR IMPLIED. BY WAY OF EXAMPLE, BUT NOT LIMITATION, MDT MAKES NO AND DISCLAIMS ANY REPRESENTATION OR WARRANTY OF MERCHANTABILITY OR FITNESS FOR ANY PARTICULAR PURPOSE OR THAT THE USE OF MATPLOTLIB 2.0.2 WILL NOT INFRINGE ANY THIRD PARTY RIGHTS.

5. MDT SHALL NOT BE LIABLE TO LICENSEE OR ANY OTHER USERS OF MATPLOTLIB 2.0.2 FOR ANY INCIDENTAL, SPECIAL, OR CONSEQUENTIAL DAMAGES OR LOSS AS A RESULT OF MODIFYING, DISTRIBUTING, OR OTHERWISE USING MATPLOTLIB 2.0.2, OR ANY DERIVATIVE THEREOF, EVEN IF ADVISED OF THE POSSIBILITY THEREOF.

6. This License Agreement will automatically terminate upon a material breach of its terms and conditions.

7. Nothing in this License Agreement shall be deemed to create any relationship of agency, partnership, or joint venture between MDT and Licensee. This License Agreement does not grant permission to use MDT trademarks or trade name in a trademark sense to endorse or promote products or services of Licensee, or any third party.

8. By copying, installing or otherwise using matplotlib 2.0.2, Licensee agrees to be bound by the terms and conditions of this License Agreement.

11.3 License agreement for matplotlib versions prior to 1.3.0

1. This LICENSE AGREEMENT is between John D. Hunter (“JDH”), and the Individual or Organization (“Licensee”) accessing and otherwise using matplotlib software in source or binary form and its associated documentation.

2. Subject to the terms and conditions of this License Agreement, JDH hereby grants Licensee a nonexclusive, royalty-free, world-wide license to reproduce, analyze, test, perform and/or display publicly, prepare derivative works, distribute, and otherwise use matplotlib 2.0.2 alone or in any derivative version, provided, however, that JDH’s License Agreement and JDH’s notice of copyright, i.e., “Copyright (c) 2002-2009 John D. Hunter; All Rights Reserved” are retained in matplotlib 2.0.2 alone or in any derivative version prepared by Licensee.

3. In the event Licensee prepares a derivative work that is based on or incorporates matplotlib 2.0.2 or any part thereof, and wants to make the derivative work available to others as provided herein, then Licensee hereby agrees to include in any such work a brief summary of the changes made to matplotlib 2.0.2.

4. JDH is making matplotlib 2.0.2 available to Licensee on an “AS IS” basis. JDH MAKES NO REPRESENTATIONS OR WARRANTIES, EXPRESS OR IMPLIED. BY WAY OF EXAMPLE, BUT NOT LIMITATION, JDH MAKES NO AND DISCLAIMS ANY REPRESENTATION OR WARRANTY OF MERCHANTABILITY OR FITNESS FOR ANY PARTICULAR PURPOSE OR THAT THE USE OF MATPLOTLIB 2.0.2 WILL NOT INFRINGE ANY THIRD PARTY RIGHTS.

5. JDH SHALL NOT BE LIABLE TO LICENSEE OR ANY OTHER USERS OF MATPLOTLIB 2.0.2 FOR ANY INCIDENTAL, SPECIAL, OR CONSEQUENTIAL DAMAGES OR LOSS AS A RESULT OF MODIFYING, DISTRIBUTING, OR OTHERWISE USING MATPLOTLIB 2.0.2, OR ANY DERIVATIVE THEREOF, EVEN IF ADVISED OF THE POSSIBILITY THEREOF.
6. This License Agreement will automatically terminate upon a material breach of its terms and conditions.
7. Nothing in this License Agreement shall be deemed to create any relationship of agency, partnership, or joint venture between JDH and Licensee. This License Agreement does not grant permission to use JDH trademarks or trade name in a trademark sense to endorse or promote products or services of Licensee, or any third party.
8. By copying, installing or otherwise using matplotlib 2.0.2, Licensee agrees to be bound by the terms and conditions of this License Agreement.

CREDITS

Matplotlib was written by John D. Hunter, with contributions from an ever-increasing number of users and developers. The current co-lead developers are Michael Droettboom and Thomas A. Caswell; they are assisted by many [active](#) developers.

The following is a list of contributors extracted from the git revision control history of the project:

4over7, Aaron Boushley, Acanthostega, Adam Ginsburg, Adam Heck, Adam Ortiz, Adrian Price-Whelan, Adrien F. Vincent, Ahmet Bakan, Alan Du, Alejandro Dubrovsky, Alex C. Szatmary, Alex Loew, Alexander Taylor, Alexei Colin, Ali Mehdi, Alistair Muldal, Allan Haldane, Amit Aronovitch, Amy, AmyTeegarden, Andrea Bedini, Andreas Hilboll, Andreas Wallner, Andrew Dawson, Andrew Merrill, Andrew Straw, Andy Zhu, Anton Akhmerov, Antony Lee, Arie, Ariel Hernán Curiale, Arnaud Gardelein, Arpad Horvath, Aseem Bansal, Behram Mistree, Ben Cohen, Ben Gamari, Ben Keller, Ben Root, Benjamin Reedlunn, Binglin Chang, Bradley M. Froehle, Brandon Liu, Brett Cannon, Brett Graham, Brian Mattern, Brian McLaughlin, Bruno Beltran, CJ Carey, Cameron Bates, Cameron Davidson-Pilon, Carissa Brittain, Carl Michal, Carwyn Pelley, Casey Webster, Casper van der Wel, Charles Moad, Chris Beaumont, Chris G, Christian Brueffer, Christian Stade-Schuldt, Christoph Dann, Christoph Gohlke, Christoph Hoffmann, Cimarron Mittelsteadt, Corey Farwell, Craig M, Craig Tenney, Damon McDougall, Dan Hickstein, Daniel Hyams, Daniel O'Connor, Dara Adib, Darren Dale, David Anderson, David Haberthür, David Huard, David Kaplan, David Kua, David Trémouilles, Dean Malmgren, Dmitry Lupyman, DonaldSeo, Dora Fraeman, Duncan Macleod, Edin Salkovic, Elena Glassman, Elias Pipping, Elliott Sales de Andrade, Emil Mikulic, Eric Dill, Eric Firing, Eric Ma, Eric O. LEBIGOT (EOL), Erik Bray, Eugen Beck, Eugene Yurtsev, Evan Davey, Ezra Peisach, Fabien Maussion, Fabio Zanini, Federico Ariza, Felipe, Fernando Perez, Filipe Fernandes, Florian Rhiem, Francesco Montesano, Francis Colas, François Magimel, Gaute Hope, Gellule Xg, Geoffroy Billotey, Gerald Storer, Giovanni, Graham Poulter, Gregory Ashton, Gregory R. Lee, Grégory Lielens, Guillaume Gay, Gustavo Braganca, Hans Dembinski, Hans Meine, Hans Moritz Günther, Hassan Kibirige, Holger Peters, Hubert Holin, Ian Thomas, Ignas Anikevicius (gns_ank), Iliia Kurenkov, Ioannis Filippidis, Ismo Toijala, J. Goutin, Jack Kelly, Jae-Joon Lee, Jaime Fernandez, Jake Vanderplas, James A. Bednar, James Pallister, James R. Evans, JamesMakela, Jan Schulz, Jan-Philip Gehrcke, Jan-willem De Bleser, Jarrod Millman, Jascha Ulrich, Jason Grout, Jason Liw Yan Chong, Jason Miller, JayP16, Jeff Lutgen, Jeff Whitaker, Jeffrey Bingham, Jens Hedegaard Nielsen, Jeremy Fix, Jeremy O'Donoghue, Jeremy Thurgood, Jessica B. Hamrick, Jim Radford, Jochen Voss, Jody Klymak, Joe Kington, Joel B. Mohler, John Hunter, Jonathan Waltman, Jorrit Wronski, Josef Heinen, Joseph Jon Booker, José Ricardo, Jouni K. Seppänen, Julian Mehne, Julian Taylor, JulianCienfuegos, Julien Lhermitte, Julien Schueller, Julien Woillez, Julien-Charles Lévesque, Kanwar245, Katy Huff, Ken McIvor, Kevin Chan, Kevin Davies, Kevin Keating, Kimmo Palin, Konrad Förstner, Konstantin Tretyakov, Kristen M. Thyng, Lance Hepler, Larry Bradley, Leonadoh, Lennart Fricke, Leo Singer, Levi Kilcher, Lion Krischer, Lodato Luciano, Lori J, Loïc Estève, Loïc Séguin-C, Magnus Nord, Majid alDosari, Maksym P, Manuel GOACOLOU, Manuel Metz, Marc Abramowitz, Marcos Duarte, Marek Rud-

nicki, Marianne Corvellec, Marin Gilles, Markus Roth, Markus Rothe, Martin Dengler, Martin Fitzpatrick, Martin Spacek, Martin Teichmann, Martin Thoma, Martin Ueding, Masud Rahman, Mathieu Duponchelle, Matt Giuca, Matt Klein, Matt Li, Matt Newville, Matt Shen, Matt Terry, Matthew Brett, Matthew Emmett, Matthias Bussonnier, Matthieu Caneill, Matěj Týč, Maximilian Albert, Maximilian Trescher, Mellissa Cross, Michael, Michael Droettboom, Michael Sarahan, Michael Welter, Michiel de Hoon, Michka Popoff, Mike Kaufman, Mikhail Korobov, MinRK, Minty Zhang, MirandaXM, Miriam Sierig, Muhammad Mehdi, Neil, Neil Crighton, Nelle Varoquaux, Niall Robinson, Nic Eggert, Nicholas Devenish, Nick Semenkovich, Nicolas P. Rougier, Nicolas Pinto, Nikita Kniazev, Niklas Koep, Nikolay Vyahhi, Norbert Nemeč, Ocean-Wolf, Oleg Selivanov, Olga Botvinnik, Oliver Willekens, Parfenov Sergey, Pascal Bugnion, Patrick Chen, Patrick Marsh, Paul, Paul Barret, Paul G, Paul Hobson, Paul Ivanov, Pauli Virtanen, Per Parker, Perry Greenfield, Pete Bachant, Peter Iannucci, Peter St. John, Peter Würtz, Phil Elson, Pierre Haessig, Pim Schellart, Piti Ongmongkolkul, Puneeth Chaganti, Ramiro Gómez, Randy Olson, Reinier Heeres, Remi Rampin, Richard Hattersley, Richard Trieu, Ricky, Robert Johansson, Robin Dunn, Rohan Walker, Roland Wirth, Russell Owen, RutgerK, Ryan Blomberg, Ryan D'Souza, Ryan Dale, Ryan May, Ryan Nelson, RyanPan, Salil Vanvari, Sameer D'Costa, Sandro Tosi, Scott Lasley, Scott Lawrence, Scott Stevenson, Sebastian Pinnau, Sebastian Raschka, Sergey Kholodilov, Sergey Koposov, Silviu Tantos, Simon Cross, Simon Gibbons, Skelpdar, Skipper Seabold, Slav Basharov, Spencer McIntyre, Stanley, Simon, Stefan Lehmann, Stefan van der Walt, Stefano Rivera, Stephen Horst, Sterling Smith, Steve Chaplin, Steven Silvester, Stuart Mumford, Takafumi Arakaki, Takeshi Kanmae, Tamas Gal, Thomas A Caswell, Thomas Hisch, Thomas Kluyver, Thomas Lake, Thomas Robitaille, Thomas Spura, Till Stensitzki, Timo Vanwysberghe, Tobias Hoppe, Tobias Megies, Todd Jennings, Todd Miller, Tomas Kazmar, Tony S Yu, Tor Colvin, Travis Oliphant, Trevor Bekolay, Ulrich Dobramysl, Umair Idris, Vadim Markovtsev, Valentin Haenel, Victor Zabalza, Viktor Kerkez, Vlad Seghete, Víctor Terrón, Víctor Zabalza, Wen Li, Wendell Smith, Werner F Bruhin, Wes Campaigne, Wieland Hoffmann, William Manley, Wouter Overmeire, Xiaowen Tang, Yann Tambouret, Yaron de Leeuw, Yu Feng, Yunfei Yang, Yuri D'Elia, Yuval Langer, Zach Pincus, Zair Mubashar, alex, anykraus, arokem, aseagram, aszilagyi, bblay, bev-a-tron, blackwIng, blah blah, burrbull, butterw, cammil, captainwhippet, chadawagner, chebee7i, danielballan, davidovitch, daydreamt, domspad, donald, drevicko, e-q, elpres, endolith, fardal, ffeja, fgb, fibersnet, frenchwr, fvgoto, gitj, gluap, goir, hugadams, insertroar, itziakos, jbbrokaw, juan.gonzalez, kcrisman, kelsiegr, khyox, kikocorreoso, kramer65, kshramt, lichri12, limtaesu, marky, masamson, mbyt, mcelrath, mdipierro, mrkrd, nickystringer, nwin, pkienzle, profholzer, pupssman, rahiel, rhoef, rsnape, s9w, sdementen, sfroid, sohero, spiessbuerger, stahlous, switham, syngron, torfbolt, u55, ugurthemaster, vbr, xbtsw, and xuanyuansen.

Some earlier contributors not included above are (with apologies to any we have missed):

Charles Twardy, Gary Ruben, John Gill, David Moore, Paul Barrett, Jared Wahlstrand, Jim Benson, Paul McGuire, Andrew Dalke, Nadia Dencheva, Baptiste Carvello, Sigve Tjoraand, Ted Drain, James Amundson, Daishi Harada, Nicolas Young, Paul Kienzle, John Porter, and Jonathon Taylor.

We also thank all who have reported bugs, commented on proposed changes, or otherwise contributed to Matplotlib's development and usefulness.

Part II

The Matplotlib API

PLOTTING COMMANDS SUMMARY

`matplotlib.pyplot.plotting()`

Function	Description
<i>acorr</i>	Plot the autocorrelation of x .
<i>angle_spectrum</i>	Plot the angle spectrum.
<i>annotate</i>	Annotate the point xy with text s .
<i>arrow</i>	Add an arrow to the axes.
<i>autoscale</i>	Autoscale the axis view to the data (toggle).
<i>axes</i>	Add an axes to the figure.
<i>axhline</i>	Add a horizontal line across the axis.
<i>axhspan</i>	Add a horizontal span (rectangle) across the axis.
<i>axis</i>	Convenience method to get or set axis properties.
<i>axvline</i>	Add a vertical line across the axes.
<i>axvspan</i>	Add a vertical span (rectangle) across the axes.
<i>bar</i>	Make a bar plot.
<i>barbs</i>	Plot a 2-D field of barbs.
<i>barh</i>	Make a horizontal bar plot.
<i>box</i>	Turn the axes box on or off.
<i>boxplot</i>	Make a box and whisker plot.
<i>broken_barh</i>	Plot horizontal bars.
<i>cla</i>	Clear the current axes.
<i>clabel</i>	Label a contour plot.
<i>clf</i>	Clear the current figure.
<i>clim</i>	Set the color limits of the current image.
<i>close</i>	Close a figure window.
<i>cohere</i>	Plot the coherence between x and y .
<i>colorbar</i>	Add a colorbar to a plot.
<i>contour</i>	Plot contours.
<i>contourf</i>	Plot contours.
<i>csd</i>	Plot the cross-spectral density.
<i>delaxes</i>	Remove an axes from the current figure.
<i>draw</i>	Redraw the current figure.
<i>errorbar</i>	Plot an errorbar graph.

Function	Description
<code>eventplot</code>	Plot identical parallel lines at specific positions.
<code>figimage</code>	Adds a non-resampled image to the figure.
<code>figlegend</code>	Place a legend in the figure.
<code>fignum_exists</code>	
<code>figtext</code>	Add text to figure.
<code>figure</code>	Creates a new figure.
<code>fill</code>	Plot filled polygons.
<code>fill_between</code>	Make filled polygons between two curves.
<code>fill_betweenx</code>	Make filled polygons between two horizontal curves.
<code>findobj</code>	Find artist objects.
<code>gca</code>	Get the current <i>Axes</i> instance on the current figure matching the given keyword args.
<code>gcf</code>	Get a reference to the current figure.
<code>gci</code>	Get the current colorable artist.
<code>get_figlabels</code>	Return a list of existing figure labels.
<code>get_fignums</code>	Return a list of existing figure numbers.
<code>grid</code>	Turn the axes grids on or off.
<code>hexbin</code>	Make a hexagonal binning plot.
<code>hist</code>	Plot a histogram.
<code>hist2d</code>	Make a 2D histogram plot.
<code>hlines</code>	Plot horizontal lines at each <i>y</i> from <i>xmin</i> to <i>xmax</i> .
<code>hold</code>	
<code>imread</code>	Read an image from a file into an array.
<code>imsave</code>	Save an array as in image file.
<code>imshow</code>	Display an image on the axes.
<code>install_repl_displayhook</code>	Install a repl display hook so that any stale figure are automatically redrawn when con
<code>ioff</code>	Turn interactive mode off.
<code>ion</code>	Turn interactive mode on.
<code>ishold</code>	
<code>isinteractive</code>	Return status of interactive mode.
<code>legend</code>	Places a legend on the axes.
<code>locator_params</code>	Control behavior of tick locators.
<code>loglog</code>	Make a plot with log scaling on both the <i>x</i> and <i>y</i> axis.
<code>magnitude_spectrum</code>	Plot the magnitude spectrum.
<code>margins</code>	Set or retrieve autoscaling margins.
<code>matshow</code>	Display an array as a matrix in a new figure window.
<code>minorticks_off</code>	Remove minor ticks from the current plot.
<code>minorticks_on</code>	Display minor ticks on the current plot.
<code>over</code>	
<code>pause</code>	Pause for <i>interval</i> seconds.
<code>pcolor</code>	Create a pseudocolor plot of a 2-D array.
<code>pcolormesh</code>	Plot a quadrilateral mesh.
<code>phase_spectrum</code>	Plot the phase spectrum.
<code>pie</code>	Plot a pie chart.

Table 13.1 – continuu

Function	Description
<code>plot</code>	Plot lines and/or markers to the <i>Axes</i> .
<code>plot_date</code>	A plot with data that contains dates.
<code>plotfile</code>	Plot the data in in a file.
<code>polar</code>	Make a polar plot.
<code>psd</code>	Plot the power spectral density.
<code>quiver</code>	Plot a 2-D field of arrows.
<code>quiverkey</code>	Add a key to a quiver plot.
<code>rc</code>	Set the current rc params.
<code>rc_context</code>	Return a context manager for managing rc settings.
<code>rcdefaults</code>	Restore the rc params from Matplotlib’s internal defaults.
<code>rgrids</code>	Get or set the radial gridlines on a polar plot.
<code>savefig</code>	Save the current figure.
<code>sca</code>	Set the current Axes instance to <i>ax</i> .
<code>scatter</code>	Make a scatter plot of <i>x</i> vs <i>y</i> Marker size is scaled by <i>s</i> and marker color is mapped t
<code>sci</code>	Set the current image.
<code>semilogx</code>	Make a plot with log scaling on the <i>x</i> axis.
<code>semilogy</code>	Make a plot with log scaling on the <i>y</i> axis.
<code>set_cmap</code>	Set the default colormap.
<code>setp</code>	Set a property on an artist object.
<code>show</code>	Display a figure.
<code>specgram</code>	Plot a spectrogram.
<code>spy</code>	Plot the sparsity pattern on a 2-D array.
<code>stackplot</code>	Draws a stacked area plot.
<code>stem</code>	Create a stem plot.
<code>step</code>	Make a step plot.
<code>streamplot</code>	Draws streamlines of a vector flow.
<code>subplot</code>	Return a subplot axes positioned by the given grid definition.
<code>subplot2grid</code>	Create a subplot in a grid.
<code>subplot_tool</code>	Launch a subplot tool window for a figure.
<code>subplots</code>	Create a figure and a set of subplots This utility wrapper makes it convenient to creat
<code>subplots_adjust</code>	Tune the subplot layout.
<code>suptitle</code>	Add a centered title to the figure.
<code>switch_backend</code>	Switch the default backend.
<code>table</code>	Add a table to the current axes.
<code>text</code>	Add text to the axes.
<code>thetagrids</code>	Get or set the theta locations of the gridlines in a polar plot.
<code>tick_params</code>	Change the appearance of ticks and tick labels.
<code>ticklabel_format</code>	Change the <i>ScalarFormatter</i> used by default for linear axes.
<code>tight_layout</code>	Automatically adjust subplot parameters to give specified padding.
<code>title</code>	Set a title of the current axes.
<code>tricontour</code>	Draw contours on an unstructured triangular grid.
<code>tricontourf</code>	Draw contours on an unstructured triangular grid.
<code>tripcolor</code>	Create a pseudocolor plot of an unstructured triangular grid.

Function	Description
<code>triplot</code>	Draw a unstructured triangular grid as lines and/or markers.
<code>twinx</code>	Make a second axes that shares the x -axis.
<code>twiny</code>	Make a second axes that shares the y -axis.
<code>uninstall_repl_displayhook</code>	Uninstalls the matplotlib display hook.
<code>violinplot</code>	Make a violin plot.
<code>vlines</code>	Plot vertical lines.
<code>xcorr</code>	Plot the cross correlation between x and y .
<code>xkcd</code>	Turns on <code>xkcd</code> sketch-style drawing mode.
<code>xlabel</code>	Set the x axis label of the current axis.
<code>xlim</code>	Get or set the x limits of the current axes.
<code>xscale</code>	Set the scaling of the x -axis.
<code>xticks</code>	Get or set the x -limits of the current tick locations and labels.
<code>ylabel</code>	Set the y axis label of the current axis.
<code>ylim</code>	Get or set the y -limits of the current axes.
<code>yscale</code>	Set the scaling of the y -axis.
<code>yticks</code>	Get or set the y -limits of the current tick locations and labels.

matplotlib.pyplot.colormaps()

Matplotlib provides a number of colormaps, and others can be added using `register_cmap()`. This function documents the built-in colormaps, and will also return a list of all registered colormaps if called.

You can set the colormap for an image, pcolor, scatter, etc, using a keyword argument:

```
imshow(X, cmap=cm.hot)
```

or using the `set_cmap()` function:

```
imshow(X)
pyplot.set_cmap('hot')
pyplot.set_cmap('jet')
```

In interactive mode, `set_cmap()` will update the colormap post-hoc, allowing you to see which one works best for your data.

All built-in colormaps can be reversed by appending `_r`: For instance, `gray_r` is the reverse of `gray`.

There are several common color schemes used in visualization:

Sequential schemes for unipolar data that progresses from low to high

Diverging schemes for bipolar data that emphasizes positive or negative deviations from a central value

Cyclic schemes meant for plotting values that wrap around at the endpoints, such as phase angle, wind direction, or time of day

Qualitative schemes for nominal data that has no inherent ordering, where color is used only to distinguish categories

The base colormaps are derived from those of the same name provided with Matlab:

Colormap	Description
autumn	sequential linearly-increasing shades of red-orange-yellow
bone	sequential increasing black-white color map with a tinge of blue, to emulate X-ray film
cool	linearly-decreasing shades of cyan-magenta
copper	sequential increasing shades of black-copper
flag	repetitive red-white-blue-black pattern (not cyclic at endpoints)
gray	sequential linearly-increasing black-to-white grayscale
hot	sequential black-red-yellow-white, to emulate blackbody radiation from an object at increasing temperatures
hsv	cyclic red-yellow-green-cyan-blue-magenta-red, formed by changing the hue component in the HSV color space
inferno	perceptually uniform shades of black-red-yellow
jet	a spectral map with dark endpoints, blue-cyan-yellow-red; based on a fluid-jet simulation by NCSA ¹
magma	perceptually uniform shades of black-red-white
pink	sequential increasing pastel black-pink-white, meant for sepia tone colorization of photographs
plasma	perceptually uniform shades of blue-red-yellow
prism	repetitive red-yellow-green-blue-purple-...-green pattern (not cyclic at endpoints)
spring	linearly-increasing shades of magenta-yellow
summer	sequential linearly-increasing shades of green-yellow
viridis	perceptually uniform shades of blue-green-yellow
winter	linearly-increasing shades of blue-green

For the above list only, you can also set the colormap using the corresponding pylab shortcut interface function, similar to Matlab:

```
imshow(X)
hot()
jet()
```

The next set of palettes are from the [Yorick scientific visualisation package](#), an evolution of the GIST package, both by David H. Munro:

¹ Rainbow colormaps, jet in particular, are considered a poor choice for scientific visualization by many researchers: [Rainbow Color Map \(Still\) Considered Harmful](#)

Colormap	Description
<code>gist_earth</code>	mapmaker's colors from dark blue deep ocean to green lowlands to brown highlands to white mountains
<code>gist_heat</code>	sequential increasing black-red-orange-white, to emulate blackbody radiation from an iron bar as it grows hotter
<code>gist_ncar</code>	pseudo-spectral black-blue-green-yellow-red-purple-white colormap from National Center for Atmospheric Research ²
<code>gist_rainbow</code>	flows through the colors in spectral order from red to violet at full saturation (like <i>hsv</i> but not cyclic)
<code>gist_stern</code>	"Stern special" color table from Interactive Data Language software

The following colormaps are based on the [ColorBrewer](#) color specifications and designs developed by Cynthia Brewer:

ColorBrewer Diverging (luminance is highest at the midpoint, and decreases towards differently-colored endpoints):

Colormap	Description
<code>BrBG</code>	brown, white, blue-green
<code>PiYG</code>	pink, white, yellow-green
<code>PRGn</code>	purple, white, green
<code>PuOr</code>	orange, white, purple
<code>RdBu</code>	red, white, blue
<code>RdGy</code>	red, white, gray
<code>RdYIBu</code>	red, yellow, blue
<code>RdYIGn</code>	red, yellow, green
<code>Spectral</code>	red, orange, yellow, green, blue

ColorBrewer Sequential (luminance decreases monotonically):

² Resembles "BkBlAqGrYeOrReViWh200" from NCAR Command Language. See [Color Table Gallery](#)

Colormap	Description
Blues	white to dark blue
BuGn	white, light blue, dark green
BuPu	white, light blue, dark purple
GnBu	white, light green, dark blue
Greens	white to dark green
Greys	white to black (not linear)
Oranges	white, orange, dark brown
OrRd	white, orange, dark red
PuBu	white, light purple, dark blue
PuBuGn	white, light purple, dark green
PuRd	white, light purple, dark red
Purples	white to dark purple
RdPu	white, pink, dark purple
Reds	white to dark red
YlGn	light yellow, dark green
YlGnBu	light yellow, light green, dark blue
YlOrBr	light yellow, orange, dark brown
YlOrRd	light yellow, orange, dark red

ColorBrewer Qualitative:

(For plotting nominal data, `ListedColormap` is used, not `LinearSegmentedColormap`. Different sets of colors are recommended for different numbers of categories.)

- Accent
- Dark2
- Paired
- Pastel1
- Pastel2
- Set1
- Set2
- Set3

Other miscellaneous schemes:

Colormap	Description
afmhot	sequential black-orange-yellow-white blackbody spectrum, commonly used in atomic force microscopy
brg	blue-red-green
bwr	diverging blue-white-red
coolwarm	diverging blue-gray-red, meant to avoid issues with 3D shading, color blindness, and ordering of colors ³
CMRmap	“Default colormaps on color images often reproduce to confusing grayscale images. The proposed colormap maintains an aesthetically pleasing color image that automatically reproduces to a monotonic grayscale with discrete, quantifiable saturation levels.” ⁴
cubehelix	Unlike most other color schemes cubehelix was designed by D.A. Green to be monotonically increasing in terms of perceived brightness. Also, when printed on a black and white postscript printer, the scheme results in a greyscale with monotonically increasing brightness. This color scheme is named cubehelix because the r,g,b values produced can be visualised as a squashed helix around the diagonal in the r,g,b color cube.
gnuplot	gnuplot’s traditional pm3d scheme (black-blue-red-yellow)
gnuplot2	sequential color printable as gray (black-blue-violet-yellow-white)
ocean	green-blue-white
rainbow	spectral purple-blue-green-yellow-orange-red colormap with diverging luminance
seismic	diverging blue-white-red
nipy_spectral	black-purple-blue-green-yellow-red-white spectrum, originally from the Neuroimaging in Python project
terrain	mapmaker’s colors, blue-green-yellow-brown-white, originally from IGOR Pro

The following colormaps are redundant and may be removed in future versions. It’s recommended to use the names in the descriptions instead, which produce identical output:

Colormap	Description
gist_gray	identical to <i>gray</i>
gist_yarg	identical to <i>gray_r</i>
binary	identical to <i>gray_r</i>
spectral	identical to <i>nipy_spectral</i> ⁵

³ See [Diverging Color Maps for Scientific Visualization](#) by Kenneth Moreland.

⁴ See [A Color Map for Effective Black-and-White Rendering of Color-Scale Images](#) by Carey Rappaport

⁵ Changed to distinguish from ColorBrewer’s *Spectral* map. `spectral()` still works, but `set_cmap('nipy_spectral')` is recommended for clarity.

API CHANGES

Log of changes to Matplotlib that affect the outward-facing API. If updating Matplotlib breaks your scripts, this list may help you figure out what caused the breakage and how to fix it by updating your code.

For new features that were added to Matplotlib, please see *What's new in matplotlib*.

14.1 API Changes in 2.0.1

14.1.1 Extensions to `matplotlib.backend_bases.GraphicsContextBase`

To better support controlling the color of hatches, the method `matplotlib.backend_bases.GraphicsContextBase.set_hatch_color` was added to the expected API of `GraphicsContext` classes. Calls to this method are currently wrapped with a `try:...except AttributeError` block to preserve back-compatibility with any third-party backends which do not extend `GraphicsContextBase`.

This value can be accessed in the backends via `matplotlib.backend_bases.GraphicsContextBase.get_hatch_color` (which was added in 2.0 see *Extension to matplotlib.backend_bases.GraphicsContextBase*) and should be used to color the hatches.

In the future there may also be `hatch_linewidth` and `hatch_density` related methods added. It is encouraged, but not required that third-party backends extend `GraphicsContextBase` to make adapting to these changes easier.

14.1.2 `afm.get_fontconfig_fonts` returns a list of paths and does not check for existence

`afm.get_fontconfig_fonts` used to return a set of paths encoded as a `{key: 1, ...}` dict, and checked for the existence of the paths. It now returns a list and dropped the existence check, as the same check is performed by the caller (`afm.findSystemFonts`) as well.

14.1.3 `bar` now returns rectangles of negative height or width if the corresponding input is negative

`plt.bar` used to normalize the coordinates of the rectangles that it created, to keep their height and width positives, even if the corresponding input was negative. This normalization has been removed to permit a

simpler computation of the correct `sticky_edges` to use.

14.1.4 Do not clip line width when scaling dashes

The algorithm to scale dashes was changed to no longer clip the scaling factor: the dash patterns now continue to shrink at thin line widths. If the line width is smaller than the effective pixel size, this may result in dashed lines turning into solid gray-ish lines. This also required slightly tweaking the default patterns for `'-'`, `'.'`, and `'.-'` so that with the default line width the final patterns would not change.

There is no way to restore the old behavior.

14.1.5 Deprecate 'Vega' color maps

The "Vega" colormaps are deprecated in Matplotlib 2.0.1 and will be removed in Matplotlib 2.2. Use the "tab" colormaps instead: `"tab10"`, `"tab20"`, `"tab20b"`, `"tab20c"`.

14.2 API Changes in 2.0.0

14.2.1 Deprecation and removal

Color of Axes

The `axisbg` and `axis_bgcolor` properties on `Axes` have been deprecated in favor of `facecolor`.

GTK and GDK backends deprecated

The GDK and GTK backends have been deprecated. These obsolete backends allow figures to be rendered via the GDK API to files and GTK2 figures. They are untested and known to be broken, and their use has been discouraged for some time. Instead, use the `GTKAgg` and `GTKCairo` backends for rendering to GTK2 windows.

WX backend deprecated

The WX backend has been deprecated. It is untested, and its use has been discouraged for some time. Instead, use the `WXAgg` backend for rendering figures to WX windows.

CocoaAgg backend removed

The deprecated and not fully functional `CocoaAgg` backend has been removed.

round removed from TkAgg Backend

The TkAgg backend had its own implementation of the `round` function. This was unused internally and has been removed. Instead, use either the `round` builtin function or `numpy.round`.

‘hold’ functionality deprecated

The ‘hold’ keyword argument and all functions and methods related to it are deprecated, along with the ‘axes.hold’ rcParams entry. The behavior will remain consistent with the default `hold=True` state that has long been in place. Instead of using a function or keyword argument (`hold=False`) to change that behavior, explicitly clear the axes or figure as needed prior to subsequent plotting commands.

14.2.2 Artist.update has return value

The methods `matplotlib.artist.Artist.set`, `matplotlib.Artist.update`, and the function `matplotlib.artist.setp` now use a common codepath to look up how to update the given artist properties (either using the setter methods or an attribute/property).

The behavior of `matplotlib.Artist.update` is slightly changed to return a list of the values returned from the setter methods to avoid changing the API of `matplotlib.Artist.set` and `matplotlib.artist.setp`.

The keys passed into `matplotlib.Artist.update` are now converted to lower case before being processed, to match the behavior of `matplotlib.Artist.set` and `matplotlib.artist.setp`. This should not break any user code because there are no set methods with capitals in their names, but this puts a constraint on naming properties in the future.

14.2.3 Legend initializers gain edgcolor and facecolor kwargs

The `Legend` background patch (or ‘frame’) can have its `edgcolor` and `facecolor` determined by the corresponding keyword arguments to the `matplotlib.legend.Legend` initializer, or to any of the methods or functions that call that initializer. If left to their default values of `None`, their values will be taken from `matplotlib.rcParams`. The previously-existing `framealpha` kwarg still controls the alpha transparency of the patch.

14.2.4 Qualitative colormaps

Colorbrewer’s qualitative/discrete colormaps (“Accent”, “Dark2”, “Paired”, “Pastel1”, “Pastel2”, “Set1”, “Set2”, “Set3”) are now implemented as `ListedColormap` instead of `LinearSegmentedColormap`.

To use these for images where categories are specified as integers, for instance, use:

```
plt.imshow(x, cmap='Dark2', norm=colors.NoNorm())
```

14.2.5 Change in the `draw_image` backend API

The `draw_image` method implemented by backends has changed its interface.

This change is only relevant if the backend declares that it is able to transform images by returning `True` from `option_scale_image`. See the `draw_image` docstring for more information.

14.2.6 `matplotlib.ticker.LinearLocator` algorithm update

The `matplotlib.ticker.LinearLocator` is used to define the range and location of axis ticks when the user wants an exact number of ticks. `LinearLocator` thus differs from the default locator `MaxNLocator`, for which the user specifies a maximum number of intervals rather than a precise number of ticks.

The view range algorithm in `matplotlib.ticker.LinearLocator` has been changed so that more convenient tick locations are chosen. The new algorithm returns a plot view range that is a multiple of the user-requested number of ticks. This ensures tick marks will be located at whole integers more consistently. For example, when both y-axes of a “`twinx`” plot use `matplotlib.ticker.LinearLocator` with the same number of ticks, their y-tick locations and grid lines will coincide.

14.2.7 `matplotlib.ticker.LogLocator` gains `numticks` kwarg

The maximum number of ticks generated by the `LogLocator` can now be controlled explicitly via setting the new ‘`numticks`’ kwarg to an integer. By default the kwarg is `None` which internally sets it to the ‘`auto`’ string, triggering a new algorithm for adjusting the maximum according to the axis length relative to the ticklabel font size.

14.2.8 `matplotlib.ticker.LogFormatter`: two new kwargs

Previously, minor ticks on log-scaled axes were not labeled by default. An algorithm has been added to the `LogFormatter` to control the labeling of ticks between integer powers of the base. The algorithm uses two parameters supplied in a kwarg tuple named ‘`minor_thresholds`’. See the docstring for further explanation.

To improve support for axes using `SymmetricLogLocator`, a ‘`linthresh`’ kwarg was added.

14.2.9 New defaults for 3D quiver function in `mpl_toolkits.mplot3d.axes3d.py`

Matplotlib has both a 2D and a 3D quiver function. These changes affect only the 3D function and make the default behavior of the 3D function match the 2D version. There are two changes:

1. The 3D quiver function previously normalized the arrows to be the same length, which makes it unusable for situations where the arrows should be different lengths and does not match the behavior of the 2D function. This normalization behavior is now controlled with the `normalize` keyword, which defaults to `False`.
2. The `pivot` keyword now defaults to `tail` instead of `tip`. This was done in order to match the default behavior of the 2D quiver function.

To obtain the previous behavior with the 3D quiver function, one can call the function with

```
ax.quiver(x, y, z, u, v, w, normalize=True, pivot='tip')
```

where “ax” is an Axes3d object created with something like

```
import mpl_toolkits.mplot3d.axes3d
ax = plt.subplot(111, projection='3d')
```

14.2.10 Stale figure behavior

Attempting to draw the figure will now mark it as not stale (independent if the draw succeeds). This change is to prevent repeatedly trying to re-draw a figure which is raising an error on draw. The previous behavior would only mark a figure as not stale after a full re-draw succeeded.

14.2.11 The spectral colormap is now nipy_spectral

The colormaps formerly known as `spectral` and `spectral_r` have been replaced by `nipy_spectral` and `nipy_spectral_r` since Matplotlib 1.3.0. Even though the colormap was deprecated in Matplotlib 1.3.0, it never raised a warning. As of Matplotlib 2.0.0, using the old names raises a deprecation warning. In the future, using the old names will raise an error.

14.2.12 Default install no longer includes test images

To reduce the size of wheels and source installs, the tests and baseline images are no longer included by default.

To restore installing the tests and images, use a `setup.cfg` with

```
[packages]
tests = True
toolkits_tests = True
```

in the source directory at build/install time.

14.3 Changes in 1.5.3

14.3.1 `ax.plot(..., marker=None)` gives default marker

Prior to 1.5.3 kwargs passed to `plot` were handled in two parts – default kwargs generated internal to `plot` (such as the cycled styles) and user supplied kwargs. The internally generated kwargs were passed to the `matplotlib.lines.Line2D.__init__` and the user kwargs were passed to `ln.set(**kwargs)` to update the artist after it was created. Now both sets of kwargs are merged and passed to `__init__`. This change was made to allow `None` to be passed in via the user kwargs to mean ‘do the default thing’ as is the convention through out `mpl` rather than raising an exception.

Unlike most *Line2D* setter methods `set_marker` did accept `None` as a valid input which was mapped to 'no marker'. Thus, by routing this `marker=None` through `__init__` rather than `set(...)` the meaning of `ax.plot(..., marker=None)` changed from 'no markers' to 'default markers from rcparams'.

This change is only evident if `mpl.rcParams['lines.marker']` has a value other than 'None' (which is string 'None' which means 'no marker').

14.4 Changes in 1.5.2

14.4.1 Default Behavior Changes

Changed default autorange behavior in boxplots

Prior to v1.5.2, the whiskers of boxplots would extend to the minimum and maximum values if the quartiles were all equal (i.e., $Q1 = \text{median} = Q3$). This behavior has been disabled by default to restore consistency with other plotting packages.

To restore the old behavior, simply set `autorange=True` when calling `plt.boxplot`.

14.5 Changes in 1.5.0

14.5.1 Code Changes

Reversed `matplotlib.cbook.ls_mapper`, added `ls_mapper_r`

Formerly, `matplotlib.cbook.ls_mapper` was a dictionary with the long-form line-style names ("solid") as keys and the short forms ("-") as values. This long-to-short mapping is now done by `ls_mapper_r`, and the short-to-long mapping is done by the `ls_mapper`.

Prevent moving artists between Axes, Property-ify `Artist.axes`, deprecate `Artist.{get,set}_axes`

This was done to prevent an Artist that is already associated with an Axes from being moved/added to a different Axes. This was never supported as it causes havoc with the transform stack. The apparent support for this (as it did not raise an exception) was the source of multiple bug reports and questions on SO.

For almost all use-cases, the assignment of the axes to an artist should be taken care of by the axes as part of the `Axes.add_*` method, hence the deprecation of `{get,set}_axes`.

Removing the `set_axes` method will also remove the 'axes' line from the ACCEPTS kwarg tables (assuming that the removal date gets here before that gets overhauled).

Tightened input validation on 'pivot' kwarg to quiver

Tightened validation so that only {'tip', 'tail', 'mid', and 'middle'} (but any capitalization) are valid values for the 'pivot' kwarg in the `Quiver.__init__` (and hence `Axes.quiver` and `plt.quiver` which both

fully delegate to Quiver). Previously any input matching ‘mid.*’ would be interpreted as ‘middle’, ‘tip.*’ as ‘tip’ and any string not matching one of those patterns as ‘tail’.

The value of `Quiver.pivot` is normalized to be in the set {‘tip’, ‘tail’, ‘middle’} in `Quiver.__init__`.

Reordered `Axes.get_children`

The artist order returned by `Axes.get_children` did not match the one used by `Axes.draw`. They now use the same order, as `Axes.draw` now calls `Axes.get_children`.

Changed behaviour of contour plots

The default behaviour of `contour()` and `contourf()` when using a masked array is now determined by the new keyword argument `corner_mask`, or if this is not specified then the new rcParam `contour.corner_mask` instead. The new default behaviour is equivalent to using `corner_mask=True`; the previous behaviour can be obtained using `corner_mask=False` or by changing the rcParam. The example http://matplotlib.org/examples/pylab_examples/contour_corner_mask.html demonstrates the difference. Use of the old contouring algorithm, which is obtained with `corner_mask='legacy'`, is now deprecated.

Contour labels may now appear in different places than in earlier versions of Matplotlib.

In addition, the keyword argument `nchunk` now applies to `contour()` as well as `contourf()`, and it subdivides the domain into subdomains of exactly `nchunk` by `nchunk` quads, whereas previously it was only roughly `nchunk` by `nchunk` quads.

The C/C++ object that performs contour calculations used to be stored in the public attribute `QuadContourSet.Cntr`, but is now stored in a private attribute and should not be accessed by end users.

Added `set_params` function to all Locator types

This was a bug fix targeted at making the api for Locators more consistent.

In the old behavior, only locators of type `MaxNLocator` have `set_params()` defined, causing its use on any other Locator to raise an `AttributeError` (*aside: `set_params(args)` is a function that sets the parameters of a Locator instance to be as specified within args*). The fix involves moving `set_params()` to the `Locator` class such that all subtypes will have this function defined.

Since each of the `Locator` subtypes have their own modifiable parameters, a universal `set_params()` in `Locator` isn’t ideal. Instead, a default no-operation function that raises a warning is implemented in `Locator`. Subtypes extending `Locator` will then override with their own implementations. Subtypes that do not have a need for `set_params()` will fall back onto their parent’s implementation, which raises a warning as intended.

In the new behavior, `Locator` instances will not raise an `AttributeError` when `set_params()` is called. For Locators that do not implement `set_params()`, the default implementation in `Locator` is used.

Disallow `None` as x or y value in `ax.plot`

Do not allow `None` as a valid input for the x or y args in `ax.plot`. This may break some user code, but this was never officially supported (ex documented) and allowing `None` objects through can lead to confusing

exceptions downstream.

To create an empty line use

```
ln1, = ax.plot([], [], ...)  
ln2, = ax.plot([], ...)
```

In either case to update the data in the `Line2D` object you must update both the `x` and `y` data.

Removed args and kwargs from `MicrosecondLocator.__call__`

The call signature of `__call__()` has changed from `__call__(self, *args, **kwargs)` to `__call__(self)`. This is consistent with the superclass `Locator` and also all the other `Locators` derived from this superclass.

No `ValueError` for the `MicrosecondLocator` and `YearLocator`

The `MicrosecondLocator` and `YearLocator` objects when called will return an empty list if the axes have no data or the view has no interval. Previously, they raised a `ValueError`. This is consistent with all the `Date Locators`.

'`OffsetBox.DrawingArea`' respects the 'clip' keyword argument

The call signature was `OffsetBox.DrawingArea(..., clip=True)` but nothing was done with the `clip` argument. The object did not do any clipping regardless of that parameter. Now the object can and does clip the child `Artists` if they are set to be clipped.

You can turn off the clipping on a per-child basis using `child.set_clip_on(False)`.

Add salt to `clipPath` id

Add salt to the hash used to determine the id of the `clipPath` nodes. This is to avoid conflicts when two `svg` documents with the same clip path are included in the same document (see <https://github.com/ipython/ipython/issues/8133> and <https://github.com/matplotlib/matplotlib/issues/4349>), however this means that the `svg` output is no longer deterministic if the same figure is saved twice. It is not expected that this will affect any users as the current ids are generated from an `md5` hash of properties of the clip path and any user would have a very difficult time anticipating the value of the id.

Changed snap threshold for circle markers to `inf`

When drawing circle markers above some marker size (previously 6.0) the path used to generate the marker was snapped to pixel centers. However, this ends up distorting the marker away from a circle. By setting the snap threshold to `inf` snapping is never done on circles.

This change broke several tests, but is an improvement.

Preserve units with Text position

Previously the 'get_position' method on Text would strip away unit information even though the units were still present. There was no inherent need to do this, so it has been changed so that unit data (if present) will be preserved. Essentially a call to 'get_position' will return the exact value from a call to 'set_position'.

If you wish to get the old behaviour, then you can use the new method called 'get_unitless_position'.

New API for custom Axes view changes

Interactive pan and zoom were previously implemented using a Cartesian-specific algorithm that was not necessarily applicable to custom Axes. Three new private methods, `_get_view()`, `_set_view()`, and `_set_view_from_bbox()`, allow for custom Axes classes to override the pan and zoom algorithms. Implementors of custom Axes who override these methods may provide suitable behaviour for both pan and zoom as well as the view navigation buttons on the interactive toolbars.

14.5.2 MathTex visual changes

The spacing commands in mathtext have been changed to more closely match vanilla TeX.

Improved spacing in mathtext

The extra space that appeared after subscripts and superscripts has been removed.

No annotation coordinates wrap

In #2351 for 1.4.0 the behavior of ['axes points', 'axes pixel', 'figure points', 'figure pixel'] as coordinates was change to no longer wrap for negative values. In 1.4.3 this change was reverted for 'axes points' and 'axes pixel' and in addition caused 'axes fraction' to wrap. For 1.5 the behavior has been reverted to as it was in 1.4.0-1.4.2, no wrapping for any type of coordinate.

14.5.3 Deprecation

Deprecated GraphicsContextBase.set_graylevel

The `GraphicsContextBase.set_graylevel` function has been deprecated in 1.5 and will be removed in 1.6. It has been unused. The `GraphicsContextBase.set_foreground` could be used instead.

deprecated idle_event

The `idle_event` was broken or missing in most backends and causes spurious warnings in some cases, and its use in creating animations is now obsolete due to the `animations` module. Therefore code involving it has been removed from all but the `wx` backend (where it partially works), and its use is deprecated. The `animations` module may be used instead to create animations.

color_cycle deprecated

In light of the new property cycling feature, the Axes method `set_color_cycle` is now deprecated. Calling this method will replace the current property cycle with one that cycles just the given colors.

Similarly, the rc parameter `axes.color_cycle` is also deprecated in lieu of the new `axes.prop_cycle` parameter. Having both parameters in the same rc file is not recommended as the result cannot be predicted. For compatibility, setting `axes.color_cycle` will replace the cycler in `axes.prop_cycle` with a color cycle. Accessing `axes.color_cycle` will return just the color portion of the property cycle, if it exists.

Timeline for removal has not been set.

14.5.4 Bundled jquery

The version of jquery bundled with the webagg backend has been upgraded from 1.7.1 to 1.11.3. If you are using the version of jquery bundled with webagg you will need to update your html files as such

```
- <script src="_static/jquery/js/jquery-1.7.1.min.js"></script>
+ <script src="_static/jquery/js/jquery-1.11.3.min.js"></script>
```

14.5.5 Code Removed

Removed Image from main namespace

Image was imported from PIL/pillow to test if PIL is available, but there is no reason to keep Image in the namespace once the availability has been determined.

Removed lod from Artist

Removed the method `set_lod` and all references to the attribute `_lod` as they are not used anywhere else in the code base. It appears to be a feature stub that was never built out.

Removed threading related classes from cbook

The classes Scheduler, Timeout, and Idle were in cbook, but are not used internally. They appear to be a prototype for the idle event system which was not working and has recently been pulled out.

Removed Lena images from sample_data

The `lena.png` and `lena.jpg` images have been removed from Matplotlib's `sample_data` directory. The images are also no longer available from `matplotlib.cbook.get_sample_data`. We suggest using `matplotlib.cbook.get_sample_data('grace_hopper.png')` or `matplotlib.cbook.get_sample_data('grace_hopper.jpg')` instead.

Legend

Removed handling of `loc` as a positional argument to `Legend`

Legend handlers

Remove code to allow legend handlers to be callable. They must now implement a method `legend_artist`.

Axis

Removed method `set_scale`. This is now handled via a private method which should not be used directly by users. It is called via `Axes.set_{x,y}scale` which takes care of ensuring the related changes are also made to the `Axes` object.

finance.py

Removed functions with ambiguous argument order from `finance.py`

Annotation

Removed `textcoords` and `xytext` properties from `Annotation` objects.

spinxext.ipython_*.py

Both `ipython_console_highlighting` and `ipython_directive` have been moved to `IPython`.

Change your import from `'matplotlib.spinxext.ipython_directive'` to `'IPython.spinxext.ipython_directive'` and from `'matplotlib.spinxext.ipython_directive'` to `'IPython.spinxext.ipython_directive'`

LineCollection.color

Deprecated in 2005, use `set_color`

remove 'faceted' as a valid value for shading in tri.tripcolor

Use `edgecolor` instead. Added validation on shading to only be valid values.

Remove faceted kwarg from scatter

Remove support for the `faceted` kwarg. This was deprecated in [d48b34288e9651ff95c3b8a071ef5ac5cf50bae7](#) (2008-04-18!) and replaced by `edgecolor`.

Remove `set_colorbar` method from `ScalarMappable`

Remove `set_colorbar` method, use `colorbar` attribute directly.

`patheffects.svg`

- remove `get_proxy_renderer` method from `AbstractPathEffect` class
- remove `patch_alpha` and `offset_xy` from `SimplePatchShadow`

Remove `testing.image_util.py`

Contained only a no-longer used port of functionality from PIL

Remove `mlab.FIFOBuffer`

Not used internally and not part of core mission of mpl.

Remove `mlab.prepca`

Deprecated in 2009.

Remove `NavigationToolbar2QTAgg`

Added no functionality over the base `NavigationToolbar2Qt`

`mpl.py`

Remove the module `matplotlib.mpl`. Deprecated in 1.3 by PR #1670 and commit `78ce67d161625833cacf23cfe5d74920248c5b2`

14.6 Changes in 1.4.x

14.6.1 Code changes

- A major refactoring of the axes module was made. The axes module has been split into smaller modules:
 - the `_base` module, which contains a new private `_AxesBase` class. This class contains all methods except plotting and labelling methods.
 - the `axes` module, which contains the `Axes` class. This class inherits from `_AxesBase`, and contains all plotting and labelling methods.

- the `_subplot` module, with all the classes concerning subplotting.

There are a couple of things that do not exist in the `axes` module's namespace anymore. If you use them, you need to import them from their original location:

- `math` -> `import math`
- `ma` -> `from numpy import ma`
- `cbook` -> `from matplotlib import cbook`
- `docstring` -> `from matplotlib import docstring`
- `is_sequence_of_strings` -> `from matplotlib.cbook import is_sequence_of_strings`
- `is_string_like` -> `from matplotlib.cbook import is_string_like`
- `iterable` -> `from matplotlib.cbook import iterable`
- `itertools` -> `import itertools`
- `matplotlib` -> `from matplotlib import artist as matplotlib`
- `matplotlib` -> `import matplotlib`
- `mcoll` -> `from matplotlib import collections as mcoll`
- `mcolors` -> `from matplotlib import colors as mcolors`
- `mcontour` -> `from matplotlib import contour as mcontour`
- `mpatches` -> `from matplotlib import patches as mpatches`
- `mpath` -> `from matplotlib import path as mpath`
- `mquiver` -> `from matplotlib import quiver as mquiver`
- `mstack` -> `from matplotlib import stack as mstack`
- `mstream` -> `from matplotlib import stream as mstream`
- `mtable` -> `from matplotlib import table as mtable`
- As part of the refactoring to enable Qt5 support, the module `matplotlib.backends.qt4_compat` was renamed to `matplotlib.qt_compat`. `qt4_compat` is deprecated in 1.4 and will be removed in 1.5.
- The `errorbar()` method has been changed such that the upper and lower limits (`lolims`, `uplims`, `xlolims`, `xuplims`) now point in the correct direction.
- The `fmt` kwarg for `plot()` defaults.
- A bug has been fixed in the path effects rendering of fonts, which now means that the font size is consistent with non-path effect fonts. See <https://github.com/matplotlib/matplotlib/issues/2889> for more detail.
- The Sphinx extensions `ipython_directive` and `ipython_console_highlighting` have been moved to the IPython project itself. While they remain in Matplotlib for this release, they have been deprecated. Update your extensions in `conf.py` to point to `IPython.sphinxext.ipython_directive` instead of `matplotlib.sphinxext.ipython_directive`.

- In *finance*, almost all functions have been deprecated and replaced with a pair of functions name *_ochl and *_ohl. The former is the ‘open-close-high-low’ order of quotes used previously in this module, and the latter is the ‘open-high-low-close’ order that is standard in finance.
- For consistency the `face_alpha` keyword to `matplotlib.patheffects.SimplePatchShadow` has been deprecated in favour of the `alpha` keyword. Similarly, the keyword `offset_xy` is now named `offset` across all `_Base`` has been renamed to `matplotlib.patheffects.AbstractPathEffect`. `matplotlib.patheffect.ProxyRenderer` has been renamed to `matplotlib.patheffects.PathEffectRenderer` and is now a full `RendererBase` subclass.
- The artist used to draw the outline of a colorbar has been changed from a `matplotlib.lines.Line2D` to `matplotlib.patches.Polygon`, thus `colorbar.ColorbarBase.outline` is now a `matplotlib.patches.Polygon` object.
- The legend handler interface has changed from a callable, to any object which implements the `legend_artists` method (a deprecation phase will see this interface be maintained for v1.4). See *Legend guide* for further details. Further legend changes include:
 - `matplotlib.axes.Axes._get_legend_handles()` now returns a generator of handles, rather than a list.
 - The `legend()` function’s “loc” positional argument has been deprecated. Use the “loc” keyword instead.
- The rcParams `savefig.transparent` has been added to control default transparency when saving figures.
- Slightly refactored the `Annotation` family. The text location in `Annotation` is now handled entirely handled by the underlying `Text` object so `set_position` works as expected. The attributes `xytext` and `textcoords` have been deprecated in favor of `xyann` and `anncoords` so that `Annotation` and `AnnotationBbox` can share a common sensibly named api for getting/setting the location of the text or box.
 - `xyann` -> set the location of the annotation
 - `xy` -> set where the arrow points to
 - `anncoords` -> set the units of the annotation location
 - `xycoords` -> set the units of the point location
 - `set_position()` -> `Annotation` only set location of annotation
- `matplotlib.mlab.specgram`, `matplotlib.mlab.psd`, `matplotlib.mlab.csd`, `matplotlib.mlab.cohere`, `matplotlib.mlab.cohere_pairs`, `matplotlib.pyplot.specgram`, `matplotlib.pyplot.psd`, `matplotlib.pyplot.csd`, and `matplotlib.pyplot.cohere` now raise `ValueError` where they previously raised `AssertionError`.
- For `matplotlib.mlab.psd`, `matplotlib.mlab.csd`, `matplotlib.mlab.cohere`, `matplotlib.mlab.cohere_pairs`, `matplotlib.pyplot.specgram`, `matplotlib.pyplot.psd`, `matplotlib.pyplot.csd`, and `matplotlib.pyplot.cohere`, in cases where a shape `(n, 1)` array is returned, this is now converted to a `(n,)` array. Previously, `(n, m)` arrays were averaged to an `(n,)` array, but `(n, 1)` arrays were returned unchanged. This change makes the dimensions consistent in both cases.

- Added the rcParam `axes.formatter.useoffset` to control the default value of `useOffset` in `ticker.ScalarFormatter`
- Added `Formatter` sub-class `StrMethodFormatter` which does the exact same thing as `FormatStrFormatter`, but for new-style formatting strings.
- Deprecated `matplotlib.testing.image_util` and the only function within, `matplotlib.testing.image_util.autocontrast`. These will be removed completely in v1.5.0.
- The `fmt` argument of `plot_date()` has been changed from `bo` to just `o`, so color cycling can happen by default.
- Removed the class `FigureManagerQTAgg` and deprecated `NavigationToolbar2QTAgg` which will be removed in 1.5.
- Removed formerly public (non-prefixed) attributes `rect` and `drawRect` from `FigureCanvasQTAgg`; they were always an implementation detail of the (preserved) `drawRectangle()` function.
- The function signatures of `tight_bbox.adjust_bbox` and `tight_bbox.process_figure_for_rasterizing` have been changed. A new `fixed_dpi` parameter allows for overriding the `figure.dpi` setting instead of trying to deduce the intended behaviour from the file format.
- Added support for horizontal/vertical axes padding to `mpl_toolkits.axes_grid1.ImageGrid` — argument `axes_pad` can now be tuple-like if separate axis padding is required. The original behavior is preserved.
- Added support for skewed transforms to `matplotlib.transforms.Affine2D`, which can be created using the `skew` and `skew_deg` methods.
- Added clockwise parameter to control sectors direction in `axes.pie`
- In `matplotlib.lines.Line2D` the `markevery` functionality has been extended. Previously an integer start-index and stride-length could be specified using either a two-element-list or a two-element-tuple. Now this can only be done using a two-element-tuple. If a two-element-list is used then it will be treated as numpy fancy indexing and only the two markers corresponding to the given indexes will be shown.
- removed prop kwarg from `mpl_toolkits.axes_grid1.anchored_artists.AnchoredSizeBar` call. It was passed through to the base-class `__init__` and is only used for setting padding. Now `fontproperties` (which is what is really used to set the font properties of `AnchoredSizeBar`) is passed through in place of `prop`. If `fontproperties` is not passed in, but `prop` is, then `prop` is used in place of `fontproperties`. If both are passed in, `prop` is silently ignored.
- The use of the index 0 in `plt.subplot` and related commands is deprecated. Due to a lack of validation calling `plt.subplots(2, 2, 0)` does not raise an exception, but puts an axes in the `_last_` position. This is due to the indexing in subplot being 1-based (to mirror MATLAB) so before indexing into the `GridSpec` object used to determine where the axes should go, 1 is subtracted off. Passing in 0 results in passing -1 to `GridSpec` which results in getting the last position back. Even though this behavior is clearly wrong and not intended, we are going through a deprecation cycle in an abundance of caution that any users are exploiting this ‘feature’. The use of 0 as an index will raise a warning in 1.4 and an exception in 1.5.
- Clipping is now off by default on offset boxes.

- Matplotlib now uses a less-aggressive call to `gc.collect(1)` when closing figures to avoid major delays with large numbers of user objects in memory.
- The default clip value of *all* pie artists now defaults to `False`.

14.6.2 Code removal

- Removed `mlab.levypdf`. The code raised a numpy error (and has for a long time) and was not the standard form of the Levy distribution. `scipy.stats.levy` should be used instead

14.7 Changes in 1.3.x

14.7.1 Changes in 1.3.1

It is rare that we make an API change in a bugfix release, however, for 1.3.1 since 1.3.0 the following change was made:

- `text.Text.cached` (used to cache font objects) has been made into a private variable. Among the obvious encapsulation benefit, this removes this confusing-looking member from the documentation.
- The method `hist()` now always returns bin occupancies as an array of type `float`. Previously, it was sometimes an array of type `int`, depending on the call.

14.7.2 Code removal

- The following items that were deprecated in version 1.2 or earlier have now been removed completely.
 - The Qt 3.x backends (`qt` and `qtagg`) have been removed in favor of the Qt 4.x backends (`qt4` and `qt4agg`).
 - The `FltkAgg` and `Emf` backends have been removed.
 - The `matplotlib.nxutils` module has been removed. Use the functionality on `matplotlib.path.Path.contains_point` and friends instead.
 - Instead of `axes.Axes.get_frame`, use `axes.Axes.patch`.
 - The following kwargs to the legend function have been renamed:
 - * `pad` -> `borderpad`
 - * `labelsep` -> `labelspacing`
 - * `handlelen` -> `handlelength`
 - * `handletextsep` -> `handletextpad`
 - * `axespad` -> `borderaxespad`

Related to this, the following rcParams have been removed:

- * `legend.pad`, `legend.labelsep`, `legend.handlelen`, `legend.handletextsep` and `legend.axespad`
- For the `hist` function, instead of `width`, use `rwidth` (relative width).
- On `patches.Circle`, the `resolution` kwarg has been removed. For a circle made up of line segments, use `patches.CirclePolygon`.
- The printing functions in the `Wx` backend have been removed due to the burden of keeping them up-to-date.
- `mlab.liaupunov` has been removed.
- `mlab.save`, `mlab.load`, `pylab.save` and `pylab.load` have been removed. We recommend using `numpy.savetxt` and `numpy.loadtxt` instead.
- `widgets.HorizontalSpanSelector` has been removed. Use `widgets.SpanSelector` instead.

14.7.3 Code deprecation

- The `CocoaAgg` backend has been deprecated, with the possibility for deletion or resurrection in a future release.
- The top-level functions in `matplotlib.path` that are implemented in C++ were never meant to be public. Instead, users should use the Pythonic wrappers for them in the `path.Path` and `collections.Collection` classes. Use the following mapping to update your code:
 - `point_in_path` -> `path.Path.contains_point`
 - `get_path_extents` -> `path.Path.get_extents`
 - `point_in_path_collection` -> `collection.Collection.contains`
 - `path_in_path` -> `path.Path.contains_path`
 - `path_intersects_path` -> `path.Path.intersects_path`
 - `convert_path_to_polygons` -> `path.Path.to_polygons`
 - `cleanup_path` -> `path.Path.cleaned`
 - `points_in_path` -> `path.Path.contains_points`
 - `clip_path_to_rect` -> `path.Path.clip_to_bbox`
- `matplotlib.colors.normalize` and `matplotlib.colors.no_norm` have been deprecated in favour of `matplotlib.colors.Normalize` and `matplotlib.colors.NoNorm` respectively.
- The `ScalarMappable` class' `set_colorbar` is now deprecated. Instead, the `matplotlib.cm.ScalarMappable.colorbar` attribute should be used. In previous Matplotlib versions this attribute was an undocumented tuple of (`colorbar_instance`, `colorbar_axes`) but is now just `colorbar_instance`. To get the colorbar axes it is possible to just use the `ax` attribute on a colorbar instance.

- The `mpl` module is now deprecated. Those who relied on this module should transition to simply using `import matplotlib as mpl`.

14.7.4 Code changes

- `Patch` now fully supports using RGBA values for its `facecolor` and `edgecolor` attributes, which enables faces and edges to have different alpha values. If the `Patch` object's `alpha` attribute is set to anything other than `None`, that value will override any alpha-channel value in both the face and edge colors. Previously, if `Patch` had `alpha=None`, the alpha component of `edgecolor` would be applied to both the edge and face.
- The optional `isRGB` argument to `set_foreground()` (and the other `GraphicsContext` classes that descend from it) has been renamed to `isRGBA`, and should now only be set to `True` if the `fg` color argument is known to be an RGBA tuple.
- For `Patch`, the `capstyle` used is now `butt`, to be consistent with the default for most other objects, and to avoid problems with non-solid `linestyle` appearing solid when using a large `linewidth`. Previously, `Patch` used `capstyle='projecting'`.
- Path objects can now be marked as `readonly` by passing `readonly=True` to its constructor. The built-in path singletons, obtained through `Path.unit*` class methods return `readonly` paths. If you have code that modified these, you will need to make a `deepcopy` first, using either:

```
import copy
path = copy.deepcopy(Path.unit_circle())

# or

path = Path.unit_circle().deepcopy()
```

Deep copying a `Path` always creates an `editable` (i.e. non-`readonly`) `Path`.

- The list at `Path.NUM_VERTICES` was replaced by a dictionary mapping Path codes to the number of expected vertices at `NUM_VERTICES_FOR_CODE`.
- To support XKCD style plots, the `matplotlib.path.cleanup_path()` method's signature was updated to require a `sketch` argument. Users of `matplotlib.path.cleanup_path()` are encouraged to use the new `cleaned()` `Path` method.
- Data limits on a plot now start from a state of having “null” limits, rather than limits in the range (0, 1). This has an effect on artists that only control limits in one direction, such as `axvline` and `axhline`, since their limits will not longer also include the range (0, 1). This fixes some problems where the computed limits would be dependent on the order in which artists were added to the axes.
- Fixed a bug in setting the position for the right/top spine with `data` position type. Previously, it would draw the right or top spine at +1 data offset.
- In `FancyArrow`, the default arrow head width, `head_width`, has been made larger to produce a visible arrow head. The new value of this kwarg is `head_width = 20 * width`.
- It is now possible to provide `number of levels + 1` colors in the case of `extend='both'` for `contourf` (or just `number of levels` colors for an `extend` value `min` or `max`) such that the resulting

colormap's `set_under` and `set_over` are defined appropriately. Any other number of colors will continue to behave as before (if more colors are provided than levels, the colors will be unused). A similar change has been applied to `contour`, where `extend='both'` would expect number of levels + 2 colors.

- A new keyword `extendrect` in `colorbar()` and `ColorbarBase` allows one to control the shape of colorbar extensions.
- The extension of `MultiCursor` to both vertical (default) and/or horizontal cursor implied that `self.line` is replaced by `self.vline` for vertical cursors lines and `self.hline` is added for the horizontal cursors lines.
- On POSIX platforms, the `report_memory()` function raises `NotImplementedError` instead of `OSError` if the `ps` command cannot be run.
- The `matplotlib.cbook.check_output()` function has been moved to `matplotlib.compat.subprocess()`.

14.7.5 Configuration and rcParams

- On Linux, the user-specific `matplotlibrc` configuration file is now located in `config/matplotlib/matplotlibrc` to conform to the [XDG Base Directory Specification](#).
- The `font.*` rcParams now affect only text objects created after the rcParam has been set, and will not retroactively affect already existing text objects. This brings their behavior in line with most other rcParams.
- Removed call of `grid()` in `plotfile()`. To draw the axes grid, set the `axes.grid` rcParam to `True`, or explicitly call `grid()`.

14.8 Changes in 1.2.x

- The classic option of the rc parameter `toolbar` is deprecated and will be removed in the next release.
- The `isvector()` method has been removed since it is no longer functional.
- The `rasterization_zorder` property on `Axes` a zorder below which artists are rasterized. This has defaulted to `-30000.0`, but it now defaults to `None`, meaning no artists will be rasterized. In order to rasterize artists below a given zorder value, `set_rasterization_zorder` must be explicitly called.
- In `scatter()`, and `scatter`, when specifying a marker using a tuple, the angle is now specified in degrees, not radians.
- Using `twinx()` or `twiny()` no longer overrides the current locaters and formatters on the axes.
- In `contourf()`, the handling of the `extend` kwarg has changed. Formerly, the extended ranges were mapped after to 0, 1 after being normed, so that they always corresponded to the extreme values of the colormap. Now they are mapped outside this range so that they correspond to the special colormap values determined by the `set_under()` and `set_over()` methods, which default to the colormap end points.

- The new rc parameter `savefig.format` replaces `cairo.format` and `savefig.extension`, and sets the default file format used by `matplotlib.figure.Figure.savefig()`.
- In `pie()` and `pie()`, one can now set the radius of the pie; setting the `radius` to 'None' (the default value), will result in a pie with a radius of 1 as before.
- Use of `projection_factory()` is now deprecated in favour of axes class identification using `process_projection_requirements()` followed by direct axes class invocation (at the time of writing, functions which do this are: `add_axes()`, `add_subplot()` and `gca()`). Therefore:

```

key = figure._make_key(*args, **kwargs)
ispolar = kwargs.pop('polar', False)
projection = kwargs.pop('projection', None)
if ispolar:
    if projection is not None and projection != 'polar':
        raise ValueError('polar and projection args are inconsistent')
    projection = 'polar'
ax = projection_factory(projection, self, rect, **kwargs)
key = self._make_key(*args, **kwargs)

# is now

projection_class, kwargs, key = \
    process_projection_requirements(self, *args, **kwargs)
ax = projection_class(self, rect, **kwargs)

```

This change means that third party objects can expose themselves as Matplotlib axes by providing a `_as_mpl_axes` method. See *Developer's guide for creating scales and transformations* for more detail.

- A new keyword `extendfrac` in `colorbar()` and `ColorbarBase` allows one to control the size of the triangular minimum and maximum extensions on colorbars.
- A new keyword `capthick` in `errorbar()` has been added as an intuitive alias to the `markeredgewidth` and `mew` keyword arguments, which indirectly controlled the thickness of the caps on the errorbars. For backwards compatibility, specifying either of the original keyword arguments will override any value provided by `capthick`.
- Transform subclassing behaviour is now subtly changed. If your transform implements a non-affine transformation, then it should override the `transform_non_affine` method, rather than the generic `transform` method. Previously transforms would define `transform` and then copy the method into `transform_non_affine`:

```

class MyTransform(mtrans.Transform):
    def transform(self, xy):
        ...
        transform_non_affine = transform

```

This approach will no longer function correctly and should be changed to:

```

class MyTransform(mtrans.Transform):
    def transform_non_affine(self, xy):
        ...

```

- Artists no longer have `x_isdata` or `y_isdata` attributes; instead any artist's transform can be interrogated with `artist_instance.get_transform().contains_branch(ax.transData)`
- Lines added to an axes now take into account their transform when updating the data and view limits. This means transforms can now be used as a pre-transform. For instance:

```
>>> import matplotlib.pyplot as plt
>>> import matplotlib.transforms as mtrans
>>> ax = plt.axes()
>>> ax.plot(range(10), transform=mtrans.Affine2D().scale(10) + ax.transData)
>>> print(ax.viewLim)
Bbox('array([[ 0.,  0.],\n          [ 90.,  90.]])')
```

- One can now easily get a transform which goes from one transform's coordinate system to another, in an optimized way, using the new subtract method on a transform. For instance, to go from data coordinates to axes coordinates:

```
>>> import matplotlib.pyplot as plt
>>> ax = plt.axes()
>>> data2ax = ax.transData - ax.transAxes
>>> print(ax.transData.depth, ax.transAxes.depth)
3, 1
>>> print(data2ax.depth)
2
```

for versions before 1.2 this could only be achieved in a sub-optimal way, using `ax.transData + ax.transAxes.inverted()` (depth is a new concept, but had it existed it would return 4 for this example).

- `twinx` and `twiny` now returns an instance of `SubplotBase` if parent axes is an instance of `SubplotBase`.
- All Qt3-based backends are now deprecated due to the lack of py3k bindings. Qt and QtAgg backends will continue to work in v1.2.x for py2.6 and py2.7. It is anticipated that the Qt3 support will be completely removed for the next release.
- `ColorConverter`, `Colormap` and `Normalize` now subclasses `object`
- `ContourSet` instances no longer have a `transform` attribute. Instead, access the transform with the `get_transform` method.

14.9 Changes in 1.1.x

- Added new `matplotlib.sankey.Sankey` for generating Sankey diagrams.
- In `imshow()`, setting `interpolation` to 'nearest' will now always mean that the nearest-neighbor interpolation is performed. If you want the no-op interpolation to be performed, choose 'none'.
- There were errors in how the tri-functions were handling input parameters that had to be fixed. If your tri-plots are not working correctly anymore, or you were working around apparent mistakes, please see issue #203 in the github tracker. When in doubt, use kwargs.

- The ‘symlog’ scale had some bad behavior in previous versions. This has now been fixed and users should now be able to use it without frustrations. The fixes did result in some minor changes in appearance for some users who may have been depending on the bad behavior.
- There is now a common set of markers for all plotting functions. Previously, some markers existed only for `scatter()` or just for `plot()`. This is now no longer the case. This merge did result in a conflict. The string ‘d’ now means “thin diamond” while ‘D’ will mean “regular diamond”.

14.10 Changes beyond 0.99.x

- The default behavior of `matplotlib.axes.Axes.set_xlim()`, `matplotlib.axes.Axes.set_ylim()`, and `matplotlib.axes.Axes.axis()`, and their corresponding pyplot functions, has been changed: when view limits are set explicitly with one of these methods, autoscaling is turned off for the matching axis. A new `auto` kwarg is available to control this behavior. The limit kwargs have been renamed to `left` and `right` instead of `xmin` and `xmax`, and `bottom` and `top` instead of `ymin` and `ymax`. The old names may still be used, however.
- There are five new Axes methods with corresponding pyplot functions to facilitate autoscaling, tick location, and tick label formatting, and the general appearance of ticks and tick labels:
 - `matplotlib.axes.Axes.autoscale()` turns autoscaling on or off, and applies it.
 - `matplotlib.axes.Axes.margins()` sets margins used to autoscale the `matplotlib.axes.Axes.viewLim` based on the `matplotlib.axes.Axes.dataLim`.
 - `matplotlib.axes.Axes.locator_params()` allows one to adjust axes locator parameters such as `nbins`.
 - `matplotlib.axes.Axes.ticklabel_format()` is a convenience method for controlling the `matplotlib.ticker.ScalarFormatter` that is used by default with linear axes.
 - `matplotlib.axes.Axes.tick_params()` controls direction, size, visibility, and color of ticks and their labels.
- The `matplotlib.axes.Axes.bar()` method accepts a `error_kw` kwarg; it is a dictionary of kwargs to be passed to the errorbar function.
- The `matplotlib.axes.Axes.hist()` `color` kwarg now accepts a sequence of color specs to match a sequence of datasets.
- The `EllipseCollection` has been changed in two ways:
 - There is a new `units` option, ‘xy’, that scales the ellipse with the data units. This matches the `:class:~matplotlib.patches.Ellipse` scaling.
 - The `height` and `width` kwargs have been changed to specify the height and width, again for consistency with `Ellipse`, and to better match their names; previously they specified the half-height and half-width.
- There is a new rc parameter `axes.color_cycle`, and the color cycle is now independent of the rc parameter `lines.color`. `matplotlib.Axes.set_default_color_cycle()` is deprecated.

- You can now print several figures to one pdf file and modify the document information dictionary of a pdf file. See the docstrings of the class `matplotlib.backends.backend_pdf.PdfPages` for more information.
- Removed `configobj` and `enthought.traits` packages, which are only required by the experimental traitled config and are somewhat out of date. If needed, install them independently.
- The new rc parameter `savefig.extension` sets the filename extension that is used by `matplotlib.figure.Figure.savefig()` if its `fname` argument lacks an extension.
- In an effort to simplify the backend API, all clipping rectangles and paths are now passed in using GraphicsContext objects, even on collections and images. Therefore:

```

draw_path_collection(self, master_transform, cliprect, clippath,
                    clippath_trans, paths, all_transforms, offsets,
                    offsetTrans, facecolors, edgcolors, linewidths,
                    linestyles, antialiaseds, urls)

# is now

draw_path_collection(self, gc, master_transform, paths, all_transforms,
                    offsets, offsetTrans, facecolors, edgcolors,
                    linewidths, linestyles, antialiaseds, urls)

draw_quad_mesh(self, master_transform, cliprect, clippath,
               clippath_trans, meshWidth, meshHeight, coordinates,
               offsets, offsetTrans, facecolors, antialiased,
               showedges)

# is now

draw_quad_mesh(self, gc, master_transform, meshWidth, meshHeight,
               coordinates, offsets, offsetTrans, facecolors,
               antialiased, showedges)

draw_image(self, x, y, im, bbox, clippath=None, clippath_trans=None)

# is now

draw_image(self, gc, x, y, im)

```

- There are four new Axes methods with corresponding pyplot functions that deal with unstructured triangular grids:
 - `matplotlib.axes.Axes.tricontour()` draws contour lines on a triangular grid.
 - `matplotlib.axes.Axes.tricontourf()` draws filled contours on a triangular grid.
 - `matplotlib.axes.Axes.tripcolor()` draws a pseudocolor plot on a triangular grid.
 - `matplotlib.axes.Axes.triplot()` draws a triangular grid as lines and/or markers.

14.11 Changes in 0.99

- `pylab` no longer provides a load and save function. These are available in `matplotlib.mlab`, or you can use `numpy.loadtxt` and `numpy.savetxt` for text files, or `np.save` and `np.load` for binary numpy arrays.
- User-generated colormaps can now be added to the set recognized by `matplotlib.cm.get_cmap()`. Colormaps can be made the default and applied to the current image using `matplotlib.pyplot.set_cmap()`.
- changed `use_mrecords` default to `False` in `mlab.csv2rec` since this is partially broken
- Axes instances no longer have a “frame” attribute. Instead, use the new “spines” attribute. Spines is a dictionary where the keys are the names of the spines (e.g., ‘left’, ‘right’ and so on) and the values are the artists that draw the spines. For normal (rectilinear) axes, these artists are `Line2D` instances. For other axes (such as polar axes), these artists may be `Patch` instances.
- Polar plots no longer accept a resolution kwarg. Instead, each `Path` must specify its own number of interpolation steps. This is unlikely to be a user-visible change – if interpolation of data is required, that should be done before passing it to `Matplotlib`.

14.12 Changes for 0.98.x

- `psd()`, `csd()`, and `cohere()` will now automatically wrap negative frequency components to the beginning of the returned arrays. This is much more sensible behavior and makes them consistent with `specgram()`. The previous behavior was more of an oversight than a design decision.
- Added new keyword parameters `nonposx`, `nonposy` to `matplotlib.axes.Axes` methods that set log scale parameters. The default is still to mask out non-positive values, but the kwargs accept ‘clip’, which causes non-positive values to be replaced with a very small positive value.
- Added new `matplotlib.pyplot.fignum_exists()` and `matplotlib.pyplot.get_fignums()`; they merely expose information that had been hidden in `matplotlib._pylab_helpers`.
- Deprecated `numerix` package.
- Added new `matplotlib.image.imsave()` and exposed it to the `matplotlib.pyplot` interface.
- Remove support for `pyExcelerator` in `exceltools` – use `xlwt` instead
- Changed the defaults of `acorr` and `xcorr` to use `usevlines=True`, `maxlags=10` and `normed=True` since these are the best defaults
- Following keyword parameters for `matplotlib.label.Label` are now deprecated and new set of parameters are introduced. The new parameters are given as a fraction of the font-size. Also, `scatteryoffsets`, `fancybox` and `columnspacing` are added as keyword parameters.

Deprecated	New
<code>pad</code>	<code>borderpad</code>
<code>labelsep</code>	<code>labelspacing</code>
<code>handlelen</code>	<code>handlelength</code>
<code>handletextsep</code>	<code>handletextpad</code>
<code>axespad</code>	<code>borderaxespad</code>

- Removed the `configobj` and experimental traits `rc` support
- Modified `matplotlib.mlab.psd()`, `matplotlib.mlab.csd()`, `matplotlib.mlab.cohere()`, and `matplotlib.mlab.specgram()` to scale one-sided densities by a factor of 2. Also, optionally scale the densities by the sampling frequency, which gives true values of densities that can be integrated by the returned frequency values. This also gives better MATLAB compatibility. The corresponding `matplotlib.axes.Axes` methods and `matplotlib.pyplot` functions were updated as well.
- Font lookup now uses a nearest-neighbor approach rather than an exact match. Some fonts may be different in plots, but should be closer to what was requested.
- `matplotlib.axes.Axes.set_xlim()`, `matplotlib.axes.Axes.set_ylim()` now return a copy of the `viewlim` array to avoid modify-in-place surprises.
- `matplotlib.afm.AFM.get_fullname()` and `matplotlib.afm.AFM.get_familyname()` no longer raise an exception if the AFM file does not specify these optional attributes, but returns a guess based on the required `FontName` attribute.
- Changed precision kwarg in `matplotlib.pyplot.spy()`; default is 0, and the string value 'present' is used for sparse arrays only to show filled locations.
- `matplotlib.collections.EllipseCollection` added.
- Added angles kwarg to `matplotlib.pyplot.quiver()` for more flexible specification of the arrow angles.
- Deprecated (raise `NotImplementedError`) all the `mlab2` functions from `matplotlib.mlab` out of concern that some of them were not clean room implementations.
- Methods `matplotlib.collections.Collection.get_offsets()` and `matplotlib.collections.Collection.set_offsets()` added to `Collection` base class.
- `matplotlib.figure.Figure.figurePatch` renamed `matplotlib.figure.Figure.patch`; `matplotlib.axes.Axes.axesPatch` renamed `matplotlib.axes.Axes.patch`; `matplotlib.axes.Axes.axesFrame` renamed `matplotlib.axes.Axes.frame`. `matplotlib.axes.Axes.get_frame()`, which returns `matplotlib.axes.Axes.patch`, is deprecated.
- Changes in the `matplotlib.contour.ContourLabeler` attributes (`matplotlib.pyplot.clabel()` function) so that they all have a form like `.labelAttribute`. The three attributes that are most likely to be used by end users, `.cl`, `.cl_xy` and `.cl_cvalues` have been maintained for the moment (in addition to their renamed versions), but they are deprecated and will eventually be removed.
- Moved several functions in `matplotlib.mlab` and `matplotlib.cbook` into a separate module `matplotlib.numerical_methods` because they were unrelated to the initial purpose of `mlab` or `cbook` and appeared more coherent elsewhere.

14.13 Changes for 0.98.1

- Removed broken `matplotlib.axes3d` support and replaced it with a non-implemented error pointing to 0.91.x

14.14 Changes for 0.98.0

- `matplotlib.image.imread()` now no longer always returns RGBA data—if the image is luminance or RGB, it will return a MxN or MxNx3 array if possible. Also `uint8` is no longer always forced to float.
- Rewrote the `matplotlib.cm.ScalarMappable` callback infrastructure to use `matplotlib.colorbar.CallbackRegistry` rather than custom callback handling. Any users of `matplotlib.cm.ScalarMappable.add_observer()` of the `ScalarMappable` should use the `matplotlib.cm.ScalarMappable.callbacks` `CallbackRegistry` instead.
- New axes function and Axes method provide control over the plot color cycle: `matplotlib.axes.set_default_color_cycle()` and `matplotlib.axes.Axes.set_color_cycle()`.
- Matplotlib now requires Python 2.4, so `matplotlib.colorbar` will no longer provide `set`, `enumerate()`, `reversed()` or `izip()` compatibility functions.
- In Numpy 1.0, bins are specified by the left edges only. The axes method `matplotlib.axes.Axes.hist()` now uses future Numpy 1.3 semantics for histograms. Providing `binedges`, the last value gives the upper-right edge now, which was implicitly set to +infinity in Numpy 1.0. This also means that the last bin doesn't contain upper outliers any more by default.
- New axes method and pyplot function, `hexbin()`, is an alternative to `scatter()` for large datasets. It makes something like a `pcolor()` of a 2-D histogram, but uses hexagonal bins.
- New kwarg, `symmetric`, in `matplotlib.ticker.MaxNLocator` allows one require an axis to be centered around zero.
- Toolkits must now be imported from `mpl_toolkits` (not `matplotlib.toolkits`)

14.14.1 Notes about the transforms refactoring

A major new feature of the 0.98 series is a more flexible and extensible transformation infrastructure, written in Python/Numpy rather than a custom C extension.

The primary goal of this refactoring was to make it easier to extend matplotlib to support new kinds of projections. This is mostly an internal improvement, and the possible user-visible changes it allows are yet to come.

See `matplotlib.transforms` for a description of the design of the new transformation framework.

For efficiency, many of these functions return views into Numpy arrays. This means that if you hold on to a reference to them, their contents may change. If you want to store a snapshot of their current values, use the Numpy array method `copy()`.

The view intervals are now stored only in one place – in the `matplotlib.axes.Axes` instance, not in the locator instances as well. This means locators must get their limits from their `matplotlib.axis.Axis`, which in turn looks up its limits from the `Axes`. If a locator is used temporarily and not assigned to an Axis or Axes, (e.g., in `matplotlib.contour`), a dummy axis must be created to store its bounds. Call `matplotlib.ticker.Locator.create_dummy_axis()` to do so.

The functionality of `Pbox` has been merged with `Bbox`. Its methods now all return copies rather than modifying in place.

The following lists many of the simple changes necessary to update code from the old transformation framework to the new one. In particular, methods that return a copy are named with a verb in the past tense, whereas methods that alter an object in place are named with a verb in the present tense.

matplotlib.transforms

Old method	New method
Bbox.get_bounds()	transforms.Bbox.bounds
Bbox.width()	transforms.Bbox.width
Bbox.height()	transforms.Bbox.height
Bbox.intervalx().get_bounds()	transforms.Bbox.intervalx
Bbox.intervalx().set_bounds()	[Bbox.intervalx is now a property.]
Bbox.intervaly().get_bounds()	transforms.Bbox.intervaly
Bbox.intervaly().set_bounds()	[Bbox.intervaly is now a property.]
Bbox.xmin()	transforms.Bbox.x0 or transforms.Bbox.xmin ¹
Bbox.ymin()	transforms.Bbox.y0 or transforms.Bbox.ymin ¹
Bbox.xmax()	transforms.Bbox.x1 or transforms.Bbox.xmax ¹
Bbox.ymax()	transforms.Bbox.y1 or transforms.Bbox.ymax ¹
Bbox.overlaps(bboxes)	Bbox.count_overlaps(bboxes)
bbox_all(bboxes)	Bbox.union(bboxes) [transforms.Bbox.union() is a staticmethod.]
lbwh_to_bbox(l, b, w, h)	Bbox.from_bounds(x0, y0, w, h) [transforms.Bbox.from_bounds() is a staticmethod.]
inverse_transform_bbox(transform, bbox)	Bbox.inverse_transformed(transform)
Interval.contains_open(v)	interval_contains_open(tuple, v)
Interval.contains(v)	interval_contains(tuple, v)
identity_transform()	matplotlib.transforms.IdentityTransform
blend_xy_sep_transform(xtransform, ytransform)	blended_transform_factory(xtransform, ytransform)
scale_transform(xs, ys)	Affine2D().scale(xs[, ys])
get_bbox_transform(boxin, boxout)	BboxTransform(boxin, boxout) or BboxTransformFrom(boxin) or BboxTransformTo(boxout)
Transform.seq_xy_tup(points)	Transform.transform(points)
Transform.inverse_xy_tup(points)	Transform.inverted().transform(points)

¹ The *Bbox* is bound by the points (x0, y0) to (x1, y1) and there is no defined order to these points, that is, x0 is not necessarily the left edge of the box. To get the left edge of the Bbox, use the read-only property *xmin*.

matplotlib.axes

Old method	New method
<code>Axes.get_position()</code>	<code>matplotlib.axes.Axes.get_position()</code> ²
<code>Axes.set_position()</code>	<code>matplotlib.axes.Axes.set_position()</code> ³
<code>Axes.toggle_log_lineary()</code>	<code>matplotlib.axes.Axes.set_yscale()</code> ⁴
Subplot class	removed.

The Polar class has moved to `matplotlib.projections.polar`.

matplotlib.artist

Old method	New method
<code>Artist.set_clip_path(path)</code>	<code>Artist.set_clip_path(path, transform)</code> ⁵

matplotlib.collections

Old method	New method
<code>linestyle</code>	<code>linestyles</code> ⁶

matplotlib.colors

Old method	New method
<code>ColorConverter.to_rgba_list(c)</code>	<code>ColorConverter.to_rgba_array(c)</code> [<code>matplotlib.colors.ColorConverter.to_rgba_array()</code> returns an Nx4 Numpy array of RGBA color quadruples.]

matplotlib.contour

Old method	New method
<code>Contour._segments</code>	<code>matplotlib.contour.Contour.get_paths`()</code> [Returns a list of <code>matplotlib.path.Path</code> instances.]

matplotlib.figure

Old method	New method
<code>Figure.dpi.get()</code> / <code>Figure.dpi.set()</code>	<code>matplotlib.figure.Figure.dpi</code> (a property)

² `matplotlib.axes.Axes.get_position()` used to return a list of points, now it returns a `matplotlib.transforms.Bbox` instance.

³ `matplotlib.axes.Axes.set_position()` now accepts either four scalars or a `matplotlib.transforms.Bbox` instance.

⁴ Since the refactoring allows for more than two scale types ('log' or 'linear'), it no longer makes sense to have a toggle. `Axes.toggle_log_lineary()` has been removed.

⁵ `matplotlib.artist.Artist.set_clip_path()` now accepts a `matplotlib.path.Path` instance and a `matplotlib.transforms.Transform` that will be applied to the path immediately before clipping.

⁶ Linestyles are now treated like all other collection attributes, i.e. a single value or multiple values may be provided.

matplotlib.patches

Old method	New method
Patch. get_verts()	<code>matplotlib.patches.Patch.get_path()</code> [Returns a <code>matplotlib.path.Path</code> instance]

matplotlib.backend_bases

Old method	New method
GraphicsContext. set_clip_rectangle(tuple)	GraphicsContext. set_clip_rectangle(bbox)
GraphicsContext.get_clip_path()	GraphicsContext.get_clip_path() ⁷
GraphicsContext.set_clip_path()	GraphicsContext.set_clip_path() ⁸

RendererBase

New methods:

- `draw_path(self, gc, path, transform, rgbFace)`
- `draw_markers(self, gc, marker_path, marker_trans, path, trans, rgbFace)`
- `draw_path_collection(self, master_transform, cliprect, clippath, clippath_trans, paths, all_transforms, offsets, offsetTrans, facecolors, edgecolors, linewidths, linestyle, antialiaseds) [optional]`

Changed methods:

- `draw_image(self, x, y, im, bbox)` is now `draw_image(self, x, y, im, bbox, clippath, clippath_trans)`

Removed methods:

- `draw_arc`
- `draw_line_collection`
- `draw_line`
- `draw_lines`
- `draw_point`
- `draw_quad_mesh`
- `draw_poly_collection`
- `draw_polygon`

⁷ `matplotlib.backend_bases.GraphicsContext.get_clip_path()` returns a tuple of the form `(path, affine_transform)`, where `path` is a `matplotlib.path.Path` instance and `affine_transform` is a `matplotlib.transforms.Affine2D` instance.

⁸ `matplotlib.backend_bases.GraphicsContext.set_clip_path()` now only accepts a `matplotlib.transforms.TransformPath` instance.

- `draw_rectangle`
- `draw_regpoly_collection`

14.15 Changes for 0.91.2

- For `csv2rec()`, `checkrows=0` is the new default indicating all rows will be checked for type inference
- A warning is issued when an image is drawn on log-scaled axes, since it will not log-scale the image data.
- Moved `rec2gtk()` to `matplotlib.toolkits.gtktools`
- Moved `rec2excel()` to `matplotlib.toolkits.exceltools`
- Removed, dead/experimental `ExampleInfo`, `Namespace` and `Importer` code from `matplotlib.__init__`

14.16 Changes for 0.91.1

14.17 Changes for 0.91.0

- Changed `cbook.is_file_like()` to `cbook.is_writable_file_like()` and corrected behavior.
- Added `ax` kwarg to `pyplot.colorbar()` and `Figure.colorbar()` so that one can specify the axes object from which space for the colorbar is to be taken, if one does not want to make the colorbar axes manually.
- Changed `cbook.reversed()` so it yields a tuple rather than a (index, tuple). This agrees with the python `reversed` builtin, and `cbook` only defines `reversed` if python doesn't provide the builtin.
- Made `skiprows=1` the default on `csv2rec()`
- The `gd` and `paint` backends have been deleted.
- The `errorbar` method and function now accept additional kwargs so that upper and lower limits can be indicated by capping the bar with a caret instead of a straight line segment.
- The `matplotlib.dviread` file now has a parser for files like `psfonts.map` and `pdftex.map`, to map TeX font names to external files.
- The file `matplotlib.type1font` contains a new class for Type 1 fonts. Currently it simply reads `pfa` and `pfm` format files and stores the data in a way that is suitable for embedding in pdf files. In the future the class might actually parse the font to allow e.g., subsetting.
- `matplotlib.FT2Font` now supports `FT_Attach_File()`. In practice this can be used to read an `afm` file in addition to a `pfa/pfm` file, to get metrics and kerning information for a Type 1 font.
- The `AFM` class now supports querying `CapHeight` and stem widths. The `get_name_char` method now has an `isord` kwarg like `get_width_char`.

- Changed `pcolor()` default to `shading='flat'`; but as noted now in the docstring, it is preferable to simply use the `edgecolor` kwarg.
- The `mathtext` font commands (`\cal`, `\rm`, `\it`, `\tt`) now behave as TeX does: they are in effect until the next font change command or the end of the grouping. Therefore uses of `$$\cal{R}$$` should be changed to `$$\cal R$$`. Alternatively, you may use the new LaTeX-style font commands (`\mathcal`, `\mathrm`, `\mathit`, `\mathtt`) which do affect the following group, e.g., `$$\mathcal{R}$$`.
- Text creation commands have a new default `linespacing` and a new `linespacing` kwarg, which is a multiple of the maximum vertical extent of a line of ordinary text. The default is 1.2; `linespacing=2` would be like ordinary double spacing, for example.
- Changed default kwarg in `matplotlib.colors.Normalize.__init__()` to `clip=False`; clipping silently defeats the purpose of the special over, under, and bad values in the colormap, thereby leading to unexpected behavior. The new default should reduce such surprises.
- Made the `emit` property of `set_xlim()` and `set_ylim()` `True` by default; removed the Axes custom callback handling into a 'callbacks' attribute which is a `CallbackRegistry` instance. This now supports the 'xlim_changed' and 'ylim_changed' Axes events.

14.18 Changes for 0.90.1

The file `dviread.py` has a (very limited and fragile) dvi reader for usetex support. The API might change in the future so don't depend on it yet.

Removed deprecated support for a float value as a gray-scale; now it must be a string, like `'0.5'`. Added `alpha` kwarg to `ColorConverter.to_rgba_list`.

New method `set_bounds(vmin, vmax)` for formatters, locators sets the `viewInterval` and `dataInterval` from floats.

Removed deprecated `colorbar_classic`.

`Line2D.get_xdata` and `get_ydata` `valid_only=False` kwarg is replaced by `orig=True`. When `True`, it returns the original data, otherwise the processed data (masked, converted)

Some modifications to the units interface.

`units.ConversionInterface.tickers` renamed to `units.ConversionInterface.axisinfo` and it now returns a `units.AxisInfo` object rather than a tuple. This will make it easier to add axis info functionality (e.g., I added a default label on this iteration) w/o having to change the tuple length and hence the API of the client code every time new functionality is added. Also, `units.ConversionInterface.convert_to_value` is now simply named `units.ConversionInterface.convert`.

`Axes.errorbar` uses `Axes.vlines` and `Axes.hlines` to draw its error

limits `int` the vertical **and** horizontal direction. As you'll see **in** the changes below, these functions now **return** a `LineCollection` rather than a `list` of lines. The new **return** signature **for** `errorbar` **is** `ybins`, `caplines`, `errorcollections` where `errorcollections` **is** a `xerrcollection`, `yerrcollection`

`Axes.vlines` **and** `Axes.hlines` now create **and** returns a `LineCollection`, **not** a `list` of lines. This **is** much faster. The kwarg signature has changed, so consult the docs

`MaxNLocator` accepts a new Boolean kwarg (`'integer'`) to force ticks to integer locations.

Commands that **pass** an argument to the `Text` constructor **or** to `Text.set_text()` now accept **any object** that can be converted **with** `'%s'`. This affects `xlabel()`, `title()`, etc.

`Barh` now takes a `**kwargs` `dict` instead of most of the old arguments. This helps ensure that `bar` **and** `barh` are kept **in** sync, but **as** a side effect you can no longer **pass** e.g., `color` **as** a positional argument.

`ft2font.get_charmap()` now returns a `dict` that maps character codes to glyph indices (until now it was `reversed`)

Moved data files into `lib/matplotlib` so that `setuptools`' `develop` mode works. Re-organized the `mpl-data` layout so that this source structure **is** maintained **in** the installation. (i.e., the `'fonts'` **and** `'images'` sub-directories are maintained **in** site-packages.). Suggest removing `site-packages/matplotlib/mpl-data` **and** `~/matplotlib/ttfont.cache` before installing

14.19 Changes for 0.90.0

All artists now implement a `"pick"` method which users should **not** call. Rather, **set** the `"picker"` `property` of **any** artist you want to pick on (the `epsilon` distance **in** points **for** a hit test) **and** register **with** the `"pick_event"` callback. See `examples/pick_event_demo.py` **for** details

`Bar`, `barh`, **and** `hist` have `"log"` binary kwarg: `log=True` sets the ordinate to a log scale.

`Boxplot` can handle a `list` of vectors instead of just an array, so vectors can have different lengths.

`Plot` can handle 2-D x **and/or** y; it plots the columns.

Added `linewidth` kwarg to `bar` **and** `barh`.

Made the default `Artist._transform` `None` (rather than invoking `identity_transform` `for` each artist only to have it overridden later). Use `artist.get_transform()` rather than `artist._transform`, even `in` derived classes, so that the default transform will be created lazily `as` needed

New `LogNorm` subclass of `Normalize` added to `colors.py`. All `Normalize` subclasses have new `inverse()` method, `and` the `__call__()` method has a new `clip` kwarg.

Changed `class names` `in` `colors.py` to match convention: `normalize` -> `Normalize`, `no_norm` -> `NoNorm`. Old names are still available `for` now.

Removed obsolete `pcolor_classic` command `and` method.

Removed `lineprops` `and` `markerprops` `from the` `Annotation` code `and` replaced them `with` an arrow configurable `with` kwarg `arrowprops`. See `examples/annotation_demo.py` - JDH

14.20 Changes for 0.87.7

Completely reworked the annotations API because I found the old API cumbersome. The new design `is` much more legible `and` easy to read. See `matplotlib.text.Annotation` `and` `examples/annotation_demo.py`

`markeredgecolor` `and` `markerfacecolor` cannot be configured `in` `matplotlibrc` `any` more. Instead, markers are generally colored automatically based on the color of the line, unless marker colors are explicitly `set as` `kwargs` - NN

Changed default comment character `for` `load` to `'#'` - JDH

`math_parse_s_ft2font_svg` `from` `mathtext.py` & `mathtext2.py` now returns `width`, `height`, `svg_elements`. `svg_elements` `is` an instance of `Bunch` (`cmbook.py`) `and` has the attributes `svg_glyphs` `and` `svg_lines`, which are both lists.

`Renderer.draw_arc` now takes an additional parameter, `rotation`. It specifies to draw the artist rotated `in` degrees anti-clockwise. It was added `for` rotated ellipses.

Renamed `Figure.set_figsize_inches` to `Figure.set_size_inches` to better match the `get` method, `Figure.get_size_inches`.

Removed the `copy_bbox_transform` `from` `transforms.py`; added `shallowcopy` methods to `all` transforms. All transforms already had `deepcopy` methods.

FigureManager.resize(width, height): resize the window specified **in** pixels

barh: x **and** y args have been renamed to width **and** bottom respectively, **and** their order has been swapped to maintain a (position, value) order.

bar **and** barh: now accept kwarg 'edgecolor'.

bar **and** barh: The left, height, width **and** bottom args can now **all** be scalars **or** sequences; see docstring.

barh: now defaults to edge aligned instead of center aligned bars

bar, barh **and** hist: Added a keyword arg 'align' that controls between edge **or** center bar alignment.

Collections: PolyCollection **and** LineCollection now accept vertices **or** segments either **in** the original form [(x,y), (x,y), ...] **or as** a 2D numerix array, **with X as** the first column **and Y as** the second. Contour **and** quiver output the numerix form. The transforms methods Bbox.update() **and** Transformation.seq_xy_tups() now accept either form.

Collections: LineCollection **is** now a ScalarMappable like PolyCollection, etc.

Specifying a grayscale color **as** a float **is** deprecated; use a string instead, e.g., 0.75 -> '0.75'.

Collections: initializers now accept **any** mpl color arg, **or** sequence of such args; previously only a sequence of rgba tuples was accepted.

Colorbar: completely new version **and** api; see docstring. The original version **is** still accessible **as** colorbar_classic, but **is** deprecated.

Contourf: "extend" kwarg replaces "clip_ends"; see docstring. Masked array support added to pcolormesh.

Modified aspect-ratio handling:

Removed aspect kwarg **from** imshow

Axes methods:

set_aspect(self, aspect, adjustable=None, anchor=None)

set_adjustable(self, adjustable)

set_anchor(self, anchor)

PyLab interface:

axis('image')

Backend developers: ft2font's load_char now takes a flags argument, which you can OR together **from** the LOAD_XXX

constants.

14.21 Changes for 0.86

Matplotlib data **is** installed into the matplotlib module. This **is** similar to package_data. This should get rid of having to check **for** many possibilities **in** _get_data_path(). The MATPLOTLIBDATA env key **is** still checked first to allow **for** flexibility.

- 1) Separated the color table data **from** cm.py out into a new file, _cm.py, to make it easier to find the actual code **in** cm.py **and** to add new colormaps. Everything **from** _cm.py **is** imported by cm.py, so the split should be transparent.
- 2) Enabled automatic generation of a colormap **from** a list of colors **in** contour; see modified examples/contour_demo.py.
- 3) Support **for** imshow of a masked array, **with** the ability to specify colors (**or** no color at **all**) **for** masked regions, **and** **for** regions that are above **or** below the normally mapped region. See examples/image_masked.py.
- 4) In support of the above, added two new classes, ListedColormap, **and** no_norm, to colors.py, **and** modified the Colormap **class** to include common functionality. Added a clip kwarg to the normalize class.

14.22 Changes for 0.85

Made xtick **and** ytick separate props **in** rc

made pos=**None** the default **for** tick formatters rather than 0 to indicate "not supplied"

Removed "feature" of minor ticks which prevents them **from** **overlapping** major ticks. Often you want major **and** minor ticks at the same place, **and** can offset the major ticks **with** the pad. This could be made configurable

Changed the internal structure of contour.py to a more OO style. Calls to contour **or** contourf **in** axes.py **or** pylab.py now **return** a ContourSet **object** which contains references to the LineCollections **or** PolyCollections created by the call, **as** well **as** the configuration variables that were used. The ContourSet **object** **is** a "mappable" **if** a colormap was used.

Added a clip_ends kwarg to contourf. From the docstring:

* `clip_ends = True`
 If `False`, the limits for color scaling are set to the minimum and maximum contour levels.
`True` (default) clips the scaling limits. Example:
 if the contour boundaries are `V = [-100, 2, 1, 0, 1, 2, 100]`,
 then the scaling limits will be `[-100, 100]` if `clip_ends`
 is `False`, and `[-3, 3]` if `clip_ends` is `True`.

Added kwargs `linewidths`, `antialiased`, and `nchunk` to `contourf`. These are experimental; see the docstring.

Changed `Figure.colorbar()`:
 kw argument `order` changed;
 if mappable arg is a non-filled `ContourSet`, `colorbar()` shows lines instead of polygons.
 if mappable arg is a filled `ContourSet` with `clip_ends=True`, the endpoints are not labelled, so as to give the correct impression of open-endedness.

Changed `LineCollection.get_linewidths` to `get_linewidth`, for consistency.

14.23 Changes for 0.84

Unified argument handling between `hlines` and `vlines`. Both now take optionally a `fmt` argument (as in `plot`) and a keyword args that can be passed onto `Line2D`.

Removed all references to "data clipping" in `rc` and `lines.py` since these were not used and not optimized. I'm sure they'll be resurrected later with a better implementation when needed.

'set' removed - no more deprecation warnings. Use 'setp' instead.

Backend developers: Added `flipud` method to `image` and removed it from `to_str`. Removed origin kwarg from `backend.draw_image`. origin is handled entirely by the frontend now.

14.24 Changes for 0.83

- Made `HOME/.matplotlib` the new config dir where the `matplotlibrc` file, the `ttf.cache`, and the `tex.cache` live. The new default filenames in `.matplotlib` have no leading dot and are not hidden. e.g., the new names are `matplotlibrc`, `tex.cache`, and `ttffont.cache`. This is how ipython does it so it must be right.

If old files are found, a warning is issued and they are moved to the new location.

- backends/___init___py no longer imports new_figure_manager, draw_if_interactive and show from the default backend, but puts these imports into a call to pylab_setup. Also, the Toolbar is no longer imported from WX/WXAgg. New usage:

```
from backends import pylab_setup
new_figure_manager, draw_if_interactive, show = pylab_setup()
```

- Moved Figure.get_width_height() to FigureCanvasBase. It now returns int instead of float.

14.25 Changes for 0.82

- toolbar import change in GTKAgg, GTKCairo and WXAgg
- Added subplot config tool to GTK* backends -- note you must now import the NavigationToolbar2 from your backend of choice rather than from backend_gtk because it needs to know about the backend specific canvas -- see examples/embedding_in_gtk2.py. Ditto for wx backend -- see examples/embedding_in_wxagg.py

- hist bin change

Sean Richards notes there was a problem in the way we created the binning for histogram, which made the last bin underrepresented. From his post:

```
I see that hist uses the linspace function to create the bins
and then uses searchsorted to put the values in their correct
bin. That's all good but I am confused over the use of linspace
for the bin creation. I wouldn't have thought that it does
what is needed, to quote the docstring it creates a "Linear
spaced array from min to max". For it to work correctly
shouldn't the values in the bins array be the same bound for
each bin? (i.e. each value should be the lower bound of a
bin). To provide the correct bins for hist would it not be
something like
```

```
def bins(xmin, xmax, N):
    if N==1: return xmax
    dx = (xmax-xmin)/N # instead of N-1
    return xmin + dx*arange(N)
```

This suggestion is implemented in 0.81. My test script with these changes does not reveal any bias in the binning

```
from matplotlib.numerix.mlab import randn, rand, zeros, Float
from matplotlib.mlab import hist, mean
```

```

Nbins = 50
Ntests = 200
results = zeros((Ntests,Nbins), typecode=Float)
for i in range(Ntests):
    print 'computing', i
    x = rand(10000)
    n, bins = hist(x, Nbins)
    results[i] = n
print mean(results)

```

14.26 Changes for 0.81

- pylab **and** artist "set" functions renamed to setp to avoid clash **with** python2.4 built-in set. Current version will issue a deprecation warning which will be removed **in** future versions
- imshow interpolation arguments changes **for** advanced interpolation schemes. See help imshow, particularly the interpolation, filternorm **and** filterrad kwargs
- Support **for** masked arrays has been added to the plot command **and** to the Line2D object. Only the valid points are plotted. A "valid_only" kwarg was added to the get_xdata() **and** get_ydata() methods of Line2D; by default it **is False**, so that the original data arrays are returned. Setting it to **True** returns the plottable points.
- contour changes:

Masked arrays: contour **and** contourf now accept masked arrays **as** the variable to be contoured. Masking works correctly **for** contour, but a bug remains to be fixed before it will work **for** contourf. The "badmask" kwarg has been removed **from both** functions.

Level argument changes:

Old version: a **list** of levels **as** one of the positional arguments specified the lower bound of each filled region; the upper bound of the last region was taken **as** a very large number. Hence, it was **not** possible to specify that z values between 0 **and** 1, **for** example, be filled, **and** that values outside that **range** remain unfilled.

New version: a **list** of N levels **is** taken **as** specifying the boundaries of N-1 z ranges. Now the user has more control over what **is** colored **and** what **is not**. Repeated calls to contourf (**with** different colormaps **or** color specifications, **for** example) can be used to color different ranges of z. Values of z

outside an expected `range` are left uncolored.

Example:

Old: `contourf(z, [0, 1, 2])` would **yield** 3 regions: 0-1, 1-2, **and** >2.
New: it would **yield** 2 regions: 0-1, 1-2. If the same 3 regions were desired, the equivalent `list` of levels would be `[0, 1, 2, 1e38]`.

14.27 Changes for 0.80

- `xlim/ylim/axis` always **return** the new limits regardless of arguments. They now take kwargs which allow you to selectively change the upper **or** lower limits **while** leaving unnamed limits unchanged. See `help(xlim)` **for** example

14.28 Changes for 0.73

- Removed deprecated `ColormapJet` **and** friends
- Removed **all** error handling **from the** verbose `object`
- figure num of zero **is** now allowed

14.29 Changes for 0.72

- `Line2D`, `Text`, and `Patch` `copy_properties` renamed `update_from` and moved into artist base class
- `LineCollecitons.color` renamed to `LineCollections.set_color` for consistency with set/get introspection mechanism,
- `pylab` figure now defaults to `num=None`, which creates a new figure with a guaranteed unique number
- `contour` method syntax changed - now it is MATLAB compatible

unchanged: `contour(Z)`
old: `contour(Z, x=Y, y=Y)`
new: `contour(X, Y, Z)`

see <http://matplotlib.sf.net/matplotlib.pylab.html#-contour>
- Increased the default resolution for `save` command.

- Renamed the base attribute of the ticker classes to `_base` to avoid conflict with the base method. Sitt for subs
- `subs=None` now does autosubbing in the tick locator.
- New subplots that overlap old will delete the old axes. If you do not want this behavior, use `fig.add_subplot` or the axes command

14.30 Changes for 0.71

Significant numerix namespace changes, introduced to resolve namespace clashes between python built-ins and mlab names. Refactored numerix to maintain separate modules, rather than folding all these names into a single namespace. See the following mailing list threads for more information and background

http://sourceforge.net/mailarchive/forum.php?thread_id=6398890&forum_id=36187
http://sourceforge.net/mailarchive/forum.php?thread_id=6323208&forum_id=36187

OLD usage

```
from matplotlib.numerix import array, mean, fft
```

NEW usage

```
from matplotlib.numerix import array
from matplotlib.numerix.mlab import mean
from matplotlib.numerix.fft import fft
```

numerix dir structure mirrors numarray (though it is an incomplete implementation)

```
numerix
numerix/mlab
numerix/linear_algebra
numerix/fft
numerix/random_array
```

but of course you can use `'numerix : Numeric'` and still get the symbols.

pylab still imports most of the symbols from Numerix, MLab, fft, etc, but is more cautious. For names that clash with python names (`min`, `max`, `sum`), pylab keeps the builtins and provides the numeric versions with an `a*` prefix, e.g., (`amin`, `amax`, `asum`)

14.31 Changes for 0.70

MplEvent factored into a base `class Event` and derived classes `MouseEvent` and `KeyEvent`

Removed defunct `set_measurement` in wx toolbar

14.32 Changes for 0.65.1

removed `add_axes` and `add_subplot` from `backend_bases`. Use `figure.add_axes` and `add_subplot` instead. The figure now manages the current axes with `gca` and `sca` for get and set current axes. If you have code you are porting which called, e.g., `figmanager.add_axes`, you can now simply do `figmanager.canvas.figure.add_axes`.

14.33 Changes for 0.65

`mpl_connect` and `mpl_disconnect` in the MATLAB interface renamed to `connect` and `disconnect`

Did away with the text methods for angle since they were ambiguous. `fontangle` could mean `fontstyle` (oblique, etc) or the rotation of the text. Use `style` and `rotation` instead.

14.34 Changes for 0.63

Dates are now represented internally as float days since 0001-01-01, UTC.

All date tickers and formatters are now in `matplotlib.dates`, rather than `matplotlib.tickers`

converters have been abolished from all functions and classes. `num2date` and `date2num` are now the converter functions for all date plots

Most of the date tick locators have a different meaning in their constructors. In the prior implementation, the first argument was a base and multiples of the base were ticked. e.g.,

```
HourLocator(5) # old: tick every 5 minutes
```

In the new implementation, the explicit points you want to tick are provided as a number or sequence

```
HourLocator(range(0,5,61)) # new: tick every 5 minutes
```

This gives much greater flexibility. I have tried to make the default constructors (no args) behave similarly, where possible.

Note that YearLocator still works under the base/multiple scheme. The difference between the YearLocator **and** the other locators **is** that years are **not** recurrent.

Financial functions:

```
matplotlib.finance.quotes_historical_yahoo(ticker, date1, date2)
```

date1, date2 are now datetime instances. Return value **is** a list of quotes where the quote time **is** a float - days since gregorian start, **as** returned by date2num

See examples/finance_demo.py **for** example usage of new API

14.35 Changes for 0.61

canvas.connect **is** now deprecated **for** event handling. use mpl_connect **and** mpl_disconnect instead. The callback signature **is** func(event) rather than func(widget, event)

14.36 Changes for 0.60

ColormapJet **and** Grayscale are deprecated. For backwards compatibility, they can be obtained either by doing

```
from matplotlib.cm import ColormapJet
```

or

```
from matplotlib.matlab import *
```

They are replaced by cm.jet **and** cm.grey

14.37 Changes for 0.54.3

removed the set_default_font / get_default_font scheme **from** the font_manager to unify customization of font defaults **with** the rest of

```
the rc scheme. See examples/font_properties_demo.py and help(rc) in
matplotlib.matlab.
```

14.38 Changes for 0.54

14.38.1 MATLAB interface

dpi

Several of the backends used a PIXELS_PER_INCH hack that I added to try and make images render consistently across backends. This just complicated matters. So you may find that some font sizes and line widths appear different than before. Apologies for the inconvenience. You should set the dpi to an accurate value for your screen to get true sizes.

pcolor and scatter

There are two changes to the MATLAB interface API, both involving the patch drawing commands. For efficiency, pcolor and scatter have been rewritten to use polygon collections, which are a new set of objects from matplotlib.collections designed to enable efficient handling of large collections of objects. These new collections make it possible to build large scatter plots or pcolor plots with no loops at the python level, and are significantly faster than their predecessors. The original pcolor and scatter functions are retained as pcolor_classic and scatter_classic.

The return value from pcolor is a PolyCollection. Most of the properties that are available on rectangles or other patches are also available on PolyCollections, e.g., you can say:

```
c = scatter(blah, blah)
c.set_linewidth(1.0)
c.set_facecolor('r')
c.set_alpha(0.5)
```

or:

```
c = scatter(blah, blah)
set(c, 'linewidth', 1.0, 'facecolor', 'r', 'alpha', 0.5)
```

Because the collection is a single object, you no longer need to loop over the return value of scatter or pcolor to set properties for the entire list.

If you want the different elements of a collection to vary on a property, e.g., to have different line widths, see matplotlib.collections for a discussion on how to set the properties as a sequence.

For scatter, the size argument is now in points² (the area of the symbol in points) as in MATLAB and is not in data coords as before. Using sizes in data coords caused several problems. So you will need to adjust your size arguments accordingly or use scatter_classic.

mathtext spacing

For reasons not clear to me (and which I'll eventually fix) spacing no longer works in font groups. However, I added three new spacing commands which compensate for this ‘’ (regular space), ‘/’ (small space) and ‘`hspace{frac}`’ where `frac` is a fraction of `fontsize` in points. You will need to quote spaces in font strings, is:

```
title(r'$\rm{Histogram\ of\ IQ:}\ \mu=100,\ \sigma=15$')
```

14.38.2 Object interface - Application programmers

Autoscaling

The `x` and `y` axis instances no longer have `autoscale` view. These are handled by `axes.autoscale_view`

Axes creation

You should not instantiate your own `Axes` any more using the OO API. Rather, create a `Figure` as before and in place of:

```
f = Figure(figsize=(5,4), dpi=100)
a = Subplot(f, 111)
f.add_axis(a)
```

use:

```
f = Figure(figsize=(5,4), dpi=100)
a = f.add_subplot(111)
```

That is, `add_axis` no longer exists and is replaced by:

```
add_axes(rect, axisbg=defaultcolor, frameon=True)
add_subplot(num, axisbg=defaultcolor, frameon=True)
```

Artist methods

If you define your own `Artists`, you need to rename the `_draw` method to `draw`

Bounding boxes

`matplotlib.transforms.Bounds2D` is replaced by `matplotlib.transforms.Bbox`. If you want to construct a `bbox` from `left`, `bottom`, `width`, `height` (the signature for `Bounds2D`), use `matplotlib.transforms.lbwh_to_bbox`, as in

```
bbox = clickBBox = lbwh_to_bbox(left, bottom, width, height)
```

The Bbox has a different API than the Bound2D. e.g., if you want to get the width and height of the bbox

OLD:: width = fig.bbox.x.interval() height = fig.bbox.y.interval()

New:: width = fig.bbox.width() height = fig.bbox.height()

Object constructors

You no longer pass the bbox, dpi, or transforms to the various Artist constructors. The old way of creating lines and rectangles was cumbersome because you had to pass so many attributes to the Line2D and Rectangle classes not related directly to the geometry and properties of the object. Now default values are added to the object when you call axes.add_line or axes.add_patch, so they are hidden from the user.

If you want to define a custom transformation on these objects, call o.set_transform(trans) where trans is a Transformation instance.

In prior versions of you wanted to add a custom line in data coords, you would have to do

```
l = Line2D(dpi, bbox, x, y, color = color, transx = transx, transy = transy, )
```

now all you need is

```
l = Line2D(x, y, color=color)
```

and the axes will set the transformation for you (unless you have set your own already, in which case it will leave it unchanged)

Transformations

The entire transformation architecture has been rewritten. Previously the x and y transformations were stored in the xaxis and yaxis instances. The problem with this approach is it only allows for separable transforms (where the x and y transformations don't depend on one another). But for cases like polar, they do. Now transformations operate on x,y together. There is a new base class matplotlib.transforms.Transformation and two concrete implementations, matplotlib.transforms.SeparableTransformation and matplotlib.transforms.Affine. The SeparableTransformation is constructed with the bounding box of the input (this determines the rectangular coordinate system of the input, i.e., the x and y view limits), the bounding box of the display, and possibly nonlinear transformations of x and y. The 2 most frequently used transformations, data coordinates -> display and axes coordinates -> display are available as ax.transData and ax.transAxes. See alignment_demo.py which uses axes coords.

Also, the transformations should be much faster now, for two reasons

- they are written entirely in extension code
- because they operate on x and y together, they can do the entire transformation in one loop. Earlier I did something along the lines of:

```
xt = sx*func(x) + tx  
yt = sy*func(y) + ty
```

Although this was done in numerix, it still involves 6 length(x) for-loops (the multiply, add, and function evaluation each for x and y). Now all of that is done in a single pass.

If you are using transformations and bounding boxes to get the cursor position in data coordinates, the method calls are a little different now. See the updated examples/coords_demo.py which shows you how to do this.

Likewise, if you are using the artist bounding boxes to pick items on the canvas with the GUI, the bbox methods are somewhat different. You will need to see the updated examples/object_picker.py.

See unit/transforms_unit.py for many examples using the new transformations.

14.39 Changes for 0.50

- * refactored Figure **class so it is** no longer backend dependent. FigureCanvasBackend takes over the backend specific duties of the Figure. matplotlib.backend_bases.FigureBase moved to matplotlib.figure.Figure.
- * backends must implement FigureCanvasBackend (the thing that controls the figure **and** handles the events **if any**) **and** FigureManagerBackend (wraps the canvas **and** the window **for** MATLAB interface). FigureCanvasBase implements a backend switching mechanism
- * Figure **is** now an Artist (like everything **else in** the figure) **and is** totally backend independent
- * GDFONTPATH renamed to TTFPATH
- * backend faceColor argument changed to rgbFace
- * colormap stuff moved to colors.py
- * arg_to_rgb **in** backend_bases moved to **class ColorConverter in** colors.py
- * GD users must upgrade to gd-2.0.22 **and** gdmodule-0.52 since new gd features (clipping, antialiased lines) are now used.
- * Renderer must implement points_to_pixels

Migrating code:

MATLAB interface:

The only API change **for** those using the MATLAB interface **is in** how you call figure redraws **for** dynamically updating figures. In the old API, you did

```
fig.draw()
```

In the new API, you do

```
manager = get_current_fig_manager()
manager.canvas.draw()
```

See the examples `system_monitor.py`, `dynamic_demo.py`, and `anim.py`

API

There **is** one important API change **for** application developers. Figure instances used subclass GUI widgets that enabled them to be placed directly into figures. e.g., `FigureGTK` subclassed `gtk.DrawingArea`. Now the Figure **class is** independent of the backend, **and** `FigureCanvas` takes over the functionality formerly handled by Figure. In order to include figures into your apps, you now need to do, **for** example

```
# gtk example
fig = Figure(figsize=(5,4), dpi=100)
canvas = FigureCanvasGTK(fig) # a gtk.DrawingArea
canvas.show()
vbox.pack_start(canvas)
```

If you use the `NavigationToolbar`, this **in** now initialized **with** a `FigureCanvas`, **not** a Figure. The examples `embedding_in_gtk.py`, `embedding_in_gtk2.py`, and `mpl_with_glade.py` all reflect the new API so use these **as** a guide.

All prior calls to

```
figure.draw() and
figure.print_figure(args)
```

should now be

```
canvas.draw() and
canvas.print_figure(args)
```

Apologies **for** the inconvenience. This refactorization brings significant more freedom **in** developing matplotlib **and** should bring better plotting capabilities, so I hope the inconvenience **is** worth it.

14.40 Changes for 0.42

* Refactoring `AxisText` to be backend independent. Text drawing **and** `get_window_extent` functionality will be moved to the `Renderer`.

* `backend_bases.AxisTextBase` **is** now `text.Text` module

- * All the erase **and** reset functionality removed **from** `AxisText` - **not** needed **with** double buffered drawing. Ditto **with** state change. Text instances have a `get_prop_tup` method that returns a hashable **tuple** of text properties which you can use to see **if** text props have changed, e.g., by caching a font **or** layout instance **in** a **dict** **with** the prop tup **as** a key -- see `RendererGTK.get_pango_layout` **in** `backend_gtk` **for** an example.
- * `Text._get_xy_display` renamed `Text.get_xy_display`
- * Artist `set_renderer` **and** `wash_brushes` methods removed
- * Moved Legend **class** **from** `matplotlib.axes` into `matplotlib.legend`
- * Moved `Tick`, `XTick`, `YTick`, `Axis`, `XAxis`, `YAxis` **from** `matplotlib.axes` to `matplotlib.axis`
- * moved `process_text_args` to `matplotlib.text`
- * After getting Text handled **in** a backend independent fashion, the **import process** **is** much cleaner since there are no longer cyclic dependencies
- * `matplotlib.matlab._get_current_fig_manager` renamed to `matplotlib.matlab.get_current_fig_manager` to allow user access to the GUI window attribute, e.g., `figManager.window` **for** GTK **and** `figManager.frame` **for** wx

14.41 Changes for 0.40

- Artist
 - * `__init__` takes a DPI instance **and** a `Bound2D` instance which **is** the bounding box of the artist **in** display coords
 - * `get_window_extent` returns a `Bound2D` instance
 - * `set_size` **is** removed; replaced by `bbox` **and** `dpi`
 - * the `clip_gc` method **is** removed. Artists now clip themselves **with** their box
 - * added `_clipOn` boolean attribute. If **True**, gc clip to `bbox`.
- `AxisTextBase`
 - * Initialized **with** a `transx`, `transy` which are Transform instances
 - * `set_drawing_area` removed
 - * `get_left_right` **and** `get_top_bottom` are replaced by `get_window_extent`
- `Line2D` Patches now take `transx`, `transy`
 - * Initialized **with** a `transx`, `transy` which are Transform instances
- Patches
 - * Initialized **with** a `transx`, `transy` which are Transform instances

- FigureBase attributes dpi **is** a DPI instance rather than scalar **and** new attribute bbox **is** a Bound2D **in** display coords, **and** I got rid of the left, width, height, etc... attributes. These are now accessible **as**, **for** example, bbox.x.min **is** left, bbox.x.interval() **is** width, bbox.y.max **is** top, etc...
- GcfBase attribute pagesize renamed to figsize
- Axes
 - * removed figbg attribute
 - * added fig instance to `__init__`
 - * resizing **is** handled by figure call to `resize`.
- Subplot
 - * added fig instance to `__init__`
- Renderer methods **for** patches now take gcEdge **and** gcFace instances. gcFace=**None** takes the place of filled=**False**
- **True and False** symbols provided by cbook **in** a python2.3 compatible way
- new module transforms supplies Bound1D, Bound2D **and** Transform instances **and** more
- Changes to the MATLAB helpers API
 - * `_matplotlib_helpers.GcfBase` **is** renamed by Gcf. Backends no longer need to derive **from this** class. Instead, they provide a factory function `new_figure_manager(num, figsize, dpi)`. The `destroy` method of the GcfDerived **from the** backends **is** moved to the derived FigureManager.
 - * FigureManagerBase moved to `backend_bases`
 - * `Gcf.get_all_figwins` renamed to `Gcf.get_all_fig_managers`

Jeremy:

Make sure to `self._reset = False` **in** `AxisTextWX._set_font`. This was something missing **in** my backend code.

THE TOP LEVEL MATPLOTLIB MODULE

`matplotlib.use(arg, warn=True, force=False)`

Set the matplotlib backend to one of the known backends.

The argument is case-insensitive. *warn* specifies whether a warning should be issued if a backend has already been set up. *force* is an **experimental** flag that tells matplotlib to attempt to initialize a new backend by reloading the backend module.

Note: This function must be called *before* importing pyplot for the first time; or, if you are not using pyplot, it must be called before importing matplotlib.backends. If *warn* is True, a warning is issued if you try and call this after pylab or pyplot have been loaded. In certain black magic use cases, e.g. `pyplot.switch_backend()`, we are doing the reloading necessary to make the backend switch work (in some cases, e.g., pure image backends) so one can set *warn=False* to suppress the warnings.

To find out which backend is currently set, see `matplotlib.get_backend()`.

`matplotlib.get_backend()`

Return the name of the current backend.

`matplotlib.rcParams`

An instance of `RcParams` for handling default matplotlib values.

`matplotlib.rc(group, **kwargs)`

Set the current rc params. Group is the grouping for the rc, e.g., for `lines.linewidth` the group is `lines`, for `axes.facecolor`, the group is `axes`, and so on. Group may also be a list or tuple of group names, e.g., (*x*tick, *y*tick). *kwargs* is a dictionary attribute name/value pairs, e.g.,:

```
rc('lines', linewidth=2, color='r')
```

sets the current rc params and is equivalent to:

```
rcParams['lines.linewidth'] = 2  
rcParams['lines.color'] = 'r'
```

The following aliases are available to save typing for interactive users:

Alias	Property
'lw'	'linewidth'
'ls'	'linestyle'
'c'	'color'
'fc'	'facecolor'
'ec'	'edgecolor'
'mew'	'markeredgewidth'
'aa'	'antialiased'

Thus you could abbreviate the above rc command as:

```
rc('lines', lw=2, c='r')
```

Note you can use python's kwargs dictionary facility to store dictionaries of default parameters. e.g., you can customize the font rc as follows:

```
font = {'family' : 'monospace',
        'weight' : 'bold',
        'size'   : 'larger'}

rc('font', **font) # pass in the font dict as kwargs
```

This enables you to easily switch between several configurations. Use `matplotlib.style.use('default')` or `rcdefaults()` to restore the default rc params after changes.

`matplotlib.matplotlib_fname()`

Get the location of the config file.

The file location is determined in the following order

- `$PWD/matplotlibrc`
- `$MATPLOTLIBRC/matplotlibrc`
- `$MPLCONFIGDIR/matplotlibrc`
- On Linux,
 - `~/.matplotlib/matplotlibrc`, if it exists
 - or `$XDG_CONFIG_HOME/matplotlib/matplotlibrc` (if `$XDG_CONFIG_HOME` is defined)
 - or `~/.config/matplotlib/matplotlibrc` (if `$XDG_CONFIG_HOME` is not defined)
- On other platforms,
 - `~/.matplotlib/matplotlibrc` if `$HOME` is defined.
- Lastly, it looks in `$MATPLOTLIBDATA/matplotlibrc` for a system-defined copy.

`class matplotlib.RcParams(*args, **kwargs)`

A dictionary object including validation

validating functions are defined and associated with rc parameters in `matplotlib.rcsetup`

`matplotlib.rc_params`(*fail_on_error=False*)

Return a `matplotlib.RcParams` instance from the default matplotlib rc file.

`matplotlib.rc_params_from_file`(*fname, fail_on_error=False, use_default_template=True*)

Return `matplotlib.RcParams` from the contents of the given file.

Parameters `fname` : str

Name of file parsed for matplotlib settings.

fail_on_error : bool

If True, raise an error when the parser fails to convert a parameter.

use_default_template : bool

If True, initialize with default parameters before updating with those in the given file. If False, the configuration class only contains the parameters specified in the file. (Useful for updating dicts.)

class `matplotlib.rc_context`(*rc=None, fname=None*)

Return a context manager for managing rc settings.

This allows one to do:

```
with mpl.rc_context(fname='screen.rc'):
    plt.plot(x, a)
    with mpl.rc_context(fname='print.rc'):
        plt.plot(x, b)
    plt.plot(x, c)
```

The 'a' vs 'x' and 'c' vs 'x' plots would have settings from 'screen.rc', while the 'b' vs 'x' plot would have settings from 'print.rc'.

A dictionary can also be passed to the context manager:

```
with mpl.rc_context(rc={'text.usetex': True}, fname='screen.rc'):
    plt.plot(x, a)
```

The 'rc' dictionary takes precedence over the settings loaded from 'fname'. Passing a dictionary only is also valid.

AFM (ADOBE FONT METRICS INTERFACE)

16.1 matplotlib.afm

This is a python interface to Adobe Font Metrics Files. Although a number of other python implementations exist, and may be more complete than this, it was decided not to go with them because they were either:

1. copyrighted or used a non-BSD compatible license
2. had too many dependencies and a free standing lib was needed
3. Did more than needed and it was easier to write afresh rather than figure out how to get just what was needed.

It is pretty easy to use, and requires only built-in python libs:

```
>>> from matplotlib import rcParams
>>> import os.path
>>> afm_fname = os.path.join(rcParams['datapath'],
...                          'fonts', 'afm', 'ptmr8a.afm')
>>>
>>> from matplotlib.afm import AFM
>>> with open(afm_fname) as fh:
...     afm = AFM(fh)
>>> afm.string_width_height('What the heck?')
(6220.0, 694)
>>> afm.get_fontname()
'Times-Roman'
>>> afm.get_kern_dist('A', 'f')
0
>>> afm.get_kern_dist('A', 'y')
-92.0
>>> afm.get_bbox_char('!')
[130, -9, 238, 676]
```

```
class matplotlib.afm.AFM(fh)
```

```
    Bases: object
```

```
    Parse the AFM file in file object fh
```

```
    family_name
```

get_angle()
Return the fontangle as float

get_bbox_char(*c*, *isord=False*)

get_capheight()
Return the cap height as float

get_familyname()
Return the font family name, e.g., ‘Times’

get_fontname()
Return the font name, e.g., ‘Times-Roman’

get_fullname()
Return the font full name, e.g., ‘Times-Roman’

get_height_char(*c*, *isord=False*)
Get the height of character *c* from the bounding box. This is the ink height (space is 0)

get_horizontal_stem_width()
Return the standard horizontal stem width as float, or *None* if not specified in AFM file.

get_kern_dist(*c1*, *c2*)
Return the kerning pair distance (possibly 0) for chars *c1* and *c2*

get_kern_dist_from_name(*name1*, *name2*)
Return the kerning pair distance (possibly 0) for chars *name1* and *name2*

get_name_char(*c*, *isord=False*)
Get the name of the character, i.e., ‘;’ is ‘semicolon’

get_str_bbox(*s*)
Return the string bounding box

get_str_bbox_and_descent(*s*)
Return the string bounding box

get_underline_thickness()
Return the underline thickness as float

get_vertical_stem_width()
Return the standard vertical stem width as float, or *None* if not specified in AFM file.

get_weight()
Return the font weight, e.g., ‘Bold’ or ‘Roman’

get_width_char(*c*, *isord=False*)
Get the width of the character from the character metric WX field

get_width_from_char_name(*name*)
Get the width of the character from a type1 character name

get_xheight()
Return the xheight as float

string_width_height(*s*)

Return the string width (including kerning) and string height as a (*w*, *h*) tuple.

matplotlib.afm.parse_afm(*fh*)

Parse the Adobe Font Metrics file in file handle *fh*. Return value is a (*dhead*, *dcmetrics*, *dkernpairs*, *dcomposite*) tuple where *dhead* is a `_parse_header()` dict, *dcmetrics* is a `_parse_composites()` dict, *dkernpairs* is a `_parse_kern_pairs()` dict (possibly {}), and *dcomposite* is a `_parse_composites()` dict (possibly {})

ANIMATION MODULE

Table of Contents

- *Animation*
- *Writer Classes*
- *Helper Classes*
- *Inheritance Diagrams*
- *Deprecated*

17.1 Animation

The easiest way to make a live animation in matplotlib is to use one of the *Animation* classes.

<i>FuncAnimation</i>	Makes an animation by repeatedly calling a function <code>func</code> .
<i>ArtistAnimation</i>	Animation using a fixed set of <code>Artist</code> objects.

17.1.1 matplotlib.animation.FuncAnimation

`class matplotlib.animation.FuncAnimation(fig, func, frames=None, init_func=None,
fargs=None, save_count=None, **kwargs)`

Makes an animation by repeatedly calling a function `func`.

Parameters `fig` : `matplotlib.figure.Figure`

The figure object that is used to get draw, resize, and any other needed events.

func : callable

The function to call at each frame. The first argument will be the next value in `frames`. Any additional positional arguments can be supplied via the `fargs` parameter.

The required signature is

```
def func(fr: object, *fargs) -> iterable_of_artists:
```

frames : iterable, int, generator function, or None, optional

Source of data to pass `func` and each frame of the animation

If an iterable, then simply use the values provided. If the iterable has a length, it will override the `save_count` kwarg.

If an integer, equivalent to passing `range(frames)`

If a generator function, then must have the signature

```
def gen_function() -> obj:
```

In all of these cases, the values in `frames` is simply passed through to the user-supplied `func` and thus can be of any type.

If `None`, then equivalent to passing `itertools.count`.

init_func : callable, optional

A function used to draw a clear frame. If not given, the results of drawing from the first item in the `frames` sequence will be used. This function will be called once before the first frame.

If `blit=True`, `init_func` must return an iterable of artists to be re-drawn.

The required signature is

```
def init_func() -> iterable_of_artists:
```

fargs : tuple or None, optional

Additional arguments to pass to each call to `func`

save_count : int, optional

The number of values from `frames` to cache.

interval : number, optional

Delay between frames in milliseconds. Defaults to 200.

repeat_delay : number, optional

If the animation is repeated, adds a delay in milliseconds before repeating the animation. Defaults to `None`.

repeat : bool, optional

Controls whether the animation should repeat when the sequence of frames is completed. Defaults to `True`.

blit : bool, optional

Controls whether blitting is used to optimize drawing. Defaults to `False`.

```
__init__(fig, func, frames=None, init_func=None, fargs=None, save_count=None,
         **kwargs)
```

Methods

<code>__init__(fig, func[, frames, init_func, ...])</code>	
<code>new_frame_seq()</code>	
<code>new_saved_frame_seq()</code>	
<code>save(filename[, writer, fps, dpi, codec, ...])</code>	Saves a movie file by drawing every frame.
<code>to_html5_video()</code>	Returns animation as an HTML5 video tag.

17.1.2 matplotlib.animation.ArtistAnimation

```
class matplotlib.animation.ArtistAnimation(fig, artists, *args, **kwargs)
```

Animation using a fixed set of Artist objects.

Before creating an instance, all plotting should have taken place and the relevant artists saved.

Parameters fig : matplotlib.figure.Figure

The figure object that is used to get draw, resize, and any other needed events.

artists : list

Each list entry a collection of artists that represent what needs to be enabled on each frame. These will be disabled for other frames.

interval : number, optional

Delay between frames in milliseconds. Defaults to 200.

repeat_delay : number, optional

If the animation is repeated, adds a delay in milliseconds before repeating the animation. Defaults to None.

repeat : bool, optional

Controls whether the animation should repeat when the sequence of frames is completed. Defaults to True.

blit : bool, optional

Controls whether blitting is used to optimize drawing. Defaults to False.

```
__init__(fig, artists, *args, **kwargs)
```

Methods

<code>__init__(fig, artists, *args, **kwargs)</code>	
<code>new_frame_seq()</code>	Creates a new sequence of frame information.
<code>new_saved_frame_seq()</code>	Creates a new sequence of saved/cached frame information.
<code>save(filename[, writer, fps, dpi, codec, ...])</code>	Saves a movie file by drawing every frame.
<code>to_html5_video()</code>	Returns animation as an HTML5 video tag.

In both cases it is critical to keep a reference to the instance object. The animation is advanced by a timer (typically from the host GUI framework) which the *Animation* object holds the only reference to. If you do not hold a reference to the *Animation* object, it (and hence the timers), will be garbage collected which will stop the animation.

To save an animation to disk use

<code>Animation.save</code>	Saves a movie file by drawing every frame.
<code>Animation.to_html5_video</code>	Returns animation as an HTML5 video tag.

17.1.3 matplotlib.animation.Animation.save

`Animation.save(filename, writer=None, fps=None, dpi=None, codec=None, bitrate=None, extra_args=None, metadata=None, extra_anim=None, savefig_kwargs=None)`
 Saves a movie file by drawing every frame.

Parameters filename : str

The output filename, e.g., `mymovie.mp4`

writer : *MovieWriter* or str, optional

A *MovieWriter* instance to use or a key that identifies a class to use, such as 'ffmpeg' or 'mencoder'. If None, defaults to `rcParams['animation.writer']`

fps : number, optional

frames per second in the movie. Defaults to None, which will use the animation's specified interval to set the frames per second.

dpi : number, optional

Controls the dots per inch for the movie frames. This combined with the figure's size in inches controls the size of the movie. If None, defaults to `rcparam['savefig.dpi']`

codec : str, optional

The video codec to be used. Not all codecs are supported by a given *MovieWriter*. If None, default to `rcParams['animation.codec']`

bitrate : number, optional

Specifies the number of bits used per second in the compressed movie, in kilobits per second. A higher number means a higher quality movie, but at the cost of increased file size. If `None`, defaults to `rcParam['animation.bitrate']`

extra_args : list, optional

List of extra string arguments to be passed to the underlying movie utility. If `None`, defaults to `rcParams['animation.extra_args']`

metadata : dict, optional

Dictionary of keys and values for metadata to include in the output file. Some keys that may be of use include: title, artist, genre, subject, copyright, src-form, comment.

extra_anim : list, optional

Additional *Animation* objects that should be included in the saved movie file. These need to be from the same `matplotlib.Figure` instance. Also, animation frames will just be simply combined, so there should be a 1:1 correspondence between the frames from the different animations.

savefig_kwargs : dict, optional

Is a dictionary containing keyword arguments to be passed on to the 'savefig' command which is called repeatedly to save the individual frames.

Notes

`fps`, `codec`, `bitrate`, `extra_args`, `metadata` are used to construct a *MovieWriter* instance and can only be passed if `writer` is a string. If they are passed as non-`None` and `writer` is a *MovieWriter*, a `RuntimeError` will be raised.

17.1.4 matplotlib.animation.Animation.to_html5_video

`Animation.to_html5_video()`

Returns animation as an HTML5 video tag.

This saves the animation as an h264 video, encoded in base64 directly into the HTML5 video tag. This respects the rc parameters for the writer as well as the bitrate. This also makes use of the `interval` to control the speed, and uses the `repeat` parameter to decide whether to loop.

See *Helper Classes* below for details about what movie formats are supported.

17.1.5 FuncAnimation

The inner workings of *FuncAnimation* is more-or-less:

```

for d in frames:
    artists = func(d, *fargs)
    fig.canvas.draw_idle()
    plt.pause(interval)

```

with details to handle ‘blitting’ (to dramatically improve the live performance), to be non-blocking, handle repeats, multiple animated axes, and easily save the animation to a movie file.

‘Blitting’ is a [old technique](#) in computer graphics. The general gist is to take an existing bit map (in our case a mostly rasterized figure) and then ‘blit’ one more artist on top. Thus, by managing a saved ‘clean’ bitmap, we can only re-draw the few artists that are changing at each frame and possibly save significant amounts of time. When using blitting (by passing `blit=True`) the core loop of *FuncAnimation* gets a bit more complicated

```

ax = fig.gca()

def update_blit(artists):
    fig.canvas.restore_region(bg_cache)
    for a in artists:
        a.axes.draw_artist(a)

    ax.figure.canvas.blit(ax.bbox)

artists = init_func()

for a in artists:
    a.set_animated(True)

fig.canvas.draw()
bg_cache = fig.canvas.copy_from_bbox(ax.bbox)

for f in frames:
    artists = func(f, *fargs)
    update_blit(artists)
    plt.pause(interval)

```

This is of course leaving out many details (such as updating the background when the figure is resized or fully re-drawn). However, this hopefully minimalist example gives a sense of how `init_func` and `func` are used inside of *FuncAnimation* and the theory of how ‘blitting’ works.

The expected signature on `func` and `init_func` is very simple to keep *FuncAnimation* out of your book keeping and plotting logic, but this means that the callable objects you pass in must know what artists they should be working on. There are several approaches to handling this, of varying complexity and encapsulation. The simplest approach, which works quite well in the case of a script, is to define the artist at a global scope and let Python sort things out. For example

```

import numpy as np
import matplotlib.pyplot as plt
from matplotlib.animation import FuncAnimation

fig, ax = plt.subplots()
xdata, ydata = [], []

```

```

ln, = plt.plot([], [], 'ro', animated=True)

def init():
    ax.set_xlim(0, 2*np.pi)
    ax.set_ylim(-1, 1)
    return ln,

def update(frame):
    xdata.append(frame)
    ydata.append(np.sin(frame))
    ln.set_data(xdata, ydata)
    return ln,

ani = FuncAnimation(fig, update, frames=np.linspace(0, 2*np.pi, 128),
                    init_func=init, blit=True)
plt.show()

```

The second method is to use `functools.partial` to ‘bind’ artists to function. A third method is to use closures to build up the required artists and functions. A fourth method is to create a class.

Examples

animation example code: `animate_decay.py`

[source code]

```

"""
=====
Decay
=====

This example showcases a sinusoidal decay animation.
"""

import numpy as np
import matplotlib.pyplot as plt
import matplotlib.animation as animation

def data_gen(t=0):
    cnt = 0
    while cnt < 1000:
        cnt += 1
        t += 0.1
        yield t, np.sin(2*np.pi*t) * np.exp(-t/10.)

def init():
    ax.set_ylim(-1.1, 1.1)
    ax.set_xlim(0, 10)

```

```

    del xdata[:]
    del ydata[:]
    line.set_data(xdata, ydata)
    return line,

fig, ax = plt.subplots()
line, = ax.plot([], [], lw=2)
ax.grid()
xdata, ydata = [], []

def run(data):
    # update the data
    t, y = data
    xdata.append(t)
    ydata.append(y)
    xmin, xmax = ax.get_xlim()

    if t >= xmax:
        ax.set_xlim(xmin, 2*xmax)
        ax.figure.canvas.draw()
    line.set_data(xdata, ydata)

    return line,

ani = animation.FuncAnimation(fig, run, data_gen, blit=False, interval=10,
                             repeat=False, init_func=init)
plt.show()

```

Keywords: python, matplotlib, pylab, example, codex (see [Search examples](#))

animation example code: bayes_update.py

[source code]

```

"""
=====
The Bayes update
=====

This animation displays the posterior estimate updates as it is refitted when
new data arrives.
The vertical line represents the theoretical value to which the plotted
distribution should converge.
"""

# update a distribution based on new data.
import numpy as np
import matplotlib.pyplot as plt
import scipy.stats as ss
from matplotlib.animation import FuncAnimation

```



```

class UpdateDist(object):
    def __init__(self, ax, prob=0.5):
        self.success = 0
        self.prob = prob
        self.line, = ax.plot([], [], 'k-')
        self.x = np.linspace(0, 1, 200)
        self.ax = ax

        # Set up plot parameters
        self.ax.set_xlim(0, 1)
        self.ax.set_ylim(0, 15)
        self.ax.grid(True)

        # This vertical line represents the theoretical value, to
        # which the plotted distribution should converge.
        self.ax.axvline(prob, linestyle='--', color='black')

    def init(self):
        self.success = 0
        self.line.set_data([], [])
        return self.line,

    def __call__(self, i):
        # This way the plot can continuously run and we just keep
        # watching new realizations of the process
        if i == 0:
            return self.init()

        # Choose success based on exceed a threshold with a uniform pick
        if np.random.rand(1,) < self.prob:
            self.success += 1
        y = ss.beta.pdf(self.x, self.success + 1, (i - self.success) + 1)
        self.line.set_data(self.x, y)
        return self.line,

fig, ax = plt.subplots()
ud = UpdateDist(ax, prob=0.7)
anim = FuncAnimation(fig, ud, frames=np.arange(100), init_func=ud.init,
                    interval=100, blit=True)
plt.show()

```

Keywords: python, matplotlib, pylab, example, codex (see [Search examples](#))

animation example code: double_pendulum_animated.py

[source code]

```

"""
=====

```

```

The double pendulum problem
=====

This animation illustrates the double pendulum problem.
"""

# Double pendulum formula translated from the C code at
# http://www.physics.usyd.edu.au/~wheat/dpend_html/solve_dpend.c

from numpy import sin, cos
import numpy as np
import matplotlib.pyplot as plt
import scipy.integrate as integrate
import matplotlib.animation as animation

G = 9.8 # acceleration due to gravity, in m/s^2
L1 = 1.0 # length of pendulum 1 in m
L2 = 1.0 # length of pendulum 2 in m
M1 = 1.0 # mass of pendulum 1 in kg
M2 = 1.0 # mass of pendulum 2 in kg

def derivs(state, t):

    dydx = np.zeros_like(state)
    dydx[0] = state[1]

    del_ = state[2] - state[0]
    den1 = (M1 + M2)*L1 - M2*L1*cos(del_)*cos(del_)
    dydx[1] = (M2*L1*state[1]*state[1]*sin(del_)*cos(del_) +
              M2*G*sin(state[2])*cos(del_) +
              M2*L2*state[3]*state[3]*sin(del_) -
              (M1 + M2)*G*sin(state[0]))/den1

    dydx[2] = state[3]

    den2 = (L2/L1)*den1
    dydx[3] = (-M2*L2*state[3]*state[3]*sin(del_)*cos(del_) +
              (M1 + M2)*G*sin(state[0])*cos(del_) -
              (M1 + M2)*L1*state[1]*state[1]*sin(del_) -
              (M1 + M2)*G*sin(state[2]))/den2

    return dydx

# create a time array from 0..100 sampled at 0.05 second steps
dt = 0.05
t = np.arange(0.0, 20, dt)

# th1 and th2 are the initial angles (degrees)
# w10 and w20 are the initial angular velocities (degrees per second)
th1 = 120.0
w1 = 0.0
th2 = -10.0

```

```

w2 = 0.0

# initial state
state = np.radians([th1, w1, th2, w2])

# integrate your ODE using scipy.integrate.
y = integrate.odeint(derivs, state, t)

x1 = L1*sin(y[:, 0])
y1 = -L1*cos(y[:, 0])

x2 = L2*sin(y[:, 2]) + x1
y2 = -L2*cos(y[:, 2]) + y1

fig = plt.figure()
ax = fig.add_subplot(111, autoscale_on=False, xlim=(-2, 2), ylim=(-2, 2))
ax.grid()

line, = ax.plot([], [], 'o-', lw=2)
time_template = 'time = %.1fs'
time_text = ax.text(0.05, 0.9, '', transform=ax.transAxes)

def init():
    line.set_data([], [])
    time_text.set_text('')
    return line, time_text

def animate(i):
    thisx = [0, x1[i], x2[i]]
    thisy = [0, y1[i], y2[i]]

    line.set_data(thisx, thisy)
    time_text.set_text(time_template % (i*dt))
    return line, time_text

ani = animation.FuncAnimation(fig, animate, np.arange(1, len(y)),
                              interval=25, blit=True, init_func=init)

# ani.save('double_pendulum.mp4', fps=15)
plt.show()

```

Keywords: python, matplotlib, pylab, example, codex (see [Search examples](#))

animation example code: dynamic_image.py

[source code]

```

"""
=====

```

```

An animated image
=====

This example demonstrates how to animate an image.
"""
import numpy as np
import matplotlib.pyplot as plt
import matplotlib.animation as animation

fig = plt.figure()

def f(x, y):
    return np.sin(x) + np.cos(y)

x = np.linspace(0, 2 * np.pi, 120)
y = np.linspace(0, 2 * np.pi, 100).reshape(-1, 1)

im = plt.imshow(f(x, y), animated=True)

def updatefig(*args):
    global x, y
    x += np.pi / 15.
    y += np.pi / 20.
    im.set_array(f(x, y))
    return im,

ani = animation.FuncAnimation(fig, updatefig, interval=50, blit=True)
plt.show()

```

Keywords: python, matplotlib, pylab, example, codex (see [Search examples](#))

animation example code: histogram.py

[source code]

```

"""
=====
Animated histogram
=====

This example shows how to use a path patch to draw a bunch of
rectangles for an animated histogram.

"""
import numpy as np

import matplotlib.pyplot as plt
import matplotlib.patches as patches
import matplotlib.path as path

```

```

import matplotlib.animation as animation

fig, ax = plt.subplots()

# histogram our data with numpy
data = np.random.randn(1000)
n, bins = np.histogram(data, 100)

# get the corners of the rectangles for the histogram
left = np.array(bins[:-1])
right = np.array(bins[1:])
bottom = np.zeros(len(left))
top = bottom + n
nrects = len(left)

# here comes the tricky part -- we have to set up the vertex and path
# codes arrays using moveto, lineto and closepoly

# for each rect: 1 for the MOVETO, 3 for the LINETO, 1 for the
# CLOSEPOLY; the vert for the closepoly is ignored but we still need
# it to keep the codes aligned with the vertices
nverts = nrects*(1 + 3 + 1)
verts = np.zeros((nverts, 2))
codes = np.ones(nverts, int) * path.Path.LINETO
codes[0::5] = path.Path.MOVETO
codes[4::5] = path.Path.CLOSEPOLY
verts[0::5, 0] = left
verts[0::5, 1] = bottom
verts[1::5, 0] = left
verts[1::5, 1] = top
verts[2::5, 0] = right
verts[2::5, 1] = top
verts[3::5, 0] = right
verts[3::5, 1] = bottom

barpath = path.Path(verts, codes)
patch = patches.PathPatch(
    barpath, facecolor='green', edgecolor='yellow', alpha=0.5)
ax.add_patch(patch)

ax.set_xlim(left[0], right[-1])
ax.set_ylim(bottom.min(), top.max())

def animate(i):
    # simulate new data coming in
    data = np.random.randn(1000)
    n, bins = np.histogram(data, 100)
    top = bottom + n
    verts[1::5, 1] = top
    verts[2::5, 1] = top
    return [patch, ]

```

```
ani = animation.FuncAnimation(fig, animate, 100, repeat=False, blit=True)
plt.show()
```

Keywords: python, matplotlib, pylab, example, codex (see *Search examples*)

animation example code: rain.py

[source code]

```
"""
=====
Rain simulation
=====

Simulates rain drops on a surface by animating the scale and opacity
of 50 scatter points.

Author: Nicolas P. Rougier
"""
import numpy as np
import matplotlib.pyplot as plt
from matplotlib.animation import FuncAnimation

# Create new Figure and an Axes which fills it.
fig = plt.figure(figsize=(7, 7))
ax = fig.add_axes([0, 0, 1, 1], frameon=False)
ax.set_xlim(0, 1), ax.set_xticks([])
ax.set_ylim(0, 1), ax.set_yticks([])

# Create rain data
n_drops = 50
rain_drops = np.zeros(n_drops, dtype=[('position', float, 2),
                                      ('size', float, 1),
                                      ('growth', float, 1),
                                      ('color', float, 4)])

# Initialize the raindrops in random positions and with
# random growth rates.
rain_drops['position'] = np.random.uniform(0, 1, (n_drops, 2))
rain_drops['growth'] = np.random.uniform(50, 200, n_drops)

# Construct the scatter which we will update during animation
# as the raindrops develop.
scat = ax.scatter(rain_drops['position'][:, 0], rain_drops['position'][:, 1],
                  s=rain_drops['size'], lw=0.5, edgecolors=rain_drops['color'],
                  facecolors='none')

def update(frame_number):
    # Get an index which we can use to re-spawn the oldest raindrop.
```

```

current_index = frame_number % n_drops

# Make all colors more transparent as time progresses.
rain_drops['color'][:, 3] -= 1.0/len(rain_drops)
rain_drops['color'][:, 3] = np.clip(rain_drops['color'][:, 3], 0, 1)

# Make all circles bigger.
rain_drops['size'] += rain_drops['growth']

# Pick a new position for oldest rain drop, resetting its size,
# color and growth factor.
rain_drops['position'][current_index] = np.random.uniform(0, 1, 2)
rain_drops['size'][current_index] = 5
rain_drops['color'][current_index] = (0, 0, 0, 1)
rain_drops['growth'][current_index] = np.random.uniform(50, 200)

# Update the scatter collection, with the new colors, sizes and positions.
scat.set_edgecolors(rain_drops['color'])
scat.set_sizes(rain_drops['size'])
scat.set_offsets(rain_drops['position'])

# Construct the animation, using the update function as the animation
# director.
animation = FuncAnimation(fig, update, interval=10)
plt.show()

```

Keywords: python, matplotlib, pylab, example, codex (see [Search examples](#))

animation example code: random_data.py

[source code]

```

"""
=====
Random data
=====

An animation of random data.

"""

import numpy as np
import matplotlib.pyplot as plt
import matplotlib.animation as animation

fig, ax = plt.subplots()
line, = ax.plot(np.random.rand(10))
ax.set_ylim(0, 1)

```

```
def update(data):
    line.set_ydata(data)
    return line,

def data_gen():
    while True:
        yield np.random.rand(10)

ani = animation.FuncAnimation(fig, update, data_gen, interval=100)
plt.show()
```

Keywords: python, matplotlib, pylab, example, codex (see [Search examples](#))

animation example code: simple_3danim.py

[source code]

```
"""
=====
3D animation
=====

A simple example of an animated plot... In 3D!
"""
import numpy as np
import matplotlib.pyplot as plt
import mpl_toolkits.mplot3d.axes3d as p3
import matplotlib.animation as animation

def Gen_RandLine(length, dims=2):
    """
    Create a line using a random walk algorithm

    length is the number of points for the line.
    dims is the number of dimensions the line has.
    """
    lineData = np.empty((dims, length))
    lineData[:, 0] = np.random.rand(dims)
    for index in range(1, length):
        # scaling the random numbers by 0.1 so
        # movement is small compared to position.
        # subtraction by 0.5 is to change the range to [-0.5, 0.5]
        # to allow a line to move backwards.
        step = ((np.random.rand(dims) - 0.5) * 0.1)
        lineData[:, index] = lineData[:, index - 1] + step

    return lineData
```



```

def update_lines(num, dataLines, lines):
    for line, data in zip(lines, dataLines):
        # NOTE: there is no .set_data() for 3 dim data...
        line.set_data(data[0:2, :num])
        line.set_3d_properties(data[2, :num])
    return lines

# Attaching 3D axis to the figure
fig = plt.figure()
ax = p3.Axes3D(fig)

# Fifty lines of random 3-D lines
data = [Gen_RandLine(25, 3) for index in range(50)]

# Creating fifty line objects.
# NOTE: Can't pass empty arrays into 3d version of plot()
lines = [ax.plot(dat[0, 0:1], dat[1, 0:1], dat[2, 0:1])[0] for dat in data]

# Setting the axes properties
ax.set_xlim3d([0.0, 1.0])
ax.set_xlabel('X')

ax.set_ylim3d([0.0, 1.0])
ax.set_ylabel('Y')

ax.set_zlim3d([0.0, 1.0])
ax.set_zlabel('Z')

ax.set_title('3D Test')

# Creating the Animation object
line_ani = animation.FuncAnimation(fig, update_lines, 25, fargs=(data, lines),
                                   interval=50, blit=False)

plt.show()

```

Keywords: python, matplotlib, pylab, example, codex (see [Search examples](#))

animation example code: simple_anim.py

[source code]

```

"""
A simple example of an animated plot
"""
import numpy as np
import matplotlib.pyplot as plt
import matplotlib.animation as animation

fig, ax = plt.subplots()

```

```

x = np.arange(0, 2*np.pi, 0.01)
line, = ax.plot(x, np.sin(x))

def animate(i):
    line.set_ydata(np.sin(x + i/10.0)) # update the data
    return line,

# Init only required for blitting to give a clean slate.
def init():
    line.set_ydata(np.ma.array(x, mask=True))
    return line,

ani = animation.FuncAnimation(fig, animate, np.arange(1, 200), init_func=init,
                              interval=25, blit=True)

plt.show()

```

Keywords: python, matplotlib, pylab, example, codex (see [Search examples](#))

animation example code: strip_chart_demo.py

[source code]

```

"""
=====
Oscilloscope
=====

Emulates an oscilloscope.
"""
import numpy as np
from matplotlib.lines import Line2D
import matplotlib.pyplot as plt
import matplotlib.animation as animation

class Scope(object):
    def __init__(self, ax, maxt=2, dt=0.02):
        self.ax = ax
        self.dt = dt
        self.maxt = maxt
        self.tdata = [0]
        self.ydata = [0]
        self.line = Line2D(self.tdata, self.ydata)
        self.ax.add_line(self.line)
        self.ax.set_ylim(-.1, 1.1)
        self.ax.set_xlim(0, self.maxt)

    def update(self, y):
        lastt = self.tdata[-1]

```

```

    if lastt > self.tdata[0] + self.maxt: # reset the arrays
        self.tdata = [self.tdata[-1]]
        self.ydata = [self.ydata[-1]]
        self.ax.set_xlim(self.tdata[0], self.tdata[0] + self.maxt)
        self.ax.figure.canvas.draw()

    t = self.tdata[-1] + self.dt
    self.tdata.append(t)
    self.ydata.append(y)
    self.line.set_data(self.tdata, self.ydata)
    return self.line,

def emitter(p=0.03):
    'return a random value with probability p, else 0'
    while True:
        v = np.random.rand(1)
        if v > p:
            yield 0.
        else:
            yield np.random.rand(1)

fig, ax = plt.subplots()
scope = Scope(ax)

# pass a generator in "emitter" to produce data for the update func
ani = animation.FuncAnimation(fig, scope.update, emitter, interval=10,
                              blit=True)

plt.show()

```

Keywords: python, matplotlib, pylab, example, codex (see [Search examples](#))

animation example code: unchained.py

[source code]

```

"""
=====
MATPLOTLIB **UNCHAINED**
=====

Comparative path demonstration of frequency from a fake signal of a pulsar.
(mostly known because of the cover for Joy Division's Unknown Pleasures)

Author: Nicolas P. Rougier
"""
import numpy as np
import matplotlib.pyplot as plt
import matplotlib.animation as animation

```

```

# Create new Figure with black background
fig = plt.figure(figsize=(8, 8), facecolor='black')

# Add a subplot with no frame
ax = plt.subplot(111, frameon=False)

# Generate random data
data = np.random.uniform(0, 1, (64, 75))
X = np.linspace(-1, 1, data.shape[-1])
G = 1.5 * np.exp(-4 * X * X)

# Generate line plots
lines = []
for i in range(len(data)):
    # Small reduction of the X extents to get a cheap perspective effect
    xscale = 1 - i / 200.
    # Same for linewidth (thicker strokes on bottom)
    lw = 1.5 - i / 100.0
    line, = ax.plot(xscale * X, i + G * data[i], color="w", lw=lw)
    lines.append(line)

# Set y limit (or first line is cropped because of thickness)
ax.set_ylim(-1, 70)

# No ticks
ax.set_xticks([])
ax.set_yticks([])

# 2 part titles to get different font weights
ax.text(0.5, 1.0, "MATPLOTLIB ", transform=ax.transAxes,
        ha="right", va="bottom", color="w",
        family="sans-serif", fontweight="light", fontsize=16)
ax.text(0.5, 1.0, "UNCHAINED", transform=ax.transAxes,
        ha="left", va="bottom", color="w",
        family="sans-serif", fontweight="bold", fontsize=16)

def update(*args):
    # Shift all data to the right
    data[:, 1:] = data[:, :-1]

    # Fill-in new values
    data[:, 0] = np.random.uniform(0, 1, len(data))

    # Update data
    for i in range(len(data)):
        lines[i].set_ydata(i + G * data[i])

    # Return modified artists
    return lines

# Construct the animation, using the update function as the animation

```

```
# director.
anim = animation.FuncAnimation(fig, update, interval=10)
plt.show()
```

Keywords: python, matplotlib, pylab, example, codex (see *Search examples*)

17.1.6 ArtistAnimation

Examples

animation example code: `basic_example.py`

[source code]

```
"""
=====
Simple animation examples
=====

This example contains two animations. The first is a random walk plot. The
second is an image animation.
"""

import numpy as np
import matplotlib.pyplot as plt
import matplotlib.animation as animation

def update_line(num, data, line):
    line.set_data(data[... , :num])
    return line,

fig1 = plt.figure()

data = np.random.rand(2, 25)
l, = plt.plot([], [], 'r-')
plt.xlim(0, 1)
plt.ylim(0, 1)
plt.xlabel('x')
plt.title('test')
line_ani = animation.FuncAnimation(fig1, update_line, 25, fargs=(data, l),
                                   interval=50, blit=True)

# To save the animation, use the command: line_ani.save('lines.mp4')

fig2 = plt.figure()

x = np.arange(-9, 10)
y = np.arange(-9, 10).reshape(-1, 1)
base = np.hypot(x, y)
ims = []
```

```
for add in np.arange(15):
    ims.append((plt.pcolor(x, y, base + add, norm=plt.Normalize(0, 30)),))

im_ani = animation.ArtistAnimation(fig2, ims, interval=50, repeat_delay=3000,
                                   blit=True)
# To save this second animation with some metadata, use the following command:
# im_ani.save('im.mp4', metadata={'artist':'Guido'})

plt.show()
```

Keywords: python, matplotlib, pylab, example, codex (see *Search examples*)

animation example code: basic_example_writer.py

[source code]

```
"""
=====
Saving an animation
=====

This example showcases the same animations as `basic_example.py`, but instead
of displaying the animation to the user, it writes to files using a
MovieWriter instance.
"""

# -*- noplots -*-
import numpy as np
import matplotlib
matplotlib.use("Agg")
import matplotlib.pyplot as plt
import matplotlib.animation as animation

def update_line(num, data, line):
    line.set_data(data[... , :num])
    return line,

# Set up formatting for the movie files
Writer = animation.writers['ffmpeg']
writer = Writer(fps=15, metadata=dict(artist='Me'), bitrate=1800)

fig1 = plt.figure()

data = np.random.rand(2, 25)
l, = plt.plot([], [], 'r-')
plt.xlim(0, 1)
plt.ylim(0, 1)
plt.xlabel('x')
plt.title('test')
```

```

line_ani = animation.FuncAnimation(fig1, update_line, 25, fargs=(data, 1),
                                  interval=50, blit=True)
line_ani.save('lines.mp4', writer=writer)

fig2 = plt.figure()

x = np.arange(-9, 10)
y = np.arange(-9, 10).reshape(-1, 1)
base = np.hypot(x, y)
ims = []
for add in np.arange(15):
    ims.append((plt.pcolor(x, y, base + add, norm=plt.Normalize(0, 30)),))

im_ani = animation.ArtistAnimation(fig2, ims, interval=50, repeat_delay=3000,
                                   blit=True)
im_ani.save('im.mp4', writer=writer)

```

Keywords: python, matplotlib, pylab, example, codex (see [Search examples](#))

animation example code: dynamic_image2.py

[source code]

```

"""
=====
An animated image using a list of images
=====

This examples demonstrates how to animate an image from a list of images (or
Artists).
"""
import numpy as np
import matplotlib.pyplot as plt
import matplotlib.animation as animation

fig = plt.figure()

def f(x, y):
    return np.sin(x) + np.cos(y)

x = np.linspace(0, 2 * np.pi, 120)
y = np.linspace(0, 2 * np.pi, 100).reshape(-1, 1)
# ims is a list of lists, each row is a list of artists to draw in the
# current frame; here we are just animating one artist, the image, in
# each frame
ims = []
for i in range(60):
    x += np.pi / 15.
    y += np.pi / 20.
    im = plt.imshow(f(x, y), animated=True)

```

```
ims.append([im])

ani = animation.ArtistAnimation(fig, ims, interval=50, blit=True,
                               repeat_delay=1000)

# ani.save('dynamic_images.mp4')

plt.show()
```

Keywords: python, matplotlib, pylab, example, codex (see [Search examples](#))

17.2 Writer Classes

The provided writers fall into two broad categories: pipe-based and file-based. The pipe-based writers stream the captured frames over a pipe to an external process. The pipe-based variants tend to be more performant, but may not work on all systems.

<i>FFMpegWriter</i>	Pipe-based ffmpeg writer.
<i>ImageMagickFileWriter</i>	File-based animated gif writer.
<i>AVConvWriter</i>	Pipe-based avconv writer.

17.2.1 matplotlib.animation.FFMpegWriter

```
class matplotlib.animation.FFMpegWriter(fps=5, codec=None, bitrate=None, extra_args=None, metadata=None)
```

Pipe-based ffmpeg writer.

Frames are streamed directly to ffmpeg via a pipe and written in a single pass.

Parameters **fps**: int

Framerate for movie.

codec: string or None, optional

The codec to use. If None (the default) the setting in the rcParam `animation.codec` is used.

bitrate: int or None, optional

The bitrate for the saved movie file, which is one way to control the output file size and quality. The default value is None, which uses the value stored in the rcParam `animation.bitrate`. A value of -1 implies that the bitrate should be determined automatically by the underlying utility.

extra_args: list of strings or None

A list of extra string arguments to be passed to the underlying movie utility. The default is None, which passes the additional arguments in the `'animation.extra_args'` rcParam.

metadata: dict of string:string or None

A dictionary of keys and values for metadata to include in the output file. Some keys that may be of use include: title, artist, genre, subject, copyright, srcform, comment.

`__init__(fps=5, codec=None, bitrate=None, extra_args=None, metadata=None)`
MovieWriter

Parameters fps: int

Framerate for movie.

codec: string or None, optional

The codec to use. If None (the default) the setting in the rcParam `animation.codec` is used.

bitrate: int or None, optional

The bitrate for the saved movie file, which is one way to control the output file size and quality. The default value is None, which uses the value stored in the rcParam `animation.bitrate`. A value of -1 implies that the bitrate should be determined automatically by the underlying utility.

extra_args: list of strings or None

A list of extra string arguments to be passed to the underlying movie utility. The default is None, which passes the additional arguments in the ‘animation.extra_args’ rcParam.

metadata: dict of string:string or None

A dictionary of keys and values for metadata to include in the output file. Some keys that may be of use include: title, artist, genre, subject, copyright, srcform, comment.

Methods

<code>__init__([fps, codec, bitrate, extra_args, ...])</code>	MovieWriter
<code>bin_path()</code>	Returns the binary path to the commandline tool used by a specific subclass.
<code>cleanup()</code>	Clean-up and collect the process used to write the movie file.
<code>finish()</code>	Finish any processing for writing the movie.
<code>grab_frame(**savefig_kwargs)</code>	Grab the image information from the figure and save as a movie frame.
<code>isAvailable()</code>	Check to see if a MovieWriter subclass is actually available by running the commandline tool.
<code>saving(*args, **kw)</code>	Context manager to facilitate writing the movie file.

Continued on next page

Table 17.6 – continued from previous page

<code>setup(fig, outfile, dpi)</code>	Perform setup for writing the movie file.
---------------------------------------	-------------------------------------------

Attributes

<code>args_key</code>	
<code>exec_key</code>	
<code>frame_size</code>	A tuple (width,height) in pixels of a movie frame.
<code>output_args</code>	

17.2.2 matplotlib.animation.ImageMagickFileWriter

`class matplotlib.animation.ImageMagickFileWriter(*args, **kwargs)`

File-based animated gif writer.

Frames are written to temporary files on disk and then stitched together at the end.

`__init__(*args, **kwargs)`

Methods

<code>__init__(*args, **kwargs)</code>	
<code>bin_path()</code>	Returns the binary path to the commandline tool used by a specific subclass.
<code>cleanup()</code>	
<code>finish()</code>	
<code>grab_frame(**savefig_kwargs)</code>	Grab the image information from the figure and save as a movie frame.
<code>isAvailable()</code>	Check to see if a ImageMagickWriter is actually available.
<code>saving(*args, **kw)</code>	Context manager to facilitate writing the movie file.
<code>setup(fig, outfile, dpi[, frame_prefix, ...])</code>	Perform setup for writing the movie file.

Attributes

<code>args_key</code>	
<code>delay</code>	
<code>exec_key</code>	

Continued on next page

Table 17.9 – continued from previous page

<code>frame_format</code>	Format (png, jpeg, etc.) to use for saving the frames, which can be decided by the individual subclasses.
<code>frame_size</code>	A tuple (width,height) in pixels of a movie frame.
<code>output_args</code>	
<code>supported_formats</code>	

17.2.3 matplotlib.animation.AVConvWriter

class `matplotlib.animation.AVConvWriter`(*fps=5, codec=None, bitrate=None, extra_args=None, metadata=None*)

Pipe-based avconv writer.

Frames are streamed directly to avconv via a pipe and written in a single pass.

Parameters fps: int

Framerate for movie.

codec: string or None, optional

The codec to use. If None (the default) the setting in the rcParam `animation.codec` is used.

bitrate: int or None, optional

The bitrate for the saved movie file, which is one way to control the output file size and quality. The default value is None, which uses the value stored in the rcParam `animation.bitrate`. A value of -1 implies that the bitrate should be determined automatically by the underlying utility.

extra_args: list of strings or None

A list of extra string arguments to be passed to the underlying movie utility. The default is None, which passes the additional arguments in the ‘`animation.extra_args`’ rcParam.

metadata: dict of string:string or None

A dictionary of keys and values for metadata to include in the output file. Some keys that may be of use include: title, artist, genre, subject, copyright, srcform, comment.

__init__(*fps=5, codec=None, bitrate=None, extra_args=None, metadata=None*)

MovieWriter

Parameters fps: int

Framerate for movie.

codec: string or None, optional

The codec to use. If None (the default) the setting in the rcParam `animation.codec` is used.

bitrate: int or None, optional

The bitrate for the saved movie file, which is one way to control the output file size and quality. The default value is None, which uses the value stored in the rcParam `animation.bitrate`. A value of -1 implies that the bitrate should be determined automatically by the underlying utility.

extra_args: list of strings or None

A list of extra string arguments to be passed to the underlying movie utility. The default is None, which passes the additional arguments in the `animation.extra_args` rcParam.

metadata: dict of string:string or None

A dictionary of keys and values for metadata to include in the output file. Some keys that may be of use include: title, artist, genre, subject, copyright, srcform, comment.

Methods

<code>__init__([fps, codec, bitrate, extra_args, ...])</code>	MovieWriter
<code>bin_path()</code>	Returns the binary path to the commandline tool used by a specific subclass.
<code>cleanup()</code>	Clean-up and collect the process used to write the movie file.
<code>finish()</code>	Finish any processing for writing the movie.
<code>grab_frame(**savefig_kwargs)</code>	Grab the image information from the figure and save as a movie frame.
<code>isAvailable()</code>	Check to see if a MovieWriter subclass is actually available by running the commandline tool.
<code>saving(*args, **kw)</code>	Context manager to facilitate writing the movie file.
<code>setup(fig, outfile, dpi)</code>	Perform setup for writing the movie file.

Attributes

<code>args_key</code>	
<code>exec_key</code>	
<code>frame_size</code>	A tuple (width,height) in pixels of a movie frame.
<code>output_args</code>	

Alternatively the file-based writers save temporary files for each frame which are stitched into a single file at the end. Although slower, these writers can be easier to debug.

FFMpegFileWriter

File-based ffmpeg writer.

Continued on next page

Table 17.12 – continued from previous page

<i>ImageMagickWriter</i>	Pipe-based animated gif.
<i>AVConvFileWriter</i>	File-based avconv writer.

17.2.4 matplotlib.animation.FFMpegFileWriter

class matplotlib.animation.FFMpegFileWriter(*args, **kwargs)

File-based ffmpeg writer.

Frames are written to temporary files on disk and then stitched together at the end.

`__init__`(*args, **kwargs)

Methods

<code>__init__</code> (*args, **kwargs)	
<code>bin_path</code> ()	Returns the binary path to the commandline tool used by a specific subclass.
<code>cleanup</code> ()	
<code>finish</code> ()	
<code>grab_frame</code> (**savefig_kwargs)	Grab the image information from the figure and save as a movie frame.
<code>isAvailable</code> ()	Check to see if a MovieWriter subclass is actually available by running the commandline tool.
<code>saving</code> (*args, **kw)	Context manager to facilitate writing the movie file.
<code>setup</code> (fig, outfile, dpi[, frame_prefix, ...])	Perform setup for writing the movie file.

Attributes

<code>args_key</code>	
<code>exec_key</code>	
<code>frame_format</code>	Format (png, jpeg, etc.) to use for saving the frames, which can be decided by the individual subclasses.
<code>frame_size</code>	A tuple (width,height) in pixels of a movie frame.
<code>output_args</code>	
<code>supported_formats</code>	

17.2.5 matplotlib.animation.ImageMagickWriter

`class matplotlib.animation.ImageMagickWriter`(*fps=5, codec=None, bitrate=None, extra_args=None, metadata=None*)

Pipe-based animated gif.

Frames are streamed directly to ImageMagick via a pipe and written in a single pass.

Parameters **fps**: int

Framerate for movie.

codec: string or None, optional

The codec to use. If None (the default) the setting in the rcParam `animation.codec` is used.

bitrate: int or None, optional

The bitrate for the saved movie file, which is one way to control the output file size and quality. The default value is None, which uses the value stored in the rcParam `animation.bitrate`. A value of -1 implies that the bitrate should be determined automatically by the underlying utility.

extra_args: list of strings or None

A list of extra string arguments to be passed to the underlying movie utility. The default is None, which passes the additional arguments in the 'animation.extra_args' rcParam.

metadata: dict of string:string or None

A dictionary of keys and values for metadata to include in the output file. Some keys that may be of use include: title, artist, genre, subject, copyright, srcform, comment.

`__init__`(*fps=5, codec=None, bitrate=None, extra_args=None, metadata=None*)
MovieWriter

Parameters **fps**: int

Framerate for movie.

codec: string or None, optional

The codec to use. If None (the default) the setting in the rcParam `animation.codec` is used.

bitrate: int or None, optional

The bitrate for the saved movie file, which is one way to control the output file size and quality. The default value is None, which uses the value stored in the rcParam `animation.bitrate`. A value of -1 implies that the bitrate should be determined automatically by the underlying utility.

extra_args: list of strings or None

A list of extra string arguments to be passed to the underlying movie utility. The default is None, which passes the additional arguments in the 'animation.extra_args' rcParam.

metadata: dict of string:string or None

A dictionary of keys and values for metadata to include in the output file. Some keys that may be of use include: title, artist, genre, subject, copyright, srcform, comment.

Methods

<code>__init__</code> ([fps, codec, bitrate, extra_args, ...])	MovieWriter
<code>bin_path</code> ()	Returns the binary path to the commandline tool used by a specific subclass.
<code>cleanup</code> ()	Clean-up and collect the process used to write the movie file.
<code>finish</code> ()	Finish any processing for writing the movie.
<code>grab_frame</code> (**savefig_kwargs)	Grab the image information from the figure and save as a movie frame.
<code>isAvailable</code> ()	Check to see if a ImageMagickWriter is actually available.
<code>saving</code> (*args, **kw)	Context manager to facilitate writing the movie file.
<code>setup</code> (fig, outfile, dpi)	Perform setup for writing the movie file.

Attributes

<code>args_key</code>	
<code>delay</code>	
<code>exec_key</code>	
<code>frame_size</code>	A tuple (width,height) in pixels of a movie frame.
<code>output_args</code>	

17.2.6 matplotlib.animation.AVConvFileWriter

class matplotlib.animation.AVConvFileWriter(*args, **kwargs)

File-based avconv writer.

Frames are written to temporary files on disk and then stitched together at the end.

`__init__`(*args, **kwargs)

Methods

<code>__init__(*args, **kwargs)</code>	
<code>bin_path()</code>	Returns the binary path to the commandline tool used by a specific subclass.
<code>cleanup()</code>	
<code>finish()</code>	
<code>grab_frame(**savefig_kwargs)</code>	Grab the image information from the figure and save as a movie frame.
<code>isAvailable()</code>	Check to see if a <code>MovieWriter</code> subclass is actually available by running the commandline tool.
<code>saving(*args, **kw)</code>	Context manager to facilitate writing the movie file.
<code>setup(fig, outfile, dpi[, frame_prefix, ...])</code>	Perform setup for writing the movie file.

Attributes

<code>args_key</code>	
<code>exec_key</code>	
<code>frame_format</code>	Format (png, jpeg, etc.) to use for saving the frames, which can be decided by the individual subclasses.
<code>frame_size</code>	A tuple (width,height) in pixels of a movie frame.
<code>output_args</code>	
<code>supported_formats</code>	

Fundamentally, a `MovieWriter` provides a way to grab sequential frames from the same underlying `Figure` object. The base class `MovieWriter` implements 3 methods and a context manager. The only difference between the pipe-based and file-based writers is in the arguments to their respective `setup` methods.

<code>MovieWriter.setup</code>	Perform setup for writing the movie file.
<code>FileMovieWriter.setup</code>	Perform setup for writing the movie file.
<code>MovieWriter.grab_frame</code>	Grab the image information from the figure and save as a movie frame.
<code>MovieWriter.finish</code>	Finish any processing for writing the movie.
<code>MovieWriter.saving</code>	Context manager to facilitate writing the movie file.

17.2.7 matplotlib.animation.MovieWriter.setup

`MovieWriter.setup(fig, outfile, dpi)`

Perform setup for writing the movie file.

Parameters `fig` : `matplotlib.Figure` instance

The figure object that contains the information for frames

outfile : string

The filename of the resulting movie file

dpi : int

The DPI (or resolution) for the file. This controls the size in pixels of the resulting movie file.

17.2.8 matplotlib.animation.FileMovieWriter.setup

`FileMovieWriter.setup(fig, outfile, dpi, frame_prefix='_tmp', clear_temp=True)`

Perform setup for writing the movie file.

Parameters fig : matplotlib.figure.Figure

The figure to grab the rendered frames from.

outfile : str

The filename of the resulting movie file.

dpi : number

The dpi of the output file. This, with the figure size, controls the size in pixels of the resulting movie file.

frame_prefix : str, optional

The filename prefix to use for temporary files. Defaults to ‘_tmp’.

clear_temp : bool, optional

If the temporary files should be deleted after stitching the final result. Setting this to False can be useful for debugging. Defaults to True.

17.2.9 matplotlib.animation.MovieWriter.grab_frame

`MovieWriter.grab_frame(**savefig_kwargs)`

Grab the image information from the figure and save as a movie frame.

All keyword arguments in `savefig_kwargs` are passed on to the ‘savefig’ command that saves the figure.

17.2.10 matplotlib.animation.MovieWriter.finish

`MovieWriter.finish()`

Finish any processing for writing the movie.

17.2.11 matplotlib.animation.MovieWriter.saving

MovieWriter.**saving**(*args, **kw)

Context manager to facilitate writing the movie file.

*args, **kw are any parameters that should be passed to *setup*.

The `setup()` method is used to prepare the writer (possibly opening a pipe), successive calls to `grab_frame()` capture a single frame at a time and `finish()` finalizes the movie and writes the output file to disk. For example

```
moviewriter = MovieWriter(...)
moviewriter.setup(fig=fig, 'my_movie.ext', dpi=100)
for j in range(n):
    update_figure(n)
    moviewriter.grab_frame()
moviewriter.finish()
```

If using the writer classes directly (not through *Animation.save*), it is strongly encouraged to use the *saving* context manager

```
with moviewriter.saving(fig, 'myfile.mp4', dpi=100):
    for j in range(n):
        update_figure(n)
        moviewriter.grab_frame()
```

to ensure that setup and cleanup are performed as necessary.

animation example code: moviewriter.py

17.3 Helper Classes

17.3.1 Animation Base Classes

<i>Animation</i>	This class wraps the creation of an animation using matplotlib.
<i>TimedAnimation</i>	<i>Animation</i> subclass for time-based animation.

matplotlib.animation.Animation

class matplotlib.animation.**Animation**(fig, event_source=None, blit=False)

This class wraps the creation of an animation using matplotlib.

It is only a base class which should be subclassed to provide needed behavior.

This class is not typically used directly.

Parameters fig : matplotlib.figure.Figure

The figure object that is used to get draw, resize, and any other needed events.

event_source : object, optional

A class that can run a callback when desired events are generated, as well as be stopped and started.

Examples include timers (see [TimedAnimation](#)) and file system notifications.

blit : bool, optional

controls whether blitting is used to optimize drawing. Defaults to False.

See also:

[FuncAnimation](#), [ArtistAnimation](#)

`__init__(fig, event_source=None, blit=False)`

Methods

<code>__init__(fig[, event_source, blit])</code>	
<code>new_frame_seq()</code>	Creates a new sequence of frame information.
<code>new_saved_frame_seq()</code>	Creates a new sequence of saved/cached frame information.
<code>save(filename[, writer, fps, dpi, codec, ...])</code>	Saves a movie file by drawing every frame.
<code>to_html5_video()</code>	Returns animation as an HTML5 video tag.

matplotlib.animation.TimedAnimation

class matplotlib.animation.**TimedAnimation**(fig, interval=200, repeat_delay=None, repeat=True, event_source=None, *args, **kwargs)

Animation subclass for time-based animation.

A new frame is drawn every *interval* milliseconds.

Parameters fig : matplotlib.figure.Figure

The figure object that is used to get draw, resize, and any other needed events.

interval : number, optional

Delay between frames in milliseconds. Defaults to 200.

repeat_delay : number, optional

If the animation is repeated, adds a delay in milliseconds before repeating the animation. Defaults to None.

repeat : bool, optional

Controls whether the animation should repeat when the sequence of frames is completed. Defaults to True.

blit : bool, optional

Controls whether blitting is used to optimize drawing. Defaults to `False`.

`__init__(fig, interval=200, repeat_delay=None, repeat=True, event_source=None, *args, **kwargs)`

Methods

<code>__init__(fig[, interval, repeat_delay, ...])</code>	
<code>new_frame_seq()</code>	Creates a new sequence of frame information.
<code>new_saved_frame_seq()</code>	Creates a new sequence of saved/cached frame information.
<code>save(filename[, writer, fps, dpi, codec, ...])</code>	Saves a movie file by drawing every frame.
<code>to_html5_video()</code>	Returns animation as an HTML5 video tag.

17.3.2 Custom Animation classes

animation example code: subplots.py

17.3.3 Writer Registry

A module-level registry is provided to map between the name of the writer and the class to allow a string to be passed to `Animation.save` instead of a writer instance.

<code>MovieWriterRegistry</code>	Registry of available writer classes by human readable name.
----------------------------------	--------------------------------------------------------------

matplotlib.animation.MovieWriterRegistry

class matplotlib.animation.MovieWriterRegistry

Registry of available writer classes by human readable name.

`__init__()`

Methods

<code>__init__()</code>	
<code>ensure_not_dirty()</code>	If dirty, reasks the writers if they are available
<code>is_available(name)</code>	Check if given writer is available by name.
<code>list()</code>	Get a list of available MovieWriters.

Continued on next page

Table 17.24 – continued from previous page

<code>register(name)</code>	
<code>reset_available_writers()</code>	Reset the available state of all registered writers
<code>set_dirty()</code>	Sets a flag to re-setup the writers

17.3.4 Writer Base Classes

To reduce code duplication base classes

<code>MovieWriter</code>	Base class for writing movies.
<code>FileMovieWriter</code>	<code>MovieWriter</code> for writing to individual files and stitching at the end.

matplotlib.animation.MovieWriter

```
class matplotlib.animation.MovieWriter(fps=5, codec=None, bitrate=None,
                                       extra_args=None, metadata=None)
```

Base class for writing movies.

This class is set up to provide for writing movie frame data to a pipe. See examples for how to use these classes.

Attributes

<code>frame_format</code>	(str) The format used in writing frame data, defaults to 'rgba'
<code>fig</code>	(<i>Figure</i>) The figure to capture data from. This must be provided by the sub-classes.

Parameters `fps`: int

Framerate for movie.

`codec`: string or None, optional

The codec to use. If None (the default) the setting in the rcParam `animation.codec` is used.

`bitrate`: int or None, optional

The bitrate for the saved movie file, which is one way to control the output file size and quality. The default value is None, which uses the value stored in the rcParam `animation.bitrate`. A value of -1 implies that the bitrate should be determined automatically by the underlying utility.

`extra_args`: list of strings or None

A list of extra string arguments to be passed to the underlying movie utility. The default is None, which passes the additional arguments in the 'animation.extra_args' rcParam.

metadata: dict of string:string or None

A dictionary of keys and values for metadata to include in the output file. Some keys that may be of use include: title, artist, genre, subject, copyright, srcform, comment.

`__init__(fps=5, codec=None, bitrate=None, extra_args=None, metadata=None)`
 MovieWriter

Parameters fps: int

Framerate for movie.

codec: string or None, optional

The codec to use. If None (the default) the setting in the rcParam `animation.codec` is used.

bitrate: int or None, optional

The bitrate for the saved movie file, which is one way to control the output file size and quality. The default value is None, which uses the value stored in the rcParam `animation.bitrate`. A value of -1 implies that the bitrate should be determined automatically by the underlying utility.

extra_args: list of strings or None

A list of extra string arguments to be passed to the underlying movie utility. The default is None, which passes the additional arguments in the `animation.extra_args` rcParam.

metadata: dict of string:string or None

A dictionary of keys and values for metadata to include in the output file. Some keys that may be of use include: title, artist, genre, subject, copyright, srcform, comment.

Methods

<code>__init__([fps, codec, bitrate, extra_args, ...])</code>	MovieWriter
<code>bin_path()</code>	Returns the binary path to the commandline tool used by a specific subclass.
<code>cleanup()</code>	Clean-up and collect the process used to write the movie file.
<code>finish()</code>	Finish any processing for writing the movie.
<code>grab_frame(**savefig_kwargs)</code>	Grab the image information from the figure and save as a movie frame.
<code>isAvailable()</code>	Check to see if a MovieWriter subclass is actually available by running the commandline tool.

Continued on next page

Table 17.26 – continued from previous page

<code>saving(*args, **kw)</code>	Context manager to facilitate writing the movie file.
<code>setup(fig, outfile, dpi)</code>	Perform setup for writing the movie file.

Attributes

<code>frame_size</code>	A tuple (width,height) in pixels of a movie frame.
-------------------------	----------------------------------------------------

matplotlib.animation.FileMovieWriter

class matplotlib.animation.FileMovieWriter(*args, **kwargs)

MovieWriter for writing to individual files and stitching at the end.

This must be sub-classed to be useful.

`__init__(*args, **kwargs)`

Methods

<code>__init__(*args, **kwargs)</code>	
<code>bin_path()</code>	Returns the binary path to the commandline tool used by a specific subclass.
<code>cleanup()</code>	
<code>finish()</code>	
<code>grab_frame(**savefig_kwargs)</code>	Grab the image information from the figure and save as a movie frame.
<code>isAvailable()</code>	Check to see if a MovieWriter subclass is actually available by running the commandline tool.
<code>saving(*args, **kw)</code>	Context manager to facilitate writing the movie file.
<code>setup(fig, outfile, dpi[, frame_prefix, ...])</code>	Perform setup for writing the movie file.

Attributes

<code>frame_format</code>	Format (png, jpeg, etc.) to use for saving the frames, which can be decided by the individual subclasses.
<code>frame_size</code>	A tuple (width,height) in pixels of a movie frame.

and mixins are provided

<i>AVConvBase</i>	Mixin class for avconv output.
<i>FFMpegBase</i>	Mixin class for FFMpeg output.
<i>ImageMagickBase</i>	Mixin class for ImageMagick output.

matplotlib.animation.AVConvBase

class matplotlib.animation.AVConvBase

Mixin class for avconv output.

To be useful this must be multiply-inherited from with a `MovieWriterBase` sub-class.

__init__()

Initialize self. See `help(type(self))` for accurate signature.

Attributes

<code>args_key</code>
<code>exec_key</code>
<code>output_args</code>

matplotlib.animation.FFMpegBase

class matplotlib.animation.FFMpegBase

Mixin class for FFMpeg output.

To be useful this must be multiply-inherited from with a `MovieWriterBase` sub-class.

__init__()

Initialize self. See `help(type(self))` for accurate signature.

Attributes

<code>args_key</code>
<code>exec_key</code>
<code>output_args</code>

matplotlib.animation.ImageMagickBase

class matplotlib.animation.ImageMagickBase

Mixin class for ImageMagick output.

To be useful this must be multiply-inherited from with a `MovieWriterBase` sub-class.

__init__()

Initialize self. See `help(type(self))` for accurate signature.

Methods

isAvailable()	Check to see if a ImageMagickWriter is actually available.
---------------	------------------------------------------------------------

Attributes

args_key
delay
exec_key
output_args

See the source code for how to easily implement new *MovieWriter* classes.

17.4 Inheritance Diagrams

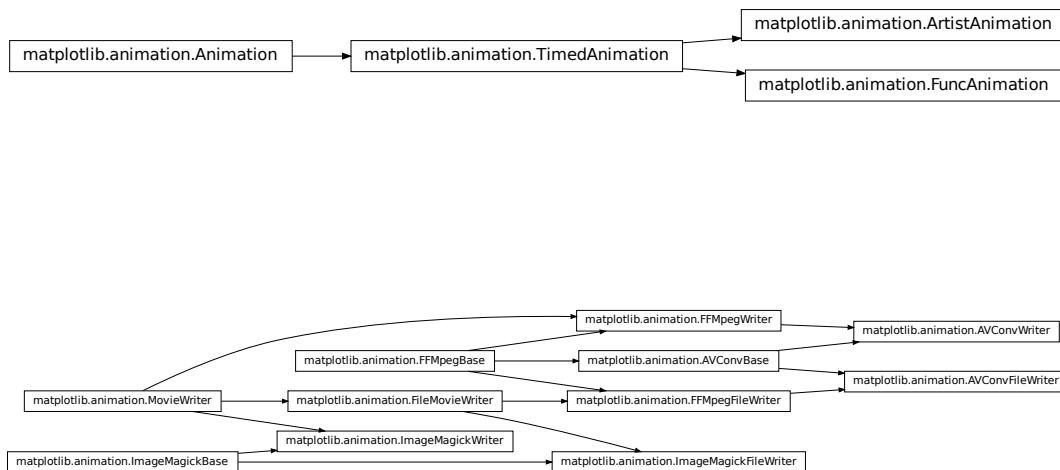

17.5 Deprecated

MencoderBase

MencoderFileWriter

Deprecated since version 2.0.

Continued on next page

Table 17.35 – continued from previous page

MencoderWriter

Deprecated since version 2.0.

17.5.1 matplotlib.animation.MencoderBase

class matplotlib.animation.MencoderBase**__init__**()

Initialize self. See help(type(self)) for accurate signature.

Attributes

allowed_metadata

args_key

exec_key

output_args

17.5.2 matplotlib.animation.MencoderFileWriter

class matplotlib.animation.MencoderFileWriter(*args, **kwargs)

Deprecated since version 2.0: Support for mencoder is only partially functional, and will be removed entirely in 2.2. Please use ffmpeg instead.

__init__(*args, **kwargs)

Deprecated since version 2.0: Support for mencoder is only partially functional, and will be removed entirely in 2.2. Please use ffmpeg instead.

Methods

__init__(*args, **kwargs)

Deprecated since version 2.0.

bin_path()

Returns the binary path to the commandline tool used by a specific subclass.

cleanup()

finish()

grab_frame(**savefig_kwargs)

Grab the image information from the figure and save as a movie frame.

isAvailable()

Check to see if a MovieWriter subclass is actually available by running the commandline tool.

saving(*args, **kw)

Context manager to facilitate writing the movie file.

Continued on next page

Table 17.37 – continued from previous page

<code>setup(fig, outfile, dpi[, frame_prefix, ...])</code>	Perform setup for writing the movie file.
------------------------------------------------------------	-------------------------------------------

Attributes

<code>allowed_metadata</code>	
<code>args_key</code>	
<code>exec_key</code>	
<code>frame_format</code>	Format (png, jpeg, etc.) to use for saving the frames, which can be decided by the individual subclasses.
<code>frame_size</code>	A tuple (width,height) in pixels of a movie frame.
<code>output_args</code>	
<code>supported_formats</code>	

17.5.3 matplotlib.animation.MencoderWriter

class `matplotlib.animation.MencoderWriter(*args, **kwargs)`

Deprecated since version 2.0: Support for mencoder is only partially functional, and will be removed entirely in 2.2. Please use ffmpeg instead.

__init__(*args, **kwargs)

Deprecated since version 2.0: Support for mencoder is only partially functional, and will be removed entirely in 2.2. Please use ffmpeg instead.

Methods

<code>__init__(*args, **kwargs)</code>	Deprecated since version 2.0.
<code>bin_path()</code>	Returns the binary path to the commandline tool used by a specific subclass.
<code>cleanup()</code>	Clean-up and collect the process used to write the movie file.
<code>finish()</code>	Finish any processing for writing the movie.
<code>grab_frame(**savefig_kwargs)</code>	Grab the image information from the figure and save as a movie frame.
<code>isAvailable()</code>	Check to see if a MovieWriter subclass is actually available by running the commandline tool.
<code>saving(*args, **kw)</code>	Context manager to facilitate writing the movie file.
<code>setup(fig, outfile, dpi)</code>	Perform setup for writing the movie file.

Attributes

allowed_metadata

args_key

exec_key

frame_size A tuple (width,height) in pixels of a movie frame.

output_args

ARTIST MODULE

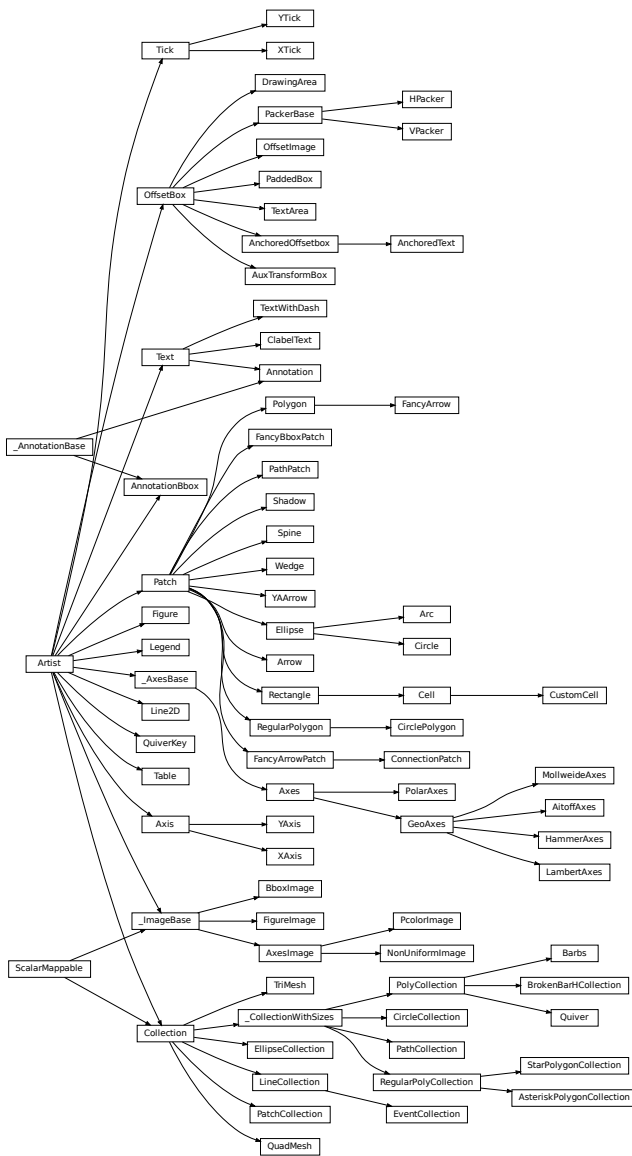

18.1 Artist class

class matplotlib.artist.Artist

Abstract base class for someone who renders into a `FigureCanvas`.

18.1.1 Interactive

<code>Artist.add_callback</code>	Adds a callback function that will be called whenever one of the <code>Artist</code> 's properties changes.
<code>Artist.format_cursor_data</code>	Return <code>cursor data</code> string formatted.
<code>Artist.get_contains</code>	Return the <code>_contains</code> test used by the artist, or <code>None</code> for default.
<code>Artist.get_cursor_data</code>	Get the cursor data for a given event.
<code>Artist.get_picker</code>	Return the picker object used by this artist
<code>Artist.hitlist</code>	List the children of the artist which contain the mouse event <code>event</code> .
<code>Artist.mouseover</code>	
<code>Artist.pchanged</code>	Fire an event when property changed, calling all of the registered callbacks.
<code>Artist.pick</code>	Process pick event
<code>Artist.pickable</code>	Return <code>True</code> if <code>Artist</code> is pickable.
<code>Artist.remove_callback</code>	Remove a callback based on its <code>id</code> .
<code>Artist.set_contains</code>	Replace the contains test used by this artist.
<code>Artist.set_picker</code>	Set the epsilon for picking used by this artist
<code>Artist.contains</code>	Test whether the artist contains the mouse event.

matplotlib.artist.Artist.add_callback

Artist.add_callback(*func*)

Adds a callback function that will be called whenever one of the `Artist`'s properties changes.

Returns an `id` that is useful for removing the callback with `remove_callback()` later.

matplotlib.artist.Artist.format_cursor_data

Artist.format_cursor_data(*data*)

Return `cursor data` string formatted.

matplotlib.artist.Artist.get_contains

Artist.get_contains()

Return the `_contains` test used by the artist, or `None` for default.

matplotlib.artist.Artist.get_cursor_data

`Artist.get_cursor_data(event)`
Get the cursor data for a given event.

matplotlib.artist.Artist.get_picker

`Artist.get_picker()`
Return the picker object used by this artist

matplotlib.artist.Artist.hitlist

`Artist.hitlist(event)`
List the children of the artist which contain the mouse event *event*.

matplotlib.artist.Artist.mouseover

`Artist.mouseover`

matplotlib.artist.Artist.pchanged

`Artist.pchanged()`
Fire an event when property changed, calling all of the registered callbacks.

matplotlib.artist.Artist.pick

`Artist.pick(mouseevent)`
Process pick event
each child artist will fire a pick event if *mouseevent* is over the artist and the artist has picker set

matplotlib.artist.Artist.pickable

`Artist.pickable()`
Return *True* if *Artist* is pickable.

matplotlib.artist.Artist.remove_callback

`Artist.remove_callback(oid)`
Remove a callback based on its *id*.

See also:

`add_callback()` For adding callbacks

matplotlib.artist.Artist.set_contains

`Artist.set_contains(picker)`

Replace the contains test used by this artist. The new picker should be a callable function which determines whether the artist is hit by the mouse event:

```
hit, props = picker(artist, mouseevent)
```

If the mouse event is over the artist, return `hit = True` and `props` is a dictionary of properties you want returned with the contains test.

ACCEPTS: a callable function

matplotlib.artist.Artist.set_picker

`Artist.set_picker(picker)`

Set the epsilon for picking used by this artist

`picker` can be one of the following:

- *None*: picking is disabled for this artist (default)
- A boolean: if *True* then picking will be enabled and the artist will fire a pick event if the mouse event is over the artist
- A float: if `picker` is a number it is interpreted as an epsilon tolerance in points and the artist will fire off an event if it's data is within epsilon of the mouse event. For some artists like lines and patch collections, the artist may provide additional data to the pick event that is generated, e.g., the indices of the data within epsilon of the pick event
- A function: if `picker` is callable, it is a user supplied function which determines whether the artist is hit by the mouse event:

```
hit, props = picker(artist, mouseevent)
```

to determine the hit test. if the mouse event is over the artist, return `hit=True` and `props` is a dictionary of properties you want added to the `PickEvent` attributes.

ACCEPTS: [None|float|boolean|callable]

matplotlib.artist.Artist.contains

`Artist.contains(mouseevent)`

Test whether the artist contains the mouse event.

Returns the truth value and a dictionary of artist specific details of selection, such as which points are contained in the pick radius. See individual artists for details.

18.1.2 Margins and Autoscaling

*Artist.sticky_edges*x and y sticky edge lists.

matplotlib.artist.Artist.sticky_edges

Artist.sticky_edges

x and y sticky edge lists.

When performing autoscaling, if a data limit coincides with a value in the corresponding `sticky_edges` list, then no margin will be added—the view limit “sticks” to the edge. A typical usecase is histograms, where one usually expects no margin on the bottom edge (0) of the histogram.

This attribute cannot be assigned to; however, the x and y lists can be modified in place as needed.

Examples

```
>>> artist.sticky_edges.x[:] = (xmin, xmax)
>>> artist.sticky_edges.y[:] = (ymin, ymax)
```

18.1.3 Clipping

Artist.get_clip_box

Return artist clipbox

Artist.get_clip_on

Return whether artist uses clipping

Artist.get_clip_path

Return artist clip path

*Artist.set_clip_box*Set the artist’s clip *Bbox*.

Artist.set_clip_on

Set whether artist uses clipping.

*Artist.set_clip_path*Set the artist’s clip path, which may be:

matplotlib.artist.Artist.get_clip_box

Artist.get_clip_box()

Return artist clipbox

matplotlib.artist.Artist.get_clip_on

Artist.get_clip_on()

Return whether artist uses clipping

matplotlib.artist.Artist.get_clip_path

Artist.get_clip_path()

Return artist clip path

matplotlib.artist.Artist.set_clip_box**Artist.set_clip_box**(*clipbox*)Set the artist's clip *Bbox*.ACCEPTS: a *matplotlib.transforms.Bbox* instance**matplotlib.artist.Artist.set_clip_on****Artist.set_clip_on**(*b*)

Set whether artist uses clipping.

When False artists will be visible out side of the axes which can lead to unexpected results.

ACCEPTS: [True | False]

matplotlib.artist.Artist.set_clip_path**Artist.set_clip_path**(*path*, *transform=None*)

Set the artist's clip path, which may be:

- a *Patch* (or subclass) instance
- a *Path* instance, in which case an optional *Transform* instance may be provided, which will be applied to the path before using it for clipping.
- *None*, to remove the clipping path

For efficiency, if the path happens to be an axis-aligned rectangle, this method will set the clipping box to the corresponding rectangle and set the clipping path to *None*.

ACCEPTS: [(*Path*, *Transform*) | *Patch* | None]**18.1.4 Bulk Properties**

<i>Artist.update</i>	Update the properties of this <i>Artist</i> from the dictionary <i>prop</i> .
<i>Artist.update_from</i>	Copy properties from <i>other</i> to <i>self</i> .
<i>Artist.properties</i>	return a dictionary mapping property name -> value for all Artist props
<i>Artist.set</i>	A property batch setter.

matplotlib.artist.Artist.update**Artist.update**(*props*)Update the properties of this *Artist* from the dictionary *prop*.

matplotlib.artist.Artist.update_from

`Artist.update_from(other)`
 Copy properties from *other* to *self*.

matplotlib.artist.Artist.properties

`Artist.properties()`
 return a dictionary mapping property name -> value for all Artist props

matplotlib.artist.Artist.set

`Artist.set(**kwargs)`
 A property batch setter. Pass *kwargs* to set properties.

18.1.5 Drawing

<code>Artist.draw</code>	Derived classes drawing method
<code>Artist.get_animated</code>	Return the artist's animated state
<code>Artist.set_animated</code>	Set the artist's animation state.
<code>Artist.get_agg_filter</code>	return filter function to be used for agg filter
<code>Artist.get_alpha</code>	Return the alpha value used for blending - not supported on all
<code>Artist.get_snap</code>	Returns the snap setting which may be:
<code>Artist.get_visible</code>	Return the artist's visibility
<code>Artist.get_zorder</code>	Return the <i>Artist</i> 's zorder.
<code>Artist.set_agg_filter</code>	set <code>agg_filter</code> fuction.
<code>Artist.set_alpha</code>	Set the alpha value used for blending - not supported on all backends.
<code>Artist.set_sketch_params</code>	Sets the sketch parameters.
<code>Artist.set_snap</code>	Sets the snap setting which may be:
<code>Artist.get_rasterized</code>	return True if the artist is to be rasterized
<code>Artist.get_sketch_params</code>	Returns the sketch parameters for the artist.
<code>Artist.set_path_effects</code>	set <code>path_effects</code> , which should be a list of instances of
<code>Artist.set_rasterized</code>	Force rasterized (bitmap) drawing in vector backend output.
<code>Artist.zorder</code>	
<code>Artist.set_visible</code>	Set the artist's visibility.
<code>Artist.set_zorder</code>	Set the zorder for the artist.
<code>Artist.get_window_extent</code>	Get the axes bounding box in display space.
<code>Artist.get_path_effects</code>	
<code>Artist.get_transformed_clip_path_and_affine</code>	Return the clip path with the non-affine part of its transformation applied, and the remaining affine part of its transformation.

matplotlib.artist.Artist.draw

`Artist.draw(renderer, *args, **kwargs)`

Derived classes drawing method

matplotlib.artist.Artist.get_animated

`Artist.get_animated()`

Return the artist's animated state

matplotlib.artist.Artist.set_animated

`Artist.set_animated(b)`

Set the artist's animation state.

ACCEPTS: [True | False]

matplotlib.artist.Artist.get_agg_filter

`Artist.get_agg_filter()`

return filter function to be used for agg filter

matplotlib.artist.Artist.get_alpha

`Artist.get_alpha()`

Return the alpha value used for blending - not supported on all backends

matplotlib.artist.Artist.get_snap

`Artist.get_snap()`

Returns the snap setting which may be:

- True: snap vertices to the nearest pixel center
- False: leave vertices as-is
- None: (auto) If the path contains only rectilinear line segments, round to the nearest pixel center

Only supported by the Agg and MacOSX backends.

matplotlib.artist.Artist.get_visible

`Artist.get_visible()`

Return the artist's visibility

matplotlib.artist.Artist.get_zorder

`Artist.get_zorder()`

Return the *Artist*'s zorder.

matplotlib.artist.Artist.set_agg_filter

`Artist.set_agg_filter(filter_func)`

set `agg_filter` fuction.

matplotlib.artist.Artist.set_alpha

`Artist.set_alpha(alpha)`

Set the alpha value used for blending - not supported on all backends.

ACCEPTS: float (0.0 transparent through 1.0 opaque)

matplotlib.artist.Artist.set_sketch_params

`Artist.set_sketch_params(scale=None, length=None, randomness=None)`

Sets the sketch parameters.

Parameters scale : float, optional

The amplitude of the wiggle perpendicular to the source line, in pixels. If scale is `None`, or not provided, no sketch filter will be provided.

length : float, optional

The length of the wiggle along the line, in pixels (default 128.0)

randomness : float, optional

The scale factor by which the length is shrunken or expanded (default 16.0)

matplotlib.artist.Artist.set_snap

`Artist.set_snap(snap)`

Sets the snap setting which may be:

- True: snap vertices to the nearest pixel center
- False: leave vertices as-is
- None: (auto) If the path contains only rectilinear line segments, round to the nearest pixel center

Only supported by the Agg and MacOSX backends.

`matplotlib.artist.Artist.get_rasterized`

`Artist.get_rasterized()`

return True if the artist is to be rasterized

`matplotlib.artist.Artist.get_sketch_params`

`Artist.get_sketch_params()`

Returns the sketch parameters for the artist.

Returns sketch_params : tuple or None

A 3-tuple with the following elements:

- scale: The amplitude of the wiggle perpendicular to the source line.
- length: The length of the wiggle along the line.
- randomness: The scale factor by which the length is shrunken or expanded.

May return None if no sketch parameters were set.

`matplotlib.artist.Artist.set_path_effects`

`Artist.set_path_effects(path_effects)`

set path_effects, which should be a list of instances of `matplotlib.patheffect._Base` class or its derivatives.

`matplotlib.artist.Artist.set_rasterized`

`Artist.set_rasterized(rasterized)`

Force rasterized (bitmap) drawing in vector backend output.

Defaults to None, which implies the backend's default behavior

ACCEPTS: [True | False | None]

`matplotlib.artist.Artist.zorder`

`Artist.zorder = 0`

`matplotlib.artist.Artist.set_visible`

`Artist.set_visible(b)`

Set the artist's visibility.

ACCEPTS: [True | False]

matplotlib.artist.Artist.set_zorder

`Artist.set_zorder(level)`

Set the zorder for the artist. Artists with lower zorder values are drawn first.

ACCEPTS: any number

matplotlib.artist.Artist.get_window_extent

`Artist.get_window_extent(renderer)`

Get the axes bounding box in display space. Subclasses should override for inclusion in the bounding box “tight” calculation. Default is to return an empty bounding box at 0, 0.

Be careful when using this function, the results will not update if the artist window extent of the artist changes. The extent can change due to any changes in the transform stack, such as changing the axes limits, the figure size, or the canvas used (as is done when saving a figure). This can lead to unexpected behavior where interactive figures will look fine on the screen, but will save incorrectly.

matplotlib.artist.Artist.get_path_effects

`Artist.get_path_effects()`

matplotlib.artist.Artist.get_transformed_clip_path_and_affine

`Artist.get_transformed_clip_path_and_affine()`

Return the clip path with the non-affine part of its transformation applied, and the remaining affine part of its transformation.

18.1.6 Figure and Axes

<code>Artist.remove</code>	Remove the artist from the figure if possible.
<code>Artist.axes</code>	The <i>Axes</i> instance the artist resides in, or <i>None</i> .
<code>Artist.get_axes</code>	Return the <i>Axes</i> instance the artist resides in, or <i>None</i> .
<code>Artist.set_axes</code>	Set the <i>Axes</i> instance in which the artist resides, if any.
<code>Artist.set_figure</code>	Set the <i>Figure</i> instance the artist belongs to.
<code>Artist.get_figure</code>	Return the <i>Figure</i> instance the artist belongs to.
<code>Artist.is_figure_set</code>	Returns True if the artist is assigned to a <i>Figure</i> .

matplotlib.artist.Artist.remove

`Artist.remove()`

Remove the artist from the figure if possible. The effect will not be visible until the figure is redrawn, e.g., with `matplotlib.axes.Axes.draw_idle()`. Call `matplotlib.axes.Axes.relim()` to

update the axes limits if desired.

Note: `relim()` will not see collections even if the collection was added to axes with `autolim = True`.

Note: there is no support for removing the artist's legend entry.

matplotlib.artist.Artist.axes

Artist.axes

The *Axes* instance the artist resides in, or *None*.

matplotlib.artist.Artist.get_axes

Artist.get_axes()

Return the *Axes* instance the artist resides in, or *None*.

This has been deprecated in mpl 1.5, please use the axes property. Will be removed in 1.7 or 2.0.

matplotlib.artist.Artist.set_axes

Artist.set_axes(*axes*)

Set the *Axes* instance in which the artist resides, if any.

This has been deprecated in mpl 1.5, please use the axes property. Will be removed in 1.7 or 2.0.

ACCEPTS: an *Axes* instance

matplotlib.artist.Artist.set_figure

Artist.set_figure(*fig*)

Set the *Figure* instance the artist belongs to.

ACCEPTS: a `matplotlib.figure.Figure` instance

matplotlib.artist.Artist.get_figure

Artist.get_figure()

Return the *Figure* instance the artist belongs to.

matplotlib.artist.Artist.is_figure_set

Artist.is_figure_set()

Returns True if the artist is assigned to a *Figure*.

18.1.7 Children

<code>Artist.get_children</code>	Return a list of the child <code>Artist</code> 's <code>this :class:`Artist</code> contains.
<code>Artist.findobj</code>	Find artist objects.

matplotlib.artist.Artist.get_children

Artist.get_children()

Return a list of the child `Artist`'s `this :class:`Artist` contains.

matplotlib.artist.Artist.findobj

Artist.findobj(*match=None, include_self=True*)

Find artist objects.

Recursively find all `Artist` instances contained in self.

match can be

- None: return all objects contained in artist.
- function with signature `boolean = match(artist)` used to filter matches
- class instance: e.g., `Line2D`. Only return artists of class type.

If *include_self* is `True` (default), include self in the list to be checked for a match.

18.1.8 Transform

<code>Artist.set_transform</code>	Set the <code>Transform</code> instance used by this artist.
<code>Artist.get_transform</code>	Return the <code>Transform</code> instance used by this artist.
<code>Artist.is_transform_set</code>	Returns <code>True</code> if <code>Artist</code> has a transform explicitly set.

matplotlib.artist.Artist.set_transform

Artist.set_transform(*t*)

Set the `Transform` instance used by this artist.

ACCEPTS: `Transform` instance

matplotlib.artist.Artist.get_transform

Artist.get_transform()

Return the `Transform` instance used by this artist.

matplotlib.artist.Artist.is_transform_set**Artist.is_transform_set()**

Returns *True* if *Artist* has a transform explicitly set.

18.1.9 Units

<i>Artist.convert_xunits</i>	For artists in an axes, if the xaxis has units support,
<i>Artist.convert_yunits</i>	For artists in an axes, if the yaxis has units support,
<i>Artist.have_units</i>	Return <i>True</i> if units are set on the <i>x</i> or <i>y</i> axes

matplotlib.artist.Artist.convert_xunits**Artist.convert_xunits(*x*)**

For artists in an axes, if the xaxis has units support, convert *x* using xaxis unit type

matplotlib.artist.Artist.convert_yunits**Artist.convert_yunits(*y*)**

For artists in an axes, if the yaxis has units support, convert *y* using yaxis unit type

matplotlib.artist.Artist.have_units**Artist.have_units()**

Return *True* if units are set on the *x* or *y* axes

18.1.10 Metadata

<i>Artist.get_gid</i>	Returns the group id
<i>Artist.get_label</i>	Get the label used for this artist in the legend.
<i>Artist.set_gid</i>	Sets the (group) id for the artist
<i>Artist.set_label</i>	Set the label to <i>s</i> for auto legend.
<i>Artist.get_url</i>	Returns the url
<i>Artist.set_url</i>	Sets the url for the artist
<i>Artist.aname</i>	

matplotlib.artist.Artist.get_gid**Artist.get_gid()**

Returns the group id

matplotlib.artist.Artist.get_label

Artist.get_label()

Get the label used for this artist in the legend.

matplotlib.artist.Artist.set_gid

Artist.set_gid(*gid*)

Sets the (group) id for the artist

ACCEPTS: an id string

matplotlib.artist.Artist.set_label

Artist.set_label(*s*)

Set the label to *s* for auto legend.

ACCEPTS: string or anything printable with ‘%s’ conversion.

matplotlib.artist.Artist.get_url

Artist.get_url()

Returns the url

matplotlib.artist.Artist.set_url

Artist.set_url(*url*)

Sets the url for the artist

ACCEPTS: a url string

matplotlib.artist.Artist.aname

Artist.aname = ‘Artist’

18.1.11 Stale

Artist.stale

If the artist is ‘stale’ and needs to be re-drawn for the output to match the internal state of the artist.

matplotlib.artist.Artist.stale**Artist.stale**

If the artist is ‘stale’ and needs to be re-drawn for the output to match the internal state of the artist.

18.2 Functions

<i>allow_rasterization</i>	Decorator for Artist.draw method.
<i>get</i>	Return the value of object’s property.
<i>getp</i>	Return the value of object’s property.
<i>setp</i>	Set a property on an artist object.
<i>kwdoc</i>	
<i>ArtistInspector</i>	A helper class to inspect an <i>Artist</i> and return information about it’s settable properties and their current values.

18.2.1 matplotlib.artist.allow_rasterization**matplotlib.artist.allow_rasterization(*draw*)**

Decorator for Artist.draw method. Provides routines that run before and after the draw call. The before and after functions are useful for changing artist-dependant renderer attributes or making other setup function calls, such as starting and flushing a mixed-mode renderer.

18.2.2 matplotlib.artist.get**matplotlib.artist.get(*obj*, *property=None*)**

Return the value of object’s property. *property* is an optional string for the property you want to return

Example usage:

```
getp(obj) # get all the object properties
getp(obj, 'linestyle') # get the linestyle property
```

obj is a *Artist* instance, e.g., *Line2D* or an instance of a *Axes* or *matplotlib.text.Text*. If the *property* is ‘somename’, this function returns

```
obj.get_somename()
```

getp() can be used to query all the gettable properties with *getp(obj)*. Many properties have aliases for shorter typing, e.g. ‘lw’ is an alias for ‘linewidth’. In the output, aliases and full property names will be listed as:

```
property or alias = value
```

e.g.:

```
linewidth or lw = 2
```

18.2.3 matplotlib.artist.getp

`matplotlib.artist.getp(obj, property=None)`

Return the value of object's property. *property* is an optional string for the property you want to return

Example usage:

```
getp(obj) # get all the object properties
getp(obj, 'linestyle') # get the linestyle property
```

obj is a *Artist* instance, e.g., *Line2D* or an instance of a *Axes* or *matplotlib.text.Text*. If the *property* is 'somename', this function returns

```
obj.get_somename()
```

getp() can be used to query all the gettable properties with *getp(obj)*. Many properties have aliases for shorter typing, e.g. 'lw' is an alias for 'linewidth'. In the output, aliases and full property names will be listed as:

```
property or alias = value
```

e.g.:

```
linewidth or lw = 2
```

18.2.4 matplotlib.artist.setp

`matplotlib.artist.setp(obj, *args, **kwargs)`

Set a property on an artist object.

matplotlib supports the use of *setp()* ("set property") and *getp()* to set and get object properties, as well as to do introspection on the object. For example, to set the linestyle of a line to be dashed, you can do:

```
>>> line, = plot([1,2,3])
>>> setp(line, linestyle='--')
```

If you want to know the valid types of arguments, you can provide the name of the property you want to set without a value:

```
>>> setp(line, 'linestyle')
linestyle: [ '-' | '--' | '-.' | ':' | 'steps' | 'None' ]
```

If you want to see all the properties that can be set, and their possible values, you can do:

```
>>> setp(line)
... long output listing omitted
```

setp() operates on a single instance or a list of instances. If you are in query mode introspecting the possible values, only the first instance in the sequence is used. When actually setting values, all the

instances will be set. e.g., suppose you have a list of two lines, the following will make both lines thicker and red:

```
>>> x = arange(0,1.0,0.01)
>>> y1 = sin(2*pi*x)
>>> y2 = sin(4*pi*x)
>>> lines = plot(x, y1, x, y2)
>>> setp(lines, linewidth=2, color='r')
```

`setp()` works with the MATLAB style string/value pairs or with python kwargs. For example, the following are equivalent:

```
>>> setp(lines, 'linewidth', 2, 'color', 'r') # MATLAB style
>>> setp(lines, linewidth=2, color='r')      # python style
```

18.2.5 matplotlib.artist.kwdoc

`matplotlib.artist.kwdoc(a)`

18.2.6 matplotlib.artist.ArtistInspector

`class matplotlib.artist.ArtistInspector(o)`

A helper class to inspect an *Artist* and return information about its settable properties and their current values.

Initialize the artist inspector with an *Artist* or sequence of *Artists*. If a sequence is used, we assume it is a homogeneous sequence (all *Artists* are of the same type) and it is your responsibility to make sure this is so.

`__init__(o)`

Initialize the artist inspector with an *Artist* or sequence of *Artists*. If a sequence is used, we assume it is a homogeneous sequence (all *Artists* are of the same type) and it is your responsibility to make sure this is so.

Methods

<code>__init__(o)</code>	Initialize the artist inspector with an <i>Artist</i> or sequence of <i>Artists</i> .
<code>aliased_name(s)</code>	return 'PROPNAME or alias' if <i>s</i> has an alias, else return
<code>aliased_name_rest(s, target)</code>	return 'PROPNAME or alias' if <i>s</i> has an alias, else return
<code>findobj([match])</code>	Recursively find all <code>matplotlib.artist.Artist</code> instances contained in <i>self</i> .

Continued on next page

Table 18.13 – continued from previous page

<code>get_aliases()</code>	Get a dict mapping <i>fullname</i> -> <i>alias</i> for each <i>alias</i> in the <i>ArtistInspector</i> .
<code>get_setters()</code>	Get the attribute strings with setters for object.
<code>get_valid_values(attr)</code>	Get the legal arguments for the setter associated with <i>attr</i> .
<code>is_alias(o)</code>	Return <i>True</i> if method object <i>o</i> is an alias for another function.
<code>pprint_getters()</code>	Return the getters and actual values as list of strings.
<code>pprint_setters([prop, leadingspace])</code>	If <i>prop</i> is <i>None</i> , return a list of strings of all settable properties and their valid values.
<code>pprint_setters_rest([prop, leadingspace])</code>	If <i>prop</i> is <i>None</i> , return a list of strings of all settable properties and their valid values.
<code>properties()</code>	return a dictionary mapping property name -> value

AXES CLASS

```
class matplotlib.axes.Axes(fig, rect, facecolor=None, frameon=True, sharex=None,
                             sharey=None, label='', xscale=None, yscale=None, axisbg=None,
                             **kwargs)
```

The *Axes* contains most of the figure elements: *Axis*, *Tick*, *Line2D*, *Text*, *Polygon*, etc., and sets the coordinate system.

The *Axes* instance supports callbacks through a *callbacks* attribute which is a *CallbackRegistry* instance. The events you can connect to are 'xlim_changed' and 'ylim_changed' and the callback will be called with `func(ax)` where *ax* is the *Axes* instance.

Table of Contents

- *Plotting*
 - *Basic*
 - *Spans*
 - *Spectral*
 - *Statistics*
 - *Binned*
 - *Contours*
 - *Array*
 - *Unstructured Triangles*
 - *Text and Annotations*
 - *Fields*
- *Clearing*
- *Appearance*
- *Property cycle*
- *Axis / limits*
 - *Axis Limits and direction*

- *Axis Labels, title, and legend*
- *Axis scales*
- *Autoscaling and margins*
- *Aspect ratio*
- *Ticks and tick labels*
- *Units*
- *Adding Artists*
- *Twinning*
- *Axes Position*
- *Async/Event based*
- *Interactive*
- *Children*
- *Drawing*
- *Bulk property manipulation*
- *General Artist Properties*
- *Artist Methods*
- *Projection*
- *Other*
- *Inheritance*

19.1 Plotting

19.1.1 Basic

<code>Axes.plot</code>	Plot lines and/or markers to the <i>Axes</i> .
<code>Axes.errorbar</code>	Plot an errorbar graph.
<code>Axes.scatter</code>	Make a scatter plot of <i>x</i> vs <i>y</i>
<code>Axes.plot_date</code>	A plot with data that contains dates.
<code>Axes.step</code>	Make a step plot.
<code>Axes.loglog</code>	Make a plot with log scaling on both the <i>x</i> and <i>y</i> axis.
<code>Axes.semilogx</code>	Make a plot with log scaling on the <i>x</i> axis.
<code>Axes.semilogy</code>	Make a plot with log scaling on the <i>y</i> axis.
<code>Axes.fill_between</code>	Make filled polygons between two curves.
<code>Axes.fill_betweenx</code>	Make filled polygons between two horizontal curves.

Continued on next page

Table 19.1 – continued from previous page

<code>Axes.bar</code>	Make a bar plot.
<code>Axes.barh</code>	Make a horizontal bar plot.
<code>Axes.stem</code>	Create a stem plot.
<code>Axes.eventplot</code>	Plot identical parallel lines at specific positions.
<code>Axes.pie</code>	Plot a pie chart.
<code>Axes.stackplot</code>	Draws a stacked area plot.
<code>Axes.broken_barh</code>	Plot horizontal bars.
<code>Axes.vlines</code>	Plot vertical lines.
<code>Axes.hlines</code>	Plot horizontal lines at each <code>y</code> from <code>xmin</code> to <code>xmax</code> .
<code>Axes.fill</code>	Plot filled polygons.

matplotlib.axes.Axes.plot**Axes.plot**(**args*, ***kwargs*)

Plot lines and/or markers to the *Axes*. *args* is a variable length argument, allowing for multiple *x*, *y* pairs with an optional format string. For example, each of the following is legal:

```
plot(x, y)           # plot x and y using default line style and color
plot(x, y, 'bo')    # plot x and y using blue circle markers
plot(y)             # plot y using x as index array 0..N-1
plot(y, 'r+')       # ditto, but with red plusses
```

If *x* and/or *y* is 2-dimensional, then the corresponding columns will be plotted.

If used with labeled data, make sure that the color spec is not included as an element in data, as otherwise the last case `plot("v", "r", data={"v":..., "r":...})` can be interpreted as the first case which would do `plot(v, r)` using the default line style and color.

If not used with labeled data (i.e., without a data argument), an arbitrary number of *x*, *y*, *fmt* groups can be specified, as in:

```
a.plot(x1, y1, 'g^', x2, y2, 'g-')
```

Return value is a list of lines that were added.

By default, each line is assigned a different style specified by a ‘style cycle’. To change this behavior, you can edit the `axes.prop_cycle` rcParam.

The following format string characters are accepted to control the line style or marker:

character	description
' - '	solid line style
' -- '	dashed line style
' - . '	dash-dot line style
' : '	dotted line style
' . '	point marker
' , '	pixel marker
' o '	circle marker
' v '	triangle_down marker
' ^ '	triangle_up marker
' < '	triangle_left marker
' > '	triangle_right marker
' 1 '	tri_down marker
' 2 '	tri_up marker
' 3 '	tri_left marker
' 4 '	tri_right marker
' s '	square marker
' p '	pentagon marker
' * '	star marker
' h '	hexagon1 marker
' H '	hexagon2 marker
' + '	plus marker
' x '	x marker
' D '	diamond marker
' d '	thin_diamond marker
' '	vline marker
' _ '	hline marker

The following color abbreviations are supported:

character	color
' b '	blue
' g '	green
' r '	red
' c '	cyan
' m '	magenta
' y '	yellow
' k '	black
' w '	white

In addition, you can specify colors in many weird and wonderful ways, including full names ('green'), hex strings ('#008000'), RGB or RGBA tuples ((0, 1, 0, 1)) or grayscale intensities as a string ('0.8'). Of these, the string specifications can be used in place of a `fmt` group, but the tuple forms can be used only as `kwargs`.

Line styles and colors are combined in a single format string, as in 'bo' for blue circles.

The `kwargs` can be used to set line properties (any property that has a `set_*` method). You can use this to set a line label (for auto legends), linewidth, antialiasing, marker face color, etc. Here is an

example:

```
plot([1,2,3], [1,2,3], 'go-', label='line 1', linewidth=2)
plot([1,2,3], [1,4,9], 'rs', label='line 2')
axis([0, 4, 0, 10])
legend()
```

If you make multiple lines with one plot command, the kwargs apply to all those lines, e.g.:

```
plot(x1, y1, x2, y2, antialiased=False)
```

Neither line will be antialiased.

You do not need to use format strings, which are just abbreviations. All of the line properties can be controlled by keyword arguments. For example, you can set the color, marker, linestyle, and markercolor with:

```
plot(x, y, color='green', linestyle='dashed', marker='o',
     markerfacecolor='blue', markersize=12).
```

See [Line2D](#) for details.

The kwargs are [Line2D](#) properties:

Property	Description
<i>agg_filter</i>	unknown
<i>alpha</i>	float (0.0 transparent through 1.0 opaque)
<i>animated</i>	[True False]
<i>antialiased</i> or <i>aa</i>	[True False]
<i>axes</i>	an <i>Axes</i> instance
<i>clip_box</i>	a <i>matplotlib.transforms.Bbox</i> instance
<i>clip_on</i>	[True False]
<i>clip_path</i>	[(<i>Path</i> , <i>Transform</i>) <i>Patch</i> None]
<i>color</i> or <i>c</i>	any matplotlib color
<i>contains</i>	a callable function
<i>dash_capstyle</i>	['butt' 'round' 'projecting']
<i>dash_joinstyle</i>	['miter' 'round' 'bevel']
<i>dashes</i>	sequence of on/off ink in points
<i>drawstyle</i>	['default' 'steps' 'steps-pre' 'steps-mid' 'steps-post']
<i>figure</i>	a <i>matplotlib.figure.Figure</i> instance
<i>fillstyle</i>	['full' 'left' 'right' 'bottom' 'top' 'none']
<i>gid</i>	an id string
<i>label</i>	string or anything printable with '%s' conversion.
<i>linestyle</i> or <i>ls</i>	['solid' 'dashed', 'dashdot', 'dotted' (offset, on-off-dash-seq) '-' '--' '-.' ' ']
<i>linewidth</i> or <i>lw</i>	float value in points
<i>marker</i>	<i>A valid marker style</i>
<i>markeredgecolor</i> or <i>mec</i>	any matplotlib color
<i>markeredgewidth</i> or <i>mew</i>	float value in points

Table 19.2 – continued from previous page

Property	Description
<code>markerfacecolor</code> or <code>mfc</code>	any matplotlib color
<code>markerfacecoloralt</code> or <code>mfcalt</code>	any matplotlib color
<code>markersize</code> or <code>ms</code>	float
<code>markevery</code>	[None int length-2 tuple of int slice list/array of int float length-2 tuple of float]
<code>path_effects</code>	unknown
<code>picker</code>	float distance in points or callable pick function <code>fn(artist, event)</code>
<code>pickradius</code>	float distance in points
<code>rasterized</code>	[True False None]
<code>sketch_params</code>	unknown
<code>snap</code>	unknown
<code>solid_capstyle</code>	['butt' 'round' 'projecting']
<code>solid_joinstyle</code>	['miter' 'round' 'bevel']
<code>transform</code>	a <code>matplotlib.transforms.Transform</code> instance
<code>url</code>	a url string
<code>visible</code>	[True False]
<code>xdata</code>	1D array
<code>ydata</code>	1D array
<code>zorder</code>	any number

kwargs `scalex` and `scaley`, if defined, are passed on to `autoscale_view()` to determine whether the `x` and `y` axes are autoscaled; the default is `True`.

Note: In addition to the above described arguments, this function can take a **data** keyword argument. If such a **data** argument is given, the following arguments are replaced by **data[<arg>]**:

- All arguments with the following names: 'x', 'y'.

matplotlib.axes.Axes.errorbar

Axes.errorbar(`x`, `y`, `yerr=None`, `xerr=None`, `fmt=''`, `ecolor=None`, `elinewidth=None`, `capsize=None`, `barsabove=False`, `lolims=False`, `uplims=False`, `xlolims=False`, `xuplims=False`, `errorevery=1`, `capthick=None`, `**kwargs`)

Plot an errorbar graph.

Plot `x` versus `y` with error deltas in `yerr` and `xerr`. Vertical errorbars are plotted if `yerr` is not `None`. Horizontal errorbars are plotted if `xerr` is not `None`.

`x`, `y`, `xerr`, and `yerr` can all be scalars, which plots a single error bar at `x`, `y`.

Parameters `x` : scalar or array-like

`y` : scalar or array-like

xerr/yerr : scalar or array-like, `shape(N,)` or `shape(2,N)`, optional

If a scalar number, len(N) array-like object, or a N-element array-like object, errorbars are drawn at +/-value relative to the data. Default is None.

If a sequence of shape 2xN, errorbars are drawn at -row1 and +row2 relative to the data.

fmt : plot format string, optional, default: None

The plot format symbol. If fmt is 'none' (case-insensitive), only the errorbars are plotted. This is used for adding errorbars to a bar plot, for example. Default is '', an empty plot format string; properties are then identical to the defaults for `plot()`.

ecolor : mpl color, optional, default: None

A matplotlib color arg which gives the color the errorbar lines; if None, use the color of the line connecting the markers.

elinewidth : scalar, optional, default: None

The linewidth of the errorbar lines. If None, use the linewidth.

capsize : scalar, optional, default: None

The length of the error bar caps in points; if None, it will take the value from `errorbar.capsize` *rcParam*.

capthick : scalar, optional, default: None

An alias kwarg to `markeredgewidth` (a.k.a. - mew). This setting is a more sensible name for the property that controls the thickness of the error bar cap in points. For backwards compatibility, if mew or `markeredgewidth` are given, then they will over-ride `capthick`. This may change in future releases.

barsabove : bool, optional, default: False

if True, will plot the errorbars above the plot symbols. Default is below.

lolims / uplims / xlolims / xuplims : bool, optional, default:None

These arguments can be used to indicate that a value gives only upper/lower limits. In that case a caret symbol is used to indicate this. `lims`-arguments may be of the same type as `xerr` and `yerr`. To use limits with inverted axes, `set_xlim()` or `set_ylim()` must be called before `errorbar()`.

errorevery : positive integer, optional, default:1

subsamples the errorbars. e.g., if `errorevery=5`, errorbars for every 5-th data-point will be plotted. The data plot itself still shows all data points.

Returns plotline : *Line2D* instance

x, y plot markers and/or line

caplines : list of *Line2D* instances

error bar cap

barlinecols : list of *LineCollection*

horizontal and vertical error ranges.

Other Parameters kwargs : All other keyword arguments are passed on to the plot

command for the markers. For example, this code makes big red squares with thick green edges:

```
x,y,yerr = rand(3,10)
errorbar(x, y, yerr, marker='s', mfc='red',
         mec='green', ms=20, mew=4)
```

where mfc, mec, ms and mew are aliases for the longer property names, markerfacecolor, markeredgewidth, markersize and markeredgewidth.

valid kwargs for the marker properties are

Property	Description
<i>agg_filter</i>	unknown
<i>alpha</i>	float (0.0 transparent through 1.0 opaque)
<i>animated</i>	[True False]
<i>antialiased</i> or <i>aa</i>	[True False]
<i>axes</i>	an <i>Axes</i> instance
<i>clip_box</i>	a <i>matplotlib.transforms.Bbox</i> instance
<i>clip_on</i>	[True False]
<i>clip_path</i>	[(<i>Path</i> , <i>Transform</i>) <i>Patch</i> None]
<i>color</i> or <i>c</i>	any matplotlib color
<i>contains</i>	a callable function
<i>dash_capstyle</i>	['butt' 'round' 'projecting']
<i>dash_joinstyle</i>	['miter' 'round' 'bevel']
<i>dashes</i>	sequence of on/off ink in points
<i>drawstyle</i>	['default' 'steps' 'steps-pre' 'steps-mid' 'steps-post']
<i>figure</i>	a <i>matplotlib.figure.Figure</i> instance
<i>fillstyle</i>	['full' 'left' 'right' 'bottom' 'top' 'none']
<i>gid</i>	an id string
<i>label</i>	string or anything printable with '%s' conversion.
<i>linestyle</i> or <i>ls</i>	['solid' 'dashed', 'dashdot', 'dotted' (offset, on-off-dash-seq) '-' '--' '-.' ' ']
<i>linewidth</i> or <i>lw</i>	float value in points
<i>marker</i>	<i>A valid marker style</i>
<i>markeredgecolor</i> or <i>mec</i>	any matplotlib color
<i>markeredgewidth</i> or <i>mew</i>	float value in points
<i>markerfacecolor</i> or <i>mfc</i>	any matplotlib color
<i>markerfacecoloralt</i> or <i>mfcalt</i>	any matplotlib color
<i>markersize</i> or <i>ms</i>	float
<i>markevery</i>	[None int length-2 tuple of int slice list/array of int float length-2 tuple of float]
<i>path_effects</i>	unknown
<i>picker</i>	float distance in points or callable pick function <i>fn(artist, event)</i>
<i>pickradius</i>	float distance in points
<i>rasterized</i>	[True False None]

Table 19.3 – continued from previous page

Property	Description
<code>sketch_params</code>	unknown
<code>snap</code>	unknown
<code>solid_capstyle</code>	['butt' 'round' 'projecting']
<code>solid_joinstyle</code>	['miter' 'round' 'bevel']
<code>transform</code>	a <code>matplotlib.transforms.Transform</code> instance
<code>url</code>	a url string
<code>visible</code>	[True False]
<code>xdata</code>	1D array
<code>ydata</code>	1D array
<code>zorder</code>	any number

Examples

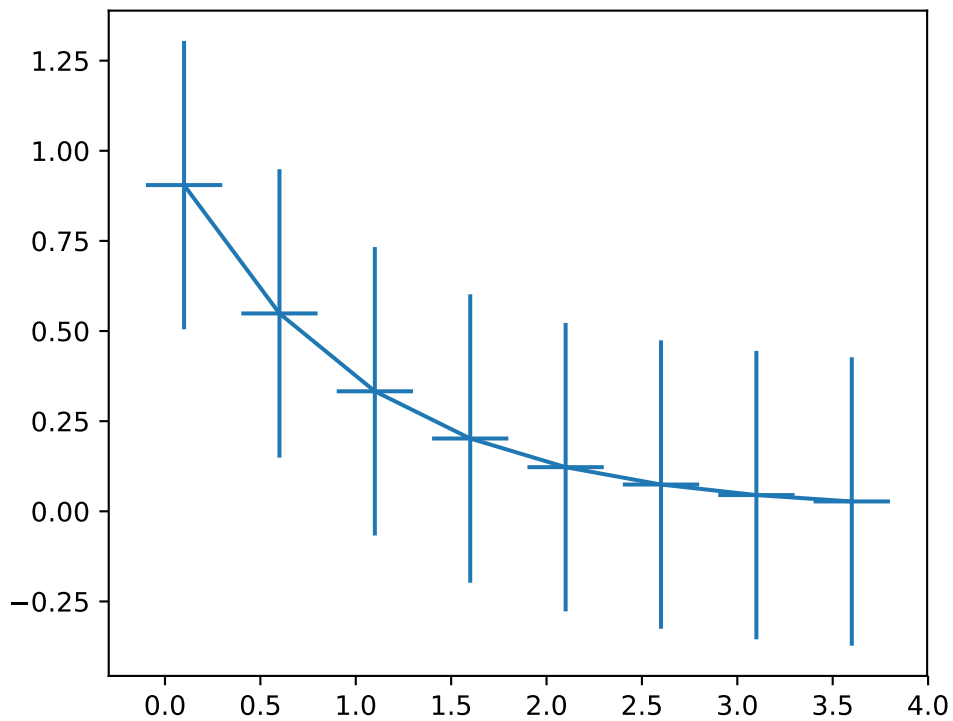

Note: In addition to the above described arguments, this function can take a **data** keyword argument. If such a **data** argument is given, the following arguments are replaced by **data[<arg>]**:

- All arguments with the following names: 'x', 'xerr', 'y', 'yerr'.

matplotlib.axes.Axes.scatter

Axes.scatter(*x*, *y*, *s=None*, *c=None*, *marker=None*, *cmap=None*, *norm=None*, *vmin=None*, *vmax=None*, *alpha=None*, *linewidths=None*, *verts=None*, *edgecolors=None*, ***kwargs*)

Make a scatter plot of *x* vs *y*

Marker size is scaled by *s* and marker color is mapped to *c*

Parameters *x*, *y* : array_like, shape (n,)

Input data

s : scalar or array_like, shape (n,), optional

size in points². Default is rcParams['lines.markersize'] ** 2.

c : color, sequence, or sequence of color, optional, default: 'b'

c can be a single color format string, or a sequence of color specifications of length *N*, or a sequence of *N* numbers to be mapped to colors using the *cmap* and *norm* specified via *kwargs* (see below). Note that *c* should not be a single numeric RGB or RGBA sequence because that is indistinguishable from an array of values to be colormapped. *c* can be a 2-D array in which the rows are RGB or RGBA, however, including the case of a single row to specify the same color for all points.

marker : *MarkerStyle*, optional, default: 'o'

See *markers* for more information on the different styles of markers scatter supports. *marker* can be either an instance of the class or the text shorthand for a particular marker.

cmap : *Colormap*, optional, default: None

A *Colormap* instance or registered name. *cmap* is only used if *c* is an array of floats. If None, defaults to rc image.cmap.

norm : *Normalize*, optional, default: None

A *Normalize* instance is used to scale luminance data to 0, 1. *norm* is only used if *c* is an array of floats. If None, use the default `normalize()`.

vmin, **vmax** : scalar, optional, default: None

vmin and *vmax* are used in conjunction with *norm* to normalize luminance data. If either are None, the min and max of the color array is used. Note if you pass a *norm* instance, your settings for *vmin* and *vmax* will be ignored.

alpha : scalar, optional, default: None

The alpha blending value, between 0 (transparent) and 1 (opaque)

linewidths : scalar or array_like, optional, default: None

If None, defaults to (lines.linewidth,).

verts : sequence of (x, y), optional

If `marker` is `None`, these vertices will be used to construct the marker. The center of the marker is located at (0,0) in normalized units. The overall marker is rescaled by `s`.

edgecolors : color or sequence of color, optional, default: `None`

If `None`, defaults to `'face'`

If `'face'`, the edge color will always be the same as the face color.

If it is `'none'`, the patch boundary will not be drawn.

For non-filled markers, the `edgecolors` kwarg is ignored and forced to `'face'` internally.

Returns paths : *PathCollection*

Other Parameters kwargs : *Collection* properties

See also:

plot to plot scatter plots when markers are identical in size and color

Notes

- The *plot* function will be faster for scatterplots where markers don't vary in size or color.
- Any or all of `x`, `y`, `s`, and `c` may be masked arrays, in which case all masks will be combined and only unmasked points will be plotted.

Fundamentally, scatter works with 1-D arrays; `x`, `y`, `s`, and `c` may be input as 2-D arrays, but within scatter they will be flattened. The exception is `c`, which will be flattened only if its size matches the size of `x` and `y`.

Examples

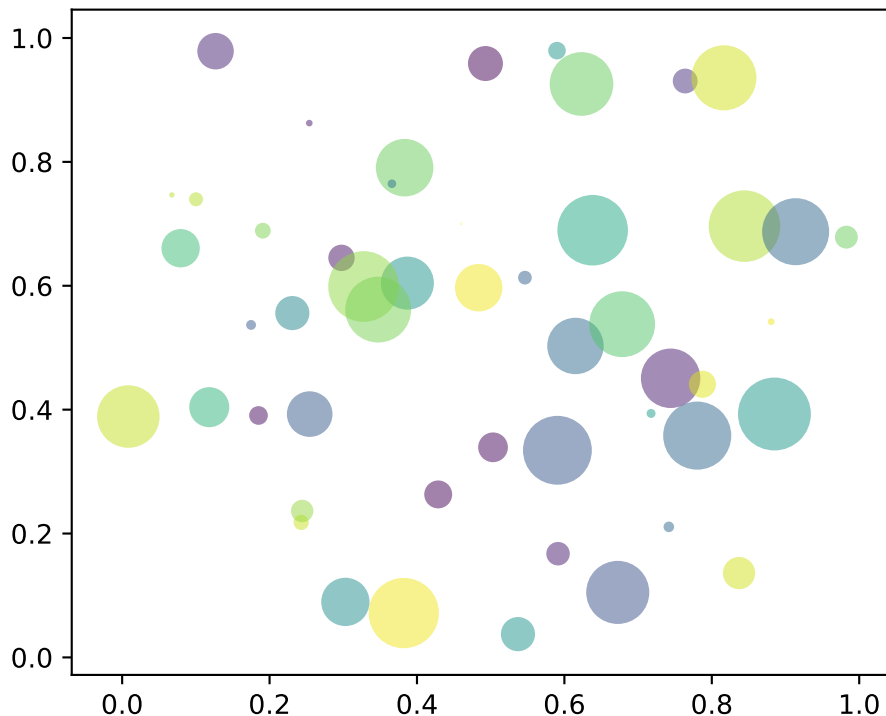

Note: In addition to the above described arguments, this function can take a **data** keyword argument. If such a **data** argument is given, the following arguments are replaced by **data[<arg>]**:

- All arguments with the following names: 'c', 'color', 'edgecolors', 'facecolor', 'facecolors', 'linewidths', 's', 'x', 'y'.
-

matplotlib.axes.Axes.plot_date

Axes.plot_date(*x*, *y*, *fmt*='o', *tz*=None, *xdate*=True, *ydate*=False, ***kwargs*)

A plot with data that contains dates.

Similar to the `plot()` command, except the *x* or *y* (or both) data is considered to be dates, and the axis is labeled accordingly.

x and/or *y* can be a sequence of dates represented as float days since 0001-01-01 UTC.

Note if you are using custom date tickers and formatters, it may be necessary to set the formatters/locators after the call to `meth:plot_date` since `meth:plot_date` will set the default tick locator to class:`matplotlib.dates.AutoDateLocator` (if the tick locator is not already set to a class:`matplotlib.dates.DateLocator` instance) and the default tick formatter

to class:`matplotlib.dates.AutoDateFormatter` (if the tick formatter is not already set to a class:`matplotlib.dates.DateFormatter` instance).

Parameters `fmt` : string

The plot format string.

`tz` : [*None* | timezone string | `tzinfo` instance]

The time zone to use in labeling dates. If *None*, defaults to rc value.

`xdate` : boolean

If *True*, the *x*-axis will be labeled with dates.

`ydate` : boolean

If *True*, the *y*-axis will be labeled with dates.

Returns lines

Other Parameters `kwargs` : `matplotlib.lines.Line2D`

properties :

Property	Description
<code>agg_filter</code>	unknown
<code>alpha</code>	float (0.0 transparent through 1.0 opaque)
<code>animated</code>	[True False]
<code>antialiased</code> or <code>aa</code>	[True False]
<code>axes</code>	an <code>Axes</code> instance
<code>clip_box</code>	a <code>matplotlib.transforms.Bbox</code> instance
<code>clip_on</code>	[True False]
<code>clip_path</code>	[(<code>Path</code> , <code>Transform</code>) <code>Patch</code> None]
<code>color</code> or <code>c</code>	any matplotlib color
<code>contains</code>	a callable function
<code>dash_capstyle</code>	['butt' 'round' 'projecting']
<code>dash_joinstyle</code>	['miter' 'round' 'bevel']
<code>dashes</code>	sequence of on/off ink in points
<code>drawstyle</code>	['default' 'steps' 'steps-pre' 'steps-mid' 'steps-post']
<code>figure</code>	a <code>matplotlib.figure.Figure</code> instance
<code>fillstyle</code>	['full' 'left' 'right' 'bottom' 'top' 'none']
<code>gid</code>	an id string
<code>label</code>	string or anything printable with '%s' conversion.
<code>linestyle</code> or <code>ls</code>	['solid' 'dashed', 'dashdot', 'dotted' (offset, on-off-dash-seq) '-' '--' '-.' '']
<code>linewidth</code> or <code>lw</code>	float value in points
<code>marker</code>	<i>A valid marker style</i>
<code>markeredgecolor</code> or <code>mec</code>	any matplotlib color
<code>markeredgewidth</code> or <code>mew</code>	float value in points
<code>markerfacecolor</code> or <code>mfc</code>	any matplotlib color
<code>markerfacecoloralt</code> or <code>mfcalt</code>	any matplotlib color

Table 19.4 – continued from previous page

Property	Description
<i>markersize</i> or <i>ms</i>	float
<i>markevery</i>	[None int length-2 tuple of int slice list/array of int float length-2 tuple of float]
<i>path_effects</i>	unknown
<i>picker</i>	float distance in points or callable pick function <code>fn(artist, event)</code>
<i>pickradius</i>	float distance in points
<i>rasterized</i>	[True False None]
<i>sketch_params</i>	unknown
<i>snap</i>	unknown
<i>solid_capstyle</i>	['butt' 'round' 'projecting']
<i>solid_joinstyle</i>	['miter' 'round' 'bevel']
<i>transform</i>	a <code>matplotlib.transforms.Transform</code> instance
<i>url</i>	a url string
<i>visible</i>	[True False]
<i>xdata</i>	1D array
<i>ydata</i>	1D array
<i>zorder</i>	any number

.. note::

In addition to the above described arguments, this function can take a **data** keyword argument. If such a **data** argument is given, the following arguments are replaced by **data[<arg>]**:

- All arguments with the following names: 'x', 'y'.

See also:

`matplotlib.dates` helper functions on dates

`matplotlib.dates.date2num` how to convert dates to num

`matplotlib.dates.num2date` how to convert num to dates

`matplotlib.dates.drange` how floating point dates

matplotlib.axes.Axes.step

`Axes.step(x, y, *args, **kwargs)`

Make a step plot.

Parameters `x` : array_like

1-D sequence, and it is assumed, but not checked, that it is uniformly increasing.

`y` : array_like

1-D sequence, and it is assumed, but not checked, that it is uniformly increasing.

Returns list

List of lines that were added.

Other Parameters *where* : ['pre' | 'post' | 'mid']

If 'pre' (the default), the interval from $x[i]$ to $x[i+1]$ has level $y[i+1]$.

If 'post', that interval has level $y[i]$.

If 'mid', the jumps in y occur half-way between the x -values.

Notes

Additional parameters are the same as those for `plot()`.

Note: In addition to the above described arguments, this function can take a **data** keyword argument. If such a **data** argument is given, the following arguments are replaced by **data[<arg>]**:

- All arguments with the following names: 'x', 'y'.
-

matplotlib.axes.Axes.loglog

`Axes.loglog(*args, **kwargs)`

Make a plot with log scaling on both the x and y axis.

`loglog()` supports all the keyword arguments of `plot()` and `matplotlib.axes.Axes.set_xscale()` / `matplotlib.axes.Axes.set_yscale()`.

Notable keyword arguments:

basex/basey: **scalar > 1** Base of the x/y logarithm

subsx/subsy: [*None* | **sequence**] The location of the minor x/y ticks; *None* defaults to autosubs, which depend on the number of decades in the plot; see `matplotlib.axes.Axes.set_xscale()` / `matplotlib.axes.Axes.set_yscale()` for details

nonposx/nonposy: ['**mask**' | '**clip**'] Non-positive values in x or y can be masked as invalid, or clipped to a very small positive number

The remaining valid kwargs are `Line2D` properties:

Property	Description
<code>agg_filter</code>	unknown
<code>alpha</code>	float (0.0 transparent through 1.0 opaque)
<code>animated</code>	[True False]
<code>antialiased</code> or <code>aa</code>	[True False]

Table 19.5 – continued from previous page

Property	Description
<i>axes</i>	an <i>Axes</i> instance
<i>clip_box</i>	a <i>matplotlib.transforms.Bbox</i> instance
<i>clip_on</i>	[True False]
<i>clip_path</i>	[(<i>Path</i> , <i>Transform</i>) <i>Patch</i> None]
<i>color</i> or <i>c</i>	any matplotlib color
<i>contains</i>	a callable function
<i>dash_capstyle</i>	['butt' 'round' 'projecting']
<i>dash_joinstyle</i>	['miter' 'round' 'bevel']
<i>dashes</i>	sequence of on/off ink in points
<i>drawstyle</i>	['default' 'steps' 'steps-pre' 'steps-mid' 'steps-post']
<i>figure</i>	a <i>matplotlib.figure.Figure</i> instance
<i>fillstyle</i>	['full' 'left' 'right' 'bottom' 'top' 'none']
<i>gid</i>	an id string
<i>label</i>	string or anything printable with '%s' conversion.
<i>linestyle</i> or <i>ls</i>	['solid' 'dashed', 'dashdot', 'dotted' (offset, on-off-dash-seq) '-' '--' '-.' ' ']
<i>linewidth</i> or <i>lw</i>	float value in points
<i>marker</i>	<i>A valid marker style</i>
<i>markeredgecolor</i> or <i>mec</i>	any matplotlib color
<i>markeredgewidth</i> or <i>mew</i>	float value in points
<i>markerfacecolor</i> or <i>mfc</i>	any matplotlib color
<i>markerfacecoloralt</i> or <i>mfcalt</i>	any matplotlib color
<i>markersize</i> or <i>ms</i>	float
<i>markevery</i>	[None int length-2 tuple of int slice list/array of int float length-2 tuple of float]
<i>path_effects</i>	unknown
<i>picker</i>	float distance in points or callable pick function <code>fn(artist, event)</code>
<i>pickradius</i>	float distance in points
<i>rasterized</i>	[True False None]
<i>sketch_params</i>	unknown
<i>snap</i>	unknown
<i>solid_capstyle</i>	['butt' 'round' 'projecting']
<i>solid_joinstyle</i>	['miter' 'round' 'bevel']
<i>transform</i>	a <i>matplotlib.transforms.Transform</i> instance
<i>url</i>	a url string
<i>visible</i>	[True False]
<i>xdata</i>	1D array
<i>ydata</i>	1D array
<i>zorder</i>	any number

Example:

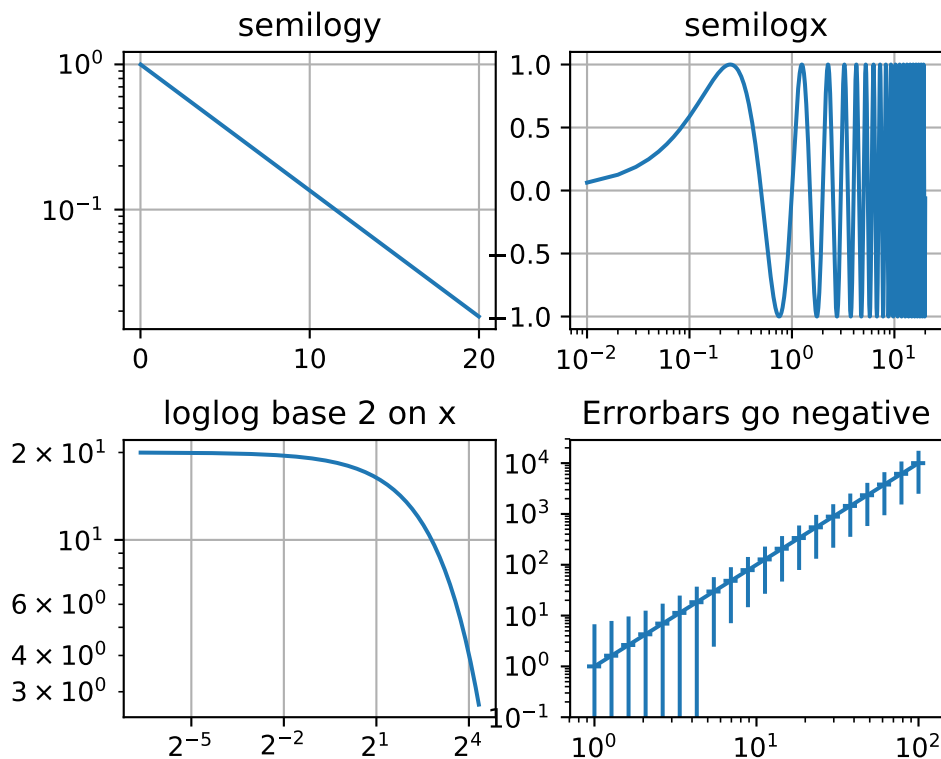

matplotlib.axes.Axes.semilogx

`Axes.semilogx(*args, **kwargs)`

Make a plot with log scaling on the x axis.

Parameters `basex` : float, optional

Base of the x logarithm. The scalar should be larger than 1.

subsx : array_like, optional

The location of the minor xticks; *None* defaults to autosubs, which depend on the number of decades in the plot; see `set_xscale()` for details.

nonposx : string, optional, {'mask', 'clip'}

Non-positive values in *x* can be masked as invalid, or clipped to a very small positive number.

Returns *plot*

Log-scaled plot on the *x* axis.

Other Parameters :class:~matplotlib.lines.Line2D properties:

Property	Description
<i>agg_filter</i>	unknown
<i>alpha</i>	float (0.0 transparent through 1.0 opaque)
<i>animated</i>	[True False]
<i>antialiased</i> or <i>aa</i>	[True False]
<i>axes</i>	an <i>Axes</i> instance
<i>clip_box</i>	a <i>matplotlib.transforms.Bbox</i> instance
<i>clip_on</i>	[True False]
<i>clip_path</i>	[(<i>Path</i> , <i>Transform</i>) <i>Patch</i> None]
<i>color</i> or <i>c</i>	any matplotlib color
<i>contains</i>	a callable function
<i>dash_capstyle</i>	['butt' 'round' 'projecting']
<i>dash_joinstyle</i>	['miter' 'round' 'bevel']
<i>dashes</i>	sequence of on/off ink in points
<i>drawstyle</i>	['default' 'steps' 'steps-pre' 'steps-mid' 'steps-post']
<i>figure</i>	a <i>matplotlib.figure.Figure</i> instance
<i>fillstyle</i>	['full' 'left' 'right' 'bottom' 'top' 'none']
<i>gid</i>	an id string
<i>label</i>	string or anything printable with '%s' conversion.
<i>linestyle</i> or <i>ls</i>	['solid' 'dashed', 'dashdot', 'dotted' (offset, on-off-dash-seq) '-' '--' '-.' ' ']
<i>linewidth</i> or <i>lw</i>	float value in points
<i>marker</i>	<i>A valid marker style</i>
<i>markeredgecolor</i> or <i>mec</i>	any matplotlib color
<i>markeredgewidth</i> or <i>mew</i>	float value in points
<i>markerfacecolor</i> or <i>mfc</i>	any matplotlib color
<i>markerfacecoloralt</i> or <i>mfcalt</i>	any matplotlib color
<i>markersize</i> or <i>ms</i>	float
<i>markevery</i>	[None int length-2 tuple of int slice list/array of int float length-2 tuple of float]
<i>path_effects</i>	unknown
<i>picker</i>	float distance in points or callable pick function <code>fn(artist, event)</code>
<i>pickradius</i>	float distance in points
<i>rasterized</i>	[True False None]
<i>sketch_params</i>	unknown
<i>snap</i>	unknown
<i>solid_capstyle</i>	['butt' 'round' 'projecting']
<i>solid_joinstyle</i>	['miter' 'round' 'bevel']
<i>transform</i>	a <i>matplotlib.transforms.Transform</i> instance
<i>url</i>	a url string
<i>visible</i>	[True False]
<i>xdata</i>	1D array
<i>ydata</i>	1D array
<i>zorder</i>	any number

See also:

loglog For example code and figure.

Notes

This function supports all the keyword arguments of `plot()` and `matplotlib.axes.Axes.set_xscale()`.

matplotlib.axes.Axes.semilogy

`Axes.semilogy(*args, **kwargs)`

Make a plot with log scaling on the y axis.

Parameters `basey` : scalar > 1

Base of the y logarithm.

subs [None or iterable] The location of the minor yticks. None defaults to autosubs, which depend on the number of decades in the plot. See `set_yscale()` for details.

nonposy [{'mask' | 'clip'} str] Non-positive values in y can be masked as invalid, or clipped to a very small positive number.

Returns `Line2D`

Line instance of the plot.

Other Parameters `kwargs` : `Line2D` properties,

plot and `matplotlib.axes.Axes.set_yscale` arguments.

```
=====
=====
```

Property Description

```
=====
=====
```

:meth:'agg_filter <matplotlib.artist.Artist.set_agg_filter>' unknown

:meth:'alpha <matplotlib.artist.Artist.set_alpha>' float (0.0 transparent through 1.0 opaque)

:meth:'animated <matplotlib.artist.Artist.set_animated>' [True | False]

:meth:'antialiased <matplotlib.lines.Line2D.set_antialiased>' or aa [True | False]

:meth:'axes <matplotlib.artist.Artist.set_axes>' an

:class:'~matplotlib.axes.Axes' instance

:meth:'clip_box <matplotlib.artist.Artist.set_clip_box>' a

:class:'matplotlib.transforms.Bbox' instance

:meth:‘clip_on <matplotlib.artist.Artist.set_clip_on>‘ [True | False]

:meth:‘clip_path <matplotlib.artist.Artist.set_clip_path>‘ [

 (:class:‘~matplotlib.path.Path‘, :class:‘~matplotlib.transforms.Transform‘) |

 :class:‘~matplotlib.patches.Patch‘ | None]

:meth:‘color <matplotlib.lines.Line2D.set_color>‘ or c any matplotlib color

:meth:‘contains <matplotlib.artist.Artist.set_contains>‘ a callable function

:meth:‘dash_capstyle <matplotlib.lines.Line2D.set_dash_capstyle>‘ [‘butt’ |

 ‘round’ | ‘projecting’]

:meth:‘dash_joinstyle <matplotlib.lines.Line2D.set_dash_joinstyle>‘ [‘miter’ |

 ‘round’ | ‘bevel’]

:meth:‘dashes <matplotlib.lines.Line2D.set_dashes>‘ sequence of on/off ink in

 points

:meth:‘drawstyle <matplotlib.lines.Line2D.set_drawstyle>‘ [‘default’ | ‘steps’ |

 ‘steps-pre’ | ‘steps-mid’ | ‘steps-post’]

:meth:‘figure <matplotlib.artist.Artist.set_figure>‘ a

 :class:‘matplotlib.figure.Figure‘ instance

:meth:‘fillstyle <matplotlib.lines.Line2D.set_fillstyle>‘ [‘full’ | ‘left’ | ‘right’ |

 ‘bottom’ | ‘top’ | ‘none’]

:meth:‘gid <matplotlib.artist.Artist.set_gid>‘ an id string

:meth:‘label <matplotlib.artist.Artist.set_label>‘ string or anything printable

 with ‘%s’ conversion.

:meth:‘linestyle <matplotlib.lines.Line2D.set_linestyle>‘ or ls [‘solid’ | ‘dashed’,

 ‘dashdot’, ‘dotted’ | (offset, on-off-dash-seq) | “’-“ | “’-“ | “’-.” | “’:” |

 “None” | “” | “” | “”

:meth:‘linewidth <matplotlib.lines.Line2D.set_linewidth>‘ or lw float value in

 points

:meth:‘marker <matplotlib.lines.Line2D.set_marker>‘ :mod:‘A valid marker

 style <matplotlib.markers>‘

:meth:‘markeredgecolor <matplotlib.lines.Line2D.set_markeredgecolor>‘ or

 mec any matplotlib color

:meth:‘markeredgewidth <matplotlib.lines.Line2D.set_markeredgewidth>‘ or

 mew float value in points

:meth:‘markerfacecolor <matplotlib.lines.Line2D.set_markerfacecolor>‘ or mfc

 any matplotlib color

:meth:‘markerfacecoloralt <matplotlib.lines.Line2D.set_markerfacecoloralt>‘

 or mfcalt any matplotlib color

:meth:‘markersize <matplotlib.lines.Line2D.set_markersize>‘ or ms float

```

:meth:'markevery <matplotlib.lines.Line2D.set_markevery>' [None | int |
length-2 tuple of int | slice | list/array of int | float | length-2 tuple of float]
:meth:'path_effects <matplotlib.artist.Artist.set_path_effects>' unknown
:meth:'picker <matplotlib.lines.Line2D.set_picker>' float distance in points or
callable pick function "fn(artist, event)"
:meth:'pickradius <matplotlib.lines.Line2D.set_pickradius>' float distance in
points
:meth:'rasterized <matplotlib.artist.Artist.set_rasterized>' [True | False | None]
:meth:'sketch_params <matplotlib.artist.Artist.set_sketch_params>' unknown
:meth:'snap <matplotlib.artist.Artist.set_snap>' unknown
:meth:'solid_capstyle <matplotlib.lines.Line2D.set_solid_capstyle>' ['butt' |
'round' | 'projecting']
:meth:'solid_joinstyle <matplotlib.lines.Line2D.set_solid_joinstyle>' ['miter' |
'round' | 'bevel']
:meth:'transform <matplotlib.lines.Line2D.set_transform>' a
:class:'matplotlib.transforms.Transform' instance
:meth:'url <matplotlib.artist.Artist.set_url>' a url string
:meth:'visible <matplotlib.artist.Artist.set_visible>' [True | False]
:meth:'xdata <matplotlib.lines.Line2D.set_xdata>' 1D array
:meth:'ydata <matplotlib.lines.Line2D.set_ydata>' 1D array
:meth:'zorder <matplotlib.artist.Artist.set_zorder>' any number

```

```

=====
=====

```

See also:

[*loglog\(\)*](#) For example code and figure.

matplotlib.axes.Axes.fill_between

`Axes.fill_between(x, y1, y2=0, where=None, interpolate=False, step=None, **kwargs)`

Make filled polygons between two curves.

Create a [*PolyCollection*](#) filling the regions between *y1* and *y2* where `where==True`

Parameters *x* : array

An N-length array of the x data

y1 : array

An N-length array (or scalar) of the y data

y2 : array

An N-length array (or scalar) of the y data

where : array, optional

If None, default to fill between everywhere. If not None, it is an N-length numpy boolean array and the fill will only happen over the regions where `where==True`.

interpolate : bool, optional

If True, interpolate between the two lines to find the precise point of intersection. Otherwise, the start and end points of the filled region will only occur on explicit values in the x array.

step : { 'pre', 'post', 'mid' }, optional

If not None, fill with step logic.

See also:

In addition to the above described arguments, this function can take a **data** keyword argument. If such a **data** argument is given, the following arguments are replaced by **data[<arg>]**: * All arguments with the following names: 'where', 'x', 'y1', 'y2'.

Notes

Additional Keyword args passed on to the *PolyCollection*.

kwargs control the *Polygon* properties:

Property	Description
<i>agg_filter</i>	unknown
<i>alpha</i>	float or None
<i>animated</i>	[True False]
<i>antialiased</i> or <i>antialiaseds</i>	Boolean or sequence of booleans
<i>array</i>	unknown
<i>axes</i>	an <i>Axes</i> instance
<i>clim</i>	a length 2 sequence of floats
<i>clip_box</i>	a <i>matplotlib.transforms.Bbox</i> instance
<i>clip_on</i>	[True False]
<i>clip_path</i>	[(<i>Path, Transform</i>) <i>Patch</i> None]
<i>cmap</i>	a colormap or registered colormap name
<i>color</i>	matplotlib color arg or sequence of rgba tuples
<i>contains</i>	a callable function
<i>edgecolor</i> or <i>edgecolors</i>	matplotlib color spec or sequence of specs
<i>facecolor</i> or <i>facecolors</i>	matplotlib color spec or sequence of specs
<i>figure</i>	a <i>matplotlib.figure.Figure</i> instance
<i>gid</i>	an id string

Table 19.7 – continued from previous page

Property	Description
<i>hatch</i>	['/' '\' ' ' '-' '+' 'x' 'o' 'O' '.' '*']
<i>label</i>	string or anything printable with '%s' conversion.
<i>linestyle</i> or dashes or <i>linestyles</i>	['solid' 'dashed', 'dashdot', 'dotted' (offset, on-off-dash-seq) '-' '--' '-.'
<i>linewidth</i> or <i>linewidths</i> or <i>lw</i>	float or sequence of floats
<i>norm</i>	unknown
<i>offset_position</i>	unknown
<i>offsets</i>	float or sequence of floats
<i>path_effects</i>	unknown
<i>picker</i>	[None float boolean callable]
<i>pickradius</i>	unknown
<i>rasterized</i>	[True False None]
<i>sketch_params</i>	unknown
<i>snap</i>	unknown
<i>transform</i>	<i>Transform</i> instance
<i>url</i>	a url string
<i>urls</i>	unknown
<i>visible</i>	[True False]
<i>zorder</i>	any number

Examples

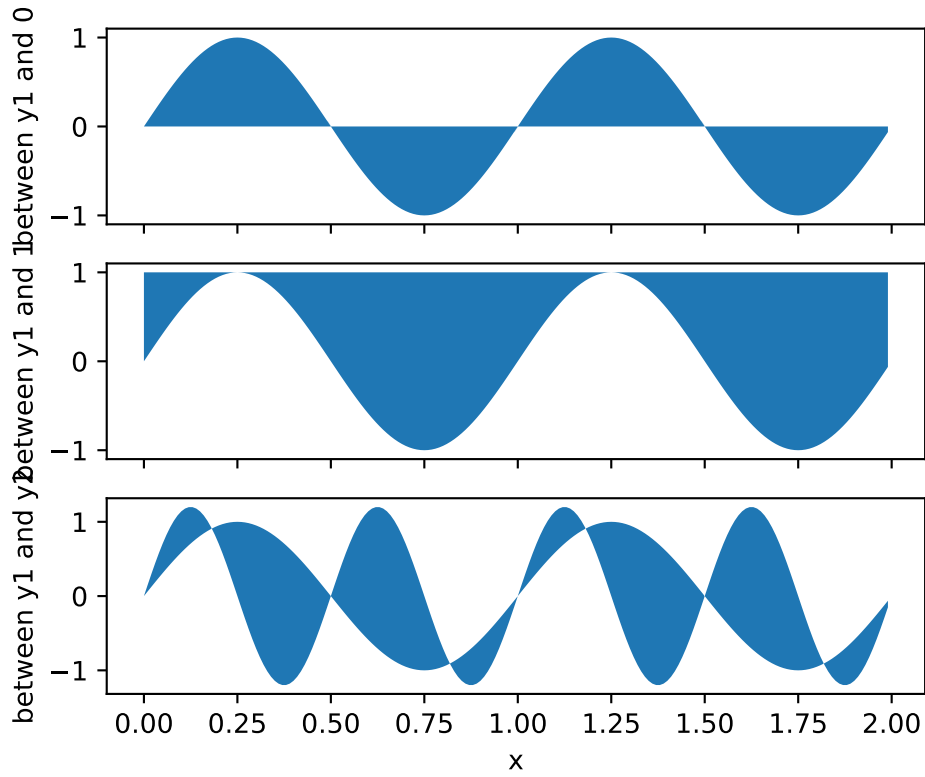

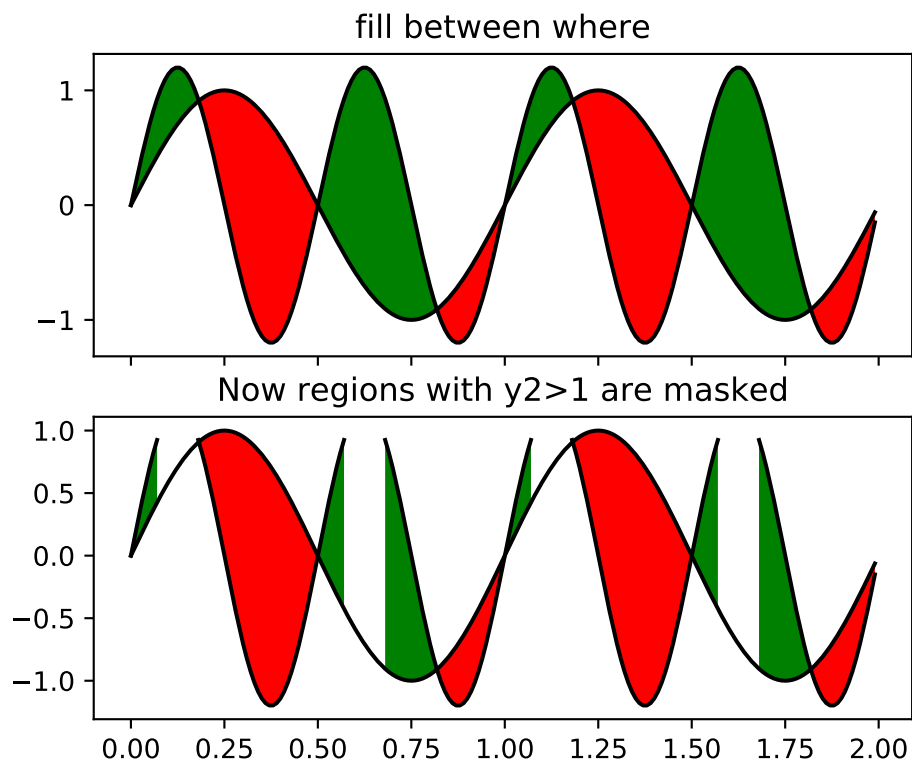

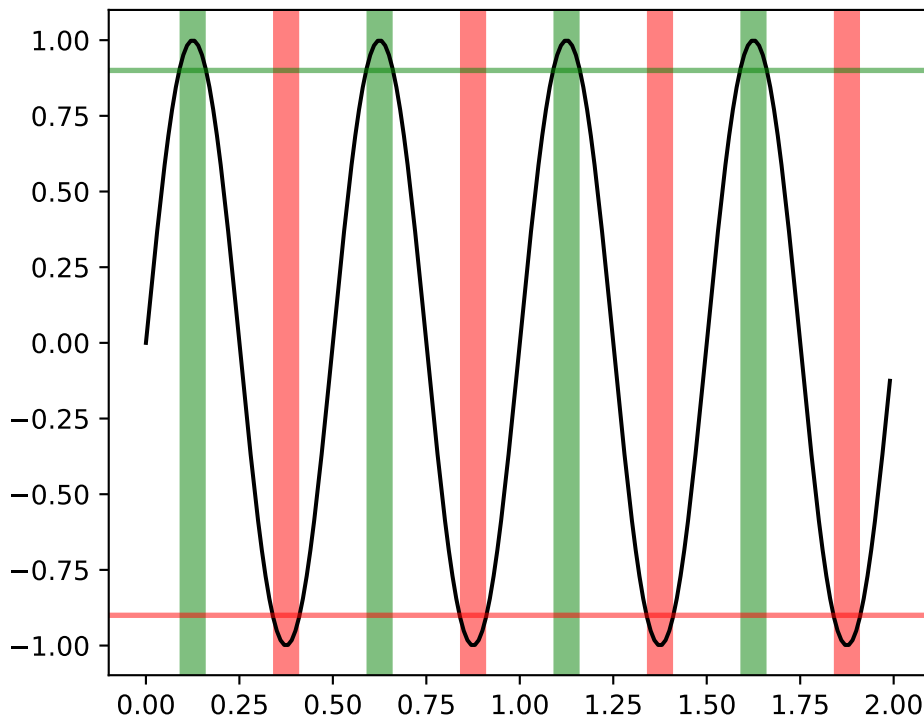

matplotlib.axes.Axes.fill_betweenx

`Axes.fill_betweenx(y, x1, x2=0, where=None, step=None, **kwargs)`

Make filled polygons between two horizontal curves.

Create a *PolyCollection* filling the regions between $x1$ and $x2$ where `where==True`

Parameters `y` : array

An N-length array of the y data

x1 : array

An N-length array (or scalar) of the x data

x2 : array, optional

An N-length array (or scalar) of the x data

where : array, optional

If *None*, default to fill between everywhere. If not *None*, it is a N length numpy boolean array and the fill will only happen over the regions where `where==True`

step : { 'pre', 'post', 'mid' }, optional

If not None, fill with step logic.

See also:

In addition to the above described arguments, this function can take a **data** keyword argument. If such a **data** argument is given, the following arguments are replaced by **data[<arg>]**: * All arguments with the following names: ‘where’, ‘x1’, ‘x2’, ‘y’.

Notes

keyword args passed on to the *PolyCollection*

kwargs control the *Polygon* properties:

Property	Description
<i>agg_filter</i>	unknown
<i>alpha</i>	float or None
<i>animated</i>	[True False]
<i>antialiased</i> or <i>antialiaseds</i>	Boolean or sequence of booleans
<i>array</i>	unknown
<i>axes</i>	an <i>Axes</i> instance
<i>clim</i>	a length 2 sequence of floats
<i>clip_box</i>	a <i>matplotlib.transforms.Bbox</i> instance
<i>clip_on</i>	[True False]
<i>clip_path</i>	[(<i>Path</i> , <i>Transform</i>) <i>Patch</i> None]
<i>cmap</i>	a colormap or registered colormap name
<i>color</i>	matplotlib color arg or sequence of rgba tuples
<i>contains</i>	a callable function
<i>edgecolor</i> or <i>edgecolors</i>	matplotlib color spec or sequence of specs
<i>facecolor</i> or <i>facecolors</i>	matplotlib color spec or sequence of specs
<i>figure</i>	a <i>matplotlib.figure.Figure</i> instance
<i>gid</i>	an id string
<i>hatch</i>	['/' '\' ' ' '-' '+' 'x' 'o' 'O' '.' '*']
<i>label</i>	string or anything printable with '%s' conversion.
<i>linestyle</i> or <i>dashes</i> or <i>linestyles</i>	['solid' 'dashed', 'dashdot', 'dotted' (offset, on-off-dash-seq) '- ' '-- ' '-. ' ...]
<i>linewidth</i> or <i>linewidths</i> or <i>lw</i>	float or sequence of floats
<i>norm</i>	unknown
<i>offset_position</i>	unknown
<i>offsets</i>	float or sequence of floats
<i>path_effects</i>	unknown
<i>picker</i>	[None float boolean callable]
<i>pickradius</i>	unknown
<i>rasterized</i>	[True False None]
<i>sketch_params</i>	unknown
<i>snap</i>	unknown

Table 19.8 – continued from previous page

Property	Description
<i>transform</i>	<i>Transform</i> instance
<i>url</i>	a url string
<i>urls</i>	unknown
<i>visible</i>	[True False]
<i>zorder</i>	any number

Examples

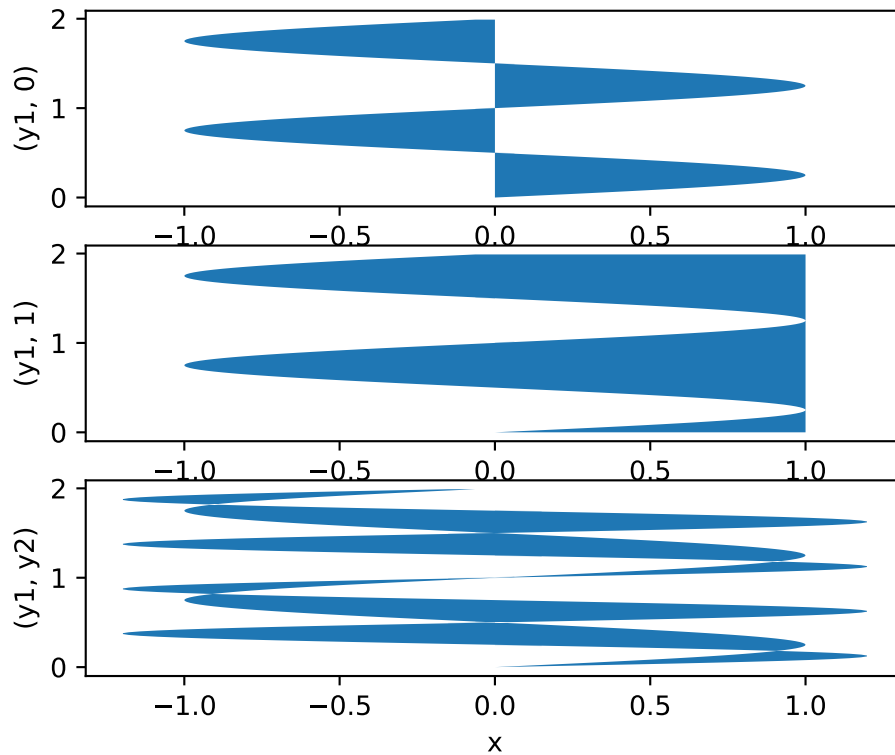

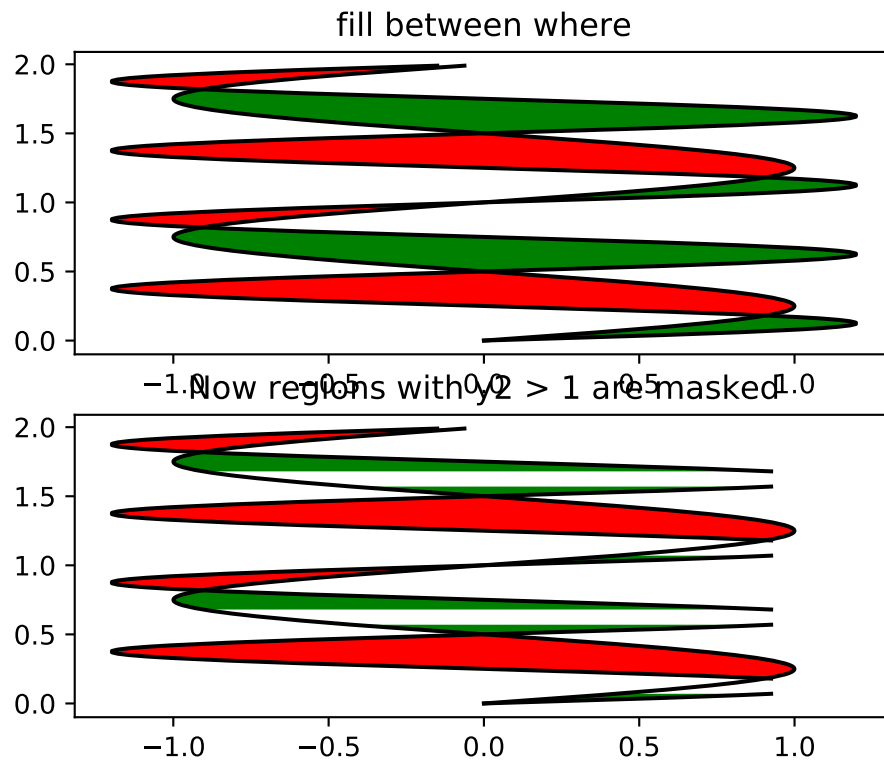

matplotlib.axes.Axes.bar

`Axes.bar`(*left*, *height*, *width*=0.8, *bottom*=None, ***kwargs*)

Make a bar plot.

Make a bar plot with rectangles bounded by:

left, **left + width**, **bottom**, **bottom + height** (left, right, bottom and top edges)

Parameters left : sequence of scalars

the x coordinates of the left sides of the bars

height : sequence of scalars

the heights of the bars

width : scalar or array-like, optional

the width(s) of the bars default: 0.8

bottom : scalar or array-like, optional

the y coordinate(s) of the bars default: None

color : scalar or array-like, optional

the colors of the bar faces

edgecolor : scalar or array-like, optional

the colors of the bar edges

linewidth : scalar or array-like, optional

width of bar edge(s). If None, use default linewidth; If 0, don't draw edges.
default: None

tick_label : string or array-like, optional

the tick labels of the bars default: None

xerr : scalar or array-like, optional

if not None, will be used to generate errorbar(s) on the bar chart default: None

yerr : scalar or array-like, optional

if not None, will be used to generate errorbar(s) on the bar chart default: None

ecolor : scalar or array-like, optional

specifies the color of errorbar(s) default: None

capsize : scalar, optional

determines the length in points of the error bar caps default: None, which will take the value from the `errorbar.capsize` *rcParam*.

error_kw : dict, optional

dictionary of kwargs to be passed to errorbar method. *ecolor* and *capsize* may be specified here rather than as independent kwargs.

align : { 'center', 'edge' }, optional

If 'edge', aligns bars by their left edges (for vertical bars) and by their bottom edges (for horizontal bars). If 'center', interpret the `left` argument as the coordinates of the centers of the bars. To align on the right edge pass a negative `width`.

orientation : { 'vertical', 'horizontal' }, optional

The orientation of the bars.

log : boolean, optional

If true, sets the axis to be log scale. default: False

Returns bars : `matplotlib.container.BarContainer`

Container with all of the bars + errorbars

See also:

[*barh*](#) Plot a horizontal bar plot.

Notes

The optional arguments `color`, `edgecolor`, `linewidth`, `xerr`, and `yerr` can be either scalars or sequences of length equal to the number of bars. This enables you to use `bar` as the basis for stacked bar charts, or candlestick plots. Detail: `xerr` and `yerr` are passed directly to `errorbar()`, so they can also have shape `2xN` for independent specification of lower and upper errors.

Other optional kwargs:

Property	Description
<code>agg_filter</code>	unknown
<code>alpha</code>	float or None
<code>animated</code>	[True False]
<code>antialiased</code> or <code>aa</code>	[True False] or None for default
<code>axes</code>	an <code>Axes</code> instance
<code>capstyle</code>	['butt' 'round' 'projecting']
<code>clip_box</code>	a <code>matplotlib.transforms.Bbox</code> instance
<code>clip_on</code>	[True False]
<code>clip_path</code>	[(<code>Path</code> , <code>Transform</code>) <code>Patch</code> None]
<code>color</code>	matplotlib color spec
<code>contains</code>	a callable function
<code>edgecolor</code> or <code>ec</code>	mpl color spec, None, 'none', or 'auto'
<code>facecolor</code> or <code>fc</code>	mpl color spec, or None for default, or 'none' for no color
<code>figure</code>	a <code>matplotlib.figure.Figure</code> instance
<code>fill</code>	[True False]
<code>gid</code>	an id string
<code>hatch</code>	['/' '\' ' ' '-' '+' 'x' 'o' 'O' '.' '*']
<code>joinstyle</code>	['miter' 'round' 'bevel']
<code>label</code>	string or anything printable with '%s' conversion.
<code>linestyle</code> or <code>ls</code>	['solid' 'dashed', 'dashdot', 'dotted' (offset, on-off-dash-seq) '-' '--' '-.' ':' 'None']
<code>linewidth</code> or <code>lw</code>	float or None for default
<code>path_effects</code>	unknown
<code>picker</code>	[None float boolean callable]
<code>rasterized</code>	[True False None]
<code>sketch_params</code>	unknown
<code>snap</code>	unknown
<code>transform</code>	<code>Transform</code> instance
<code>url</code>	a url string
<code>visible</code>	[True False]
<code>zorder</code>	any number

Examples

Example: A stacked bar chart.

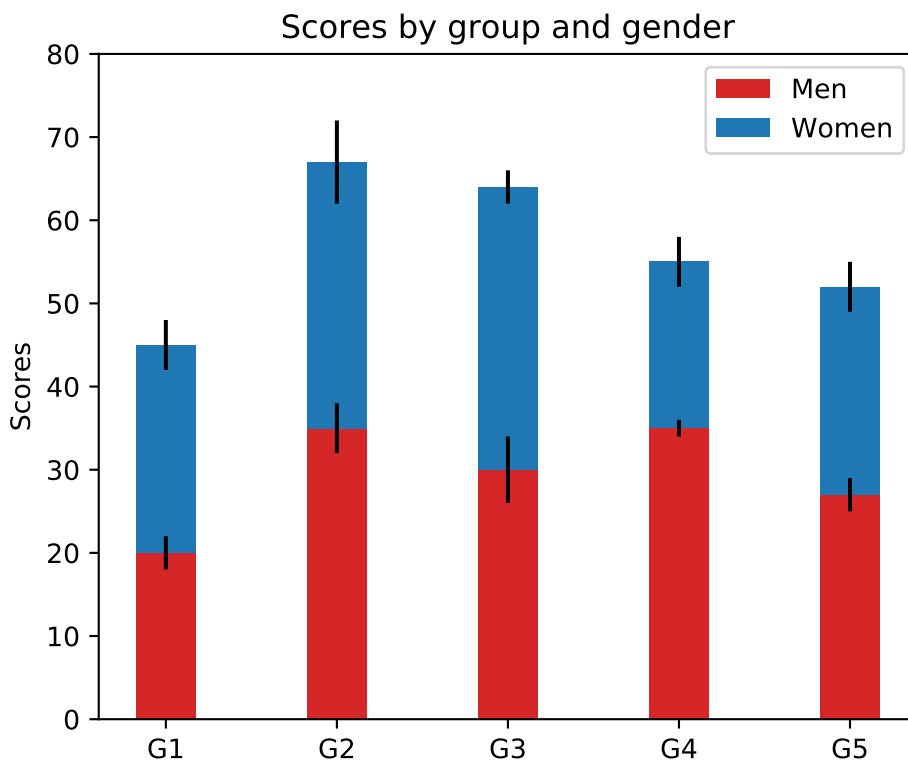

Note: In addition to the above described arguments, this function can take a **data** keyword argument. If such a **data** argument is given, the following arguments are replaced by **data[<arg>]**:

- All arguments with the following names: 'bottom', 'color', 'ecolor', 'edgecolor', 'height', 'left', 'linewidth', 'tick_label', 'width', 'xerr', 'yerr'.
-

matplotlib.axes.Axes.barh

Axes.**barh**(*bottom*, *width*, *height=0.8*, *left=None*, ***kwargs*)

Make a horizontal bar plot.

Make a horizontal bar plot with rectangles bounded by:

left, **left + width**, **bottom**, **bottom + height** (left, right, bottom and top edges)

bottom, *width*, *height*, and *left* can be either scalars or sequences

Parameters bottom : scalar or array-like

the y coordinate(s) of the bars

width : scalar or array-like

the width(s) of the bars

height : sequence of scalars, optional, default: 0.8
the heights of the bars

left : sequence of scalars
the x coordinates of the left sides of the bars

Returns *matplotlib.patches.Rectangle* instances.

Other Parameters color : scalar or array-like, optional
the colors of the bars

edgecolor : scalar or array-like, optional
the colors of the bar edges

linewidth : scalar or array-like, optional, default: None
width of bar edge(s). If None, use default linewidth; If 0, don't draw edges.

tick_label : string or array-like, optional, default: None
the tick labels of the bars

xerr : scalar or array-like, optional, default: None
if not None, will be used to generate errorbar(s) on the bar chart

yerr : scalar or array-like, optional, default: None
if not None, will be used to generate errorbar(s) on the bar chart

ecolor : scalar or array-like, optional, default: None
specifies the color of errorbar(s)

capsize : scalar, optional
determines the length in points of the error bar caps default: None, which will take the value from the `errorbar.capsize` *rcParam*.

error_kw :
dictionary of kwargs to be passed to errorbar method. `ecolor` and `capsize` may be specified here rather than as independent kwargs.

align : { 'center', 'edge' }, optional
If 'edge', aligns bars by their left edges (for vertical bars) and by their bottom edges (for horizontal bars). If 'center', interpret the `bottom` argument as the coordinates of the centers of the bars. To align on the align bars on the top edge pass a negative 'height'.

log : boolean, optional, default: False
If true, sets the axis to be log scale

See also:

bar Plot a vertical bar plot.

Notes

The optional arguments *color*, *edgecolor*, *linewidth*, *xerr*, and *yerr* can be either scalars or sequences of length equal to the number of bars. This enables you to use *bar* as the basis for stacked bar charts, or candlestick plots. Detail: *xerr* and *yerr* are passed directly to *errorbar()*, so they can also have shape 2xN for independent specification of lower and upper errors.

Other optional kwargs:

Property	Description
<i>agg_filter</i>	unknown
<i>alpha</i>	float or None
<i>animated</i>	[True False]
<i>antialiased</i> or <i>aa</i>	[True False] or None for default
<i>axes</i>	an <i>Axes</i> instance
<i>capstyle</i>	['butt' 'round' 'projecting']
<i>clip_box</i>	a <i>matplotlib.transforms.Bbox</i> instance
<i>clip_on</i>	[True False]
<i>clip_path</i>	[(<i>Path</i> , <i>Transform</i>) <i>Patch</i> None]
<i>color</i>	matplotlib color spec
<i>contains</i>	a callable function
<i>edgecolor</i> or <i>ec</i>	mpl color spec, None, 'none', or 'auto'
<i>facecolor</i> or <i>fc</i>	mpl color spec, or None for default, or 'none' for no color
<i>figure</i>	a <i>matplotlib.figure.Figure</i> instance
<i>fill</i>	[True False]
<i>gid</i>	an id string
<i>hatch</i>	['/' '\' ' ' '-' '+' 'x' 'o' 'O' '.' '*']
<i>joinstyle</i>	['miter' 'round' 'bevel']
<i>label</i>	string or anything printable with '%s' conversion.
<i>linestyle</i> or <i>ls</i>	['solid' 'dashed', 'dashdot', 'dotted' (offset, on-off-dash-seq) '-' '--' '-.' ':' 'None']
<i>linewidth</i> or <i>lw</i>	float or None for default
<i>path_effects</i>	unknown
<i>picker</i>	[None float boolean callable]
<i>rasterized</i>	[True False None]
<i>sketch_params</i>	unknown
<i>snap</i>	unknown
<i>transform</i>	<i>Transform</i> instance
<i>url</i>	a url string
<i>visible</i>	[True False]
<i>zorder</i>	any number

matplotlib.axes.Axes.stem**Axes.stem**(*args, **kwargs)

Create a stem plot.

Call signatures:

```
stem(y, linefmt='b-', markerfmt='bo', basefmt='r-')
stem(x, y, linefmt='b-', markerfmt='bo', basefmt='r-')
```

A stem plot plots vertical lines (using *linefmt*) at each *x* location from the baseline to *y*, and places a marker there using *markerfmt*. A horizontal line at 0 is plotted using *basefmt*.

If no *x* values are provided, the default is (0, 1, ..., len(y) - 1)

Return value is a tuple (*markerline*, *stemlines*, *baseline*).

See also:

This [document](#) for details.

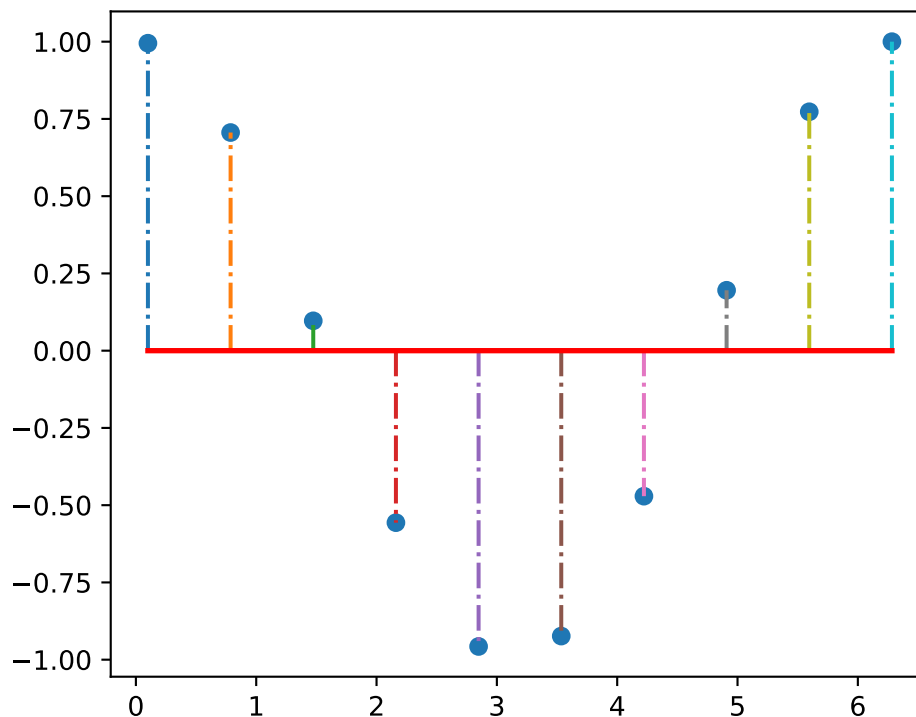
Example:

Note: In addition to the above described arguments, this function can take a **data** keyword argument. If such a **data** argument is given, the following arguments are replaced by **data[<arg>]**:

- All positional and all keyword arguments.
-

matplotlib.axes.Axes.eventplot

`Axes.eventplot`(*positions*, *orientation*='horizontal', *lineoffsets*=1, *linelengths*=1, *linewidths*=None, *colors*=None, *linestyles*='solid', ***kwargs*)
 Plot identical parallel lines at specific positions.

Plot parallel lines at the given positions. *positions* should be a 1D or 2D array-like object, with each row corresponding to a row or column of lines.

This type of plot is commonly used in neuroscience for representing neural events, where it is commonly called a spike raster, dot raster, or raster plot.

However, it is useful in any situation where you wish to show the timing or position of multiple sets of discrete events, such as the arrival times of people to a business on each day of the month or the date of hurricanes each year of the last century.

orientation [['horizontal' | 'vertical']] 'horizontal' : the lines will be vertical and arranged in rows
 'vertical' : lines will be horizontal and arranged in columns

lineoffsets : A float or array-like containing floats.

linelengths : A float or array-like containing floats.

linewidths : A float or array-like containing floats.

colors must be a sequence of RGBA tuples (e.g., arbitrary color strings, etc, not allowed) or a list of such sequences

linestyles : ['solid' | 'dashed' | 'dashdot' | 'dotted'] or an array of these values

For *linelengths*, *linewidths*, *colors*, and *linestyles*, if only a single value is given, that value is applied to all lines. If an array-like is given, it must have the same length as *positions*, and each value will be applied to the corresponding row or column in *positions*.

Returns a list of `matplotlib.collections.EventCollection` objects that were added.

kwargs are `LineCollection` properties:

Property	Description
<code>agg_filter</code>	unknown
<code>alpha</code>	float or None
<code>animated</code>	[True False]
<code>antialiased</code> or <code>antialiaseds</code>	Boolean or sequence of booleans
<code>array</code>	unknown
<code>axes</code>	an <code>Axes</code> instance
<code>clim</code>	a length 2 sequence of floats
<code>clip_box</code>	a <code>matplotlib.transforms.Bbox</code> instance
<code>clip_on</code>	[True False]
<code>clip_path</code>	[(<code>Path</code> , <code>Transform</code>) <code>Patch</code> None]

Table 19.11 – continued from previous page

Property	Description
<i>cmap</i>	a colormap or registered colormap name
<i>color</i>	matplotlib color arg or sequence of rgba tuples
<i>contains</i>	a callable function
<i>edgecolor</i> or <i>edgecolors</i>	matplotlib color spec or sequence of specs
<i>facecolor</i> or <i>facecolors</i>	matplotlib color spec or sequence of specs
<i>figure</i>	a <i>matplotlib.figure.Figure</i> instance
<i>gid</i>	an id string
<i>hatch</i>	['/' '\ ' ' ' '-' '+' 'x' 'o' 'O' '.' '*']
<i>label</i>	string or anything printable with '%s' conversion.
<i>linestyle</i> or <i>dashes</i> or <i>linestyles</i>	['solid' 'dashed', 'dashdot', 'dotted' (offset, on-off-dash-seq) '-' '--' '-.' '']
<i>linewidth</i> or <i>linewidths</i> or <i>lw</i>	float or sequence of floats
<i>norm</i>	unknown
<i>offset_position</i>	unknown
<i>offsets</i>	float or sequence of floats
<i>path_effects</i>	unknown
<i>paths</i>	unknown
<i>picker</i>	[None float boolean callable]
<i>pickradius</i>	unknown
<i>rasterized</i>	[True False None]
<i>segments</i>	unknown
<i>sketch_params</i>	unknown
<i>snap</i>	unknown
<i>transform</i>	<i>Transform</i> instance
<i>url</i>	a url string
<i>urls</i>	unknown
<i>verts</i>	unknown
<i>visible</i>	[True False]
<i>zorder</i>	any number

Example:

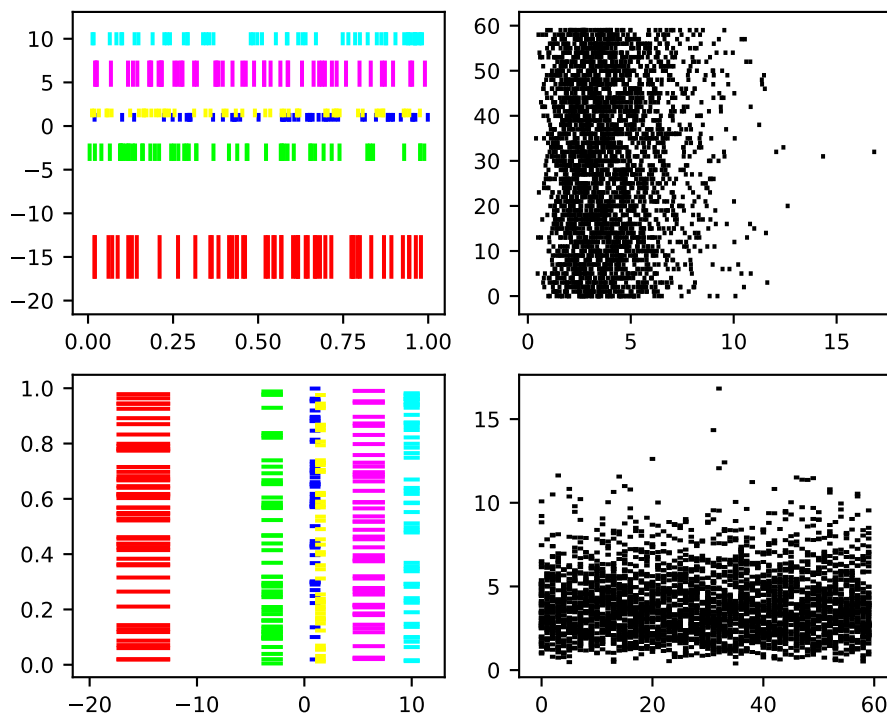

Note: In addition to the above described arguments, this function can take a **data** keyword argument. If such a **data** argument is given, the following arguments are replaced by **data[<arg>]**:

- All arguments with the following names: ‘colors’, ‘linelengths’, ‘lineoffsets’, ‘linestyles’, ‘linewidths’, ‘positions’.

matplotlib.axes.Axes.pie

Axes.pie(*x*, *explode=None*, *labels=None*, *colors=None*, *autopct=None*, *pctdistance=0.6*, *shadow=False*, *labeldistance=1.1*, *startangle=None*, *radius=None*, *counterclock=True*, *wedgeprops=None*, *textprops=None*, *center=(0, 0)*, *frame=False*)
 Plot a pie chart.

Make a pie chart of array *x*. The fractional area of each wedge is given by $x/\text{sum}(x)$. If $\text{sum}(x) \leq 1$, then the values of *x* give the fractional area directly and the array will not be normalized. The wedges are plotted counterclockwise, by default starting from the x-axis.

Parameters x : array-like

The input array used to make the pie chart.

explode : array-like, optional, default: None

If not *None*, is a `len(x)` array which specifies the fraction of the radius with which to offset each wedge.

labels : list, optional, default: None

A sequence of strings providing the labels for each wedge

colors : array-like, optional, default: None

A sequence of matplotlib color args through which the pie chart will cycle. If None, will use the colors in the currently active cycle.

autopct : None (default), string, or function, optional

If not *None*, is a string or function used to label the wedges with their numeric value. The label will be placed inside the wedge. If it is a format string, the label will be `fmt%pct`. If it is a function, it will be called.

pctdistance : float, optional, default: 0.6

The ratio between the center of each pie slice and the start of the text generated by *autopct*. Ignored if *autopct* is *None*.

shadow : bool, optional, default: False

Draw a shadow beneath the pie.

labeldistance : float, optional, default: 1.1

The radial distance at which the pie labels are drawn

startangle : float, optional, default: None

If not *None*, rotates the start of the pie chart by *angle* degrees counterclockwise from the x-axis.

radius : float, optional, default: None

The radius of the pie, if *radius* is *None* it will be set to 1.

counterclock : bool, optional, default: True

Specify fractions direction, clockwise or counterclockwise.

wedgeprops : dict, optional, default: None

Dict of arguments passed to the wedge objects making the pie. For example, you can pass in `wedgeprops = {'linewidth': 3}` to set the width of the wedge border lines equal to 3. For more details, look at the doc/arguments of the wedge object. By default `clip_on=False`.

textprops : dict, optional, default: None

Dict of arguments to pass to the text objects.

center : list of float, optional, default: (0, 0)

Center position of the chart. Takes value (0, 0) or is a sequence of 2 scalars.

frame : bool, optional, default: False

Plot axes frame with the chart if true.

Returns patches : list

A sequence of `matplotlib.patches.Wedge` instances

texts : list

A is a list of the label `matplotlib.text.Text` instances.

autotexts : list

A is a list of `Text` instances for the numeric labels. Is returned only if parameter `autopct` is not `None`.

Notes

The pie chart will probably look best if the figure and axes are square, or the Axes aspect is equal.

Examples

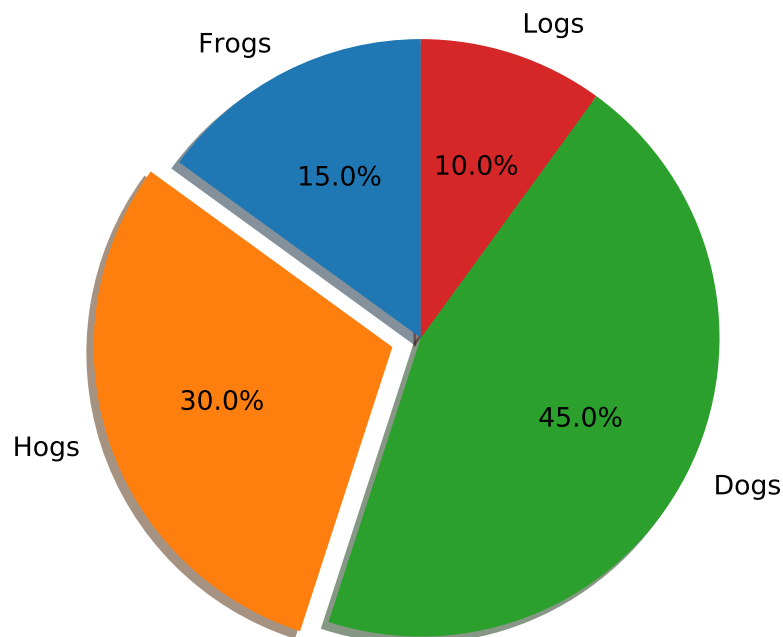

Note: In addition to the above described arguments, this function can take a **data** keyword argument. If such a **data** argument is given, the following arguments are replaced by **data[<arg>]**:

- All arguments with the following names: ‘colors’, ‘explode’, ‘labels’, ‘x’.

matplotlib.axes.Axes.stackplot

Axes.**stackplot**(*x*, **args*, ***kwargs*)

Draws a stacked area plot.

x : 1d array of dimension N

y [2d array of dimension MxN, OR any number 1d arrays each of dimension] 1xN. The data is assumed to be unstacked. Each of the following calls is legal:

```
stackplot(x, y) # where y is MxN
stackplot(x, y1, y2, y3, y4) # where y1, y2, y3, y4, are all 1xNm
```

Keyword arguments:

baseline [['zero', 'sym', 'wiggle', 'weighted_wiggle']] Method used to calculate the baseline. ‘zero’ is just a simple stacked plot. ‘sym’ is symmetric around zero and is sometimes called ThemeRiver. ‘wiggle’ minimizes the sum of the squared slopes. ‘weighted_wiggle’ does the same but weights to account for size of each layer. It is also called Streamgraph-layout. More details can be found at <http://leebyron.com/streamgraph/>.

labels : A list or tuple of labels to assign to each data series.

colors [A list or tuple of colors. These will be cycled through and] used to colour the stacked areas. All other keyword arguments are passed to `fill_between()`

Returns *r* : A list of *PolyCollection*, one for each element in the stacked area plot.

matplotlib.axes.Axes.broken_barh

Axes.**broken_barh**(*xranges*, *yrange*, ***kwargs*)

Plot horizontal bars.

A collection of horizontal bars spanning *yrange* with a sequence of *xranges*.

Required arguments:

Argument	Description
<i>xranges</i>	sequence of (<i>xmin</i> , <i>xwidth</i>)
<i>yrange</i>	sequence of (<i>ymin</i> , <i>ywidth</i>)

kwargs are `matplotlib.collections.BrokenBarHCollection` properties:

Property	Description
<i>agg_filter</i>	unknown
<i>alpha</i>	float or None
<i>animated</i>	[True False]
<i>antialiased</i> or <i>antialiaseds</i>	Boolean or sequence of booleans

Table 19.12 – continued from previous page

Property	Description
<i>array</i>	unknown
<i>axes</i>	an <i>Axes</i> instance
<i>clim</i>	a length 2 sequence of floats
<i>clip_box</i>	a <i>matplotlib.transforms.Bbox</i> instance
<i>clip_on</i>	[True False]
<i>clip_path</i>	[(<i>Path</i> , <i>Transform</i>) <i>Patch</i> None]
<i>cmap</i>	a colormap or registered colormap name
<i>color</i>	matplotlib color arg or sequence of rgba tuples
<i>contains</i>	a callable function
<i>edgecolor</i> or <i>edgecolors</i>	matplotlib color spec or sequence of specs
<i>facecolor</i> or <i>facecolors</i>	matplotlib color spec or sequence of specs
<i>figure</i>	a <i>matplotlib.figure.Figure</i> instance
<i>gid</i>	an id string
<i>hatch</i>	['/' '\' ' ' '-' '+' 'x' 'o' 'O' '.' '*']
<i>label</i>	string or anything printable with '%s' conversion.
<i>linestyle</i> or <i>dashes</i> or <i>linestyles</i>	['solid' 'dashed', 'dashdot', 'dotted' (offset, on-off-dash-seq) '-' '--' '-.' ...]
<i>linewidth</i> or <i>linewidths</i> or <i>lw</i>	float or sequence of floats
<i>norm</i>	unknown
<i>offset_position</i>	unknown
<i>offsets</i>	float or sequence of floats
<i>path_effects</i>	unknown
<i>picker</i>	[None float boolean callable]
<i>pickradius</i>	unknown
<i>rasterized</i>	[True False None]
<i>sketch_params</i>	unknown
<i>snap</i>	unknown
<i>transform</i>	<i>Transform</i> instance
<i>url</i>	a url string
<i>urls</i>	unknown
<i>visible</i>	[True False]
<i>zorder</i>	any number

these can either be a single argument, i.e.,:

```
facecolors = 'black'
```

or a sequence of arguments for the various bars, i.e.,:

```
facecolors = ('black', 'red', 'green')
```

Example:

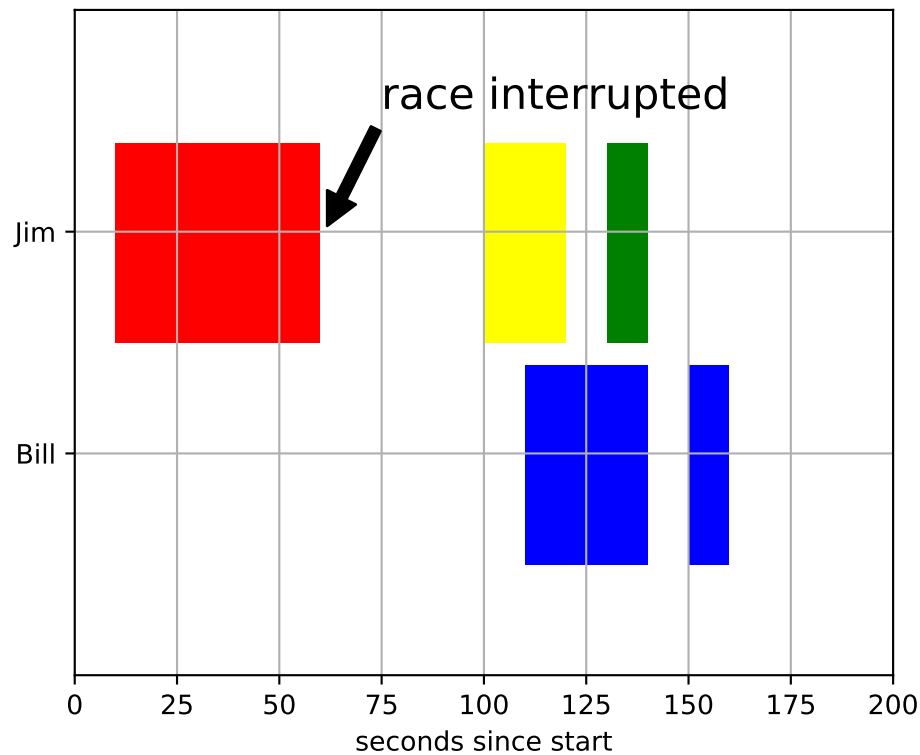

Note: In addition to the above described arguments, this function can take a **data** keyword argument. If such a **data** argument is given, the following arguments are replaced by **data[<arg>]**:

- All positional and all keyword arguments.
-

matplotlib.axes.Axes.vlines

Axes.**vlines**(*x*, *ymin*, *ymax*, *colors='k'*, *linestyles='solid'*, *label='', **kwargs*)

Plot vertical lines.

Plot vertical lines at each *x* from *ymin* to *ymax*.

Parameters *x* : scalar or 1D array_like

x-indexes where to plot the lines.

ymin, ymax : scalar or 1D array_like

Respective beginning and end of each line. If scalars are provided, all lines will have same length.

colors : array_like of colors, optional, default: 'k'

linestyles : ['solid' | 'dashed' | 'dashdot' | 'dotted'], optional

label : string, optional, default: ''

Returns lines : *LineCollection*

Other Parameters kwargs : *LineCollection* properties.

See also:

hlines horizontal lines

Examples

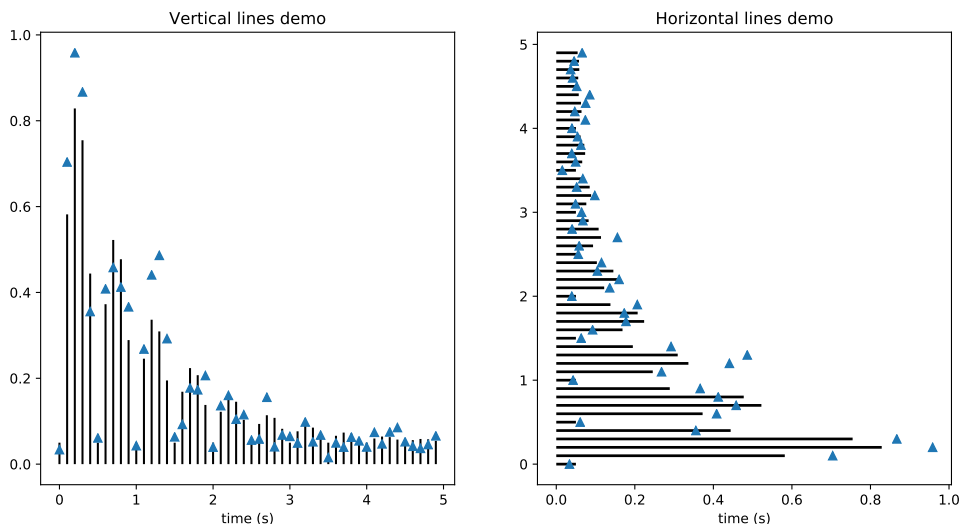

Note: In addition to the above described arguments, this function can take a **data** keyword argument. If such a **data** argument is given, the following arguments are replaced by **data[<arg>]**:

- All arguments with the following names: 'colors', 'x', 'ymax', 'ymin'.

matplotlib.axes.Axes.hlines

Axes.hlines(y, xmin, xmax, colors='k', linestyle='solid', label='', **kwargs)

Plot horizontal lines at each y from xmin to xmax.

Parameters y : scalar or sequence of scalar

y-indexes where to plot the lines.

xmin, xmax : scalar or 1D array_like

Respective beginning and end of each line. If scalars are provided, all lines will have same length.

colors : array_like of colors, optional, default: 'k'

linestyles : ['solid' | 'dashed' | 'dashdot' | 'dotted'], optional

label : string, optional, default: ''

Returns lines : *LineCollection*

Other Parameters kwargs : *LineCollection* properties.

See also:

vlines vertical lines

Examples

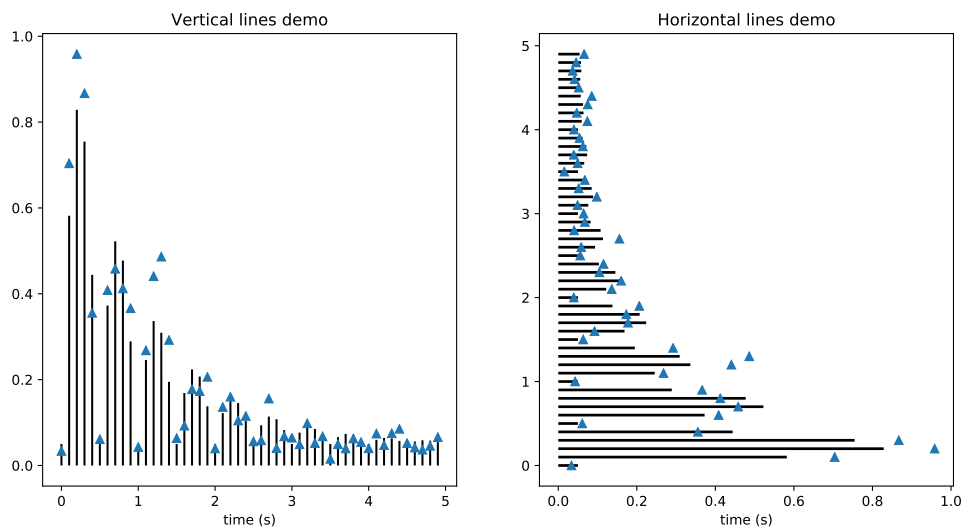

Note: In addition to the above described arguments, this function can take a **data** keyword argument. If such a **data** argument is given, the following arguments are replaced by **data[<arg>]**:

- All arguments with the following names: 'xmax', 'xmin', 'y'.

matplotlib.axes.Axes.fill

`Axes.fill(*args, **kwargs)`

Plot filled polygons.

Parameters args : a variable length argument

It allowing for multiple x, y pairs with an optional color format string; see [plot\(\)](#) for details on the argument parsing. For example, each of the following is legal:

```
ax.fill(x, y)
ax.fill(x, y, "b")
ax.fill(x, y, "b", x, y, "r")
```

An arbitrary number of $x, y, color$ groups can be specified:: `ax.fill(x1, y1, 'g', x2, y2, 'r')`

Returns a list of *Patch*

Other Parameters `kwargs` : *Polygon* properties

Notes

The same color strings that `plot()` supports are supported by the fill format string.

If you would like to fill below a curve, e.g., shade a region between 0 and y along x , use `fill_between()`

Examples

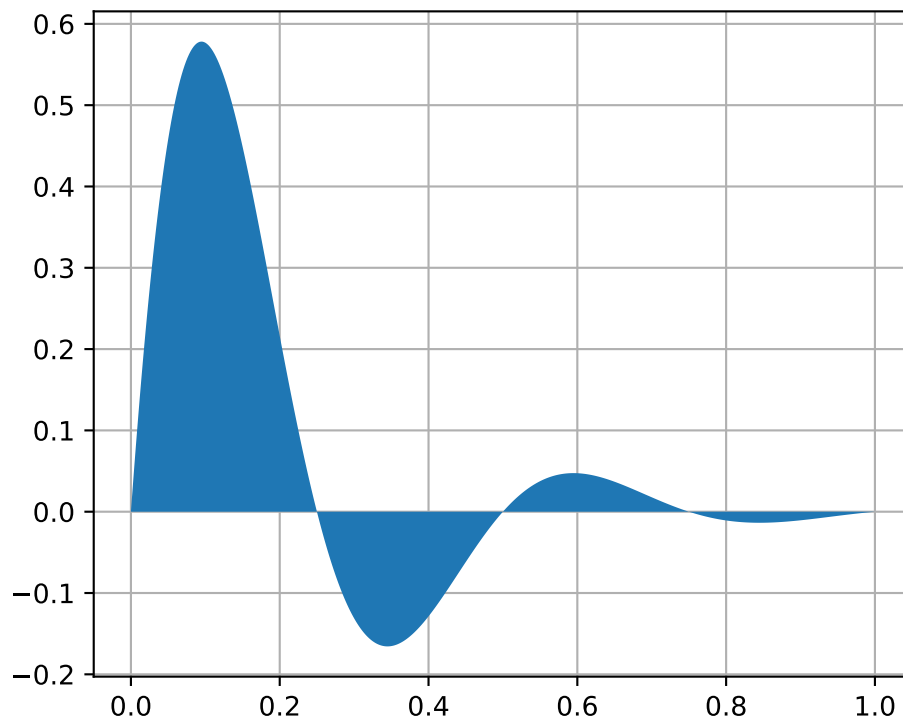

Note: In addition to the above described arguments, this function can take a **data** keyword argument.

If such a **data** argument is given, the following arguments are replaced by **data[<arg>]**:

- All arguments with the following names: 'x', 'y'.

19.1.2 Spans

<code>Axes.axhline</code>	Add a horizontal line across the axis.
<code>Axes.axhspan</code>	Add a horizontal span (rectangle) across the axis.
<code>Axes.axvline</code>	Add a vertical line across the axes.
<code>Axes.axvspan</code>	Add a vertical span (rectangle) across the axes.

matplotlib.axes.Axes.axhline

`Axes.axhline`($y=0$, $xmin=0$, $xmax=1$, ***kwargs*)

Add a horizontal line across the axis.

Parameters y : scalar, optional, default: 0

y position in data coordinates of the horizontal line.

xmin : scalar, optional, default: 0

Should be between 0 and 1, 0 being the far left of the plot, 1 the far right of the plot.

xmax : scalar, optional, default: 1

Should be between 0 and 1, 0 being the far left of the plot, 1 the far right of the plot.

Returns *Line2D*

See also:

[axhspan](#) for example plot and source code

Notes

kwargs are passed to *Line2D* and can be used to control the line properties.

Examples

- draw a thick red hline at 'y' = 0 that spans the xrange:

```
>>> axhline(linewidth=4, color='r')
```

- draw a default hline at 'y' = 1 that spans the xrange:

```
>>> axhline(y=1)
```

- draw a default hline at 'y' = .5 that spans the middle half of the xrange:

```
>>> axhline(y=.5, xmin=0.25, xmax=0.75)
```

Valid kwargs are *Line2D* properties, with the exception of 'transform':

Property	Description
<i>agg_filter</i>	unknown
<i>alpha</i>	float (0.0 transparent through 1.0 opaque)
<i>animated</i>	[True False]
<i>antialiased</i> or <i>aa</i>	[True False]
<i>axes</i>	an <i>Axes</i> instance
<i>clip_box</i>	a <i>matplotlib.transforms.Bbox</i> instance
<i>clip_on</i>	[True False]
<i>clip_path</i>	[(<i>Path</i> , <i>Transform</i>) <i>Patch</i> None]
<i>color</i> or <i>c</i>	any matplotlib color
<i>contains</i>	a callable function
<i>dash_capstyle</i>	['butt' 'round' 'projecting']
<i>dash_joinstyle</i>	['miter' 'round' 'bevel']
<i>dashes</i>	sequence of on/off ink in points
<i>drawstyle</i>	['default' 'steps' 'steps-pre' 'steps-mid' 'steps-post']
<i>figure</i>	a <i>matplotlib.figure.Figure</i> instance
<i>fillstyle</i>	['full' 'left' 'right' 'bottom' 'top' 'none']
<i>gid</i>	an id string
<i>label</i>	string or anything printable with '%s' conversion.
<i>linestyle</i> or <i>ls</i>	['solid' 'dashed', 'dashdot', 'dotted' (offset, on-off-dash-seq) '-' '--' '-.' ' ']
<i>linewidth</i> or <i>lw</i>	float value in points
<i>marker</i>	<i>A valid marker style</i>
<i>markeredgecolor</i> or <i>mec</i>	any matplotlib color
<i>markeredgewidth</i> or <i>mew</i>	float value in points
<i>markerfacecolor</i> or <i>mfc</i>	any matplotlib color
<i>markerfacecoloralt</i> or <i>mfcalt</i>	any matplotlib color
<i>markersize</i> or <i>ms</i>	float
<i>markevery</i>	[None int length-2 tuple of int slice list/array of int float length-2 tuple of float]
<i>path_effects</i>	unknown
<i>picker</i>	float distance in points or callable pick function <code>fn(artist, event)</code>
<i>pickradius</i>	float distance in points
<i>rasterized</i>	[True False None]
<i>sketch_params</i>	unknown
<i>snap</i>	unknown
<i>solid_capstyle</i>	['butt' 'round' 'projecting']
<i>solid_joinstyle</i>	['miter' 'round' 'bevel']
<i>transform</i>	a <i>matplotlib.transforms.Transform</i> instance

Table 19.14 – continued from previous page

Property	Description
<i>url</i>	a url string
<i>visible</i>	[True False]
<i>xdata</i>	1D array
<i>ydata</i>	1D array
<i>zorder</i>	any number

matplotlib.axes.Axes.axhspan

Axes. **axhspan**(*ymin*, *ymax*, *xmin=0*, *xmax=1*, ***kwargs*)

Add a horizontal span (rectangle) across the axis.

Draw a horizontal span (rectangle) from *ymin* to *ymax*. With the default values of *xmin* = 0 and *xmax* = 1, this always spans the xrange, regardless of the xlim settings, even if you change them, e.g., with the *set_xlim()* command. That is, the horizontal extent is in axes coords: 0=left, 0.5=middle, 1.0=right but the y location is in data coordinates.

Parameters *ymin* : float

Lower limit of the horizontal span in data units.

ymax : float

Upper limit of the horizontal span in data units.

xmin : float, optional, default: 0

Lower limit of the vertical span in axes (relative 0-1) units.

xmax : float, optional, default: 1

Upper limit of the vertical span in axes (relative 0-1) units.

Returns Polygon : *Polygon*

Other Parameters *kwargs* : *Polygon* properties.

Property	Description
<i>agg_filter</i>	unknown
<i>alpha</i>	float or None
<i>animated</i>	[True False]
<i>antialiased</i> or <i>aa</i>	[True False] or None for default
<i>axes</i>	an <i>Axes</i> instance
<i>capstyle</i>	['butt' 'round' 'projecting']
<i>clip_box</i>	a <i>matplotlib.transforms.Bbox</i> instance
<i>clip_on</i>	[True False]
<i>clip_path</i>	[(<i>Path</i> , <i>Transform</i>) <i>Patch</i> None]

Continued on

Table 19.15 – continued from previous page

Property	Description
<i>color</i>	matplotlib color spec
<i>contains</i>	a callable function
<i>edgecolor</i> or <i>ec</i>	mpl color spec, None, ‘none’, or ‘auto’
<i>facecolor</i> or <i>fc</i>	mpl color spec, or None for default, or ‘none’ for no color
<i>figure</i>	a <i>matplotlib.figure.Figure</i> instance
<i>fill</i>	[True False]
<i>gid</i>	an id string
<i>hatch</i>	[‘/’ ‘\’ ‘ ’ ‘-’ ‘+’ ‘x’ ‘o’ ‘O’ ‘.’ ‘*’]
<i>joinstyle</i>	[‘miter’ ‘round’ ‘bevel’]
<i>label</i>	string or anything printable with ‘%s’ conversion.
<i>linestyle</i> or <i>ls</i>	[‘solid’ ‘dashed’, ‘dashdot’, ‘dotted’ (offset, on-off-dash-seq) ‘-’ ‘--’ ‘-.’ ‘:’ ‘None’]
<i>linewidth</i> or <i>lw</i>	float or None for default
<i>path_effects</i>	unknown
<i>picker</i>	[None float boolean callable]
<i>rasterized</i>	[True False None]
<i>sketch_params</i>	unknown
<i>snap</i>	unknown
<i>transform</i>	<i>Transform</i> instance
<i>url</i>	a url string
<i>visible</i>	[True False]
<i>zorder</i>	any number

See also:

axvspan Add a vertical span (rectangle) across the axes.

Examples

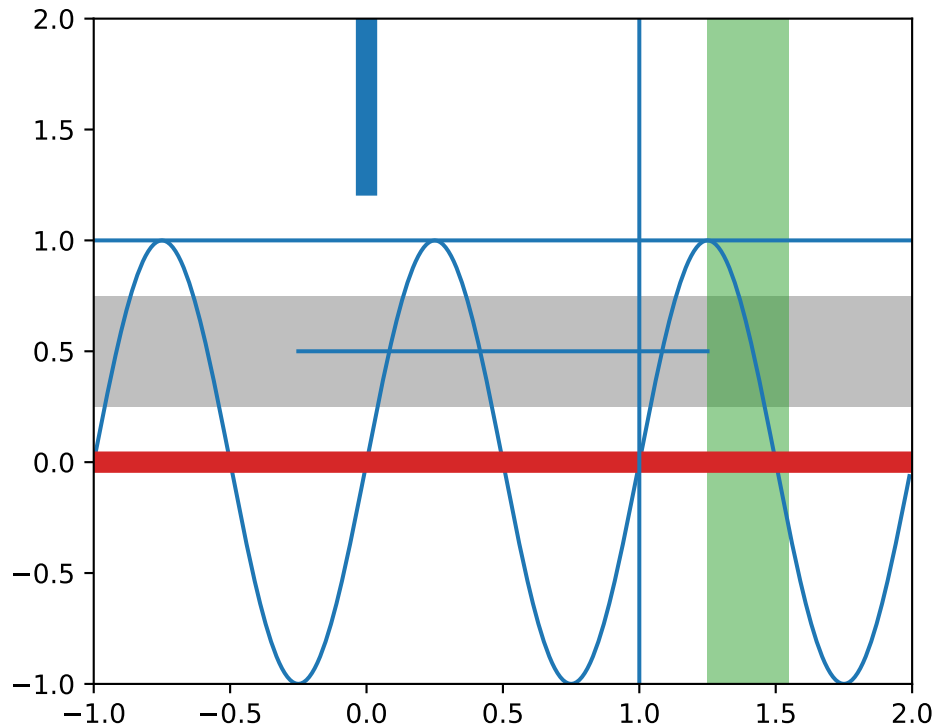
**matplotlib.axes.Axes.axvline**

Axes.*axvline*(*x=0, ymin=0, ymax=1, **kwargs*)

Add a vertical line across the axes.

Parameters *x* : scalar, optional, default: 0

x position in data coordinates of the vertical line.

ymin : scalar, optional, default: 0

Should be between 0 and 1, 0 being the bottom of the plot, 1 the top of the plot.

ymax : scalar, optional, default: 1

Should be between 0 and 1, 0 being the bottom of the plot, 1 the top of the plot.

Returns *Line2D*

See also:

[axhspan](#) for example plot and source code

Examples

- draw a thick red vline at $x = 0$ that spans the yrange:

```
>>> axvline(linewidth=4, color='r')
```

- draw a default vline at $x = 1$ that spans the yrange:

```
>>> axvline(x=1)
```

- draw a default vline at $x = .5$ that spans the middle half of the yrange:

```
>>> axvline(x=.5, ymin=0.25, ymax=0.75)
```

Valid kwargs are *Line2D* properties, with the exception of ‘transform’:

Property	Description
<i>agg_filter</i>	unknown
<i>alpha</i>	float (0.0 transparent through 1.0 opaque)
<i>animated</i>	[True False]
<i>antialiased</i> or <i>aa</i>	[True False]
<i>axes</i>	an <i>Axes</i> instance
<i>clip_box</i>	a <i>matplotlib.transforms.Bbox</i> instance
<i>clip_on</i>	[True False]
<i>clip_path</i>	[(<i>Path</i> , <i>Transform</i>) <i>Patch</i> None]
<i>color</i> or <i>c</i>	any matplotlib color
<i>contains</i>	a callable function
<i>dash_capstyle</i>	[‘butt’ ‘round’ ‘projecting’]
<i>dash_joinstyle</i>	[‘miter’ ‘round’ ‘bevel’]
<i>dashes</i>	sequence of on/off ink in points
<i>drawstyle</i>	[‘default’ ‘steps’ ‘steps-pre’ ‘steps-mid’ ‘steps-post’]
<i>figure</i>	a <i>matplotlib.figure.Figure</i> instance
<i>fillstyle</i>	[‘full’ ‘left’ ‘right’ ‘bottom’ ‘top’ ‘none’]
<i>gid</i>	an id string
<i>label</i>	string or anything printable with ‘%s’ conversion.
<i>linestyle</i> or <i>ls</i>	[‘solid’ ‘dashed’, ‘dashdot’, ‘dotted’ (offset, on-off-dash-seq) ‘-’ ‘--’ ‘-.’ ‘.’]
<i>linewidth</i> or <i>lw</i>	float value in points
<i>marker</i>	<i>A valid marker style</i>
<i>markeredgecolor</i> or <i>mec</i>	any matplotlib color
<i>markeredgewidth</i> or <i>mew</i>	float value in points
<i>markerfacecolor</i> or <i>mfc</i>	any matplotlib color
<i>markerfacecoloralt</i> or <i>mfcalt</i>	any matplotlib color
<i>markersize</i> or <i>ms</i>	float

Table 19.16 – continued from previous page

Property	Description
<i>markevery</i>	[None int length-2 tuple of int slice list/array of int float length-2 tuple of float]
<i>path_effects</i>	unknown
<i>picker</i>	float distance in points or callable pick function <code>fn(artist, event)</code>
<i>pickradius</i>	float distance in points
<i>rasterized</i>	[True False None]
<i>sketch_params</i>	unknown
<i>snap</i>	unknown
<i>solid_capstyle</i>	['butt' 'round' 'projecting']
<i>solid_joinstyle</i>	['miter' 'round' 'bevel']
<i>transform</i>	a <code>matplotlib.transforms.Transform</code> instance
<i>url</i>	a url string
<i>visible</i>	[True False]
<i>xdata</i>	1D array
<i>ydata</i>	1D array
<i>zorder</i>	any number

matplotlib.axes.Axes.axvspan

Axes.*axvspan*(*xmin*, *xmax*, *ymin*=0, *ymax*=1, ***kwargs*)

Add a vertical span (rectangle) across the axes.

Draw a vertical span (rectangle) from *xmin* to *xmax*. With the default values of *ymin* = 0 and *ymax* = 1. This always spans the yrange, regardless of the *ylim* settings, even if you change them, e.g., with the `set_ylim()` command. That is, the vertical extent is in axes coords: 0=bottom, 0.5=middle, 1.0=top but the y location is in data coordinates.

Parameters *xmin* : scalar

Number indicating the first X-axis coordinate of the vertical span rectangle in data units.

xmax : scalar

Number indicating the second X-axis coordinate of the vertical span rectangle in data units.

ymin : scalar, optional

Number indicating the first Y-axis coordinate of the vertical span rectangle in relative Y-axis units (0-1). Default to 0.

ymax : scalar, optional

Number indicating the second Y-axis coordinate of the vertical span rectangle in relative Y-axis units (0-1). Default to 1.

Returns *rectangle* : `matplotlib.patches.Polygon`

Vertical span (rectangle) from (xmin, ymin) to (xmax, ymax).

Other Parameters ****kwargs**

Optional parameters are properties of the class `matplotlib.patches.Polygon`.

See also:

[`axhspan`](#)

Examples

Draw a vertical, green, translucent rectangle from $x = 1.25$ to $x = 1.55$ that spans the yrange of the axes.

```
>>> axvspan(1.25, 1.55, facecolor='g', alpha=0.5)
```

19.1.3 Spectral

<code>Axes.acorr</code>	Plot the autocorrelation of x .
<code>Axes.angle_spectrum</code>	Plot the angle spectrum.
<code>Axes.cohere</code>	Plot the coherence between x and y .
<code>Axes.csd</code>	Plot the cross-spectral density.
<code>Axes.magnitude_spectrum</code>	Plot the magnitude spectrum.
<code>Axes.phase_spectrum</code>	Plot the phase spectrum.
<code>Axes.psd</code>	Plot the power spectral density.
<code>Axes.specgram</code>	Plot a spectrogram.
<code>Axes.xcorr</code>	Plot the cross correlation between x and y .

`matplotlib.axes.Axes.acorr`

`Axes.acorr`(x , ****kwargs**)

Plot the autocorrelation of x .

Parameters x : sequence of scalar

hold : boolean, optional, *deprecated*, default: True

detrend : callable, optional, default: `mlab.detrend_none`

x is detrended by the `detrend` callable. Default is no normalization.

normed : boolean, optional, default: True

if True, input vectors are normalised to unit length.

usevlines : boolean, optional, default: True

if True, `Axes.vlines` is used to plot the vertical lines from the origin to the `acorr`. Otherwise, `Axes.plot` is used.

maxlags : integer, optional, default: 10

number of lags to show. If None, will return all $2 * \text{len}(x) - 1$ lags.

Returns (lags, c, line, b) : where:

- lags are a length $2 * \text{maxlags} + 1$ lag vector.
- c is the $2 * \text{maxlags} + 1$ auto correlation vector
- line is a *Line2D* instance returned by *plot*.
- b is the x-axis.

Other Parameters linestyle : *Line2D* prop, optional, default: None

Only used if usevlines is False.

marker : string, optional, default: 'o'

Notes

The cross correlation is performed with `numpy.correlate()` with `mode = 2`.

Examples

xcorr is top graph, and *acorr* is bottom graph.

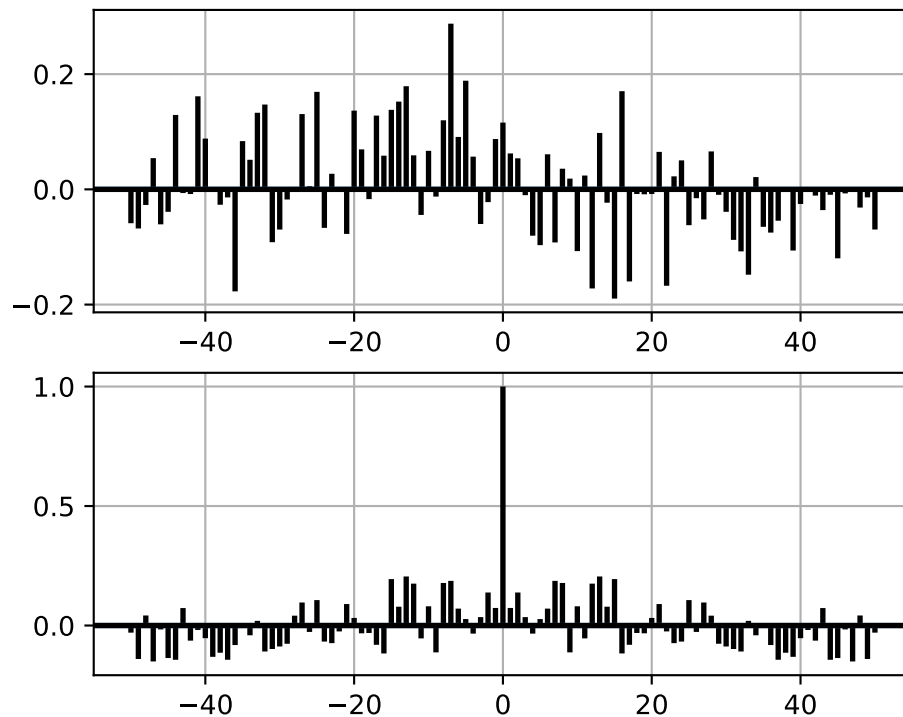

Note: In addition to the above described arguments, this function can take a **data** keyword argument. If such a **data** argument is given, the following arguments are replaced by **data[<arg>]**:

- All arguments with the following names: 'x'.
-

matplotlib.axes.Axes.angle_spectrum

Axes.angle_spectrum(*x*, *Fs*=None, *Fc*=None, *window*=None, *pad_to*=None, *sides*=None, ****kwargs**)

Plot the angle spectrum.

Call signature:

```
angle_spectrum(x, Fs=2, Fc=0, window=mlab.window_hanning,
              pad_to=None, sides='default', **kwargs)
```

Compute the angle spectrum (wrapped phase spectrum) of *x*. Data is padded to a length of *pad_to* and the windowing function *window* is applied to the signal.

Parameters x : 1-D array or sequence

Array or sequence containing the data

Fs : scalar

The sampling frequency (samples per time unit). It is used to calculate the Fourier frequencies, `freqs`, in cycles per time unit. The default value is 2.

window : callable or ndarray

A function or a vector of length *NFFT*. To create window vectors see `window_hanning()`, `window_none()`, `numpy.blackman()`, `numpy.hamming()`, `numpy.bartlett()`, `scipy.signal()`, `scipy.signal.get_window()`, etc. The default is `window_hanning()`. If a function is passed as the argument, it must take a data segment as an argument and return the windowed version of the segment.

sides : ['default' | 'onesided' | 'twosided']

Specifies which sides of the spectrum to return. Default gives the default behavior, which returns one-sided for real data and both for complex data. 'onesided' forces the return of a one-sided spectrum, while 'twosided' forces two-sided.

pad_to : integer

The number of points to which the data segment is padded when performing the FFT. While not increasing the actual resolution of the spectrum (the minimum distance between resolvable peaks), this can give more points in the plot, allowing for more detail. This corresponds to the *n* parameter in the call to `fft()`. The default is `None`, which sets *pad_to* equal to the length of the input signal (i.e. no padding).

Fc : integer

The center frequency of *x* (defaults to 0), which offsets the x extents of the plot to reflect the frequency range used when a signal is acquired and then filtered and downsampled to baseband.

****kwargs** :

Keyword arguments control the *Line2D* properties:

Property	Description
<i>agg_filter</i>	unknown
<i>alpha</i>	float (0.0 transparent through 1.0 opaque)
<i>animated</i>	[True False]
<i>antialiased</i> or <i>aa</i>	[True False]
<i>axes</i>	an <i>Axes</i> instance
<i>clip_box</i>	a <i>matplotlib.transforms.Bbox</i> instance
<i>clip_on</i>	[True False]
<i>clip_path</i>	[(<i>Path</i> , <i>Transform</i>) <i>Patch</i> None]
<i>color</i> or <i>c</i>	any matplotlib color
<i>contains</i>	a callable function
<i>dash_capstyle</i>	['butt' 'round' 'projecting']
<i>dash_joinstyle</i>	['miter' 'round' 'bevel']

Table 19.18 – continued from previous page

Property	Description
<i>dashes</i>	sequence of on/off ink in points
<i>drawstyle</i>	['default' 'steps' 'steps-pre' 'steps-mid' 'steps-post']
<i>figure</i>	a <i>matplotlib.figure.Figure</i> instance
<i>fillstyle</i>	['full' 'left' 'right' 'bottom' 'top' 'none']
<i>gid</i>	an id string
<i>label</i>	string or anything printable with '%s' conversion.
<i>linestyle</i> or <i>ls</i>	['solid' 'dashed', 'dashdot', 'dotted' (offset, on-off-dash-seq) '-' '--' '-.' ' ']
<i>linewidth</i> or <i>lw</i>	float value in points
<i>marker</i>	<i>A valid marker style</i>
<i>markeredgecolor</i> or <i>mec</i>	any matplotlib color
<i>markeredgewidth</i> or <i>mew</i>	float value in points
<i>markerfacecolor</i> or <i>mfc</i>	any matplotlib color
<i>markerfacecoloralt</i> or <i>mfcalt</i>	any matplotlib color
<i>markersize</i> or <i>ms</i>	float
<i>markevery</i>	[None int length-2 tuple of int slice list/array of int float length-2 tuple of float]
<i>path_effects</i>	unknown
<i>picker</i>	float distance in points or callable pick function <code>fn(artist, event)</code>
<i>pickradius</i>	float distance in points
<i>rasterized</i>	[True False None]
<i>sketch_params</i>	unknown
<i>snap</i>	unknown
<i>solid_capstyle</i>	['butt' 'round' 'projecting']
<i>solid_joinstyle</i>	['miter' 'round' 'bevel']
<i>transform</i>	a <i>matplotlib.transforms.Transform</i> instance
<i>url</i>	a url string
<i>visible</i>	[True False]
<i>xdata</i>	1D array
<i>ydata</i>	1D array
<i>zorder</i>	any number

Returns spectrum : 1-D array

The values for the angle spectrum in radians (real valued)

freqs : 1-D array

The frequencies corresponding to the elements in *spectrum*

line : a *Line2D* instance

The line created by this function

See also:

magnitude_spectrum() *angle_spectrum()* plots the magnitudes of the corresponding frequencies.

phase_spectrum() *phase_spectrum()* plots the unwrapped version of this function.

`specgram()` `specgram()` can plot the angle spectrum of segments within the signal in a colormap.

In addition to the above described arguments, this function can take a **data** keyword argument. If such a **data** argument is given, the following arguments are replaced by **data[<arg>]**: * All arguments with the following names: 'x'.

Examples

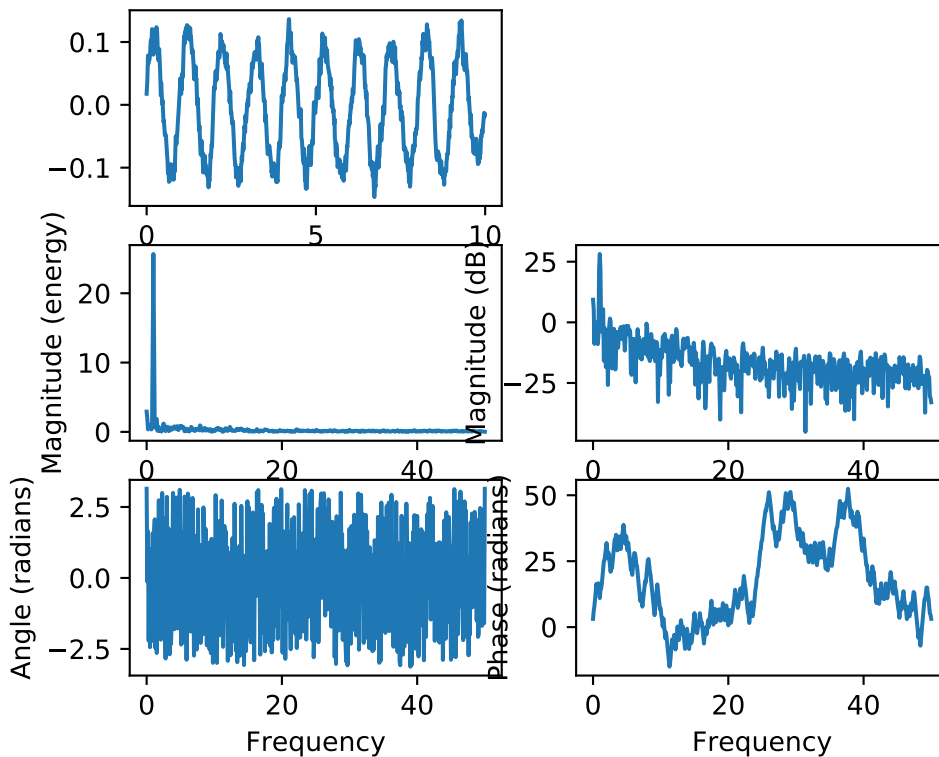

matplotlib.axes.Axes.cohere

`Axes.cohere(x, y, NFFT=256, Fs=2, Fc=0, detrend=<function detrend_none>, window=<function window_hanning>, noverlap=0, pad_to=None, sides='default', scale_by_freq=None, **kwargs)`

Plot the coherence between x and y .

Plot the coherence between x and y . Coherence is the normalized cross spectral density:

$$C_{xy} = \frac{|P_{xy}|^2}{P_{xx}P_{yy}} \quad (19.1)$$

Parameters Fs : scalar

The sampling frequency (samples per time unit). It is used to calculate the Fourier frequencies, freqs, in cycles per time unit. The default value is 2.

window : callable or ndarray

A function or a vector of length $NFFT$. To create window vectors see `window_hanning()`, `window_none()`, `numpy.blackman()`, `numpy.hamming()`, `numpy.bartlett()`, `scipy.signal()`, `scipy.signal.get_window()`, etc. The default is `window_hanning()`. If a function is passed as the argument, it must take a data segment as an argument and return the windowed version of the segment.

sides : ['default' | 'onesided' | 'twosided']

Specifies which sides of the spectrum to return. Default gives the default behavior, which returns one-sided for real data and both for complex data. 'onesided' forces the return of a one-sided spectrum, while 'twosided' forces two-sided.

pad_to : integer

The number of points to which the data segment is padded when performing the FFT. This can be different from $NFFT$, which specifies the number of data points used. While not increasing the actual resolution of the spectrum (the minimum distance between resolvable peaks), this can give more points in the plot, allowing for more detail. This corresponds to the n parameter in the call to `fft()`. The default is `None`, which sets `pad_to` equal to $NFFT$

NFFT : integer

The number of data points used in each block for the FFT. A power 2 is most efficient. The default value is 256. This should *NOT* be used to get zero padding, or the scaling of the result will be incorrect. Use `pad_to` for this instead.

detrend : { 'default', 'constant', 'mean', 'linear', 'none' } or callable

The function applied to each segment before `fft`-ing, designed to remove the mean or linear trend. Unlike in MATLAB, where the `detrend` parameter is a vector, in matplotlib it is a function. The `pylab` module defines `detrend_none()`, `detrend_mean()`, and `detrend_linear()`, but you can use a custom function as well. You can also use a string to choose one of the functions. 'default', 'constant', and 'mean' call `detrend_mean()`. 'linear' calls `detrend_linear()`. 'none' calls `detrend_none()`.

scale_by_freq : boolean, optional

Specifies whether the resulting density values should be scaled by the scaling frequency, which gives density in units of Hz^{-1} . This allows for integration over the returned frequency values. The default is `True` for MATLAB compatibility.

noverlap : integer

The number of points of overlap between blocks. The default value is 0 (no overlap).

Fc : integer

The center frequency of x (defaults to 0), which offsets the x extents of the plot to reflect the frequency range used when a signal is acquired and then filtered and downsampled to baseband.

****kwargs :**

Keyword arguments control the *Line2D* properties of the coherence plot:

Property	Description
<i>agg_filter</i>	unknown
<i>alpha</i>	float (0.0 transparent through 1.0 opaque)
<i>animated</i>	[True False]
<i>antialiased</i> or <i>aa</i>	[True False]
<i>axes</i>	an <i>Axes</i> instance
<i>clip_box</i>	a <i>matplotlib.transforms.Bbox</i> instance
<i>clip_on</i>	[True False]
<i>clip_path</i>	[(<i>Path</i> , <i>Transform</i>) <i>Patch</i> None]
<i>color</i> or <i>c</i>	any matplotlib color
<i>contains</i>	a callable function
<i>dash_capstyle</i>	['butt' 'round' 'projecting']
<i>dash_joinstyle</i>	['miter' 'round' 'bevel']
<i>dashes</i>	sequence of on/off ink in points
<i>drawstyle</i>	['default' 'steps' 'steps-pre' 'steps-mid' 'steps-post']
<i>figure</i>	a <i>matplotlib.figure.Figure</i> instance
<i>fillstyle</i>	['full' 'left' 'right' 'bottom' 'top' 'none']
<i>gid</i>	an id string
<i>label</i>	string or anything printable with '%s' conversion.
<i>linestyle</i> or <i>ls</i>	['solid' 'dashed', 'dashdot', 'dotted' (offset, on-off-dash-seq) '-' '--' '-.' ' ']
<i>linewidth</i> or <i>lw</i>	float value in points
<i>marker</i>	<i>A valid marker style</i>
<i>markeredgecolor</i> or <i>mec</i>	any matplotlib color
<i>markeredgewidth</i> or <i>mew</i>	float value in points
<i>markerfacecolor</i> or <i>mfc</i>	any matplotlib color
<i>markerfacecoloralt</i> or <i>mfcalt</i>	any matplotlib color
<i>markersize</i> or <i>ms</i>	float
<i>markevery</i>	[None int length-2 tuple of int slice list/array of int float length-2 tuple of float]
<i>path_effects</i>	unknown
<i>picker</i>	float distance in points or callable pick function <code>fn(artist, event)</code>
<i>pickradius</i>	float distance in points
<i>rasterized</i>	[True False None]
<i>sketch_params</i>	unknown
<i>snap</i>	unknown
<i>solid_capstyle</i>	['butt' 'round' 'projecting']
<i>solid_joinstyle</i>	['miter' 'round' 'bevel']
<i>transform</i>	a <i>matplotlib.transforms.Transform</i> instance
<i>url</i>	a url string

Table 19.19 – continued from previous page

Property	Description
<i>visible</i>	[True False]
<i>xdata</i>	1D array
<i>ydata</i>	1D array
<i>zorder</i>	any number

Returns The return value is a tuple (C_{xy}, f) , where f are the frequencies of the coherence vector.

kwargs are applied to the lines.

References

Bendat & Piersol – Random Data: Analysis and Measurement Procedures, John Wiley & Sons (1986)

Examples

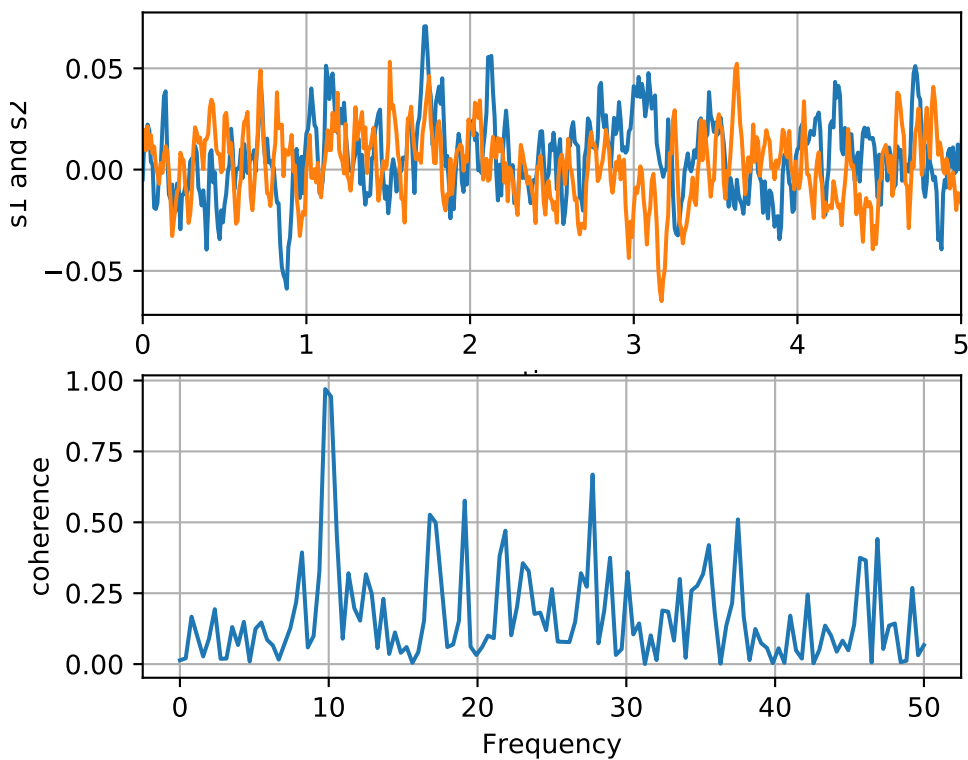

Note: In addition to the above described arguments, this function can take a **data** keyword argument. If such a **data** argument is given, the following arguments are replaced by **data[<arg>]**:

- All arguments with the following names: 'x', 'y'.

matplotlib.axes.Axes.csd

`Axes.csd(x, y, NFFT=None, Fs=None, Fc=None, detrend=None, window=None, noverlap=None, pad_to=None, sides=None, scale_by_freq=None, return_line=None, **kwargs)`
Plot the cross-spectral density.

Call signature:

```
csd(x, y, NFFT=256, Fs=2, Fc=0, detrend=mlab.detrend_none,
    window=mlab.window_hanning, noverlap=0, pad_to=None,
    sides='default', scale_by_freq=None, return_line=None, **kwargs)
```

The cross spectral density P_{xy} by Welch's average periodogram method. The vectors x and y are divided into $NFFT$ length segments. Each segment is detrended by function *detrend* and windowed by function *window*. *noverlap* gives the length of the overlap between segments. The product of the direct FFTs of x and y are averaged over each segment to compute P_{xy} , with a scaling to correct for power loss due to windowing.

If $\text{len}(x) < NFFT$ or $\text{len}(y) < NFFT$, they will be zero padded to $NFFT$.

Parameters x, y : 1-D arrays or sequences

Arrays or sequences containing the data

Fs : scalar

The sampling frequency (samples per time unit). It is used to calculate the Fourier frequencies, *freqs*, in cycles per time unit. The default value is 2.

window : callable or ndarray

A function or a vector of length $NFFT$. To create window vectors see `window_hanning()`, `window_none()`, `numpy.blackman()`, `numpy.hamming()`, `numpy.bartlett()`, `scipy.signal()`, `scipy.signal.get_window()`, etc. The default is `window_hanning()`. If a function is passed as the argument, it must take a data segment as an argument and return the windowed version of the segment.

sides : ['default' | 'onesided' | 'twosided']

Specifies which sides of the spectrum to return. Default gives the default behavior, which returns one-sided for real data and both for complex data. 'onesided' forces the return of a one-sided spectrum, while 'twosided' forces two-sided.

pad_to : integer

The number of points to which the data segment is padded when performing the FFT. This can be different from $NFFT$, which specifies the number of data points used. While not increasing the actual resolution of the spectrum (the minimum distance between resolvable peaks), this can give more points in

the plot, allowing for more detail. This corresponds to the n parameter in the call to `fft()`. The default is `None`, which sets `pad_to` equal to `NFFT`

NFFT : integer

The number of data points used in each block for the FFT. A power 2 is most efficient. The default value is 256. This should *NOT* be used to get zero padding, or the scaling of the result will be incorrect. Use `pad_to` for this instead.

detrend : { 'default', 'constant', 'mean', 'linear', 'none' } or callable

The function applied to each segment before fit-ting, designed to remove the mean or linear trend. Unlike in MATLAB, where the `detrend` parameter is a vector, in matplotlib is it a function. The `pylab` module defines `detrend_none()`, `detrend_mean()`, and `detrend_linear()`, but you can use a custom function as well. You can also use a string to choose one of the functions. 'default', 'constant', and 'mean' call `detrend_mean()`. 'linear' calls `detrend_linear()`. 'none' calls `detrend_none()`.

scale_by_freq : boolean, optional

Specifies whether the resulting density values should be scaled by the scaling frequency, which gives density in units of Hz^{-1} . This allows for integration over the returned frequency values. The default is `True` for MATLAB compatibility.

noverlap : integer

The number of points of overlap between segments. The default value is 0 (no overlap).

Fc : integer

The center frequency of x (defaults to 0), which offsets the x extents of the plot to reflect the frequency range used when a signal is acquired and then filtered and downsampled to baseband.

return_line : bool

Whether to include the line object plotted in the returned values. Default is `False`.

****kwargs** :

Keyword arguments control the `Line2D` properties:

Property	Description
<code>agg_filter</code>	unknown
<code>alpha</code>	float (0.0 transparent through 1.0 opaque)
<code>animated</code>	[True False]
<code>antialiased</code> or <code>aa</code>	[True False]
<code>axes</code>	an <code>Axes</code> instance

Table 19.20 – continued from previous page

Property	Description
<code>clip_box</code>	a <code>matplotlib.transforms.Bbox</code> instance
<code>clip_on</code>	[True False]
<code>clip_path</code>	[(<code>Path</code> , <code>Transform</code>) <code>Patch</code> None]
<code>color</code> or <code>c</code>	any matplotlib color
<code>contains</code>	a callable function
<code>dash_capstyle</code>	['butt' 'round' 'projecting']
<code>dash_joinstyle</code>	['miter' 'round' 'bevel']
<code>dashes</code>	sequence of on/off ink in points
<code>drawstyle</code>	['default' 'steps' 'steps-pre' 'steps-mid' 'steps-post']
<code>figure</code>	a <code>matplotlib.figure.Figure</code> instance
<code>fillstyle</code>	['full' 'left' 'right' 'bottom' 'top' 'none']
<code>gid</code>	an id string
<code>label</code>	string or anything printable with '%s' conversion.
<code>linestyle</code> or <code>ls</code>	['solid' 'dashed', 'dashdot', 'dotted' (offset, on-off-dash-seq) '-' '--' '-.' ''
<code>linewidth</code> or <code>lw</code>	float value in points
<code>marker</code>	<i>A valid marker style</i>
<code>markeredgecolor</code> or <code>mec</code>	any matplotlib color
<code>markeredgewidth</code> or <code>mew</code>	float value in points
<code>markerfacecolor</code> or <code>mfc</code>	any matplotlib color
<code>markerfacecoloralt</code> or <code>mfcalt</code>	any matplotlib color
<code>markersize</code> or <code>ms</code>	float
<code>markevery</code>	[None int length-2 tuple of int slice list/array of int float length-2 tuple of float]
<code>path_effects</code>	unknown
<code>picker</code>	float distance in points or callable pick function <code>fn(artist, event)</code>
<code>pickradius</code>	float distance in points
<code>rasterized</code>	[True False None]
<code>sketch_params</code>	unknown
<code>snap</code>	unknown
<code>solid_capstyle</code>	['butt' 'round' 'projecting']
<code>solid_joinstyle</code>	['miter' 'round' 'bevel']
<code>transform</code>	a <code>matplotlib.transforms.Transform</code> instance
<code>url</code>	a url string
<code>visible</code>	[True False]
<code>xdata</code>	1D array
<code>ydata</code>	1D array
<code>zorder</code>	any number

Returns `Pxy` : 1-D array

The values for the cross spectrum $P_{\{xy\}}$ before scaling (complex valued)

freqs : 1-D array

The frequencies corresponding to the elements in `Pxy`

line : a `Line2D` instance

The line created by this function. Only returned if *return_line* is True.

See also:

psd() *psd()* is the equivalent to setting $y=x$.

In addition to the above described arguments, this function can take a **data** keyword argument. If such a **data** argument is given, the following arguments are replaced by **data[<arg>]**: * All arguments with the following names: 'x', 'y'.

Notes

For plotting, the power is plotted as $10 \log_{10}(P_{xy})$ for decibels, though $P_{\{xy\}}$ itself is returned.

References

Bendat & Piersol – Random Data: Analysis and Measurement Procedures, John Wiley & Sons (1986)

Examples

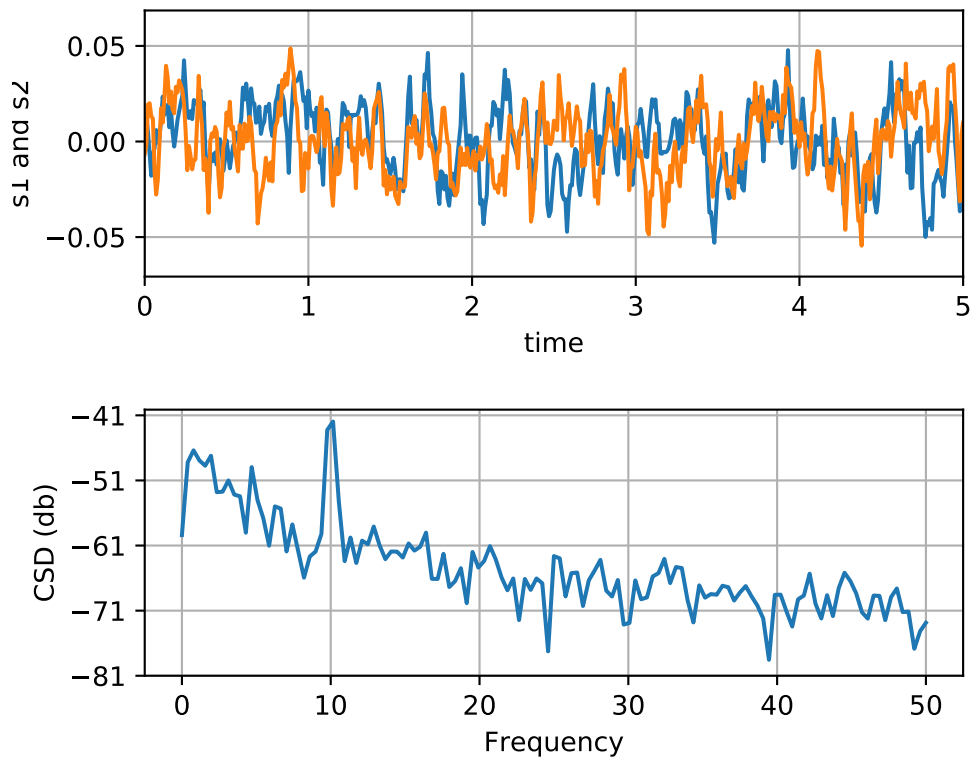

matplotlib.axes.Axes.magnitude_spectrum

Axes.magnitude_spectrum(*x*, *Fs=None*, *Fc=None*, *window=None*, *pad_to=None*, *sides=None*, *scale=None*, ****kwargs**)

Plot the magnitude spectrum.

Call signature:

```
magnitude_spectrum(x, Fs=2, Fc=0, window=mlab.window_hanning,
                   pad_to=None, sides='default', **kwargs)
```

Compute the magnitude spectrum of *x*. Data is padded to a length of *pad_to* and the windowing function *window* is applied to the signal.

Parameters x : 1-D array or sequence

Array or sequence containing the data

Fs : scalar

The sampling frequency (samples per time unit). It is used to calculate the Fourier frequencies, *freqs*, in cycles per time unit. The default value is 2.

window : callable or ndarray

A function or a vector of length *NFFT*. To create window vectors see `window_hanning()`, `window_none()`, `numpy.blackman()`, `numpy.hamming()`, `numpy.bartlett()`, `scipy.signal()`, `scipy.signal.get_window()`, etc. The default is `window_hanning()`. If a function is passed as the argument, it must take a data segment as an argument and return the windowed version of the segment.

sides : ['default' | 'onesided' | 'twosided']

Specifies which sides of the spectrum to return. Default gives the default behavior, which returns one-sided for real data and both for complex data. 'onesided' forces the return of a one-sided spectrum, while 'twosided' forces two-sided.

pad_to : integer

The number of points to which the data segment is padded when performing the FFT. While not increasing the actual resolution of the spectrum (the minimum distance between resolvable peaks), this can give more points in the plot, allowing for more detail. This corresponds to the *n* parameter in the call to `fft()`. The default is `None`, which sets *pad_to* equal to the length of the input signal (i.e. no padding).

scale : ['default' | 'linear' | 'dB']

The scaling of the values in the *spec*. 'linear' is no scaling. 'dB' returns the values in dB scale. When *mode* is 'density', this is dB power ($10 * \log_{10}$). Otherwise this is dB amplitude ($20 * \log_{10}$). 'default' is 'linear'.

Fc : integer

The center frequency of x (defaults to 0), which offsets the x extents of the plot to reflect the frequency range used when a signal is acquired and then filtered and downsampled to baseband.

****kwargs :**

Keyword arguments control the *Line2D* properties:

Property	Description
<i>agg_filter</i>	unknown
<i>alpha</i>	float (0.0 transparent through 1.0 opaque)
<i>animated</i>	[True False]
<i>antialiased</i> or <i>aa</i>	[True False]
<i>axes</i>	an <i>Axes</i> instance
<i>clip_box</i>	a <i>matplotlib.transforms.Bbox</i> instance
<i>clip_on</i>	[True False]
<i>clip_path</i>	[(<i>Path</i> , <i>Transform</i>) <i>Patch</i> None]
<i>color</i> or <i>c</i>	any matplotlib color
<i>contains</i>	a callable function
<i>dash_capstyle</i>	['butt' 'round' 'projecting']
<i>dash_joinstyle</i>	['miter' 'round' 'bevel']
<i>dashes</i>	sequence of on/off ink in points
<i>drawstyle</i>	['default' 'steps' 'steps-pre' 'steps-mid' 'steps-post']
<i>figure</i>	a <i>matplotlib.figure.Figure</i> instance
<i>fillstyle</i>	['full' 'left' 'right' 'bottom' 'top' 'none']
<i>gid</i>	an id string
<i>label</i>	string or anything printable with '%s' conversion.
<i>linestyle</i> or <i>ls</i>	['solid' 'dashed', 'dashdot', 'dotted' (offset, on-off-dash-seq) '- ' '--' '-.' ' ']
<i>linewidth</i> or <i>lw</i>	float value in points
<i>marker</i>	<i>A valid marker style</i>
<i>markeredgecolor</i> or <i>mec</i>	any matplotlib color
<i>markeredgewidth</i> or <i>mew</i>	float value in points
<i>markerfacecolor</i> or <i>mfc</i>	any matplotlib color
<i>markerfacecoloralt</i> or <i>mfcalt</i>	any matplotlib color
<i>markersize</i> or <i>ms</i>	float
<i>markevery</i>	[None int length-2 tuple of int slice list/array of int float length-2 tuple of float]
<i>path_effects</i>	unknown
<i>picker</i>	float distance in points or callable pick function <code>fn(artist, event)</code>
<i>pickradius</i>	float distance in points
<i>rasterized</i>	[True False None]
<i>sketch_params</i>	unknown
<i>snap</i>	unknown
<i>solid_capstyle</i>	['butt' 'round' 'projecting']
<i>solid_joinstyle</i>	['miter' 'round' 'bevel']
<i>transform</i>	a <i>matplotlib.transforms.Transform</i> instance
<i>url</i>	a url string
<i>visible</i>	[True False]

Table 19.21 – continued from previous page

Property	Description
<i>xdata</i>	1D array
<i>ydata</i>	1D array
<i>zorder</i>	any number

Returns spectrum : 1-D array

The values for the magnitude spectrum before scaling (real valued)

freqs : 1-D array

The frequencies corresponding to the elements in *spectrum*

line : a *Line2D* instance

The line created by this function

See also:

psd() *psd()* plots the power spectral density.‘.

angle_spectrum() *angle_spectrum()* plots the angles of the corresponding frequencies.

phase_spectrum() *phase_spectrum()* plots the phase (unwrapped angle) of the corresponding frequencies.

specgram() *specgram()* can plot the magnitude spectrum of segments within the signal in a colormap.

In addition to the above described arguments, this function can take a **data** keyword argument. If such a **data** argument is given, the following arguments are replaced by **data[<arg>]**: * All arguments with the following names: ‘x’.

Examples

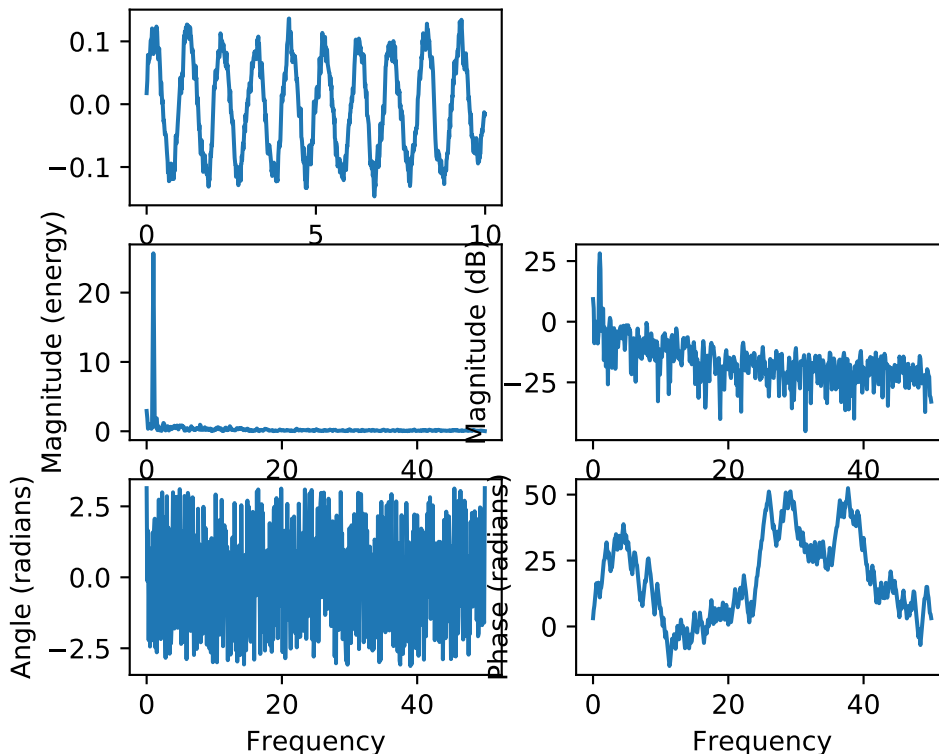
`matplotlib.axes.Axes.phase_spectrum`

`Axes.phase_spectrum(x, Fs=None, Fc=None, window=None, pad_to=None, sides=None, **kwargs)`
 Plot the phase spectrum.

Call signature:

```
phase_spectrum(x, Fs=2, Fc=0, window=mlab.window_hanning,
               pad_to=None, sides='default', **kwargs)
```

Compute the phase spectrum (unwrapped angle spectrum) of x . Data is padded to a length of pad_to and the windowing function $window$ is applied to the signal.

Parameters x : 1-D array or sequence

Array or sequence containing the data

Fs : scalar

The sampling frequency (samples per time unit). It is used to calculate the Fourier frequencies, `freqs`, in cycles per time unit. The default value is 2.

window : callable or ndarray

A function or a vector of length $NFFT$. To create window vectors see `window_hanning()`, `window_none()`, `numpy.blackman()`, `numpy.hamming()`, `numpy.bartlett()`, `scipy.signal()`, `scipy.signal.get_window()`, etc. The default is `window_hanning()`. If a function is passed as the argument, it must take a data segment as an argument and return the windowed version of the segment.

sides : ['default' | 'onesided' | 'twosided']

Specifies which sides of the spectrum to return. Default gives the default behavior, which returns one-sided for real data and both for complex data. 'onesided' forces the return of a one-sided spectrum, while 'twosided' forces two-sided.

pad_to : integer

The number of points to which the data segment is padded when performing the FFT. While not increasing the actual resolution of the spectrum (the minimum distance between resolvable peaks), this can give more points in the plot, allowing for more detail. This corresponds to the n parameter in the call to `fft()`. The default is `None`, which sets `pad_to` equal to the length of the input signal (i.e. no padding).

Fc : integer

The center frequency of x (defaults to 0), which offsets the x extents of the plot to reflect the frequency range used when a signal is acquired and then filtered and downsampled to baseband.

****kwargs** :

Keyword arguments control the *Line2D* properties:

Property	Description
<i>agg_filter</i>	unknown
<i>alpha</i>	float (0.0 transparent through 1.0 opaque)
<i>animated</i>	[True False]
<i>antialiased</i> or <i>aa</i>	[True False]
<i>axes</i>	an <i>Axes</i> instance
<i>clip_box</i>	a <i>matplotlib.transforms.Bbox</i> instance
<i>clip_on</i>	[True False]
<i>clip_path</i>	[(<i>Path</i> , <i>Transform</i>) <i>Patch</i> None]
<i>color</i> or <i>c</i>	any matplotlib color
<i>contains</i>	a callable function
<i>dash_capstyle</i>	['butt' 'round' 'projecting']
<i>dash_joinstyle</i>	['miter' 'round' 'bevel']
<i>dashes</i>	sequence of on/off ink in points
<i>drawstyle</i>	['default' 'steps' 'steps-pre' 'steps-mid' 'steps-post']
<i>figure</i>	a <i>matplotlib.figure.Figure</i> instance

Table 19.22 – continued from previous page

Property	Description
<i>fillstyle</i>	['full' 'left' 'right' 'bottom' 'top' 'none']
<i>gid</i>	an id string
<i>label</i>	string or anything printable with '%s' conversion.
<i>linestyle</i> or <i>ls</i>	['solid' 'dashed', 'dashdot', 'dotted' (offset, on-off-dash-seq) '- ' '-- ' '-. ' ' ']
<i>linewidth</i> or <i>lw</i>	float value in points
<i>marker</i>	<i>A valid marker style</i>
<i>markeredgecolor</i> or <i>mec</i>	any matplotlib color
<i>markeredgewidth</i> or <i>mew</i>	float value in points
<i>markerfacecolor</i> or <i>mfc</i>	any matplotlib color
<i>markerfacecoloralt</i> or <i>mfcalt</i>	any matplotlib color
<i>markersize</i> or <i>ms</i>	float
<i>markevery</i>	[None int length-2 tuple of int slice list/array of int float length-2 tuple of float]
<i>path_effects</i>	unknown
<i>picker</i>	float distance in points or callable pick function <code>fn(artist, event)</code>
<i>pickradius</i>	float distance in points
<i>rasterized</i>	[True False None]
<i>sketch_params</i>	unknown
<i>snap</i>	unknown
<i>solid_capstyle</i>	['butt' 'round' 'projecting']
<i>solid_joinstyle</i>	['miter' 'round' 'bevel']
<i>transform</i>	a <i>matplotlib.transforms.Transform</i> instance
<i>url</i>	a url string
<i>visible</i>	[True False]
<i>xdata</i>	1D array
<i>ydata</i>	1D array
<i>zorder</i>	any number

Returns spectrum : 1-D array

The values for the phase spectrum in radians (real valued)

freqs : 1-D array

The frequencies corresponding to the elements in *spectrum*

line : a *Line2D* instance

The line created by this function

See also:

magnitude_spectrum() *magnitude_spectrum()* plots the magnitudes of the corresponding frequencies.

angle_spectrum() *angle_spectrum()* plots the wrapped version of this function.

specgram() *specgram()* can plot the phase spectrum of segments within the signal in a colormap.

In addition to the above described arguments, this function can take a **data** keyword argument. If such a **data** argument is given, the following arguments are replaced by **data[<arg>]**: * All arguments with the following names: 'x'.

Examples

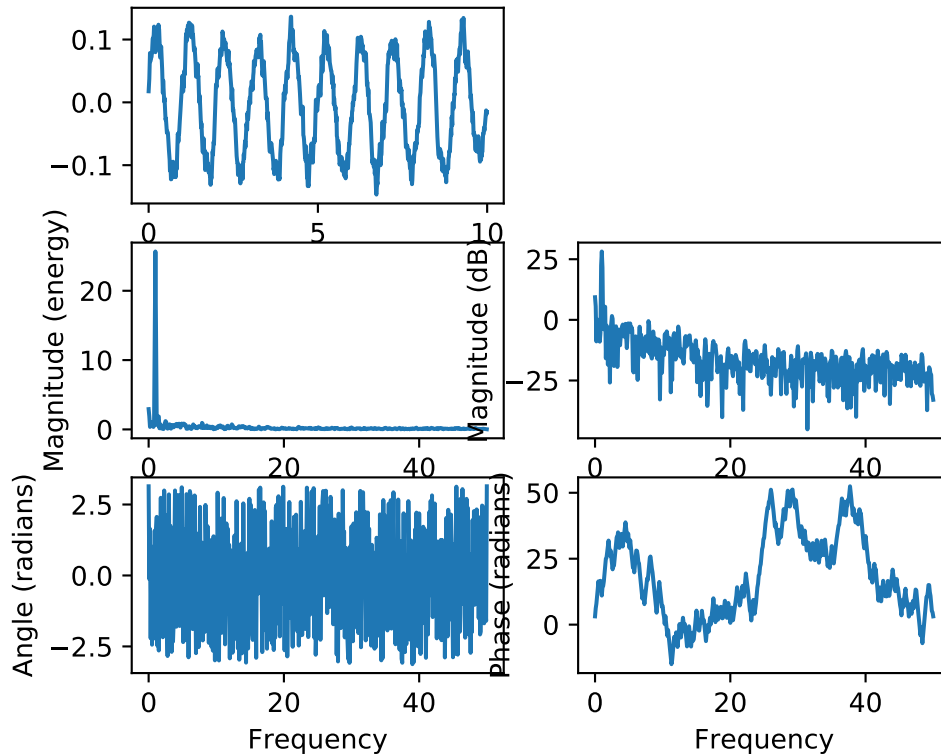

matplotlib.axes.Axes.psd

`Axes.psd(x, NFFT=None, Fs=None, Fc=None, detrend=None, window=None, noverlap=None, pad_to=None, sides=None, scale_by_freq=None, return_line=None, **kwargs)`
Plot the power spectral density.

Call signature:

```
psd(x, NFFT=256, Fs=2, Fc=0, detrend=mlab.detrend_none,
    window=mlab.window_hanning, noverlap=0, pad_to=None,
    sides='default', scale_by_freq=None, return_line=None, **kwargs)
```

The power spectral density P_{xx} by Welch's average periodogram method. The vector x is divided into $NFFT$ length segments. Each segment is detrended by function *detrend* and windowed by function *window*. *noverlap* gives the length of the overlap between segments. The $|fft(i)|^2$ of each segment i are averaged to compute P_{xx} , with a scaling to correct for power loss due to windowing.

If $\text{len}(x) < NFFT$, it will be zero padded to $NFFT$.

Parameters x : 1-D array or sequence

Array or sequence containing the data

Fs : scalar

The sampling frequency (samples per time unit). It is used to calculate the Fourier frequencies, `freqs`, in cycles per time unit. The default value is 2.

window : callable or ndarray

A function or a vector of length $NFFT$. To create window vectors see `window_hanning()`, `window_none()`, `numpy.blackman()`, `numpy.hamming()`, `numpy.bartlett()`, `scipy.signal()`, `scipy.signal.get_window()`, etc. The default is `window_hanning()`. If a function is passed as the argument, it must take a data segment as an argument and return the windowed version of the segment.

sides : ['default' | 'onesided' | 'twosided']

Specifies which sides of the spectrum to return. Default gives the default behavior, which returns one-sided for real data and both for complex data. 'onesided' forces the return of a one-sided spectrum, while 'twosided' forces two-sided.

pad_to : integer

The number of points to which the data segment is padded when performing the FFT. This can be different from $NFFT$, which specifies the number of data points used. While not increasing the actual resolution of the spectrum (the minimum distance between resolvable peaks), this can give more points in the plot, allowing for more detail. This corresponds to the n parameter in the call to `fft()`. The default is `None`, which sets `pad_to` equal to $NFFT$

NFFT : integer

The number of data points used in each block for the FFT. A power 2 is most efficient. The default value is 256. This should *NOT* be used to get zero padding, or the scaling of the result will be incorrect. Use `pad_to` for this instead.

detrend : { 'default', 'constant', 'mean', 'linear', 'none' } or callable

The function applied to each segment before `fft`-ing, designed to remove the mean or linear trend. Unlike in MATLAB, where the `detrend` parameter is a vector, in matplotlib it is a function. The `pylab` module defines `detrend_none()`, `detrend_mean()`, and `detrend_linear()`, but you can use a custom function as well. You can also use a string to choose one of the functions. 'default', 'constant', and 'mean' call `detrend_mean()`. 'linear' calls `detrend_linear()`. 'none' calls `detrend_none()`.

scale_by_freq : boolean, optional

Specifies whether the resulting density values should be scaled by the scaling frequency, which gives density in units of Hz⁻¹. This allows for integration over the returned frequency values. The default is True for MATLAB compatibility.

noverlap : integer

The number of points of overlap between segments. The default value is 0 (no overlap).

Fc : integer

The center frequency of x (defaults to 0), which offsets the x extents of the plot to reflect the frequency range used when a signal is acquired and then filtered and downsampled to baseband.

return_line : bool

Whether to include the line object plotted in the returned values. Default is False.

****kwargs** :

Keyword arguments control the *Line2D* properties:

Property	Description
<i>agg_filter</i>	unknown
<i>alpha</i>	float (0.0 transparent through 1.0 opaque)
<i>animated</i>	[True False]
<i>antialiased</i> or <i>aa</i>	[True False]
<i>axes</i>	an <i>Axes</i> instance
<i>clip_box</i>	a <i>matplotlib.transforms.Bbox</i> instance
<i>clip_on</i>	[True False]
<i>clip_path</i>	[(<i>Path</i> , <i>Transform</i>) <i>Patch</i> None]
<i>color</i> or <i>c</i>	any matplotlib color
<i>contains</i>	a callable function
<i>dash_capstyle</i>	['butt' 'round' 'projecting']
<i>dash_joinstyle</i>	['miter' 'round' 'bevel']
<i>dashes</i>	sequence of on/off ink in points
<i>drawstyle</i>	['default' 'steps' 'steps-pre' 'steps-mid' 'steps-post']
<i>figure</i>	a <i>matplotlib.figure.Figure</i> instance
<i>fillstyle</i>	['full' 'left' 'right' 'bottom' 'top' 'none']
<i>gid</i>	an id string
<i>label</i>	string or anything printable with '%s' conversion.
<i>linestyle</i> or <i>ls</i>	['solid' 'dashed', 'dashdot', 'dotted' (offset, on-off-dash-seq) '-' '--' '-.' ' ']
<i>linewidth</i> or <i>lw</i>	float value in points
<i>marker</i>	<i>A valid marker style</i>
<i>markeredgecolor</i> or <i>mec</i>	any matplotlib color
<i>markeredgewidth</i> or <i>mew</i>	float value in points
<i>markerfacecolor</i> or <i>mfc</i>	any matplotlib color

Table 19.23 – continued from previous page

Property	Description
<i>markerfacecoloralt</i> or <i>mfcalt</i>	any matplotlib color
<i>markersize</i> or <i>ms</i>	float
<i>markevery</i>	[None int length-2 tuple of int slice list/array of int float length-2 tuple of float]
<i>path_effects</i>	unknown
<i>picker</i>	float distance in points or callable pick function <code>fn(artist, event)</code>
<i>pickradius</i>	float distance in points
<i>rasterized</i>	[True False None]
<i>sketch_params</i>	unknown
<i>snap</i>	unknown
<i>solid_capstyle</i>	['butt' 'round' 'projecting']
<i>solid_joinstyle</i>	['miter' 'round' 'bevel']
<i>transform</i>	a <code>matplotlib.transforms.Transform</code> instance
<i>url</i>	a url string
<i>visible</i>	[True False]
<i>xdata</i>	1D array
<i>ydata</i>	1D array
<i>zorder</i>	any number

Returns P_{xx} : 1-D array

The values for the power spectrum $P_{\{xx\}}$ before scaling (real valued)

freqs : 1-D array

The frequencies corresponding to the elements in P_{xx}

line : a `Line2D` instance

The line created by this function. Only returned if `return_line` is True.

See also:

`specgram()` `specgram()` differs in the default overlap; in not returning the mean of the segment periodograms; in returning the times of the segments; and in plotting a colormap instead of a line.

`magnitude_spectrum()` `magnitude_spectrum()` plots the magnitude spectrum.

`csd()` `csd()` plots the spectral density between two signals.

In addition to the above described arguments, this function can take a **data** keyword argument. If such a **data** argument is given, the following arguments are replaced by **data[<arg>]**: * All arguments with the following names: 'x'.

Notes

For plotting, the power is plotted as $10 \log_{10}(P_{xx})$ for decibels, though P_{xx} itself is returned.

References

Bendat & Piersol – Random Data: Analysis and Measurement Procedures, John Wiley & Sons (1986)

Examples

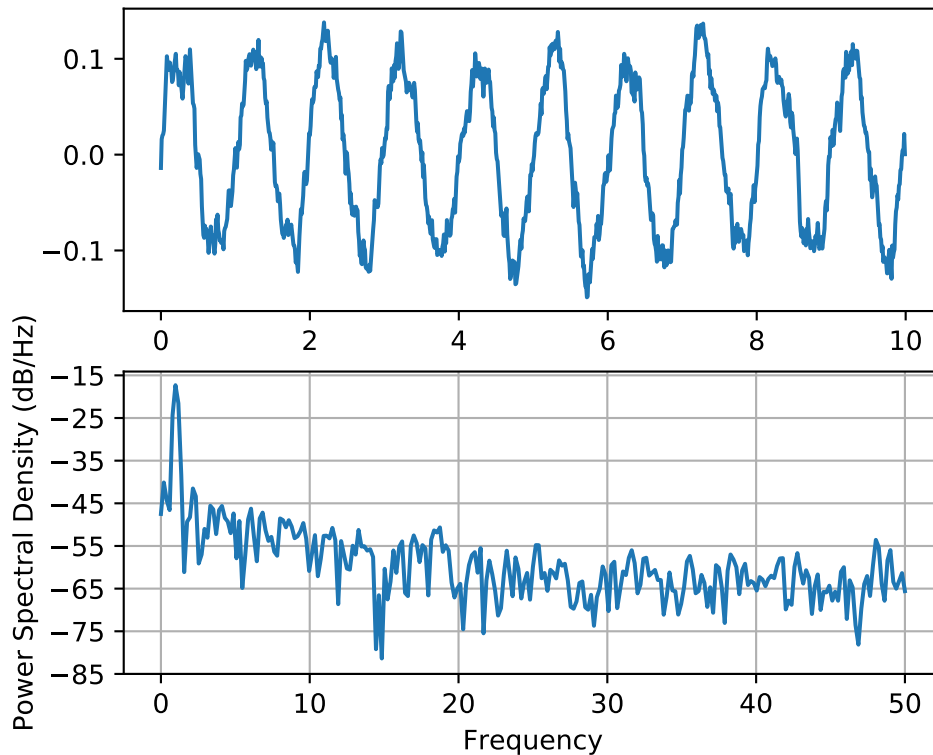

matplotlib.axes.Axes.specgram

`Axes.specgram(x, NFFT=None, Fs=None, Fc=None, detrend=None, window=None, noverlap=None, cmap=None, xextent=None, pad_to=None, sides=None, scale_by_freq=None, mode=None, scale=None, vmin=None, vmax=None, **kwargs)`

Plot a spectrogram.

Call signature:

```
specgram(x, NFFT=256, Fs=2, Fc=0, detrend=mlab.detrend_none,
         window=mlab.window_hanning, noverlap=128,
         cmap=None, xextent=None, pad_to=None, sides='default',
         scale_by_freq=None, mode='default', scale='default',
         **kwargs)
```

Compute and plot a spectrogram of data in x . Data are split into $NFFT$ length segments and the spectrum of each section is computed. The windowing function $window$ is applied to each segment, and the amount of overlap of each segment is specified with $noverlap$. The spectrogram is plotted as a colormap (using `imshow`).

Parameters x : 1-D array or sequence

Array or sequence containing the data.

Fs : scalar

The sampling frequency (samples per time unit). It is used to calculate the Fourier frequencies, `freqs`, in cycles per time unit. The default value is 2.

window : callable or ndarray

A function or a vector of length $NFFT$. To create window vectors see `window_hanning()`, `window_none()`, `numpy.blackman()`, `numpy.hamming()`, `numpy.bartlett()`, `scipy.signal()`, `scipy.signal.get_window()`, etc. The default is `window_hanning()`. If a function is passed as the argument, it must take a data segment as an argument and return the windowed version of the segment.

sides : ['default' | 'onesided' | 'twosided']

Specifies which sides of the spectrum to return. Default gives the default behavior, which returns one-sided for real data and both for complex data. 'onesided' forces the return of a one-sided spectrum, while 'twosided' forces two-sided.

pad_to : integer

The number of points to which the data segment is padded when performing the FFT. This can be different from $NFFT$, which specifies the number of data points used. While not increasing the actual resolution of the spectrum (the minimum distance between resolvable peaks), this can give more points in the plot, allowing for more detail. This corresponds to the n parameter in the call to `fft()`. The default is `None`, which sets `pad_to` equal to $NFFT$.

NFFT : integer

The number of data points used in each block for the FFT. A power 2 is most efficient. The default value is 256. This should *NOT* be used to get zero padding, or the scaling of the result will be incorrect. Use `pad_to` for this instead.

detrend : { 'default', 'constant', 'mean', 'linear', 'none' } or callable

The function applied to each segment before `fft`-ing, designed to remove the mean or linear trend. Unlike in MATLAB, where the `detrend` parameter is a vector, in matplotlib it is a function. The `pylab` module defines `detrend_none()`, `detrend_mean()`, and `detrend_linear()`, but you can use a custom function as well. You can also use a string to choose one of the functions. 'default', 'constant', and 'mean' call `detrend_mean()`. 'linear' calls `detrend_linear()`. 'none' calls `detrend_none()`.

scale_by_freq : boolean, optional

Specifies whether the resulting density values should be scaled by the scaling frequency, which gives density in units of Hz^{-1} . This allows for integration over the returned frequency values. The default is True for MATLAB compatibility.

mode : ['default' | 'psd' | 'magnitude' | 'angle' | 'phase']

What sort of spectrum to use. Default is 'psd', which takes the power spectral density. 'complex' returns the complex-valued frequency spectrum. 'magnitude' returns the magnitude spectrum. 'angle' returns the phase spectrum without unwrapping. 'phase' returns the phase spectrum with unwrapping.

noverlap : integer

The number of points of overlap between blocks. The default value is 128.

scale : ['default' | 'linear' | 'dB']

The scaling of the values in the *spec*. 'linear' is no scaling. 'dB' returns the values in dB scale. When *mode* is 'psd', this is dB power ($10 * \log_{10}$). Otherwise this is dB amplitude ($20 * \log_{10}$). 'default' is 'dB' if *mode* is 'psd' or 'magnitude' and 'linear' otherwise. This must be 'linear' if *mode* is 'angle' or 'phase'.

Fc : integer

The center frequency of *x* (defaults to 0), which offsets the x extents of the plot to reflect the frequency range used when a signal is acquired and then filtered and downsampled to baseband.

cmap :

A `matplotlib.colors.Colormap` instance; if *None*, use default determined by rc

xextent : [None | (xmin, xmax)]

The image extent along the x-axis. The default sets *xmin* to the left border of the first bin (*spectrum* column) and *xmax* to the right border of the last bin. Note that for *noverlap* > 0 the width of the bins is smaller than those of the segments.

****kwargs** :

Additional kwargs are passed on to `imshow` which makes the spectrogram image

Returns spectrum : 2-D array

Columns are the periodograms of successive segments.

freqs : 1-D array

The frequencies corresponding to the rows in *spectrum*.

t : 1-D array

The times corresponding to midpoints of segments (i.e., the columns in *spectrum*).

im : instance of class *AxesImage*

The image created by `imshow` containing the spectrogram

See also:

psd() *psd()* differs in the default overlap; in returning the mean of the segment periodograms; in not returning times; and in generating a line plot instead of colormap.

magnitude_spectrum() A single spectrum, similar to having a single segment when *mode* is 'magnitude'. Plots a line instead of a colormap.

angle_spectrum() A single spectrum, similar to having a single segment when *mode* is 'angle'. Plots a line instead of a colormap.

phase_spectrum() A single spectrum, similar to having a single segment when *mode* is 'phase'. Plots a line instead of a colormap.

In addition to the above described arguments, this function can take a **data** keyword argument. If such a **data** argument is given, the following arguments are replaced by **data[<arg>]**: * All arguments with the following names: 'x'.

Notes

detrend and *scale_by_freq* only apply when *mode* is set to 'psd'

Examples

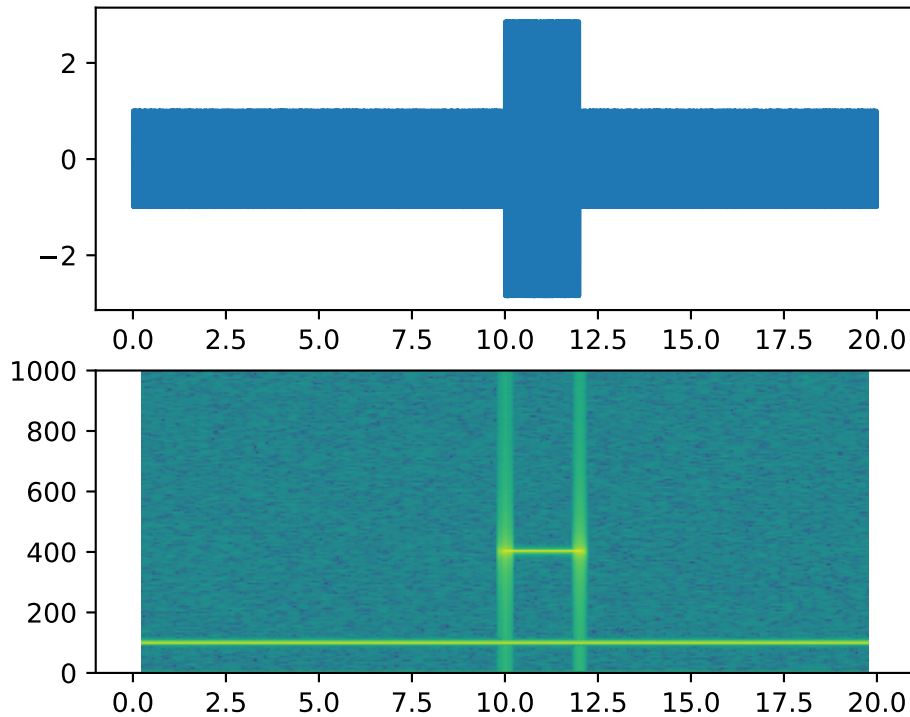
**matplotlib.axes.Axes.xcorr**

Axes.xcorr(*x*, *y*, *normed*=True, *detrend*=<function detrend_none>, *usevlines*=True, *maxlags*=10, ***kwargs*)

Plot the cross correlation between *x* and *y*.

The correlation with lag *k* is defined as $\sum_n x[n+k] * \text{conj}(y[n])$.

Parameters x : sequence of scalars of length *n*

y : sequence of scalars of length *n*

hold : boolean, optional, *deprecated*, default: True

detrend : callable, optional, default: `mlab.detrend_none`

x is detrended by the `detrend` callable. Default is no normalization.

normed : boolean, optional, default: True

if True, input vectors are normalised to unit length.

usevlines : boolean, optional, default: True

if True, `Axes.vlines` is used to plot the vertical lines from the origin to the `acorr`. Otherwise, `Axes.plot` is used.

maxlags : integer, optional, default: 10

number of lags to show. If None, will return all $2 * \text{len}(x) - 1$ lags.

Returns (lags, c, line, b) : where:

- lags are a length $2 * \text{maxlags} + 1$ lag vector.
- c is the $2 * \text{maxlags} + 1$ auto correlation vector
- line is a `Line2D` instance returned by `plot`.
- b is the x-axis (none, if plot is used).

Other Parameters linestyle : `Line2D` prop, optional, default: None

Only used if `usevlines` is False.

marker : string, optional, default: 'o'

Notes

The cross correlation is performed with `numpy.correlate()` with `mode = 2`.

Note: In addition to the above described arguments, this function can take a **data** keyword argument. If such a **data** argument is given, the following arguments are replaced by **data[<arg>]**:

- All arguments with the following names: 'x', 'y'.
-

19.1.4 Statistics

<code>Axes.boxplot</code>	Make a box and whisker plot.
<code>Axes.violinplot</code>	Make a violin plot.
<code>Axes.violin</code>	Drawing function for violin plots.
<code>Axes.bxp</code>	Drawing function for box and whisker plots.

matplotlib.axes.Axes.boxplot

`Axes.boxplot`(*x*, *notch=None*, *sym=None*, *vert=None*, *whis=None*, *positions=None*, *widths=None*, *patch_artist=None*, *bootstrap=None*, *usermedians=None*, *conf_intervals=None*, *meanline=None*, *showmeans=None*, *showcaps=None*, *showbox=None*, *showfliers=None*, *boxprops=None*, *labels=None*, *flierprops=None*, *medianprops=None*, *meanprops=None*, *capprops=None*, *whiskerprops=None*, *manage_xticks=True*, *autorange=False*, *zorder=None*)

Make a box and whisker plot.

Make a box and whisker plot for each column of **x** or each vector in sequence **x**. The box extends

from the lower to upper quartile values of the data, with a line at the median. The whiskers extend from the box to show the range of the data. Flier points are those past the end of the whiskers.

Parameters x : Array or a sequence of vectors.

The input data.

notch : bool, optional (False)

If `True`, will produce a notched box plot. Otherwise, a rectangular boxplot is produced. The notches represent the confidence interval (CI) around the median. See the entry for the `bootstrap` parameter for information regarding how the locations of the notches are computed.

Note: In cases where the values of the CI are less than the lower quartile or greater than the upper quartile, the notches will extend beyond the box, giving it a distinctive “flipped” appearance. This is expected behavior and consistent with other statistical visualization packages.

sym : str, optional

The default symbol for flier points. Enter an empty string (‘’) if you don’t want to show fliers. If `None`, then the fliers default to ‘b+’ If you want more control use the `flierprops` kwarg.

vert : bool, optional (True)

If `True` (default), makes the boxes vertical. If `False`, everything is drawn horizontally.

whis : float, sequence, or string (default = 1.5)

As a float, determines the reach of the whiskers to the beyond the first and third quartiles. In other words, where IQR is the interquartile range ($Q3 - Q1$), the upper whisker will extend to last datum less than $Q3 + whis * IQR$. Similarly, the lower whisker will extend to the first datum greater than $Q1 - whis * IQR$. Beyond the whiskers, data are considered outliers and are plotted as individual points. Set this to an unreasonably high value to force the whiskers to show the min and max values. Alternatively, set this to an ascending sequence of percentile (e.g., [5, 95]) to set the whiskers at specific percentiles of the data. Finally, `whis` can be the string ‘range’ to force the whiskers to the min and max of the data.

bootstrap : int, optional

Specifies whether to bootstrap the confidence intervals around the median for notched boxplots. If `bootstrap` is `None`, no bootstrapping is performed, and notches are calculated using a Gaussian-based asymptotic approximation (see McGill, R., Tukey, J.W., and Larsen, W.A., 1978, and Kendall and Stuart, 1967). Otherwise, `bootstrap` specifies the number of times to bootstrap the median to determine its 95% confidence intervals. Values between 1000 and 10000 are recommended.

usermedians : array-like, optional

An array or sequence whose first dimension (or length) is compatible with `x`. This overrides the medians computed by matplotlib for each element of `usermedians` that is not `None`. When an element of `usermedians` is `None`, the median will be computed by matplotlib as normal.

conf_intervals : array-like, optional

Array or sequence whose first dimension (or length) is compatible with `x` and whose second dimension is 2. When the an element of `conf_intervals` is not `None`, the notch locations computed by matplotlib are overridden (provided `notch` is `True`). When an element of `conf_intervals` is `None`, the notches are computed by the method specified by the other kwargs (e.g., `bootstrap`).

positions : array-like, optional

Sets the positions of the boxes. The ticks and limits are automatically set to match the positions. Defaults to `range(1, N+1)` where `N` is the number of boxes to be drawn.

widths : scalar or array-like

Sets the width of each box either with a scalar or a sequence. The default is 0.5, or $0.15 * (\text{distance between extreme positions})$, if that is smaller.

patch_artist : bool, optional (False)

If `False` produces boxes with the `Line2D` artist. Otherwise, boxes and drawn with `Patch` artists.

labels : sequence, optional

Labels for each dataset. Length must be compatible with dimensions of `x`.

manage_xticks : bool, optional (True)

If the function should adjust the `xlim` and `xtick` locations.

autorange : bool, optional (False)

When `True` and the data are distributed such that the 25th and 75th percentiles are equal, `whis` is set to `'range'` such that the whisker ends are at the minimum and maximum of the data.

meanline : bool, optional (False)

If `True` (and `showmeans` is `True`), will try to render the mean as a line spanning the full width of the box according to `meanprops` (see below). Not recommended if `shownotches` is also `True`. Otherwise, means will be shown as points.

zorder : scalar, optional (None)

Sets the `zorder` of the boxplot.

Returns result : dict

A dictionary mapping each component of the boxplot to a list of the `matplotlib.lines.Line2D` instances created. That dictionary has the following keys (assuming vertical boxplots):

- **boxes**: the main body of the boxplot showing the quartiles and the median's confidence intervals if enabled.
- **medians**: horizontal lines at the median of each box.
- **whiskers**: the vertical lines extending to the most extreme, non-outlier data points.
- **caps**: the horizontal lines at the ends of the whiskers.
- **fliers**: points representing data that extend beyond the whiskers (fliers).
- **means**: points or lines representing the means.

Other Parameters **showcaps** : bool, optional (True)

Show the caps on the ends of whiskers.

showbox : bool, optional (True)

Show the central box.

showfliers : bool, optional (True)

Show the outliers beyond the caps.

showmeans : bool, optional (False)

Show the arithmetic means.

capprops : dict, optional (None)

Specifies the style of the caps.

boxprops : dict, optional (None)

Specifies the style of the box.

whiskerprops : dict, optional (None)

Specifies the style of the whiskers.

flierprops : dict, optional (None)

Specifies the style of the fliers.

medianprops : dict, optional (None)

Specifies the style of the median.

meanprops : dict, optional (None)

Specifies the style of the mean.

Examples

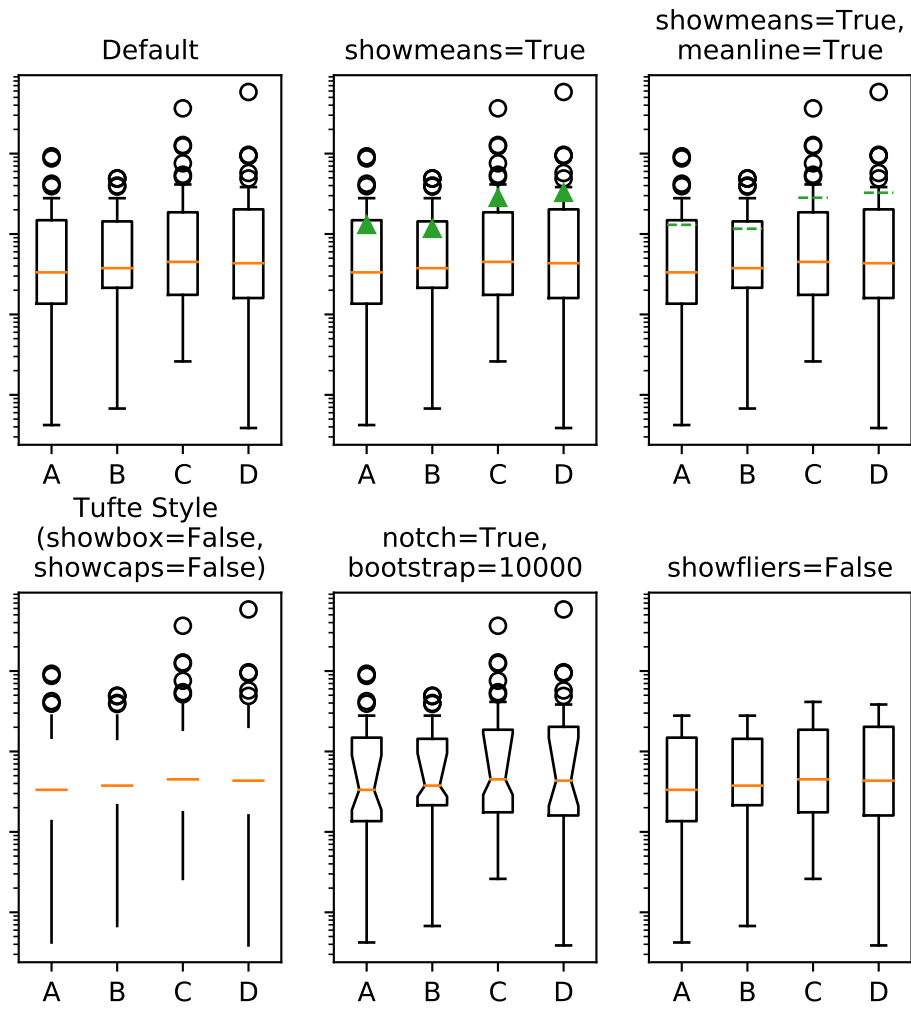

I never said they'd be pretty

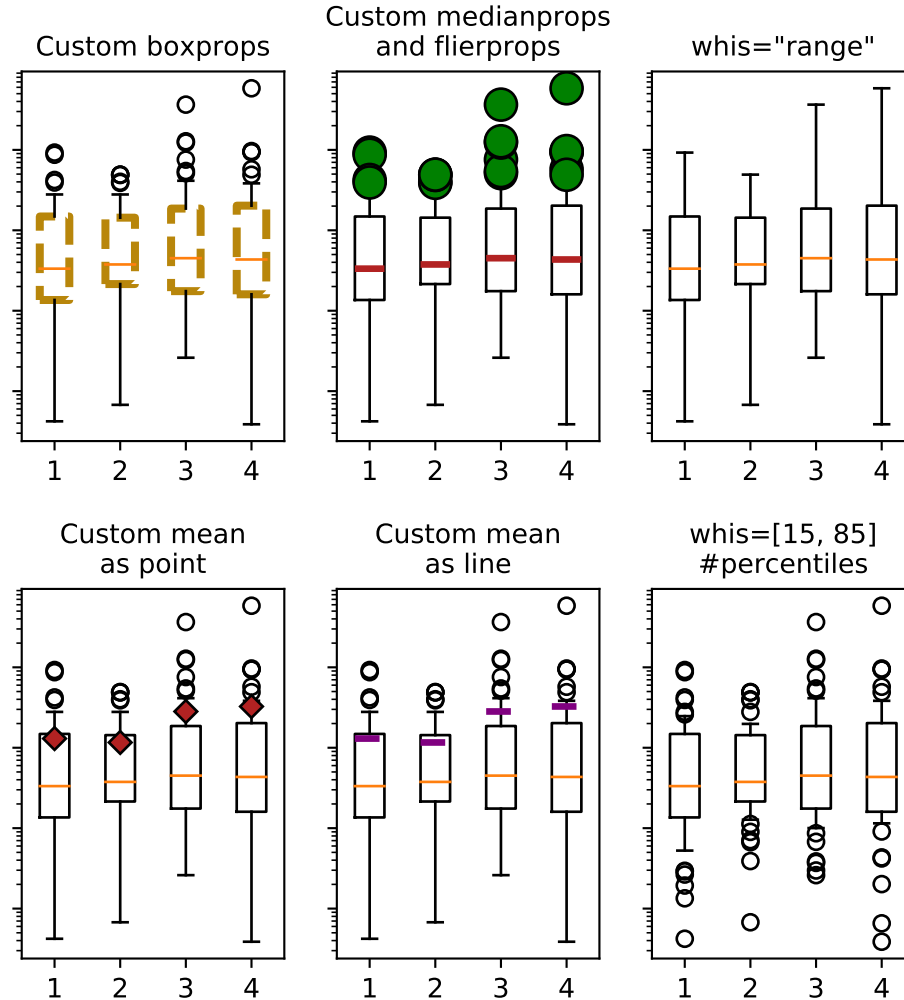

Note: In addition to the above described arguments, this function can take a **data** keyword argument. If such a **data** argument is given, the following arguments are replaced by **data[<arg>]**:

- All positional and all keyword arguments.
-

matplotlib.axes.Axes.violinplot

`Axes.violinplot(dataset, positions=None, vert=True, widths=0.5, showmeans=False, showextrema=True, showmedians=False, points=100, bw_method=None)`

Make a violin plot.

Make a violin plot for each column of *dataset* or each vector in sequence *dataset*. Each filled area extends to represent the entire data range, with optional lines at the mean, the median, the minimum, and the maximum.

Parameters dataset : Array or a sequence of vectors.

The input data.

positions : array-like, default = [1, 2, ..., n]

Sets the positions of the violins. The ticks and limits are automatically set to match the positions.

vert : bool, default = True.

If true, creates a vertical violin plot. Otherwise, creates a horizontal violin plot.

widths : array-like, default = 0.5

Either a scalar or a vector that sets the maximal width of each violin. The default is 0.5, which uses about half of the available horizontal space.

showmeans : bool, default = False

If True, will toggle rendering of the means.

showextrema : bool, default = True

If True, will toggle rendering of the extrema.

showmedians : bool, default = False

If True, will toggle rendering of the medians.

points : scalar, default = 100

Defines the number of points to evaluate each of the gaussian kernel density estimations at.

bw_method : str, scalar or callable, optional

The method used to calculate the estimator bandwidth. This can be 'scott', 'silverman', a scalar constant or a callable. If a scalar, this will be used directly as `kde.factor`. If a callable, it should take a `GaussianKDE` instance as its only parameter and return a scalar. If None (default), 'scott' is used.

Returns result : dict

A dictionary mapping each component of the violinplot to a list of the corresponding collection instances created. The dictionary has the following keys:

- **bodies**: A list of the `matplotlib.collections.PolyCollection` instances containing the filled area of each violin.
- **cmeans**: A `matplotlib.collections.LineCollection` instance created to identify the mean values of each of the violin's distribution.
- **cmims**: A `matplotlib.collections.LineCollection` instance created to identify the bottom of each violin's distribution.
- **cmaxes**: A `matplotlib.collections.LineCollection` instance created to identify the top of each violin's distribution.

- **cbars**: A `matplotlib.collections.LineCollection` instance created to identify the centers of each violin's distribution.
- **cmedians**: A `matplotlib.collections.LineCollection` instance created to identify the median values of each of the violin's distribution.

Note: In addition to the above described arguments, this function can take a **data** keyword argument. If such a **data** argument is given, the following arguments are replaced by **data[<arg>]**:

- All arguments with the following names: 'dataset'.
-

matplotlib.axes.Axes.violin

Axes.violin(*vpstats*, *positions=None*, *vert=True*, *widths=0.5*, *showmeans=False*, *showextrema=True*, *showmedians=False*)

Drawing function for violin plots.

Draw a violin plot for each column of *vpstats*. Each filled area extends to represent the entire data range, with optional lines at the mean, the median, the minimum, and the maximum.

Parameters vpstats : list of dicts

A list of dictionaries containing stats for each violin plot. Required keys are:

- **coords**: A list of scalars containing the coordinates that the violin's kernel density estimate were evaluated at.
- **vals**: A list of scalars containing the values of the kernel density estimate at each of the coordinates given in *coords*.
- **mean**: The mean value for this violin's dataset.
- **median**: The median value for this violin's dataset.
- **min**: The minimum value for this violin's dataset.
- **max**: The maximum value for this violin's dataset.

positions : array-like, default = [1, 2, ..., n]

Sets the positions of the violins. The ticks and limits are automatically set to match the positions.

vert : bool, default = True.

If true, plots the violins vertically. Otherwise, plots the violins horizontally.

widths : array-like, default = 0.5

Either a scalar or a vector that sets the maximal width of each violin. The default is 0.5, which uses about half of the available horizontal space.

showmeans : bool, default = False

If true, will toggle rendering of the means.

showextrema : bool, default = True

If true, will toggle rendering of the extrema.

showmedians : bool, default = False

If true, will toggle rendering of the medians.

Returns result : dict

A dictionary mapping each component of the violinplot to a list of the corresponding collection instances created. The dictionary has the following keys:

- **bodies**: A list of the `matplotlib.collections.PolyCollection` instances containing the filled area of each violin.
- **cmeans**: A `matplotlib.collections.LineCollection` instance created to identify the mean values of each of the violin's distribution.
- **cmins**: A `matplotlib.collections.LineCollection` instance created to identify the bottom of each violin's distribution.
- **cmaxes**: A `matplotlib.collections.LineCollection` instance created to identify the top of each violin's distribution.
- **cbars**: A `matplotlib.collections.LineCollection` instance created to identify the centers of each violin's distribution.
- **cmedians**: A `matplotlib.collections.LineCollection` instance created to identify the median values of each of the violin's distribution.

matplotlib.axes.Axes.bxp

Axes.bxp(*bxpstats*, *positions=None*, *widths=None*, *vert=True*, *patch_artist=False*, *shownotches=False*, *showmeans=False*, *showcaps=True*, *showbox=True*, *showfliers=True*, *boxprops=None*, *whiskerprops=None*, *flierprops=None*, *medianprops=None*, *capprops=None*, *meanprops=None*, *meanline=False*, *manage_xticks=True*, *zorder=None*)

Drawing function for box and whisker plots.

Make a box and whisker plot for each column of *x* or each vector in sequence *x*. The box extends from the lower to upper quartile values of the data, with a line at the median. The whiskers extend from the box to show the range of the data. Flier points are those past the end of the whiskers.

Parameters bxpstats : list of dicts

A list of dictionaries containing stats for each boxplot. Required keys are:

- **med**: The median (scalar float).
- **q1**: The first quartile (25th percentile) (scalar float).
- **q3**: The third quartile (75th percentile) (scalar float).
- **whislo**: Lower bound of the lower whisker (scalar float).

- **whishi**: Upper bound of the upper whisker (scalar float).

Optional keys are:

- **mean**: The mean (scalar float). Needed if `showmeans=True`.
- **fliers**: Data beyond the whiskers (sequence of floats). Needed if `showfliers=True`.
- **cilo & cihi**: Lower and upper confidence intervals about the median. Needed if `shownotches=True`.
- **label**: Name of the dataset (string). If available, this will be used a tick label for the boxplot

positions : array-like, default = [1, 2, ..., n]

Sets the positions of the boxes. The ticks and limits are automatically set to match the positions.

widths : array-like, default = 0.5

Either a scalar or a vector and sets the width of each box. The default is 0.5, or $0.15 * (\text{distance between extreme positions})$ if that is smaller.

vert : bool, default = False

If True (default), makes the boxes vertical. If False, makes horizontal boxes.

patch_artist : bool, default = False

If False produces boxes with the *Line2D* artist. If True produces boxes with the *Patch* artist.

shownotches : bool, default = False

If False (default), produces a rectangular box plot. If True, will produce a notched box plot

showmeans : bool, default = False

If True, will toggle on the rendering of the means

showcaps : bool, default = True

If True, will toggle on the rendering of the caps

showbox : bool, default = True

If True, will toggle on the rendering of the box

showfliers : bool, default = True

If True, will toggle on the rendering of the fliers

boxprops : dict or None (default)

If provided, will set the plotting style of the boxes

whiskerprops : dict or None (default)

If provided, will set the plotting style of the whiskers

capprops : dict or None (default)

If provided, will set the plotting style of the caps

flierprops : dict or None (default)

If provided will set the plotting style of the fliers

medianprops : dict or None (default)

If provided, will set the plotting style of the medians

meanprops : dict or None (default)

If provided, will set the plotting style of the means

meanline : bool, default = False

If True (and *showmeans* is True), will try to render the mean as a line spanning the full width of the box according to *meanprops*. Not recommended if *shownotches* is also True. Otherwise, means will be shown as points.

manage_xticks : bool, default = True

If the function should adjust the xlim and xtick locations.

zorder : scalar, default = None

The zorder of the resulting boxplot

Returns result : dict

A dictionary mapping each component of the boxplot to a list of the *matplotlib.lines.Line2D* instances created. That dictionary has the following keys (assuming vertical boxplots):

- **boxes**: the main body of the boxplot showing the quartiles and the median's confidence intervals if enabled.
- **medians**: horizontal lines at the median of each box.
- **whiskers**: the vertical lines extending to the most extreme, non-outlier data points.
- **caps**: the horizontal lines at the ends of the whiskers.
- **fliers**: points representing data that extend beyond the whiskers (fliers).
- **means**: points or lines representing the means.

Examples

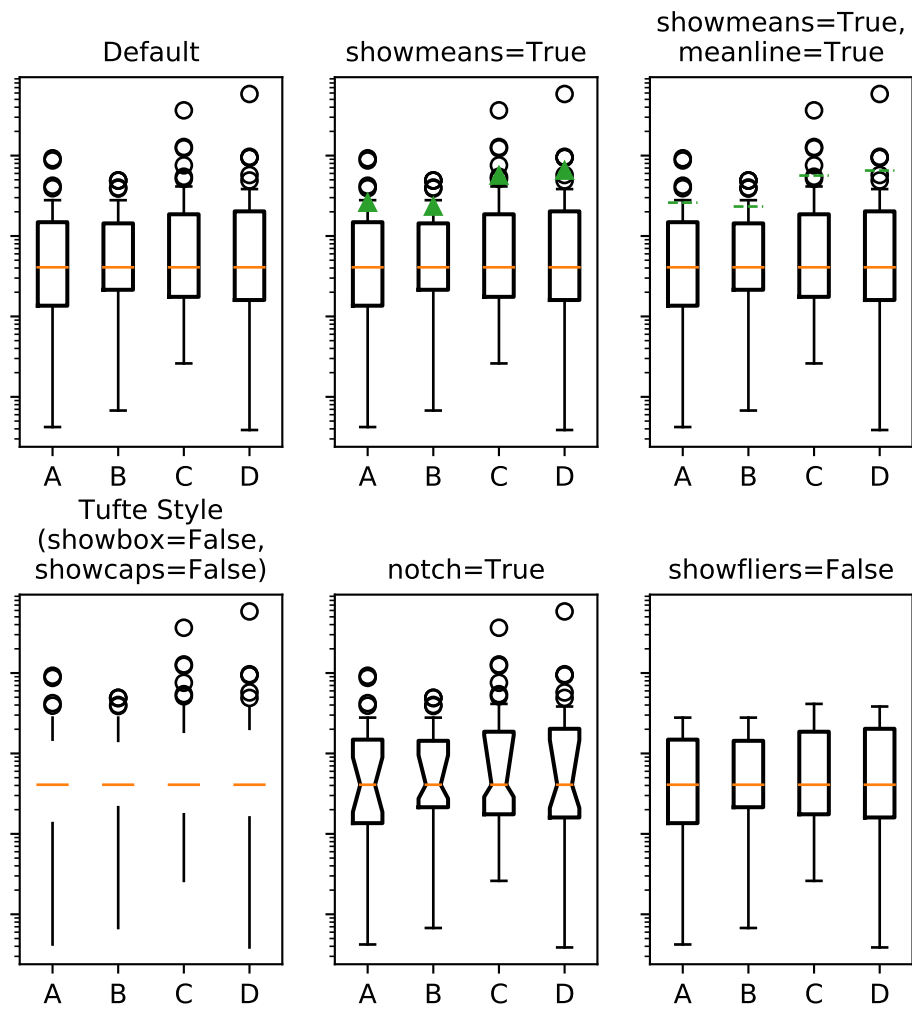

I never said they'd be pretty

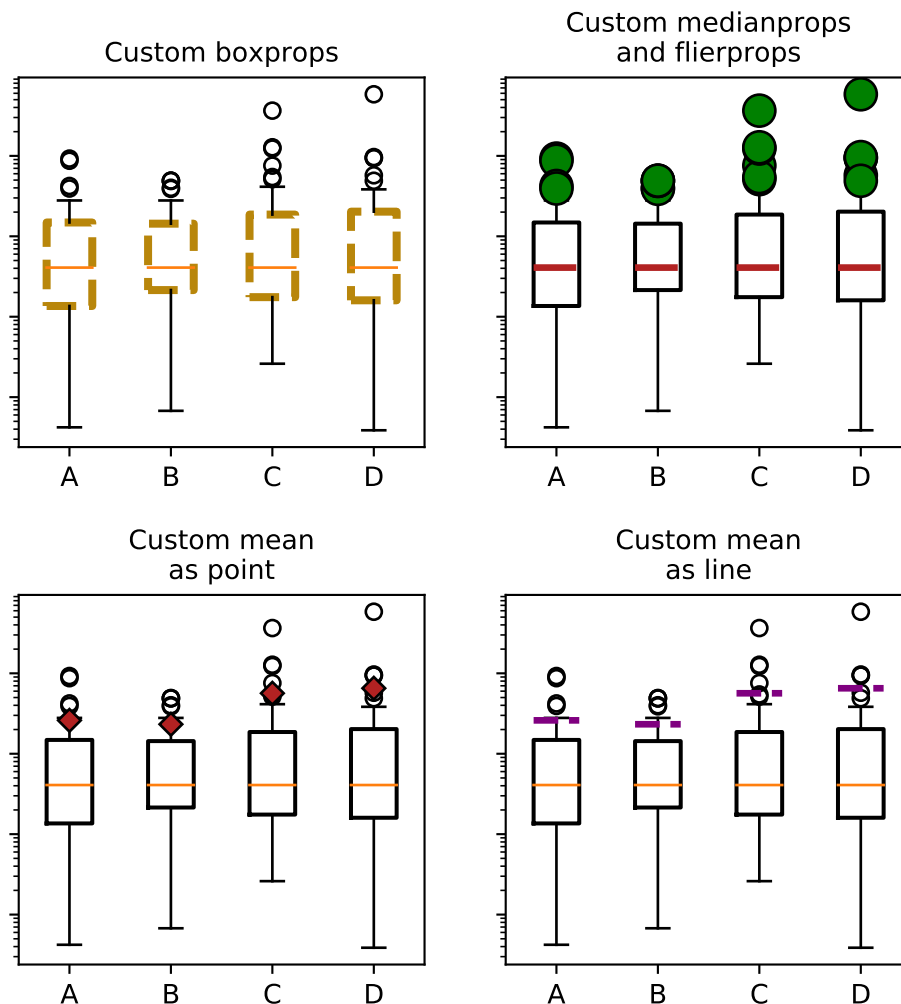

19.1.5 Binned

<code>Axes.hexbin</code>	Make a hexagonal binning plot.
<code>Axes.hist</code>	Plot a histogram.
<code>Axes.hist2d</code>	Make a 2D histogram plot.

matplotlib.axes.Axes.hexbin

`Axes.hexbin`(*x*, *y*, *C=None*, *gridsize=100*, *bins=None*, *xscale='linear'*, *yscale='linear'*, *extent=None*, *cmap=None*, *norm=None*, *vmin=None*, *vmax=None*, *alpha=None*, *linewidths=None*, *edgecolors='none'*, *reduce_C_function=<function mean>*, *mincnt=None*, *marginals=False*, ***kwargs*)

Make a hexagonal binning plot.

Make a hexagonal binning plot of x versus y , where x, y are 1-D sequences of the same length, N . If C is *None* (the default), this is a histogram of the number of occurrences of the observations at $(x[i], y[i])$.

If C is specified, it specifies values at the coordinate $(x[i], y[i])$. These values are accumulated for each hexagonal bin and then reduced according to *reduce_C_function*, which defaults to numpy's mean function (`np.mean`). (If C is specified, it must also be a 1-D sequence of the same length as x and y .)

Parameters x, y : array or masked array

C : array or masked array, optional, default is *None*

gridsize : int or (int, int), optional, default is 100

The number of hexagons in the x -direction, default is 100. The corresponding number of hexagons in the y -direction is chosen such that the hexagons are approximately regular. Alternatively, *gridsize* can be a tuple with two elements specifying the number of hexagons in the x -direction and the y -direction.

bins : { 'log' } or int or sequence, optional, default is *None*

If *None*, no binning is applied; the color of each hexagon directly corresponds to its count value.

If 'log', use a logarithmic scale for the color map. Internally, $\log_{10}(i + 1)$ is used to determine the hexagon color.

If an integer, divide the counts in the specified number of bins, and color the hexagons accordingly.

If a sequence of values, the values of the lower bound of the bins to be used.

xscale : { 'linear', 'log' }, optional, default is 'linear'

Use a linear or log10 scale on the horizontal axis.

yscale : { 'linear', 'log' }, optional, default is 'linear'

Use a linear or log10 scale on the vertical axis.

mincnt : int > 0, optional, default is *None*

If not *None*, only display cells with more than *mincnt* number of points in the cell

marginals : bool, optional, default is *False*

if *marginals* is *True*, plot the marginal density as colormapped rectangles along the bottom of the x -axis and left of the y -axis

extent : scalar, optional, default is *None*

The limits of the bins. The default assigns the limits based on *gridsize*, x , y , *xscale* and *yscale*.

If *xscale* or *yscale* is set to 'log', the limits are expected to be the exponent for a power of 10. E.g. for x -limits of 1 and 50 in 'linear' scale and y -limits of 10 and 1000 in 'log' scale, enter (1, 50, 1, 3).

Order of scalars is (left, right, bottom, top).

Returns object

a *PolyCollection* instance; use *get_array()* on this *PolyCollection* to get the counts in each hexagon.

If *marginals* is *True*, horizontal bar and vertical bar (both *PolyCollections*) will be attached to the return collection as attributes *hbar* and *vbar*.

Other Parameters *cmap* : object, optional, default is *None*

a *matplotlib.colors.Colormap* instance. If *None*, defaults to rc image. *cmap*.

norm : object, optional, default is *None*

matplotlib.colors.Normalize instance is used to scale luminance data to 0,1.

vmin*, *vmax : scalar, optional, default is *None*

vmin and *vmax* are used in conjunction with *norm* to normalize luminance data. If *None*, the min and max of the color array *C* are used. Note if you pass a norm instance your settings for *vmin* and *vmax* will be ignored.

alpha : scalar between 0 and 1, optional, default is *None*

the alpha value for the patches

linewidths : scalar, optional, default is *None*

If *None*, defaults to 1.0.

edgecolors : { 'none' } or mpl color, optional, default is 'none'

If 'none', draws the edges in the same color as the fill color. This is the default, as it avoids unsightly unpainted pixels between the hexagons.

If *None*, draws outlines in the default color.

If a matplotlib color arg, draws outlines in the specified color.

Notes

The standard descriptions of all the *Collection* parameters:

Property	Description
<i>agg_filter</i>	unknown
<i>alpha</i>	float or None
<i>animated</i>	[True False]
<i>antialiased</i> or <i>antialiaseds</i>	Boolean or sequence of booleans
<i>array</i>	unknown
<i>axes</i>	an <i>Axes</i> instance
<i>clim</i>	a length 2 sequence of floats

Table 19.26 – continued from previous page

Property	Description
<i>clip_box</i>	a <i>matplotlib.transforms.Bbox</i> instance
<i>clip_on</i>	[True False]
<i>clip_path</i>	[(<i>Path</i> , <i>Transform</i>) <i>Patch</i> None]
<i>cmap</i>	a colormap or registered colormap name
<i>color</i>	matplotlib color arg or sequence of rgba tuples
<i>contains</i>	a callable function
<i>edgecolor</i> or <i>edgecolors</i>	matplotlib color spec or sequence of specs
<i>facecolor</i> or <i>facecolors</i>	matplotlib color spec or sequence of specs
<i>figure</i>	a <i>matplotlib.figure.Figure</i> instance
<i>gid</i>	an id string
<i>hatch</i>	['/' '\' ' ' '-' '+' 'x' 'o' 'O' '.' '*']
<i>label</i>	string or anything printable with '%s' conversion.
<i>linestyle</i> or <i>dashes</i> or <i>linestyles</i>	['solid' 'dashed', 'dashdot', 'dotted' (offset, on-off-dash-seq) '-' '--' '-.' ...]
<i>linewidth</i> or <i>linewidths</i> or <i>lw</i>	float or sequence of floats
<i>norm</i>	unknown
<i>offset_position</i>	unknown
<i>offsets</i>	float or sequence of floats
<i>path_effects</i>	unknown
<i>picker</i>	[None float boolean callable]
<i>pickradius</i>	unknown
<i>rasterized</i>	[True False None]
<i>sketch_params</i>	unknown
<i>snap</i>	unknown
<i>transform</i>	<i>Transform</i> instance
<i>url</i>	a url string
<i>urls</i>	unknown
<i>visible</i>	[True False]
<i>zorder</i>	any number

Note: In addition to the above described arguments, this function can take a **data** keyword argument. If such a **data** argument is given, the following arguments are replaced by **data[<arg>]**:

- All arguments with the following names: 'x', 'y'.
-

Examples

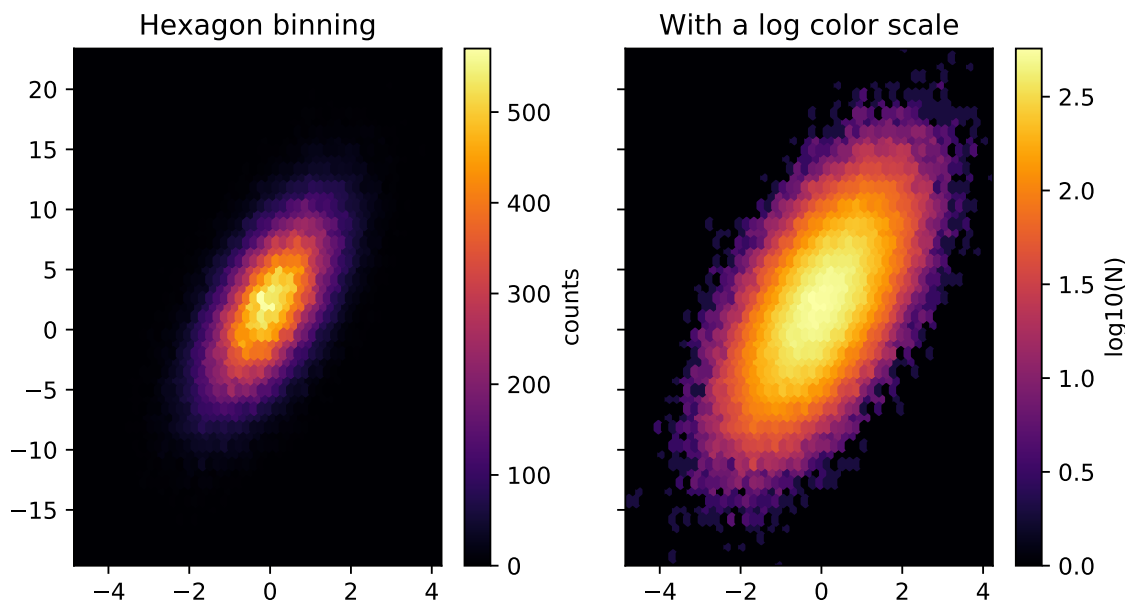
`matplotlib.axes.Axes.hist`

`Axes.hist`(*x*, *bins*=None, *range*=None, *normed*=False, *weights*=None, *cumulative*=False, *bottom*=None, *histtype*='bar', *align*='mid', *orientation*='vertical', *rwidth*=None, *log*=False, *color*=None, *label*=None, *stacked*=False, ***kwargs*)
 Plot a histogram.

Compute and draw the histogram of *x*. The return value is a tuple (*n*, *bins*, *patches*) or (*[n0, n1, ...]*, *bins*, *[patches0, patches1, ...]*) if the input contains multiple data.

Multiple data can be provided via *x* as a list of datasets of potentially different length (*[x0, x1, ...]*), or as a 2-D ndarray in which each column is a dataset. Note that the ndarray form is transposed relative to the list form.

Masked arrays are not supported at present.

Parameters x : (n,) array or sequence of (n,) arrays

Input values, this takes either a single array or a sequence of arrays which are not required to be of the same length

bins : integer or array_like or 'auto', optional

If an integer is given, *bins* + 1 bin edges are returned, consistently with `numpy.histogram()` for numpy version ≥ 1.3 .

Unequally spaced bins are supported if *bins* is a sequence.

If Numpy 1.11 is installed, may also be 'auto'.

Default is taken from the `rcParam hist.bins`.

range : tuple or None, optional

The lower and upper range of the bins. Lower and upper outliers are ignored. If not provided, `range` is `(x.min(), x.max())`. Range has no effect if `bins` is a sequence.

If `bins` is a sequence or `range` is specified, autoscaling is based on the specified bin range instead of the range of `x`.

Default is None

normed : boolean, optional

If True, the first element of the return tuple will be the counts normalized to form a probability density, i.e., $n/(\text{len}(x) \cdot \text{dbin})$, i.e., the integral of the histogram will sum to 1. If `stacked` is also True, the sum of the histograms is normalized to 1.

Default is False

weights : (n,) array_like or None, optional

An array of weights, of the same shape as `x`. Each value in `x` only contributes its associated weight towards the bin count (instead of 1). If `normed` is True, the weights are normalized, so that the integral of the density over the range remains 1.

Default is None

cumulative : boolean, optional

If True, then a histogram is computed where each bin gives the counts in that bin plus all bins for smaller values. The last bin gives the total number of datapoints. If `normed` is also True then the histogram is normalized such that the last bin equals 1. If `cumulative` evaluates to less than 0 (e.g., -1), the direction of accumulation is reversed. In this case, if `normed` is also True, then the histogram is normalized such that the first bin equals 1.

Default is False

bottom : array_like, scalar, or None

Location of the bottom baseline of each bin. If a scalar, the base line for each bin is shifted by the same amount. If an array, each bin is shifted independently and the length of bottom must match the number of bins. If None, defaults to 0.

Default is None

histtype : { 'bar', 'barstacked', 'step', 'stepfilled' }, optional

The type of histogram to draw.

- 'bar' is a traditional bar-type histogram. If multiple data are given the bars are aranged side by side.

- ‘barstacked’ is a bar-type histogram where multiple data are stacked on top of each other.
- ‘step’ generates a lineplot that is by default unfilled.
- ‘stepfilled’ generates a lineplot that is by default filled.

Default is ‘bar’

align : { ‘left’, ‘mid’, ‘right’ }, optional

Controls how the histogram is plotted.

- ‘left’: bars are centered on the left bin edges.
- ‘mid’: bars are centered between the bin edges.
- ‘right’: bars are centered on the right bin edges.

Default is ‘mid’

orientation : { ‘horizontal’, ‘vertical’ }, optional

If ‘horizontal’, *barh* will be used for bar-type histograms and the *bottom* kwarg will be the left edges.

rwidth : scalar or None, optional

The relative width of the bars as a fraction of the bin width. If None, automatically compute the width.

Ignored if *histtype* is ‘step’ or ‘stepfilled’.

Default is None

log : boolean, optional

If True, the histogram axis will be set to a log scale. If *log* is True and *x* is a 1D array, empty bins will be filtered out and only the non-empty (*n*, *bins*, *patches*) will be returned.

Default is False

color : color or array_like of colors or None, optional

Color spec or sequence of color specs, one per dataset. Default (None) uses the standard line color sequence.

Default is None

label : string or None, optional

String, or sequence of strings to match multiple datasets. Bar charts yield multiple patches per dataset, but only the first gets the label, so that the legend command will work as expected.

default is None

stacked : boolean, optional

If `True`, multiple data are stacked on top of each other. If `False` multiple data are arranged side by side if `histtype` is `'bar'` or on top of each other if `histtype` is `'step'`.

Default is `False`.

Returns `n` : array or list of arrays

The values of the histogram bins. See **`normed`** and **`weights`** for a description of the possible semantics. If input `x` is an array, then this is an array of length **`nbins`**. If input is a sequence of arrays `[data1, data2, ...]`, then this is a list of arrays with the values of the histograms for each of the arrays in the same order.

`bins` : array

The edges of the bins. Length `nbins + 1` (`nbins` left edges and right edge of last bin). Always a single array even when multiple data sets are passed in.

`patches` : list or list of lists

Silent list of individual patches used to create the histogram or list of such list if multiple input datasets.

Other Parameters `kwargs` : *Patch* properties

See also:

hist2d 2D histograms

Notes

Until numpy release 1.5, the underlying numpy histogram function was incorrect with `normed=True` if bin sizes were unequal. MPL inherited that error. It is now corrected within MPL when using earlier numpy versions.

Examples

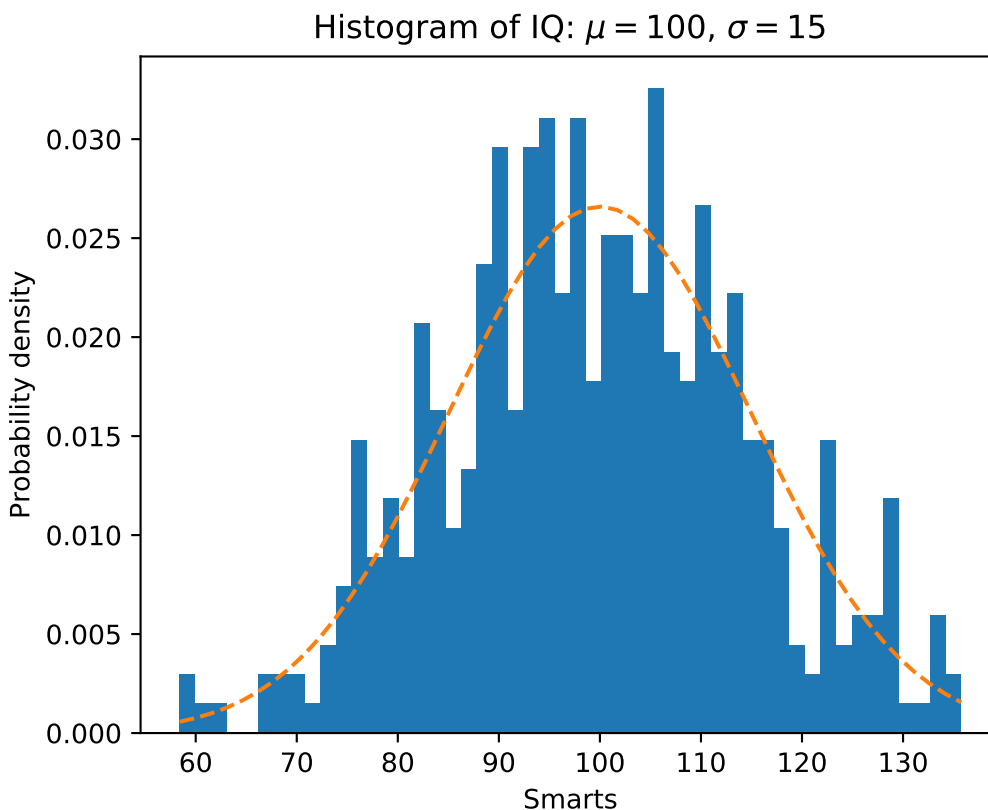

Note: In addition to the above described arguments, this function can take a **data** keyword argument. If such a **data** argument is given, the following arguments are replaced by **data[<arg>]**:

- All arguments with the following names: 'weights', 'x'.
-

matplotlib.axes.Axes.hist2d

Axes.hist2d(*x, y, bins=10, range=None, normed=False, weights=None, cmin=None, cmax=None, **kwargs*)

Make a 2D histogram plot.

Parameters *x, y*: **array_like, shape (n,)**

Input values

bins: [**None** | **int** | [**int, int**] | **array_like** | [**array, array**]]

The bin specification:

- If **int**, the number of bins for the two dimensions ($n_x = n_y = \text{bins}$).
- If [**int, int**], the number of bins in each dimension ($n_x, n_y = \text{bins}$).

- If `array_like`, the bin edges for the two dimensions (`x_edges=y_edges=bins`).
- If `[array, array]`, the bin edges in each dimension (`x_edges, y_edges = bins`).

The default value is 10.

range : `array_like` shape(2, 2), optional, default: None

The leftmost and rightmost edges of the bins along each dimension (if not specified explicitly in the bins parameters): `[[xmin, xmax], [ymin, ymax]]`. All values outside of this range will be considered outliers and not tallied in the histogram.

normed : boolean, optional, default: False

Normalize histogram.

weights : `array_like`, shape (n,), optional, default: None

An array of values `w_i` weighing each sample (`x_i, y_i`).

cmin : scalar, optional, default: None

All bins that has count less than `cmin` will not be displayed and these count values in the return value `count` histogram will also be set to `nan` upon return

cmax : scalar, optional, default: None

All bins that has count more than `cmax` will not be displayed (set to `none` before passing to `imshow`) and these count values in the return value `count` histogram will also be set to `nan` upon return

Returns The return value is (`counts`, `xedges`, `yedges`, `Image`).

Other Parameters **cmap** : {`Colormap`, string}, optional

A `matplotlib.colors.Colormap` instance. If not set, use rc settings.

norm : Normalize, optional

A `matplotlib.colors.Normalize` instance is used to scale luminance data to `[0, 1]`. If not set, defaults to `Normalize()`.

vmin/vmax : {None, scalar}, optional

Arguments passed to the `Normalize` instance.

alpha : 0 <= scalar <= 1 or None, optional

The alpha blending value.

See also:

[*hist*](#) 1D histogram

Notes

Rendering the histogram with a logarithmic color scale is accomplished by passing a `colors.LogNorm` instance to the `norm` keyword argument. Likewise, power-law normalization (similar in effect to gamma correction) can be accomplished with `colors.PowerNorm`.

Examples

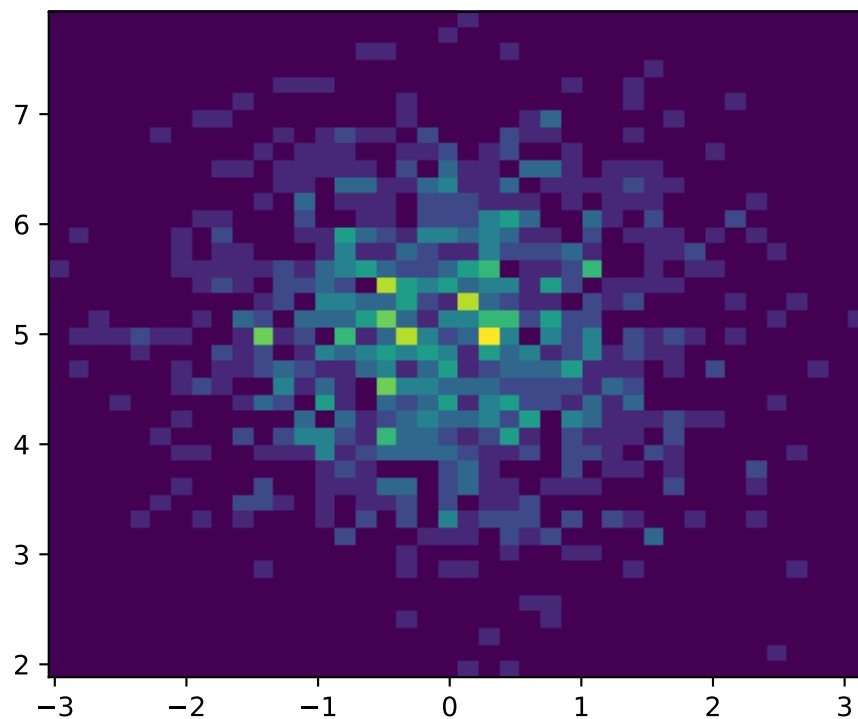

Note: In addition to the above described arguments, this function can take a **data** keyword argument. If such a **data** argument is given, the following arguments are replaced by **data[<arg>]**:

- All arguments with the following names: 'weights', 'x', 'y'.
-

19.1.6 Contours

<code>Axes.clabel</code>	Label a contour plot.
<code>Axes.contour</code>	Plot contours.
<code>Axes.contourf</code>	Plot contours.

matplotlib.axes.Axes.clabel

Axes.clabel(*CS*, *args, **kwargs)

Label a contour plot.

Call signature:

```
cclassdef clabel(cs, **kwargs)
```

Adds labels to line contours in *cs*, where *cs* is a `ContourSet` object returned by `contour`.

```
cclassdef clabel(cs, v, **kwargs)
```

only labels contours listed in *v*.

Optional keyword arguments:

fontsize: size in points or relative size e.g., ‘smaller’, ‘x-large’

colors:

- if *None*, the color of each label matches the color of the corresponding contour
- if one string color, e.g., *colors* = ‘r’ or *colors* = ‘red’, all labels will be plotted in this color
- if a tuple of matplotlib color args (string, float, rgb, etc), different labels will be plotted in different colors in the order specified

inline: controls whether the underlying contour is removed or not. Default is *True*.

inline_spacing: space in pixels to leave on each side of label when placing inline. Defaults to 5. This spacing will be exact for labels at locations where the contour is straight, less so for labels on curved contours.

fmt: a format string for the label. Default is ‘%1.3f’ Alternatively, this can be a dictionary matching contour levels with arbitrary strings to use for each contour level (i.e., *fmt*[level]=string), or it can be any callable, such as a `Formatter` instance, that returns a string when called with a numeric contour level.

manual: if *True*, contour labels will be placed manually using mouse clicks. Click the first button near a contour to add a label, click the second button (or potentially both mouse buttons at once) to finish adding labels. The third button can be used to remove the last label added, but only if labels are not inline. Alternatively, the keyboard can be used to select label locations (enter to end label placement, delete or backspace act like the third mouse button, and any other key will select a label location).

manual can be an iterable object of x,y tuples. Contour labels will be created as if mouse is clicked at each x,y positions.

rightside_up: if *True* (default), label rotations will always be plus or minus 90 degrees from level.

use_clabeltext: if *True* (default is *False*), *ClabelText* class (instead of *matplotlib.Text*) is used to create labels. *ClabelText* recalculates rotation angles of texts during the drawing time, therefore this can be used if aspect of the axes changes.

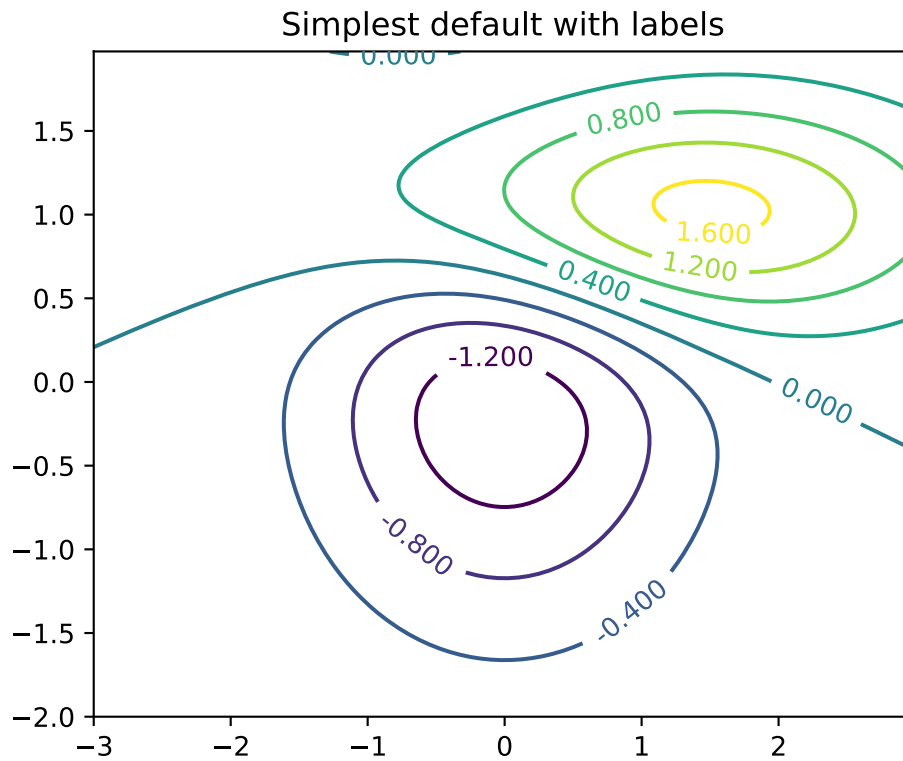

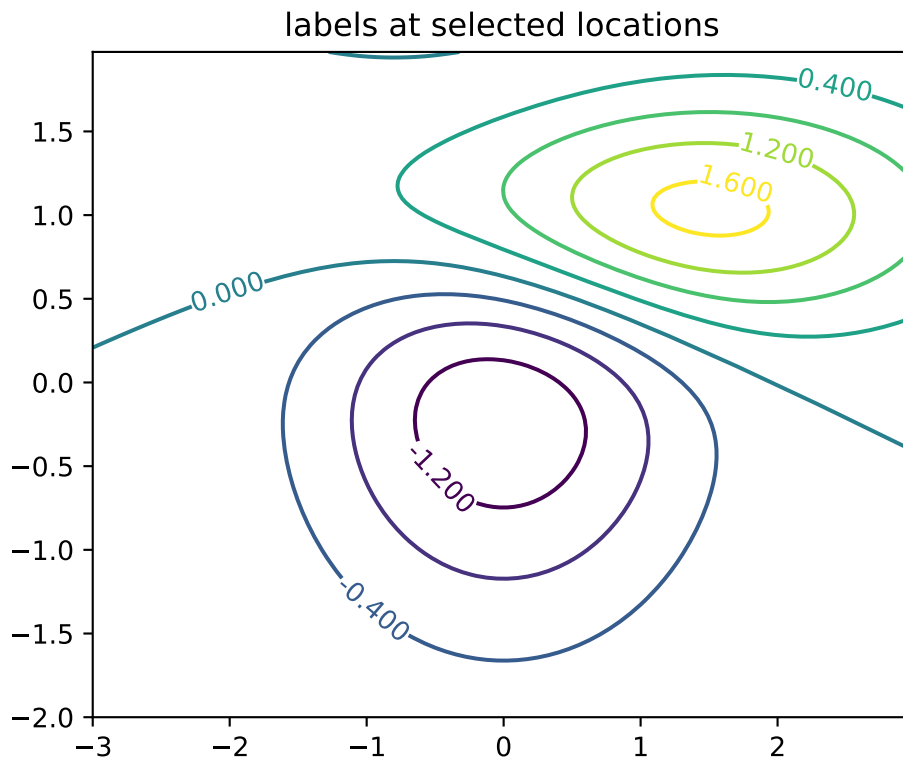

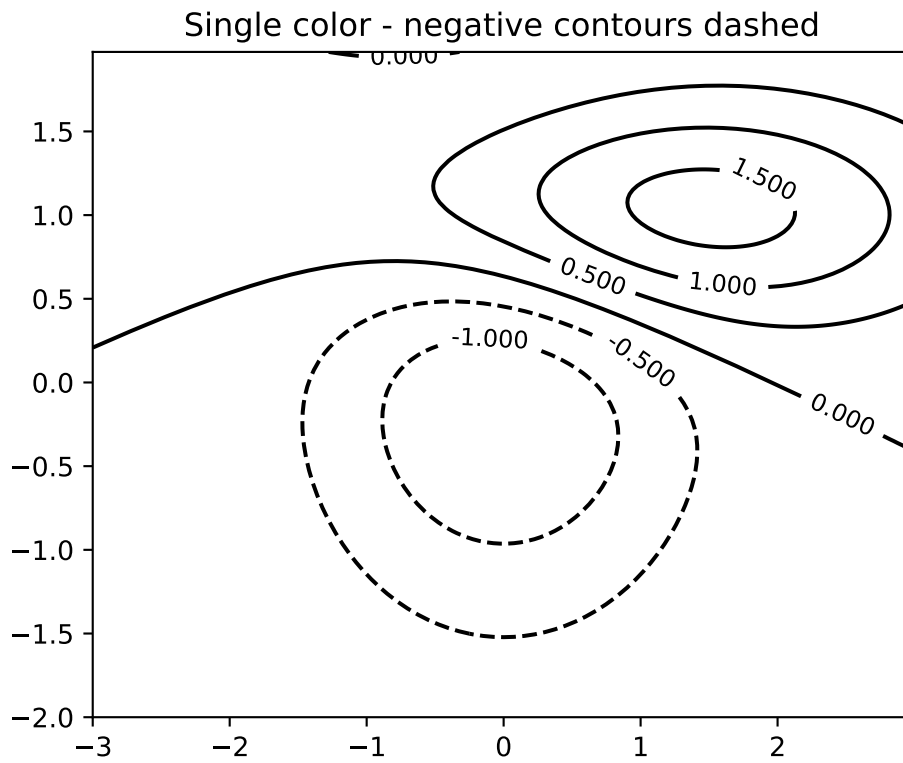

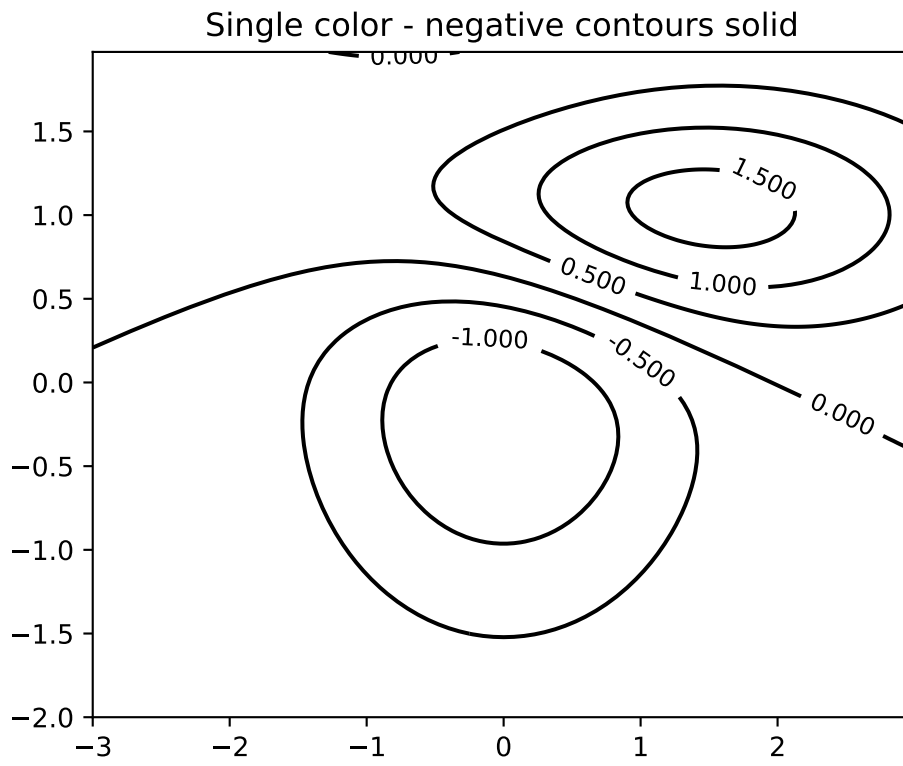

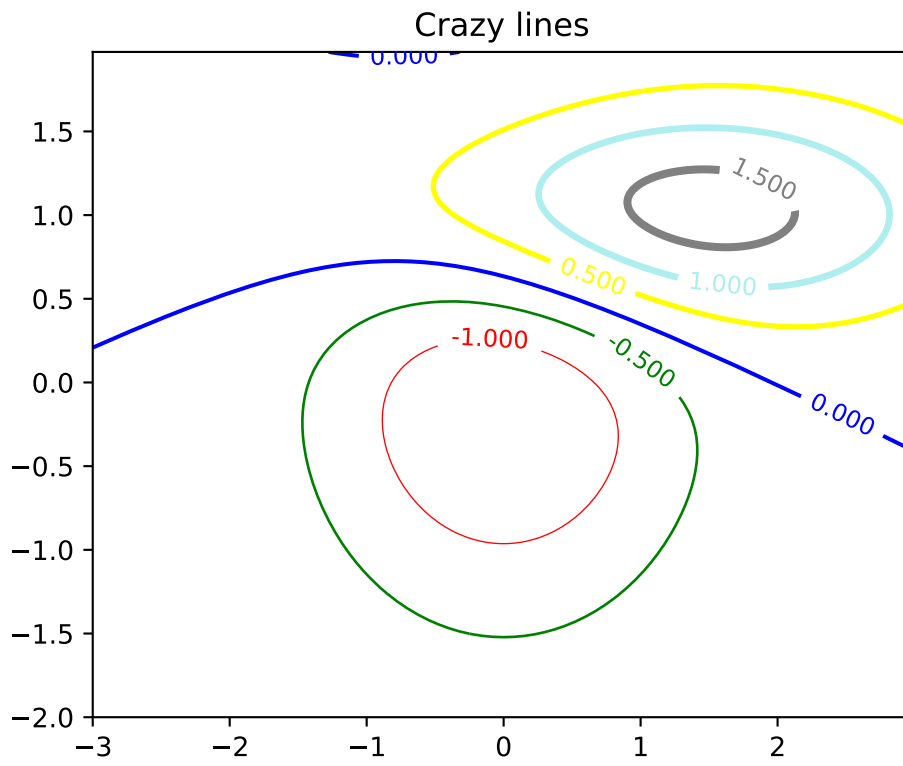

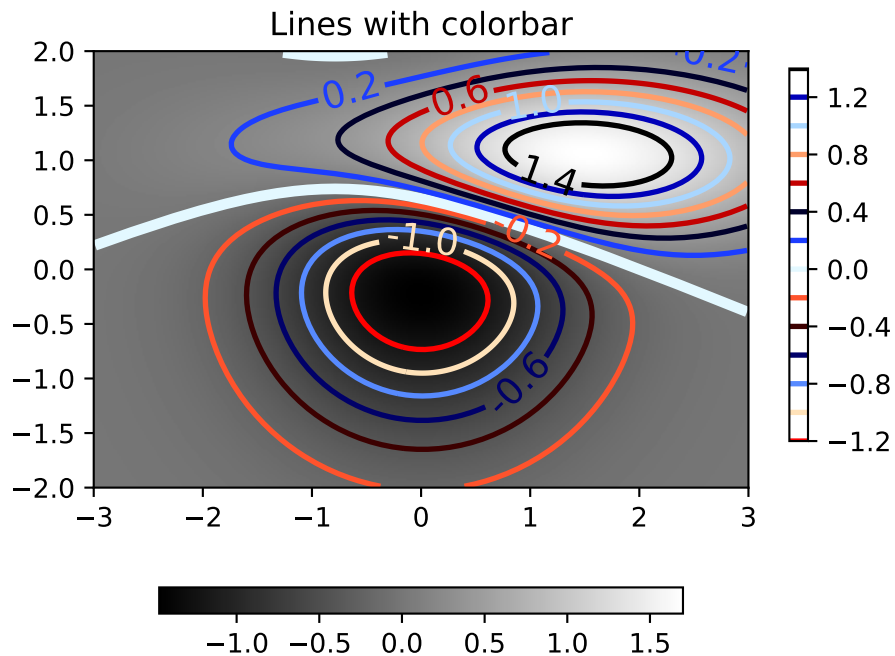

matplotlib.axes.Axes.contour

`Axes.contour(*args, **kwargs)`

Plot contours.

`contour()` and `contourf()` draw contour lines and filled contours, respectively. Except as noted, function signatures and return values are the same for both versions.

`contourf()` differs from the MATLAB version in that it does not draw the polygon edges. To draw edges, add line contours with calls to `contour()`.

Call signatures:

```
contour(Z)
```

make a contour plot of an array `Z`. The level values are chosen automatically.

```
contour(X, Y, Z)
```

`X`, `Y` specify the (x, y) coordinates of the surface

```
contour(Z, N)
contour(X, Y, Z, N)
```

contour up to `N` automatically-chosen levels.

```
contour(Z, V)
contour(X, Y, Z, V)
```

draw contour lines at the values specified in sequence *V*, which must be in increasing order.

```
contourf(..., V)
```

fill the $\text{len}(V) - 1$ regions between the values in *V*, which must be in increasing order.

```
contour(Z, **kwargs)
```

Use keyword args to control colors, linewidth, origin, cmap ... see below for more details.

X and *Y* must both be 2-D with the same shape as *Z*, or they must both be 1-D such that $\text{len}(X)$ is the number of columns in *Z* and $\text{len}(Y)$ is the number of rows in *Z*.

C = `contour(...)` returns a `QuadContourSet` object.

Optional keyword arguments:

corner_mask: [*True* | *False* | 'legacy'] Enable/disable corner masking, which only has an effect if *Z* is a masked array. If *False*, any quad touching a masked point is masked out. If *True*, only the triangular corners of quads nearest those points are always masked out, other triangular corners comprising three unmasked points are contoured as usual. If 'legacy', the old contouring algorithm is used, which is equivalent to *False* and is deprecated, only remaining whilst the new algorithm is tested fully.

If not specified, the default is taken from `rcParams['contour.corner_mask']`, which is *True* unless it has been modified.

colors: [*None* | string | (`mpl_colors`)] If *None*, the colormap specified by `cmap` will be used.

If a string, like 'r' or 'red', all levels will be plotted in this color.

If a tuple of matplotlib color args (string, float, rgb, etc), different levels will be plotted in different colors in the order specified.

alpha: float The alpha blending value

cmap: [*None* | `Colormap`] A `Colormap` instance or *None*. If `cmap` is *None* and `colors` is *None*, a default `Colormap` is used.

norm: [*None* | `Normalize`] A `matplotlib.colors.Normalize` instance for scaling data values to colors. If `norm` is *None* and `colors` is *None*, the default linear scaling is used.

vmin, vmax: [*None* | scalar] If not *None*, either or both of these values will be supplied to the `matplotlib.colors.Normalize` instance, overriding the default color scaling based on `levels`.

levels: [`level0`, `level1`, ..., `levelN`] A list of floating point numbers indicating the level curves to draw, in increasing order; e.g., to draw just the zero contour pass `levels=[0]`

origin: [*None* | ‘upper’ | ‘lower’ | ‘image’] If *None*, the first value of *Z* will correspond to the lower left corner, location (0,0). If ‘image’, the rc value for `image.origin` will be used.

This keyword is not active if *X* and *Y* are specified in the call to `contour`.

extent: [*None* | (*x0*,*x1*,*y0*,*y1*)]

If *origin* is not *None*, then *extent* is interpreted as in `matplotlib.pyplot.imshow()`: it gives the outer pixel boundaries. In this case, the position of `Z[0,0]` is the center of the pixel, not a corner. If *origin* is *None*, then (*x0*, *y0*) is the position of `Z[0,0]`, and (*x1*, *y1*) is the position of `Z[-1,-1]`.

This keyword is not active if *X* and *Y* are specified in the call to `contour`.

locator: [*None* | `ticker.Locator` subclass] If *locator* is *None*, the default `MaxNLocator` is used. The locator is used to determine the contour levels if they are not given explicitly via the *V* argument.

extend: [‘neither’ | ‘both’ | ‘min’ | ‘max’] Unless this is ‘neither’, contour levels are automatically added to one or both ends of the range so that all data are included. These added ranges are then mapped to the special colormap values which default to the ends of the colormap range, but can be set via `matplotlib.colors.Colormap.set_under()` and `matplotlib.colors.Colormap.set_over()` methods.

xunits, yunits: [*None* | registered units] Override axis units by specifying an instance of a `matplotlib.units.ConversionInterface`.

antialiased: [*True* | *False*] enable antialiasing, overriding the defaults. For filled contours, the default is *True*. For line contours, it is taken from `rcParams['lines.antialiased']`.

nchunk: [0 | integer] If 0, no subdivision of the domain. Specify a positive integer to divide the domain into subdomains of *nchunk* by *nchunk* quads. Chunking reduces the maximum length of polygons generated by the contouring algorithm which reduces the rendering workload passed on to the backend and also requires slightly less RAM. It can however introduce rendering artifacts at chunk boundaries depending on the backend, the *antialiased* flag and value of *alpha*.

contour-only keyword arguments:

linewidths: [*None* | number | tuple of numbers] If *linewidths* is *None*, the default width in `lines.linewidth` in `matplotlibrc` is used.

If a number, all levels will be plotted with this linewidth.

If a tuple, different levels will be plotted with different linewidths in the order specified.

linestyles: [*None* | ‘solid’ | ‘dashed’ | ‘dashdot’ | ‘dotted’] If *linestyles* is *None*, the default is ‘solid’ unless the lines are monochrome. In that case, negative contours will take their linestyle from the `matplotlibrc` `contour.negative_linestyle` setting.

linestyles can also be an iterable of the above strings specifying a set of linestyles to be used. If this iterable is shorter than the number of contour levels it will be repeated as necessary.

contourf-only keyword arguments:

hatches: A list of cross hatch patterns to use on the filled areas. If None, no hatching will be added to the contour. Hatching is supported in the PostScript, PDF, SVG and Agg backends only.

Note: contourf fills intervals that are closed at the top; that is, for boundaries $z1$ and $z2$, the filled region is:

$$z1 < z \leq z2$$

There is one exception: if the lowest boundary coincides with the minimum value of the z array, then that minimum value will be included in the lowest interval.

Examples:

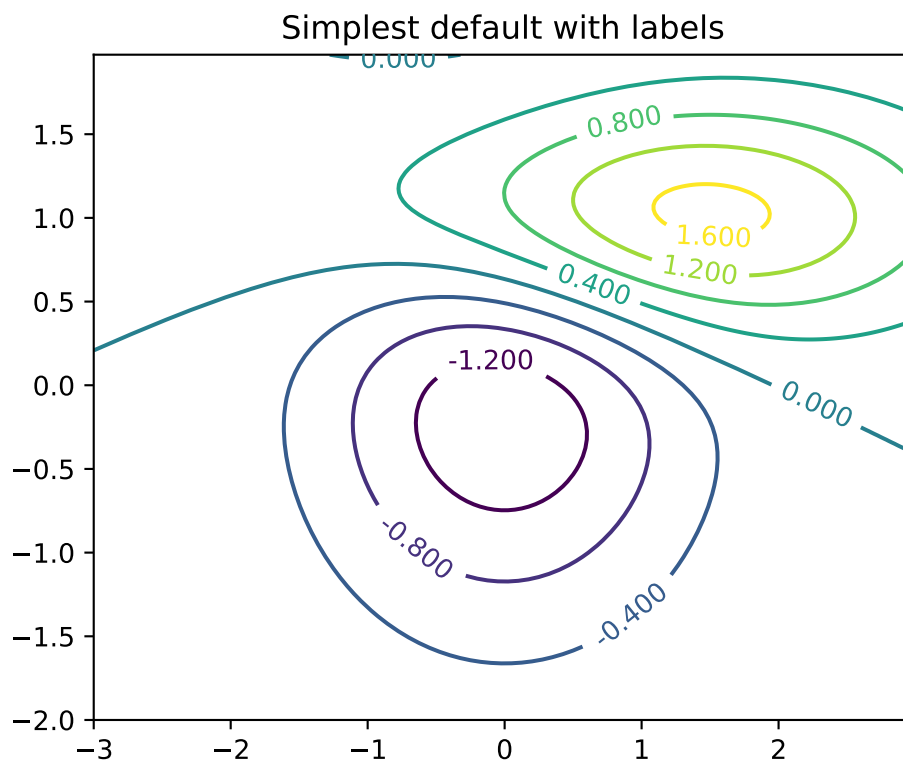

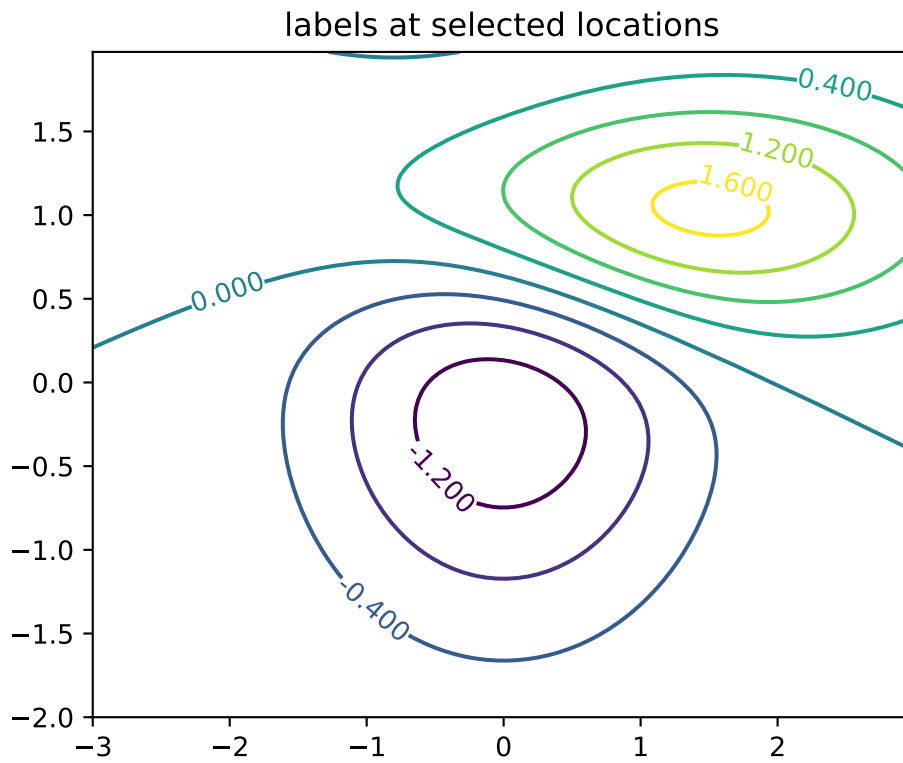

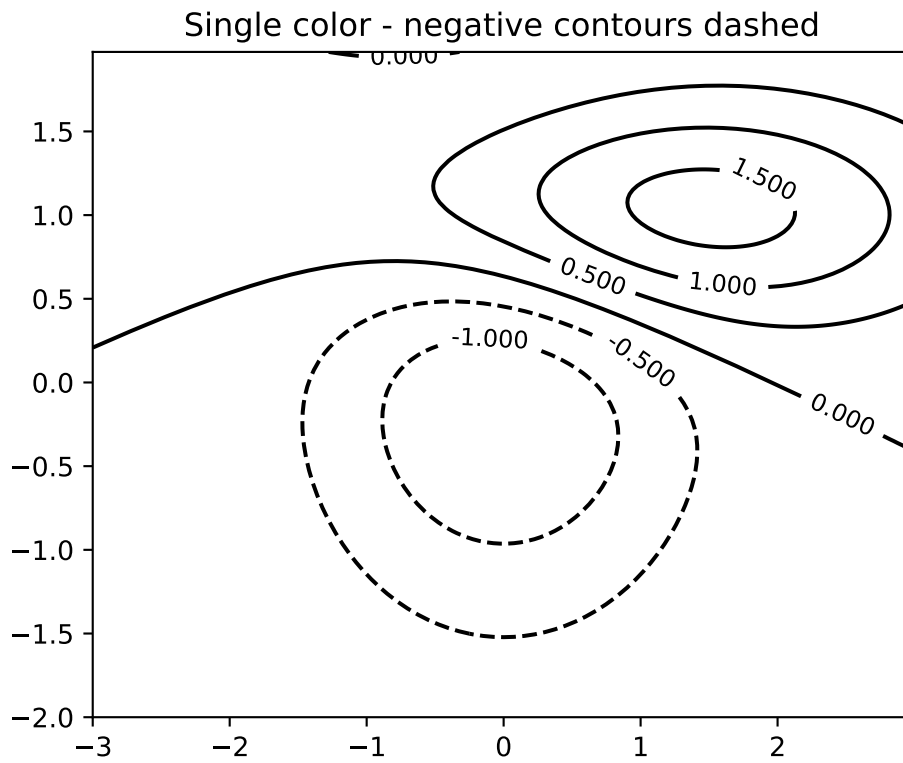

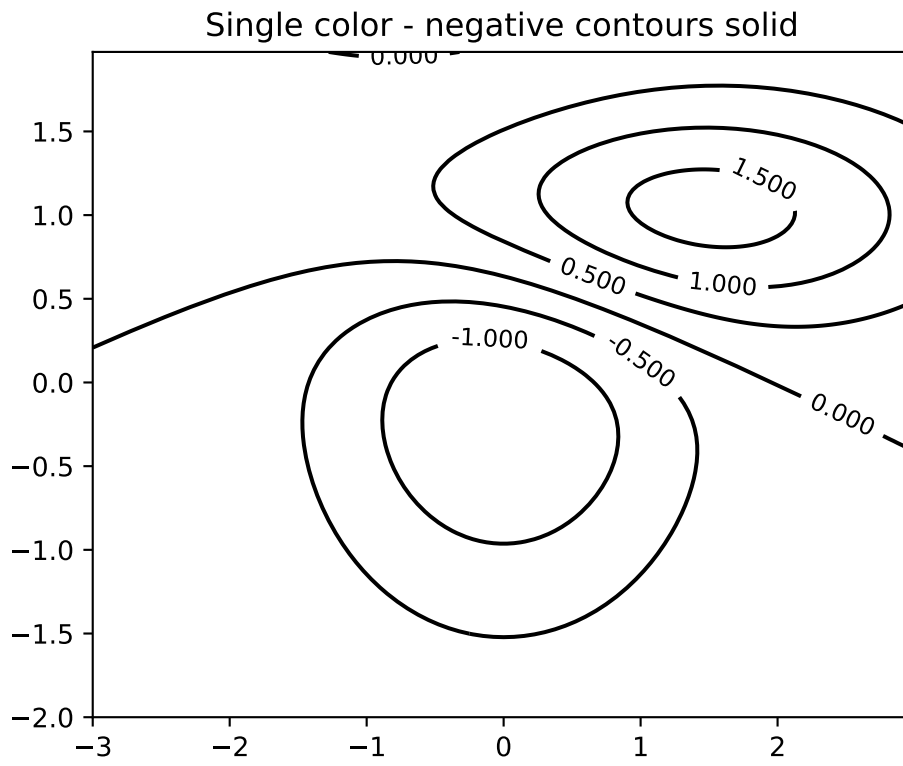

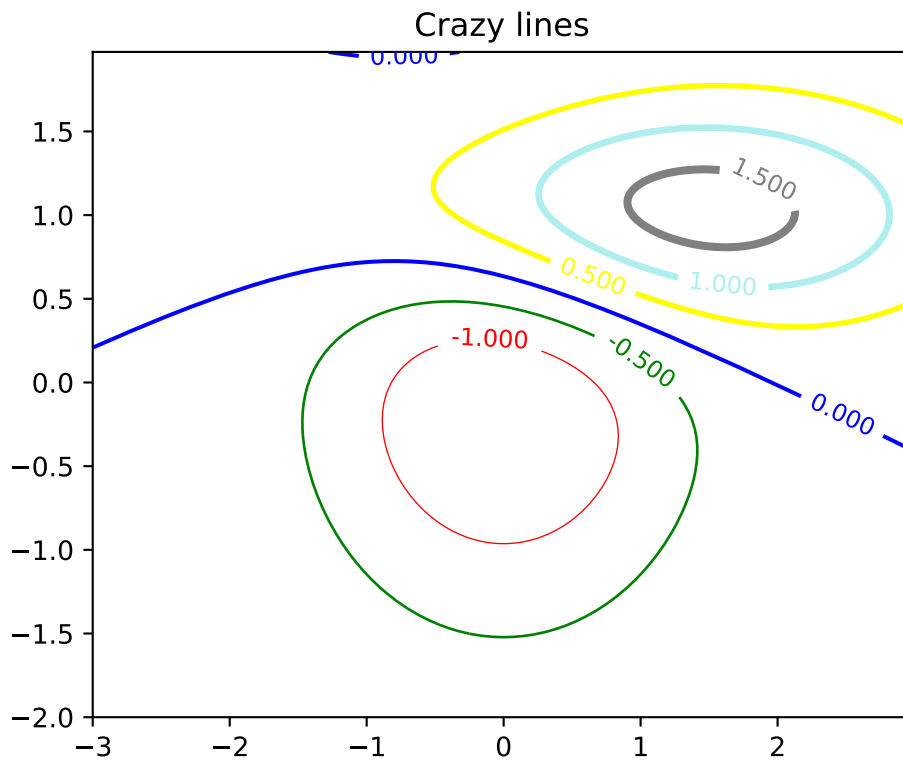

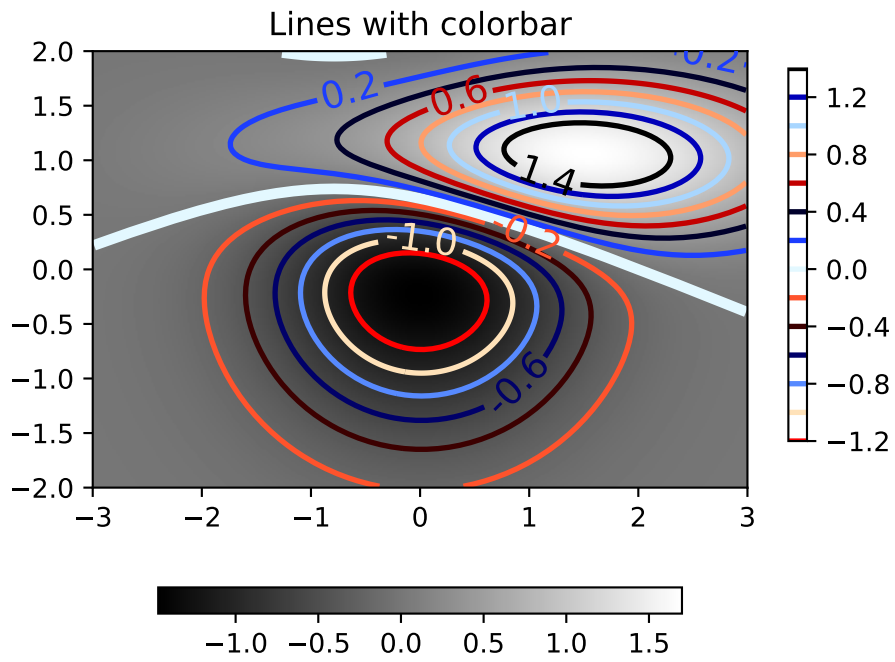

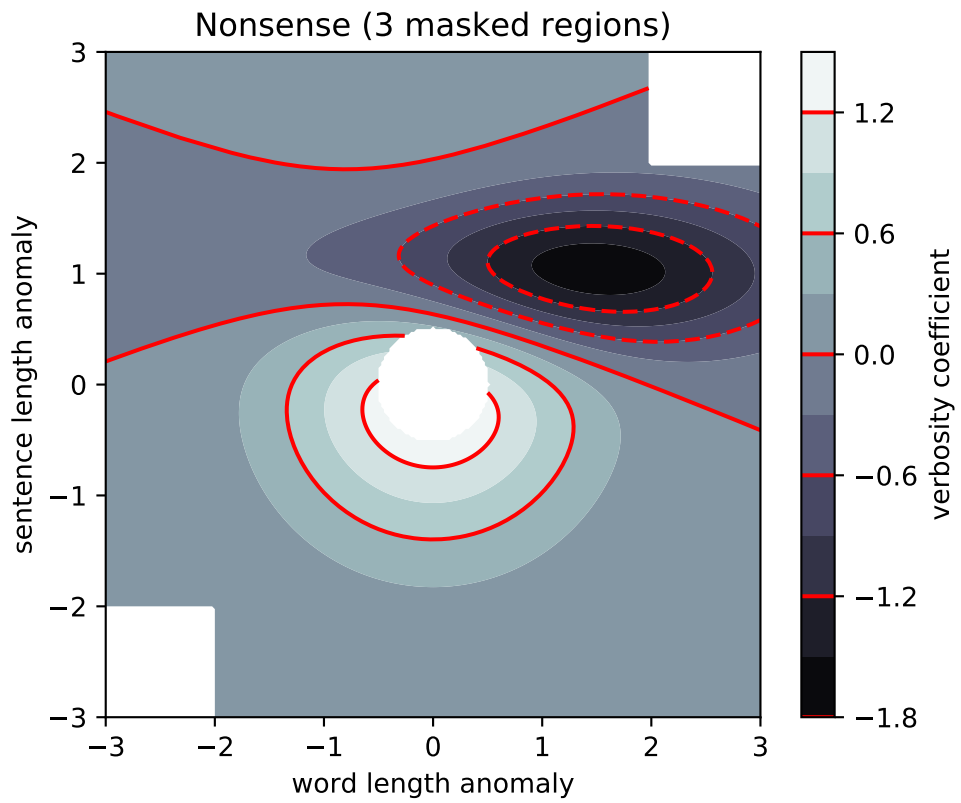

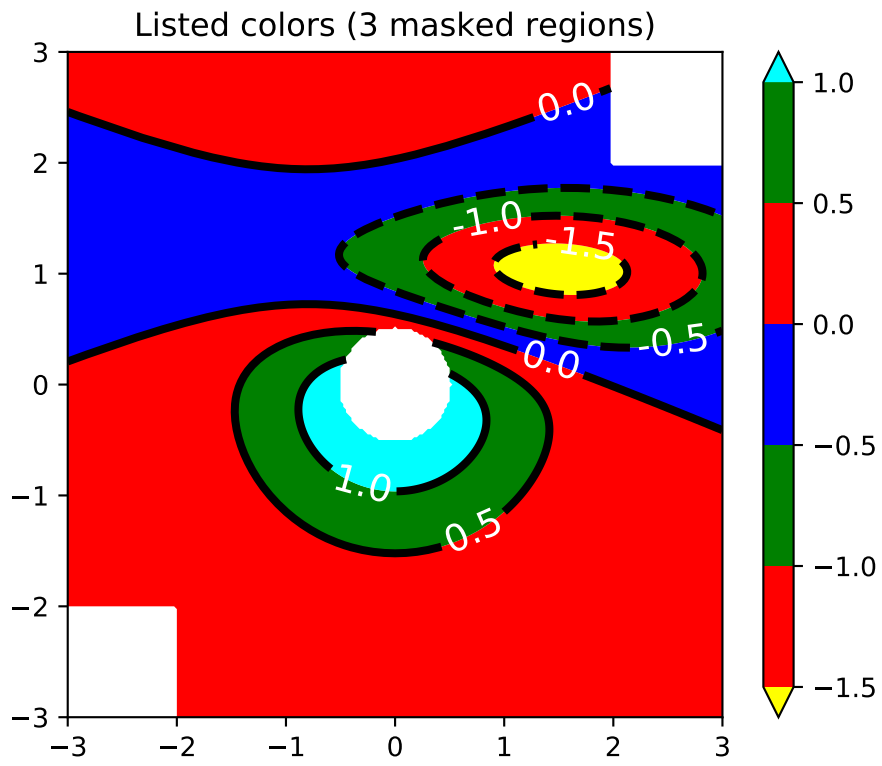

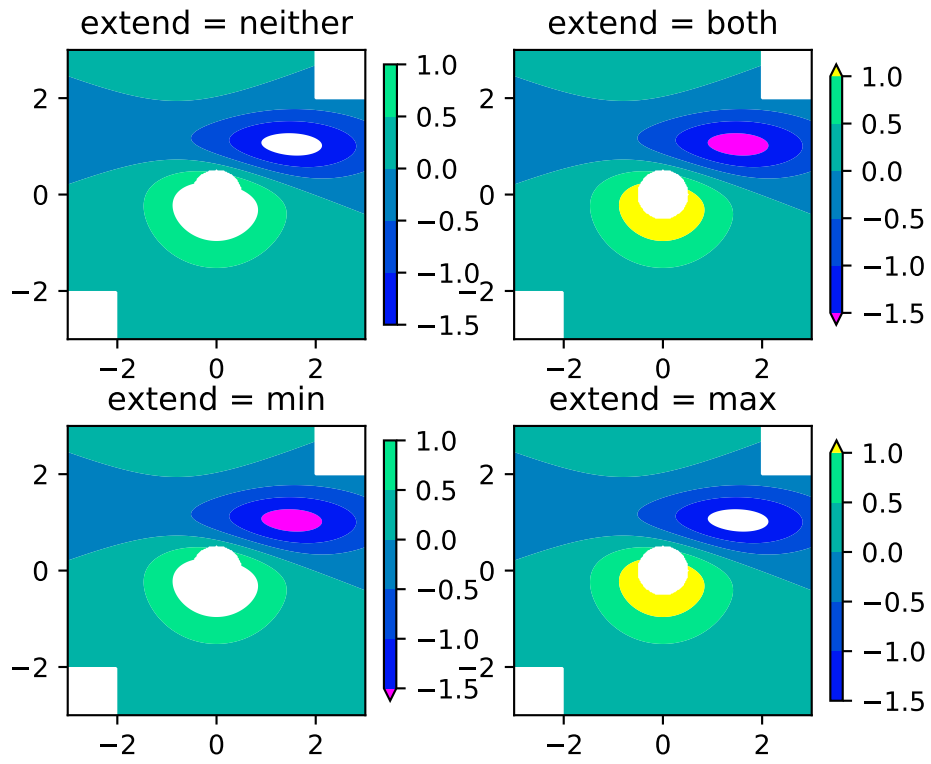

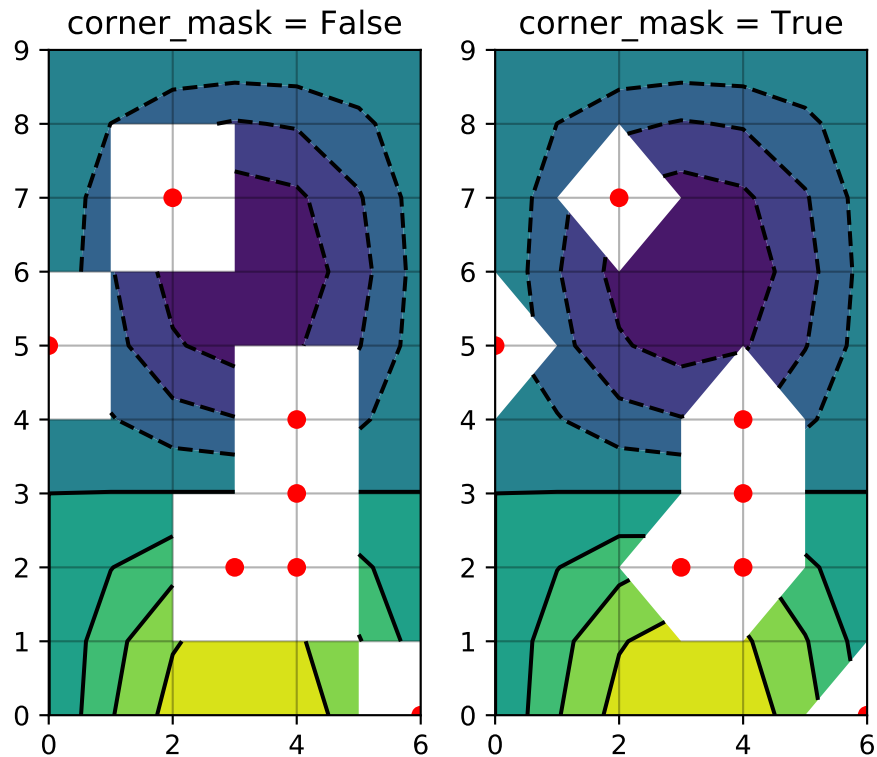

matplotlib.axes.Axes.contourf

`Axes.contourf(*args, **kwargs)`

Plot contours.

`contour()` and `contourf()` draw contour lines and filled contours, respectively. Except as noted, function signatures and return values are the same for both versions.

`contourf()` differs from the MATLAB version in that it does not draw the polygon edges. To draw edges, add line contours with calls to `contour()`.

Call signatures:

```
contour(Z)
```

make a contour plot of an array `Z`. The level values are chosen automatically.

```
contour(X, Y, Z)
```

`X`, `Y` specify the (x, y) coordinates of the surface

```
contour(Z, N)
contour(X, Y, Z, N)
```

contour up to `N` automatically-chosen levels.

```
contour(Z, V)
contour(X, Y, Z, V)
```

draw contour lines at the values specified in sequence *V*, which must be in increasing order.

```
contourf(..., V)
```

fill the $\text{len}(V) - 1$ regions between the values in *V*, which must be in increasing order.

```
contour(Z, **kwargs)
```

Use keyword args to control colors, linewidth, origin, cmap ... see below for more details.

X and *Y* must both be 2-D with the same shape as *Z*, or they must both be 1-D such that $\text{len}(X)$ is the number of columns in *Z* and $\text{len}(Y)$ is the number of rows in *Z*.

C = `contour(...)` returns a `QuadContourSet` object.

Optional keyword arguments:

corner_mask: [*True* | *False* | 'legacy'] Enable/disable corner masking, which only has an effect if *Z* is a masked array. If *False*, any quad touching a masked point is masked out. If *True*, only the triangular corners of quads nearest those points are always masked out, other triangular corners comprising three unmasked points are contoured as usual. If 'legacy', the old contouring algorithm is used, which is equivalent to *False* and is deprecated, only remaining whilst the new algorithm is tested fully.

If not specified, the default is taken from `rcParams['contour.corner_mask']`, which is *True* unless it has been modified.

colors: [*None* | string | (mpl_colors)] If *None*, the colormap specified by `cmap` will be used.

If a string, like 'r' or 'red', all levels will be plotted in this color.

If a tuple of matplotlib color args (string, float, rgb, etc), different levels will be plotted in different colors in the order specified.

alpha: float The alpha blending value

cmap: [*None* | Colormap] A cm [Colormap](#) instance or *None*. If *cmap* is *None* and *colors* is *None*, a default [Colormap](#) is used.

norm: [*None* | Normalize] A [matplotlib.colors.Normalize](#) instance for scaling data values to colors. If *norm* is *None* and *colors* is *None*, the default linear scaling is used.

vmin, vmax: [*None* | scalar] If not *None*, either or both of these values will be supplied to the [matplotlib.colors.Normalize](#) instance, overriding the default color scaling based on *levels*.

levels: [level0, level1, ..., levelN] A list of floating point numbers indicating the level curves to draw, in increasing order; e.g., to draw just the zero contour pass `levels=[0]`

origin: [*None* | ‘upper’ | ‘lower’ | ‘image’] If *None*, the first value of *Z* will correspond to the lower left corner, location (0,0). If ‘image’, the rc value for `image.origin` will be used.

This keyword is not active if *X* and *Y* are specified in the call to `contour`.

extent: [*None* | (*x0*,*x1*,*y0*,*y1*)]

If *origin* is not *None*, then *extent* is interpreted as in `matplotlib.pyplot.imshow()`: it gives the outer pixel boundaries. In this case, the position of `Z[0,0]` is the center of the pixel, not a corner. If *origin* is *None*, then (*x0*, *y0*) is the position of `Z[0,0]`, and (*x1*, *y1*) is the position of `Z[-1,-1]`.

This keyword is not active if *X* and *Y* are specified in the call to `contour`.

locator: [*None* | `ticker.Locator` subclass] If *locator* is *None*, the default `MaxNLocator` is used. The locator is used to determine the contour levels if they are not given explicitly via the *V* argument.

extend: [‘neither’ | ‘both’ | ‘min’ | ‘max’] Unless this is ‘neither’, contour levels are automatically added to one or both ends of the range so that all data are included. These added ranges are then mapped to the special colormap values which default to the ends of the colormap range, but can be set via `matplotlib.colors.Colormap.set_under()` and `matplotlib.colors.Colormap.set_over()` methods.

xunits, yunits: [*None* | registered units] Override axis units by specifying an instance of a `matplotlib.units.ConversionInterface`.

antialiased: [*True* | *False*] enable antialiasing, overriding the defaults. For filled contours, the default is *True*. For line contours, it is taken from `rcParams['lines.antialiased']`.

nchunk: [0 | integer] If 0, no subdivision of the domain. Specify a positive integer to divide the domain into subdomains of *nchunk* by *nchunk* quads. Chunking reduces the maximum length of polygons generated by the contouring algorithm which reduces the rendering workload passed on to the backend and also requires slightly less RAM. It can however introduce rendering artifacts at chunk boundaries depending on the backend, the *antialiased* flag and value of *alpha*.

contour-only keyword arguments:

linewidths: [*None* | number | tuple of numbers] If *linewidths* is *None*, the default width in `lines.linewidth` in `matplotlibrc` is used.

If a number, all levels will be plotted with this linewidth.

If a tuple, different levels will be plotted with different linewidths in the order specified.

linestyles: [*None* | ‘solid’ | ‘dashed’ | ‘dashdot’ | ‘dotted’] If *linestyles* is *None*, the default is ‘solid’ unless the lines are monochrome. In that case, negative contours will take their linestyle from the `matplotlibrc` `contour.negative_linestyle` setting.

linestyles can also be an iterable of the above strings specifying a set of linestyles to be used. If this iterable is shorter than the number of contour levels it will be repeated as necessary.

contourf-only keyword arguments:

hatches: A list of cross hatch patterns to use on the filled areas. If None, no hatching will be added to the contour. Hatching is supported in the PostScript, PDF, SVG and Agg backends only.

Note: contourf fills intervals that are closed at the top; that is, for boundaries $z1$ and $z2$, the filled region is:

```
z1 < z <= z2
```

There is one exception: if the lowest boundary coincides with the minimum value of the z array, then that minimum value will be included in the lowest interval.

Examples:

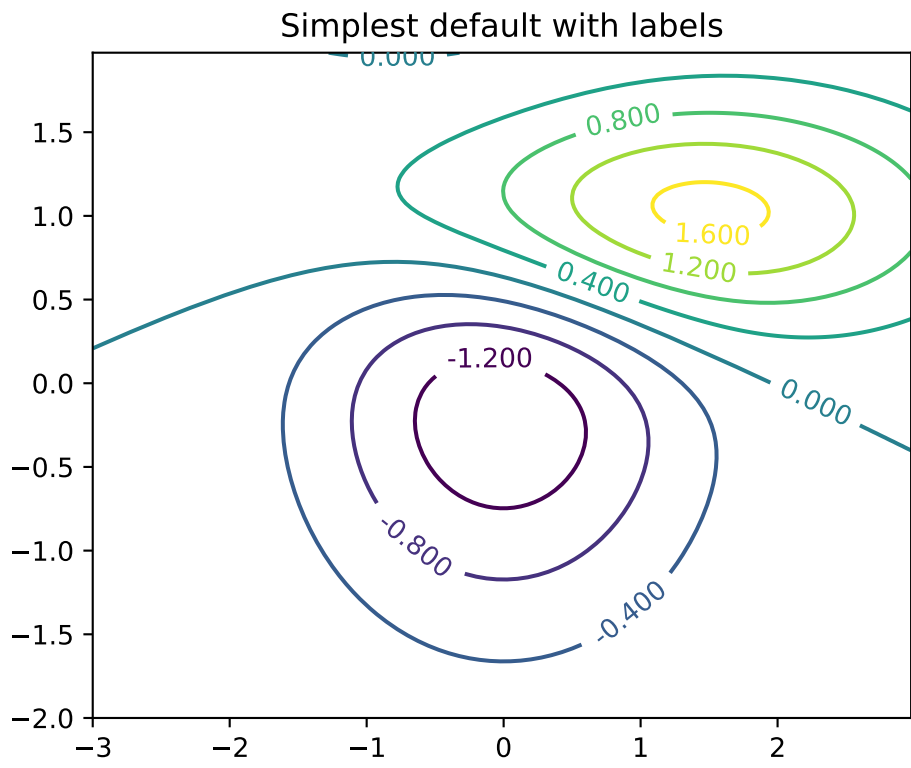

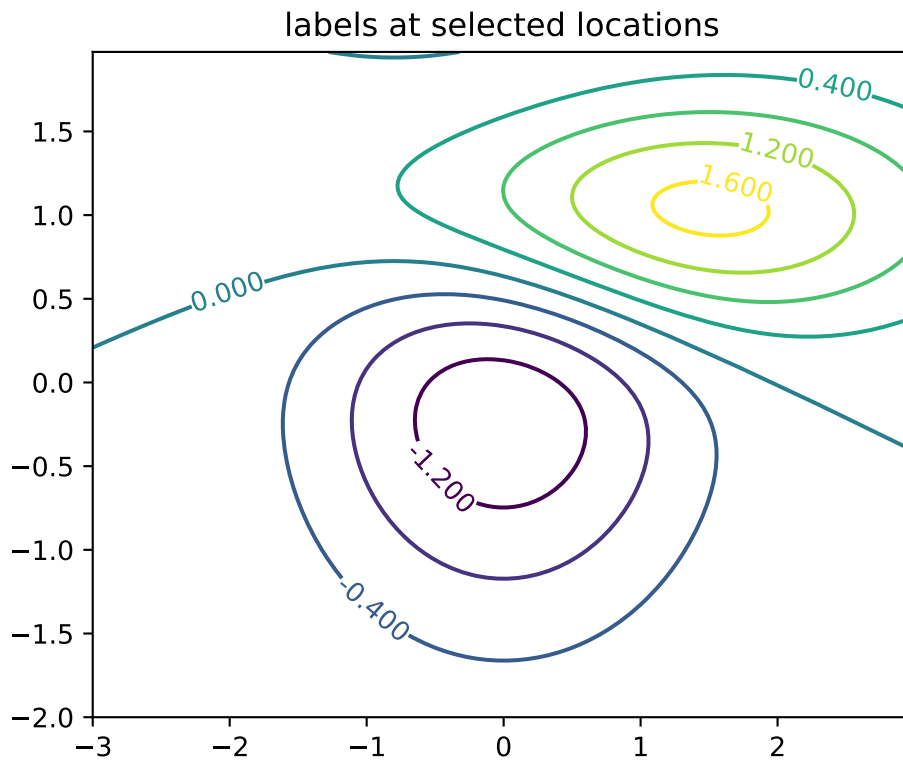

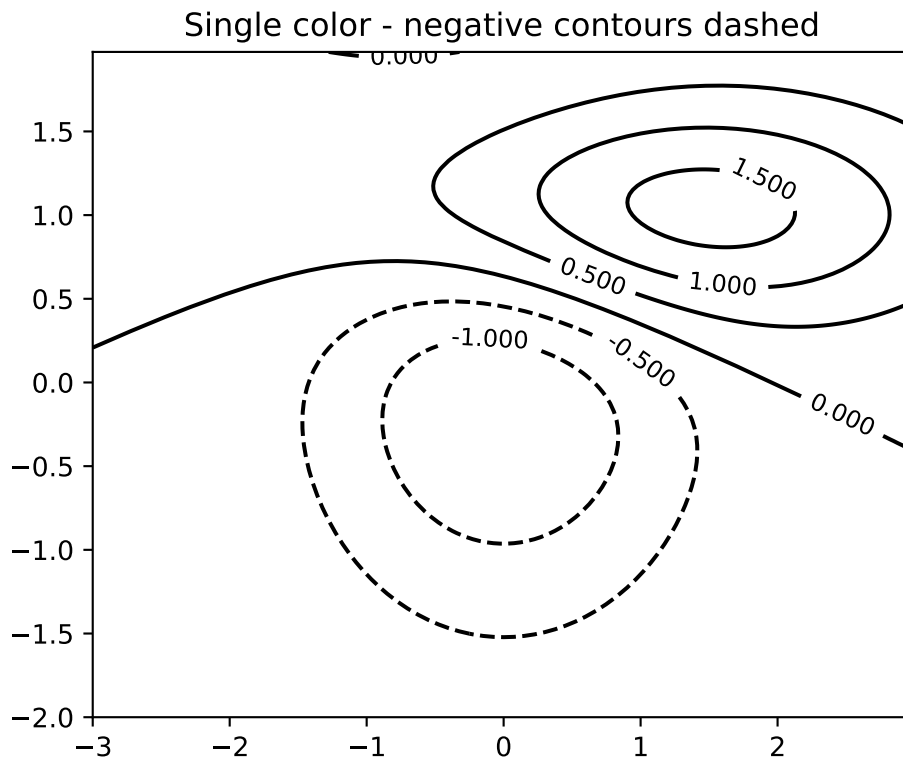

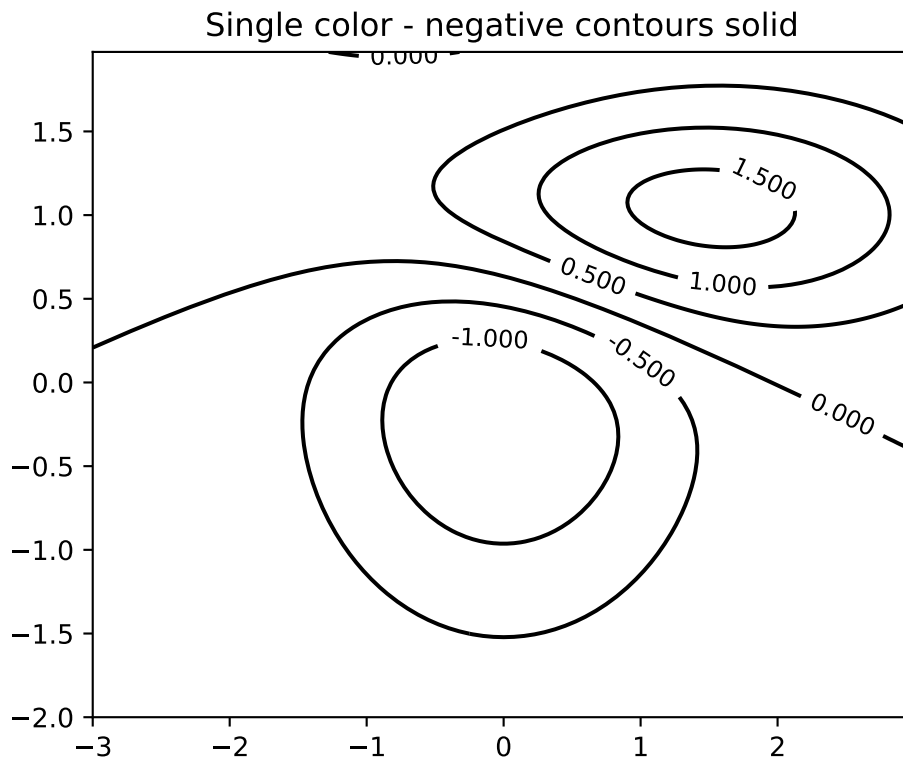

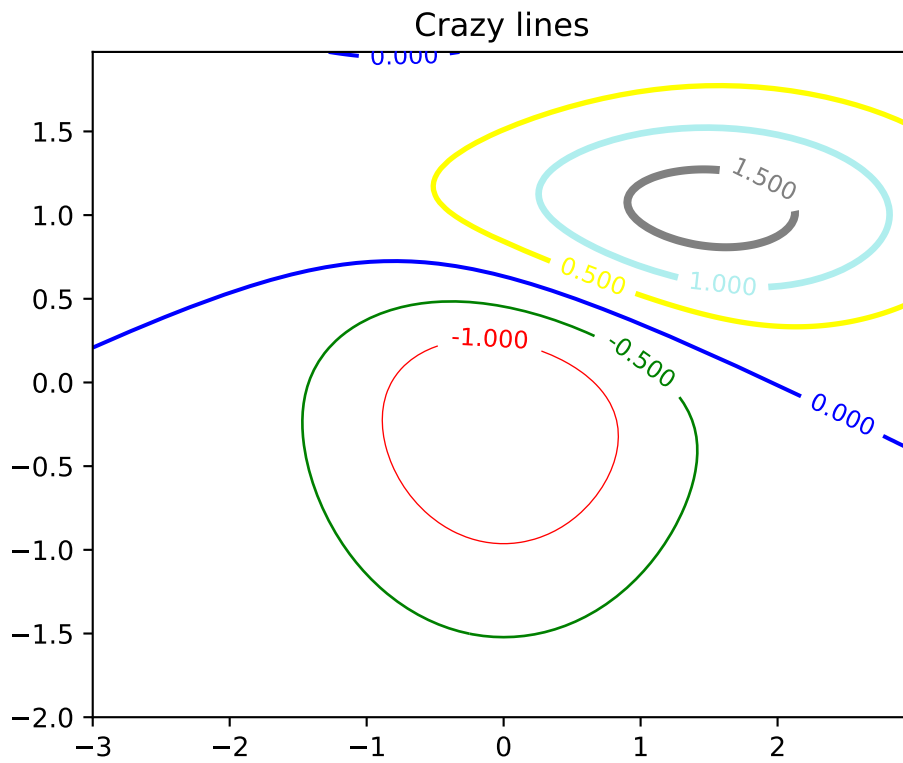

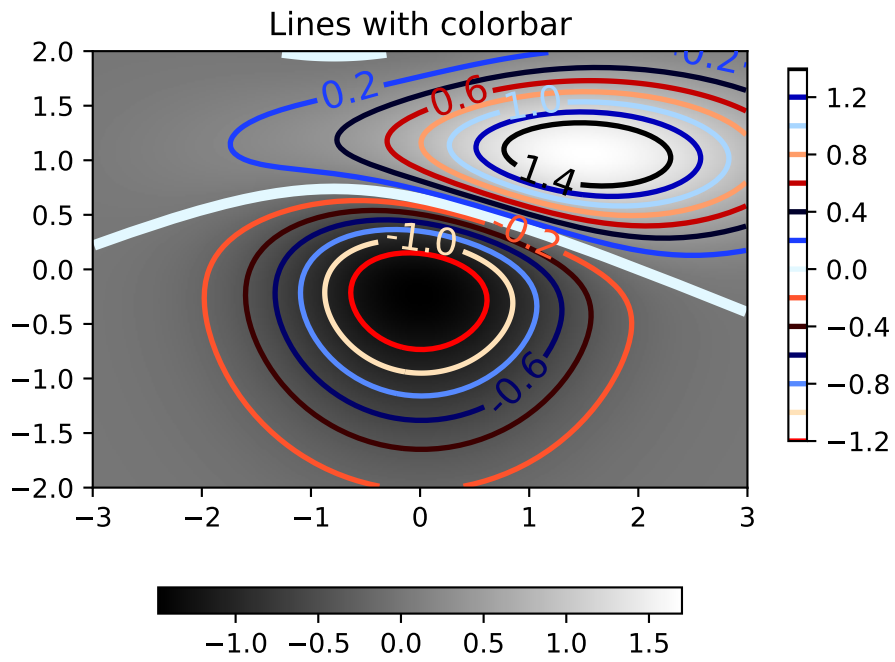

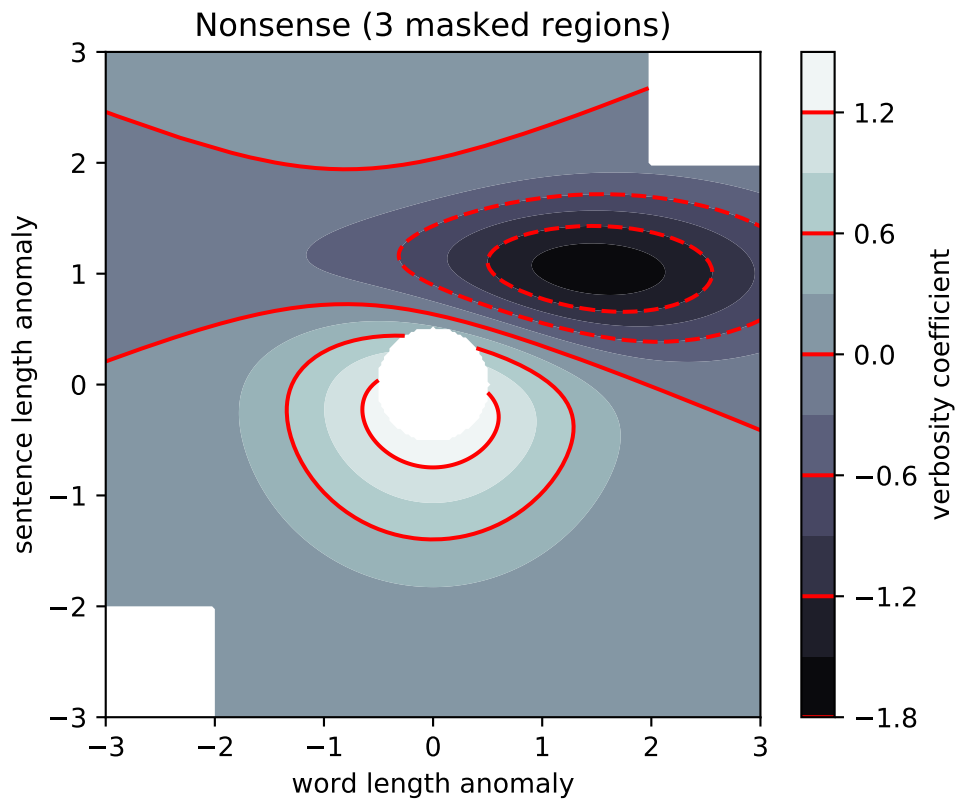

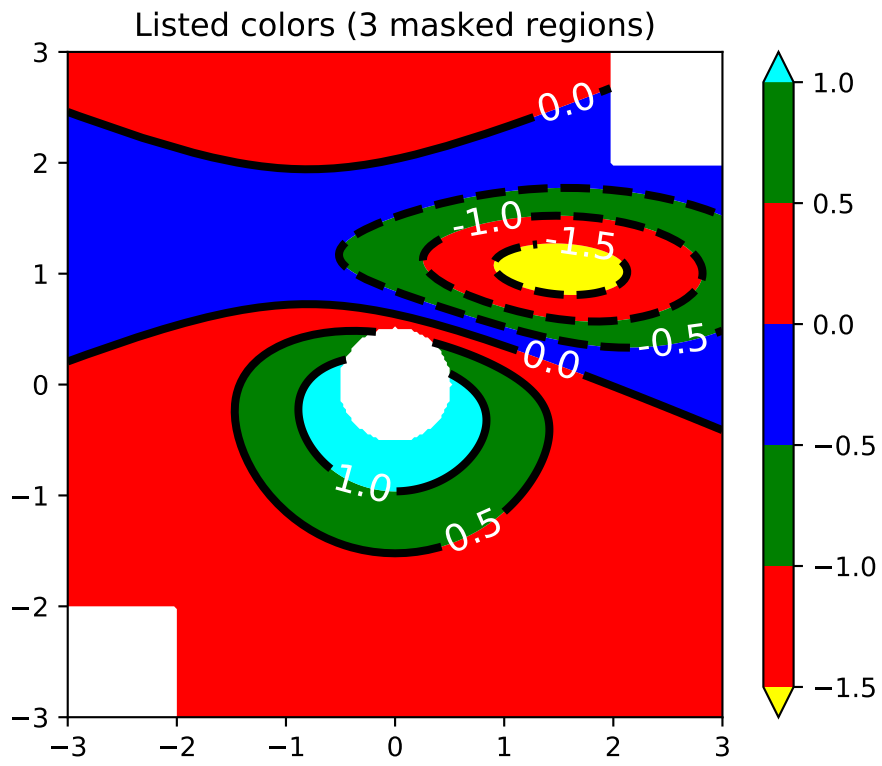

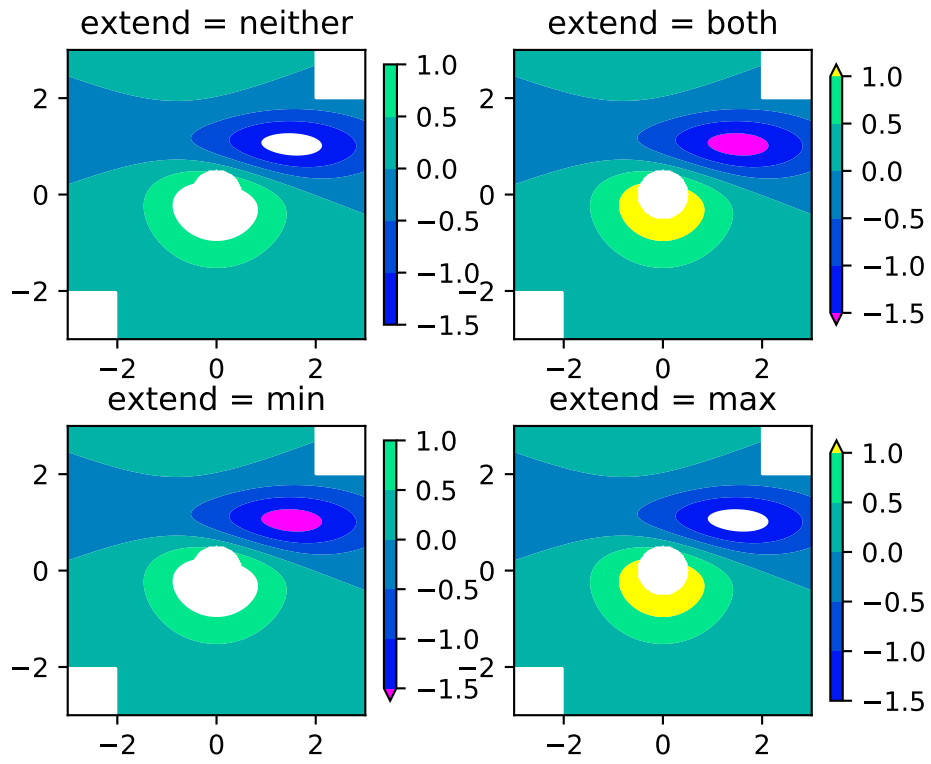

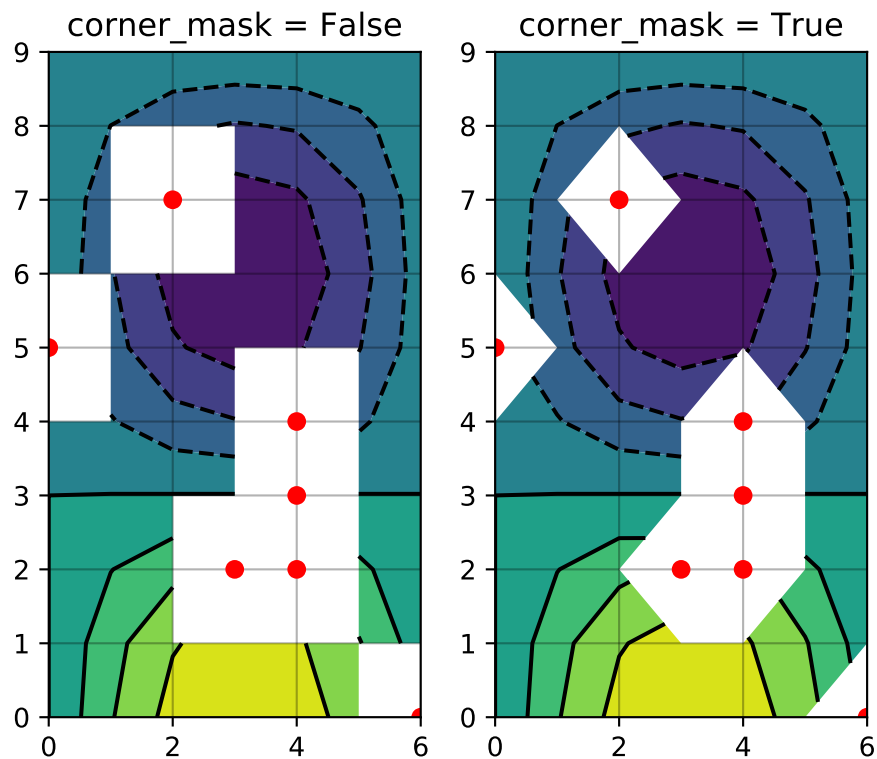

19.1.7 Array

<code>Axes.imshow</code>	Display an image on the axes.
<code>Axes.matshow</code>	Plot a matrix or array as an image.
<code>Axes.pcolor</code>	Create a pseudocolor plot of a 2-D array.
<code>Axes.pcolorfast</code>	pseudocolor plot of a 2-D array
<code>Axes.pcolormesh</code>	Plot a quadrilateral mesh.
<code>Axes.spy</code>	Plot the sparsity pattern on a 2-D array.

matplotlib.axes.Axes.imshow

`Axes.imshow(X, cmap=None, norm=None, aspect=None, interpolation=None, alpha=None, vmin=None, vmax=None, origin=None, extent=None, shape=None, filternorm=1, filterrad=4.0, imlim=None, resample=None, url=None, **kwargs)`

Display an image on the axes.

Parameters X : array_like, shape (n, m) or (n, m, 3) or (n, m, 4)

Display the image in X to current axes. X may be an array or a PIL image. If X is an array, it can have the following shapes and types:

- MxN – values to be mapped (float or int)

- $M \times N \times 3$ – RGB (float or uint8)
- $M \times N \times 4$ – RGBA (float or uint8)

The value for each component of $M \times N \times 3$ and $M \times N \times 4$ float arrays should be in the range 0.0 to 1.0. $M \times N$ arrays are mapped to colors based on the `norm` (mapping scalar to scalar) and the `cmap` (mapping the normed scalar to a color).

cmap : *Colormap*, optional, default: None

If None, default to `rc image.cmap` value. `cmap` is ignored if `X` is 3-D, directly specifying RGB(A) values.

aspect : ['auto' | 'equal' | scalar], optional, default: None

If 'auto', changes the image aspect ratio to match that of the axes.

If 'equal', and `extent` is None, changes the axes aspect ratio to match that of the image. If `extent` is not None, the axes aspect ratio is changed to match that of the extent.

If None, default to `rc image.aspect` value.

interpolation : string, optional, default: None

Acceptable values are 'none', 'nearest', 'bilinear', 'bicubic', 'spline16', 'spline36', 'hanning', 'hamming', 'hermite', 'kaiser', 'quadric', 'catrom', 'gaussian', 'bessel', 'mitchell', 'sinc', 'lanczos'

If `interpolation` is None, default to `rc image.interpolation`. See also the `filternorm` and `filterrad` parameters. If `interpolation` is 'none', then no interpolation is performed on the Agg, ps and pdf backends. Other backends will fall back to 'nearest'.

norm : *Normalize*, optional, default: None

A *Normalize* instance is used to scale a 2-D float `X` input to the (0, 1) range for input to the `cmap`. If `norm` is None, use the default `func:normalize`. If `norm` is an instance of *NoNorm*, `X` must be an array of integers that index directly into the lookup table of the `cmap`.

vmin, vmax : scalar, optional, default: None

`vmin` and `vmax` are used in conjunction with `norm` to normalize luminance data. Note if you pass a `norm` instance, your settings for `vmin` and `vmax` will be ignored.

alpha : scalar, optional, default: None

The alpha blending value, between 0 (transparent) and 1 (opaque)

origin : ['upper' | 'lower'], optional, default: None

Place the [0,0] index of the array in the upper left or lower left corner of the axes. If None, default to `rc image.origin`.

extent : scalars (left, right, bottom, top), optional, default: None

The location, in data-coordinates, of the lower-left and upper-right corners. If `None`, the image is positioned such that the pixel centers fall on zero-based (row, column) indices.

shape : scalars (columns, rows), optional, default: `None`

For raw buffer images

filtnorm : scalar, optional, default: 1

A parameter for the antigrain image resize filter. From the antigrain documentation, if `filtnorm = 1`, the filter normalizes integer values and corrects the rounding errors. It doesn't do anything with the source floating point values, it corrects only integers according to the rule of 1.0 which means that any sum of pixel weights must be equal to 1.0. So, the filter function must produce a graph of the proper shape.

filterrad : scalar, optional, default: 4.0

The filter radius for filters that have a radius parameter, i.e. when interpolation is one of: 'sinc', 'lanczos' or 'blackman'

Returns image : *AxesImage*

Other Parameters kwargs : *Artist* properties.

See also:

imshow Plot a matrix or an array as an image.

Notes

Unless *extent* is used, pixel centers will be located at integer coordinates. In other words: the origin will coincide with the center of pixel (0, 0).

Examples

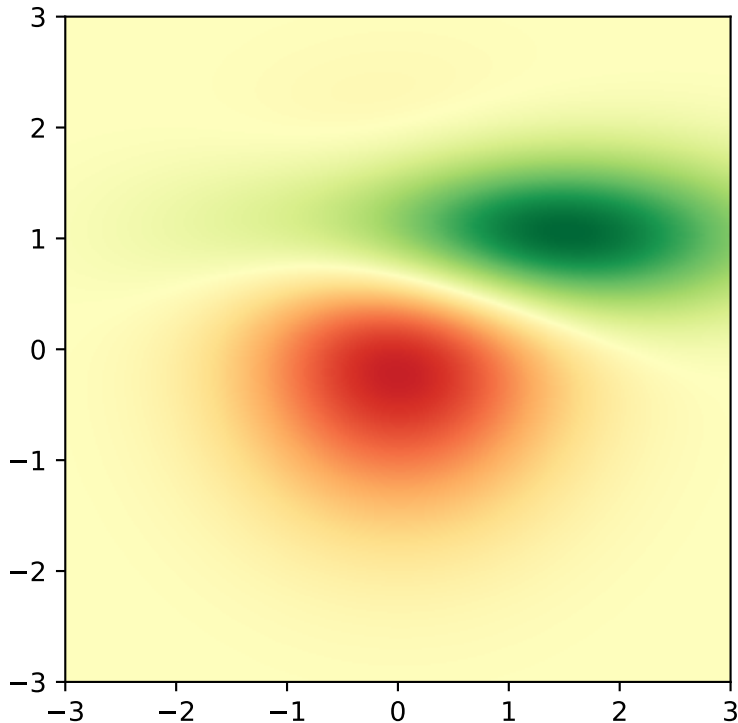

Note: In addition to the above described arguments, this function can take a **data** keyword argument. If such a **data** argument is given, the following arguments are replaced by **data[<arg>]**:

- All positional and all keyword arguments.
-

matplotlib.axes.Axes.imshow

`Axes.imshow(Z, **kwargs)`

Plot a matrix or array as an image.

The matrix will be shown the way it would be printed, with the first row at the top. Row and column numbering is zero-based.

Parameters Z : array_like shape (n, m)

The matrix to be displayed.

Returns image : *AxesImage*

Other Parameters kwargs : *imshow* arguments

Sets origin to 'upper', 'interpolation' to 'nearest' and 'aspect' to equal.

See also:

[*imshow*](#) plot an image

Examples

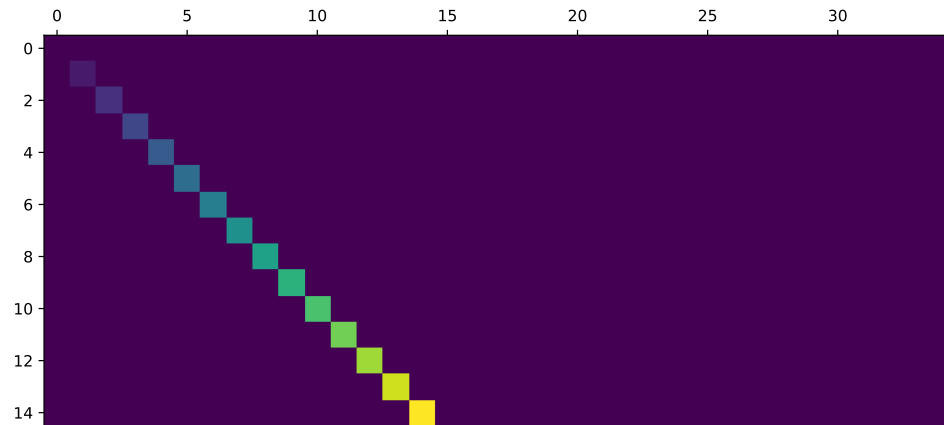

matplotlib.axes.Axes.pcolor

`Axes.pcolor(*args, **kwargs)`

Create a pseudocolor plot of a 2-D array.

Note: `pcolor` can be very slow for large arrays; consider using the similar but much faster [`pcolormesh\(\)`](#) instead.

Call signatures:

```
pcolor(C, **kwargs)
pcolor(X, Y, C, **kwargs)
```

`C` is the array of color values.

`X` and `Y`, if given, specify the (x, y) coordinates of the colored quadrilaterals; the quadrilateral for `C[i,j]` has corners at:

```
(X[i, j], Y[i, j]),
(X[i, j+1], Y[i, j+1]),
(X[i+1, j], Y[i+1, j]),
(X[i+1, j+1], Y[i+1, j+1]).
```

Ideally the dimensions of X and Y should be one greater than those of C ; if the dimensions are the same, then the last row and column of C will be ignored.

Note that the column index corresponds to the x -coordinate, and the row index corresponds to y ; for details, see the *Grid Orientation* section below.

If either or both of X and Y are 1-D arrays or column vectors, they will be expanded as needed into the appropriate 2-D arrays, making a rectangular grid.

X , Y and C may be masked arrays. If either $C[i, j]$, or one of the vertices surrounding $C[i, j]$ (X or Y at $[i, j]$, $[i+1, j]$, $[i, j+1]$, $[i+1, j+1]$) is masked, nothing is plotted.

Keyword arguments:

cmap: [*None* | **Colormap**] A `matplotlib.colors.Colormap` instance. If *None*, use rc settings.

norm: [*None* | **Normalize**] An `matplotlib.colors.Normalize` instance is used to scale luminance data to 0,1. If *None*, defaults to `normalize()`.

vmin/vmax: [*None* | **scalar**] *vmin* and *vmax* are used in conjunction with *norm* to normalize luminance data. If either is *None*, it is autoscaled to the respective min or max of the color array C . If not *None*, *vmin* or *vmax* passed in here override any pre-existing values supplied in the *norm* instance.

shading: [**'flat'** | **'faceted'**] If **'faceted'**, a black grid is drawn around each rectangle; if **'flat'**, edges are not drawn. Default is **'flat'**, contrary to MATLAB.

This kwarg is deprecated; please use 'edgecolors' instead:

- `shading='flat' – edgecolors='none'`
- `shading='faceted – edgecolors='k'`

edgecolors: [*None* | **'none'** | **color** | **color sequence**] If *None*, the rc setting is used by default.

If **'none'**, edges will not be visible.

An mpl color or sequence of colors will set the edge color

alpha: **0** <= **scalar** <= **1** or *None* the alpha blending value

snap: **bool** Whether to snap the mesh to pixel boundaries.

Return value is a `matplotlib.collections.Collection` instance. The grid orientation follows the MATLAB convention: an array C with shape (*nrows*, *ncolumns*) is plotted with the column number as X and the row number as Y , increasing up; hence it is plotted the way the array would be printed, except that the Y axis is reversed. That is, C is taken as $C^*(y, x)$.

Similarly for `meshgrid()`:

```
x = np.arange(5)
y = np.arange(3)
X, Y = np.meshgrid(x, y)
```

is equivalent to:

```
X = array([[0, 1, 2, 3, 4],
          [0, 1, 2, 3, 4],
          [0, 1, 2, 3, 4]])

Y = array([[0, 0, 0, 0, 0],
          [1, 1, 1, 1, 1],
          [2, 2, 2, 2, 2]])
```

so if you have:

```
C = rand(len(x), len(y))
```

then you need to transpose C:

```
pcolor(X, Y, C.T)
```

or:

```
pcolor(C.T)
```

MATLAB `pcolor()` always discards the last row and column of *C*, but matplotlib displays the last row and column if *X* and *Y* are not specified, or if *X* and *Y* have one more row and column than *C*.

kwargs can be used to control the *PolyCollection* properties:

Property	Description
<code>agg_filter</code>	unknown
<code>alpha</code>	float or None
<code>animated</code>	[True False]
<code>antialiased</code> or <code>antialiaseds</code>	Boolean or sequence of booleans
<code>array</code>	unknown
<code>axes</code>	an <i>Axes</i> instance
<code>clim</code>	a length 2 sequence of floats
<code>clip_box</code>	a <i>matplotlib.transforms.Bbox</i> instance
<code>clip_on</code>	[True False]
<code>clip_path</code>	[(<i>Path</i> , <i>Transform</i>) <i>Patch</i> None]
<code>cmap</code>	a colormap or registered colormap name
<code>color</code>	matplotlib color arg or sequence of rgba tuples
<code>contains</code>	a callable function
<code>edgecolor</code> or <code>edgecolors</code>	matplotlib color spec or sequence of specs
<code>facecolor</code> or <code>facecolors</code>	matplotlib color spec or sequence of specs
<code>figure</code>	a <i>matplotlib.figure.Figure</i> instance
<code>gid</code>	an id string
<code>hatch</code>	['/' '\' ' ' '-' '+' 'x' 'o' 'O' '.' '*']
<code>label</code>	string or anything printable with '%s' conversion.
<code>linestyle</code> or <code>dashes</code> or <code>linestyles</code>	['solid' 'dashed', 'dashdot', 'dotted' (offset, on-off-dash-seq) '- ' '-- ' '-. ' ...]
<code>linewidth</code> or <code>linewidths</code> or <code>lw</code>	float or sequence of floats
<code>norm</code>	unknown

Table 19.29 – continued from previous page

Property	Description
<code>offset_position</code>	unknown
<code>offsets</code>	float or sequence of floats
<code>path_effects</code>	unknown
<code>picker</code>	[None float boolean callable]
<code>pickradius</code>	unknown
<code>rasterized</code>	[True False None]
<code>sketch_params</code>	unknown
<code>snap</code>	unknown
<code>transform</code>	<i>Transform</i> instance
<code>url</code>	a url string
<code>urls</code>	unknown
<code>visible</code>	[True False]
<code>zorder</code>	any number

Note: The default *antialiaseds* is False if the default *edgecolors* is “none”. This eliminates artificial lines at patch boundaries, and works regardless of the value of *alpha*. If *edgecolors* is not “none”, then the default *antialiaseds* is taken from `rcParams['patch.antialiased']`, which defaults to True. Stroking the edges may be preferred if *alpha* is 1, but will cause artifacts otherwise.

See also:

[`pcolormesh\(\)`](#) For an explanation of the differences between `pcolor` and `pcolormesh`.

Note: In addition to the above described arguments, this function can take a **data** keyword argument. If such a **data** argument is given, the following arguments are replaced by **data[<arg>]**:

- All positional and all keyword arguments.
-

matplotlib.axes.Axes.pcolorfast

`Axes.pcolorfast(*args, **kwargs)`
 pseudocolor plot of a 2-D array

Experimental; this is a `pcolor`-type method that provides the fastest possible rendering with the Agg backend, and that can handle any quadrilateral grid. It supports only flat shading (no outlines), it lacks support for log scaling of the axes, and it does not have a `pyplot` wrapper.

Call signatures:

```
ax.pcolorfast(C, **kwargs)
ax.pcolorfast(xr, yr, C, **kwargs)
ax.pcolorfast(x, y, C, **kwargs)
ax.pcolorfast(X, Y, C, **kwargs)
```

C is the 2D array of color values corresponding to quadrilateral cells. Let (nr, nc) be its shape. C may be a masked array.

`ax.pcolorfast(C, **kwargs)` is equivalent to `ax.pcolorfast([0,nc], [0,nr], C, **kwargs)`

xr, yr specify the ranges of x and y corresponding to the rectangular region bounding C . If:

```
xr = [x0, x1]
```

and:

```
yr = [y0, y1]
```

then x goes from $x0$ to $x1$ as the second index of C goes from 0 to nc , etc. $(x0, y0)$ is the outermost corner of cell $(0,0)$, and $(x1, y1)$ is the outermost corner of cell $(nr-1, nc-1)$. All cells are rectangles of the same size. This is the fastest version.

x, y are monotonic 1D arrays of length $nc + 1$ and $nr + 1$, respectively, giving the x and y boundaries of the cells. Hence the cells are rectangular but the grid may be nonuniform. The speed is intermediate. (The grid is checked, and if found to be uniform the fast version is used.)

X and Y are 2D arrays with shape $(nr + 1, nc + 1)$ that specify the (x,y) coordinates of the corners of the colored quadrilaterals; the quadrilateral for $C[i,j]$ has corners at $(X[i,j], Y[i,j])$, $(X[i,j+1], Y[i,j+1])$, $(X[i+1,j], Y[i+1,j])$, $(X[i+1,j+1], Y[i+1,j+1])$. The cells need not be rectangular. This is the most general, but the slowest to render. It may produce faster and more compact output using ps, pdf, and svg backends, however.

Note that the column index corresponds to the x -coordinate, and the row index corresponds to y ; for details, see [Grid Orientation](#).

Optional keyword arguments:

cmap: [*None* | **Colormap**] A `matplotlib.colors.Colormap` instance from `cm`. If *None*, use rc settings.

norm: [*None* | **Normalize**] A `matplotlib.colors.Normalize` instance is used to scale luminance data to 0,1. If *None*, defaults to `normalize()`

vmin/vmax: [*None* | **scalar**] *vmin* and *vmax* are used in conjunction with `norm` to normalize luminance data. If either are *None*, the min and max of the color array C is used. If you pass a `norm` instance, *vmin* and *vmax* will be *None*.

alpha: 0 <= **scalar** <= 1 or *None* the alpha blending value

Return value is an image if a regular or rectangular grid is specified, and a [QuadMesh](#) collection in the general quadrilateral case.

Note: In addition to the above described arguments, this function can take a **data** keyword argument. If such a **data** argument is given, the following arguments are replaced by **data[<arg>]**:

- All positional and all keyword arguments.
-

matplotlib.axes.Axes.pcolormesh

Axes.pcolormesh(*args, **kwargs)

Plot a quadrilateral mesh.

Call signatures:

```
pcolormesh(C)
pcolormesh(X, Y, C)
pcolormesh(C, **kwargs)
```

Create a pseudocolor plot of a 2-D array.

pcolormesh is similar to *pcolor()*, but uses a different mechanism and returns a different object; pcolor returns a *PolyCollection* but pcolormesh returns a *QuadMesh*. It is much faster, so it is almost always preferred for large arrays.

C may be a masked array, but *X* and *Y* may not. Masked array support is implemented via *cmap* and *norm*; in contrast, *pcolor()* simply does not draw quadrilaterals with masked colors or vertices.

Keyword arguments:

cmap: [*None* | **Colormap**] A *matplotlib.colors.Colormap* instance. If *None*, use rc settings.

norm: [*None* | **Normalize**] A *matplotlib.colors.Normalize* instance is used to scale luminance data to 0,1. If *None*, defaults to *normalize()*.

vmin/vmax: [*None* | **scalar**] *vmin* and *vmax* are used in conjunction with *norm* to normalize luminance data. If either is *None*, it is autoscaled to the respective min or max of the color array *C*. If not *None*, *vmin* or *vmax* passed in here override any pre-existing values supplied in the *norm* instance.

shading: [**'flat'** | **'gouraud'**] 'flat' indicates a solid color for each quad. When 'gouraud', each quad will be Gouraud shaded. When gouraud shading, *edgecolors* is ignored.

edgecolors: [*None* | **'None'** | **'face'** | **color** |
color sequence]

If *None*, the rc setting is used by default.

If **'None'**, edges will not be visible.

If **'face'**, edges will have the same color as the faces.

An mpl color or sequence of colors will set the edge color

alpha: 0 <= **scalar** <= 1 or *None* the alpha blending value

Return value is a `matplotlib.collections.QuadMesh` object.

kwargs can be used to control the `matplotlib.collections.QuadMesh` properties:

Property	Description
<code>agg_filter</code>	unknown
<code>alpha</code>	float or None
<code>animated</code>	[True False]
<code>antialiased</code> or <code>antialiaseds</code>	Boolean or sequence of booleans
<code>array</code>	unknown
<code>axes</code>	an <code>Axes</code> instance
<code>clim</code>	a length 2 sequence of floats
<code>clip_box</code>	a <code>matplotlib.transforms.Bbox</code> instance
<code>clip_on</code>	[True False]
<code>clip_path</code>	[(<code>Path</code> , <code>Transform</code>) <code>Patch</code> None]
<code>cmap</code>	a colormap or registered colormap name
<code>color</code>	matplotlib color arg or sequence of rgba tuples
<code>contains</code>	a callable function
<code>edgecolor</code> or <code>edgecolors</code>	matplotlib color spec or sequence of specs
<code>facecolor</code> or <code>facecolors</code>	matplotlib color spec or sequence of specs
<code>figure</code>	a <code>matplotlib.figure.Figure</code> instance
<code>gid</code>	an id string
<code>hatch</code>	['/' '\' ' ' '-' '+' 'x' 'o' 'O' '.' '*']
<code>label</code>	string or anything printable with '%s' conversion.
<code>linestyle</code> or <code>dashes</code> or <code>linestyles</code>	['solid' 'dashed', 'dashdot', 'dotted' (offset, on-off-dash-seq) '-' '--' '-.]
<code>linewidth</code> or <code>linewidths</code> or <code>lw</code>	float or sequence of floats
<code>norm</code>	unknown
<code>offset_position</code>	unknown
<code>offsets</code>	float or sequence of floats
<code>path_effects</code>	unknown
<code>picker</code>	[None float boolean callable]
<code>pickradius</code>	unknown
<code>rasterized</code>	[True False None]
<code>sketch_params</code>	unknown
<code>snap</code>	unknown
<code>transform</code>	<code>Transform</code> instance
<code>url</code>	a url string
<code>urls</code>	unknown
<code>visible</code>	[True False]
<code>zorder</code>	any number

See also:

`pcolor()` For an explanation of the grid orientation (*Grid Orientation*) and the expansion of 1-D *X* and/or *Y* to 2-D arrays.

Note: In addition to the above described arguments, this function can take a **data** keyword argument. If such a **data** argument is given, the following arguments are replaced by **data[<arg>]**:

- All positional and all keyword arguments.
-

matplotlib.axes.Axes.spy

`Axes.spy(Z, precision=0, marker=None, markersize=None, aspect='equal', origin='upper', **kwargs)`

Plot the sparsity pattern on a 2-D array.

`spy(Z)` plots the sparsity pattern of the 2-D array `Z`.

Parameters `Z` : sparse array (n, m)

The array to be plotted.

precision : float, optional, default: 0

If *precision* is 0, any non-zero value will be plotted; else, values of $|Z| > precision$ will be plotted.

For `scipy.sparse.spmatrix` instances, there is a special case: if *precision* is 'present', any value present in the array will be plotted, even if it is identically zero.

origin : ['upper', 'lower'], optional, default: "upper"

Place the [0,0] index of the array in the upper left or lower left corner of the axes.

aspect : ['auto' | 'equal' | scalar], optional, default: "equal"

If 'equal', and `extent` is `None`, changes the axes aspect ratio to match that of the image. If `extent` is not `None`, the axes aspect ratio is changed to match that of the extent.

If 'auto', changes the image aspect ratio to match that of the axes.

If `None`, default to `rc image.aspect` value.

Two plotting styles are available: image or marker. Both

are available for full arrays, but only the marker style

works for `:class:'scipy.sparse.spmatrix'` instances.

If `*marker*` and `*markersize*` are `*None*`, an image will be

returned and any remaining kwargs are passed to

`:func:'~matplotlib.pyplot.imshow'`; else, a

`:class:'~matplotlib.lines.Line2D'` object will be returned with

the value of marker determining the marker type, and any

remaining kwargs passed to the
:meth:~matplotlib.axes.Axes.plot method.

If **marker** and **markersize** are **None**, useful kwargs include:

cmap

alpha

See also:

imshow for image options.

plot for plotting options

19.1.8 Unstructured Triangles

<i>Axes.tripcolor</i>	Create a pseudocolor plot of an unstructured triangular grid.
<i>Axes.triplot</i>	Draw a unstructured triangular grid as lines and/or markers.
<i>Axes.tricontour</i>	Draw contours on an unstructured triangular grid.
<i>Axes.tricontourf</i>	Draw contours on an unstructured triangular grid.

matplotlib.axes.Axes.tripcolor

Axes.tripcolor(*args, **kwargs)

Create a pseudocolor plot of an unstructured triangular grid.

The triangulation can be specified in one of two ways; either:

```
tripcolor(triangulation, ...)
```

where *triangulation* is a *matplotlib.tri.Triangulation* object, or

```
tripcolor(x, y, ...)
tripcolor(x, y, triangles, ...)
tripcolor(x, y, triangles=triangles, ...)
tripcolor(x, y, mask=mask, ...)
tripcolor(x, y, triangles, mask=mask, ...)
```

in which case a *Triangulation* object will be created. See *Triangulation* for a explanation of these possibilities.

The next argument must be *C*, the array of color values, either one per point in the triangulation if color values are defined at points, or one per triangle in the triangulation if color values are defined at triangles. If there are the same number of points and triangles in the triangulation it is assumed that color values are defined at points; to force the use of color values at triangles use the kwarg *facecolors*=C* instead of just **C*.

shading may be ‘flat’ (the default) or ‘gouraud’. If *shading* is ‘flat’ and *C* values are defined at points, the color values used for each triangle are from the mean *C* of the triangle’s three points. If *shading* is ‘gouraud’ then color values must be defined at points.

The remaining kwargs are the same as for `pcolor()`.

Example:

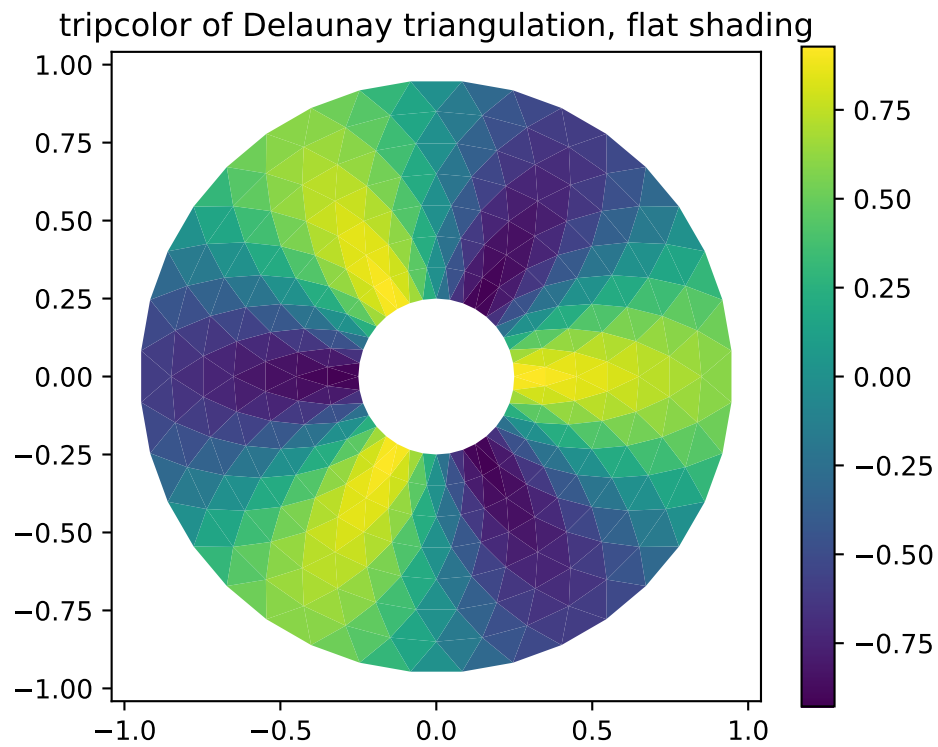

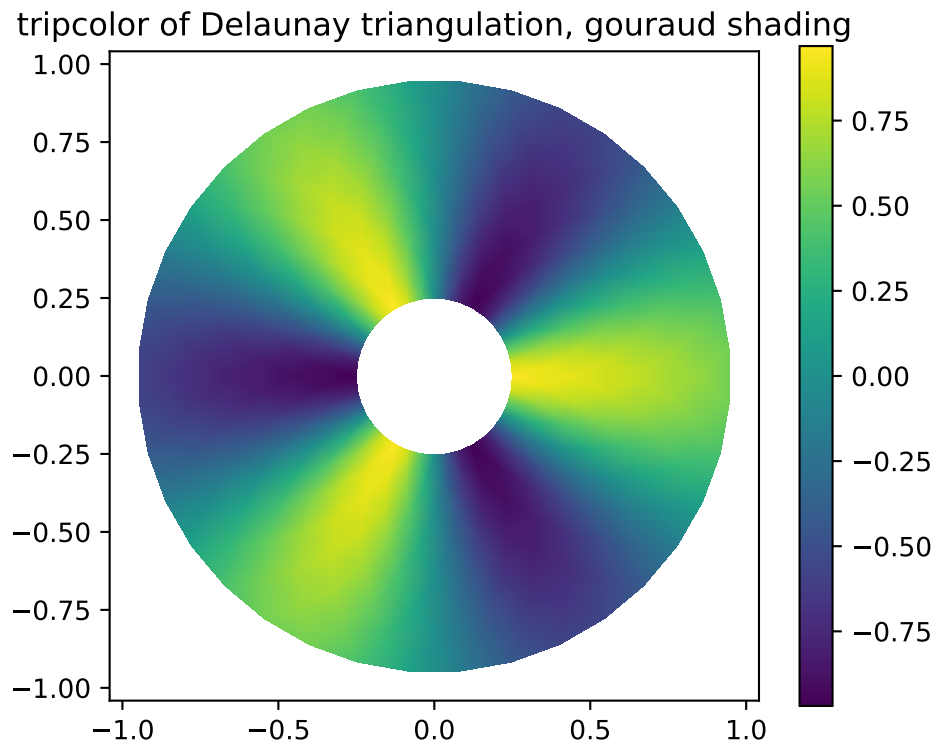

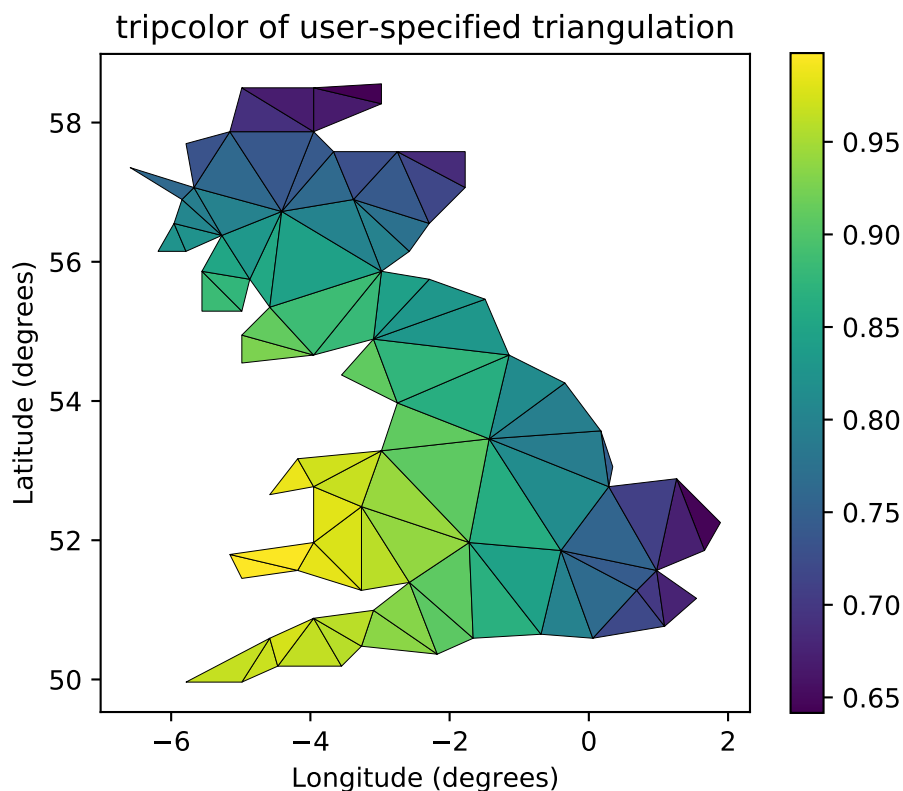

matplotlib.axes.Axes.triplot

Axes.**triplot**(*args, **kwargs)

Draw a unstructured triangular grid as lines and/or markers.

The triangulation to plot can be specified in one of two ways; either:

```
triplot(triangulation, ...)
```

where triangulation is a `matplotlib.tri.Triangulation` object, or

```
triplot(x, y, ...)
triplot(x, y, triangles, ...)
triplot(x, y, triangles=triangles, ...)
triplot(x, y, mask=mask, ...)
triplot(x, y, triangles, mask=mask, ...)
```

in which case a `Triangulation` object will be created. See [Triangulation](#) for a explanation of these possibilities.

The remaining args and kwargs are the same as for `plot()`.

Return a list of 2 `Line2D` containing respectively:

- the lines plotted for triangles edges

- the markers plotted for triangles nodes

Example:

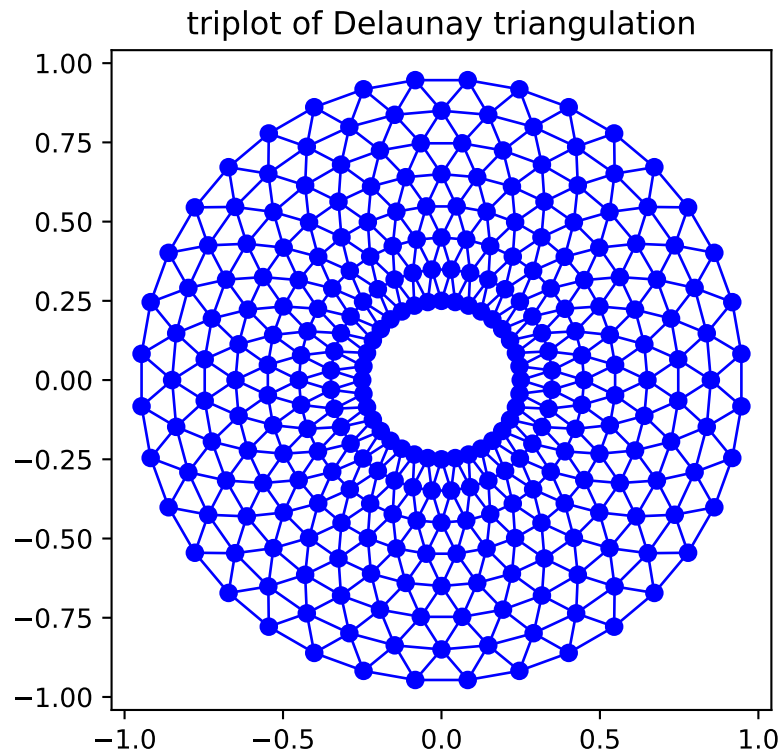

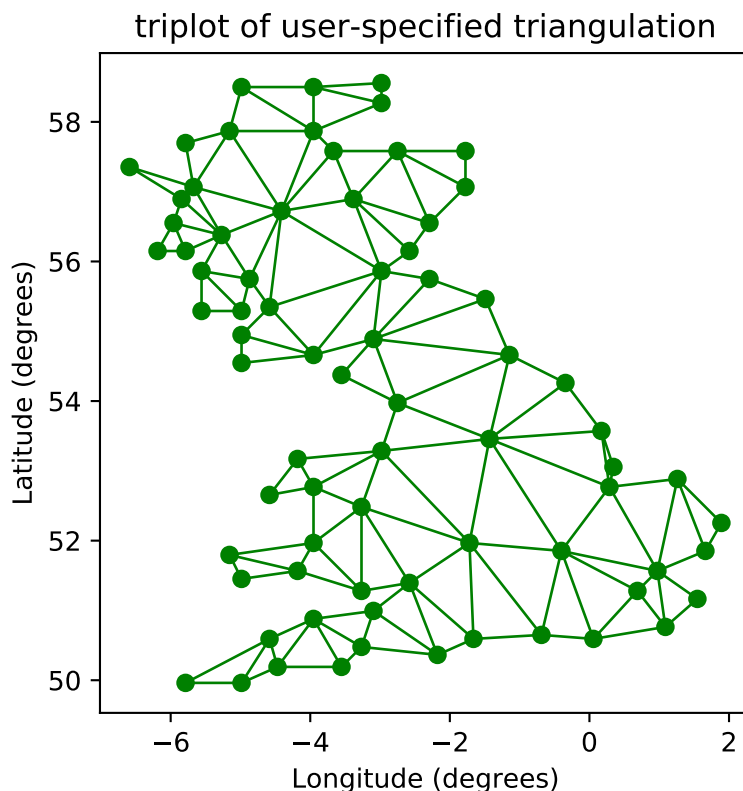

matplotlib.axes.Axes.tricontour

Axes.tricontour(*args, **kwargs)

Draw contours on an unstructured triangular grid. *tricontour()* and *tricontourf()* draw contour lines and filled contours, respectively. Except as noted, function signatures and return values are the same for both versions.

The triangulation can be specified in one of two ways; either:

```
tricontour(triangulation, ...)
```

where triangulation is a *matplotlib.tri.Triangulation* object, or

```
tricontour(x, y, ...)
tricontour(x, y, triangles, ...)
tricontour(x, y, triangles=triangles, ...)
tricontour(x, y, mask=mask, ...)
tricontour(x, y, triangles, mask=mask, ...)
```

in which case a Triangulation object will be created. See *Triangulation* for an explanation of these possibilities.

The remaining arguments may be:

```
tricontour(..., Z)
```

where Z is the array of values to contour, one per point in the triangulation. The level values are chosen automatically.

```
tricontour(..., Z, N)
```

contour N automatically-chosen levels.

```
tricontour(..., Z, V)
```

draw contour lines at the values specified in sequence V , which must be in increasing order.

```
tricontourf(..., Z, V)
```

fill the $(\text{len}(V)-1)$ regions between the values in V , which must be in increasing order.

```
tricontour(Z, **kwargs)
```

Use keyword args to control colors, linewidth, origin, cmap ... see below for more details.

$C = \text{tricontour}(\dots)$ returns a `TriContourSet` object.

Optional keyword arguments:

colors: [*None* | string | (mpl_colors)] If *None*, the colormap specified by `cmap` will be used.

If a string, like 'r' or 'red', all levels will be plotted in this color.

If a tuple of matplotlib color args (string, float, rgb, etc), different levels will be plotted in different colors in the order specified.

alpha: float The alpha blending value

cmap: [*None* | Colormap] A cm `Colormap` instance or *None*. If `cmap` is *None* and `colors` is *None*, a default `Colormap` is used.

norm: [*None* | Normalize] A `matplotlib.colors.Normalize` instance for scaling data values to colors. If `norm` is *None* and `colors` is *None*, the default linear scaling is used.

levels [level0, level1, ..., leveln] A list of floating point numbers indicating the level curves to draw, in increasing order; e.g., to draw just the zero contour pass `levels=[0]`

origin: [*None* | 'upper' | 'lower' | 'image'] If *None*, the first value of Z will correspond to the lower left corner, location (0,0). If 'image', the rc value for `image.origin` will be used.

This keyword is not active if X and Y are specified in the call to contour.

extent: [*None* | (x0,x1,y0,y1)]

If `origin` is not *None*, then `extent` is interpreted as in `matplotlib.pyplot.imshow()`: it gives the outer pixel boundaries. In this case, the position of $Z[0,0]$

is the center of the pixel, not a corner. If *origin* is *None*, then $(x0, y0)$ is the position of $Z[0,0]$, and $(x1, y1)$ is the position of $Z[-1,-1]$.

This keyword is not active if *X* and *Y* are specified in the call to `contour`.

locator: [*None* | `ticker.Locator` subclass] If *locator* is *None*, the default `MaxNLocator` is used. The locator is used to determine the contour levels if they are not given explicitly via the *V* argument.

extend: ['neither' | 'both' | 'min' | 'max'] Unless this is 'neither', contour levels are automatically added to one or both ends of the range so that all data are included. These added ranges are then mapped to the special colormap values which default to the ends of the colormap range, but can be set via `matplotlib.colors.Colormap.set_under()` and `matplotlib.colors.Colormap.set_over()` methods.

xunits, yunits: [*None* | registered units] Override axis units by specifying an instance of a `matplotlib.units.ConversionInterface`.

tricontour-only keyword arguments:

linewidths: [*None* | number | tuple of numbers] If *linewidths* is *None*, the default width in lines. `linewidth` in `matplotlibrc` is used.

If a number, all levels will be plotted with this linewidth.

If a tuple, different levels will be plotted with different linewidths in the order specified

linestyles: [*None* | 'solid' | 'dashed' | 'dashdot' | 'dotted'] If *linestyles* is *None*, the 'solid' is used.

linestyles can also be an iterable of the above strings specifying a set of linestyles to be used. If this iterable is shorter than the number of contour levels it will be repeated as necessary.

If `contour` is using a monochrome colormap and the contour level is less than 0, then the linestyle specified in `contour.negative_linestyle` in `matplotlibrc` will be used.

tricontourf-only keyword arguments:

antialiased: [*True* | *False*] enable antialiasing

Note: `tricontourf` fills intervals that are closed at the top; that is, for boundaries $z1$ and $z2$, the filled region is:

$$z1 < z \leq z2$$

There is one exception: if the lowest boundary coincides with the minimum value of the z array, then that minimum value will be included in the lowest interval.

Examples:

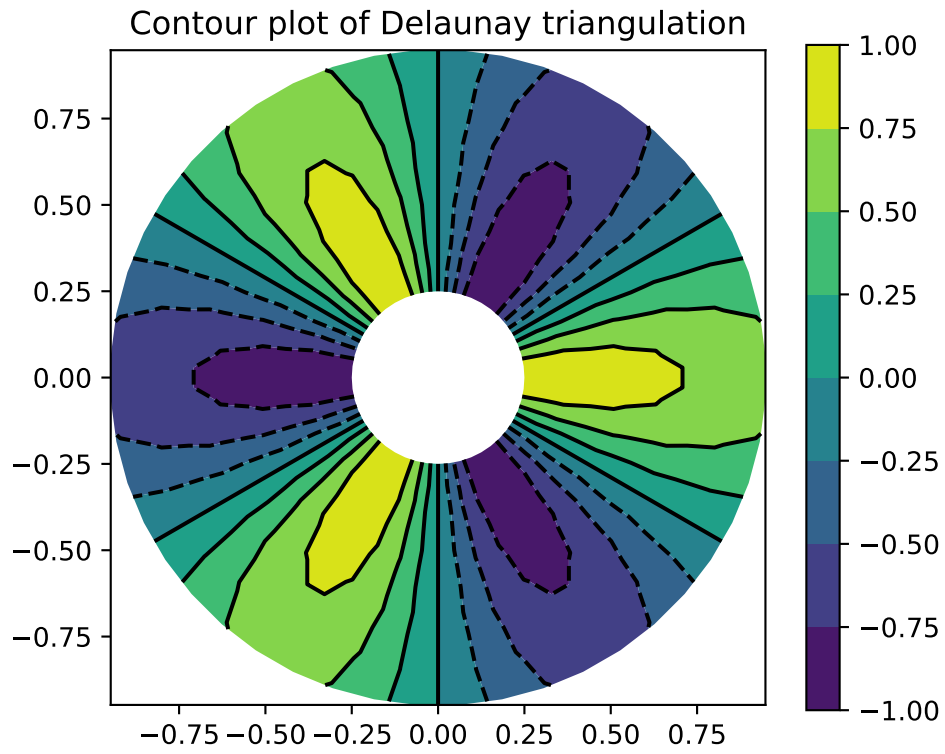

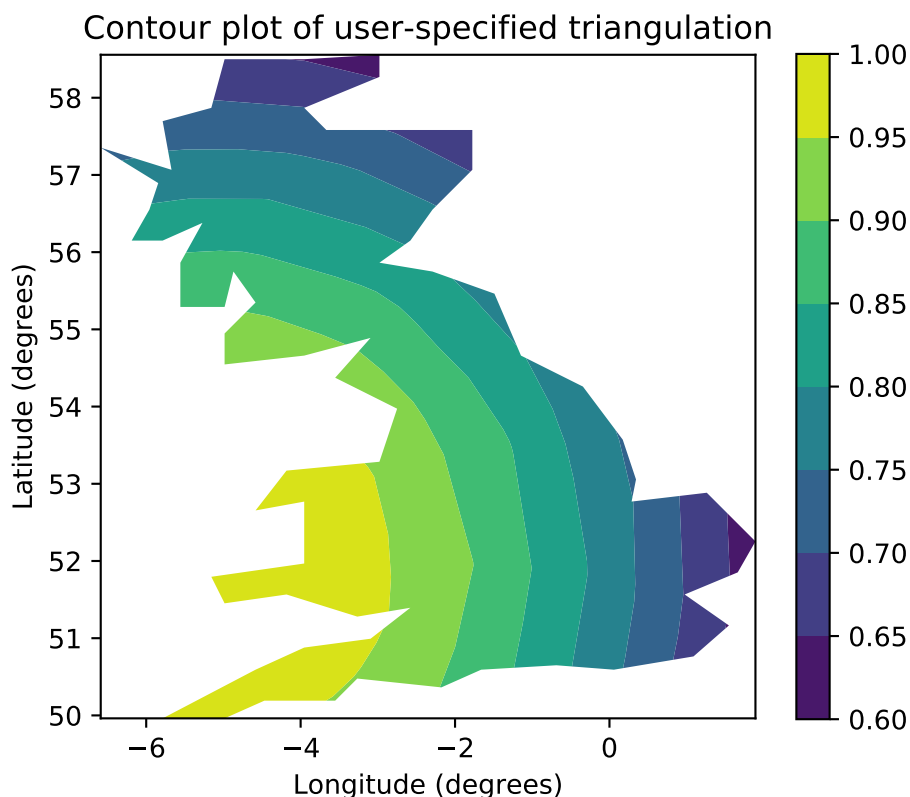

matplotlib.axes.Axes.tricontourf

Axes.tricontourf(*args, **kwargs)

Draw contours on an unstructured triangular grid. *tricontour()* and *tricontourf()* draw contour lines and filled contours, respectively. Except as noted, function signatures and return values are the same for both versions.

The triangulation can be specified in one of two ways; either:

```
tricontour(triangulation, ...)
```

where triangulation is a *matplotlib.tri.Triangulation* object, or

```
tricontour(x, y, ...)
tricontour(x, y, triangles, ...)
tricontour(x, y, triangles=triangles, ...)
tricontour(x, y, mask=mask, ...)
tricontour(x, y, triangles, mask=mask, ...)
```

in which case a Triangulation object will be created. See *Triangulation* for an explanation of these possibilities.

The remaining arguments may be:

```
tricontour(..., Z)
```

where Z is the array of values to contour, one per point in the triangulation. The level values are chosen automatically.

```
tricontour(..., Z, N)
```

contour N automatically-chosen levels.

```
tricontour(..., Z, V)
```

draw contour lines at the values specified in sequence V , which must be in increasing order.

```
tricontourf(..., Z, V)
```

fill the $(\text{len}(V)-1)$ regions between the values in V , which must be in increasing order.

```
tricontour(Z, **kwargs)
```

Use keyword args to control colors, linewidth, origin, cmap ... see below for more details.

$C = \text{tricontour}(\dots)$ returns a `TriContourSet` object.

Optional keyword arguments:

colors: [*None* | string | (mpl_colors)] If *None*, the colormap specified by `cmap` will be used.

If a string, like 'r' or 'red', all levels will be plotted in this color.

If a tuple of matplotlib color args (string, float, rgb, etc), different levels will be plotted in different colors in the order specified.

alpha: float The alpha blending value

cmap: [*None* | Colormap] A `cm.Colormap` instance or *None*. If `cmap` is *None* and `colors` is *None*, a default `Colormap` is used.

norm: [*None* | Normalize] A `matplotlib.colors.Normalize` instance for scaling data values to colors. If `norm` is *None* and `colors` is *None*, the default linear scaling is used.

levels [level0, level1, ..., leveln] A list of floating point numbers indicating the level curves to draw, in increasing order; e.g., to draw just the zero contour pass `levels=[0]`

origin: [*None* | 'upper' | 'lower' | 'image'] If *None*, the first value of Z will correspond to the lower left corner, location (0,0). If 'image', the `rc` value for `image.origin` will be used.

This keyword is not active if X and Y are specified in the call to `contour`.

extent: [*None* | (x0,x1,y0,y1)]

If `origin` is not *None*, then `extent` is interpreted as in `matplotlib.pyplot.imshow()`: it gives the outer pixel boundaries. In this case, the position of $Z[0,0]$

is the center of the pixel, not a corner. If *origin* is *None*, then $(x0, y0)$ is the position of $Z[0,0]$, and $(x1, y1)$ is the position of $Z[-1,-1]$.

This keyword is not active if *X* and *Y* are specified in the call to `contour`.

locator: [*None* | `ticker.Locator` subclass] If *locator* is *None*, the default `MaxNLocator` is used. The locator is used to determine the contour levels if they are not given explicitly via the *V* argument.

extend: [`'neither'` | `'both'` | `'min'` | `'max'`] Unless this is `'neither'`, contour levels are automatically added to one or both ends of the range so that all data are included. These added ranges are then mapped to the special colormap values which default to the ends of the colormap range, but can be set via `matplotlib.colors.Colormap.set_under()` and `matplotlib.colors.Colormap.set_over()` methods.

xunits, yunits: [*None* | registered units] Override axis units by specifying an instance of a `matplotlib.units.ConversionInterface`.

tricontour-only keyword arguments:

linewidths: [*None* | number | tuple of numbers] If *linewidths* is *None*, the default width in lines. `linewidth` in `matplotlibrc` is used.

If a number, all levels will be plotted with this linewidth.

If a tuple, different levels will be plotted with different linewidths in the order specified

linestyles: [*None* | `'solid'` | `'dashed'` | `'dashdot'` | `'dotted'`] If *linestyles* is *None*, the `'solid'` is used.

linestyles can also be an iterable of the above strings specifying a set of linestyles to be used. If this iterable is shorter than the number of contour levels it will be repeated as necessary.

If `contour` is using a monochrome colormap and the contour level is less than 0, then the linestyle specified in `contour.negative_linestyle` in `matplotlibrc` will be used.

tricontourf-only keyword arguments:

antialiased: [*True* | *False*] enable antialiasing

Note: `tricontourf` fills intervals that are closed at the top; that is, for boundaries $z1$ and $z2$, the filled region is:

$$z1 < z \leq z2$$

There is one exception: if the lowest boundary coincides with the minimum value of the z array, then that minimum value will be included in the lowest interval.

Examples:

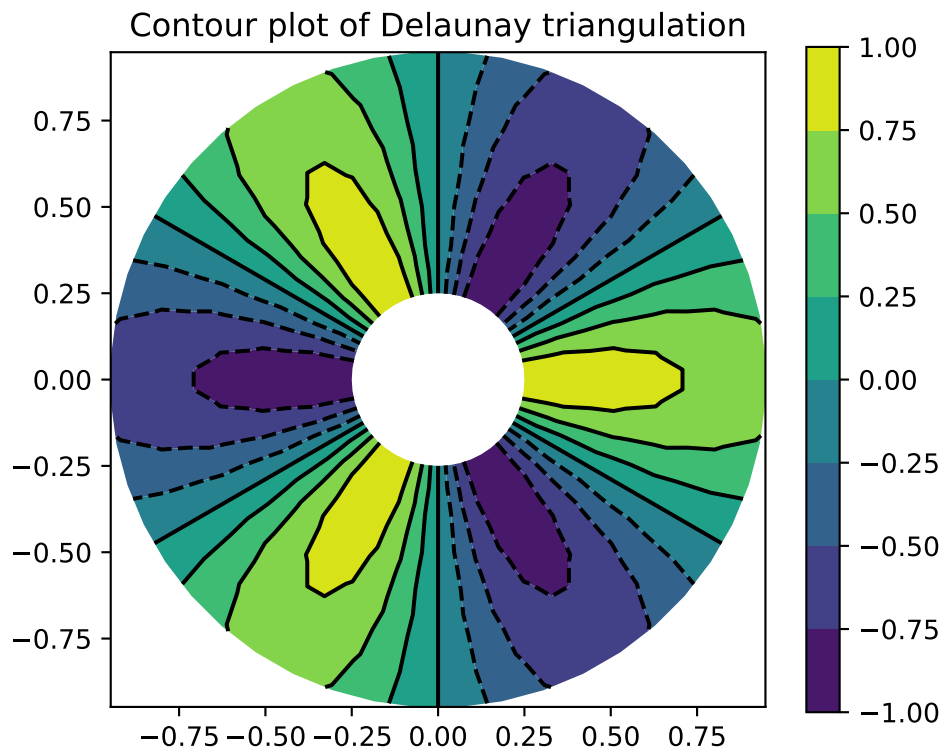

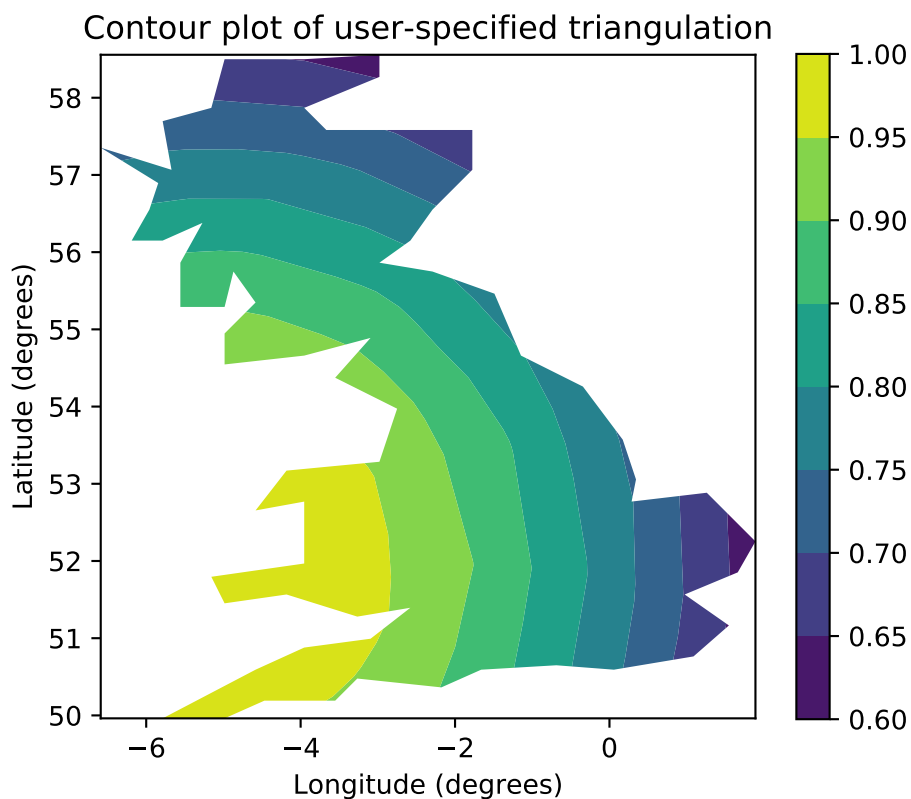

19.1.9 Text and Annotations

<code>Axes.annotate</code>	Annotate the point <code>xy</code> with text <code>s</code> .
<code>Axes.text</code>	Add text to the axes.
<code>Axes.table</code>	Add a table to the current axes.
<code>Axes.arrow</code>	Add an arrow to the axes.

`matplotlib.axes.Axes.annotate`

`Axes.annotate(*args, **kwargs)`

Annotate the point `xy` with text `s`.

Additional kwargs are passed to `Text`.

Parameters `s` : str

The text of the annotation

`xy` : iterable

Length 2 sequence specifying the (x,y) point to annotate

`xytext` : iterable, optional

Length 2 sequence specifying the (x,y) to place the text at. If None, defaults to xy .

xycoords : str, Artist, Transform, callable or tuple, optional

The coordinate system that xy is given in.

For a str the allowed values are:

Property	Description
'figure points'	points from the lower left of the figure
'figure pixels'	pixels from the lower left of the figure
'figure fraction'	fraction of figure from lower left
'axes points'	points from lower left corner of axes
'axes pixels'	pixels from lower left corner of axes
'axes fraction'	fraction of axes from lower left
'data'	use the coordinate system of the object being annotated (default)
'polar'	(θ,r) if not native 'data' coordinates

If a *Artist* object is passed in the units are fraction if it's bounding box.

If a *Transform* object is passed in use that to transform xy to screen coordinates

If a callable it must take a *RendererBase* object as input and return a *Transform* or *Bbox* object

If a tuple must be length 2 tuple of str, Artist, Transform or callable objects. The first transform is used for the x coordinate and the second for y .

See *Advanced Annotation* for more details.

Defaults to 'data'

textcoords : str, Artist, Transform, callable or tuple, optional

The coordinate system that $xytext$ is given, which may be different than the coordinate system used for xy .

All xycoords values are valid as well as the following strings:

Property	Description
'offset points'	offset (in points) from the xy value
'offset pixels'	offset (in pixels) from the xy value

defaults to the input of xycoords

arrowprops : dict, optional

If not None, properties used to draw a *FancyArrowPatch* arrow between xy and $xytext$.

If `arrowprops` does not contain the key `'arrowstyle'` the allowed keys are:

Key	Description
<code>width</code>	the width of the arrow in points
<code>headwidth</code>	the width of the base of the arrow head in points
<code>headlength</code>	the length of the arrow head in points
<code>shrink</code>	fraction of total length to 'shrink' from both ends
<code>?</code>	any key to matplotlib.patches.FancyArrowPatch

If the `arrowprops` contains the key `'arrowstyle'` the above keys are forbidden. The allowed values of `'arrowstyle'` are:

Name	Attrs
<code>'-'</code>	None
<code>'->'</code>	<code>head_length=0.4,head_width=0.2</code>
<code>'-['</code>	<code>widthB=1.0,lengthB=0.2,angleB=None</code>
<code>' -'</code>	<code>widthA=1.0,widthB=1.0</code>
<code>'- >'</code>	<code>head_length=0.4,head_width=0.2</code>
<code>'<-'</code>	<code>head_length=0.4,head_width=0.2</code>
<code>'<->'</code>	<code>head_length=0.4,head_width=0.2</code>
<code>'< -'</code>	<code>head_length=0.4,head_width=0.2</code>
<code>'< ->'</code>	<code>head_length=0.4,head_width=0.2</code>
<code>'fancy'</code>	<code>head_length=0.4,head_width=0.4,tail_width=0.4</code>
<code>'simple'</code>	<code>head_length=0.5,head_width=0.5,tail_width=0.2</code>
<code>'wedge'</code>	<code>tail_width=0.3,shrink_factor=0.5</code>

Valid keys for [FancyArrowPatch](#) are:

Key	Description
<code>arrowstyle</code>	the arrow style
<code>connectionstyle</code>	the connection style
<code>relpos</code>	default is (0.5, 0.5)
<code>patchA</code>	default is bounding box of the text
<code>patchB</code>	default is None
<code>shrinkA</code>	default is 2 points
<code>shrinkB</code>	default is 2 points
<code>mutation_scale</code>	default is text size (in points)
<code>mutation_aspect</code>	default is 1.
<code>?</code>	any key for matplotlib.patches.PathPatch

Defaults to None

annotation_clip : bool, optional

Controls the visibility of the annotation when it goes outside the axes area.

If `True`, the annotation will only be drawn when the `xy` is inside the axes. If `False`, the annotation will always be drawn regardless of its position.

The default is `None`, which behave as `True` only if `xycoords` is "data".

Returns Annotation

matplotlib.axes.Axes.text

Axes.text(*x, y, s, fontdict=None, withdash=False, **kwargs*)

Add text to the axes.

Add text in string *s* to axis at location *x, y*, data coordinates.

Parameters *x, y* : scalars

data coordinates

s : string

text

fontdict : dictionary, optional, default: None

A dictionary to override the default text properties. If *fontdict* is None, the defaults are determined by your rc parameters.

withdash : boolean, optional, default: False

Creates a *TextWithDash* instance instead of a *Text* instance.

Other Parameters *kwargs* : *Text* properties.

Other miscellaneous text parameters.

Examples

Individual keyword arguments can be used to override any given parameter:

```
>>> text(x, y, s, fontsize=12)
```

The default transform specifies that text is in data coords, alternatively, you can specify text in axis coords (0,0 is lower-left and 1,1 is upper-right). The example below places text in the center of the axes:

```
>>> text(0.5, 0.5, 'matplotlib', horizontalalignment='center',
...     verticalalignment='center',
...     transform=ax.transAxes)
```

You can put a rectangular box around the text instance (e.g., to set a background color) by using the keyword *bbox*. *bbox* is a dictionary of *Rectangle* properties. For example:

```
>>> text(x, y, s, bbox=dict(facecolor='red', alpha=0.5))
```

matplotlib.axes.Axes.table

Axes.table(***kwargs*)

Add a table to the current axes.

Call signature:

```
table(cellText=None, cellColours=None,
      cellLoc='right', colWidths=None,
      rowLabels=None, rowColours=None, rowLoc='left',
      colLabels=None, colColours=None, colLoc='center',
      loc='bottom', bbox=None):
```

Returns a `matplotlib.table.Table` instance. Either `cellText` or `cellColours` must be provided. For finer grained control over tables, use the `Table` class and add it to the axes with `add_table()`.

Thanks to John Gill for providing the class and table.

kwargs control the `Table` properties:

Property	Description
<code>agg_filter</code>	unknown
<code>alpha</code>	float (0.0 transparent through 1.0 opaque)
<code>animated</code>	[True False]
<code>axes</code>	an <code>Axes</code> instance
<code>clip_box</code>	a <code>matplotlib.transforms.Bbox</code> instance
<code>clip_on</code>	[True False]
<code>clip_path</code>	[(<code>Path</code> , <code>Transform</code>) <code>Patch</code> None]
<code>contains</code>	a callable function
<code>figure</code>	a <code>matplotlib.figure.Figure</code> instance
<code>fontsize</code>	a float in points
<code>gid</code>	an id string
<code>label</code>	string or anything printable with ‘%s’ conversion.
<code>path_effects</code>	unknown
<code>picker</code>	[None float boolean callable]
<code>rasterized</code>	[True False None]
<code>sketch_params</code>	unknown
<code>snap</code>	unknown
<code>transform</code>	<code>Transform</code> instance
<code>url</code>	a url string
<code>visible</code>	[True False]
<code>zorder</code>	any number

matplotlib.axes.Axes.arrow

`Axes.arrow(x, y, dx, dy, **kwargs)`

Add an arrow to the axes.

Draws arrow on specified axis from (x, y) to (x + dx, y + dy). Uses `FancyArrow` patch to construct the arrow.

Parameters `x` : float

X-coordinate of the arrow base

`y` : float

Y-coordinate of the arrow base

dx : float

Length of arrow along x-coordinate

dy : float

Length of arrow along y-coordinate

Returns a : FancyArrow

patches.FancyArrow object

Other Parameters Optional kwargs (inherited from FancyArrow patch) control the arrow

construction and properties:

Constructor arguments

width: float (default: 0.001) width of full arrow tail

length_includes_head: [True | False] (default: False) True if head is to be counted in calculating the length.

head_width: float or None (default: 3*width) total width of the full arrow head

head_length: float or None (default: 1.5 * head_width) length of arrow head

shape: ['full', 'left', 'right'] (default: 'full') draw the left-half, right-half, or full arrow

overhang: float (default: 0) fraction that the arrow is swept back (0 overhang means triangular shape). Can be negative or greater than one.

head_starts_at_zero: [True | False] (default: False) if True, the head starts being drawn at coordinate 0 instead of ending at coordinate 0.

Other valid kwargs (inherited from :class:'Patch') are:

Property	Description
<i>agg_filter</i>	unknown
<i>alpha</i>	float or None
<i>animated</i>	[True False]
<i>antialiased</i> or <i>aa</i>	[True False] or None for default
<i>axes</i>	an <i>Axes</i> instance
<i>capstyle</i>	['butt' 'round' 'projecting']
<i>clip_box</i>	a <i>matplotlib.transforms.Bbox</i> instance
<i>clip_on</i>	[True False]
<i>clip_path</i>	[(<i>Path</i> , <i>Transform</i>) <i>Patch</i> None]
<i>color</i>	matplotlib color spec
<i>contains</i>	a callable function

Continued on

Table 19.33 – continued from previous page

Property	Description
<i>edgecolor</i> or <i>ec</i>	mpl color spec, None, ‘none’, or ‘auto’
<i>facecolor</i> or <i>fc</i>	mpl color spec, or None for default, or ‘none’ for no color
<i>figure</i>	a <i>matplotlib.figure.Figure</i> instance
<i>fill</i>	[True False]
<i>gid</i>	an id string
<i>hatch</i>	[‘/’ ‘\’ ‘ ’ ‘-’ ‘+’ ‘x’ ‘o’ ‘O’ ‘.’ ‘*’]
<i>joinstyle</i>	[‘miter’ ‘round’ ‘bevel’]
<i>label</i>	string or anything printable with ‘%s’ conversion.
<i>linestyle</i> or <i>ls</i>	[‘solid’ ‘dashed’, ‘dashdot’, ‘dotted’ (offset, on-off-dash-seq) ‘-’ ‘--’ ‘-.’ ‘:’ ‘None’]
<i>linewidth</i> or <i>lw</i>	float or None for default
<i>path_effects</i>	unknown
<i>picker</i>	[None float boolean callable]
<i>rasterized</i>	[True False None]
<i>sketch_params</i>	unknown
<i>snap</i>	unknown
<i>transform</i>	<i>Transform</i> instance
<i>url</i>	a url string
<i>visible</i>	[True False]
<i>zorder</i>	any number

Notes

The resulting arrow is affected by the axes aspect ratio and limits. This may produce an arrow whose head is not square with its stem. To create an arrow whose head is square with its stem, use *annotate()* for example:

```
ax.annotate("", xy=(0.5, 0.5), xytext=(0, 0),
            arrowprops=dict(arrowstyle="->"))
```

Examples

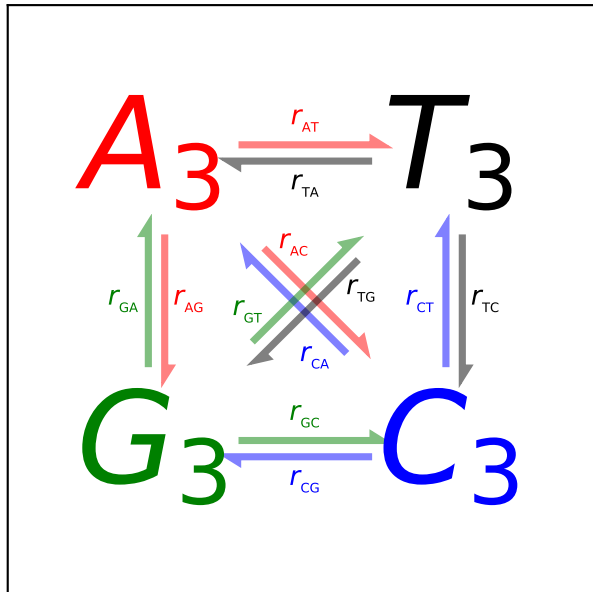

19.1.10 Fields

<code>Axes.barbs</code>	Plot a 2-D field of barbs.
<code>Axes.quiver</code>	Plot a 2-D field of arrows.
<code>Axes.quiverkey</code>	Add a key to a quiver plot.
<code>Axes.streamplot</code>	Draws streamlines of a vector flow.

`matplotlib.axes.Axes.barbs`

`Axes.barbs`(*args, **kw)

Plot a 2-D field of barbs.

Call signatures:

```
barb(U, V, **kw)
barb(U, V, C, **kw)
barb(X, Y, U, V, **kw)
barb(X, Y, U, V, C, **kw)
```

Arguments:

X, Y: The x and y coordinates of the barb locations (default is head of barb; see *pivot* kwarg)

U, V: Give the x and y components of the barb shaft

C: An optional array used to map colors to the barbs

All arguments may be 1-D or 2-D arrays or sequences. If *X* and *Y* are absent, they will be generated as a uniform grid. If *U* and *V* are 2-D arrays but *X* and *Y* are 1-D, and if `len(X)` and `len(Y)` match the column and row dimensions of *U*, then *X* and *Y* will be expanded with `numpy.meshgrid()`.

U, V, C may be masked arrays, but masked *X, Y* are not supported at present.

Keyword arguments:

length: Length of the barb in points; the other parts of the barb are scaled against this. Default is 9

pivot: [**'tip'** | **'middle'**] The part of the arrow that is at the grid point; the arrow rotates about this point, hence the name *pivot*. Default is 'tip'

barbcolor: [**color** | **color sequence**] Specifies the color all parts of the barb except any flags. This parameter is analagous to the *edgecolor* parameter for polygons, which can be used instead. However this parameter will override *facecolor*.

flagcolor: [**color** | **color sequence**] Specifies the color of any flags on the barb. This parameter is analagous to the *facecolor* parameter for polygons, which can be used instead. However this parameter will override *facecolor*. If this is not set (and *C* has not either) then *flagcolor* will be set to match *barbcolor* so that the barb has a uniform color. If *C* has been set, *flagcolor* has no effect.

sizes: A dictionary of coefficients specifying the ratio of a given feature to the length of the barb. Only those values one wishes to override need to be included. These features include:

- 'spacing' - space between features (flags, full/half barbs)
- 'height' - height (distance from shaft to top) of a flag or full barb
- 'width' - width of a flag, twice the width of a full barb
- 'emptybarb' - radius of the circle used for low magnitudes

fill_empty: A flag on whether the empty barbs (circles) that are drawn should be filled with the flag color. If they are not filled, they will be drawn such that no color is applied to the center. Default is False

rounding: A flag to indicate whether the vector magnitude should be rounded when allocating barb components. If True, the magnitude is rounded to the nearest multiple of the half-barb increment. If False, the magnitude is simply truncated to the next lowest multiple. Default is True

barb_increments: A dictionary of increments specifying values to associate with different parts of the barb. Only those values one wishes to override need to be included.

- 'half' - half barbs (Default is 5)
- 'full' - full barbs (Default is 10)
- 'flag' - flags (default is 50)

flip_barb: Either a single boolean flag or an array of booleans. Single boolean indicates whether the lines and flags should point opposite to normal for all barbs. An array (which should be the same size as the other data arrays) indicates whether to flip for each individual barb. Normal behavior is for the barbs and lines to point right (comes from wind barbs having these features point towards low pressure in the Northern Hemisphere.) Default is False

Barbs are traditionally used in meteorology as a way to plot the speed and direction of wind observations, but can technically be used to plot any two dimensional vector quantity. As opposed to arrows, which give vector magnitude by the length of the arrow, the barbs give more quantitative information about the vector magnitude by putting slanted lines or a triangle for various increments in magnitude, as show schematically below:



The largest increment is given by a triangle (or “flag”). After those come full lines (barbs). The smallest increment is a half line. There is only, of course, ever at most 1 half line. If the magnitude is small and only needs a single half-line and no full lines or triangles, the half-line is offset from the end of the barb so that it can be easily distinguished from barbs with a single full line. The magnitude for the barb shown above would nominally be 65, using the standard increments of 50, 10, and 5.

linewidths and edgecolors can be used to customize the barb. Additional *PolyCollection* keyword arguments:

Property	Description
<i>agg_filter</i>	unknown
<i>alpha</i>	float or None
<i>animated</i>	[True False]
<i>antialiased</i> or <i>antialiaseds</i>	Boolean or sequence of booleans
<i>array</i>	unknown
<i>axes</i>	an <i>Axes</i> instance
<i>clim</i>	a length 2 sequence of floats
<i>clip_box</i>	a <i>matplotlib.transforms.Bbox</i> instance
<i>clip_on</i>	[True False]
<i>clip_path</i>	[(<i>Path</i> , <i>Transform</i>) <i>Patch</i> None]
<i>cmap</i>	a colormap or registered colormap name
<i>color</i>	matplotlib color arg or sequence of rgba tuples
<i>contains</i>	a callable function
<i>edgecolor</i> or <i>edgecolors</i>	matplotlib color spec or sequence of specs
<i>facecolor</i> or <i>facecolors</i>	matplotlib color spec or sequence of specs
<i>figure</i>	a <i>matplotlib.figure.Figure</i> instance
<i>gid</i>	an id string
<i>hatch</i>	['/' '\' ' ' '-' '+' 'x' 'o' 'O' '.' '*']
<i>label</i>	string or anything printable with '%s' conversion.

Table 19.35 – continued from previous page

Property	Description
<i>linestyle</i> or dashes or linestyles	['solid' 'dashed', 'dashdot', 'dotted' (offset, on-off-dash-seq) '- ' '-- ' '-. ' ...]
<i>linewidth</i> or linewidths or lw	float or sequence of floats
<i>norm</i>	unknown
<i>offset_position</i>	unknown
<i>offsets</i>	float or sequence of floats
<i>path_effects</i>	unknown
<i>picker</i>	[None float boolean callable]
<i>pickradius</i>	unknown
<i>rasterized</i>	[True False None]
<i>sketch_params</i>	unknown
<i>snap</i>	unknown
<i>transform</i>	<i>Transform</i> instance
<i>url</i>	a url string
<i>urls</i>	unknown
<i>visible</i>	[True False]
<i>zorder</i>	any number

Example:

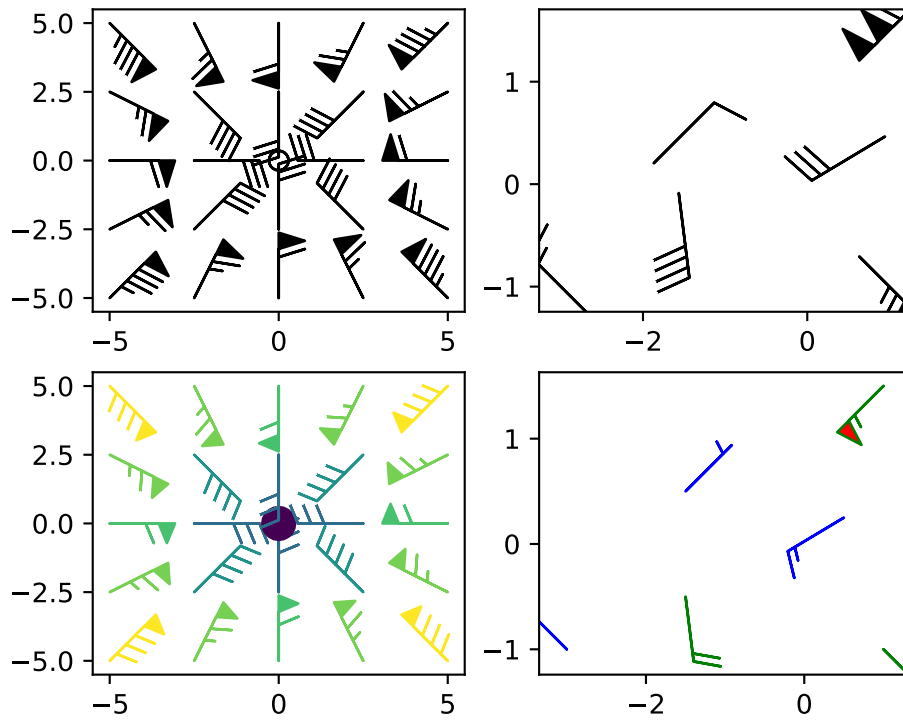

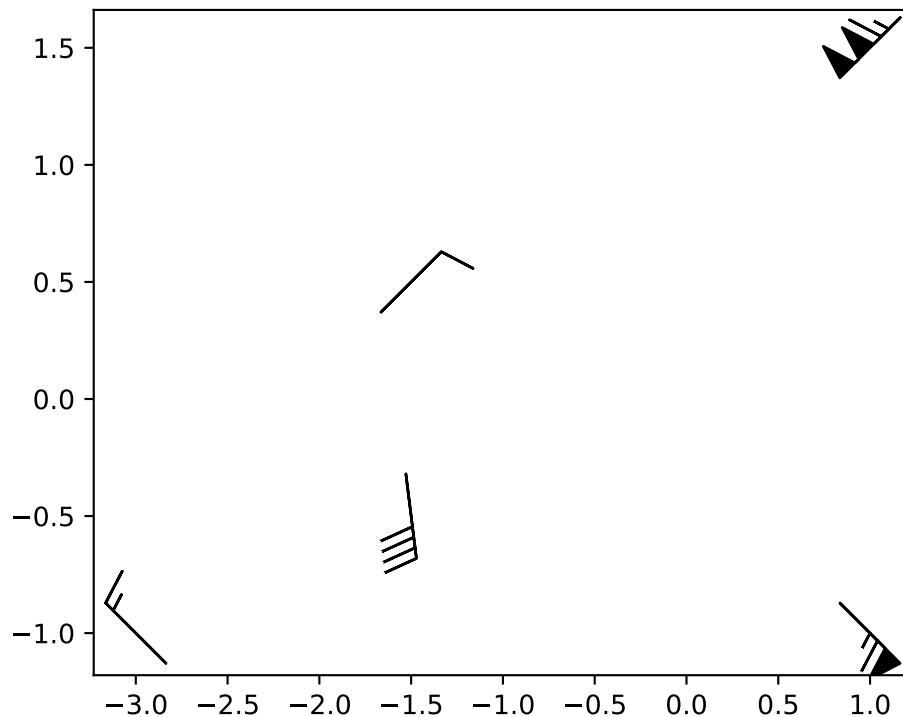

Note: In addition to the above described arguments, this function can take a **data** keyword argument. If such a **data** argument is given, the following arguments are replaced by **data[<arg>]**:

- All positional and all keyword arguments.
-

matplotlib.axes.Axes.quiver

Axes.quiver(*args, **kw)

Plot a 2-D field of arrows.

Call signatures:

```
quiver(U, V, **kw)
quiver(U, V, C, **kw)
quiver(X, Y, U, V, **kw)
quiver(X, Y, U, V, C, **kw)
```

U and *V* are the arrow data, *X* and *Y* set the location of the arrows, and *C* sets the color of the arrows. These arguments may be 1-D or 2-D arrays or sequences.

If *X* and *Y* are absent, they will be generated as a uniform grid. If *U* and *V* are 2-D arrays and *X* and *Y* are 1-D, and if `len(X)` and `len(Y)` match the column and row dimensions of *U*, then *X* and *Y* will be expanded with `numpy.meshgrid()`.

The default settings auto-scales the length of the arrows to a reasonable size. To change this behavior see the *scale* and *scale_units* kwargs.

The defaults give a slightly swept-back arrow; to make the head a triangle, make *headaxislength* the same as *headlength*. To make the arrow more pointed, reduce *headwidth* or increase *headlength* and *headaxislength*. To make the head smaller relative to the shaft, scale down all the head parameters. You will probably do best to leave *minshaft* alone.

linewidths and *edgecolors* can be used to customize the arrow outlines.

Parameters X : 1D or 2D array, sequence, optional

The x coordinates of the arrow locations

Y : 1D or 2D array, sequence, optional

The y coordinates of the arrow locations

U : 1D or 2D array or masked array, sequence

The x components of the arrow vectors

V : 1D or 2D array or masked array, sequence

The y components of the arrow vectors

C : 1D or 2D array, sequence, optional

The arrow colors

units : ['width' | 'height' | 'dots' | 'inches' | 'x' | 'y' | 'xy']

The arrow dimensions (except for *length*) are measured in multiples of this unit.

'width' or 'height': the width or height of the axis

'dots' or 'inches': pixels or inches, based on the figure dpi

'x', 'y', or 'xy': respectively X, Y, or $\sqrt{X^2 + Y^2}$ in data units

The arrows scale differently depending on the units. For 'x' or 'y', the arrows get larger as one zooms in; for other units, the arrow size is independent of the zoom state. For 'width' or 'height', the arrow size increases with the width and height of the axes, respectively, when the window is resized; for 'dots' or 'inches', resizing does not change the arrows.

angles : ['uv' | 'xy'], array, optional

Method for determining the angle of the arrows. Default is 'uv'.

'uv': the arrow axis aspect ratio is 1 so that if $U == V$ the orientation of the arrow on the plot is 45 degrees counter-clockwise from the horizontal axis (positive to the right).

'xy': arrows point from (x,y) to (x+u, y+v). Use this for plotting a gradient field, for example.

Alternatively, arbitrary angles may be specified as an array of values in degrees, counter-clockwise from the horizontal axis.

Note: inverting a data axis will correspondingly invert the arrows only with `angles='xy'`.

scale : None, float, optional

Number of data units per arrow length unit, e.g., m/s per plot width; a smaller scale parameter makes the arrow longer. Default is *None*.

If *None*, a simple autoscaling algorithm is used, based on the average vector length and the number of vectors. The arrow length unit is given by the `scale_units` parameter

scale_units : ['width' | 'height' | 'dots' | 'inches' | 'x' | 'y' | 'xy'], None, optional

If the `scale` kwarg is *None*, the arrow length unit. Default is *None*.

e.g. `scale_units` is 'inches', `scale` is 2.0, and $(u, v) = (1, 0)$, then the vector will be 0.5 inches long.

If `scale_units` is 'width'/'height', then the vector will be half the width/height of the axes.

If `scale_units` is 'x' then the vector will be 0.5 x-axis units. To plot vectors in the x-y plane, with `u` and `v` having the same units as `x` and `y`, use `angles='xy'`, `scale_units='xy'`, `scale=1`.

width : scalar, optional

Shaft width in arrow units; default depends on choice of units, above, and number of vectors; a typical starting value is about 0.005 times the width of the plot.

headwidth : scalar, optional

Head width as multiple of shaft width, default is 3

headlength : scalar, optional

Head length as multiple of shaft width, default is 5

headaxislength : scalar, optional

Head length at shaft intersection, default is 4.5

minshaft : scalar, optional

Length below which arrow scales, in units of head length. Do not set this to less than 1, or small arrows will look terrible! Default is 1

minlength : scalar, optional

Minimum length as a multiple of shaft width; if an arrow length is less than this, plot a dot (hexagon) of this diameter instead. Default is 1.

pivot : ['tail' | 'mid' | 'middle' | 'tip'], optional

The part of the arrow that is at the grid point; the arrow rotates about this point, hence the name *pivot*.

color : [color | color sequence], optional

This is a synonym for the *PolyCollection* `facecolor` kwarg. If *C* has been set, *color* has no effect.

See also:

quiverkey Add a key to a quiver plot

Notes

Additional *PolyCollection* keyword arguments:

Property	Description
<i>agg_filter</i>	unknown
<i>alpha</i>	float or None
<i>animated</i>	[True False]
<i>antialiased</i> or <i>antialiaseds</i>	Boolean or sequence of booleans
<i>array</i>	unknown
<i>axes</i>	an <i>Axes</i> instance
<i>clim</i>	a length 2 sequence of floats
<i>clip_box</i>	a <i>matplotlib.transforms.Bbox</i> instance
<i>clip_on</i>	[True False]
<i>clip_path</i>	[(<i>Path</i> , <i>Transform</i>) <i>Patch</i> None]
<i>cmap</i>	a colormap or registered colormap name
<i>color</i>	matplotlib color arg or sequence of rgba tuples
<i>contains</i>	a callable function
<i>edgecolor</i> or <i>edgecolors</i>	matplotlib color spec or sequence of specs
<i>facecolor</i> or <i>facecolors</i>	matplotlib color spec or sequence of specs
<i>figure</i>	a <i>matplotlib.figure.Figure</i> instance
<i>gid</i>	an id string
<i>hatch</i>	['/' '\' ' ' '-' '+' 'x' 'o' 'O' '.' '*']
<i>label</i>	string or anything printable with '%s' conversion.
<i>linestyle</i> or <i>dashes</i> or <i>linestyles</i>	['solid' 'dashed', 'dashdot', 'dotted' (offset, on-off-dash-seq) '-' '--' '-. ']
<i>linewidth</i> or <i>linewidths</i> or <i>lw</i>	float or sequence of floats
<i>norm</i>	unknown
<i>offset_position</i>	unknown
<i>offsets</i>	float or sequence of floats
<i>path_effects</i>	unknown
<i>picker</i>	[None float boolean callable]
<i>pickradius</i>	unknown
<i>rasterized</i>	[True False None]
<i>sketch_params</i>	unknown

Table 19.36 – continued from previous page

Property	Description
<i>snap</i>	unknown
<i>transform</i>	<i>Transform</i> instance
<i>url</i>	a url string
<i>urls</i>	unknown
<i>visible</i>	[True False]
<i>zorder</i>	any number

Examples

→ Quiver key, length = 10

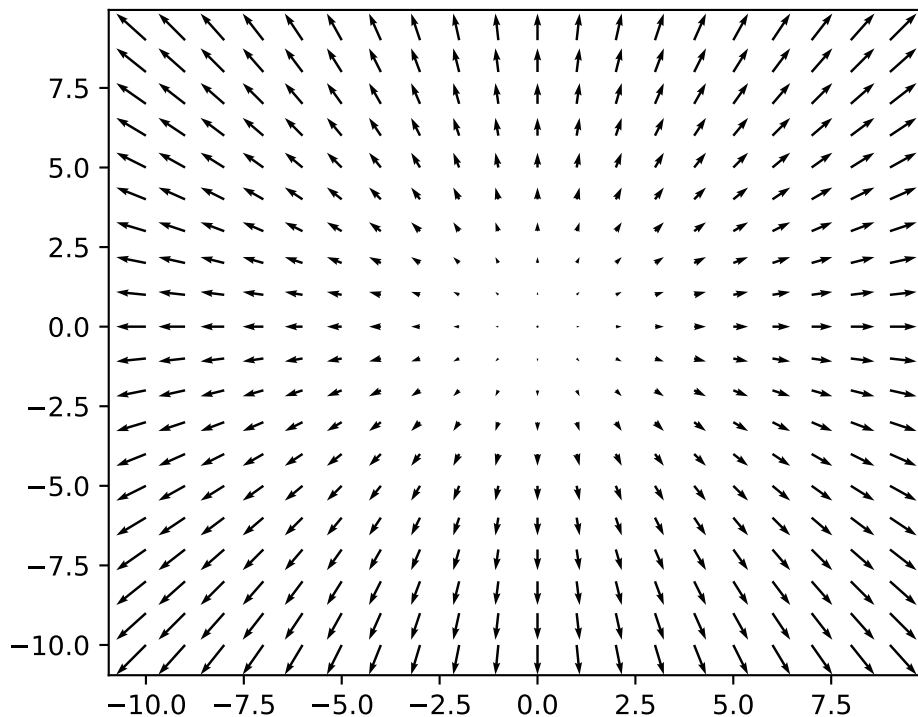

matplotlib.axes.Axes.quiverkey

`Axes.quiverkey(*args, **kw)`

Add a key to a quiver plot.

Call signature:

```
quiverkey(Q, X, Y, U, label, **kw)
```

Arguments:

Q: The Quiver instance returned by a call to `quiver`.

X, Y: The location of the key; additional explanation follows.

U: The length of the key

label: A string with the length and units of the key

Keyword arguments:

coordinates = ['axes' | 'figure' | 'data' | 'inches'] Coordinate system and units for *X, Y*: 'axes' and 'figure' are normalized coordinate systems with 0,0 in the lower left and 1,1 in the upper right; 'data' are the axes data coordinates (used for the locations of the vectors in the quiver plot itself); 'inches' is position in the figure in inches, with 0,0 at the lower left corner.

color: overrides face and edge colors from *Q*.

labelpos = ['N' | 'S' | 'E' | 'W'] Position the label above, below, to the right, to the left of the arrow, respectively.

labelsep: Distance in inches between the arrow and the label. Default is 0.1

labelcolor: defaults to default *Text* color.

fontproperties: A dictionary with keyword arguments accepted by the *FontProperties* initializer: *family, style, variant, size, weight*

Any additional keyword arguments are used to override vector properties taken from *Q*.

The positioning of the key depends on *X, Y, coordinates*, and *labelpos*. If *labelpos* is 'N' or 'S', *X, Y* give the position of the middle of the key arrow. If *labelpos* is 'E', *X, Y* positions the head, and if *labelpos* is 'W', *X, Y* positions the tail; in either of these two cases, *X, Y* is somewhere in the middle of the arrow+label key object.

matplotlib.axes.Axes.streamplot

```
Axes.streamplot(x, y, u, v, density=1, linewidth=None, color=None, cmap=None, norm=None,
                 arrowsize=1, arrowstyle='->', minlength=0.1, transform=None, zorder=None,
                 start_points=None)
```

Draws streamlines of a vector flow.

x, y [1d arrays] an *evenly spaced* grid.

u, v [2d arrays] x and y-velocities. Number of rows should match length of *y*, and the number of columns should match *x*.

density [float or 2-tuple] Controls the closeness of streamlines. When *density* = 1, the domain is divided into a 30x30 grid—*density* linearly scales this grid. Each cell in the grid can have, at most, one traversing streamline. For different densities in each direction, use [*density_x, density_y*].

linewidth [numeric or 2d array] vary linewidth when given a 2d array with the same shape as velocities.

color [matplotlib color code, or 2d array] Streamline color. When given an array with the same shape as velocities, *color* values are converted to colors using *cmap*.

cmap [*Colormap*] Colormap used to plot streamlines and arrows. Only necessary when using an array input for *color*.

norm [*Normalize*] Normalize object used to scale luminance data to 0, 1. If None, stretch (min, max) to (0, 1). Only necessary when *color* is an array.

arrowsize [float] Factor scale arrow size.

arrowstyle [str] Arrow style specification. See *FancyArrowPatch*.

minlength [float] Minimum length of streamline in axes coordinates.

start_points: Nx2 array Coordinates of starting points for the streamlines. In data coordinates, the same as the *x* and *y* arrays.

zorder [int] any number

Returns:

stream_container [StreamplotSet] Container object with attributes

- lines: *matplotlib.collections.LineCollection* of streamlines
- arrows: collection of *matplotlib.patches.FancyArrowPatch* objects representing arrows half-way along stream lines.

This container will probably change in the future to allow changes to the colormap, alpha, etc. for both lines and arrows, but these changes should be backward compatible.

19.2 Clearing

<i>Axes.cla</i>	Clear the current axes.
<i>Axes.clear</i>	clear the axes

19.2.1 matplotlib.axes.Axes.cla

Axes.cla()

Clear the current axes.

19.2.2 matplotlib.axes.Axes.clear

Axes.clear()

clear the axes

19.3 Appearance

<code>Axes.axis</code>	Set axis properties.
<code>Axes.set_axis_off</code>	turn off the axis
<code>Axes.set_axis_on</code>	turn on the axis
<code>Axes.set_frame_on</code>	Set whether the axes rectangle patch is drawn
<code>Axes.get_frame_on</code>	Get whether the axes rectangle patch is drawn
<code>Axes.set_axisbelow</code>	Set whether the axis ticks and gridlines are above or below most
<code>Axes.get_axisbelow</code>	Get whether axis below is true or not
<code>Axes.grid</code>	Turn the axes grids on or off.
<code>Axes.get_axis_bgcolor</code>	Deprecated since version 2.0.
<code>Axes.get_facecolor</code>	
<code>Axes.get_fc</code>	
<code>Axes.set_facecolor</code>	
<code>Axes.set_fc</code>	
<code>Axes.set_axis_bgcolor</code>	Deprecated since version 2.0.

19.3.1 matplotlib.axes.Axes.axis

`Axes.axis(*v, **kwargs)`

Set axis properties.

Valid signatures:

```
xmin, xmax, ymin, ymax = axis()
xmin, xmax, ymin, ymax = axis(list_arg)
xmin, xmax, ymin, ymax = axis(string_arg)
xmin, xmax, ymin, ymax = axis(**kwargs)
```

Parameters `v` : list of float or {'on', 'off', 'equal', 'tight', 'scaled', 'normal', 'auto', 'image', 'square'}

Optional positional argument

Axis data limits set from a list; or a command relating to axes:

Value	Description
'on'	Toggle axis lines and labels on
'off'	Toggle axis lines and labels off
'equal'	Equal scaling by changing limits
'scaled'	Equal scaling by changing box dimensions
'tight'	Limits set such that all data is shown
'auto'	Automatic scaling, fill rectangle with data
'normal'	Same as 'auto'; deprecated
'image'	'scaled' with axis limits equal to data limits
'square'	Square plot; similar to 'scaled', but initially forcing $x_{\max}-x_{\min} = y_{\max}-y_{\min}$

emit : bool, optional

Passed to `set_{x,y}lim` functions, if observers are notified of axis limit change

xmin, ymin, xmax, ymax : float, optional

The axis limits to be set

Returns **xmin, xmax, ymin, ymax** : float

The axis limits

19.3.2 matplotlib.axes.Axes.set_axis_off

`Axes.set_axis_off()`

turn off the axis

19.3.3 matplotlib.axes.Axes.set_axis_on

`Axes.set_axis_on()`

turn on the axis

19.3.4 matplotlib.axes.Axes.set_frame_on

`Axes.set_frame_on(b)`

Set whether the axes rectangle patch is drawn

ACCEPTS: [*True* | *False*]

19.3.5 matplotlib.axes.Axes.get_frame_on

`Axes.get_frame_on()`

Get whether the axes rectangle patch is drawn

19.3.6 matplotlib.axes.Axes.set_axisbelow

`Axes.set_axisbelow(b)`

Set whether the axis ticks and gridlines are above or below most artists

ACCEPTS: [*True* | *False* | 'line']

19.3.7 matplotlib.axes.Axes.get_axisbelow

`Axes.get_axisbelow()`

Get whether axis below is true or not

19.3.8 matplotlib.axes.Axes.grid

`Axes.grid(b=None, which='major', axis='both', **kwargs)`

Turn the axes grids on or off.

Set the axes grids on or off; *b* is a boolean. (For MATLAB compatibility, *b* may also be a string, 'on' or 'off'.)

If *b* is *None* and `len(kwargs)==0`, toggle the grid state. If *kwargs* are supplied, it is assumed that you want a grid and *b* is thus set to *True*.

which can be 'major' (default), 'minor', or 'both' to control whether major tick grids, minor tick grids, or both are affected.

axis can be 'both' (default), 'x', or 'y' to control which set of gridlines are drawn.

kwargs are used to set the grid line properties, e.g.,:

```
ax.grid(color='r', linestyle='-', linewidth=2)
```

Valid *Line2D* kwargs are

Property	Description
<i>agg_filter</i>	unknown
<i>alpha</i>	float (0.0 transparent through 1.0 opaque)
<i>animated</i>	[True False]
<i>antialiased</i> or <i>aa</i>	[True False]
<i>axes</i>	an <i>Axes</i> instance
<i>clip_box</i>	a <i>matplotlib.transforms.Bbox</i> instance
<i>clip_on</i>	[True False]
<i>clip_path</i>	[(<i>Path</i> , <i>Transform</i>) <i>Patch</i> None]
<i>color</i> or <i>c</i>	any matplotlib color
<i>contains</i>	a callable function
<i>dash_capstyle</i>	['butt' 'round' 'projecting']
<i>dash_joinstyle</i>	['miter' 'round' 'bevel']
<i>dashes</i>	sequence of on/off ink in points

Table 19.39 – continued from previous page

Property	Description
<i>drawstyle</i>	[‘default’ ‘steps’ ‘steps-pre’ ‘steps-mid’ ‘steps-post’]
<i>figure</i>	a <i>matplotlib.figure.Figure</i> instance
<i>fillstyle</i>	[‘full’ ‘left’ ‘right’ ‘bottom’ ‘top’ ‘none’]
<i>gid</i>	an id string
<i>label</i>	string or anything printable with ‘%s’ conversion.
<i>linestyle</i> or <i>ls</i>	[‘solid’ ‘dashed’, ‘dashdot’, ‘dotted’ (offset, on-off-dash-seq) ‘-’ ‘--’ ‘-.’ ‘.’]
<i>linewidth</i> or <i>lw</i>	float value in points
<i>marker</i>	<i>A valid marker style</i>
<i>markeredgecolor</i> or <i>mec</i>	any matplotlib color
<i>markeredgewidth</i> or <i>mew</i>	float value in points
<i>markerfacecolor</i> or <i>mfc</i>	any matplotlib color
<i>markerfacecoloralt</i> or <i>mfcalt</i>	any matplotlib color
<i>markersize</i> or <i>ms</i>	float
<i>markevery</i>	[None int length-2 tuple of int slice list/array of int float length-2 tuple of float]
<i>path_effects</i>	unknown
<i>picker</i>	float distance in points or callable pick function <code>fn(artist, event)</code>
<i>pickradius</i>	float distance in points
<i>rasterized</i>	[True False None]
<i>sketch_params</i>	unknown
<i>snap</i>	unknown
<i>solid_capstyle</i>	[‘butt’ ‘round’ ‘projecting’]
<i>solid_joinstyle</i>	[‘miter’ ‘round’ ‘bevel’]
<i>transform</i>	a <i>matplotlib.transforms.Transform</i> instance
<i>url</i>	a url string
<i>visible</i>	[True False]
<i>xdata</i>	1D array
<i>ydata</i>	1D array
<i>zorder</i>	any number

19.3.9 matplotlib.axes.Axes.get_axis_bgcolor

Axes.get_axis_bgcolor()

Deprecated since version 2.0: The `get_axis_bgcolor` function was deprecated in version 2.0. Use `get_facecolor` instead.

Return the axis background color

19.3.10 matplotlib.axes.Axes.get_facecolor

Axes.get_facecolor()

19.3.11 matplotlib.axes.Axes.get_fc

`Axes.get_fc()`

19.3.12 matplotlib.axes.Axes.set_facecolor

`Axes.set_facecolor(color)`

19.3.13 matplotlib.axes.Axes.set_fc

`Axes.set_fc(color)`

19.3.14 matplotlib.axes.Axes.set_axis_bgcolor

`Axes.set_axis_bgcolor(color)`

Deprecated since version 2.0: The `set_axis_bgcolor` function was deprecated in version 2.0. Use `set_facecolor` instead.

set the axes background color

ACCEPTS: any matplotlib color - see `colors()`

19.4 Property cycle

<code><i>Axes.set_prop_cycle</i></code>	Set the property cycle for any future plot commands on this Axes.
<code><i>Axes.set_color_cycle</i></code>	Set the color cycle for any future plot commands on this Axes.

19.4.1 matplotlib.axes.Axes.set_prop_cycle

`Axes.set_prop_cycle(*args, **kwargs)`

Set the property cycle for any future plot commands on this Axes.

`set_prop_cycle(arg)` `set_prop_cycle(label, itr)` `set_prop_cycle(label1=itr1[, label2=itr2[, ...]])`

Form 1 simply sets given `Cycler` object.

Form 2 creates and sets a `Cycler` from a label and an iterable.

Form 3 composes and sets a `Cycler` as an inner product of the pairs of keyword arguments. In other words, all of the iterables are cycled simultaneously, as if through `zip()`.

Parameters *arg* : *Cycler*

Set the given *Cycler*. Can also be *None* to reset to the cycle defined by the current style.

label : *str*

The property key. Must be a valid *Artist* property. For example, 'color' or 'linestyle'. Aliases are allowed, such as 'c' for 'color' and 'lw' for 'linewidth'.

itr : *iterable*

Finite-length iterable of the property values. These values are validated and will raise a *ValueError* if invalid.

19.4.2 matplotlib.axes.Axes.set_color_cycle

Axes.set_color_cycle(*clist*)

Set the color cycle for any future plot commands on this *Axes*.

clist is a list of *mpl* color specifiers.

Deprecated since version 1.5.

19.5 Axis / limits

<i>Axes.get_yaxis</i>	Return the <i>YAxis</i> instance
<i>Axes.get_xaxis</i>	Return the <i>XAxis</i> instance

19.5.1 matplotlib.axes.Axes.get_yaxis

Axes.get_yaxis()

Return the *YAxis* instance

19.5.2 matplotlib.axes.Axes.get_xaxis

Axes.get_xaxis()

Return the *XAxis* instance

19.5.3 Axis Limits and direction

<i>Axes.invert_xaxis</i>	Invert the x-axis.
<i>Axes.invert_yaxis</i>	Invert the y-axis.
<i>Axes.xaxis_inverted</i>	Returns <i>True</i> if the x-axis is inverted.

Continued on next page

Table 19.42 – continued from previous page

<code>Axes.yaxis_inverted</code>	Returns <i>True</i> if the y-axis is inverted.
<code>Axes.set_xlim</code>	Set the data limits for the x-axis
<code>Axes.set_ylim</code>	Set the data limits for the y-axis
<code>Axes.get_ylim</code>	Get the y-axis range
<code>Axes.get_xlim</code>	Get the x-axis range
<code>Axes.update_datalim</code>	Update the data lim bbox with seq of xy tups or equiv.
<code>Axes.update_datalim_bounds</code>	Update the datalim to include the given
<code>Axes.update_datalim_numerix</code>	Deprecated since version 2.0.
<hr/>	
<code>Axes.set_ybound</code>	Set the lower and upper numerical bounds of the y-axis.
<code>Axes.set_xbound</code>	Set the lower and upper numerical bounds of the x-axis.
<code>Axes.get_ybound</code>	Return y-axis numerical bounds in the form of
<code>Axes.get_xbound</code>	Returns the x-axis numerical bounds

matplotlib.axes.Axes.invert_xaxis

Axes.invert_xaxis()

Invert the x-axis.

matplotlib.axes.Axes.invert_yaxis

Axes.invert_yaxis()

Invert the y-axis.

matplotlib.axes.Axes.xaxis_inverted

Axes.xaxis_inverted()

Returns *True* if the x-axis is inverted.

matplotlib.axes.Axes.yaxis_inverted

Axes.yaxis_inverted()

Returns *True* if the y-axis is inverted.

matplotlib.axes.Axes.set_xlim

Axes.set_xlim(*left=None, right=None, emit=True, auto=False, **kw*)

Set the data limits for the x-axis

Parameters left : scalar, optional

The left xlim (default: None, which leaves the left limit unchanged).

right : scalar, optional

The right xlim (default: None, which leaves the right limit unchanged).

emit : bool, optional

Whether to notify observers of limit change (default: True).

auto : bool or None, optional

Whether to turn on autoscaling of the x-axis. True turns on, False turns off (default action), None leaves unchanged.

xlims : tuple, optional

The left and right xlims may be passed as the tuple (`left`, `right`) as the first positional argument (or as the `left` keyword argument).

Returns xlims : tuple

Returns the new x-axis limits as (`left`, `right`).

Notes

The left value may be greater than the right value, in which case the x-axis values will decrease from left to right.

Examples

```
>>> set_xlim(left, right)
>>> set_xlim((left, right))
>>> left, right = set_xlim(left, right)
```

One limit may be left unchanged.

```
>>> set_xlim(right=right_lim)
```

Limits may be passed in reverse order to flip the direction of the x-axis. For example, suppose `x` represents the number of years before present. The x-axis limits might be set like the following so 5000 years ago is on the left of the plot and the present is on the right.

```
>>> set_xlim(5000, 0)
```

matplotlib.axes.Axes.set_ylim

`Axes.set_ylim(bottom=None, top=None, emit=True, auto=False, **kw)`

Set the data limits for the y-axis

Parameters bottom : scalar, optional

The bottom ylim (default: None, which leaves the bottom limit unchanged).

top : scalar, optional

The top ylim (default: None, which leaves the top limit unchanged).

emit : bool, optional

Whether to notify observers of limit change (default: True).

auto : bool or None, optional

Whether to turn on autoscaling of the y-axis. True turns on, False turns off (default action), None leaves unchanged.

ylimits : tuple, optional

The bottom and top ylimits may be passed as the tuple (bottom, top) as the first positional argument (or as the bottom keyword argument).

Returns ylimits : tuple

Returns the new y-axis limits as (bottom, top).

Notes

The bottom value may be greater than the top value, in which case the y-axis values will decrease from bottom to top.

Examples

```
>>> set_ylim(bottom, top)
>>> set_ylim((bottom, top))
>>> bottom, top = set_ylim(bottom, top)
```

One limit may be left unchanged.

```
>>> set_ylim(top=top_lim)
```

Limits may be passed in reverse order to flip the direction of the y-axis. For example, suppose *y* represents depth of the ocean in m. The y-axis limits might be set like the following so 5000 m depth is at the bottom of the plot and the surface, 0 m, is at the top.

```
>>> set_ylim(5000, 0)
```

matplotlib.axes.Axes.get_ylim

Axes.get_ylim()

Get the y-axis range

Returns ylimits : tuple

Returns the current y-axis limits as the tuple (bottom, top).

Notes

The y-axis may be inverted, in which case the bottom value will be greater than the top value.

matplotlib.axes.Axes.get_xlim

Axes.get_xlim()

Get the x-axis range

Returns xlims : tuple

Returns the current x-axis limits as the tuple (left, right).

Notes

The x-axis may be inverted, in which case the left value will be greater than the right value.

matplotlib.axes.Axes.update_datalim

Axes.update_datalim(xys, updatex=True, updatey=True)

Update the data lim bbox with seq of xy tups or equiv. 2-D array

matplotlib.axes.Axes.update_datalim_bounds

Axes.update_datalim_bounds(bounds)

Update the datalim to include the given *Bbox bounds*

matplotlib.axes.Axes.update_datalim_numerix

Axes.update_datalim_numerix(x, y)

Deprecated since version 2.0: The update_datalim_numerix function was deprecated in version 2.0. Use update_datalim instead.

Update the data lim bbox with seq of xy tups

matplotlib.axes.Axes.set_ybound

Axes.set_ybound(lower=None, upper=None)

Set the lower and upper numerical bounds of the y-axis. This method will honor axes inversion regardless of parameter order. It will not change the `_autoscaleYon` attribute.

matplotlib.axes.Axes.set_xbound

`Axes.set_xbound(lower=None, upper=None)`

Set the lower and upper numerical bounds of the x-axis. This method will honor axes inversion regardless of parameter order. It will not change the `_autoscaleXon` attribute.

matplotlib.axes.Axes.get_ybound

`Axes.get_ybound()`

Return y-axis numerical bounds in the form of `lowerBound < upperBound`

matplotlib.axes.Axes.get_xbound

`Axes.get_xbound()`

Returns the x-axis numerical bounds

This always returns:

`lowerBound < upperBound`

Returns `lowerBound, upperBound` : float

19.5.4 Axis Labels, title, and legend

<code>Axes.get_xlabel</code>	Get the xlabel text string.
<code>Axes.get_ylabel</code>	Get the ylabel text string.
<code>Axes.set_xlabel</code>	Set the label for the xaxis.
<code>Axes.set_ylabel</code>	Set the label for the yaxis
<code>Axes.set_title</code>	Set a title for the axes.
<code>Axes.get_title</code>	Get an axes title.
<code>Axes.legend</code>	Places a legend on the axes.
<code>Axes.get_legend</code>	Return the legend.Legend instance, or None if no legend is defined
<code>Axes.get_legend_handles_labels</code>	Return handles and labels for legend

matplotlib.axes.Axes.get_xlabel

`Axes.get_xlabel()`

Get the xlabel text string.

matplotlib.axes.Axes.get_ylabel

`Axes.get_ylabel()`

Get the ylabel text string.

matplotlib.axes.Axes.set_xlabel

Axes.set_xlabel(*xlabel*, *fontdict=None*, *labelpad=None*, ***kwargs*)

Set the label for the xaxis.

Parameters xlabel : string

x label

labelpad : scalar, optional, default: None

spacing in points between the label and the x-axis

Other Parameters kwargs : *Text* properties

See also:

[text](#) for information on how override and the optional args work

matplotlib.axes.Axes.set_ylabel

Axes.set_ylabel(*ylabel*, *fontdict=None*, *labelpad=None*, ***kwargs*)

Set the label for the yaxis

Parameters ylabel : string

y label

labelpad : scalar, optional, default: None

spacing in points between the label and the x-axis

Other Parameters kwargs : *Text* properties

See also:

[text](#) for information on how override and the optional args work

matplotlib.axes.Axes.set_title

Axes.set_title(*label*, *fontdict=None*, *loc='center'*, ***kwargs*)

Set a title for the axes.

Set one of the three available axes titles. The available titles are positioned above the axes in the center, flush with the left edge, and flush with the right edge.

Parameters label : str

Text to use for the title

fontdict : dict

A dictionary controlling the appearance of the title text, the default `fontdict` is:

```
{'fontsize': rcParams['axes.titlesize'],  
 'fontweight' : rcParams['axes.titleweight'],  
 'verticalalignment': 'baseline',  
 'horizontalalignment': loc}
```

loc : {'center', 'left', 'right'}, str, optional

Which title to set, defaults to 'center'

Returns text : *Text*

The matplotlib text instance representing the title

Other Parameters kwargs : text properties

Other keyword arguments are text properties, see *Text* for a list of valid text properties.

matplotlib.axes.Axes.get_title

Axes.get_title(loc='center')

Get an axes title.

Get one of the three available axes titles. The available titles are positioned above the axes in the center, flush with the left edge, and flush with the right edge.

Parameters loc : {'center', 'left', 'right'}, str, optional

Which title to get, defaults to 'center'

Returns title: str

The title text string.

matplotlib.axes.Axes.legend

Axes.legend(*args, **kwargs)

Places a legend on the axes.

To make a legend for lines which already exist on the axes (via plot for instance), simply call this function with an iterable of strings, one for each legend item. For example:

```
ax.plot([1, 2, 3])  
ax.legend(['A simple line'])
```

However, in order to keep the "label" and the legend element instance together, it is preferable to specify the label either at artist creation, or by calling the *set_label()* method on the artist:

```
line, = ax.plot([1, 2, 3], label='Inline label')  
# Overwrite the label by calling the method.  
line.set_label('Label via method')  
ax.legend()
```

Specific lines can be excluded from the automatic legend element selection by defining a label starting with an underscore. This is default for all artists, so calling `legend()` without any arguments and without setting the labels manually will result in no legend being drawn.

For full control of which artists have a legend entry, it is possible to pass an iterable of legend artists followed by an iterable of legend labels respectively:

```
legend((line1, line2, line3), ('label1', 'label2', 'label3'))
```

Parameters loc : int or string or pair of floats, default: 'upper right'

The location of the legend. Possible codes are:

Location String	Location Code
'best'	0
'upper right'	1
'upper left'	2
'lower left'	3
'lower right'	4
'right'	5
'center left'	6
'center right'	7
'lower center'	8
'upper center'	9
'center'	10

Alternatively can be a 2-tuple giving x , y of the lower-left corner of the legend in axes coordinates (in which case `bbox_to_anchor` will be ignored).

bbox_to_anchor : `matplotlib.transforms.BboxBase` instance or tuple of floats

Specify any arbitrary location for the legend in `bbox_transform` coordinates (default Axes coordinates).

For example, to put the legend's upper right hand corner in the center of the axes the following keywords can be used:

```
loc='upper right', bbox_to_anchor=(0.5, 0.5)
```

ncol : integer

The number of columns that the legend has. Default is 1.

prop : None or `matplotlib.font_manager.FontProperties` or dict

The font properties of the legend. If None (default), the current `matplotlib.rcParams` will be used.

fontsize : int or float or {'xx-small', 'x-small', 'small', 'medium', 'large', 'x-large', 'xx-large'}

Controls the font size of the legend. If the value is numeric the size will be the absolute font size in points. String values are relative to the current default font size. This argument is only used if `prop` is not specified.

numpoints : None or int

The number of marker points in the legend when creating a legend entry for a line/*matplotlib.lines.Line2D*. Default is None which will take the value from the legend.*numpoints rcParam*.

scatterpoints : None or int

The number of marker points in the legend when creating a legend entry for a scatter plot/*matplotlib.collections.PathCollection*. Default is None which will take the value from the legend.*scatterpoints rcParam*.

scatteryoffsets : iterable of floats

The vertical offset (relative to the font size) for the markers created for a scatter plot legend entry. 0.0 is at the base the legend text, and 1.0 is at the top. To draw all markers at the same height, set to [0.5]. Default [0.375, 0.5, 0.3125].

markerscale : None or int or float

The relative size of legend markers compared with the originally drawn ones. Default is None which will take the value from the legend.*markerscale rcParam*.

markerfirst : bool

if *True*, legend marker is placed to the left of the legend label if *False*, legend marker is placed to the right of the legend label

frameon : None or bool

Control whether the legend should be drawn on a patch (frame). Default is None which will take the value from the legend.*frameon rcParam*.

fancybox : None or bool

Control whether round edges should be enabled around the *FancyBboxPatch* which makes up the legend's background. Default is None which will take the value from the legend.*fancybox rcParam*.

shadow : None or bool

Control whether to draw a shadow behind the legend. Default is None which will take the value from the legend.*shadow rcParam*.

framealpha : None or float

Control the alpha transparency of the legend's background. Default is None which will take the value from the legend.*framealpha rcParam*.

facecolor : None or "inherit" or a color spec

Control the legend's background color. Default is None which will take the value from the legend.*facecolor rcParam*. If "inherit", it will take the axes.*facecolor rcParam*.

edgecolor : None or "inherit" or a color spec

Control the legend's background patch edge color. Default is `None` which will take the value from the `legend.edgecolor` *rcParam*. If `"inherit"`, it will take the `axes.edgecolor` *rcParam*.

mode : {"expand", `None`}

If `mode` is set to `"expand"` the legend will be horizontally expanded to fill the axes area (or `bbox_to_anchor` if defines the legend's size).

bbox_transform : `None` or `matplotlib.transforms.Transform`

The transform for the bounding box (`bbox_to_anchor`). For a value of `None` (default) the Axes' `transAxes` transform will be used.

title : str or `None`

The legend's title. Default is no title (`None`).

borderpad : float or `None`

The fractional whitespace inside the legend border. Measured in font-size units. Default is `None` which will take the value from the `legend.borderpad` *rcParam*.

labelspacing : float or `None`

The vertical space between the legend entries. Measured in font-size units. Default is `None` which will take the value from the `legend.labelspacing` *rcParam*.

handlelength : float or `None`

The length of the legend handles. Measured in font-size units. Default is `None` which will take the value from the `legend.handlelength` *rcParam*.

handletextpad : float or `None`

The pad between the legend handle and text. Measured in font-size units. Default is `None` which will take the value from the `legend.handletextpad` *rcParam*.

borderaxespad : float or `None`

The pad between the axes and legend border. Measured in font-size units. Default is `None` which will take the value from the `legend.borderaxespad` *rcParam*.

columnspacing : float or `None`

The spacing between columns. Measured in font-size units. Default is `None` which will take the value from the `legend.columnspacing` *rcParam*.

handler_map : dict or `None`

The custom dictionary mapping instances or types to a legend handler. This `handler_map` updates the default handler map found at `matplotlib.legend.Legend.get_legend_handler_map()`.

Notes

Not all kinds of artist are supported by the legend command. See *Legend guide* for details.

Examples

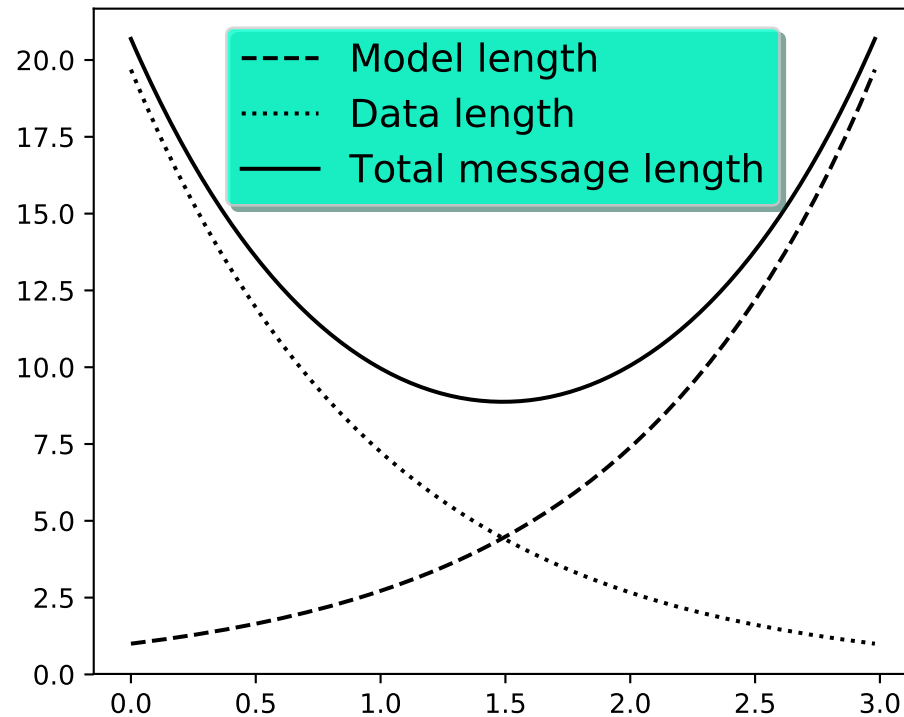

matplotlib.axes.Axes.get_legend

`Axes.get_legend()`

Return the legend.Legend instance, or None if no legend is defined

matplotlib.axes.Axes.get_legend_handles_labels

`Axes.get_legend_handles_labels(legend_handler_map=None)`

Return handles and labels for legend

`ax.legend()` is equivalent to

```
h, l = ax.get_legend_handles_labels()
ax.legend(h, l)
```

19.5.5 Axis scales

<code>Axes.set_xscale</code>	Set the x-axis scale
<code>Axes.get_xscale</code>	Return the xaxis scale string: linear, log, logit, symlog
<code>Axes.get_yscale</code>	Return the yaxis scale string: linear, log, logit, symlog
<code>Axes.set_yscale</code>	Set the y-axis scale

matplotlib.axes.Axes.set_xscale

`Axes.set_xscale`(*value*, ***kwargs*)

Set the x-axis scale

Set the scaling of the x-axis: ‘linear’ | ‘log’ | ‘logit’ | ‘symlog’

ACCEPTS: [‘linear’ | ‘log’ | ‘logit’ | ‘symlog’]

Different kwargs are accepted, depending on the scale: ‘linear’

‘log’

basex/basey: The base of the logarithm

nonposx/nonposy: [‘mask’ | ‘clip’] non-positive values in *x* or *y* can be masked as invalid, or clipped to a very small positive number

subsx/subsy: Where to place the subticks between each major tick. Should be a sequence of integers. For example, in a log10 scale: [2, 3, 4, 5, 6, 7, 8, 9]

will place 8 logarithmically spaced minor ticks between each major tick.

‘logit’

nonpos: [‘mask’ | ‘clip’] values beyond]0, 1[can be masked as invalid, or clipped to a number very close to 0 or 1

‘symlog’

basex/basey: The base of the logarithm

linthreshx/linthreshy: The range $(-x, x)$ within which the plot is linear (to avoid having the plot go to infinity around zero).

subsx/subsy: Where to place the subticks between each major tick. Should be a sequence of integers. For example, in a log10 scale: [2, 3, 4, 5, 6, 7, 8, 9]

will place 8 logarithmically spaced minor ticks between each major tick.

linscalex/linscaley: This allows the linear range ($-linthresh$ to $linthresh$) to be stretched relative to the logarithmic range. Its value is the number of decades to use for each half of the linear range. For example, when *linscale* == 1.0 (the default), the space used for the positive and negative halves of the linear range will be equal to one decade in the logarithmic range.

matplotlib.axes.Axes.get_xscale

`Axes.get_xscale()`

Return the xaxis scale string: linear, log, logit, symlog

matplotlib.axes.Axes.get_yscale

`Axes.get_yscale()`

Return the yaxis scale string: linear, log, logit, symlog

matplotlib.axes.Axes.set_yscale

`Axes.set_yscale(value, **kwargs)`

Set the y-axis scale

Set the scaling of the y-axis: 'linear' | 'log' | 'logit' | 'symlog'

ACCEPTS: ['linear' | 'log' | 'logit' | 'symlog']

Different kwargs are accepted, depending on the scale: 'linear'

'log'

basex/basey: The base of the logarithm

nonposx/nonposy: ['mask' | 'clip'] non-positive values in x or y can be masked as invalid, or clipped to a very small positive number

subsx/subsy: Where to place the subticks between each major tick. Should be a sequence of integers. For example, in a log10 scale: [2, 3, 4, 5, 6, 7, 8, 9]

will place 8 logarithmically spaced minor ticks between each major tick.

'logit'

nonpos: ['mask' | 'clip'] values beyond]0, 1[can be masked as invalid, or clipped to a number very close to 0 or 1

'symlog'

basex/basey: The base of the logarithm

linthreshx/linthreshy: The range $(-x, x)$ within which the plot is linear (to avoid having the plot go to infinity around zero).

subsx/subsy: Where to place the subticks between each major tick. Should be a sequence of integers. For example, in a log10 scale: [2, 3, 4, 5, 6, 7, 8, 9]

will place 8 logarithmically spaced minor ticks between each major tick.

linscalex/linscaley: This allows the linear range $(-linthresh$ to $linthresh)$ to be stretched relative to the logarithmic range. Its value is the number of decades to use for each half of the linear range. For example, when `linscale == 1.0` (the default), the space

used for the positive and negative halves of the linear range will be equal to one decade in the logarithmic range.

19.5.6 Autoscaling and margins

<code>Axes.use_sticky_edges</code>	When autoscaling, whether to obey all <code>Artist.sticky_edges</code> .
<code>Axes.margins</code>	Set or retrieve autoscaling margins.
<code>Axes.set_xmargin</code>	Set padding of X data limits prior to autoscaling.
<code>Axes.set_ymargin</code>	Set padding of Y data limits prior to autoscaling.
<code>Axes.relim</code>	Recompute the data limits based on current artists.
<code>Axes.autoscale</code>	Autoscale the axis view to the data (toggle).
<code>Axes.autoscale_view</code>	Autoscale the view limits using the data limits.
<code>Axes.get_autoscale_on</code>	Get whether autoscaling is applied for both axes on plot commands
<code>Axes.set_autoscale_on</code>	Set whether autoscaling is applied on plot commands
<code>Axes.get_autoscalex_on</code>	Get whether autoscaling for the x-axis is applied on plot commands
<code>Axes.set_autoscalex_on</code>	Set whether autoscaling for the x-axis is applied on plot commands
<code>Axes.get_autoscaley_on</code>	Get whether autoscaling for the y-axis is applied on plot commands
<code>Axes.set_autoscaley_on</code>	Set whether autoscaling for the y-axis is applied on plot commands

`matplotlib.axes.Axes.use_sticky_edges`

`Axes.use_sticky_edges`

When autoscaling, whether to obey all `Artist.sticky_edges`.

Default is `True`.

Setting this to `False` ensures that the specified margins will be applied, even if the plot includes an image, for example, which would otherwise force a view limit to coincide with its data limit.

The changing this property does not change the plot until `autoscale` or `autoscale_view` is called.

`matplotlib.axes.Axes.margins`

`Axes.margins(*args, **kw)`

Set or retrieve autoscaling margins.

signatures:

```
margins()
```

returns `xmargin`, `ymargin`

```
margins(margin)
margins(xmargin, ymargin)
margins(x=xmargin, y=ymargin)
margins(..., tight=False)
```

All three forms above set the `xmargin` and `ymargin` parameters. All keyword parameters are optional. A single argument specifies both `xmargin` and `ymargin`. The `tight` parameter is passed to `autoscale_view()`, which is executed after a margin is changed; the default here is `True`, on the assumption that when margins are specified, no additional padding to match tick marks is usually desired. Setting `tight` to `None` will preserve the previous setting.

Specifying any margin changes only the autoscaling; for example, if `xmargin` is not `None`, then `xmargin` times the X data interval will be added to each end of that interval before it is used in autoscaling.

matplotlib.axes.Axes.set_xmargin

Axes.set_xmargin(*m*)

Set padding of X data limits prior to autoscaling.

m times the data interval will be added to each end of that interval before it is used in autoscaling.

accepts: float in range 0 to 1

matplotlib.axes.Axes.set_ymargin

Axes.set_ymargin(*m*)

Set padding of Y data limits prior to autoscaling.

m times the data interval will be added to each end of that interval before it is used in autoscaling.

accepts: float in range 0 to 1

matplotlib.axes.Axes.relim

Axes.relim(*visible_only=False*)

Recompute the data limits based on current artists. If you want to exclude invisible artists from the calculation, set `visible_only=True`

At present, `Collection` instances are not supported.

matplotlib.axes.Axes.autoscale

Axes.autoscale(*enable=True, axis='both', tight=None*)

Autoscale the axis view to the data (toggle).

Convenience method for simple axis view autoscaling. It turns autoscaling on or off, and then, if autoscaling for either axis is on, it performs the autoscaling on the specified axis or axes.

enable: [**True** | **False** | **None**] True (default) turns autoscaling on, False turns it off. None leaves the autoscaling state unchanged.

axis: ['x' | 'y' | 'both'] which axis to operate on; default is 'both'

tight: [**True** | **False** | **None**] If True, set view limits to data limits; if False, let the locator and margins expand the view limits; if None, use tight scaling if the only artist is an image, otherwise treat *tight* as False. The *tight* setting is retained for future autoscaling until it is explicitly changed.

Returns None.

matplotlib.axes.Axes.autoscale_view

Axes.autoscale_view(*tight=None, scalex=True, scaley=True*)

Autoscale the view limits using the data limits. You can selectively autoscale only a single axis, e.g., the x-axis by setting *scaley* to *False*. The autoscaling preserves any axis direction reversal that has already been done.

If *tight* is *False*, the axis major locator will be used to expand the view limits if `rcParams['axes.autolimit_mode']` is 'round_numbers'. Note that any margins that are in effect will be applied first, regardless of whether *tight* is *True* or *False*. Specifying *tight* as *True* or *False* saves the setting as a private attribute of the Axes; specifying it as *None* (the default) applies the previously saved value.

The data limits are not updated automatically when artist data are changed after the artist has been added to an Axes instance. In that case, use `matplotlib.axes.Axes.relim()` prior to calling `autoscale_view`.

matplotlib.axes.Axes.get_autoscale_on

Axes.get_autoscale_on()

Get whether autoscaling is applied for both axes on plot commands

matplotlib.axes.Axes.set_autoscale_on

Axes.set_autoscale_on(*b*)

Set whether autoscaling is applied on plot commands

accepts: [*True* | *False*]

matplotlib.axes.Axes.get_autoscalex_on

Axes.get_autoscalex_on()

Get whether autoscaling for the x-axis is applied on plot commands

matplotlib.axes.Axes.set_autoscalex_on

`Axes.set_autoscalex_on(b)`

Set whether autoscaling for the x-axis is applied on plot commands

accepts: [*True* | *False*]

matplotlib.axes.Axes.get_autoscaley_on

`Axes.get_autoscaley_on()`

Get whether autoscaling for the y-axis is applied on plot commands

matplotlib.axes.Axes.set_autoscaley_on

`Axes.set_autoscaley_on(b)`

Set whether autoscaling for the y-axis is applied on plot commands

accepts: [*True* | *False*]

19.5.7 Aspect ratio

<code><i>Axes.apply_aspect</i></code>	Use <code>_aspect()</code> and <code>_adjustable()</code> to modify the axes box or the view limits.
<code><i>Axes.get_aspect</i></code>	
<code><i>Axes.set_aspect</i></code>	<i>aspect</i>
<code><i>Axes.get_adjustable</i></code>	
<code><i>Axes.set_adjustable</i></code>	ACCEPTS: ['box' 'datalim' 'box-forced']

matplotlib.axes.Axes.apply_aspect

`Axes.apply_aspect(position=None)`

Use `_aspect()` and `_adjustable()` to modify the axes box or the view limits.

matplotlib.axes.Axes.get_aspect

`Axes.get_aspect()`

matplotlib.axes.Axes.set_aspect

`Axes.set_aspect(aspect, adjustable=None, anchor=None)`

aspect

value	description
'auto'	automatic; fill position rectangle with data
'normal'	same as 'auto'; deprecated
'equal'	same scaling from data to plot units for x and y
num	a circle will be stretched such that the height is num times the width. aspect=1 is the same as aspect='equal'.

adjustable

value	description
'box'	change physical size of axes
'datalim'	change xlim or ylim
'box-forced'	same as 'box', but axes can be shared

'box' does not allow axes sharing, as this can cause unintended side effect. For cases when sharing axes is fine, use 'box-forced'.

anchor

value	description
'C'	centered
'SW'	lower left corner
'S'	middle of bottom edge
'SE'	lower right corner
etc.	

Deprecated since version 1.2: the option 'normal' for aspect is deprecated. Use 'auto' instead.

matplotlib.axes.Axes.get_adjustable

`Axes.get_adjustable()`

matplotlib.axes.Axes.set_adjustable

`Axes.set_adjustable(adjustable)`

ACCEPTS: ['box' | 'datalim' | 'box-forced']

19.5.8 Ticks and tick labels

<code>Axes.xaxis_date</code>	Sets up x-axis ticks and labels that treat the x data as dates.
<code>Axes.yaxis_date</code>	Sets up y-axis ticks and labels that treat the y data as dates.
<code>Axes.get_xmajorticklabels</code>	Get the xtick labels as a list of <i>Text</i> instances.
Continued on next page	

Table 19.47 – continued from previous page

<code>Axes.get_xminorticklabels</code>	Get the x minor tick labels as a list of <code>matplotlib.text.Text</code> instances.
<code>Axes.get_xticklabels</code>	Get the x tick labels as a list of <code>Text</code> instances.
<code>Axes.get_xticklines</code>	Get the xtick lines as a list of <code>Line2D</code> instances
<code>Axes.get_xticks</code>	Return the x ticks as a list of locations
<code>Axes.get_ymajorticklabels</code>	Get the major y tick labels as a list of <code>Text</code> instances.
<code>Axes.get_yminorticklabels</code>	Get the minor y tick labels as a list of <code>Text</code> instances.
<code>Axes.get_yticklabels</code>	Get the y tick labels as a list of <code>Text</code> instances.
<code>Axes.get_yticklines</code>	Get the ytick lines as a list of <code>Line2D</code> instances
<code>Axes.get_yticks</code>	Return the y ticks as a list of locations
<code>Axes.minorticks_off</code>	Remove minor ticks from the axes.
<code>Axes.minorticks_on</code>	Add autoscaling minor ticks to the axes.
<code>Axes.set_xticklabels</code>	Set the xtick labels with list of strings <code>labels</code>
<code>Axes.set_xticks</code>	Set the x ticks with list of <code>ticks</code>
<code>Axes.set_yticklabels</code>	Set the y tick labels with list of strings <code>labels</code>
<code>Axes.set_yticks</code>	Set the y ticks with list of <code>ticks</code>
<code>Axes.get_xgridlines</code>	Get the x grid lines as a list of <code>Line2D</code> instances
<code>Axes.get_ygridlines</code>	Get the y grid lines as a list of <code>Line2D</code> instances
<code>Axes.ticklabel_format</code>	Change the <code>ScalarFormatter</code> used by default for linear axes.
<code>Axes.tick_params</code>	Change the appearance of ticks and tick labels.
<code>Axes.locator_params</code>	Control behavior of tick locators.

matplotlib.axes.Axes.xaxis_date**Axes.xaxis_date**(*tz=None*)

Sets up x-axis ticks and labels that treat the x data as dates.

tz is a timezone string or `tzinfo` instance. Defaults to `rc` value.

matplotlib.axes.Axes.yaxis_date**Axes.yaxis_date**(*tz=None*)

Sets up y-axis ticks and labels that treat the y data as dates.

tz is a timezone string or `tzinfo` instance. Defaults to `rc` value.

matplotlib.axes.Axes.get_xmajorticklabels**Axes.get_xmajorticklabels**()

Get the xtick labels as a list of `Text` instances.

matplotlib.axes.Axes.get_xminorticklabels

`Axes.get_xminorticklabels()`

Get the x minor tick labels as a list of `matplotlib.text.Text` instances.

matplotlib.axes.Axes.get_xticklabels

`Axes.get_xticklabels(minor=False, which=None)`

Get the x tick labels as a list of `Text` instances.

Parameters `minor` : bool

If True return the minor ticklabels, else return the major ticklabels

which : None, ('minor', 'major', 'both')

Overrides `minor`.

Selects which ticklabels to return

Returns `ret` : list

List of `Text` instances.

matplotlib.axes.Axes.get_xticklines

`Axes.get_xticklines()`

Get the xtick lines as a list of `Line2D` instances

matplotlib.axes.Axes.get_xticks

`Axes.get_xticks(minor=False)`

Return the x ticks as a list of locations

matplotlib.axes.Axes.get_ymajorticklabels

`Axes.get_ymajorticklabels()`

Get the major y tick labels as a list of `Text` instances.

matplotlib.axes.Axes.get_yminorticklabels

`Axes.get_yminorticklabels()`

Get the minor y tick labels as a list of `Text` instances.

matplotlib.axes.Axes.get_yticklabels

`Axes.get_yticklabels`(*minor=False, which=None*)

Get the x tick labels as a list of *Text* instances.

Parameters *minor* : bool

If True return the minor ticklabels, else return the major ticklabels

which : None, ('minor', 'major', 'both')

Overrides *minor*.

Selects which ticklabels to return

Returns *ret* : list

List of *Text* instances.

matplotlib.axes.Axes.get_yticklines

`Axes.get_yticklines`()

Get the ytick lines as a list of Line2D instances

matplotlib.axes.Axes.get_yticks

`Axes.get_yticks`(*minor=False*)

Return the y ticks as a list of locations

matplotlib.axes.Axes.minorticks_off

`Axes.minorticks_off`()

Remove minor ticks from the axes.

matplotlib.axes.Axes.minorticks_on

`Axes.minorticks_on`()

Add autoscaling minor ticks to the axes.

matplotlib.axes.Axes.set_xticklabels

`Axes.set_xticklabels`(*labels, fontdict=None, minor=False, **kwargs*)

Set the xtick labels with list of strings *labels*

Return a list of axis text instances.

kwargs set the *Text* properties. Valid properties are

Property	Description
<i>agg_filter</i>	unknown
<i>alpha</i>	float (0.0 transparent through 1.0 opaque)
<i>animated</i>	[True False]
<i>axes</i>	an <i>Axes</i> instance
<i>backgroundcolor</i>	any matplotlib color
<i>bbox</i>	FancyBboxPatch prop dict
<i>clip_box</i>	a <i>matplotlib.transforms.Bbox</i> instance
<i>clip_on</i>	[True False]
<i>clip_path</i>	[(<i>Path</i> , <i>Transform</i>) <i>Patch</i> None]
<i>color</i>	any matplotlib color
<i>contains</i>	a callable function
<i>family</i> or fontfamily or fontname or name	[FONTNAME 'serif' 'sans-serif' 'cursive' 'fantasy' 'monospace']
<i>figure</i>	a <i>matplotlib.figure.Figure</i> instance
<i>fontproperties</i> or font_properties	a <i>matplotlib.font_manager.FontProperties</i> instance
<i>gid</i>	an id string
<i>horizontalalignment</i> or ha	['center' 'right' 'left']
<i>label</i>	string or anything printable with '%s' conversion.
<i>linespacing</i>	float (multiple of font size)
<i>multialignment</i>	['left' 'right' 'center']
<i>path_effects</i>	unknown
<i>picker</i>	[None float boolean callable]
<i>position</i>	(x,y)
<i>rasterized</i>	[True False None]
<i>rotation</i>	[angle in degrees 'vertical' 'horizontal']
<i>rotation_mode</i>	unknown
<i>size</i> or fontsize	[size in points 'xx-small' 'x-small' 'small' 'medium' 'large' 'x-large']
<i>sketch_params</i>	unknown
<i>snap</i>	unknown
<i>stretch</i> or fontstretch	[a numeric value in range 0-1000 'ultra-condensed' 'extra-condensed' 'c
<i>style</i> or fontstyle	['normal' 'italic' 'oblique']
<i>text</i>	string or anything printable with '%s' conversion.
<i>transform</i>	<i>Transform</i> instance
<i>url</i>	a url string
<i>usetex</i>	unknown
<i>variant</i> or fontvariant	['normal' 'small-caps']
<i>verticalalignment</i> or ma or va	['center' 'top' 'bottom' 'baseline']
<i>visible</i>	[True False]
<i>weight</i> or fontweight	[a numeric value in range 0-1000 'ultralight' 'light' 'normal' 'regular']
<i>wrap</i>	unknown
<i>x</i>	float
<i>y</i>	float
<i>zorder</i>	any number

ACCEPTS: sequence of strings

matplotlib.axes.Axes.set_xticks

`Axes.set_xticks(ticks, minor=False)`

Set the x ticks with list of *ticks*

ACCEPTS: sequence of floats

matplotlib.axes.Axes.set_yticklabels

`Axes.set_yticklabels(labels, fontdict=None, minor=False, **kwargs)`

Set the y tick labels with list of strings *labels*

Return a list of *Text* instances.

kwargs set *Text* properties for the labels. Valid properties are

Property	Description
<i>agg_filter</i>	unknown
<i>alpha</i>	float (0.0 transparent through 1.0 opaque)
<i>animated</i>	[True False]
<i>axes</i>	an <i>Axes</i> instance
<i>backgroundcolor</i>	any matplotlib color
<i>bbox</i>	FancyBboxPatch prop dict
<i>clip_box</i>	a <i>matplotlib.transforms.Bbox</i> instance
<i>clip_on</i>	[True False]
<i>clip_path</i>	[(<i>Path</i> , <i>Transform</i>) <i>Patch</i> None]
<i>color</i>	any matplotlib color
<i>contains</i>	a callable function
<i>family</i> or <i>fontfamily</i> or <i>fontname</i> or <i>name</i>	[FONTNAME 'serif' 'sans-serif' 'cursive' 'fantasy' 'monospace']
<i>figure</i>	a <i>matplotlib.figure.Figure</i> instance
<i>fontproperties</i> or <i>font_properties</i>	a <i>matplotlib.font_manager.FontProperties</i> instance
<i>gid</i>	an id string
<i>horizontalalignment</i> or <i>ha</i>	['center' 'right' 'left']
<i>label</i>	string or anything printable with '%s' conversion.
<i>linespacing</i>	float (multiple of font size)
<i>multialignment</i>	['left' 'right' 'center']
<i>path_effects</i>	unknown
<i>picker</i>	[None float boolean callable]
<i>position</i>	(x,y)
<i>rasterized</i>	[True False None]
<i>rotation</i>	[angle in degrees 'vertical' 'horizontal']
<i>rotation_mode</i>	unknown
<i>size</i> or <i>fontsize</i>	[size in points 'xx-small' 'x-small' 'small' 'medium' 'large' 'x-large']
<i>sketch_params</i>	unknown

Table 19.49 – continued from

Property	Description
<i>snap</i>	unknown
<i>stretch</i> or fontstretch	[a numeric value in range 0-1000 ‘ultra-condensed’ ‘extra-condensed’ ‘c
<i>style</i> or fontstyle	[‘normal’ ‘italic’ ‘oblique’]
<i>text</i>	string or anything printable with ‘%s’ conversion.
<i>transform</i>	<i>Transform</i> instance
<i>url</i>	a url string
<i>usetex</i>	unknown
<i>variant</i> or fontvariant	[‘normal’ ‘small-caps’]
<i>verticalalignment</i> or ma or va	[‘center’ ‘top’ ‘bottom’ ‘baseline’]
<i>visible</i>	[True False]
<i>weight</i> or fontweight	[a numeric value in range 0-1000 ‘ultralight’ ‘light’ ‘normal’ ‘regular’
<i>wrap</i>	unknown
<i>x</i>	float
<i>y</i>	float
<i>zorder</i>	any number

ACCEPTS: sequence of strings

matplotlib.axes.Axes.set_yticks

Axes.set_yticks(*ticks*, *minor=False*)

Set the y ticks with list of *ticks*

ACCEPTS: sequence of floats

Keyword arguments:

minor: [*False* | *True*] Sets the minor ticks if *True*

matplotlib.axes.Axes.get_xgridlines

Axes.get_xgridlines()

Get the x grid lines as a list of Line2D instances

matplotlib.axes.Axes.get_ygridlines

Axes.get_ygridlines()

Get the y grid lines as a list of Line2D instances

matplotlib.axes.Axes.ticklabel_format

`Axes.ticklabel_format(**kwargs)`

Change the *ScalarFormatter* used by default for linear axes.

Optional keyword arguments:

Key-word	Description
<i>style</i>	['sci' (or 'scientific') 'plain'] plain turns off scientific notation
<i>scilimits</i>	(m, n), pair of integers; if <i>style</i> is 'sci', scientific notation will be used for numbers outside the range 10^m :sup: to 10^n :sup:. Use (0,0) to include all numbers.
<i>use-Offset</i>	[True False offset]; if True, the offset will be calculated as needed; if False, no offset will be used; if a numeric offset is specified, it will be used.
<i>axis</i>	['x' 'y' 'both']
<i>use-Locale</i>	If True, format the number according to the current locale. This affects things such as the character used for the decimal separator. If False, use C-style (English) formatting. The default setting is controlled by the <code>axes.formatter.use_locale</code> rparam.

Only the major ticks are affected. If the method is called when the *ScalarFormatter* is not the *Formatter* being used, an `AttributeError` will be raised.

matplotlib.axes.Axes.tick_params

`Axes.tick_params(axis='both', **kwargs)`

Change the appearance of ticks and tick labels.

Parameters axis : { 'x', 'y', 'both' }, optional

Which axis to apply the parameters to.

Other Parameters axis : { 'x', 'y', 'both' }

Axis on which to operate; default is 'both'.

reset : bool

If *True*, set all parameters to defaults before processing other keyword arguments. Default is *False*.

which : { 'major', 'minor', 'both' }

Default is 'major'; apply arguments to *which* ticks.

direction : { 'in', 'out', 'inout' }

Puts ticks inside the axes, outside the axes, or both.

length : float

Tick length in points.

width : float

Tick width in points.

color : color

Tick color; accepts any mpl color spec.

pad : float

Distance in points between tick and label.

labelsize : float or str

Tick label font size in points or as a string (e.g., 'large').

labelcolor : color

Tick label color; mpl color spec.

colors : color

Changes the tick color and the label color to the same value: mpl color spec.

zorder : float

Tick and label zorder.

bottom, top, left, right : bool or {'on', 'off'}

controls whether to draw the respective ticks.

labelbottom, labeltop, labelleft, labelright : bool or {'on', 'off'}

controls whether to draw the respective tick labels.

Examples

Usage

```
ax.tick_params(direction='out', length=6, width=2, colors='r')
```

This will make all major ticks be red, pointing out of the box, and with dimensions 6 points by 2 points. Tick labels will also be red.

matplotlib.axes.Axes.locator_params

Axes.locator_params(*axis='both', tight=None, **kwargs*)

Control behavior of tick locators.

Keyword arguments:

axis ['x' | 'y' | 'both'] Axis on which to operate; default is 'both'.

tight [True | False | None] Parameter passed to [autoscale_view\(\)](#). Default is None, for no change.

Remaining keyword arguments are passed to directly to the `set_params()` method.

Typically one might want to reduce the maximum number of ticks and use tight bounds when plotting small subplots, for example:

```
ax.locator_params(tight=True, nbins=4)
```

Because the locator is involved in autoscaling, `autoscale_view()` is called automatically after the parameters are changed.

This presently works only for the `MaxNLocator` used by default on linear axes, but it may be generalized.

19.6 Units

<code>Axes.convert_xunits</code>	For artists in an axes, if the xaxis has units support,
<code>Axes.convert_yunits</code>	For artists in an axes, if the yaxis has units support,
<code>Axes.have_units</code>	Return <i>True</i> if units are set on the <i>x</i> or <i>y</i> axes

19.6.1 matplotlib.axes.Axes.convert_xunits

`Axes.convert_xunits(x)`

For artists in an axes, if the xaxis has units support, convert *x* using xaxis unit type

19.6.2 matplotlib.axes.Axes.convert_yunits

`Axes.convert_yunits(y)`

For artists in an axes, if the yaxis has units support, convert *y* using yaxis unit type

19.6.3 matplotlib.axes.Axes.have_units

`Axes.have_units()`

Return *True* if units are set on the *x* or *y* axes

19.7 Adding Artists

<code>Axes.add_artist</code>	Add any <i>Artist</i> to the axes.
<code>Axes.add_collection</code>	Add a <i>Collection</i> instance to the axes.
<code>Axes.add_container</code>	Add a <i>Container</i> instance to the axes.
<code>Axes.add_image</code>	Add a <i>AxesImage</i> to the axes.
<code>Axes.add_line</code>	Add a <i>Line2D</i> to the list of plot

Continued on next page

Table 19.51 – continued from previous page

<code>Axes.add_patch</code>	Add a <i>Patch</i> <i>p</i> to the list of axes patches; the clipbox will be set to the Axes clipping box.
<code>Axes.add_table</code>	Add a <i>Table</i> instance to the

19.7.1 matplotlib.axes.Axes.add_artist

`Axes.add_artist(a)`

Add any *Artist* to the axes.

Use `add_artist` only for artists for which there is no dedicated “add” method; and if necessary, use a method such as `update_dataLim` or `update_dataLim_numerix` to manually update the `dataLim` if the artist is to be included in autoscaling.

Returns the artist.

19.7.2 matplotlib.axes.Axes.add_collection

`Axes.add_collection(collection, autolim=True)`

Add a *Collection* instance to the axes.

Returns the collection.

19.7.3 matplotlib.axes.Axes.add_container

`Axes.add_container(container)`

Add a *Container* instance to the axes.

Returns the collection.

19.7.4 matplotlib.axes.Axes.add_image

`Axes.add_image(image)`

Add a *AxesImage* to the axes.

Returns the image.

19.7.5 matplotlib.axes.Axes.add_line

`Axes.add_line(line)`

Add a *Line2D* to the list of plot lines

Returns the line.

19.7.6 matplotlib.axes.Axes.add_patch

Axes.add_patch(*p*)

Add a *Patch* *p* to the list of axes patches; the clipbox will be set to the Axes clipping box. If the transform is not set, it will be set to `transData`.

Returns the patch.

19.7.7 matplotlib.axes.Axes.add_table

Axes.add_table(*tab*)

Add a `Table` instance to the list of axes tables

Returns the table.

19.8 Twinning

<code>Axes.twinx</code>	Create a twin Axes sharing the xaxis
<code>Axes.twiny</code>	Create a twin Axes sharing the yaxis
<code>Axes.get_shared_x_axes</code>	Return a copy of the shared axes Grouper object for x axes
<code>Axes.get_shared_y_axes</code>	Return a copy of the shared axes Grouper object for y axes

19.8.1 matplotlib.axes.Axes.twinx

Axes.twinx()

Create a twin Axes sharing the xaxis

create a twin of Axes for generating a plot with a sharex x-axis but independent y axis. The y-axis of self will have ticks on left and the returned axes will have ticks on the right. To ensure tick marks of both axis align, see *LinearLocator*

Note: For those who are ‘picking’ artists while using `twinx`, pick events are only called for the artists in the top-most axes.

19.8.2 matplotlib.axes.Axes.twiny

Axes.twiny()

Create a twin Axes sharing the yaxis

create a twin of Axes for generating a plot with a shared y-axis but independent x axis. The x-axis of self will have ticks on bottom and the returned axes will have ticks on the top.

Note: For those who are ‘picking’ artists while using twiny, pick events are only called for the artists in the top-most axes.

19.8.3 matplotlib.axes.Axes.get_shared_x_axes

`Axes.get_shared_x_axes()`

Return a copy of the shared axes Grouper object for x axes

19.8.4 matplotlib.axes.Axes.get_shared_y_axes

`Axes.get_shared_y_axes()`

Return a copy of the shared axes Grouper object for y axes

19.9 Axes Position

<code>Axes.get_anchor</code>	
<code>Axes.set_anchor</code>	<i>anchor</i>
<code>Axes.get_axes_locator</code>	return axes_locator
<code>Axes.set_axes_locator</code>	set axes_locator
<code>Axes.reset_position</code>	Make the original position the active position
<code>Axes.get_position</code>	Return the a copy of the axes rectangle as a Bbox
<code>Axes.set_position</code>	Set the axes position

19.9.1 matplotlib.axes.Axes.get_anchor

`Axes.get_anchor()`

19.9.2 matplotlib.axes.Axes.set_anchor

`Axes.set_anchor(anchor)`

anchor

value	description
'C'	Center
'SW'	bottom left
'S'	bottom
'SE'	bottom right
'E'	right
'NE'	top right
'N'	top
'NW'	top left
'W'	left

19.9.3 matplotlib.axes.Axes.get_axes_locator

`Axes.get_axes_locator()`
return axes_locator

19.9.4 matplotlib.axes.Axes.set_axes_locator

`Axes.set_axes_locator(locator)`
set axes_locator

ACCEPT: a callable object which takes an axes instance and renderer and returns a bbox.

19.9.5 matplotlib.axes.Axes.reset_position

`Axes.reset_position()`
Make the original position the active position

19.9.6 matplotlib.axes.Axes.get_position

`Axes.get_position(original=False)`
Return the a copy of the axes rectangle as a Bbox

19.9.7 matplotlib.axes.Axes.set_position

`Axes.set_position(pos, which='both')`
Set the axes position

The expected shape of `pos` is:

```
pos = [left, bottom, width, height]
```

in relative 0,1 coords, or `pos` can be a *Bbox*

There are two position variables: one which is ultimately used, but which may be modified by `apply_aspect()`, and a second which is the starting point for `apply_aspect()`.

Optional keyword arguments: *which*

value	description
'active'	to change the first
'original'	to change the second
'both'	to change both

19.10 Async/Event based

<code>Axes.stale</code>	If the artist is 'stale' and needs to be re-drawn for the output to match the internal state of the artist.
<code>Axes.pchanged</code>	Fire an event when property changed, calling all of the registered callbacks.
<code>Axes.add_callback</code>	Adds a callback function that will be called whenever one of the <code>Artist</code> 's properties changes.
<code>Axes.remove_callback</code>	Remove a callback based on its <i>id</i> .

19.10.1 matplotlib.axes.Axes.stale

`Axes.stale`

If the artist is 'stale' and needs to be re-drawn for the output to match the internal state of the artist.

19.10.2 matplotlib.axes.Axes.pchanged

`Axes.pchanged()`

Fire an event when property changed, calling all of the registered callbacks.

19.10.3 matplotlib.axes.Axes.add_callback

`Axes.add_callback(func)`

Adds a callback function that will be called whenever one of the `Artist`'s properties changes.

Returns an *id* that is useful for removing the callback with `remove_callback()` later.

19.10.4 matplotlib.axes.Axes.remove_callback

`Axes.remove_callback(oid)`

Remove a callback based on its *id*.

See also:

`add_callback()` For adding callbacks

19.11 Interactive

<code>Axes.can_pan</code>	Return <i>True</i> if this axes supports any pan/zoom button functionality.
<code>Axes.can_zoom</code>	Return <i>True</i> if this axes supports the zoom box button functionality.
<code>Axes.get_navigate</code>	Get whether the axes responds to navigation commands
<code>Axes.set_navigate</code>	Set whether the axes responds to navigation toolbar commands
<code>Axes.get_navigate_mode</code>	Get the navigation toolbar button status: 'PAN', 'ZOOM', or None
<code>Axes.set_navigate_mode</code>	Set the navigation toolbar button status;
<code>Axes.start_pan</code>	Called when a pan operation has started.
<code>Axes.drag_pan</code>	Called when the mouse moves during a pan operation.
<code>Axes.end_pan</code>	Called when a pan operation completes (when the mouse button
<code>Axes.format_coord</code>	Return a format string formatting the <i>x, y</i> coord
<code>Axes.format_cursor_data</code>	Return <i>cursor data</i> string formatted.
<code>Axes.format_xdata</code>	Return <i>x</i> string formatted.
<code>Axes.format_ydata</code>	Return <i>y</i> string formatted.
<code>Axes.hitlist</code>	List the children of the artist which contain the mouse event <i>event</i> .
<code>Axes.mouseover</code>	
<code>Axes.in_axes</code>	Return <i>True</i> if the given <i>mouseevent</i> (in display coords)
<code>Axes.pick</code>	Trigger pick event
<code>Axes.pickable</code>	Return <i>True</i> if <i>Artist</i> is pickable.
<code>Axes.get_picker</code>	Return the picker object used by this artist
<code>Axes.set_picker</code>	Set the epsilon for picking used by this artist
<code>Axes.set_contains</code>	Replace the contains test used by this artist.
<code>Axes.get_contains</code>	Return the <code>_contains</code> test used by the artist, or <i>None</i> for default.
<code>Axes.contains</code>	Test whether the mouse event occurred in the axes.
<code>Axes.contains_point</code>	Returns <i>True</i> if the point (tuple of <i>x,y</i>) is inside the axes (the area defined by the its patch).
<code>Axes.get_cursor_data</code>	Get the cursor data for a given event.
<code>Axes.get_cursor_props</code>	Return the cursor properties as a (<i>linewidth, color</i>)
<code>Axes.set_cursor_props</code>	Set the cursor property as

19.11.1 matplotlib.axes.Axes.can_pan

`Axes.can_pan()`

Return *True* if this axes supports any pan/zoom button functionality.

19.11.2 matplotlib.axes.Axes.can_zoom

`Axes.can_zoom()`

Return *True* if this axes supports the zoom box button functionality.

19.11.3 matplotlib.axes.Axes.get_navigate

`Axes.get_navigate()`

Get whether the axes responds to navigation commands

19.11.4 matplotlib.axes.Axes.set_navigate

`Axes.set_navigate(b)`

Set whether the axes responds to navigation toolbar commands

ACCEPTS: [*True* | *False*]

19.11.5 matplotlib.axes.Axes.get_navigate_mode

`Axes.get_navigate_mode()`

Get the navigation toolbar button status: 'PAN', 'ZOOM', or None

19.11.6 matplotlib.axes.Axes.set_navigate_mode

`Axes.set_navigate_mode(b)`

Set the navigation toolbar button status;

Warning: this is not a user-API function.

19.11.7 matplotlib.axes.Axes.start_pan

`Axes.start_pan(x, y, button)`

Called when a pan operation has started.

x, *y* are the mouse coordinates in display coords. *button* is the mouse button number:

- 1: LEFT
- 2: MIDDLE
- 3: RIGHT

Note: Intended to be overridden by new projection types.

19.11.8 matplotlib.axes.Axes.drag_pan

`Axes.drag_pan(button, key, x, y)`

Called when the mouse moves during a pan operation.

button is the mouse button number:

- 1: LEFT
- 2: MIDDLE
- 3: RIGHT

key is a “shift” key

x, *y* are the mouse coordinates in display coords.

Note: Intended to be overridden by new projection types.

19.11.9 matplotlib.axes.Axes.end_pan

`Axes.end_pan()`

Called when a pan operation completes (when the mouse button is up.)

Note: Intended to be overridden by new projection types.

19.11.10 matplotlib.axes.Axes.format_coord

`Axes.format_coord(x, y)`

Return a format string formatting the *x*, *y* coord

19.11.11 matplotlib.axes.Axes.format_cursor_data

`Axes.format_cursor_data(data)`

Return *cursor data* string formatted.

19.11.12 matplotlib.axes.Axes.format_xdata

`Axes.format_xdata(x)`

Return *x* string formatted. This function will use the attribute `self.fmt_xdata` if it is callable, else will fall back on the xaxis major formatter

19.11.13 matplotlib.axes.Axes.format_ydata

`Axes.format_ydata(y)`

Return *y* string formatted. This function will use the `fmt_ydata` attribute if it is callable, else will fall back on the *yaxis* major formatter

19.11.14 matplotlib.axes.Axes.hitlist

`Axes.hitlist(event)`

List the children of the artist which contain the mouse event *event*.

19.11.15 matplotlib.axes.Axes.mouseover

`Axes.mouseover`

19.11.16 matplotlib.axes.Axes.in_axes

`Axes.in_axes(mouseevent)`

Return *True* if the given *mouseevent* (in display coords) is in the Axes

19.11.17 matplotlib.axes.Axes.pick

`Axes.pick(*args)`

Trigger pick event

Call signature:

```
pick(mouseevent)
```

each child artist will fire a pick event if *mouseevent* is over the artist and the artist has `picker` set

19.11.18 matplotlib.axes.Axes.pickable

`Axes.pickable()`

Return *True* if *Artist* is pickable.

19.11.19 matplotlib.axes.Axes.get_picker

`Axes.get_picker()`

Return the picker object used by this artist

19.11.20 `matplotlib.axes.Axes.set_picker`

`Axes.set_picker(picker)`

Set the epsilon for picking used by this artist

picker can be one of the following:

- *None*: picking is disabled for this artist (default)
- A boolean: if *True* then picking will be enabled and the artist will fire a pick event if the mouse event is over the artist
- A float: if *picker* is a number it is interpreted as an epsilon tolerance in points and the artist will fire off an event if it's data is within epsilon of the mouse event. For some artists like lines and patch collections, the artist may provide additional data to the pick event that is generated, e.g., the indices of the data within epsilon of the pick event
- A function: if *picker* is callable, it is a user supplied function which determines whether the artist is hit by the mouse event:

```
hit, props = picker(artist, mouseevent)
```

to determine the hit test. if the mouse event is over the artist, return *hit=True* and *props* is a dictionary of properties you want added to the `PickEvent` attributes.

ACCEPTS: [*None*|float|boolean|callable]

19.11.21 `matplotlib.axes.Axes.set_contains`

`Axes.set_contains(picker)`

Replace the contains test used by this artist. The new picker should be a callable function which determines whether the artist is hit by the mouse event:

```
hit, props = picker(artist, mouseevent)
```

If the mouse event is over the artist, return *hit = True* and *props* is a dictionary of properties you want returned with the contains test.

ACCEPTS: a callable function

19.11.22 `matplotlib.axes.Axes.get_contains`

`Axes.get_contains()`

Return the `_contains` test used by the artist, or *None* for default.

19.11.23 `matplotlib.axes.Axes.contains`

`Axes.contains(mouseevent)`

Test whether the mouse event occurred in the axes.

Returns *True* / *False*, {}

19.11.24 matplotlib.axes.Axes.contains_point

Axes.contains_point(*point*)

Returns *True* if the point (tuple of x,y) is inside the axes (the area defined by the its patch). A pixel coordinate is required.

19.11.25 matplotlib.axes.Axes.get_cursor_data

Axes.get_cursor_data(*event*)

Get the cursor data for a given event.

19.11.26 matplotlib.axes.Axes.get_cursor_props

Axes.get_cursor_props()

Return the cursor properties as a (*linewidth*, *color*) tuple, where *linewidth* is a float and *color* is an RGBA tuple

19.11.27 matplotlib.axes.Axes.set_cursor_props

Axes.set_cursor_props(**args*)

Set the cursor property as

Call signature

```
ax.set_cursor_props(linewidth, color)
```

or:

```
ax.set_cursor_props((linewidth, color))
```

ACCEPTS: a (*float*, *color*) tuple

19.12 Children

<i>Axes.get_children</i>	return a list of child artists
<i>Axes.get_images</i>	return a list of Axes images contained by the Axes
<i>Axes.get_lines</i>	Return a list of lines contained by the Axes
<i>Axes.findobj</i>	Find artist objects.

19.12.1 matplotlib.axes.Axes.get_children

`Axes.get_children()`
return a list of child artists

19.12.2 matplotlib.axes.Axes.get_images

`Axes.get_images()`
return a list of Axes images contained by the Axes

19.12.3 matplotlib.axes.Axes.get_lines

`Axes.get_lines()`
Return a list of lines contained by the Axes

19.12.4 matplotlib.axes.Axes.findobj

`Axes.findobj(match=None, include_self=True)`
Find artist objects.

Recursively find all *Artist* instances contained in self.

match can be

- None: return all objects contained in artist.
- function with signature `boolean = match(artist)` used to filter matches
- class instance: e.g., `Line2D`. Only return artists of class type.

If *include_self* is `True` (default), include self in the list to be checked for a match.

19.13 Drawing

<code>Axes.draw</code>	Draw everything (plot lines, axes, labels)
<code>Axes.draw_artist</code>	This method can only be used after an initial draw which caches the renderer.
<code>Axes.redraw_in_frame</code>	This method can only be used after an initial draw which caches the renderer.
<code>Axes.get_renderer_cache</code>	
<code>Axes.get_rasterization_zorder</code>	Get zorder value below which artists will be rasterized
<code>Axes.set_rasterization_zorder</code>	Set zorder value below which artists will be rasterized.
<code>Axes.get_window_extent</code>	get the axes bounding box in display space; <i>args</i> and
<code>Axes.get_tightbbox</code>	Return the tight bounding box of the axes.

19.13.1 matplotlib.axes.Axes.draw

`Axes.draw(artist, renderer, *args, **kwargs)`
Draw everything (plot lines, axes, labels)

19.13.2 matplotlib.axes.Axes.draw_artist

`Axes.draw_artist(a)`
This method can only be used after an initial draw which caches the renderer. It is used to efficiently update Axes data (axis ticks, labels, etc are not updated)

19.13.3 matplotlib.axes.Axes.redraw_in_frame

`Axes.redraw_in_frame()`
This method can only be used after an initial draw which caches the renderer. It is used to efficiently update Axes data (axis ticks, labels, etc are not updated)

19.13.4 matplotlib.axes.Axes.get_renderer_cache

`Axes.get_renderer_cache()`

19.13.5 matplotlib.axes.Axes.get_rasterization_zorder

`Axes.get_rasterization_zorder()`
Get zorder value below which artists will be rasterized

19.13.6 matplotlib.axes.Axes.set_rasterization_zorder

`Axes.set_rasterization_zorder(z)`
Set zorder value below which artists will be rasterized. Set to None to disable rasterizing of artists below a particular zorder.

19.13.7 matplotlib.axes.Axes.get_window_extent

`Axes.get_window_extent(*args, **kwargs)`
get the axes bounding box in display space; *args* and *kwargs* are empty

19.13.8 matplotlib.axes.Axes.get_tightbbox

`Axes.get_tightbbox(renderer, call_axes_locator=True)`
Return the tight bounding box of the axes. The dimension of the Bbox in canvas coordinate.

If `call_axes_locator` is `False`, it does not call the `_axes_locator` attribute, which is necessary to get the correct bounding box. `call_axes_locator==False` can be used if the caller is only interested in the relative size of the tightbbox compared to the axes bbox.

19.14 Bulk property manipulation

<code>Axes.set</code>	A property batch setter.
<code>Axes.update</code>	Update the properties of this <code>Artist</code> from the dictionary <code>prop</code> .
<code>Axes.properties</code>	return a dictionary mapping property name -> value for all <code>Artist</code> props
<code>Axes.update_from</code>	Copy properties from <code>other</code> to <code>self</code> .

19.14.1 matplotlib.axes.Axes.set

`Axes.set(**kwargs)`

A property batch setter. Pass `kwargs` to set properties.

19.14.2 matplotlib.axes.Axes.update

`Axes.update(props)`

Update the properties of this `Artist` from the dictionary `prop`.

19.14.3 matplotlib.axes.Axes.properties

`Axes.properties()`

return a dictionary mapping property name -> value for all `Artist` props

19.14.4 matplotlib.axes.Axes.update_from

`Axes.update_from(other)`

Copy properties from `other` to `self`.

19.15 General Artist Properties

<code>Axes.set_alpha</code>	Set the alpha value used for blending - not supported on all backends.
<code>Axes.set_animated</code>	Set the artist's animation state.
<code>Axes.set_clip_box</code>	Set the artist's clip <code>Bbox</code> .
<code>Axes.set_clip_on</code>	Set whether artist uses clipping.

Continued on next page

Table 19.59 – continued from previous page

<code>Axes.set_clip_path</code>	Set the artist's clip path, which may be:
<code>Axes.set_gid</code>	Sets the (group) id for the artist
<code>Axes.set_label</code>	Set the label to <i>s</i> for auto legend.
<code>Axes.set_url</code>	Sets the url for the artist
<code>Axes.set_visible</code>	Set the artist's visibility.
<code>Axes.set_zorder</code>	Set the zorder for the artist.
<code>Axes.set_rasterized</code>	Force rasterized (bitmap) drawing in vector backend output.
<code>Axes.set_sketch_params</code>	Sets the sketch parameters.
<code>Axes.set_agg_filter</code>	set <code>agg_filter</code> fuction.
<code>Axes.set_snap</code>	Sets the snap setting which may be:
<code>Axes.set_transform</code>	Set the <i>Transform</i> instance used by this artist.
<code>Axes.set_path_effects</code>	set <code>path_effects</code> , which should be a list of instances of
<code>Axes.get_agg_filter</code>	return filter function to be used for agg filter
<code>Axes.get_sketch_params</code>	Returns the sketch parameters for the artist.
<code>Axes.get_alpha</code>	Return the alpha value used for blending - not supported on all
<code>Axes.get_animated</code>	Return the artist's animated state
<code>Axes.get_clip_box</code>	Return artist clipbox
<code>Axes.get_clip_on</code>	Return whether artist uses clipping
<code>Axes.get_clip_path</code>	Return artist clip path
<code>Axes.get_gid</code>	Returns the group id
<code>Axes.get_label</code>	Get the label used for this artist in the legend.
<code>Axes.get_url</code>	Returns the url
<code>Axes.get_visible</code>	Return the artist's visibility
<code>Axes.get_zorder</code>	Return the Artist's zorder.
<code>Axes.get_rasterized</code>	return True if the artist is to be rasterized
<code>Axes.get_transform</code>	Return the <i>Transform</i> instance used by this artist.
<code>Axes.get_snap</code>	Returns the snap setting which may be:
<code>Axes.get_path_effects</code>	
<code>Axes.axes</code>	The <i>Axes</i> instance the artist resides in, or <i>None</i> .
<code>Axes.get_axes</code>	Return the <i>Axes</i> instance the artist resides in, or <i>None</i> .
<code>Axes.set_axes</code>	Set the <i>Axes</i> instance in which the artist resides, if any.
<code>Axes.set_figure</code>	Set the class: <i>Axes</i> figure
<code>Axes.get_figure</code>	Return the <i>Figure</i> instance the artist belongs to.

19.15.1 matplotlib.axes.Axes.set_alpha

`Axes.set_alpha(alpha)`

Set the alpha value used for blending - not supported on all backends.

ACCEPTS: float (0.0 transparent through 1.0 opaque)

19.15.2 `matplotlib.axes.Axes.set_animated`

`Axes.set_animated(b)`

Set the artist's animation state.

ACCEPTS: [True | False]

19.15.3 `matplotlib.axes.Axes.set_clip_box`

`Axes.set_clip_box(clipbox)`

Set the artist's clip *Bbox*.

ACCEPTS: a `matplotlib.transforms.Bbox` instance

19.15.4 `matplotlib.axes.Axes.set_clip_on`

`Axes.set_clip_on(b)`

Set whether artist uses clipping.

When False artists will be visible out side of the axes which can lead to unexpected results.

ACCEPTS: [True | False]

19.15.5 `matplotlib.axes.Axes.set_clip_path`

`Axes.set_clip_path(path, transform=None)`

Set the artist's clip path, which may be:

- a *Patch* (or subclass) instance
- a ***Path* instance, in which case** an optional *Transform* instance may be provided, which will be applied to the path before using it for clipping.
- *None*, to remove the clipping path

For efficiency, if the path happens to be an axis-aligned rectangle, this method will set the clipping box to the corresponding rectangle and set the clipping path to *None*.

ACCEPTS: [(*Path*, *Transform*) | *Patch* | None]

19.15.6 `matplotlib.axes.Axes.set_gid`

`Axes.set_gid(gid)`

Sets the (group) id for the artist

ACCEPTS: an id string

19.15.7 matplotlib.axes.Axes.set_label

`Axes.set_label(s)`

Set the label to *s* for auto legend.

ACCEPTS: string or anything printable with ‘%s’ conversion.

19.15.8 matplotlib.axes.Axes.set_url

`Axes.set_url(url)`

Sets the url for the artist

ACCEPTS: a url string

19.15.9 matplotlib.axes.Axes.set_visible

`Axes.set_visible(b)`

Set the artist’s visibility.

ACCEPTS: [True | False]

19.15.10 matplotlib.axes.Axes.set_zorder

`Axes.set_zorder(level)`

Set the zorder for the artist. Artists with lower zorder values are drawn first.

ACCEPTS: any number

19.15.11 matplotlib.axes.Axes.set_rasterized

`Axes.set_rasterized(rasterized)`

Force rasterized (bitmap) drawing in vector backend output.

Defaults to None, which implies the backend’s default behavior

ACCEPTS: [True | False | None]

19.15.12 matplotlib.axes.Axes.set_sketch_params

`Axes.set_sketch_params(scale=None, length=None, randomness=None)`

Sets the sketch parameters.

Parameters scale : float, optional

The amplitude of the wiggle perpendicular to the source line, in pixels. If scale is None, or not provided, no sketch filter will be provided.

length : float, optional

The length of the wiggle along the line, in pixels (default 128.0)

randomness : float, optional

The scale factor by which the length is shrunken or expanded (default 16.0)

19.15.13 matplotlib.axes.Axes.set_agg_filter

`Axes.set_agg_filter(filter_func)`
set `agg_filter` fuction.

19.15.14 matplotlib.axes.Axes.set_snap

`Axes.set_snap(snap)`

Sets the snap setting which may be:

- True: snap vertices to the nearest pixel center
- False: leave vertices as-is
- None: (auto) If the path contains only rectilinear line segments, round to the nearest pixel center

Only supported by the Agg and MacOSX backends.

19.15.15 matplotlib.axes.Axes.set_transform

`Axes.set_transform(t)`

Set the *Transform* instance used by this artist.

ACCEPTS: *Transform* instance

19.15.16 matplotlib.axes.Axes.set_path_effects

`Axes.set_path_effects(path_effects)`

set `path_effects`, which should be a list of instances of `matplotlib.patheffect._Base` class or its derivatives.

19.15.17 matplotlib.axes.Axes.get_agg_filter

`Axes.get_agg_filter()`

return filter function to be used for agg filter

19.15.18 matplotlib.axes.Axes.get_sketch_params

`Axes.get_sketch_params()`

Returns the sketch parameters for the artist.

Returns `sketch_params` : tuple or None

A 3-tuple with the following elements:

- `scale`: The amplitude of the wiggle perpendicular to the source line.
- `length`: The length of the wiggle along the line.
- `randomness`: The scale factor by which the length is shrunken or expanded.

May return None if no sketch parameters were set.

19.15.19 `matplotlib.axes.Axes.get_alpha`

`Axes.get_alpha()`

Return the alpha value used for blending - not supported on all backends

19.15.20 `matplotlib.axes.Axes.get_animated`

`Axes.get_animated()`

Return the artist's animated state

19.15.21 `matplotlib.axes.Axes.get_clip_box`

`Axes.get_clip_box()`

Return artist clipbox

19.15.22 `matplotlib.axes.Axes.get_clip_on`

`Axes.get_clip_on()`

Return whether artist uses clipping

19.15.23 `matplotlib.axes.Axes.get_clip_path`

`Axes.get_clip_path()`

Return artist clip path

19.15.24 `matplotlib.axes.Axes.get_gid`

`Axes.get_gid()`

Returns the group id

19.15.25 `matplotlib.axes.Axes.get_label`

`Axes.get_label()`

Get the label used for this artist in the legend.

19.15.26 `matplotlib.axes.Axes.get_url`

`Axes.get_url()`
Returns the url

19.15.27 `matplotlib.axes.Axes.get_visible`

`Axes.get_visible()`
Return the artist's visibility

19.15.28 `matplotlib.axes.Axes.get_zorder`

`Axes.get_zorder()`
Return the Artist's zorder.

19.15.29 `matplotlib.axes.Axes.get_rasterized`

`Axes.get_rasterized()`
return True if the artist is to be rasterized

19.15.30 `matplotlib.axes.Axes.get_transform`

`Axes.get_transform()`
Return the *Transform* instance used by this artist.

19.15.31 `matplotlib.axes.Axes.get_snap`

`Axes.get_snap()`
Returns the snap setting which may be:

- True: snap vertices to the nearest pixel center
- False: leave vertices as-is
- None: (auto) If the path contains only rectilinear line segments, round to the nearest pixel center

Only supported by the Agg and MacOSX backends.

19.15.32 `matplotlib.axes.Axes.get_path_effects`

`Axes.get_path_effects()`

19.15.33 matplotlib.axes.Axes.axes

Axes.axes

The *Axes* instance the artist resides in, or *None*.

19.15.34 matplotlib.axes.Axes.get_axes

Axes.get_axes()

Return the *Axes* instance the artist resides in, or *None*.

This has been deprecated in mpl 1.5, please use the axes property. Will be removed in 1.7 or 2.0.

19.15.35 matplotlib.axes.Axes.set_axes

Axes.set_axes(*axes*)

Set the *Axes* instance in which the artist resides, if any.

This has been deprecated in mpl 1.5, please use the axes property. Will be removed in 1.7 or 2.0.

ACCEPTS: an *Axes* instance

19.15.36 matplotlib.axes.Axes.set_figure

Axes.set_figure(*fig*)

Set the class:*Axes* figure

accepts a class:*Figure* instance

19.15.37 matplotlib.axes.Axes.get_figure

Axes.get_figure()

Return the *Figure* instance the artist belongs to.

19.16 Artist Methods

<i>Axes.is_figure_set</i>	Returns True if the artist is assigned to a <i>Figure</i> .
<i>Axes.remove</i>	Remove the artist from the figure if possible.
<i>Axes.is_transform_set</i>	Returns <i>True</i> if <i>Artist</i> has a transform explicitly set.

19.16.1 matplotlib.axes.Axes.is_figure_set

Axes.is_figure_set()

Returns True if the artist is assigned to a *Figure*.

19.16.2 matplotlib.axes.Axes.remove

Axes.remove()

Remove the artist from the figure if possible. The effect will not be visible until the figure is redrawn, e.g., with `matplotlib.axes.Axes.draw_idle()`. Call `matplotlib.axes.Axes.relim()` to update the axes limits if desired.

Note: `relim()` will not see collections even if the collection was added to axes with `autolim = True`.

Note: there is no support for removing the artist's legend entry.

19.16.3 matplotlib.axes.Axes.is_transform_set

Axes.is_transform_set()

Returns `True` if `Artist` has a transform explicitly set.

19.17 Projection

Methods used by `Axis` that must be overridden for non-rectilinear Axes.

<code>Axes.name</code>	
<code>Axes.get_xaxis_transform</code>	Get the transformation used for drawing x-axis labels, ticks and gridlines.
<code>Axes.get_yaxis_transform</code>	Get the transformation used for drawing y-axis labels, ticks and gridlines.
<code>Axes.get_data_ratio</code>	Returns the aspect ratio of the raw data.
<code>Axes.get_data_ratio_log</code>	Returns the aspect ratio of the raw data in log scale.
<code>Axes.get_xaxis_text1_transform</code>	Get the transformation used for drawing x-axis labels, which will add the given amount of padding (in points) between the axes and the label.
<code>Axes.get_xaxis_text2_transform</code>	Get the transformation used for drawing the secondary x-axis labels, which will add the given amount of padding (in points) between the axes and the label.
<code>Axes.get_yaxis_text1_transform</code>	Get the transformation used for drawing y-axis labels, which will add the given amount of padding (in points) between the axes and the label.
<code>Axes.get_yaxis_text2_transform</code>	Get the transformation used for drawing the secondary y-axis labels, which will add the given amount of padding (in points) between the axes and the label.

19.17.1 matplotlib.axes.Axes.name

`Axes.name = 'rectilinear'`

19.17.2 matplotlib.axes.Axes.get_xaxis_transform

`Axes.get_xaxis_transform`(*which='grid'*)

Get the transformation used for drawing x-axis labels, ticks and gridlines. The x-direction is in data coordinates and the y-direction is in axis coordinates.

Note: This transformation is primarily used by the `Axis` class, and is meant to be overridden by new kinds of projections that may need to place axis elements in different locations.

19.17.3 matplotlib.axes.Axes.get_yaxis_transform

`Axes.get_yaxis_transform`(*which='grid'*)

Get the transformation used for drawing y-axis labels, ticks and gridlines. The x-direction is in axis coordinates and the y-direction is in data coordinates.

Note: This transformation is primarily used by the `Axis` class, and is meant to be overridden by new kinds of projections that may need to place axis elements in different locations.

19.17.4 matplotlib.axes.Axes.get_data_ratio

`Axes.get_data_ratio`()

Returns the aspect ratio of the raw data.

This method is intended to be overridden by new projection types.

19.17.5 matplotlib.axes.Axes.get_data_ratio_log

`Axes.get_data_ratio_log`()

Returns the aspect ratio of the raw data in log scale. Will be used when both axis scales are in log.

19.17.6 matplotlib.axes.Axes.get_xaxis_text1_transform

`Axes.get_xaxis_text1_transform`(*pad_points*)

Get the transformation used for drawing x-axis labels, which will add the given amount of padding (in points) between the axes and the label. The x-direction is in data coordinates and the y-direction is in axis coordinates. Returns a 3-tuple of the form:

(transform, valign, halign)

where *valign* and *halign* are requested alignments for the text.

Note: This transformation is primarily used by the *Axis* class, and is meant to be overridden by new kinds of projections that may need to place axis elements in different locations.

19.17.7 matplotlib.axes.Axes.get_xaxis_text2_transform

Axes.get_xaxis_text2_transform(*pad_points*)

Get the transformation used for drawing the secondary x-axis labels, which will add the given amount of padding (in points) between the axes and the label. The x-direction is in data coordinates and the y-direction is in axis coordinates. Returns a 3-tuple of the form:

```
(transform, valign, halign)
```

where *valign* and *halign* are requested alignments for the text.

Note: This transformation is primarily used by the *Axis* class, and is meant to be overridden by new kinds of projections that may need to place axis elements in different locations.

19.17.8 matplotlib.axes.Axes.get_yaxis_text1_transform

Axes.get_yaxis_text1_transform(*pad_points*)

Get the transformation used for drawing y-axis labels, which will add the given amount of padding (in points) between the axes and the label. The x-direction is in axis coordinates and the y-direction is in data coordinates. Returns a 3-tuple of the form:

```
(transform, valign, halign)
```

where *valign* and *halign* are requested alignments for the text.

Note: This transformation is primarily used by the *Axis* class, and is meant to be overridden by new kinds of projections that may need to place axis elements in different locations.

19.17.9 matplotlib.axes.Axes.get_yaxis_text2_transform

Axes.get_yaxis_text2_transform(*pad_points*)

Get the transformation used for drawing the secondary y-axis labels, which will add the given amount of padding (in points) between the axes and the label. The x-direction is in axis coordinates and the y-direction is in data coordinates. Returns a 3-tuple of the form:

```
(transform, valign, halign)
```

where *valign* and *halign* are requested alignments for the text.

Note: This transformation is primarily used by the *Axis* class, and is meant to be overridden by new kinds of projections that may need to place axis elements in different locations.

19.18 Other

<i>Axes.zorder</i>	
<i>Axes.aname</i>	
<i>Axes.get_default_bbox_extra_artists</i>	
<i>Axes.get_transformed_clip_path_and_affine</i>	Return the clip path with the non-affine part of its transformation applied, and the remaining affine part of its transformation.
<i>Axes.has_data</i>	Return <i>True</i> if any artists have been added to axes.
<i>Axes.hold</i>	Deprecated since version 2.0.
<i>Axes.ishold</i>	Deprecated since version 2.0.

19.18.1 matplotlib.axes.Axes.zorder

`Axes.zorder = 0`

19.18.2 matplotlib.axes.Axes.aname

`Axes.aname = 'Axes'`

19.18.3 matplotlib.axes.Axes.get_default_bbox_extra_artists

`Axes.get_default_bbox_extra_artists()`

19.18.4 matplotlib.axes.Axes.get_transformed_clip_path_and_affine

`Axes.get_transformed_clip_path_and_affine()`

Return the clip path with the non-affine part of its transformation applied, and the remaining affine part of its transformation.

19.18.5 matplotlib.axes.Axes.has_data

Axes.has_data()

Return *True* if any artists have been added to axes.

This should not be used to determine whether the *dataLim* need to be updated, and may not actually be useful for anything.

19.18.6 matplotlib.axes.Axes.hold

Axes.hold(*b=None*)

Deprecated since version 2.0: `axes.hold` is deprecated. See the API Changes document (http://matplotlib.org/api/api_changes.html) for more details.

Set the hold state

The `hold` mechanism is deprecated and will be removed in v3.0. The behavior will remain consistent with the long-time default value of `True`.

If *hold* is *None* (default), toggle the *hold* state. Else set the *hold* state to boolean value *b*.

Examples:

```
# toggle hold
hold()

# turn hold on
hold(True)

# turn hold off
hold(False)
```

When `hold` is *True*, subsequent plot commands will be added to the current axes. When `hold` is *False*, the current axes and figure will be cleared on the next plot command

19.18.7 matplotlib.axes.Axes.ishold

Axes.ishold()

Deprecated since version 2.0: The `ishold` function was deprecated in version 2.0.

return the HOLD status of the axes

The *hold* mechanism is deprecated and will be removed in v3.0.

19.19 Inheritance

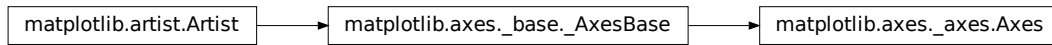

AXIS AND TICK API

Table of Contents

- *Inheritance*
- *Axis objects*
 - *Formatters and Locators*
 - *Axis Label*
 - *Ticks, tick labels and Offset text*
 - *Data and view intervals*
 - *Rendering helpers*
 - *Interactive*
 - *Units*
 - *Incremental navigation*
 - *YAxis Specific*
 - *XAxis Specific*
 - *Other*
 - *Discouraged*
- *Tick objects*
- *Common and inherited methods*
 - *XTick*
 - *YTick*
 - *YAxis*
 - *YAxis*
 - *Inherited from artist*
 - * *Ticks*

* *Axis*

Classes for the ticks and x and y axis

20.1 Inheritance

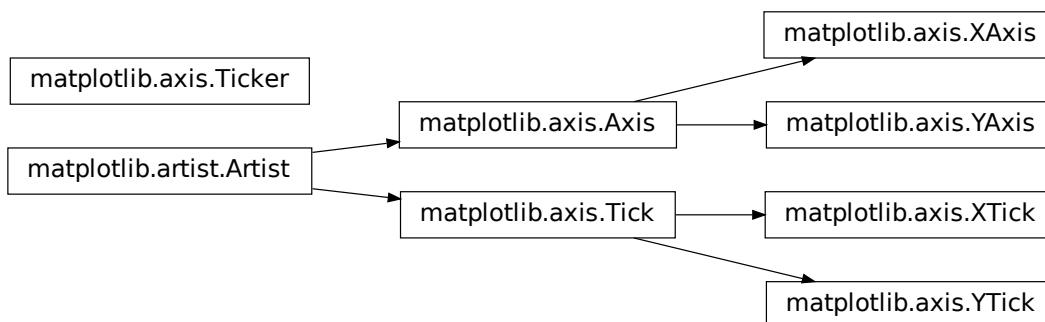

20.2 Axis objects

class matplotlib.axis.**Axis**(axes, pickradius=15)

Public attributes

- axes.transData - transform data coords to display coords
- axes.transAxes - transform axis coords to display coords
- labelpad - number of points between the axis and its label

Init the axis with the parent Axes instance

class matplotlib.axis.**XAxis**(axes, pickradius=15)

Init the axis with the parent Axes instance

class matplotlib.axis.**YAxis**(axes, pickradius=15)

Init the axis with the parent Axes instance

class matplotlib.axis.**Ticker**

Axis.cla

clear the current axis

Axis.get_scale

20.2.1 matplotlib.axis.Axis.cla

`Axis.cla()`
clear the current axis

20.2.2 matplotlib.axis.Axis.get_scale

`Axis.get_scale()`

20.2.3 Formatters and Locators

<i>Axis.get_major_formatter</i>	Get the formatter of the major ticker
<i>Axis.get_major_locator</i>	Get the locator of the major ticker
<i>Axis.get_minor_formatter</i>	Get the formatter of the minor ticker
<i>Axis.get_minor_locator</i>	Get the locator of the minor ticker
<i>Axis.set_major_formatter</i>	Set the formatter of the major ticker
<i>Axis.set_major_locator</i>	Set the locator of the major ticker
<i>Axis.set_minor_formatter</i>	Set the formatter of the minor ticker
<i>Axis.set_minor_locator</i>	Set the locator of the minor ticker

matplotlib.axis.Axis.get_major_formatter

`Axis.get_major_formatter()`
Get the formatter of the major ticker

matplotlib.axis.Axis.get_major_locator

`Axis.get_major_locator()`
Get the locator of the major ticker

matplotlib.axis.Axis.get_minor_formatter

`Axis.get_minor_formatter()`
Get the formatter of the minor ticker

matplotlib.axis.Axis.get_minor_locator

`Axis.get_minor_locator()`
Get the locator of the minor ticker

matplotlib.axis.Axis.set_major_formatter

`Axis.set_major_formatter(formatter)`
 Set the formatter of the major ticker
 ACCEPTS: A *Formatter* instance

matplotlib.axis.Axis.set_major_locator

`Axis.set_major_locator(locator)`
 Set the locator of the major ticker
 ACCEPTS: a *Locator* instance

matplotlib.axis.Axis.set_minor_formatter

`Axis.set_minor_formatter(formatter)`
 Set the formatter of the minor ticker
 ACCEPTS: A *Formatter* instance

matplotlib.axis.Axis.set_minor_locator

`Axis.set_minor_locator(locator)`
 Set the locator of the minor ticker
 ACCEPTS: a *Locator* instance

20.2.4 Axis Label

<code>Axis.set_label_coords</code>	Set the coordinates of the label.
<code>Axis.set_label_position</code>	Set the label position (top or bottom)
<code>Axis.set_label_text</code>	Sets the text value of the axis label
<code>Axis.get_label_position</code>	Return the label position (top or bottom)
<code>Axis.get_label_text</code>	Get the text of the label

matplotlib.axis.Axis.set_label_coords

`Axis.set_label_coords(x, y, transform=None)`

Set the coordinates of the label. By default, the x coordinate of the y label is determined by the tick label bounding boxes, but this can lead to poor alignment of multiple ylabels if there are multiple axes. Ditto for the y coordinate of the x label.

You can also specify the coordinate system of the label with the transform. If None, the default coordinate system will be the axes coordinate system (0,0) is (left,bottom), (0.5, 0.5) is middle, etc

matplotlib.axis.Axis.set_label_position

Axis.set_label_position(*position*)
 Set the label position (top or bottom)
 ACCEPTS: ['top' | 'bottom']

matplotlib.axis.Axis.set_label_text

Axis.set_label_text(*label*, *fontdict=None*, ***kwargs*)
 Sets the text value of the axis label
 ACCEPTS: A string value for the label

matplotlib.axis.Axis.get_label_position

Axis.get_label_position()
 Return the label position (top or bottom)

matplotlib.axis.Axis.get_label_text

Axis.get_label_text()
 Get the text of the label

20.2.5 Ticks, tick labels and Offset text

<i>Axis.get_major_ticks</i>	get the tick instances; grow as necessary
<i>Axis.get_majorticklabels</i>	Return a list of Text instances for the major ticklabels
<i>Axis.get_majorticklines</i>	Return the major tick lines as a list of Line2D instances
<i>Axis.get_majorticklocs</i>	Get the major tick locations in data coordinates as a numpy array
<i>Axis.get_minor_ticks</i>	get the minor tick instances; grow as necessary
<i>Axis.get_minorticklabels</i>	Return a list of Text instances for the minor ticklabels
<i>Axis.get_minorticklines</i>	Return the minor tick lines as a list of Line2D instances
<i>Axis.get_minorticklocs</i>	Get the minor tick locations in data coordinates as a numpy array
<i>Axis.get_offset_text</i>	Return the axis offsetText as a Text instance
<i>Axis.get_tick_padding</i>	
<i>Axis.get_ticklabels</i>	Get the x tick labels as a list of Text instances.
<i>Axis.get_ticklines</i>	Return the tick lines as a list of Line2D instances
<i>Axis.get_ticklocs</i>	Get the tick locations in data coordinates as a numpy array

Continued on next page

Table 20.4 – continued from previous page

<code>Axis.get_gridlines</code>	Return the grid lines as a list of Line2D instance
<code>Axis.grid</code>	Set the axis grid on or off; <i>b</i> is a boolean.
<code>Axis.iter_ticks</code>	Iterate through all of the major and minor ticks.
<code>Axis.set_tick_params</code>	Set appearance parameters for ticks and ticklabels.
<code>Axis.axis_date</code>	Sets up x-axis ticks and labels that treat the x data as dates.

matplotlib.axis.Axis.get_major_ticks

`Axis.get_major_ticks`(*numticks=None*)
get the tick instances; grow as necessary

matplotlib.axis.Axis.get_majorticklabels

`Axis.get_majorticklabels`()
Return a list of Text instances for the major ticklabels

matplotlib.axis.Axis.get_majorticklines

`Axis.get_majorticklines`()
Return the major tick lines as a list of Line2D instances

matplotlib.axis.Axis.get_majorticklocs

`Axis.get_majorticklocs`()
Get the major tick locations in data coordinates as a numpy array

matplotlib.axis.Axis.get_minor_ticks

`Axis.get_minor_ticks`(*numticks=None*)
get the minor tick instances; grow as necessary

matplotlib.axis.Axis.get_minorticklabels

`Axis.get_minorticklabels`()
Return a list of Text instances for the minor ticklabels

matplotlib.axis.Axis.get_minorticklines

`Axis.get_minorticklines`()
Return the minor tick lines as a list of Line2D instances

matplotlib.axis.Axis.get_minorticklocs**Axis.get_minorticklocs()**

Get the minor tick locations in data coordinates as a numpy array

matplotlib.axis.Axis.get_offset_text**Axis.get_offset_text()**

Return the axis offsetText as a Text instance

matplotlib.axis.Axis.get_tick_padding**Axis.get_tick_padding()****matplotlib.axis.Axis.get_ticklabels****Axis.get_ticklabels**(*minor=False, which=None*)Get the x tick labels as a list of *Text* instances.**Parameters** **minor** : bool

If True return the minor ticklabels, else return the major ticklabels

which : None, ('minor', 'major', 'both')Overrides **minor**.

Selects which ticklabels to return

Returns **ret** : listList of *Text* instances.**matplotlib.axis.Axis.get_ticklines****Axis.get_ticklines**(*minor=False*)

Return the tick lines as a list of Line2D instances

matplotlib.axis.Axis.get_ticklocs**Axis.get_ticklocs**(*minor=False*)

Get the tick locations in data coordinates as a numpy array

matplotlib.axis.Axis.get_gridlines**Axis.get_gridlines()**

Return the grid lines as a list of Line2D instance

matplotlib.axis.Axis.grid**Axis.grid(*b=None, which='major', **kwargs*)**

Set the axis grid on or off; *b* is a boolean. Use *which* = 'major' | 'minor' | 'both' to set the grid for major or minor ticks.

If *b* is *None* and `len(kwargs)==0`, toggle the grid state. If *kwargs* are supplied, it is assumed you want the grid on and *b* will be set to True.

kwargs are used to set the line properties of the grids, e.g.,

```
xax.grid(color='r', linestyle='-', linewidth=2)
```

matplotlib.axis.Axis.iter_ticks**Axis.iter_ticks()**

Iterate through all of the major and minor ticks.

matplotlib.axis.Axis.set_tick_params**Axis.set_tick_params(*which='major, reset=False, **kw*)**

Set appearance parameters for ticks and ticklabels.

For documentation of keyword arguments, see `matplotlib.axes.Axes.tick_params()`.

matplotlib.axis.Axis.axis_date**Axis.axis_date(*tz=None*)**

Sets up x-axis ticks and labels that treat the x data as dates. *tz* is a `tzinfo` instance or a timezone string. This timezone is used to create date labels.

20.2.6 Data and view intervals

<code>Axis.get_data_interval</code>	return the Interval instance for this axis data limits
<code>Axis.get_view_interval</code>	return the Interval instance for this axis view limits
<code>Axis.set_data_interval</code>	set the axis data limits
<code>Axis.set_view_interval</code>	

matplotlib.axis.Axis.get_data_interval**Axis.get_data_interval()**

return the Interval instance for this axis data limits

matplotlib.axis.Axis.get_view_interval**Axis.get_view_interval()**

return the Interval instance for this axis view limits

matplotlib.axis.Axis.set_data_interval**Axis.set_data_interval()**

set the axis data limits

matplotlib.axis.Axis.set_view_interval**Axis.set_view_interval(*vmin, vmax, ignore=False*)****20.2.7 Rendering helpers**

<i>Axis.get_minpos</i>	
<i>Axis.get_tick_space</i>	Return the estimated number of ticks that can fit on the axis.
<i>Axis.get_ticklabel_extents</i>	Get the extents of the tick labels on either side of the axes.
<i>Axis.get_tightbbox</i>	Return a bounding box that encloses the axis.

matplotlib.axis.Axis.get_minpos**Axis.get_minpos()****matplotlib.axis.Axis.get_tick_space****Axis.get_tick_space()**

Return the estimated number of ticks that can fit on the axis.

matplotlib.axis.Axis.get_ticklabel_extents**Axis.get_ticklabel_extents(*renderer*)**

Get the extents of the tick labels on either side of the axes.

matplotlib.axis.Axis.get_tightbbox

`Axis.get_tightbbox(renderer)`

Return a bounding box that encloses the axis. It only accounts tick labels, axis label, and `offsetText`.

20.2.8 Interactive

<code>Axis.get_pickradius</code>	Return the depth of the axis used by the picker
<code>Axis.set_pickradius</code>	Set the depth of the axis used by the picker

matplotlib.axis.Axis.get_pickradius

`Axis.get_pickradius()`

Return the depth of the axis used by the picker

matplotlib.axis.Axis.set_pickradius

`Axis.set_pickradius(pickradius)`

Set the depth of the axis used by the picker

ACCEPTS: a distance in points

20.2.9 Units

<code>Axis.convert_units</code>	
<code>Axis.set_units</code>	set the units for axis
<code>Axis.get_units</code>	return the units for axis
<code>Axis.update_units</code>	introspect <i>data</i> for units converter and update the

matplotlib.axis.Axis.convert_units

`Axis.convert_units(x)`

matplotlib.axis.Axis.set_units

`Axis.set_units(u)`

set the units for axis

ACCEPTS: a units tag

matplotlib.axis.Axis.get_units**Axis.get_units()**

return the units for axis

matplotlib.axis.Axis.update_units**Axis.update_units(*data*)**introspect *data* for units converter and update the axis.converter instance if necessary. Return *True* if *data* is registered for unit conversion.**20.2.10 Incremental navigation**

<i>Axis.pan</i>	Pan <i>numsteps</i> (can be positive or negative)
<i>Axis.zoom</i>	Zoom in/out on axis; if <i>direction</i> is >0 zoom in, else zoom out

matplotlib.axis.Axis.pan**Axis.pan(*numsteps*)**Pan *numsteps* (can be positive or negative)**matplotlib.axis.Axis.zoom****Axis.zoom(*direction*)**Zoom in/out on axis; if *direction* is >0 zoom in, else zoom out**20.2.11 YAxis Specific**

<i>YAxis.axis_name</i>	
<i>YAxis.get_text_widths</i>	
<i>YAxis.get_ticks_position</i>	Return the ticks position (left, right, both or unknown)
<i>YAxis.set_offset_position</i>	
<i>YAxis.set_ticks_position</i>	Set the ticks position (left, right, both, default or none) 'both' sets the ticks to appear on both positions, but does not change the tick labels.
<i>YAxis.tick_left</i>	use ticks only on left
<i>YAxis.tick_right</i>	use ticks only on right

matplotlib.axis.YAxis.axis_name**YAxis.axis_name = 'y'**

matplotlib.axis.YAxis.get_text_widths

YAxis.get_text_widths(*renderer*)

matplotlib.axis.YAxis.get_ticks_position

YAxis.get_ticks_position()

Return the ticks position (left, right, both or unknown)

matplotlib.axis.YAxis.set_offset_position

YAxis.set_offset_position(*position*)

matplotlib.axis.YAxis.set_ticks_position

YAxis.set_ticks_position(*position*)

Set the ticks position (left, right, both, default or none) ‘both’ sets the ticks to appear on both positions, but does not change the tick labels. ‘default’ resets the tick positions to the default: ticks on both positions, labels at left. ‘none’ can be used if you don’t want any ticks. ‘none’ and ‘both’ affect only the ticks, not the labels.

ACCEPTS: [‘left’ | ‘right’ | ‘both’ | ‘default’ | ‘none’]

matplotlib.axis.YAxis.tick_left

YAxis.tick_left()

use ticks only on left

matplotlib.axis.YAxis.tick_right

YAxis.tick_right()

use ticks only on right

20.2.12 XAxis Specific

XAxis.axis_name

XAxis.get_text_heights

Returns the amount of space one should reserve for text above and below the axes.

XAxis.get_ticks_position

Return the ticks position (top, bottom, default or unknown)

Continued on next page

Table 20.11 – continued from previous page

<code>XAxis.set_ticks_position</code>	Set the ticks position (top, bottom, both, default or none) both sets the ticks to appear on both positions, but does not change the tick labels.
<code>XAxis.tick_bottom</code>	use ticks only on bottom
<code>XAxis.tick_top</code>	use ticks only on top

matplotlib.axis.XAxis.axis_name

`XAxis.axis_name = 'x'`

matplotlib.axis.XAxis.get_text_heights

`XAxis.get_text_heights(renderer)`

Returns the amount of space one should reserve for text above and below the axes. Returns a tuple (above, below)

matplotlib.axis.XAxis.get_ticks_position

`XAxis.get_ticks_position()`

Return the ticks position (top, bottom, default or unknown)

matplotlib.axis.XAxis.set_ticks_position

`XAxis.set_ticks_position(position)`

Set the ticks position (top, bottom, both, default or none) both sets the ticks to appear on both positions, but does not change the tick labels. 'default' resets the tick positions to the default: ticks on both positions, labels at bottom. 'none' can be used if you don't want any ticks. 'none' and 'both' affect only the ticks, not the labels.

ACCEPTS: ['top' | 'bottom' | 'both' | 'default' | 'none']

matplotlib.axis.XAxis.tick_bottom

`XAxis.tick_bottom()`

use ticks only on bottom

matplotlib.axis.XAxis.tick_top

`XAxis.tick_top()`

use ticks only on top

20.2.13 Other

<i>Axis.OFFSETTEXPAD</i>	
<i>Axis.limit_range_for_scale</i>	
<i>Axis.reset_ticks</i>	
<i>Axis.set_default_intervals</i>	set the default limits for the axis data and view interval if they
<i>Axis.get_smart_bounds</i>	get whether the axis has smart bounds
<i>Axis.set_smart_bounds</i>	set the axis to have smart bounds

matplotlib.axis.Axis.OFFSETTEXPAD

`Axis.OFFSETTEXPAD = 3`

matplotlib.axis.Axis.limit_range_for_scale

`Axis.limit_range_for_scale(vmin, vmax)`

matplotlib.axis.Axis.reset_ticks

`Axis.reset_ticks()`

matplotlib.axis.Axis.set_default_intervals

`Axis.set_default_intervals()`
set the default limits for the axis data and view interval if they are not mutated

matplotlib.axis.Axis.get_smart_bounds

`Axis.get_smart_bounds()`
get whether the axis has smart bounds

matplotlib.axis.Axis.set_smart_bounds

`Axis.set_smart_bounds(value)`
set the axis to have smart bounds

20.2.14 Discouraged

These methods implicitly use *FixedLocator* and *FixedFormatter*. They can be convenient, but if not used together may de-couple your tick labels from your data.

<code>Axis.set_ticklabels</code>	Set the text values of the tick labels.
<code>Axis.set_ticks</code>	Set the locations of the tick marks from sequence ticks

matplotlib.axis.Axis.set_ticklabels

`Axis.set_ticklabels`(*ticklabels*, **args*, ***kwargs*)

Set the text values of the tick labels. Return a list of Text instances. Use *kwarg minor=True* to select minor ticks. All other *kwargs* are used to update the text object properties. As for `get_ticklabels`, *label1* (left or bottom) is affected for a given tick only if its *label1On* attribute is True, and similarly for *label2*. The list of returned label text objects consists of all such *label1* objects followed by all such *label2* objects.

The input *ticklabels* is assumed to match the set of tick locations, regardless of the state of *label1On* and *label2On*.

ACCEPTS: sequence of strings or Text objects

matplotlib.axis.Axis.set_ticks

`Axis.set_ticks`(*ticks*, *minor=False*)

Set the locations of the tick marks from sequence ticks

ACCEPTS: sequence of floats

20.3 Tick objects

```
class matplotlib.axis.Tick(axes, loc, label, size=None, width=None, color=None, tick-
dir=None, pad=None, labelsize=None, labelcolor=None,
zorder=None, gridOn=None, tick1On=True, tick2On=True,
label1On=True, label2On=False, major=True)
```

Abstract base class for the axis ticks, grid lines and labels

1 refers to the bottom of the plot for *xticks* and the left for *yticks* 2 refers to the top of the plot for *xticks* and the right for *yticks*

Publicly accessible attributes:

tick1line a Line2D instance

tick2line a Line2D instance

gridline a Line2D instance

label1 a Text instance

label12 a Text instance

gridOn a boolean which determines whether to draw the tickline

tick1On a boolean which determines whether to draw the 1st tickline

tick2On a boolean which determines whether to draw the 2nd tickline

label1On a boolean which determines whether to draw tick label

label2On a boolean which determines whether to draw tick label

bbox is the Bound2D bounding box in display coords of the Axes loc is the tick location in data coords
size is the tick size in points

class matplotlib.axis.XTick(*axes, loc, label, size=None, width=None, color=None, tick-dir=None, pad=None, labelsiz=None, labelcolor=None, zorder=None, gridOn=None, tick1On=True, tick2On=True, label1On=True, label2On=False, major=True*)

Contains all the Artists needed to make an x tick - the tick line, the label text and the grid line

bbox is the Bound2D bounding box in display coords of the Axes loc is the tick location in data coords
size is the tick size in points

class matplotlib.axis.YTick(*axes, loc, label, size=None, width=None, color=None, tick-dir=None, pad=None, labelsiz=None, labelcolor=None, zorder=None, gridOn=None, tick1On=True, tick2On=True, label1On=True, label2On=False, major=True*)

Contains all the Artists needed to make a Y tick - the tick line, the label text and the grid line

bbox is the Bound2D bounding box in display coords of the Axes loc is the tick location in data coords
size is the tick size in points

<i>Tick.apply_tickdir</i>	Calculate self._pad and self._tickmarkers
<i>Tick.get_loc</i>	Return the tick location (data coords) as a scalar
<i>Tick.get_pad</i>	Get the value of the tick label pad in points
<i>Tick.get_pad_pixels</i>	
<i>Tick.get_tick_padding</i>	Get the length of the tick outside of the axes.
<i>Tick.get_tickdir</i>	
<i>Tick.get_view_interval</i>	return the view Interval instance for the axis this tick is ticking
<i>Tick.set_label1</i>	Set the text of ticklabel
<i>Tick.set_label2</i>	Set the text of ticklabel2
<i>Tick.set_pad</i>	Set the tick label pad in points
<i>Tick.update_position</i>	Set the location of tick in data coords with scalar <i>loc</i>

20.3.1 matplotlib.axis.Tick.apply_tickdir

Tick.apply_tickdir(*tickdir*)

Calculate self._pad and self._tickmarkers

20.3.2 matplotlib.axis.Tick.get_loc

`Tick.get_loc()`

Return the tick location (data coords) as a scalar

20.3.3 matplotlib.axis.Tick.get_pad

`Tick.get_pad()`

Get the value of the tick label pad in points

20.3.4 matplotlib.axis.Tick.get_pad_pixels

`Tick.get_pad_pixels()`

20.3.5 matplotlib.axis.Tick.get_tick_padding

`Tick.get_tick_padding()`

Get the length of the tick outside of the axes.

20.3.6 matplotlib.axis.Tick.get_tickdir

`Tick.get_tickdir()`

20.3.7 matplotlib.axis.Tick.get_view_interval

`Tick.get_view_interval()`

return the view Interval instance for the axis this tick is ticking

20.3.8 matplotlib.axis.Tick.set_label1

`Tick.set_label1(s)`

Set the text of ticklabel

ACCEPTS: str

20.3.9 matplotlib.axis.Tick.set_label2

`Tick.set_label2(s)`

Set the text of ticklabel2

ACCEPTS: str

20.3.10 matplotlib.axis.Tick.set_pad

Tick.**set_pad**(*val*)

Set the tick label pad in points

ACCEPTS: float

20.3.11 matplotlib.axis.Tick.update_position

Tick.**update_position**(*loc*)

Set the location of tick in data coords with scalar *loc*

20.4 Common and inherited methods

20.4.1 XTick

<i>XTick.apply_tickdir</i>	
<i>XTick.get_loc</i>	Return the tick location (data coords) as a scalar
<i>XTick.get_pad</i>	Get the value of the tick label pad in points
<i>XTick.get_pad_pixels</i>	
<i>XTick.get_tick_padding</i>	Get the length of the tick outside of the axes.
<i>XTick.get_tickdir</i>	
<i>XTick.get_view_interval</i>	return the Interval instance for this axis view limits
<i>XTick.set_label1</i>	Set the text of ticklabel
<i>XTick.set_label2</i>	Set the text of ticklabel2
<i>XTick.set_pad</i>	Set the tick label pad in points
<i>XTick.update_position</i>	Set the location of tick in data coords with scalar <i>loc</i>

matplotlib.axis.XTick.apply_tickdir

XTick.**apply_tickdir**(*tickdir*)

matplotlib.axis.XTick.get_loc

XTick.**get_loc**()

Return the tick location (data coords) as a scalar

matplotlib.axis.XTick.get_pad

XTick.**get_pad**()

Get the value of the tick label pad in points

matplotlib.axis.XTick.get_pad_pixels

`XTick.get_pad_pixels()`

matplotlib.axis.XTick.get_tick_padding

`XTick.get_tick_padding()`

Get the length of the tick outside of the axes.

matplotlib.axis.XTick.get_tickdir

`XTick.get_tickdir()`

matplotlib.axis.XTick.get_view_interval

`XTick.get_view_interval()`

return the Interval instance for this axis view limits

matplotlib.axis.XTick.set_label1

`XTick.set_label1(s)`

Set the text of ticklabel

ACCEPTS: str

matplotlib.axis.XTick.set_label2

`XTick.set_label2(s)`

Set the text of ticklabel2

ACCEPTS: str

matplotlib.axis.XTick.set_pad

`XTick.set_pad(val)`

Set the tick label pad in points

ACCEPTS: float

matplotlib.axis.XTick.update_position

`XTick.update_position(loc)`

Set the location of tick in data coords with scalar *loc*

20.4.2 YTick

<i>YTick.apply_tickdir</i>	
<i>YTick.get_loc</i>	Return the tick location (data coords) as a scalar
<i>YTick.get_pad</i>	Get the value of the tick label pad in points
<i>YTick.get_pad_pixels</i>	
<i>YTick.get_tick_padding</i>	Get the length of the tick outside of the axes.
<i>YTick.get_tickdir</i>	
<i>YTick.get_view_interval</i>	return the Interval instance for this axis view limits
<i>YTick.set_label1</i>	Set the text of ticklabel
<i>YTick.set_label2</i>	Set the text of ticklabel2
<i>YTick.set_pad</i>	Set the tick label pad in points
<i>YTick.update_position</i>	Set the location of tick in data coords with scalar loc

matplotlib.axis.YTick.apply_tickdir

`YTick.apply_tickdir(tickdir)`

matplotlib.axis.YTick.get_loc

`YTick.get_loc()`
Return the tick location (data coords) as a scalar

matplotlib.axis.YTick.get_pad

`YTick.get_pad()`
Get the value of the tick label pad in points

matplotlib.axis.YTick.get_pad_pixels

`YTick.get_pad_pixels()`

matplotlib.axis.YTick.get_tick_padding

`YTick.get_tick_padding()`
Get the length of the tick outside of the axes.

matplotlib.axis.YTick.get_tickdir

`YTick.get_tickdir()`

matplotlib.axis.YTick.get_view_interval**YTick.get_view_interval()**

return the Interval instance for this axis view limits

matplotlib.axis.YTick.set_label1**YTick.set_label1(*s*)**

Set the text of ticklabel

ACCEPTS: str

matplotlib.axis.YTick.set_label2**YTick.set_label2(*s*)**

Set the text of ticklabel2

ACCEPTS: str

matplotlib.axis.YTick.set_pad**YTick.set_pad(*val*)**

Set the tick label pad in points

ACCEPTS: float

matplotlib.axis.YTick.update_position**YTick.update_position(*loc*)**

Set the location of tick in data coords with scalar loc

20.4.3 YAxis

<i>YAxis.OFFSETTEXTPAD</i>	
<i>YAxis.axis_date</i>	Sets up x-axis ticks and labels that treat the x data as dates.
<i>YAxis.cla</i>	clear the current axis
<i>YAxis.convert_units</i>	
<i>YAxis.get_data_interval</i>	return the Interval instance for this axis data limits
<i>YAxis.get_gridlines</i>	Return the grid lines as a list of Line2D instance
<i>YAxis.get_label_position</i>	Return the label position (top or bottom)
<i>YAxis.get_label_text</i>	Get the text of the label
<i>YAxis.get_major_formatter</i>	Get the formatter of the major ticker
<i>YAxis.get_major_locator</i>	Get the locator of the major ticker

Continued on next page

Table 20.17 – continued from previous page

<code>YAxis.get_major_ticks</code>	get the tick instances; grow as necessary
<code>YAxis.get_majorticklabels</code>	Return a list of <code>Text</code> instances for the major ticklabels
<code>YAxis.get_majorticklines</code>	Return the major tick lines as a list of <code>Line2D</code> instances
<code>YAxis.get_majorticklocs</code>	Get the major tick locations in data coordinates as a numpy array
<code>YAxis.get_minor_formatter</code>	Get the formatter of the minor ticker
<code>YAxis.get_minor_locator</code>	Get the locator of the minor ticker
<code>YAxis.get_minor_ticks</code>	get the minor tick instances; grow as necessary
<code>YAxis.get_minorticklabels</code>	Return a list of <code>Text</code> instances for the minor ticklabels
<code>YAxis.get_minorticklines</code>	Return the minor tick lines as a list of <code>Line2D</code> instances
<code>YAxis.get_minorticklocs</code>	Get the minor tick locations in data coordinates as a numpy array
<code>YAxis.get_minpos</code>	
<code>YAxis.get_offset_text</code>	Return the axis <code>offsetText</code> as a <code>Text</code> instance
<code>YAxis.get_pickradius</code>	Return the depth of the axis used by the picker
<code>YAxis.get_scale</code>	
<code>YAxis.get_smart_bounds</code>	get whether the axis has smart bounds
<code>YAxis.get_tick_padding</code>	
<code>YAxis.get_tick_space</code>	
<code>YAxis.get_ticklabel_extents</code>	Get the extents of the tick labels on either side of the axes.
<code>YAxis.get_ticklabels</code>	Get the x tick labels as a list of <code>Text</code> instances.
<code>YAxis.get_ticklines</code>	Return the tick lines as a list of <code>Line2D</code> instances
<code>YAxis.get_ticklocs</code>	Get the tick locations in data coordinates as a numpy array
<code>YAxis.get_tightbbox</code>	Return a bounding box that encloses the axis.
<code>YAxis.get_units</code>	return the units for axis
<code>YAxis.get_view_interval</code>	return the <code>Interval</code> instance for this axis view limits
<code>YAxis.grid</code>	Set the axis grid on or off; <code>b</code> is a boolean.
<code>YAxis.iter_ticks</code>	Iterate through all of the major and minor ticks.
<code>YAxis.limit_range_for_scale</code>	
<code>YAxis.pan</code>	Pan <code>numsteps</code> (can be positive or negative)
<code>YAxis.reset_ticks</code>	
<code>YAxis.set_data_interval</code>	set the axis data limits
<code>YAxis.set_default_intervals</code>	set the default limits for the axis interval if they are not mutated
<code>YAxis.set_label_coords</code>	Set the coordinates of the label.
<code>YAxis.set_label_position</code>	Set the label position (left or right)
<code>YAxis.set_label_text</code>	Sets the text value of the axis label
<code>YAxis.set_major_formatter</code>	Set the formatter of the major ticker
<code>YAxis.set_major_locator</code>	Set the locator of the major ticker
<code>YAxis.set_minor_formatter</code>	Set the formatter of the minor ticker
Continued on next page	

Table 20.17 – continued from previous page

<code>YAxis.set_minor_locator</code>	Set the locator of the minor ticker
<code>YAxis.set_pickradius</code>	Set the depth of the axis used by the picker
<code>YAxis.set_smart_bounds</code>	set the axis to have smart bounds
<code>YAxis.set_tick_params</code>	Set appearance parameters for ticks and ticklabels.
<code>YAxis.set_ticklabels</code>	Set the text values of the tick labels.
<code>YAxis.set_ticks</code>	Set the locations of the tick marks from sequence ticks
<code>YAxis.set_units</code>	set the units for axis
<code>YAxis.set_view_interval</code>	If <i>ignore</i> is <i>False</i> , the order of <i>vmin</i> , <i>vmax</i> does not matter; the original axis orientation will be preserved.
<code>YAxis.update_units</code>	introspect <i>data</i> for units converter and update the
<code>YAxis.zoom</code>	Zoom in/out on axis; if <i>direction</i> is <i>>0</i> zoom in, else zoom out

matplotlib.axis.YAxis.OFFSETTEXTPAD

`YAxis.OFFSETTEXTPAD = 3`

matplotlib.axis.YAxis.axis_date

`YAxis.axis_date` (*tz=None*)

Sets up x-axis ticks and labels that treat the x data as dates. *tz* is a `tzinfo` instance or a timezone string. This timezone is used to create date labels.

matplotlib.axis.YAxis.cla

`YAxis.cla()`

clear the current axis

matplotlib.axis.YAxis.convert_units

`YAxis.convert_units` (*x*)

matplotlib.axis.YAxis.get_data_interval

`YAxis.get_data_interval()`

return the Interval instance for this axis data limits

matplotlib.axis.YAxis.get_gridlines

`YAxis.get_gridlines()`

Return the grid lines as a list of Line2D instance

matplotlib.axis.YAxis.get_label_position

`YAxis.get_label_position()`

Return the label position (top or bottom)

matplotlib.axis.YAxis.get_label_text

`YAxis.get_label_text()`

Get the text of the label

matplotlib.axis.YAxis.get_major_formatter

`YAxis.get_major_formatter()`

Get the formatter of the major ticker

matplotlib.axis.YAxis.get_major_locator

`YAxis.get_major_locator()`

Get the locator of the major ticker

matplotlib.axis.YAxis.get_major_ticks

`YAxis.get_major_ticks(numticks=None)`

get the tick instances; grow as necessary

matplotlib.axis.YAxis.get_majorticklabels

`YAxis.get_majorticklabels()`

Return a list of Text instances for the major ticklabels

matplotlib.axis.YAxis.get_majorticklines

`YAxis.get_majorticklines()`

Return the major tick lines as a list of Line2D instances

matplotlib.axis.YAxis.get_majorticklocs

`YAxis.get_majorticklocs()`

Get the major tick locations in data coordinates as a numpy array

matplotlib.axis.YAxis.get_minor_formatter**YAxis.get_minor_formatter()**

Get the formatter of the minor ticker

matplotlib.axis.YAxis.get_minor_locator**YAxis.get_minor_locator()**

Get the locator of the minor ticker

matplotlib.axis.YAxis.get_minor_ticks**YAxis.get_minor_ticks(*numticks=None*)**

get the minor tick instances; grow as necessary

matplotlib.axis.YAxis.get_minorticklabels**YAxis.get_minorticklabels()**

Return a list of Text instances for the minor ticklabels

matplotlib.axis.YAxis.get_minorticklines**YAxis.get_minorticklines()**

Return the minor tick lines as a list of Line2D instances

matplotlib.axis.YAxis.get_minorticklocs**YAxis.get_minorticklocs()**

Get the minor tick locations in data coordinates as a numpy array

matplotlib.axis.YAxis.get_minpos**YAxis.get_minpos()****matplotlib.axis.YAxis.get_offset_text****YAxis.get_offset_text()**

Return the axis offsetText as a Text instance

matplotlib.axis.YAxis.get_pickradius

YAxis.get_pickradius()

Return the depth of the axis used by the picker

matplotlib.axis.YAxis.get_scale

YAxis.get_scale()

matplotlib.axis.YAxis.get_smart_bounds

YAxis.get_smart_bounds()

get whether the axis has smart bounds

matplotlib.axis.YAxis.get_tick_padding

YAxis.get_tick_padding()

matplotlib.axis.YAxis.get_tick_space

YAxis.get_tick_space()

matplotlib.axis.YAxis.get_ticklabel_extents

YAxis.get_ticklabel_extents(*renderer*)

Get the extents of the tick labels on either side of the axes.

matplotlib.axis.YAxis.get_ticklabels

YAxis.get_ticklabels(*minor=False, which=None*)

Get the x tick labels as a list of *Text* instances.

Parameters *minor* : bool

If True return the minor ticklabels, else return the major ticklabels

which : None, ('minor', 'major', 'both')

Overrides *minor*.

Selects which ticklabels to return

Returns *ret* : list

List of *Text* instances.

matplotlib.axis.YAxis.get_ticklines**YAxis.get_ticklines**(*minor=False*)

Return the tick lines as a list of Line2D instances

matplotlib.axis.YAxis.get_ticklocs**YAxis.get_ticklocs**(*minor=False*)

Get the tick locations in data coordinates as a numpy array

matplotlib.axis.YAxis.get_tightbbox**YAxis.get_tightbbox**(*renderer*)

Return a bounding box that encloses the axis. It only accounts tick labels, axis label, and offsetText.

matplotlib.axis.YAxis.get_units**YAxis.get_units**()

return the units for axis

matplotlib.axis.YAxis.get_view_interval**YAxis.get_view_interval**()

return the Interval instance for this axis view limits

matplotlib.axis.YAxis.grid**YAxis.grid**(*b=None, which='major', **kwargs*)Set the axis grid on or off; *b* is a boolean. Use *which* = 'major' | 'minor' | 'both' to set the grid for major or minor ticks.If *b* is *None* and `len(kwargs)==0`, toggle the grid state. If *kwargs* are supplied, it is assumed you want the grid on and *b* will be set to True.*kwargs* are used to set the line properties of the grids, e.g.,`xax.grid(color='r', linestyle='-', linewidth=2)`**matplotlib.axis.YAxis.iter_ticks****YAxis.iter_ticks**()

Iterate through all of the major and minor ticks.

matplotlib.axis.YAxis.limit_range_for_scale

`YAxis.limit_range_for_scale(vmin, vmax)`

matplotlib.axis.YAxis.pan

`YAxis.pan(numsteps)`

Pan *numsteps* (can be positive or negative)

matplotlib.axis.YAxis.reset_ticks

`YAxis.reset_ticks()`

matplotlib.axis.YAxis.set_data_interval

`YAxis.set_data_interval(vmin, vmax, ignore=False)`

set the axis data limits

matplotlib.axis.YAxis.set_default_intervals

`YAxis.set_default_intervals()`

set the default limits for the axis interval if they are not mutated

matplotlib.axis.YAxis.set_label_coords

`YAxis.set_label_coords(x, y, transform=None)`

Set the coordinates of the label. By default, the x coordinate of the y label is determined by the tick label bounding boxes, but this can lead to poor alignment of multiple ylabels if there are multiple axes. Ditto for the y coordinate of the x label.

You can also specify the coordinate system of the label with the transform. If None, the default coordinate system will be the axes coordinate system (0,0) is (left,bottom), (0.5, 0.5) is middle, etc

matplotlib.axis.YAxis.set_label_position

`YAxis.set_label_position(position)`

Set the label position (left or right)

ACCEPTS: ['left' | 'right']

matplotlib.axis.YAxis.set_label_text

`YAxis.set_label_text`(*label*, *fontdict=None*, ***kwargs*)

Sets the text value of the axis label

ACCEPTS: A string value for the label

matplotlib.axis.YAxis.set_major_formatter

`YAxis.set_major_formatter`(*formatter*)

Set the formatter of the major ticker

ACCEPTS: A *Formatter* instance

matplotlib.axis.YAxis.set_major_locator

`YAxis.set_major_locator`(*locator*)

Set the locator of the major ticker

ACCEPTS: a *Locator* instance

matplotlib.axis.YAxis.set_minor_formatter

`YAxis.set_minor_formatter`(*formatter*)

Set the formatter of the minor ticker

ACCEPTS: A *Formatter* instance

matplotlib.axis.YAxis.set_minor_locator

`YAxis.set_minor_locator`(*locator*)

Set the locator of the minor ticker

ACCEPTS: a *Locator* instance

matplotlib.axis.YAxis.set_pickradius

`YAxis.set_pickradius`(*pickradius*)

Set the depth of the axis used by the picker

ACCEPTS: a distance in points

matplotlib.axis.YAxis.set_smart_bounds

`YAxis.set_smart_bounds`(*value*)

set the axis to have smart bounds

matplotlib.axis.YAxis.set_tick_params

`YAxis.set_tick_params`(*which='major', reset=False, **kw*)

Set appearance parameters for ticks and ticklabels.

For documentation of keyword arguments, see `matplotlib.axes.Axes.tick_params()`.

matplotlib.axis.YAxis.set_ticklabels

`YAxis.set_ticklabels`(*ticklabels, *args, **kwargs*)

Set the text values of the tick labels. Return a list of Text instances. Use *kwarg minor=True* to select minor ticks. All other kwargs are used to update the text object properties. As for `get_ticklabels`, *label1* (left or bottom) is affected for a given tick only if its *label1On* attribute is True, and similarly for *label2*. The list of returned label text objects consists of all such *label1* objects followed by all such *label2* objects.

The input *ticklabels* is assumed to match the set of tick locations, regardless of the state of *label1On* and *label2On*.

ACCEPTS: sequence of strings or Text objects

matplotlib.axis.YAxis.set_ticks

`YAxis.set_ticks`(*ticks, minor=False*)

Set the locations of the tick marks from sequence *ticks*

ACCEPTS: sequence of floats

matplotlib.axis.YAxis.set_units

`YAxis.set_units`(*u*)

set the units for axis

ACCEPTS: a units tag

matplotlib.axis.YAxis.set_view_interval

`YAxis.set_view_interval`(*vmin, vmax, ignore=False*)

If *ignore* is *False*, the order of *vmin*, *vmax* does not matter; the original axis orientation will be preserved. In addition, the view limits can be expanded, but will not be reduced. This method is for mpl internal use; for normal use, see `set_ylim()`.

matplotlib.axis.YAxis.update_units

`YAxis.update_units`(*data*)

introspect *data* for units converter and update the axis.converter instance if necessary. Return *True* if *data* is registered for unit conversion.

matplotlib.axis.YAxis.zoom**YAxis.zoom**(*direction*)Zoom in/out on axis; if *direction* is >0 zoom in, else zoom out**20.4.4 XAxis**

<code>XAxis.OFFSETTEXTPAD</code>	
<code>XAxis.axis_date</code>	Sets up x-axis ticks and labels that treat the x data as dates.
<code>XAxis.cla</code>	clear the current axis
<code>XAxis.convert_units</code>	
<code>XAxis.get_data_interval</code>	return the Interval instance for this axis data limits
<code>XAxis.get_gridlines</code>	Return the grid lines as a list of Line2D instance
<code>XAxis.get_label_position</code>	Return the label position (top or bottom)
<code>XAxis.get_label_text</code>	Get the text of the label
<code>XAxis.get_major_formatter</code>	Get the formatter of the major ticker
<code>XAxis.get_major_locator</code>	Get the locator of the major ticker
<code>XAxis.get_major_ticks</code>	get the tick instances; grow as necessary
<code>XAxis.get_majorticklabels</code>	Return a list of Text instances for the major ticklabels
<code>XAxis.get_majorticklines</code>	Return the major tick lines as a list of Line2D instances
<code>XAxis.get_majorticklocs</code>	Get the major tick locations in data coordinates as a numpy array
<code>XAxis.get_minor_formatter</code>	Get the formatter of the minor ticker
<code>XAxis.get_minor_locator</code>	Get the locator of the minor ticker
<code>XAxis.get_minor_ticks</code>	get the minor tick instances; grow as necessary
<code>XAxis.get_minorticklabels</code>	Return a list of Text instances for the minor ticklabels
<code>XAxis.get_minorticklines</code>	Return the minor tick lines as a list of Line2D instances
<code>XAxis.get_minorticklocs</code>	Get the minor tick locations in data coordinates as a numpy array
<code>XAxis.get_minpos</code>	
<code>XAxis.get_offset_text</code>	Return the axis offsetText as a Text instance
<code>XAxis.get_pickradius</code>	Return the depth of the axis used by the picker
<code>XAxis.get_scale</code>	
<code>XAxis.get_smart_bounds</code>	get whether the axis has smart bounds
<code>XAxis.get_tick_padding</code>	
<code>XAxis.get_tick_space</code>	
<code>XAxis.get_ticklabel_extents</code>	Get the extents of the tick labels on either side of the axes.
<code>XAxis.get_ticklabels</code>	Get the x tick labels as a list of <i>Text</i> instances.
<code>XAxis.get_ticklines</code>	Return the tick lines as a list of Line2D instances

Continued on next page

Table 20.18 – continued from previous page

<code>XAxis.get_ticklocs</code>	Get the tick locations in data coordinates as a numpy array
<code>XAxis.get_tightbbox</code>	Return a bounding box that encloses the axis.
<code>XAxis.get_units</code>	return the units for axis
<code>XAxis.get_view_interval</code>	return the Interval instance for this axis view limits
<code>XAxis.grid</code>	Set the axis grid on or off; <i>b</i> is a boolean.
<code>XAxis.iter_ticks</code>	Iterate through all of the major and minor ticks.
<code>XAxis.limit_range_for_scale</code>	
<code>XAxis.pan</code>	Pan <i>numsteps</i> (can be positive or negative)
<code>XAxis.reset_ticks</code>	
<code>XAxis.set_data_interval</code>	set the axis data limits
<code>XAxis.set_default_intervals</code>	set the default limits for the axis interval if they are not mutated
<code>XAxis.set_label_coords</code>	Set the coordinates of the label.
<code>XAxis.set_label_position</code>	Set the label position (top or bottom)
<code>XAxis.set_label_text</code>	Sets the text value of the axis label
<code>XAxis.set_major_formatter</code>	Set the formatter of the major ticker
<code>XAxis.set_major_locator</code>	Set the locator of the major ticker
<code>XAxis.set_minor_formatter</code>	Set the formatter of the minor ticker
<code>XAxis.set_minor_locator</code>	Set the locator of the minor ticker
<code>XAxis.set_pickradius</code>	Set the depth of the axis used by the picker
<code>XAxis.set_smart_bounds</code>	set the axis to have smart bounds
<code>XAxis.set_tick_params</code>	Set appearance parameters for ticks and ticklabels.
<code>XAxis.set_ticklabels</code>	Set the text values of the tick labels.
<code>XAxis.set_ticks</code>	Set the locations of the tick marks from sequence ticks
<code>XAxis.set_units</code>	set the units for axis
<code>XAxis.set_view_interval</code>	If <i>ignore</i> is <i>False</i> , the order of <i>vmin</i> , <i>vmax</i> does not matter; the original axis orientation will be preserved.
<code>XAxis.update_units</code>	introspect <i>data</i> for units converter and update the
<code>XAxis.zoom</code>	Zoom in/out on axis; if <i>direction</i> is >0 zoom in, else zoom out

matplotlib.axis.XAxis.OFFSETTEXTPAD**XAxis.OFFSETTEXTPAD = 3****matplotlib.axis.XAxis.axis_date****XAxis.axis_date**(*tz=None*)

Sets up x-axis ticks and labels that treat the x data as dates. *tz* is a *tzinfo* instance or a timezone string. This timezone is used to create date labels.

matplotlib.axis.XAxis.cla**XAxis.cla()**

clear the current axis

matplotlib.axis.XAxis.convert_units**XAxis.convert_units(x)****matplotlib.axis.XAxis.get_data_interval****XAxis.get_data_interval()**

return the Interval instance for this axis data limits

matplotlib.axis.XAxis.get_gridlines**XAxis.get_gridlines()**

Return the grid lines as a list of Line2D instance

matplotlib.axis.XAxis.get_label_position**XAxis.get_label_position()**

Return the label position (top or bottom)

matplotlib.axis.XAxis.get_label_text**XAxis.get_label_text()**

Get the text of the label

matplotlib.axis.XAxis.get_major_formatter**XAxis.get_major_formatter()**

Get the formatter of the major ticker

matplotlib.axis.XAxis.get_major_locator**XAxis.get_major_locator()**

Get the locator of the major ticker

matplotlib.axis.XAxis.get_major_ticks

`XAxis.get_major_ticks(numticks=None)`
get the tick instances; grow as necessary

matplotlib.axis.XAxis.get_majorticklabels

`XAxis.get_majorticklabels()`
Return a list of Text instances for the major ticklabels

matplotlib.axis.XAxis.get_majorticklines

`XAxis.get_majorticklines()`
Return the major tick lines as a list of Line2D instances

matplotlib.axis.XAxis.get_majorticklocs

`XAxis.get_majorticklocs()`
Get the major tick locations in data coordinates as a numpy array

matplotlib.axis.XAxis.get_minor_formatter

`XAxis.get_minor_formatter()`
Get the formatter of the minor ticker

matplotlib.axis.XAxis.get_minor_locator

`XAxis.get_minor_locator()`
Get the locator of the minor ticker

matplotlib.axis.XAxis.get_minor_ticks

`XAxis.get_minor_ticks(numticks=None)`
get the minor tick instances; grow as necessary

matplotlib.axis.XAxis.get_minorticklabels

`XAxis.get_minorticklabels()`
Return a list of Text instances for the minor ticklabels

matplotlib.axis.XAxis.get_minorticklines**XAxis.get_minorticklines()**

Return the minor tick lines as a list of Line2D instances

matplotlib.axis.XAxis.get_minorticklocs**XAxis.get_minorticklocs()**

Get the minor tick locations in data coordinates as a numpy array

matplotlib.axis.XAxis.get_minpos**XAxis.get_minpos()****matplotlib.axis.XAxis.get_offset_text****XAxis.get_offset_text()**

Return the axis offsetText as a Text instance

matplotlib.axis.XAxis.get_pickradius**XAxis.get_pickradius()**

Return the depth of the axis used by the picker

matplotlib.axis.XAxis.get_scale**XAxis.get_scale()****matplotlib.axis.XAxis.get_smart_bounds****XAxis.get_smart_bounds()**

get whether the axis has smart bounds

matplotlib.axis.XAxis.get_tick_padding**XAxis.get_tick_padding()**

matplotlib.axis.XAxis.get_tick_space

XAxis.get_tick_space()

matplotlib.axis.XAxis.get_ticklabel_extents

XAxis.get_ticklabel_extents(*renderer*)

Get the extents of the tick labels on either side of the axes.

matplotlib.axis.XAxis.get_ticklabels

XAxis.get_ticklabels(*minor=False, which=None*)

Get the x tick labels as a list of *Text* instances.

Parameters *minor* : bool

If True return the minor ticklabels, else return the major ticklabels

which : None, ('minor', 'major', 'both')

Overrides *minor*.

Selects which ticklabels to return

Returns *ret* : list

List of *Text* instances.

matplotlib.axis.XAxis.get_ticklines

XAxis.get_ticklines(*minor=False*)

Return the tick lines as a list of Line2D instances

matplotlib.axis.XAxis.get_ticklocs

XAxis.get_ticklocs(*minor=False*)

Get the tick locations in data coordinates as a numpy array

matplotlib.axis.XAxis.get_tightbbox

XAxis.get_tightbbox(*renderer*)

Return a bounding box that encloses the axis. It only accounts tick labels, axis label, and offsetText.

matplotlib.axis.XAxis.get_units

XAxis.get_units()

return the units for axis

matplotlib.axis.XAxis.get_view_interval**XAxis.get_view_interval()**

return the Interval instance for this axis view limits

matplotlib.axis.XAxis.grid**XAxis.grid**(*b=None, which='major', **kwargs*)Set the axis grid on or off; *b* is a boolean. Use *which* = 'major' | 'minor' | 'both' to set the grid for major or minor ticks.If *b* is *None* and len(*kwargs*)==0, toggle the grid state. If *kwargs* are supplied, it is assumed you want the grid on and *b* will be set to True.*kwargs* are used to set the line properties of the grids, e.g.,`xax.grid(color='r', linestyle='-', linewidth=2)`**matplotlib.axis.XAxis.iter_ticks****XAxis.iter_ticks()**

Iterate through all of the major and minor ticks.

matplotlib.axis.XAxis.limit_range_for_scale**XAxis.limit_range_for_scale**(*vmin, vmax*)**matplotlib.axis.XAxis.pan****XAxis.pan**(*numsteps*)Pan *numsteps* (can be positive or negative)**matplotlib.axis.XAxis.reset_ticks****XAxis.reset_ticks()****matplotlib.axis.XAxis.set_data_interval****XAxis.set_data_interval**(*vmin, vmax, ignore=False*)

set the axis data limits

matplotlib.axis.XAxis.set_default_intervals

XAxis.set_default_intervals()

set the default limits for the axis interval if they are not mutated

matplotlib.axis.XAxis.set_label_coords

XAxis.set_label_coords(*x*, *y*, *transform=None*)

Set the coordinates of the label. By default, the x coordinate of the y label is determined by the tick label bounding boxes, but this can lead to poor alignment of multiple ylabels if there are multiple axes. Ditto for the y coordinate of the x label.

You can also specify the coordinate system of the label with the transform. If None, the default coordinate system will be the axes coordinate system (0,0) is (left,bottom), (0.5, 0.5) is middle, etc

matplotlib.axis.XAxis.set_label_position

XAxis.set_label_position(*position*)

Set the label position (top or bottom)

ACCEPTS: ['top' | 'bottom']

matplotlib.axis.XAxis.set_label_text

XAxis.set_label_text(*label*, *fontdict=None*, ***kwargs*)

Sets the text value of the axis label

ACCEPTS: A string value for the label

matplotlib.axis.XAxis.set_major_formatter

XAxis.set_major_formatter(*formatter*)

Set the formatter of the major ticker

ACCEPTS: A *Formatter* instance

matplotlib.axis.XAxis.set_major_locator

XAxis.set_major_locator(*locator*)

Set the locator of the major ticker

ACCEPTS: a *Locator* instance

matplotlib.axis.XAxis.set_minor_formatter**XAxis.set_minor_formatter**(*formatter*)

Set the formatter of the minor ticker

ACCEPTS: A *Formatter* instance**matplotlib.axis.XAxis.set_minor_locator****XAxis.set_minor_locator**(*locator*)

Set the locator of the minor ticker

ACCEPTS: a *Locator* instance**matplotlib.axis.XAxis.set_pickradius****XAxis.set_pickradius**(*pickradius*)

Set the depth of the axis used by the picker

ACCEPTS: a distance in points

matplotlib.axis.XAxis.set_smart_bounds**XAxis.set_smart_bounds**(*value*)

set the axis to have smart bounds

matplotlib.axis.XAxis.set_tick_params**XAxis.set_tick_params**(*which='major', reset=False, **kw*)

Set appearance parameters for ticks and ticklabels.

For documentation of keyword arguments, see *matplotlib.axes.Axes.tick_params()*.**matplotlib.axis.XAxis.set_ticklabels****XAxis.set_ticklabels**(*ticklabels, *args, **kwargs*)

Set the text values of the tick labels. Return a list of Text instances. Use *kwarg minor=True* to select minor ticks. All other kwargs are used to update the text object properties. As for *get_ticklabels*, *label1* (left or bottom) is affected for a given tick only if its *label1On* attribute is True, and similarly for *label2*. The list of returned label text objects consists of all such *label1* objects followed by all such *label2* objects.

The input *ticklabels* is assumed to match the set of tick locations, regardless of the state of *label1On* and *label2On*.

ACCEPTS: sequence of strings or Text objects

matplotlib.axis.XAxis.set_ticks

`XAxis.set_ticks(ticks, minor=False)`

Set the locations of the tick marks from sequence ticks

ACCEPTS: sequence of floats

matplotlib.axis.XAxis.set_units

`XAxis.set_units(u)`

set the units for axis

ACCEPTS: a units tag

matplotlib.axis.XAxis.set_view_interval

`XAxis.set_view_interval(vmin, vmax, ignore=False)`

If *ignore* is *False*, the order of *vmin*, *vmax* does not matter; the original axis orientation will be preserved. In addition, the view limits can be expanded, but will not be reduced. This method is for mpl internal use; for normal use, see `set_xlim()`.

matplotlib.axis.XAxis.update_units

`XAxis.update_units(data)`

introspect *data* for units converter and update the `axis.converter` instance if necessary. Return *True* if *data* is registered for unit conversion.

matplotlib.axis.XAxis.zoom

`XAxis.zoom(direction)`

Zoom in/out on axis; if *direction* is >0 zoom in, else zoom out

20.4.5 Inherited from artist

Ticks

<code>Tick.add_callback</code>	Adds a callback function that will be called whenever one of the <code>Artist</code> 's properties changes.
<code>Tick.aname</code>	
<code>Tick.axes</code>	The <code>Axes</code> instance the artist resides in, or <i>None</i> .
<code>Tick.contains</code>	Test whether the mouse event occurred in the Tick marks.
<code>Tick.convert_xunits</code>	For artists in an axes, if the xaxis has units support,
Continued on next page	

Table 20.19 – continued from previous page

<code>Tick.convert_yunits</code>	For artists in an axes, if the yaxis has units support,
<code>Tick.draw</code>	
<code>Tick.findobj</code>	Find artist objects.
<code>Tick.format_cursor_data</code>	Return <i>cursor data</i> string formatted.
<code>Tick.get_agg_filter</code>	return filter function to be used for agg filter
<code>Tick.get_alpha</code>	Return the alpha value used for blending - not supported on all
<code>Tick.get_animated</code>	Return the artist's animated state
<code>Tick.get_axes</code>	Return the <i>Axes</i> instance the artist resides in, or <i>None</i> .
<code>Tick.get_children</code>	
<code>Tick.get_clip_box</code>	Return artist clipbox
<code>Tick.get_clip_on</code>	Return whether artist uses clipping
<code>Tick.get_clip_path</code>	Return artist clip path
<code>Tick.get_contains</code>	Return the <code>_contains</code> test used by the artist, or <i>None</i> for default.
<code>Tick.get_cursor_data</code>	Get the cursor data for a given event.
<code>Tick.get_figure</code>	Return the <i>Figure</i> instance the artist belongs to.
<code>Tick.get_gid</code>	Returns the group id
<code>Tick.get_label</code>	Get the label used for this artist in the legend.
<code>Tick.get_path_effects</code>	
<code>Tick.get_picker</code>	Return the picker object used by this artist
<code>Tick.get_rasterized</code>	return True if the artist is to be rasterized
<code>Tick.get_sketch_params</code>	Returns the sketch parameters for the artist.
<code>Tick.get_snap</code>	Returns the snap setting which may be:
<code>Tick.get_transform</code>	Return the <i>Transform</i> instance used by this artist.
<code>Tick.get_transformed_clip_path_and_affine</code>	Return the clip path with the non-affine part of its transformation applied, and the remaining affine part of its transformation.
<code>Tick.get_url</code>	Returns the url
<code>Tick.get_visible</code>	Return the artist's visibility
<code>Tick.get_window_extent</code>	Get the axes bounding box in display space.
<code>Tick.get_zorder</code>	Return the <i>Artist</i> 's zorder.
<code>Tick.have_units</code>	Return <i>True</i> if units are set on the <i>x</i> or <i>y</i> axes
<code>Tick.hitlist</code>	List the children of the artist which contain the mouse event <i>event</i> .
<code>Tick.is_figure_set</code>	Returns True if the artist is assigned to a <i>Figure</i> .
<code>Tick.is_transform_set</code>	Returns <i>True</i> if <i>Artist</i> has a transform explicitly set.
<code>Tick.mouseover</code>	
<code>Tick.pchanged</code>	Fire an event when property changed, calling all of the registered callbacks.
<code>Tick.pick</code>	Process pick event
<code>Tick.pickable</code>	Return <i>True</i> if <i>Artist</i> is pickable.
<code>Tick.properties</code>	return a dictionary mapping property name -> value for all <i>Artist</i> props
Continued on next page	

Table 20.19 – continued from previous page

<code>Tick.remove</code>	Remove the artist from the figure if possible.
<code>Tick.remove_callback</code>	Remove a callback based on its <i>id</i> .
<code>Tick.set</code>	A property batch setter.
<code>Tick.set_agg_filter</code>	set <code>agg_filter</code> fuction.
<code>Tick.set_alpha</code>	Set the alpha value used for blending - not supported on all backends.
<code>Tick.set_animated</code>	Set the artist's animation state.
<code>Tick.set_axes</code>	Set the <i>Axes</i> instance in which the artist resides, if any.
<code>Tick.set_clip_box</code>	Set the artist's clip <i>Bbox</i> .
<code>Tick.set_clip_on</code>	Set whether artist uses clipping.
<code>Tick.set_clip_path</code>	Set the artist's clip path, which may be:
<code>Tick.set_contains</code>	Replace the contains test used by this artist.
<code>Tick.set_figure</code>	Set the <i>Figure</i> instance the artist belongs to.
<code>Tick.set_gid</code>	Sets the (group) id for the artist
<code>Tick.set_label</code>	Set the text of ticklabel
<code>Tick.set_path_effects</code>	set <code>path_effects</code> , which should be a list of instances of
<code>Tick.set_picker</code>	Set the epsilon for picking used by this artist
<code>Tick.set_rasterized</code>	Force rasterized (bitmap) drawing in vector backend output.
<code>Tick.set_sketch_params</code>	Sets the sketch parameters.
<code>Tick.set_snap</code>	Sets the snap setting which may be:
<code>Tick.set_transform</code>	Set the <i>Transform</i> instance used by this artist.
<code>Tick.set_url</code>	Sets the url for the artist
<code>Tick.set_visible</code>	Set the artist's visibility.
<code>Tick.set_zorder</code>	Set the zorder for the artist.
<code>Tick.stale</code>	If the artist is 'stale' and needs to be re-drawn for the output to match the internal state of the artist.
<code>Tick.update</code>	Update the properties of this <i>Artist</i> from the dictionary <i>prop</i> .
<code>Tick.update_from</code>	Copy properties from <i>other</i> to <i>self</i> .
<code>Tick.zorder</code>	
<code>XTick.add_callback</code>	Adds a callback function that will be called whenever one of the <i>Artist</i> 's properties changes.
<code>XTick.aname</code>	
<code>XTick.axes</code>	The <i>Axes</i> instance the artist resides in, or <i>None</i> .
<code>XTick.contains</code>	Test whether the mouse event occurred in the Tick marks.
<code>XTick.convert_xunits</code>	For artists in an axes, if the xaxis has units support,
<code>XTick.convert_yunits</code>	For artists in an axes, if the yaxis has units support,
<code>XTick.draw</code>	
<code>XTick.findobjj</code>	Find artist objects.
<code>XTick.format_cursor_data</code>	Return <i>cursor data</i> string formatted.
<code>XTick.get_agg_filter</code>	return filter function to be used for agg filter
Continued on next page	

Table 20.19 – continued from previous page

<code>XTick.get_alpha</code>	Return the alpha value used for blending - not supported on all
<code>XTick.get_animated</code>	Return the artist's animated state
<code>XTick.get_axes</code>	Return the <i>Axes</i> instance the artist resides in, or <i>None</i> .
<code>XTick.get_children</code>	
<code>XTick.get_clip_box</code>	Return artist clipbox
<code>XTick.get_clip_on</code>	Return whether artist uses clipping
<code>XTick.get_clip_path</code>	Return artist clip path
<code>XTick.get_contains</code>	Return the <code>_contains</code> test used by the artist, or <i>None</i> for default.
<code>XTick.get_cursor_data</code>	Get the cursor data for a given event.
<code>XTick.get_figure</code>	Return the <i>Figure</i> instance the artist belongs to.
<code>XTick.get_gid</code>	Returns the group id
<code>XTick.get_label</code>	Get the label used for this artist in the legend.
<code>XTick.get_path_effects</code>	
<code>XTick.get_picker</code>	Return the picker object used by this artist
<code>XTick.get_rasterized</code>	return True if the artist is to be rasterized
<code>XTick.get_sketch_params</code>	Returns the sketch parameters for the artist.
<code>XTick.get_snap</code>	Returns the snap setting which may be:
<code>XTick.get_transform</code>	Return the <i>Transform</i> instance used by this artist.
<code>XTick.get_transformed_clip_path_and_affine</code>	Return the clip path with the non-affine part of its transformation applied, and the remaining affine part of its transformation.
<code>XTick.get_url</code>	Returns the url
<code>XTick.get_visible</code>	Return the artist's visibility
<code>XTick.get_window_extent</code>	Get the axes bounding box in display space.
<code>XTick.get_zorder</code>	Return the <i>Artist</i> 's zorder.
<code>XTick.have_units</code>	Return <i>True</i> if units are set on the <i>x</i> or <i>y</i> axes
<code>XTick.hitlist</code>	List the children of the artist which contain the mouse event <i>event</i> .
<code>XTick.is_figure_set</code>	Returns <i>True</i> if the artist is assigned to a <i>Figure</i> .
<code>XTick.is_transform_set</code>	Returns <i>True</i> if <i>Artist</i> has a transform explicitly set.
<code>XTick.mouseover</code>	
<code>XTick.pchanged</code>	Fire an event when property changed, calling all of the registered callbacks.
<code>XTick.pick</code>	Process pick event
<code>XTick.pickable</code>	Return <i>True</i> if <i>Artist</i> is pickable.
<code>XTick.properties</code>	return a dictionary mapping property name -> value for all <i>Artist</i> props
<code>XTick.remove</code>	Remove the artist from the figure if possible.
<code>XTick.remove_callback</code>	Remove a callback based on its <i>id</i> .
<code>XTick.set</code>	A property batch setter.
<code>XTick.set_agg_filter</code>	set <code>agg_filter</code> fuction.

Continued on next page

Table 20.19 – continued from previous page

<code>XTick.set_alpha</code>	Set the alpha value used for blending - not supported on all backends.
<code>XTick.set_animated</code>	Set the artist's animation state.
<code>XTick.set_axes</code>	Set the <i>Axes</i> instance in which the artist resides, if any.
<code>XTick.set_clip_box</code>	Set the artist's clip <i>Bbox</i> .
<code>XTick.set_clip_on</code>	Set whether artist uses clipping.
<code>XTick.set_clip_path</code>	Set the artist's clip path, which may be:
<code>XTick.set_contains</code>	Replace the contains test used by this artist.
<code>XTick.set_figure</code>	Set the <i>Figure</i> instance the artist belongs to.
<code>XTick.set_gid</code>	Sets the (group) id for the artist
<code>XTick.set_label</code>	Set the text of ticklabel
<code>XTick.set_path_effects</code>	set <code>path_effects</code> , which should be a list of instances of
<code>XTick.set_picker</code>	Set the epsilon for picking used by this artist
<code>XTick.set_rasterized</code>	Force rasterized (bitmap) drawing in vector backend output.
<code>XTick.set_sketch_params</code>	Sets the sketch parameters.
<code>XTick.set_snap</code>	Sets the snap setting which may be:
<code>XTick.set_transform</code>	Set the <i>Transform</i> instance used by this artist.
<code>XTick.set_url</code>	Sets the url for the artist
<code>XTick.set_visible</code>	Set the artist's visibility.
<code>XTick.set_zorder</code>	Set the zorder for the artist.
<code>XTick.stale</code>	If the artist is 'stale' and needs to be re-drawn for the output to match the internal state of the artist.
<code>XTick.update</code>	Update the properties of this <i>Artist</i> from the dictionary <i>prop</i> .
<code>XTick.update_from</code>	Copy properties from <i>other</i> to <i>self</i> .
<code>XTick.zorder</code>	
<code>YTick.add_callback</code>	Adds a callback function that will be called whenever one of the <i>Artist</i> 's properties changes.
<code>YTick.aname</code>	
<code>YTick.axes</code>	The <i>Axes</i> instance the artist resides in, or <i>None</i> .
<code>YTick.contains</code>	Test whether the mouse event occurred in the Tick marks.
<code>YTick.convert_xunits</code>	For artists in an axes, if the xaxis has units support,
<code>YTick.convert_yunits</code>	For artists in an axes, if the yaxis has units support,
<code>YTick.draw</code>	
<code>YTick.findobjj</code>	Find artist objects.
<code>YTick.format_cursor_data</code>	Return <i>cursor data</i> string formatted.
<code>YTick.get_agg_filter</code>	return filter function to be used for agg filter
<code>YTick.get_alpha</code>	Return the alpha value used for blending - not supported on all
<code>YTick.get_animated</code>	Return the artist's animated state
<code>YTick.get_axes</code>	Return the <i>Axes</i> instance the artist resides in, or <i>None</i> .
Continued on next page	

Table 20.19 – continued from previous page

<code>YTick.get_children</code>	
<code>YTick.get_clip_box</code>	Return artist clipbox
<code>YTick.get_clip_on</code>	Return whether artist uses clipping
<code>YTick.get_clip_path</code>	Return artist clip path
<code>YTick.get_contains</code>	Return the <code>_contains</code> test used by the artist, or <code>None</code> for default.
<code>YTick.get_cursor_data</code>	Get the cursor data for a given event.
<code>YTick.get_figure</code>	Return the <code>Figure</code> instance the artist belongs to.
<code>YTick.get_gid</code>	Returns the group id
<code>YTick.get_label</code>	Get the label used for this artist in the legend.
<code>YTick.get_path_effects</code>	
<code>YTick.get_picker</code>	Return the picker object used by this artist
<code>YTick.get_rasterized</code>	return True if the artist is to be rasterized
<code>YTick.get_sketch_params</code>	Returns the sketch parameters for the artist.
<code>YTick.get_snap</code>	Returns the snap setting which may be:
<code>YTick.get_transform</code>	Return the <code>Transform</code> instance used by this artist.
<code>YTick.get_transformed_clip_path_and_affine</code>	Return the clip path with the non-affine part of its transformation applied, and the remaining affine part of its transformation.
<code>YTick.get_url</code>	Returns the url
<code>YTick.get_visible</code>	Return the artist's visibility
<code>YTick.get_window_extent</code>	Get the axes bounding box in display space.
<code>YTick.get_zorder</code>	Return the Artist's zorder.
<code>YTick.have_units</code>	Return <code>True</code> if units are set on the <code>x</code> or <code>y</code> axes
<code>YTick.hitlist</code>	List the children of the artist which contain the mouse event <code>event</code> .
<code>YTick.is_figure_set</code>	Returns True if the artist is assigned to a <code>Figure</code> .
<code>YTick.is_transform_set</code>	Returns <code>True</code> if Artist has a transform explicitly set.
<code>YTick.mouseover</code>	
<code>YTick.pchanged</code>	Fire an event when property changed, calling all of the registered callbacks.
<code>YTick.pick</code>	Process pick event
<code>YTick.pickable</code>	Return <code>True</code> if Artist is pickable.
<code>YTick.properties</code>	return a dictionary mapping property name -> value for all Artist props
<code>YTick.remove</code>	Remove the artist from the figure if possible.
<code>YTick.remove_callback</code>	Remove a callback based on its <code>id</code> .
<code>YTick.set</code>	A property batch setter.
<code>YTick.set_agg_filter</code>	set <code>agg_filter</code> fuction.
<code>YTick.set_alpha</code>	Set the alpha value used for blending - not supported on all backends.
<code>YTick.set_animated</code>	Set the artist's animation state.
<code>YTick.set_axes</code>	Set the <code>Axes</code> instance in which the artist resides, if any.
Continued on next page	

Table 20.19 – continued from previous page

<code>YTick.set_clip_box</code>	Set the artist's clip <i>Bbox</i> .
<code>YTick.set_clip_on</code>	Set whether artist uses clipping.
<code>YTick.set_clip_path</code>	Set the artist's clip path, which may be:
<code>YTick.set_contains</code>	Replace the contains test used by this artist.
<code>YTick.set_figure</code>	Set the <i>Figure</i> instance the artist belongs to.
<code>YTick.set_gid</code>	Sets the (group) id for the artist
<code>YTick.set_label</code>	Set the text of ticklabel
<code>YTick.set_path_effects</code>	set <code>path_effects</code> , which should be a list of instances of
<code>YTick.set_picker</code>	Set the epsilon for picking used by this artist
<code>YTick.set_rasterized</code>	Force rasterized (bitmap) drawing in vector backend output.
<code>YTick.set_sketch_params</code>	Sets the sketch parameters.
<code>YTick.set_snap</code>	Sets the snap setting which may be:
<code>YTick.set_transform</code>	Set the <i>Transform</i> instance used by this artist.
<code>YTick.set_url</code>	Sets the url for the artist
<code>YTick.set_visible</code>	Set the artist's visibility.
<code>YTick.set_zorder</code>	Set the zorder for the artist.
<code>YTick.stale</code>	If the artist is 'stale' and needs to be re-drawn for the output to match the internal state of the artist.
<code>YTick.update</code>	Update the properties of this <i>Artist</i> from the dictionary <i>prop</i> .
<code>YTick.update_from</code>	Copy properties from <i>other</i> to <i>self</i> .
<code>YTick.zorder</code>	

matplotlib.axis.Tick.add_callback**Tick.add_callback(*func*)**

Adds a callback function that will be called whenever one of the *Artist*'s properties changes.

Returns an *id* that is useful for removing the callback with `remove_callback()` later.

matplotlib.axis.Tick.aname

`Tick.aname = 'Artist'`

matplotlib.axis.Tick.axes**Tick.axes**

The *Axes* instance the artist resides in, or *None*.

matplotlib.axis.Tick.contains

Tick.contains(*mouseevent*)

Test whether the mouse event occurred in the Tick marks.

This function always returns false. It is more useful to test if the axis as a whole contains the mouse rather than the set of tick marks.

matplotlib.axis.Tick.convert_xunits

Tick.convert_xunits(*x*)

For artists in an axes, if the xaxis has units support, convert *x* using xaxis unit type

matplotlib.axis.Tick.convert_yunits

Tick.convert_yunits(*y*)

For artists in an axes, if the yaxis has units support, convert *y* using yaxis unit type

matplotlib.axis.Tick.draw

Tick.draw(*artist, renderer, *args, **kwargs*)

matplotlib.axis.Tick.findobj

Tick.findobj(*match=None, include_self=True*)

Find artist objects.

Recursively find all *Artist* instances contained in self.

match can be

- None: return all objects contained in artist.
- function with signature `boolean = match(artist)` used to filter matches
- class instance: e.g., `Line2D`. Only return artists of class type.

If *include_self* is True (default), include self in the list to be checked for a match.

matplotlib.axis.Tick.format_cursor_data

Tick.format_cursor_data(*data*)

Return *cursor data* string formatted.

matplotlib.axis.Tick.get_agg_filter

`Tick.get_agg_filter()`

return filter function to be used for agg filter

matplotlib.axis.Tick.get_alpha

`Tick.get_alpha()`

Return the alpha value used for blending - not supported on all backends

matplotlib.axis.Tick.get_animated

`Tick.get_animated()`

Return the artist's animated state

matplotlib.axis.Tick.get_axes

`Tick.get_axes()`

Return the *Axes* instance the artist resides in, or *None*.

This has been deprecated in mpl 1.5, please use the axes property. Will be removed in 1.7 or 2.0.

matplotlib.axis.Tick.get_children

`Tick.get_children()`

matplotlib.axis.Tick.get_clip_box

`Tick.get_clip_box()`

Return artist clipbox

matplotlib.axis.Tick.get_clip_on

`Tick.get_clip_on()`

Return whether artist uses clipping

matplotlib.axis.Tick.get_clip_path

`Tick.get_clip_path()`

Return artist clip path

matplotlib.axis.Tick.get_contains**Tick.get_contains()**Return the `_contains` test used by the artist, or *None* for default.**matplotlib.axis.Tick.get_cursor_data****Tick.get_cursor_data(event)**

Get the cursor data for a given event.

matplotlib.axis.Tick.get_figure**Tick.get_figure()**Return the *Figure* instance the artist belongs to.**matplotlib.axis.Tick.get_gid****Tick.get_gid()**

Returns the group id

matplotlib.axis.Tick.get_label**Tick.get_label()**

Get the label used for this artist in the legend.

matplotlib.axis.Tick.get_path_effects**Tick.get_path_effects()****matplotlib.axis.Tick.get_picker****Tick.get_picker()**

Return the picker object used by this artist

matplotlib.axis.Tick.get_rasterized**Tick.get_rasterized()**

return True if the artist is to be rasterized

matplotlib.axis.Tick.get_sketch_params

Tick.get_sketch_params()

Returns the sketch parameters for the artist.

Returns sketch_params : tuple or None

A 3-tuple with the following elements:

- scale: The amplitude of the wiggle perpendicular to the source line.
- length: The length of the wiggle along the line.
- randomness: The scale factor by which the length is shrunken or expanded.

May return None if no sketch parameters were set.

matplotlib.axis.Tick.get_snap

Tick.get_snap()

Returns the snap setting which may be:

- True: snap vertices to the nearest pixel center
- False: leave vertices as-is
- None: (auto) If the path contains only rectilinear line segments, round to the nearest pixel center

Only supported by the Agg and MacOSX backends.

matplotlib.axis.Tick.get_transform

Tick.get_transform()

Return the *Transform* instance used by this artist.

matplotlib.axis.Tick.get_transformed_clip_path_and_affine

Tick.get_transformed_clip_path_and_affine()

Return the clip path with the non-affine part of its transformation applied, and the remaining affine part of its transformation.

matplotlib.axis.Tick.get_url

Tick.get_url()

Returns the url

matplotlib.axis.Tick.get_visible**Tick.get_visible()**

Return the artist's visibility

matplotlib.axis.Tick.get_window_extent**Tick.get_window_extent(*renderer*)**

Get the axes bounding box in display space. Subclasses should override for inclusion in the bounding box "tight" calculation. Default is to return an empty bounding box at 0, 0.

Be careful when using this function, the results will not update if the artist window extent of the artist changes. The extent can change due to any changes in the transform stack, such as changing the axes limits, the figure size, or the canvas used (as is done when saving a figure). This can lead to unexpected behavior where interactive figures will look fine on the screen, but will save incorrectly.

matplotlib.axis.Tick.get_zorder**Tick.get_zorder()**

Return the Artist's zorder.

matplotlib.axis.Tick.have_units**Tick.have_units()**

Return *True* if units are set on the *x* or *y* axes

matplotlib.axis.Tick.hitlist**Tick.hitlist(*event*)**

List the children of the artist which contain the mouse event *event*.

matplotlib.axis.Tick.is_figure_set**Tick.is_figure_set()**

Returns *True* if the artist is assigned to a *Figure*.

matplotlib.axis.Tick.is_transform_set**Tick.is_transform_set()**

Returns *True* if Artist has a transform explicitly set.

matplotlib.axis.Tick.mouseover

Tick.`mouseover`

matplotlib.axis.Tick.pchanged

Tick.`pchanged()`

Fire an event when property changed, calling all of the registered callbacks.

matplotlib.axis.Tick.pick

Tick.`pick(mouseevent)`

Process pick event

each child artist will fire a pick event if *mouseevent* is over the artist and the artist has picker set

matplotlib.axis.Tick.pickable

Tick.`pickable()`

Return *True* if Artist is pickable.

matplotlib.axis.Tick.properties

Tick.`properties()`

return a dictionary mapping property name -> value for all Artist props

matplotlib.axis.Tick.remove

Tick.`remove()`

Remove the artist from the figure if possible. The effect will not be visible until the figure is redrawn, e.g., with `matplotlib.axes.Axes.draw_idle()`. Call `matplotlib.axes.Axes.relim()` to update the axes limits if desired.

Note: `relim()` will not see collections even if the collection was added to axes with `autolim = True`.

Note: there is no support for removing the artist's legend entry.

matplotlib.axis.Tick.remove_callback

Tick.`remove_callback(oid)`

Remove a callback based on its *id*.

See also:

`add_callback()` For adding callbacks

`matplotlib.axis.Tick.set`

`Tick.set(**kwargs)`

A property batch setter. Pass *kwargs* to set properties.

`matplotlib.axis.Tick.set_agg_filter`

`Tick.set_agg_filter(filter_func)`

set `agg_filter` fuction.

`matplotlib.axis.Tick.set_alpha`

`Tick.set_alpha(alpha)`

Set the alpha value used for blending - not supported on all backends.

ACCEPTS: float (0.0 transparent through 1.0 opaque)

`matplotlib.axis.Tick.set_animated`

`Tick.set_animated(b)`

Set the artist's animation state.

ACCEPTS: [True | False]

`matplotlib.axis.Tick.set_axes`

`Tick.set_axes(axes)`

Set the *Axes* instance in which the artist resides, if any.

This has been deprecated in mpl 1.5, please use the `axes` property. Will be removed in 1.7 or 2.0.

ACCEPTS: an *Axes* instance

`matplotlib.axis.Tick.set_clip_box`

`Tick.set_clip_box(clipbox)`

Set the artist's clip *Bbox*.

ACCEPTS: a `matplotlib.transforms.Bbox` instance

matplotlib.axis.Tick.set_clip_on

Tick.set_clip_on(*b*)

Set whether artist uses clipping.

When False artists will be visible out side of the axes which can lead to unexpected results.

ACCEPTS: [True | False]

matplotlib.axis.Tick.set_clip_path

Tick.set_clip_path(*clippath*, *transform=None*)

Set the artist's clip path, which may be:

- a *Patch* (or subclass) instance
- a *Path* instance, in which case an optional *Transform* instance may be provided, which will be applied to the path before using it for clipping.
- *None*, to remove the clipping path

For efficiency, if the path happens to be an axis-aligned rectangle, this method will set the clipping box to the corresponding rectangle and set the clipping path to *None*.

ACCEPTS: [(*Path*, *Transform*) | *Patch* | None]

matplotlib.axis.Tick.set_contains

Tick.set_contains(*picker*)

Replace the contains test used by this artist. The new picker should be a callable function which determines whether the artist is hit by the mouse event:

```
hit, props = picker(artist, mouseevent)
```

If the mouse event is over the artist, return *hit = True* and *props* is a dictionary of properties you want returned with the contains test.

ACCEPTS: a callable function

matplotlib.axis.Tick.set_figure

Tick.set_figure(*fig*)

Set the *Figure* instance the artist belongs to.

ACCEPTS: a *matplotlib.figure.Figure* instance

matplotlib.axis.Tick.set_gid**Tick.set_gid**(*gid*)

Sets the (group) id for the artist

ACCEPTS: an id string

matplotlib.axis.Tick.set_label**Tick.set_label**(*s*)

Set the text of ticklabel

ACCEPTS: str

matplotlib.axis.Tick.set_path_effects**Tick.set_path_effects**(*path_effects*)set *path_effects*, which should be a list of instances of `matplotlib.patheffect._Base` class or its derivatives.**matplotlib.axis.Tick.set_picker****Tick.set_picker**(*picker*)

Set the epsilon for picking used by this artist

picker can be one of the following:

- *None*: picking is disabled for this artist (default)
- A boolean: if *True* then picking will be enabled and the artist will fire a pick event if the mouse event is over the artist
- A float: if *picker* is a number it is interpreted as an epsilon tolerance in points and the artist will fire off an event if it's data is within epsilon of the mouse event. For some artists like lines and patch collections, the artist may provide additional data to the pick event that is generated, e.g., the indices of the data within epsilon of the pick event
- A function: if *picker* is callable, it is a user supplied function which determines whether the artist is hit by the mouse event:

```
hit, props = picker(artist, mouseevent)
```

to determine the hit test. if the mouse event is over the artist, return *hit=True* and *props* is a dictionary of properties you want added to the `PickEvent` attributes.

ACCEPTS: [None|float|boolean|callable]

matplotlib.axis.Tick.set_rasterized

Tick.**set_rasterized**(*rasterized*)

Force rasterized (bitmap) drawing in vector backend output.

Defaults to None, which implies the backend's default behavior

ACCEPTS: [True | False | None]

matplotlib.axis.Tick.set_sketch_params

Tick.**set_sketch_params**(*scale=None, length=None, randomness=None*)

Sets the sketch parameters.

Parameters scale : float, optional

The amplitude of the wiggle perpendicular to the source line, in pixels. If scale is None, or not provided, no sketch filter will be provided.

length : float, optional

The length of the wiggle along the line, in pixels (default 128.0)

randomness : float, optional

The scale factor by which the length is shrunken or expanded (default 16.0)

matplotlib.axis.Tick.set_snap

Tick.**set_snap**(*snap*)

Sets the snap setting which may be:

- True: snap vertices to the nearest pixel center
- False: leave vertices as-is
- None: (auto) If the path contains only rectilinear line segments, round to the nearest pixel center

Only supported by the Agg and MacOSX backends.

matplotlib.axis.Tick.set_transform

Tick.**set_transform**(*t*)

Set the *Transform* instance used by this artist.

ACCEPTS: *Transform* instance

matplotlib.axis.Tick.set_url**Tick.set_url**(*url*)

Sets the url for the artist

ACCEPTS: a url string

matplotlib.axis.Tick.set_visible**Tick.set_visible**(*b*)

Set the artist's visibility.

ACCEPTS: [True | False]

matplotlib.axis.Tick.set_zorder**Tick.set_zorder**(*level*)

Set the zorder for the artist. Artists with lower zorder values are drawn first.

ACCEPTS: any number

matplotlib.axis.Tick.stale**Tick.stale**

If the artist is 'stale' and needs to be re-drawn for the output to match the internal state of the artist.

matplotlib.axis.Tick.update**Tick.update**(*props*)Update the properties of this Artist from the dictionary *prop*.**matplotlib.axis.Tick.update_from****Tick.update_from**(*other*)Copy properties from *other* to *self*.**matplotlib.axis.Tick.zorder****Tick.zorder = 0**

matplotlib.axis.XTick.add_callback

XTick.add_callback(*func*)

Adds a callback function that will be called whenever one of the `Artist`'s properties changes.

Returns an *id* that is useful for removing the callback with `remove_callback()` later.

matplotlib.axis.XTick.aname

XTick.aname = 'Artist'

matplotlib.axis.XTick.axes

XTick.axes

The `Axes` instance the artist resides in, or `None`.

matplotlib.axis.XTick.contains

XTick.contains(*mouseevent*)

Test whether the mouse event occurred in the Tick marks.

This function always returns false. It is more useful to test if the axis as a whole contains the mouse rather than the set of tick marks.

matplotlib.axis.XTick.convert_xunits

XTick.convert_xunits(*x*)

For artists in an axes, if the xaxis has units support, convert *x* using xaxis unit type

matplotlib.axis.XTick.convert_yunits

XTick.convert_yunits(*y*)

For artists in an axes, if the yaxis has units support, convert *y* using yaxis unit type

matplotlib.axis.XTick.draw

XTick.draw(*artist*, *renderer*, **args*, ***kwargs*)

matplotlib.axis.XTick.findobj**XTick.findobj**(*match=None, include_self=True*)

Find artist objects.

Recursively find all *Artist* instances contained in self.*match* can be

- None: return all objects contained in artist.
- function with signature `boolean = match(artist)` used to filter matches
- class instance: e.g., `Line2D`. Only return artists of class type.

If *include_self* is True (default), include self in the list to be checked for a match.**matplotlib.axis.XTick.format_cursor_data****XTick.format_cursor_data**(*data*)Return *cursor data* string formatted.**matplotlib.axis.XTick.get_agg_filter****XTick.get_agg_filter**()

return filter function to be used for agg filter

matplotlib.axis.XTick.get_alpha**XTick.get_alpha**()

Return the alpha value used for blending - not supported on all backends

matplotlib.axis.XTick.get_animated**XTick.get_animated**()

Return the artist's animated state

matplotlib.axis.XTick.get_axes**XTick.get_axes**()Return the *Axes* instance the artist resides in, or *None*.

This has been deprecated in mpl 1.5, please use the axes property. Will be removed in 1.7 or 2.0.

matplotlib.axis.XTick.get_children

`XTick.get_children()`

matplotlib.axis.XTick.get_clip_box

`XTick.get_clip_box()`
Return artist clipbox

matplotlib.axis.XTick.get_clip_on

`XTick.get_clip_on()`
Return whether artist uses clipping

matplotlib.axis.XTick.get_clip_path

`XTick.get_clip_path()`
Return artist clip path

matplotlib.axis.XTick.get_contains

`XTick.get_contains()`
Return the `_contains` test used by the artist, or *None* for default.

matplotlib.axis.XTick.get_cursor_data

`XTick.get_cursor_data(event)`
Get the cursor data for a given event.

matplotlib.axis.XTick.get_figure

`XTick.get_figure()`
Return the *Figure* instance the artist belongs to.

matplotlib.axis.XTick.get_gid

`XTick.get_gid()`
Returns the group id

matplotlib.axis.XTick.get_label**XTick.get_label()**

Get the label used for this artist in the legend.

matplotlib.axis.XTick.get_path_effects**XTick.get_path_effects()****matplotlib.axis.XTick.get_picker****XTick.get_picker()**

Return the picker object used by this artist

matplotlib.axis.XTick.get_rasterized**XTick.get_rasterized()**

return True if the artist is to be rasterized

matplotlib.axis.XTick.get_sketch_params**XTick.get_sketch_params()**

Returns the sketch parameters for the artist.

Returns sketch_params : tuple or None

A 3-tuple with the following elements:

- scale: The amplitude of the wiggle perpendicular to the source line.
- length: The length of the wiggle along the line.
- randomness: The scale factor by which the length is shrunken or expanded.

May return None if no sketch parameters were set.

matplotlib.axis.XTick.get_snap**XTick.get_snap()**

Returns the snap setting which may be:

- True: snap vertices to the nearest pixel center
- False: leave vertices as-is
- None: (auto) If the path contains only rectilinear line segments, round to the nearest pixel center

Only supported by the Agg and MacOSX backends.

matplotlib.axis.XTick.get_transform

`XTick.get_transform()`

Return the *Transform* instance used by this artist.

matplotlib.axis.XTick.get_transformed_clip_path_and_affine

`XTick.get_transformed_clip_path_and_affine()`

Return the clip path with the non-affine part of its transformation applied, and the remaining affine part of its transformation.

matplotlib.axis.XTick.get_url

`XTick.get_url()`

Returns the url

matplotlib.axis.XTick.get_visible

`XTick.get_visible()`

Return the artist's visibility

matplotlib.axis.XTick.get_window_extent

`XTick.get_window_extent(renderer)`

Get the axes bounding box in display space. Subclasses should override for inclusion in the bounding box “tight” calculation. Default is to return an empty bounding box at 0, 0.

Be careful when using this function, the results will not update if the artist window extent of the artist changes. The extent can change due to any changes in the transform stack, such as changing the axes limits, the figure size, or the canvas used (as is done when saving a figure). This can lead to unexpected behavior where interactive figures will look fine on the screen, but will save incorrectly.

matplotlib.axis.XTick.get_zorder

`XTick.get_zorder()`

Return the Artist's zorder.

matplotlib.axis.XTick.have_units**XTick.have_units()**Return *True* if units are set on the *x* or *y* axes**matplotlib.axis.XTick.hitlist****XTick.hitlist(*event*)**List the children of the artist which contain the mouse event *event*.**matplotlib.axis.XTick.is_figure_set****XTick.is_figure_set()**Returns *True* if the artist is assigned to a *Figure*.**matplotlib.axis.XTick.is_transform_set****XTick.is_transform_set()**Returns *True* if Artist has a transform explicitly set.**matplotlib.axis.XTick.mouseover****XTick.mouseover****matplotlib.axis.XTick.pchanged****XTick.pchanged()**

Fire an event when property changed, calling all of the registered callbacks.

matplotlib.axis.XTick.pick**XTick.pick(*mouseevent*)**

Process pick event

each child artist will fire a pick event if *mouseevent* is over the artist and the artist has picker set**matplotlib.axis.XTick.pickable****XTick.pickable()**Return *True* if Artist is pickable.

matplotlib.axis.XTick.properties

XTick.properties()

return a dictionary mapping property name -> value for all Artist props

matplotlib.axis.XTick.remove

XTick.remove()

Remove the artist from the figure if possible. The effect will not be visible until the figure is redrawn, e.g., with `matplotlib.axes.Axes.draw_idle()`. Call `matplotlib.axes.Axes.relim()` to update the axes limits if desired.

Note: `relim()` will not see collections even if the collection was added to axes with `autolim = True`.

Note: there is no support for removing the artist's legend entry.

matplotlib.axis.XTick.remove_callback

XTick.remove_callback(*oid*)

Remove a callback based on its *id*.

See also:

[`add_callback\(\)`](#) For adding callbacks

matplotlib.axis.XTick.set

XTick.set(***kwargs*)

A property batch setter. Pass *kwargs* to set properties.

matplotlib.axis.XTick.set_agg_filter

XTick.set_agg_filter(*filter_func*)

set `agg_filter` function.

matplotlib.axis.XTick.set_alpha

XTick.set_alpha(*alpha*)

Set the alpha value used for blending - not supported on all backends.

ACCEPTS: float (0.0 transparent through 1.0 opaque)

matplotlib.axis.XTick.set_animated**XTick.set_animated**(*b*)

Set the artist's animation state.

ACCEPTS: [True | False]

matplotlib.axis.XTick.set_axes**XTick.set_axes**(*axes*)Set the *Axes* instance in which the artist resides, if any.

This has been deprecated in mpl 1.5, please use the axes property. Will be removed in 1.7 or 2.0.

ACCEPTS: an *Axes* instance**matplotlib.axis.XTick.set_clip_box****XTick.set_clip_box**(*clipbox*)Set the artist's clip *Bbox*.ACCEPTS: a *matplotlib.transforms.Bbox* instance**matplotlib.axis.XTick.set_clip_on****XTick.set_clip_on**(*b*)

Set whether artist uses clipping.

When False artists will be visible out side of the axes which can lead to unexpected results.

ACCEPTS: [True | False]

matplotlib.axis.XTick.set_clip_path**XTick.set_clip_path**(*clippath*, *transform=None*)

Set the artist's clip path, which may be:

- a *Patch* (or subclass) instance
- a *Path* instance, in which case an optional *Transform* instance may be provided, which will be applied to the path before using it for clipping.
- *None*, to remove the clipping path

For efficiency, if the path happens to be an axis-aligned rectangle, this method will set the clipping box to the corresponding rectangle and set the clipping path to *None*.

ACCEPTS: [(*Path*, *Transform*) | *Patch* | None]

matplotlib.axis.XTick.set_contains

`XTick.set_contains(picker)`

Replace the contains test used by this artist. The new picker should be a callable function which determines whether the artist is hit by the mouse event:

```
hit, props = picker(artist, mouseevent)
```

If the mouse event is over the artist, return `hit = True` and `props` is a dictionary of properties you want returned with the contains test.

ACCEPTS: a callable function

matplotlib.axis.XTick.set_figure

`XTick.set_figure(fig)`

Set the *Figure* instance the artist belongs to.

ACCEPTS: a `matplotlib.figure.Figure` instance

matplotlib.axis.XTick.set_gid

`XTick.set_gid(gid)`

Sets the (group) id for the artist

ACCEPTS: an id string

matplotlib.axis.XTick.set_label

`XTick.set_label(s)`

Set the text of ticklabel

ACCEPTS: str

matplotlib.axis.XTick.set_path_effects

`XTick.set_path_effects(path_effects)`

set `path_effects`, which should be a list of instances of `matplotlib.patheffect._Base` class or its derivatives.

matplotlib.axis.XTick.set_picker

`XTick.set_picker(picker)`

Set the epsilon for picking used by this artist

picker can be one of the following:

- *None*: picking is disabled for this artist (default)
- A boolean: if *True* then picking will be enabled and the artist will fire a pick event if the mouse event is over the artist
- A float: if picker is a number it is interpreted as an epsilon tolerance in points and the artist will fire off an event if it's data is within epsilon of the mouse event. For some artists like lines and patch collections, the artist may provide additional data to the pick event that is generated, e.g., the indices of the data within epsilon of the pick event
- A function: if picker is callable, it is a user supplied function which determines whether the artist is hit by the mouse event:

```
hit, props = picker(artist, mouseevent)
```

to determine the hit test. if the mouse event is over the artist, return *hit=True* and *props* is a dictionary of properties you want added to the `PickEvent` attributes.

ACCEPTS: [*None*|float|boolean|callable]

matplotlib.axis.XTick.set_rasterized

`XTick.set_rasterized(rasterized)`

Force rasterized (bitmap) drawing in vector backend output.

Defaults to *None*, which implies the backend's default behavior

ACCEPTS: [*True* | *False* | *None*]

matplotlib.axis.XTick.set_sketch_params

`XTick.set_sketch_params(scale=None, length=None, randomness=None)`

Sets the sketch parameters.

Parameters scale : float, optional

The amplitude of the wiggle perpendicular to the source line, in pixels. If *scale* is *None*, or not provided, no sketch filter will be provided.

length : float, optional

The length of the wiggle along the line, in pixels (default 128.0)

randomness : float, optional

The scale factor by which the length is shrunken or expanded (default 16.0)

matplotlib.axis.XTick.set_snap

`XTick.set_snap(snap)`

Sets the snap setting which may be:

- True: snap vertices to the nearest pixel center
- False: leave vertices as-is
- None: (auto) If the path contains only rectilinear line segments, round to the nearest pixel center

Only supported by the Agg and MacOSX backends.

matplotlib.axis.XTick.set_transform

XTick.set_transform(*t*)

Set the *Transform* instance used by this artist.

ACCEPTS: *Transform* instance

matplotlib.axis.XTick.set_url

XTick.set_url(*url*)

Sets the url for the artist

ACCEPTS: a url string

matplotlib.axis.XTick.set_visible

XTick.set_visible(*b*)

Set the artist's visibility.

ACCEPTS: [True | False]

matplotlib.axis.XTick.set_zorder

XTick.set_zorder(*level*)

Set the zorder for the artist. Artists with lower zorder values are drawn first.

ACCEPTS: any number

matplotlib.axis.XTick.stale

XTick.stale

If the artist is 'stale' and needs to be re-drawn for the output to match the internal state of the artist.

matplotlib.axis.XTick.update

XTick.update(*props*)

Update the properties of this Artist from the dictionary *prop*.

matplotlib.axis.XTick.update_from**XTick.update_from**(*other*)Copy properties from *other* to *self*.**matplotlib.axis.XTick.zorder****XTick.zorder = 0****matplotlib.axis.YTick.add_callback****YTick.add_callback**(*func*)Adds a callback function that will be called whenever one of the `Artist`'s properties changes.Returns an *id* that is useful for removing the callback with `remove_callback()` later.**matplotlib.axis.YTick.aname****YTick.aname = 'Artist'****matplotlib.axis.YTick.axes****YTick.axes**The `Axes` instance the artist resides in, or `None`.**matplotlib.axis.YTick.contains****YTick.contains**(*mouseevent*)

Test whether the mouse event occurred in the Tick marks.

This function always returns false. It is more useful to test if the axis as a whole contains the mouse rather than the set of tick marks.

matplotlib.axis.YTick.convert_xunits**YTick.convert_xunits**(*x*)For artists in an axes, if the xaxis has units support, convert *x* using xaxis unit type

matplotlib.axis.YTick.convert_yunits

YTick.**convert_yunits**(y)

For artists in an axes, if the yaxis has units support, convert y using yaxis unit type

matplotlib.axis.YTick.draw

YTick.**draw**(artist, renderer, *args, **kwargs)

matplotlib.axis.YTick.findobj

YTick.**findobj**(match=None, include_self=True)

Find artist objects.

Recursively find all *Artist* instances contained in self.

match can be

- None: return all objects contained in artist.
- function with signature `boolean = match(artist)` used to filter matches
- class instance: e.g., `Line2D`. Only return artists of class type.

If *include_self* is True (default), include self in the list to be checked for a match.

matplotlib.axis.YTick.format_cursor_data

YTick.**format_cursor_data**(data)

Return *cursor data* string formatted.

matplotlib.axis.YTick.get_agg_filter

YTick.**get_agg_filter**()

return filter function to be used for agg filter

matplotlib.axis.YTick.get_alpha

YTick.**get_alpha**()

Return the alpha value used for blending - not supported on all backends

matplotlib.axis.YTick.get_animated**YTick.get_animated()**

Return the artist's animated state

matplotlib.axis.YTick.get_axes**YTick.get_axes()**Return the *Axes* instance the artist resides in, or *None*.

This has been deprecated in mpl 1.5, please use the axes property. Will be removed in 1.7 or 2.0.

matplotlib.axis.YTick.get_children**YTick.get_children()****matplotlib.axis.YTick.get_clip_box****YTick.get_clip_box()**

Return artist clipbox

matplotlib.axis.YTick.get_clip_on**YTick.get_clip_on()**

Return whether artist uses clipping

matplotlib.axis.YTick.get_clip_path**YTick.get_clip_path()**

Return artist clip path

matplotlib.axis.YTick.get_contains**YTick.get_contains()**Return the `_contains` test used by the artist, or *None* for default.**matplotlib.axis.YTick.get_cursor_data****YTick.get_cursor_data(event)**

Get the cursor data for a given event.

matplotlib.axis.YTick.get_figure

YTick.get_figure()

Return the *Figure* instance the artist belongs to.

matplotlib.axis.YTick.get_gid

YTick.get_gid()

Returns the group id

matplotlib.axis.YTick.get_label

YTick.get_label()

Get the label used for this artist in the legend.

matplotlib.axis.YTick.get_path_effects

YTick.get_path_effects()

matplotlib.axis.YTick.get_picker

YTick.get_picker()

Return the picker object used by this artist

matplotlib.axis.YTick.get_rasterized

YTick.get_rasterized()

return True if the artist is to be rasterized

matplotlib.axis.YTick.get_sketch_params

YTick.get_sketch_params()

Returns the sketch parameters for the artist.

Returns sketch_params : tuple or None

A 3-tuple with the following elements:

- scale: The amplitude of the wiggle perpendicular to the source line.
- length: The length of the wiggle along the line.
- randomness: The scale factor by which the length is shrunken or expanded.

May return None if no sketch parameters were set.

matplotlib.axis.YTick.get_snap

YTick.get_snap()

Returns the snap setting which may be:

- True: snap vertices to the nearest pixel center
- False: leave vertices as-is
- None: (auto) If the path contains only rectilinear line segments, round to the nearest pixel center

Only supported by the Agg and MacOSX backends.

matplotlib.axis.YTick.get_transform

YTick.get_transform()

Return the *Transform* instance used by this artist.

matplotlib.axis.YTick.get_transformed_clip_path_and_affine

YTick.get_transformed_clip_path_and_affine()

Return the clip path with the non-affine part of its transformation applied, and the remaining affine part of its transformation.

matplotlib.axis.YTick.get_url

YTick.get_url()

Returns the url

matplotlib.axis.YTick.get_visible

YTick.get_visible()

Return the artist's visibility

matplotlib.axis.YTick.get_window_extent

YTick.get_window_extent(renderer)

Get the axes bounding box in display space. Subclasses should override for inclusion in the bounding box “tight” calculation. Default is to return an empty bounding box at 0, 0.

Be careful when using this function, the results will not update if the artist window extent of the artist changes. The extent can change due to any changes in the transform stack, such as changing the

axes limits, the figure size, or the canvas used (as is done when saving a figure). This can lead to unexpected behavior where interactive figures will look fine on the screen, but will save incorrectly.

matplotlib.axis.YTick.get_zorder

`YTick.get_zorder()`

Return the Artist's zorder.

matplotlib.axis.YTick.have_units

`YTick.have_units()`

Return *True* if units are set on the *x* or *y* axes

matplotlib.axis.YTick.hitlist

`YTick.hitlist(event)`

List the children of the artist which contain the mouse event *event*.

matplotlib.axis.YTick.is_figure_set

`YTick.is_figure_set()`

Returns *True* if the artist is assigned to a *Figure*.

matplotlib.axis.YTick.is_transform_set

`YTick.is_transform_set()`

Returns *True* if Artist has a transform explicitly set.

matplotlib.axis.YTick.mouseover

`YTick.mouseover`

matplotlib.axis.YTick.pchanged

`YTick.pchanged()`

Fire an event when property changed, calling all of the registered callbacks.

matplotlib.axis.YTick.pick**YTick.pick**(*mouseevent*)

Process pick event

each child artist will fire a pick event if *mouseevent* is over the artist and the artist has picker set**matplotlib.axis.YTick.pickable****YTick.pickable**()Return *True* if Artist is pickable.**matplotlib.axis.YTick.properties****YTick.properties**()

return a dictionary mapping property name -> value for all Artist props

matplotlib.axis.YTick.remove**YTick.remove**()Remove the artist from the figure if possible. The effect will not be visible until the figure is redrawn, e.g., with `matplotlib.axes.Axes.draw_idle()`. Call `matplotlib.axes.Axes.relim()` to update the axes limits if desired.Note: `relim()` will not see collections even if the collection was added to axes with `autolim = True`.

Note: there is no support for removing the artist's legend entry.

matplotlib.axis.YTick.remove_callback**YTick.remove_callback**(*oid*)Remove a callback based on its *id*.**See also:**[`add_callback\(\)`](#) For adding callbacks**matplotlib.axis.YTick.set****YTick.set**(***kwargs*)A property batch setter. Pass *kwargs* to set properties.

matplotlib.axis.YTick.set_agg_filter

YTick.**set_agg_filter**(*filter_func*)
set agg_filter fuction.

matplotlib.axis.YTick.set_alpha

YTick.**set_alpha**(*alpha*)
Set the alpha value used for blending - not supported on all backends.
ACCEPTS: float (0.0 transparent through 1.0 opaque)

matplotlib.axis.YTick.set_animated

YTick.**set_animated**(*b*)
Set the artist's animation state.
ACCEPTS: [True | False]

matplotlib.axis.YTick.set_axes

YTick.**set_axes**(*axes*)
Set the *Axes* instance in which the artist resides, if any.
This has been deprecated in mpl 1.5, please use the axes property. Will be removed in 1.7 or 2.0.
ACCEPTS: an *Axes* instance

matplotlib.axis.YTick.set_clip_box

YTick.**set_clip_box**(*clipbox*)
Set the artist's clip *Bbox*.
ACCEPTS: a *matplotlib.transforms.Bbox* instance

matplotlib.axis.YTick.set_clip_on

YTick.**set_clip_on**(*b*)
Set whether artist uses clipping.
When False artists will be visible out side of the axes which can lead to unexpected results.
ACCEPTS: [True | False]

matplotlib.axis.YTick.set_clip_path

`YTick.set_clip_path(clippath, transform=None)`

Set the artist's clip path, which may be:

- a *Patch* (or subclass) instance
- a *Path* instance, in which case an optional *Transform* instance may be provided, which will be applied to the path before using it for clipping.
- *None*, to remove the clipping path

For efficiency, if the path happens to be an axis-aligned rectangle, this method will set the clipping box to the corresponding rectangle and set the clipping path to *None*.

ACCEPTS: [(*Path*, *Transform*) | *Patch* | *None*]

matplotlib.axis.YTick.set_contains

`YTick.set_contains(picker)`

Replace the contains test used by this artist. The new picker should be a callable function which determines whether the artist is hit by the mouse event:

```
hit, props = picker(artist, mouseevent)
```

If the mouse event is over the artist, return *hit = True* and *props* is a dictionary of properties you want returned with the contains test.

ACCEPTS: a callable function

matplotlib.axis.YTick.set_figure

`YTick.set_figure(fig)`

Set the *Figure* instance the artist belongs to.

ACCEPTS: a *matplotlib.figure.Figure* instance

matplotlib.axis.YTick.set_gid

`YTick.set_gid(gid)`

Sets the (group) id for the artist

ACCEPTS: an id string

matplotlib.axis.YTick.set_label

`YTick.set_label(s)`

Set the text of ticklabel

ACCEPTS: str

matplotlib.axis.YTick.set_path_effects

YTick.set_path_effects(*path_effects*)

set path_effects, which should be a list of instances of matplotlib.patheffect._Base class or its derivatives.

matplotlib.axis.YTick.set_picker

YTick.set_picker(*picker*)

Set the epsilon for picking used by this artist

picker can be one of the following:

- None: picking is disabled for this artist (default)
- A boolean: if *True* then picking will be enabled and the artist will fire a pick event if the mouse event is over the artist
- A float: if *picker* is a number it is interpreted as an epsilon tolerance in points and the artist will fire off an event if it's data is within epsilon of the mouse event. For some artists like lines and patch collections, the artist may provide additional data to the pick event that is generated, e.g., the indices of the data within epsilon of the pick event
- A function: if *picker* is callable, it is a user supplied function which determines whether the artist is hit by the mouse event:

```
hit, props = picker(artist, mouseevent)
```

to determine the hit test. if the mouse event is over the artist, return *hit=True* and *props* is a dictionary of properties you want added to the PickEvent attributes.

ACCEPTS: [None|float|boolean|callable]

matplotlib.axis.YTick.set_rasterized

YTick.set_rasterized(*rasterized*)

Force rasterized (bitmap) drawing in vector backend output.

Defaults to None, which implies the backend's default behavior

ACCEPTS: [True | False | None]

matplotlib.axis.YTick.set_sketch_params

YTick.set_sketch_params(*scale=None, length=None, randomness=None*)

Sets the sketch parameters.

Parameters scale : float, optional

The amplitude of the wiggle perpendicular to the source line, in pixels. If scale is `None`, or not provided, no sketch filter will be provided.

length : float, optional

The length of the wiggle along the line, in pixels (default 128.0)

randomness : float, optional

The scale factor by which the length is shrunken or expanded (default 16.0)

matplotlib.axis.YTick.set_snap

`YTick.set_snap(snap)`

Sets the snap setting which may be:

- `True`: snap vertices to the nearest pixel center
- `False`: leave vertices as-is
- `None`: (auto) If the path contains only rectilinear line segments, round to the nearest pixel center

Only supported by the Agg and MacOSX backends.

matplotlib.axis.YTick.set_transform

`YTick.set_transform(t)`

Set the *Transform* instance used by this artist.

ACCEPTS: *Transform* instance

matplotlib.axis.YTick.set_url

`YTick.set_url(url)`

Sets the url for the artist

ACCEPTS: a url string

matplotlib.axis.YTick.set_visible

`YTick.set_visible(b)`

Set the artist's visibility.

ACCEPTS: [True | False]

matplotlib.axis.YTick.set_zorder

`YTick.set_zorder(level)`

Set the zorder for the artist. Artists with lower zorder values are drawn first.

ACCEPTS: any number

matplotlib.axis.YTick.stale

`YTick.stale`

If the artist is 'stale' and needs to be re-drawn for the output to match the internal state of the artist.

matplotlib.axis.YTick.update

`YTick.update(props)`

Update the properties of this Artist from the dictionary *prop*.

matplotlib.axis.YTick.update_from

`YTick.update_from(other)`

Copy properties from *other* to *self*.

matplotlib.axis.YTick.zorder

`YTick.zorder = 0`

Axis

<code>Axis.add_callback</code>	Adds a callback function that will be called whenever one of the Artist's properties changes.
<code>Axis.aname</code>	
<code>Axis.axes</code>	The <i>Axes</i> instance the artist resides in, or <i>None</i> .
<code>Axis.contains</code>	Test whether the artist contains the mouse event.
<code>Axis.convert_xunits</code>	For artists in an axes, if the xaxis has units support,
<code>Axis.convert_yunits</code>	For artists in an axes, if the yaxis has units support,
<code>Axis.draw</code>	Draw the axis lines, grid lines, tick lines and labels
<code>Axis.findobj</code>	Find artist objects.
<code>Axis.format_cursor_data</code>	Return <i>cursor data</i> string formatted.
<code>Axis.get_agg_filter</code>	return filter function to be used for agg filter
<code>Axis.get_alpha</code>	Return the alpha value used for blending - not supported on all

Continued on next page

Table 20.20 – continued from previous page

<code>Axis.get_animated</code>	Return the artist's animated state
<code>Axis.get_axes</code>	Return the <i>Axes</i> instance the artist resides in, or <i>None</i> .
<code>Axis.get_children</code>	
<code>Axis.get_clip_box</code>	Return artist clipbox
<code>Axis.get_clip_on</code>	Return whether artist uses clipping
<code>Axis.get_clip_path</code>	Return artist clip path
<code>Axis.get_contains</code>	Return the <code>_contains</code> test used by the artist, or <i>None</i> for default.
<code>Axis.get_cursor_data</code>	Get the cursor data for a given event.
<code>Axis.get_figure</code>	Return the <i>Figure</i> instance the artist belongs to.
<code>Axis.get_gid</code>	Returns the group id
<code>Axis.get_label</code>	Return the axis label as a Text instance
<code>Axis.get_path_effects</code>	
<code>Axis.get_picker</code>	Return the picker object used by this artist
<code>Axis.get_rasterized</code>	return True if the artist is to be rasterized
<code>Axis.get_sketch_params</code>	Returns the sketch parameters for the artist.
<code>Axis.get_snap</code>	Returns the snap setting which may be:
<code>Axis.get_transform</code>	
<code>Axis.get_transformed_clip_path_and_affine</code>	Return the clip path with the non-affine part of its transformation applied, and the remaining affine part of its transformation.
<code>Axis.get_url</code>	Returns the url
<code>Axis.get_visible</code>	Return the artist's visibility
<code>Axis.get_window_extent</code>	Get the axes bounding box in display space.
<code>Axis.get_zorder</code>	Return the <i>Artist</i> 's zorder.
<code>Axis.have_units</code>	
<code>Axis.hitlist</code>	List the children of the artist which contain the mouse event <i>event</i> .
<code>Axis.is_figure_set</code>	Returns True if the artist is assigned to a <i>Figure</i> .
<code>Axis.is_transform_set</code>	Returns <i>True</i> if <i>Artist</i> has a transform explicitly set.
<code>Axis.mouseover</code>	
<code>Axis.pchanged</code>	Fire an event when property changed, calling all of the registered callbacks.
<code>Axis.pick</code>	Process pick event
<code>Axis.pickable</code>	Return <i>True</i> if <i>Artist</i> is pickable.
<code>Axis.properties</code>	return a dictionary mapping property name -> value for all <i>Artist</i> props
<code>Axis.remove</code>	Remove the artist from the figure if possible.
<code>Axis.remove_callback</code>	Remove a callback based on its <i>id</i> .
<code>Axis.set</code>	A property batch setter.
<code>Axis.set_agg_filter</code>	set <code>agg_filter</code> fuction.
<code>Axis.set_alpha</code>	Set the alpha value used for blending - not supported on all backends.
<code>Axis.set_animated</code>	Set the artist's animation state.
Continued on next page	

Table 20.20 – continued from previous page

<code>Axis.set_axes</code>	Set the <i>Axes</i> instance in which the artist resides, if any.
<code>Axis.set_clip_box</code>	Set the artist's clip <i>Bbox</i> .
<code>Axis.set_clip_on</code>	Set whether artist uses clipping.
<code>Axis.set_clip_path</code>	
<code>Axis.set_contains</code>	Replace the contains test used by this artist.
<code>Axis.set_figure</code>	Set the <i>Figure</i> instance the artist belongs to.
<code>Axis.set_gid</code>	Sets the (group) id for the artist
<code>Axis.set_label</code>	Set the label to <i>s</i> for auto legend.
<code>Axis.set_path_effects</code>	set <i>path_effects</i> , which should be a list of instances of
<code>Axis.set_picker</code>	Set the epsilon for picking used by this artist
<code>Axis.set_rasterized</code>	Force rasterized (bitmap) drawing in vector backend output.
<code>Axis.set_sketch_params</code>	Sets the sketch parameters.
<code>Axis.set_snap</code>	Sets the snap setting which may be:
<code>Axis.set_transform</code>	Set the <i>Transform</i> instance used by this artist.
<code>Axis.set_url</code>	Sets the url for the artist
<code>Axis.set_visible</code>	Set the artist's visibility.
<code>Axis.set_zorder</code>	Set the zorder for the artist.
<code>Axis.stale</code>	If the artist is 'stale' and needs to be re-drawn for the output to match the internal state of the artist.
<code>Axis.update</code>	Update the properties of this <i>Artist</i> from the dictionary <i>prop</i> .
<code>Axis.update_from</code>	Copy properties from <i>other</i> to <i>self</i> .
<code>Axis.zorder</code>	
<code>XAxis.add_callback</code>	Adds a callback function that will be called whenever one of the <i>Artist</i> 's properties changes.
<code>XAxis.aname</code>	
<code>XAxis.axes</code>	The <i>Axes</i> instance the artist resides in, or <i>None</i> .
<code>XAxis.contains</code>	Test whether the mouse event occurred in the x axis.
<code>XAxis.convert_xunits</code>	For artists in an axes, if the xaxis has units support,
<code>XAxis.convert_yunits</code>	For artists in an axes, if the yaxis has units support,
<code>XAxis.draw</code>	Draw the axis lines, grid lines, tick lines and labels
<code>XAxis.findobj</code>	Find artist objects.
<code>XAxis.format_cursor_data</code>	Return <i>cursor data</i> string formatted.
<code>XAxis.get_agg_filter</code>	return filter function to be used for agg filter
<code>XAxis.get_alpha</code>	Return the alpha value used for blending - not supported on all
<code>XAxis.get_animated</code>	Return the artist's animated state
<code>XAxis.get_axes</code>	Return the <i>Axes</i> instance the artist resides in, or <i>None</i> .
<code>XAxis.get_children</code>	
<code>XAxis.get_clip_box</code>	Return artist clipbox
<code>XAxis.get_clip_on</code>	Return whether artist uses clipping
<code>XAxis.get_clip_path</code>	Return artist clip path
Continued on next page	

Table 20.20 – continued from previous page

<code>XAxis.get_contains</code>	Return the <code>_contains</code> test used by the artist, or <i>None</i> for default.
<code>XAxis.get_cursor_data</code>	Get the cursor data for a given event.
<code>XAxis.get_figure</code>	Return the <i>Figure</i> instance the artist belongs to.
<code>XAxis.get_gid</code>	Returns the group id
<code>XAxis.get_label</code>	Return the axis label as a Text instance
<code>XAxis.get_path_effects</code>	
<code>XAxis.get_picker</code>	Return the picker object used by this artist
<code>XAxis.get_rasterized</code>	return True if the artist is to be rasterized
<code>XAxis.get_sketch_params</code>	Returns the sketch parameters for the artist.
<code>XAxis.get_snap</code>	Returns the snap setting which may be:
<code>XAxis.get_transform</code>	
<code>XAxis.get_transformed_clip_path_and_affine</code>	Return the clip path with the non-affine part of its transformation applied, and the remaining affine part of its transformation.
<code>XAxis.get_url</code>	Returns the url
<code>XAxis.get_visible</code>	Return the artist's visibility
<code>XAxis.get_window_extent</code>	Get the axes bounding box in display space.
<code>XAxis.get_zorder</code>	Return the Artist's zorder.
<code>XAxis.have_units</code>	
<code>XAxis.hitlist</code>	List the children of the artist which contain the mouse event <i>event</i> .
<code>XAxis.is_figure_set</code>	Returns True if the artist is assigned to a <i>Figure</i> .
<code>XAxis.is_transform_set</code>	Returns <i>True</i> if Artist has a transform explicitly set.
<code>XAxis.mouseover</code>	
<code>XAxis.pchanged</code>	Fire an event when property changed, calling all of the registered callbacks.
<code>XAxis.pick</code>	Process pick event
<code>XAxis.pickable</code>	Return <i>True</i> if Artist is pickable.
<code>XAxis.properties</code>	return a dictionary mapping property name -> value for all Artist props
<code>XAxis.remove</code>	Remove the artist from the figure if possible.
<code>XAxis.remove_callback</code>	Remove a callback based on its <i>id</i> .
<code>XAxis.set</code>	A property batch setter.
<code>XAxis.set_agg_filter</code>	set <code>agg_filter</code> fuction.
<code>XAxis.set_alpha</code>	Set the alpha value used for blending - not supported on all backends.
<code>XAxis.set_animated</code>	Set the artist's animation state.
<code>XAxis.set_axes</code>	Set the <i>Axes</i> instance in which the artist resides, if any.
<code>XAxis.set_clip_box</code>	Set the artist's clip <i>Bbox</i> .
<code>XAxis.set_clip_on</code>	Set whether artist uses clipping.
<code>XAxis.set_clip_path</code>	
<code>XAxis.set_contains</code>	Replace the contains test used by this artist.
Continued on next page	

Table 20.20 – continued from previous page

<code>XAxis.set_figure</code>	Set the <i>Figure</i> instance the artist belongs to.
<code>XAxis.set_gid</code>	Sets the (group) id for the artist
<code>XAxis.set_label</code>	Set the label to <i>s</i> for auto legend.
<code>XAxis.set_path_effects</code>	set <code>path_effects</code> , which should be a list of instances of
<code>XAxis.set_picker</code>	Set the epsilon for picking used by this artist
<code>XAxis.set_rasterized</code>	Force rasterized (bitmap) drawing in vector backend output.
<code>XAxis.set_sketch_params</code>	Sets the sketch parameters.
<code>XAxis.set_snap</code>	Sets the snap setting which may be:
<code>XAxis.set_transform</code>	Set the <i>Transform</i> instance used by this artist.
<code>XAxis.set_url</code>	Sets the url for the artist
<code>XAxis.set_visible</code>	Set the artist's visibility.
<code>XAxis.set_zorder</code>	Set the zorder for the artist.
<code>XAxis.stale</code>	If the artist is 'stale' and needs to be re-drawn for the output to match the internal state of the artist.
<code>XAxis.update</code>	Update the properties of this <i>Artist</i> from the dictionary <i>prop</i> .
<code>XAxis.update_from</code>	Copy properties from <i>other</i> to <i>self</i> .
<code>XAxis.zorder</code>	
<code>YAxis.add_callback</code>	Adds a callback function that will be called whenever one of the <i>Artist</i> 's properties changes.
<code>YAxis.aname</code>	
<code>YAxis.axes</code>	The <i>Axes</i> instance the artist resides in, or <i>None</i> .
<code>YAxis.contains</code>	Test whether the mouse event occurred in the y axis.
<code>YAxis.convert_xunits</code>	For artists in an axes, if the xaxis has units support,
<code>YAxis.convert_yunits</code>	For artists in an axes, if the yaxis has units support,
<code>YAxis.draw</code>	Draw the axis lines, grid lines, tick lines and labels
<code>YAxis.findobjj</code>	Find artist objects.
<code>YAxis.format_cursor_data</code>	Return <i>cursor data</i> string formatted.
<code>YAxis.get_agg_filter</code>	return filter function to be used for agg filter
<code>YAxis.get_alpha</code>	Return the alpha value used for blending - not supported on all
<code>YAxis.get_animated</code>	Return the artist's animated state
<code>YAxis.get_axes</code>	Return the <i>Axes</i> instance the artist resides in, or <i>None</i> .
<code>YAxis.get_children</code>	
<code>YAxis.get_clip_box</code>	Return artist clipbox
<code>YAxis.get_clip_on</code>	Return whether artist uses clipping
<code>YAxis.get_clip_path</code>	Return artist clip path
<code>YAxis.get_contains</code>	Return the <code>_contains</code> test used by the artist, or <i>None</i> for default.
<code>YAxis.get_cursor_data</code>	Get the cursor data for a given event.
<code>YAxis.get_figure</code>	Return the <i>Figure</i> instance the artist belongs to.
<code>YAxis.get_gid</code>	Returns the group id
<code>YAxis.get_label</code>	Return the axis label as a <i>Text</i> instance
Continued on next page	

Table 20.20 – continued from previous page

<code>YAxis.get_path_effects</code>	
<code>YAxis.get_picker</code>	Return the picker object used by this artist
<code>YAxis.get_rasterized</code>	return True if the artist is to be rasterized
<code>YAxis.get_sketch_params</code>	Returns the sketch parameters for the artist.
<code>YAxis.get_snap</code>	Returns the snap setting which may be:
<code>YAxis.get_transform</code>	
<code>YAxis.get_transformed_clip_path_and_affine</code>	Return the clip path with the non-affine part of its transformation applied, and the remaining affine part of its transformation.
<code>YAxis.get_url</code>	Returns the url
<code>YAxis.get_visible</code>	Return the artist's visibility
<code>YAxis.get_window_extent</code>	Get the axes bounding box in display space.
<code>YAxis.get_zorder</code>	Return the Artist's zorder.
<code>YAxis.have_units</code>	
<code>YAxis.hitlist</code>	List the children of the artist which contain the mouse event <i>event</i> .
<code>YAxis.is_figure_set</code>	Returns True if the artist is assigned to a <i>Figure</i> .
<code>YAxis.is_transform_set</code>	Returns <i>True</i> if Artist has a transform explicitly set.
<code>YAxis.mouseover</code>	
<code>YAxis.pchanged</code>	Fire an event when property changed, calling all of the registered callbacks.
<code>YAxis.pick</code>	Process pick event
<code>YAxis.pickable</code>	Return <i>True</i> if Artist is pickable.
<code>YAxis.properties</code>	return a dictionary mapping property name -> value for all Artist props
<code>YAxis.remove</code>	Remove the artist from the figure if possible.
<code>YAxis.remove_callback</code>	Remove a callback based on its <i>id</i> .
<code>YAxis.set</code>	A property batch setter.
<code>YAxis.set_agg_filter</code>	set <i>agg_filter</i> fuction.
<code>YAxis.set_alpha</code>	Set the alpha value used for blending - not supported on all backends.
<code>YAxis.set_animated</code>	Set the artist's animation state.
<code>YAxis.set_axes</code>	Set the <i>Axes</i> instance in which the artist resides, if any.
<code>YAxis.set_clip_box</code>	Set the artist's clip <i>Bbox</i> .
<code>YAxis.set_clip_on</code>	Set whether artist uses clipping.
<code>YAxis.set_clip_path</code>	
<code>YAxis.set_contains</code>	Replace the contains test used by this artist.
<code>YAxis.set_figure</code>	Set the <i>Figure</i> instance the artist belongs to.
<code>YAxis.set_gid</code>	Sets the (group) id for the artist
<code>YAxis.set_label</code>	Set the label to <i>s</i> for auto legend.
<code>YAxis.set_path_effects</code>	set <i>path_effects</i> , which should be a list of instances of
<code>YAxis.set_picker</code>	Set the epsilon for picking used by this artist
Continued on next page	

Table 20.20 – continued from previous page

<code>YAxis.set_rasterized</code>	Force rasterized (bitmap) drawing in vector backend output.
<code>YAxis.set_sketch_params</code>	Sets the sketch parameters.
<code>YAxis.set_snap</code>	Sets the snap setting which may be:
<code>YAxis.set_transform</code>	Set the <i>Transform</i> instance used by this artist.
<code>YAxis.set_url</code>	Sets the url for the artist
<code>YAxis.set_visible</code>	Set the artist's visibility.
<code>YAxis.set_zorder</code>	Set the zorder for the artist.
<code>YAxis.stale</code>	If the artist is 'stale' and needs to be re-drawn for the output to match the internal state of the artist.
<code>YAxis.update</code>	Update the properties of this Artist from the dictionary <i>prop</i> .
<code>YAxis.update_from</code>	Copy properties from <i>other</i> to <i>self</i> .
<code>YAxis.zorder</code>	

matplotlib.axis.Axis.add_callback

Axis.add_callback(*func*)

Adds a callback function that will be called whenever one of the Artist's properties changes.

Returns an *id* that is useful for removing the callback with `remove_callback()` later.

matplotlib.axis.Axis.aname

Axis.aname = 'Artist'

matplotlib.axis.Axis.axes

Axis.axes

The *Axes* instance the artist resides in, or *None*.

matplotlib.axis.Axis.contains

Axis.contains(*mouseevent*)

Test whether the artist contains the mouse event.

Returns the truth value and a dictionary of artist specific details of selection, such as which points are contained in the pick radius. See individual artists for details.

matplotlib.axis.Axis.convert_xunits

`Axis.convert_xunits(x)`

For artists in an axes, if the xaxis has units support, convert x using xaxis unit type

matplotlib.axis.Axis.convert_yunits

`Axis.convert_yunits(y)`

For artists in an axes, if the yaxis has units support, convert y using yaxis unit type

matplotlib.axis.Axis.draw

`Axis.draw(artist, renderer, *args, **kwargs)`

Draw the axis lines, grid lines, tick lines and labels

matplotlib.axis.Axis.findobj

`Axis.findobj(match=None, include_self=True)`

Find artist objects.

Recursively find all *Artist* instances contained in self.

match can be

- None: return all objects contained in artist.
- function with signature `boolean = match(artist)` used to filter matches
- class instance: e.g., `Line2D`. Only return artists of class type.

If *include_self* is True (default), include self in the list to be checked for a match.

matplotlib.axis.Axis.format_cursor_data

`Axis.format_cursor_data(data)`

Return *cursor data* string formatted.

matplotlib.axis.Axis.get_agg_filter

`Axis.get_agg_filter()`

return filter function to be used for agg filter

matplotlib.axis.Axis.get_alpha

`Axis.get_alpha()`

Return the alpha value used for blending - not supported on all backends

matplotlib.axis.Axis.get_animated

`Axis.get_animated()`

Return the artist's animated state

matplotlib.axis.Axis.get_axes

`Axis.get_axes()`

Return the *Axes* instance the artist resides in, or *None*.

This has been deprecated in mpl 1.5, please use the axes property. Will be removed in 1.7 or 2.0.

matplotlib.axis.Axis.get_children

`Axis.get_children()`

matplotlib.axis.Axis.get_clip_box

`Axis.get_clip_box()`

Return artist clipbox

matplotlib.axis.Axis.get_clip_on

`Axis.get_clip_on()`

Return whether artist uses clipping

matplotlib.axis.Axis.get_clip_path

`Axis.get_clip_path()`

Return artist clip path

matplotlib.axis.Axis.get_contains

`Axis.get_contains()`

Return the `_contains` test used by the artist, or *None* for default.

matplotlib.axis.Axis.get_cursor_data

`Axis.get_cursor_data(event)`
Get the cursor data for a given event.

matplotlib.axis.Axis.get_figure

`Axis.get_figure()`
Return the *Figure* instance the artist belongs to.

matplotlib.axis.Axis.get_gid

`Axis.get_gid()`
Returns the group id

matplotlib.axis.Axis.get_label

`Axis.get_label()`
Return the axis label as a Text instance

matplotlib.axis.Axis.get_path_effects

`Axis.get_path_effects()`

matplotlib.axis.Axis.get_picker

`Axis.get_picker()`
Return the picker object used by this artist

matplotlib.axis.Axis.get_rasterized

`Axis.get_rasterized()`
return True if the artist is to be rasterized

matplotlib.axis.Axis.get_sketch_params

`Axis.get_sketch_params()`
Returns the sketch parameters for the artist.

Returns `sketch_params` : tuple or None

A 3-tuple with the following elements:

- `scale`: The amplitude of the wiggle perpendicular to the source line.
- `length`: The length of the wiggle along the line.
- `randomness`: The scale factor by which the length is shrunken or expanded.

May return None if no sketch parameters were set.

matplotlib.axis.Axis.get_snap

`Axis.get_snap()`

Returns the snap setting which may be:

- `True`: snap vertices to the nearest pixel center
- `False`: leave vertices as-is
- `None`: (auto) If the path contains only rectilinear line segments, round to the nearest pixel center

Only supported by the Agg and MacOSX backends.

matplotlib.axis.Axis.get_transform

`Axis.get_transform()`

matplotlib.axis.Axis.get_transformed_clip_path_and_affine

`Axis.get_transformed_clip_path_and_affine()`

Return the clip path with the non-affine part of its transformation applied, and the remaining affine part of its transformation.

matplotlib.axis.Axis.get_url

`Axis.get_url()`

Returns the url

matplotlib.axis.Axis.get_visible

`Axis.get_visible()`

Return the artist's visibility

matplotlib.axis.Axis.get_window_extent

`Axis.get_window_extent(renderer)`

Get the axes bounding box in display space. Subclasses should override for inclusion in the bounding box “tight” calculation. Default is to return an empty bounding box at 0, 0.

Be careful when using this function, the results will not update if the artist window extent of the artist changes. The extent can change due to any changes in the transform stack, such as changing the axes limits, the figure size, or the canvas used (as is done when saving a figure). This can lead to unexpected behavior where interactive figures will look fine on the screen, but will save incorrectly.

matplotlib.axis.Axis.get_zorder

`Axis.get_zorder()`

Return the Artist’s zorder.

matplotlib.axis.Axis.have_units

`Axis.have_units()`

matplotlib.axis.Axis.hitlist

`Axis.hitlist(event)`

List the children of the artist which contain the mouse event *event*.

matplotlib.axis.Axis.is_figure_set

`Axis.is_figure_set()`

Returns True if the artist is assigned to a *Figure*.

matplotlib.axis.Axis.is_transform_set

`Axis.is_transform_set()`

Returns *True* if Artist has a transform explicitly set.

matplotlib.axis.Axis.mouseover

`Axis.mouseover`

matplotlib.axis.Axis.pchanged

`Axis.pchanged()`

Fire an event when property changed, calling all of the registered callbacks.

matplotlib.axis.Axis.pick

`Axis.pick(mouseevent)`

Process pick event

each child artist will fire a pick event if *mouseevent* is over the artist and the artist has picker set

matplotlib.axis.Axis.pickable

`Axis.pickable()`

Return *True* if Artist is pickable.

matplotlib.axis.Axis.properties

`Axis.properties()`

return a dictionary mapping property name -> value for all Artist props

matplotlib.axis.Axis.remove

`Axis.remove()`

Remove the artist from the figure if possible. The effect will not be visible until the figure is redrawn, e.g., with `matplotlib.axes.Axes.draw_idle()`. Call `matplotlib.axes.Axes.relim()` to update the axes limits if desired.

Note: `relim()` will not see collections even if the collection was added to axes with `autolim = True`.

Note: there is no support for removing the artist's legend entry.

matplotlib.axis.Axis.remove_callback

`Axis.remove_callback(oid)`

Remove a callback based on its *id*.

See also:

[`add_callback\(\)`](#) For adding callbacks

matplotlib.axis.Axis.set

`Axis.set(**kwargs)`

A property batch setter. Pass *kwargs* to set properties.

matplotlib.axis.Axis.set_agg_filter

`Axis.set_agg_filter(filter_func)`

set `agg_filter` fuction.

matplotlib.axis.Axis.set_alpha

`Axis.set_alpha(alpha)`

Set the alpha value used for blending - not supported on all backends.

ACCEPTS: float (0.0 transparent through 1.0 opaque)

matplotlib.axis.Axis.set_animated

`Axis.set_animated(b)`

Set the artist's animation state.

ACCEPTS: [True | False]

matplotlib.axis.Axis.set_axes

`Axis.set_axes(axes)`

Set the *Axes* instance in which the artist resides, if any.

This has been deprecated in mpl 1.5, please use the `axes` property. Will be removed in 1.7 or 2.0.

ACCEPTS: an *Axes* instance

matplotlib.axis.Axis.set_clip_box

`Axis.set_clip_box(clipbox)`

Set the artist's clip *Bbox*.

ACCEPTS: a `matplotlib.transforms.Bbox` instance

matplotlib.axis.Axis.set_clip_on

`Axis.set_clip_on(b)`

Set whether artist uses clipping.

When False artists will be visible out side of the axes which can lead to unexpected results.

ACCEPTS: [True | False]

matplotlib.axis.Axis.set_clip_path

`Axis.set_clip_path(clippath, transform=None)`

matplotlib.axis.Axis.set_contains

`Axis.set_contains(picker)`

Replace the contains test used by this artist. The new picker should be a callable function which determines whether the artist is hit by the mouse event:

```
hit, props = picker(artist, mouseevent)
```

If the mouse event is over the artist, return *hit = True* and *props* is a dictionary of properties you want returned with the contains test.

ACCEPTS: a callable function

matplotlib.axis.Axis.set_figure

`Axis.set_figure(fig)`

Set the *Figure* instance the artist belongs to.

ACCEPTS: a `matplotlib.figure.Figure` instance

matplotlib.axis.Axis.set_gid

`Axis.set_gid(gid)`

Sets the (group) id for the artist

ACCEPTS: an id string

matplotlib.axis.Axis.set_label

`Axis.set_label(s)`

Set the label to *s* for auto legend.

ACCEPTS: string or anything printable with ‘%s’ conversion.

matplotlib.axis.Axis.set_path_effects

`Axis.set_path_effects(path_effects)`

set `path_effects`, which should be a list of instances of `matplotlib.patheffect._Base` class or its derivatives.

matplotlib.axis.Axis.set_picker

`Axis.set_picker(picker)`

Set the epsilon for picking used by this artist

picker can be one of the following:

- *None*: picking is disabled for this artist (default)
- A boolean: if *True* then picking will be enabled and the artist will fire a pick event if the mouse event is over the artist
- A float: if *picker* is a number it is interpreted as an epsilon tolerance in points and the artist will fire off an event if it's data is within epsilon of the mouse event. For some artists like lines and patch collections, the artist may provide additional data to the pick event that is generated, e.g., the indices of the data within epsilon of the pick event
- A function: if *picker* is callable, it is a user supplied function which determines whether the artist is hit by the mouse event:

```
hit, props = picker(artist, mouseevent)
```

to determine the hit test. if the mouse event is over the artist, return *hit=True* and *props* is a dictionary of properties you want added to the `PickEvent` attributes.

ACCEPTS: [None|float|boolean|callable]

matplotlib.axis.Axis.set_rasterized

`Axis.set_rasterized(rasterized)`

Force rasterized (bitmap) drawing in vector backend output.

Defaults to *None*, which implies the backend's default behavior

ACCEPTS: [True | False | None]

matplotlib.axis.Axis.set_sketch_params

`Axis.set_sketch_params(scale=None, length=None, randomness=None)`

Sets the sketch parameters.

Parameters *scale* : float, optional

The amplitude of the wiggle perpendicular to the source line, in pixels. If scale is `None`, or not provided, no sketch filter will be provided.

length : float, optional

The length of the wiggle along the line, in pixels (default 128.0)

randomness : float, optional

The scale factor by which the length is shrunken or expanded (default 16.0)

matplotlib.axis.Axis.set_snap

`Axis.set_snap(snap)`

Sets the snap setting which may be:

- True: snap vertices to the nearest pixel center
- False: leave vertices as-is
- None: (auto) If the path contains only rectilinear line segments, round to the nearest pixel center

Only supported by the Agg and MacOSX backends.

matplotlib.axis.Axis.set_transform

`Axis.set_transform(t)`

Set the *Transform* instance used by this artist.

ACCEPTS: *Transform* instance

matplotlib.axis.Axis.set_url

`Axis.set_url(url)`

Sets the url for the artist

ACCEPTS: a url string

matplotlib.axis.Axis.set_visible

`Axis.set_visible(b)`

Set the artist's visibility.

ACCEPTS: [True | False]

matplotlib.axis.Axis.set_zorder**Axis.set_zorder**(*level*)

Set the zorder for the artist. Artists with lower zorder values are drawn first.

ACCEPTS: any number

matplotlib.axis.Axis.stale**Axis.stale**

If the artist is 'stale' and needs to be re-drawn for the output to match the internal state of the artist.

matplotlib.axis.Axis.update**Axis.update**(*props*)Update the properties of this Artist from the dictionary *prop*.**matplotlib.axis.Axis.update_from****Axis.update_from**(*other*)Copy properties from *other* to *self*.**matplotlib.axis.Axis.zorder****Axis.zorder = 0****matplotlib.axis.XAxis.add_callback****XAxis.add_callback**(*func*)

Adds a callback function that will be called whenever one of the Artist's properties changes.

Returns an *id* that is useful for removing the callback with *remove_callback()* later.**matplotlib.axis.XAxis.aname****XAxis.aname = 'Artist'**

matplotlib.axis.XAxis.axes

XAxis.axes

The *Axes* instance the artist resides in, or *None*.

matplotlib.axis.XAxis.contains

XAxis.contains(*mouseevent*)

Test whether the mouse event occurred in the x axis.

matplotlib.axis.XAxis.convert_xunits

XAxis.convert_xunits(*x*)

For artists in an axes, if the xaxis has units support, convert *x* using xaxis unit type

matplotlib.axis.XAxis.convert_yunits

XAxis.convert_yunits(*y*)

For artists in an axes, if the yaxis has units support, convert *y* using yaxis unit type

matplotlib.axis.XAxis.draw

XAxis.draw(*artist*, *renderer*, **args*, ***kwargs*)

Draw the axis lines, grid lines, tick lines and labels

matplotlib.axis.XAxis.findobj

XAxis.findobj(*match=None*, *include_self=True*)

Find artist objects.

Recursively find all *Artist* instances contained in self.

match can be

- None: return all objects contained in artist.
- function with signature `boolean = match(artist)` used to filter matches
- class instance: e.g., `Line2D`. Only return artists of class type.

If *include_self* is True (default), include self in the list to be checked for a match.

matplotlib.axis.XAxis.format_cursor_data

`XAxis.format_cursor_data(data)`
Return *cursor data* string formatted.

matplotlib.axis.XAxis.get_agg_filter

`XAxis.get_agg_filter()`
return filter function to be used for agg filter

matplotlib.axis.XAxis.get_alpha

`XAxis.get_alpha()`
Return the alpha value used for blending - not supported on all backends

matplotlib.axis.XAxis.get_animated

`XAxis.get_animated()`
Return the artist's animated state

matplotlib.axis.XAxis.get_axes

`XAxis.get_axes()`
Return the [Axes](#) instance the artist resides in, or *None*.
This has been deprecated in mpl 1.5, please use the axes property. Will be removed in 1.7 or 2.0.

matplotlib.axis.XAxis.get_children

`XAxis.get_children()`

matplotlib.axis.XAxis.get_clip_box

`XAxis.get_clip_box()`
Return artist clipbox

matplotlib.axis.XAxis.get_clip_on

`XAxis.get_clip_on()`
Return whether artist uses clipping

matplotlib.axis.XAxis.get_clip_path

`XAxis.get_clip_path()`

Return artist clip path

matplotlib.axis.XAxis.get_contains

`XAxis.get_contains()`

Return the `_contains` test used by the artist, or *None* for default.

matplotlib.axis.XAxis.get_cursor_data

`XAxis.get_cursor_data(event)`

Get the cursor data for a given event.

matplotlib.axis.XAxis.get_figure

`XAxis.get_figure()`

Return the *Figure* instance the artist belongs to.

matplotlib.axis.XAxis.get_gid

`XAxis.get_gid()`

Returns the group id

matplotlib.axis.XAxis.get_label

`XAxis.get_label()`

Return the axis label as a Text instance

matplotlib.axis.XAxis.get_path_effects

`XAxis.get_path_effects()`

matplotlib.axis.XAxis.get_picker

`XAxis.get_picker()`

Return the picker object used by this artist

matplotlib.axis.XAxis.get_rasterized

XAxis.get_rasterized()

return True if the artist is to be rasterized

matplotlib.axis.XAxis.get_sketch_params

XAxis.get_sketch_params()

Returns the sketch parameters for the artist.

Returns sketch_params : tuple or None

A 3-tuple with the following elements:

- scale**: The amplitude of the wiggle perpendicular to the source line.
- length**: The length of the wiggle along the line.
- randomness**: The scale factor by which the length is shrunken or expanded.

May return None if no sketch parameters were set.

matplotlib.axis.XAxis.get_snap

XAxis.get_snap()

Returns the snap setting which may be:

- True**: snap vertices to the nearest pixel center
- False**: leave vertices as-is
- None**: (auto) If the path contains only rectilinear line segments, round to the nearest pixel center

Only supported by the Agg and MacOSX backends.

matplotlib.axis.XAxis.get_transform

XAxis.get_transform()

matplotlib.axis.XAxis.get_transformed_clip_path_and_affine

XAxis.get_transformed_clip_path_and_affine()

Return the clip path with the non-affine part of its transformation applied, and the remaining affine part of its transformation.

matplotlib.axis.XAxis.get_url

`XAxis.get_url()`
Returns the url

matplotlib.axis.XAxis.get_visible

`XAxis.get_visible()`
Return the artist's visibility

matplotlib.axis.XAxis.get_window_extent

`XAxis.get_window_extent(renderer)`
Get the axes bounding box in display space. Subclasses should override for inclusion in the bounding box “tight” calculation. Default is to return an empty bounding box at 0, 0.

Be careful when using this function, the results will not update if the artist window extent of the artist changes. The extent can change due to any changes in the transform stack, such as changing the axes limits, the figure size, or the canvas used (as is done when saving a figure). This can lead to unexpected behavior where interactive figures will look fine on the screen, but will save incorrectly.

matplotlib.axis.XAxis.get_zorder

`XAxis.get_zorder()`
Return the Artist's zorder.

matplotlib.axis.XAxis.have_units

`XAxis.have_units()`

matplotlib.axis.XAxis.hitlist

`XAxis.hitlist(event)`
List the children of the artist which contain the mouse event *event*.

matplotlib.axis.XAxis.is_figure_set

`XAxis.is_figure_set()`
Returns True if the artist is assigned to a *Figure*.

matplotlib.axis.XAxis.is_transform_set**XAxis.is_transform_set()**Returns *True* if Artist has a transform explicitly set.**matplotlib.axis.XAxis.mouseover****XAxis.mouseover****matplotlib.axis.XAxis.pchanged****XAxis.pchanged()**

Fire an event when property changed, calling all of the registered callbacks.

matplotlib.axis.XAxis.pick**XAxis.pick(*mouseevent*)**

Process pick event

each child artist will fire a pick event if *mouseevent* is over the artist and the artist has picker set**matplotlib.axis.XAxis.pickable****XAxis.pickable()**Return *True* if Artist is pickable.**matplotlib.axis.XAxis.properties****XAxis.properties()**

return a dictionary mapping property name -> value for all Artist props

matplotlib.axis.XAxis.remove**XAxis.remove()**Remove the artist from the figure if possible. The effect will not be visible until the figure is redrawn, e.g., with `matplotlib.axes.Axes.draw_idle()`. Call `matplotlib.axes.Axes.relim()` to update the axes limits if desired.Note: `relim()` will not see collections even if the collection was added to axes with `autolim = True`.

Note: there is no support for removing the artist's legend entry.

matplotlib.axis.XAxis.remove_callback

`XAxis.remove_callback(oid)`

Remove a callback based on its *id*.

See also:

[`add_callback\(\)`](#) For adding callbacks

matplotlib.axis.XAxis.set

`XAxis.set(**kwargs)`

A property batch setter. Pass *kwargs* to set properties.

matplotlib.axis.XAxis.set_agg_filter

`XAxis.set_agg_filter(filter_func)`

set `agg_filter` fuction.

matplotlib.axis.XAxis.set_alpha

`XAxis.set_alpha(alpha)`

Set the alpha value used for blending - not supported on all backends.

ACCEPTS: float (0.0 transparent through 1.0 opaque)

matplotlib.axis.XAxis.set_animated

`XAxis.set_animated(b)`

Set the artist's animation state.

ACCEPTS: [True | False]

matplotlib.axis.XAxis.set_axes

`XAxis.set_axes(axes)`

Set the *Axes* instance in which the artist resides, if any.

This has been deprecated in mpl 1.5, please use the `axes` property. Will be removed in 1.7 or 2.0.

ACCEPTS: an *Axes* instance

matplotlib.axis.XAxis.set_clip_box**XAxis.set_clip_box**(*clipbox*)Set the artist's clip *Bbox*.ACCEPTS: a *matplotlib.transforms.Bbox* instance**matplotlib.axis.XAxis.set_clip_on****XAxis.set_clip_on**(*b*)

Set whether artist uses clipping.

When False artists will be visible out side of the axes which can lead to unexpected results.

ACCEPTS: [True | False]

matplotlib.axis.XAxis.set_clip_path**XAxis.set_clip_path**(*clippath*, *transform=None*)**matplotlib.axis.XAxis.set_contains****XAxis.set_contains**(*picker*)

Replace the contains test used by this artist. The new picker should be a callable function which determines whether the artist is hit by the mouse event:

```
hit, props = picker(artist, mouseevent)
```

If the mouse event is over the artist, return *hit = True* and *props* is a dictionary of properties you want returned with the contains test.

ACCEPTS: a callable function

matplotlib.axis.XAxis.set_figure**XAxis.set_figure**(*fig*)Set the *Figure* instance the artist belongs to.ACCEPTS: a *matplotlib.figure.Figure* instance**matplotlib.axis.XAxis.set_gid****XAxis.set_gid**(*gid*)

Sets the (group) id for the artist

ACCEPTS: an id string

matplotlib.axis.XAxis.set_label

`XAxis.set_label(s)`

Set the label to *s* for auto legend.

ACCEPTS: string or anything printable with ‘%s’ conversion.

matplotlib.axis.XAxis.set_path_effects

`XAxis.set_path_effects(path_effects)`

set *path_effects*, which should be a list of instances of `matplotlib.patheffect._Base` class or its derivatives.

matplotlib.axis.XAxis.set_picker

`XAxis.set_picker(picker)`

Set the epsilon for picking used by this artist

picker can be one of the following:

- *None*: picking is disabled for this artist (default)
- A boolean: if *True* then picking will be enabled and the artist will fire a pick event if the mouse event is over the artist
- A float: if *picker* is a number it is interpreted as an epsilon tolerance in points and the artist will fire off an event if it’s data is within epsilon of the mouse event. For some artists like lines and patch collections, the artist may provide additional data to the pick event that is generated, e.g., the indices of the data within epsilon of the pick event
- A function: if *picker* is callable, it is a user supplied function which determines whether the artist is hit by the mouse event:

```
hit, props = picker(artist, mouseevent)
```

to determine the hit test. if the mouse event is over the artist, return *hit=True* and *props* is a dictionary of properties you want added to the `PickEvent` attributes.

ACCEPTS: [None|float|boolean|callable]

matplotlib.axis.XAxis.set_rasterized

`XAxis.set_rasterized(rasterized)`

Force rasterized (bitmap) drawing in vector backend output.

Defaults to *None*, which implies the backend’s default behavior

ACCEPTS: [True | False | None]

matplotlib.axis.XAxis.set_sketch_params

`XAxis.set_sketch_params(scale=None, length=None, randomness=None)`

Sets the sketch parameters.

Parameters scale : float, optional

The amplitude of the wiggle perpendicular to the source line, in pixels. If scale is `None`, or not provided, no sketch filter will be provided.

length : float, optional

The length of the wiggle along the line, in pixels (default 128.0)

randomness : float, optional

The scale factor by which the length is shrunken or expanded (default 16.0)

matplotlib.axis.XAxis.set_snap

`XAxis.set_snap(snap)`

Sets the snap setting which may be:

- True: snap vertices to the nearest pixel center
- False: leave vertices as-is
- None: (auto) If the path contains only rectilinear line segments, round to the nearest pixel center

Only supported by the Agg and MacOSX backends.

matplotlib.axis.XAxis.set_transform

`XAxis.set_transform(t)`

Set the *Transform* instance used by this artist.

ACCEPTS: *Transform* instance

matplotlib.axis.XAxis.set_url

`XAxis.set_url(url)`

Sets the url for the artist

ACCEPTS: a url string

matplotlib.axis.XAxis.set_visible

`XAxis.set_visible(b)`

Set the artist's visibility.

ACCEPTS: [True | False]

matplotlib.axis.XAxis.set_zorder

`XAxis.set_zorder(level)`

Set the zorder for the artist. Artists with lower zorder values are drawn first.

ACCEPTS: any number

matplotlib.axis.XAxis.stale

`XAxis.stale`

If the artist is 'stale' and needs to be re-drawn for the output to match the internal state of the artist.

matplotlib.axis.XAxis.update

`XAxis.update(props)`

Update the properties of this `Artist` from the dictionary *prop*.

matplotlib.axis.XAxis.update_from

`XAxis.update_from(other)`

Copy properties from *other* to *self*.

matplotlib.axis.XAxis.zorder

`XAxis.zorder = 0`

matplotlib.axis.YAxis.add_callback

`YAxis.add_callback(func)`

Adds a callback function that will be called whenever one of the `Artist`'s properties changes.

Returns an *id* that is useful for removing the callback with `remove_callback()` later.

matplotlib.axis.YAxis.aname

`YAxis.aname = 'Artist'`

matplotlib.axis.YAxis.axes

`YAxis.axes`

The *Axes* instance the artist resides in, or *None*.

matplotlib.axis.YAxis.contains

`YAxis.contains(mouseevent)`

Test whether the mouse event occurred in the y axis.

Returns *True* | *False*

matplotlib.axis.YAxis.convert_xunits

`YAxis.convert_xunits(x)`

For artists in an axes, if the xaxis has units support, convert *x* using xaxis unit type

matplotlib.axis.YAxis.convert_yunits

`YAxis.convert_yunits(y)`

For artists in an axes, if the yaxis has units support, convert *y* using yaxis unit type

matplotlib.axis.YAxis.draw

`YAxis.draw(artist, renderer, *args, **kwargs)`

Draw the axis lines, grid lines, tick lines and labels

matplotlib.axis.YAxis.findobj

`YAxis.findobj(match=None, include_self=True)`

Find artist objects.

Recursively find all *Artist* instances contained in self.

match can be

- None: return all objects contained in artist.
- function with signature `boolean = match(artist)` used to filter matches

- class instance: e.g., Line2D. Only return artists of class type.

If `include_self` is True (default), include self in the list to be checked for a match.

matplotlib.axis.YAxis.format_cursor_data

`YAxis.format_cursor_data(data)`

Return *cursor data* string formatted.

matplotlib.axis.YAxis.get_agg_filter

`YAxis.get_agg_filter()`

return filter function to be used for agg filter

matplotlib.axis.YAxis.get_alpha

`YAxis.get_alpha()`

Return the alpha value used for blending - not supported on all backends

matplotlib.axis.YAxis.get_animated

`YAxis.get_animated()`

Return the artist's animated state

matplotlib.axis.YAxis.get_axes

`YAxis.get_axes()`

Return the `Axes` instance the artist resides in, or `None`.

This has been deprecated in mpl 1.5, please use the axes property. Will be removed in 1.7 or 2.0.

matplotlib.axis.YAxis.get_children

`YAxis.get_children()`

matplotlib.axis.YAxis.get_clip_box

`YAxis.get_clip_box()`

Return artist clipbox

matplotlib.axis.YAxis.get_clip_on**YAxis.get_clip_on()**

Return whether artist uses clipping

matplotlib.axis.YAxis.get_clip_path**YAxis.get_clip_path()**

Return artist clip path

matplotlib.axis.YAxis.get_contains**YAxis.get_contains()**Return the `_contains` test used by the artist, or *None* for default.**matplotlib.axis.YAxis.get_cursor_data****YAxis.get_cursor_data(event)**

Get the cursor data for a given event.

matplotlib.axis.YAxis.get_figure**YAxis.get_figure()**Return the *Figure* instance the artist belongs to.**matplotlib.axis.YAxis.get_gid****YAxis.get_gid()**

Returns the group id

matplotlib.axis.YAxis.get_label**YAxis.get_label()**

Return the axis label as a Text instance

matplotlib.axis.YAxis.get_path_effects**YAxis.get_path_effects()**

`matplotlib.axis.YAxis.get_picker`

`YAxis.get_picker()`

Return the picker object used by this artist

`matplotlib.axis.YAxis.get_rasterized`

`YAxis.get_rasterized()`

return True if the artist is to be rasterized

`matplotlib.axis.YAxis.get_sketch_params`

`YAxis.get_sketch_params()`

Returns the sketch parameters for the artist.

Returns sketch_params : tuple or None

A 3-tuple with the following elements:

- scale: The amplitude of the wiggle perpendicular to the source line.
- length: The length of the wiggle along the line.
- randomness: The scale factor by which the length is shrunk or expanded.

May return None if no sketch parameters were set.

`matplotlib.axis.YAxis.get_snap`

`YAxis.get_snap()`

Returns the snap setting which may be:

- True: snap vertices to the nearest pixel center
- False: leave vertices as-is
- None: (auto) If the path contains only rectilinear line segments, round to the nearest pixel center

Only supported by the Agg and MacOSX backends.

`matplotlib.axis.YAxis.get_transform`

`YAxis.get_transform()`

matplotlib.axis.YAxis.get_transformed_clip_path_and_affine**YAxis.get_transformed_clip_path_and_affine()**

Return the clip path with the non-affine part of its transformation applied, and the remaining affine part of its transformation.

matplotlib.axis.YAxis.get_url**YAxis.get_url()**

Returns the url

matplotlib.axis.YAxis.get_visible**YAxis.get_visible()**

Return the artist's visibility

matplotlib.axis.YAxis.get_window_extent**YAxis.get_window_extent(*renderer*)**

Get the axes bounding box in display space. Subclasses should override for inclusion in the bounding box “tight” calculation. Default is to return an empty bounding box at 0, 0.

Be careful when using this function, the results will not update if the artist window extent of the artist changes. The extent can change due to any changes in the transform stack, such as changing the axes limits, the figure size, or the canvas used (as is done when saving a figure). This can lead to unexpected behavior where interactive figures will look fine on the screen, but will save incorrectly.

matplotlib.axis.YAxis.get_zorder**YAxis.get_zorder()**

Return the Artist's zorder.

matplotlib.axis.YAxis.have_units**YAxis.have_units()****matplotlib.axis.YAxis.hitlist****YAxis.hitlist(*event*)**

List the children of the artist which contain the mouse event *event*.

matplotlib.axis.YAxis.is_figure_set

`YAxis.is_figure_set()`

Returns True if the artist is assigned to a *Figure*.

matplotlib.axis.YAxis.is_transform_set

`YAxis.is_transform_set()`

Returns *True* if Artist has a transform explicitly set.

matplotlib.axis.YAxis.mouseover

`YAxis.mouseover`

matplotlib.axis.YAxis.pchanged

`YAxis.pchanged()`

Fire an event when property changed, calling all of the registered callbacks.

matplotlib.axis.YAxis.pick

`YAxis.pick(mouseevent)`

Process pick event

each child artist will fire a pick event if *mouseevent* is over the artist and the artist has picker set

matplotlib.axis.YAxis.pickable

`YAxis.pickable()`

Return *True* if Artist is pickable.

matplotlib.axis.YAxis.properties

`YAxis.properties()`

return a dictionary mapping property name -> value for all Artist props

matplotlib.axis.YAxis.remove

`YAxis.remove()`

Remove the artist from the figure if possible. The effect will not be visible until the figure is redrawn,

e.g., with `matplotlib.axes.Axes.draw_idle()`. Call `matplotlib.axes.Axes.relim()` to update the axes limits if desired.

Note: `relim()` will not see collections even if the collection was added to axes with `autolim = True`.

Note: there is no support for removing the artist's legend entry.

matplotlib.axis.YAxis.remove_callback

`YAxis.remove_callback(oid)`

Remove a callback based on its *id*.

See also:

`add_callback()` For adding callbacks

matplotlib.axis.YAxis.set

`YAxis.set(**kwargs)`

A property batch setter. Pass *kwargs* to set properties.

matplotlib.axis.YAxis.set_agg_filter

`YAxis.set_agg_filter(filter_func)`

set `agg_filter` fuction.

matplotlib.axis.YAxis.set_alpha

`YAxis.set_alpha(alpha)`

Set the alpha value used for blending - not supported on all backends.

ACCEPTS: float (0.0 transparent through 1.0 opaque)

matplotlib.axis.YAxis.set_animated

`YAxis.set_animated(b)`

Set the artist's animation state.

ACCEPTS: [True | False]

matplotlib.axis.YAxis.set_axes

`YAxis.set_axes(axes)`

Set the `Axes` instance in which the artist resides, if any.

This has been deprecated in mpl 1.5, please use the axes property. Will be removed in 1.7 or 2.0.

ACCEPTS: an *Axes* instance

matplotlib.axis.YAxis.set_clip_box

`YAxis.set_clip_box(clipbox)`

Set the artist's clip *Bbox*.

ACCEPTS: a `matplotlib.transforms.Bbox` instance

matplotlib.axis.YAxis.set_clip_on

`YAxis.set_clip_on(b)`

Set whether artist uses clipping.

When False artists will be visible out side of the axes which can lead to unexpected results.

ACCEPTS: [True | False]

matplotlib.axis.YAxis.set_clip_path

`YAxis.set_clip_path(clippath, transform=None)`

matplotlib.axis.YAxis.set_contains

`YAxis.set_contains(picker)`

Replace the contains test used by this artist. The new picker should be a callable function which determines whether the artist is hit by the mouse event:

```
hit, props = picker(artist, mouseevent)
```

If the mouse event is over the artist, return *hit* = *True* and *props* is a dictionary of properties you want returned with the contains test.

ACCEPTS: a callable function

matplotlib.axis.YAxis.set_figure

`YAxis.set_figure(fig)`

Set the *Figure* instance the artist belongs to.

ACCEPTS: a `matplotlib.figure.Figure` instance

matplotlib.axis.YAxis.set_gid**YAxis.set_gid**(*gid*)

Sets the (group) id for the artist

ACCEPTS: an id string

matplotlib.axis.YAxis.set_label**YAxis.set_label**(*s*)Set the label to *s* for auto legend.

ACCEPTS: string or anything printable with ‘%s’ conversion.

matplotlib.axis.YAxis.set_path_effects**YAxis.set_path_effects**(*path_effects*)set *path_effects*, which should be a list of instances of `matplotlib.patheffect._Base` class or its derivatives.**matplotlib.axis.YAxis.set_picker****YAxis.set_picker**(*picker*)

Set the epsilon for picking used by this artist

picker can be one of the following:

- *None*: picking is disabled for this artist (default)
- A boolean: if *True* then picking will be enabled and the artist will fire a pick event if the mouse event is over the artist
- A float: if *picker* is a number it is interpreted as an epsilon tolerance in points and the artist will fire off an event if it's data is within epsilon of the mouse event. For some artists like lines and patch collections, the artist may provide additional data to the pick event that is generated, e.g., the indices of the data within epsilon of the pick event
- A function: if *picker* is callable, it is a user supplied function which determines whether the artist is hit by the mouse event:

```
hit, props = picker(artist, mouseevent)
```

to determine the hit test. if the mouse event is over the artist, return *hit=True* and *props* is a dictionary of properties you want added to the `PickEvent` attributes.

ACCEPTS: [None|float|boolean|callable]

matplotlib.axis.YAxis.set_rasterized

`YAxis.set_rasterized(rasterized)`

Force rasterized (bitmap) drawing in vector backend output.

Defaults to `None`, which implies the backend's default behavior

ACCEPTS: [`True` | `False` | `None`]

matplotlib.axis.YAxis.set_sketch_params

`YAxis.set_sketch_params(scale=None, length=None, randomness=None)`

Sets the sketch parameters.

Parameters `scale` : float, optional

The amplitude of the wiggle perpendicular to the source line, in pixels. If `scale` is `None`, or not provided, no sketch filter will be provided.

length : float, optional

The length of the wiggle along the line, in pixels (default 128.0)

randomness : float, optional

The scale factor by which the length is shrunken or expanded (default 16.0)

matplotlib.axis.YAxis.set_snap

`YAxis.set_snap(snap)`

Sets the snap setting which may be:

- `True`: snap vertices to the nearest pixel center
- `False`: leave vertices as-is
- `None`: (auto) If the path contains only rectilinear line segments, round to the nearest pixel center

Only supported by the Agg and MacOSX backends.

matplotlib.axis.YAxis.set_transform

`YAxis.set_transform(t)`

Set the *Transform* instance used by this artist.

ACCEPTS: *Transform* instance

matplotlib.axis.YAxis.set_url**YAxis.set_url**(*url*)

Sets the url for the artist

ACCEPTS: a url string

matplotlib.axis.YAxis.set_visible**YAxis.set_visible**(*b*)

Set the artist's visibility.

ACCEPTS: [True | False]

matplotlib.axis.YAxis.set_zorder**YAxis.set_zorder**(*level*)

Set the zorder for the artist. Artists with lower zorder values are drawn first.

ACCEPTS: any number

matplotlib.axis.YAxis.stale**YAxis.stale**

If the artist is 'stale' and needs to be re-drawn for the output to match the internal state of the artist.

matplotlib.axis.YAxis.update**YAxis.update**(*props*)Update the properties of this Artist from the dictionary *prop*.**matplotlib.axis.YAxis.update_from****YAxis.update_from**(*other*)Copy properties from *other* to *self*.**matplotlib.axis.YAxis.zorder****YAxis.zorder = 0**

21.1 `matplotlib.backend_bases`

Abstract base classes define the primitives that renderers and graphics contexts must implement to serve as a matplotlib backend

RendererBase An abstract base class to handle drawing/rendering operations.

FigureCanvasBase The abstraction layer that separates the `matplotlib.figure.Figure` from the backend specific details like a user interface drawing area

GraphicsContextBase An abstract base class that provides color, line styles, etc...

Event The base class for all of the matplotlib event handling. Derived classes such as `KeyEvent` and `MouseEvent` store the meta data like keys and buttons pressed, x and y locations in pixel and `Axes` coordinates.

ShowBase The base class for the Show class of each interactive backend; the ‘show’ callable is then set to `Show.__call__`, inherited from ShowBase.

ToolContainerBase The base class for the Toolbar class of each interactive backend.

StatusbarBase The base class for the messaging area.

class `matplotlib.backend_bases.CloseEvent`(*name*, *canvas*, *guiEvent=None*)

Bases: `matplotlib.backend_bases.Event`

An event triggered by a figure being closed

In addition to the `Event` attributes, the following event attributes are defined:

class `matplotlib.backend_bases.DrawEvent`(*name*, *canvas*, *renderer*)

Bases: `matplotlib.backend_bases.Event`

An event triggered by a draw operation on the canvas

In addition to the `Event` attributes, the following event attributes are defined:

renderer the `RendererBase` instance for the draw event

class `matplotlib.backend_bases.Event`(*name*, *canvas*, *guiEvent=None*)

Bases: object

A matplotlib event. Attach additional attributes as defined in *FigureCanvasBase.mpl_connect()*. The following attributes are defined and shown with their default values

name the event name

canvas the FigureCanvas instance generating the event

guiEvent the GUI event that triggered the matplotlib event

class matplotlib.backend_bases.**FigureCanvasBase**(*figure*)

Bases: object

The canvas the figure renders into.

Public attributes

figure A *matplotlib.figure.Figure* instance

blit(*bbox=None*)

blit the canvas in bbox (default entire canvas)

button_press_event(*x, y, button, dblclick=False, guiEvent=None*)

Backend derived classes should call this function on any mouse button press. *x,y* are the canvas coords: 0,0 is lower, left. *button* and *key* are as defined in *MouseEvent*.

This method will be call all functions connected to the 'button_press_event' with a *MouseEvent* instance.

button_release_event(*x, y, button, guiEvent=None*)

Backend derived classes should call this function on any mouse button release.

x the canvas coordinates where 0=left

y the canvas coordinates where 0=bottom

guiEvent the native UI event that generated the mpl event

This method will be call all functions connected to the 'button_release_event' with a *MouseEvent* instance.

close_event(*guiEvent=None*)

This method will be called by all functions connected to the 'close_event' with a *CloseEvent*

draw(**args*, ***kwargs*)

Render the *Figure*

draw_cursor(*event*)

Draw a cursor in the event.axes if inaxes is not None. Use native GUI drawing for efficiency if possible

draw_event(*renderer*)

This method will be call all functions connected to the 'draw_event' with a *DrawEvent*

draw_idle(**args*, ***kwargs*)

draw() only if idle; defaults to draw but backends can override

enter_notify_event(*guiEvent=None, xy=None*)

Backend derived classes should call this function when entering canvas

guiEvent the native UI event that generated the mpl event

xy the coordinate location of the pointer when the canvas is entered

events = ['resize_event', 'draw_event', 'key_press_event', 'key_release_event', 'button_press_event', 'button

filetypes = {'ps': 'Postscript', 'eps': 'Encapsulated Postscript', 'pdf': 'Portable Document Format', 'pgf': 'P

fixed_dpi = None

flush_events()

Flush the GUI events for the figure. Implemented only for backends with GUIs.

get_default_filename()

Return a string, which includes extension, suitable for use as a default filename.

classmethod get_default_filetype()

Get the default savefig file format as specified in rcParam `savefig.format`. Returned string excludes period. Overridden in backends that only support a single file type.

classmethod get_supported_filetypes()

Return dict of savefig file formats supported by this backend

classmethod get_supported_filetypes_grouped()

Return a dict of savefig file formats supported by this backend, where the keys are a file type name, such as 'Joint Photographic Experts Group', and the values are a list of filename extensions used for that filetype, such as ['jpg', 'jpeg'].

get_width_height()

Return the figure width and height in points or pixels (depending on the backend), truncated to integers

get_window_title()

Get the title text of the window containing the figure. Return None if there is no window (e.g., a PS backend).

grab_mouse(ax)

Set the child axes which are currently grabbing the mouse events. Usually called by the widgets themselves. It is an error to call this if the mouse is already grabbed by another axes.

idle_event(guiEvent=None)

Called when GUI is idle.

is_saving()

Returns True when the renderer is in the process of saving to a file, rather than rendering for an on-screen buffer.

key_press_event(key, guiEvent=None)

This method will be call all functions connected to the 'key_press_event' with a *KeyEvent*

key_release_event(key, guiEvent=None)

This method will be call all functions connected to the 'key_release_event' with a *KeyEvent*

leave_notify_event(*guiEvent=None*)

Backend derived classes should call this function when leaving canvas

guiEvent the native UI event that generated the mpl event

motion_notify_event(*x, y, guiEvent=None*)

Backend derived classes should call this function on any motion-notify-event.

x the canvas coordinates where 0=left

y the canvas coordinates where 0=bottom

guiEvent the native UI event that generated the mpl event

This method will be call all functions connected to the 'motion_notify_event' with a [MouseEvent](#) instance.

mpl_connect(*s, func*)

Connect event with string *s* to *func*. The signature of *func* is:

```
def func(event)
```

where event is a [matplotlib.backend_bases.Event](#). The following events are recognized

- 'button_press_event'
- 'button_release_event'
- 'draw_event'
- 'key_press_event'
- 'key_release_event'
- 'motion_notify_event'
- 'pick_event'
- 'resize_event'
- 'scroll_event'
- 'figure_enter_event',
- 'figure_leave_event',
- 'axes_enter_event',
- 'axes_leave_event'
- 'close_event'

For the location events (button and key press/release), if the mouse is over the axes, the variable `event.inaxes` will be set to the [Axes](#) the event occurs is over, and additionally, the variables `event.xdata` and `event.ydata` will be defined. This is the mouse location in data coords. See [KeyEvent](#) and [MouseEvent](#) for more info.

Return value is a connection id that can be used with `mpl_disconnect()`.

Example usage:

```
def on_press(event):
    print('you pressed', event.button, event.xdata, event.ydata)

cid = canvas.mpl_connect('button_press_event', on_press)
```

mpl_disconnect(cid)

Disconnect callback id cid

Example usage:

```
cid = canvas.mpl_connect('button_press_event', on_press)
#...later
canvas.mpl_disconnect(cid)
```

new_timer(*args, **kwargs)

Creates a new backend-specific subclass of `backend_bases.Timer`. This is useful for getting periodic events through the backend's native event loop. Implemented only for backends with GUIs.

optional arguments:

interval Timer interval in milliseconds

callbacks Sequence of (func, args, kwargs) where `func(args, **kwargs)` will be executed by the timer every `*interval`.

onHilite(ev)

Mouse event processor which highlights the artists under the cursor. Connect this to the 'motion_notify_event' using:

```
canvas.mpl_connect('motion_notify_event', canvas.onHilite)
```

onRemove(ev)

Mouse event processor which removes the top artist under the cursor. Connect this to the 'mouse_press_event' using:

```
canvas.mpl_connect('mouse_press_event', canvas.onRemove)
```

pick(mouseevent)**pick_event**(mouseevent, artist, **kwargs)

This method will be called by artists who are picked and will fire off `PickEvent` callbacks registered listeners

print_figure(filename, dpi=None, facecolor=None, edgecolor=None, orientation='portrait', format=None, **kwargs)

Render the figure to hardcopy. Set the figure patch face and edge colors. This is useful because some of the GUIs have a gray figure face color background and you'll probably want to override this on hardcopy.

Arguments are:

filename can also be a file object on image backends

orientation only currently applies to PostScript printing.

dpi the dots per inch to save the figure in; if None, use `savefig.dpi`

facecolor the facecolor of the figure; if None, defaults to `savefig.facecolor`

edgecolor the edgecolor of the figure; if None, defaults to `savefig.edgecolor`

orientation 'landscape' | 'portrait' (not supported on all backends)

format when set, forcibly set the file format to save to

bbox_inches Bbox in inches. Only the given portion of the figure is saved. If 'tight', try to figure out the tight bbox of the figure. If None, use `savefig.bbox`

pad_inches Amount of padding around the figure when *bbox_inches* is 'tight'. If None, use `savefig.pad_inches`

bbox_extra_artists A list of extra artists that will be considered when the tight bbox is calculated.

release_mouse(*ax*)

Release the mouse grab held by the axes, *ax*. Usually called by the widgets. It is ok to call this even if you *ax* doesn't have the mouse grab currently.

resize(*w, h*)

set the canvas size in pixels

resize_event()

This method will be call all functions connected to the 'resize_event' with a [*ResizeEvent*](#)

scroll_event(*x, y, step, guiEvent=None*)

Backend derived classes should call this function on any scroll wheel event. *x,y* are the canvas coords: 0,0 is lower, left. *button* and *key* are as defined in `MouseEvent`.

This method will be call all functions connected to the 'scroll_event' with a [*MouseEvent*](#) instance.

set_window_title(*title*)

Set the title text of the window containing the figure. Note that this has no effect if there is no window (e.g., a PS backend).

start_event_loop(*timeout*)

Start an event loop. This is used to start a blocking event loop so that interactive functions, such as `ginput` and `waitforbuttonpress`, can wait for events. This should not be confused with the main GUI event loop, which is always running and has nothing to do with this.

This is implemented only for backends with GUIs.

start_event_loop_default(*timeout=0*)

Start an event loop. This is used to start a blocking event loop so that interactive functions, such as `ginput` and `waitforbuttonpress`, can wait for events. This should not be confused with the main GUI event loop, which is always running and has nothing to do with this.

This function provides default event loop functionality based on `time.sleep` that is meant to be used until event loop functions for each of the GUI backends can be written. As such, it throws a deprecated warning.

This call blocks until a callback function triggers `stop_event_loop()` or *timeout* is reached. If *timeout* is ≤ 0 , never timeout.

stop_event_loop()

Stop an event loop. This is used to stop a blocking event loop so that interactive functions, such as `ginput` and `waitforbuttonpress`, can wait for events.

This is implemented only for backends with GUIs.

stop_event_loop_default()

Stop an event loop. This is used to stop a blocking event loop so that interactive functions, such as `ginput` and `waitforbuttonpress`, can wait for events.

supports_blit = True

switch_backends(*FigureCanvasClass*)

Instantiate an instance of `FigureCanvasClass`

This is used for backend switching, e.g., to instantiate a `FigureCanvasPS` from a `FigureCanvasGTK`. Note, deep copying is not done, so any changes to one of the instances (e.g., setting figure size or line props), will be reflected in the other

class matplotlib.backend_bases.FigureManagerBase(*canvas, num*)

Bases: `object`

Helper class for pyplot mode, wraps everything up into a neat bundle

Public attributes:

canvas A `FigureCanvasBase` instance

num The figure number

destroy()

full_screen_toggle()

get_window_title()

Get the title text of the window containing the figure. Return `None` for non-GUI backends (e.g., a PS backend).

key_press(*event*)

Implement the default mpl key bindings defined at [Navigation Keyboard Shortcuts](#)

resize(*w, h*)

“For gui backends, resize the window (in pixels).

set_window_title(*title*)

Set the title text of the window containing the figure. Note that this has no effect for non-GUI backends (e.g., a PS backend).

show()

For GUI backends, show the figure window and redraw. For non-GUI backends, raise an exception to be caught by `show()`, for an optional warning.

show_popup(*msg*)

Display message in a popup – GUI only

class matplotlib.backend_bases.GraphicsContextBase

Bases: object

An abstract base class that provides color, line styles, etc...

copy_properties(*gc*)

Copy properties from gc to self

get_alpha()

Return the alpha value used for blending - not supported on all backends

get_antialiased()

Return true if the object should try to do antialiased rendering

get_capstyle()

Return the capstyle as a string in ('butt', 'round', 'projecting')

get_clip_path()

Return the clip path in the form (path, transform), where path is a *Path* instance, and transform is an affine transform to apply to the path before clipping.

get_clip_rectangle()

Return the clip rectangle as a *Bbox* instance

get_dashes()

Return the dash information as an offset dashlist tuple.

The dash list is a even size list that gives the ink on, ink off in pixels.

See p107 of to PostScript [BLUEBOOK](#) for more info.

Default value is None

get_forced_alpha()

Return whether the value given by `get_alpha()` should be used to override any other alpha-channel values.

get_gid()

Return the object identifier if one is set, None otherwise.

get_hatch()

Gets the current hatch style

get_hatch_color()

Gets the color to use for hatching.

get_hatch_linewidth()

Gets the linewidth to use for hatching.

get_hatch_path(*density=6.0*)

Returns a *Path* for the current hatch.

get_joinstyle()

Return the line join style as one of ('miter', 'round', 'bevel')

get_linestyle(*style*)

Return the linestyle: one of ('solid', 'dashed', 'dashdot', 'dotted').

get_linewidth()

Return the line width in points as a scalar

get_rgb()

returns a tuple of three or four floats from 0-1.

get_sketch_params()

Returns the sketch parameters for the artist.

Returns sketch_params : tuple or None

A 3-tuple with the following elements:

- scale**: The amplitude of the wiggle perpendicular to the source line.
- length**: The length of the wiggle along the line.
- randomness**: The scale factor by which the length is shrunken or expanded.

May return None if no sketch parameters were set.

get_snap()

returns the snap setting which may be:

- True**: snap vertices to the nearest pixel center
- False**: leave vertices as-is
- None**: (auto) If the path contains only rectilinear line segments, round to the nearest pixel center

get_url()

returns a url if one is set, None otherwise

restore()

Restore the graphics context from the stack - needed only for backends that save graphics contexts on a stack

set_alpha(*alpha*)

Set the alpha value used for blending - not supported on all backends. If *alpha*=None (the default), the alpha components of the foreground and fill colors will be used to set their respective transparencies (where applicable); otherwise, *alpha* will override them.

set_antialiased(*b*)

True if object should be drawn with antialiased rendering

set_capstyle(*cs*)

Set the capstyle as a string in ('butt', 'round', 'projecting')

set_clip_path(*path*)

Set the clip path and transformation. Path should be a *TransformedPath* instance.

set_clip_rectangle(*rectangle*)

Set the clip rectangle with sequence (left, bottom, width, height)

set_dashes(*dash_offset*, *dash_list*)

Set the dash style for the gc.

dash_offset is the offset (usually 0).

dash_list specifies the on-off sequence as points. (None, None) specifies a solid line

set_foreground(*fg*, *isRGBA=False*)

Set the foreground color. *fg* can be a MATLAB format string, a html hex color string, an rgb or rgba unit tuple, or a float between 0 and 1. In the latter case, grayscale is used.

If you know *fg* is rgba, set *isRGBA=True* for efficiency.

set_gid(*id*)

Sets the id.

set_graylevel(*frac*)

Set the foreground color to be a gray level with *frac*

set_hatch(*hatch*)

Sets the hatch style for filling

set_hatch_color(*hatch_color*)

sets the color to use for hatching.

set_joinstyle(*js*)

Set the join style to be one of ('miter', 'round', 'bevel')

set_linestyle(*style*)

Set the linestyle to be one of ('solid', 'dashed', 'dashdot', 'dotted'). These are defined in the rc-Params `lines.dashed_pattern`, `lines.dashdot_pattern` and `lines.dotted_pattern`. One may also specify customized dash styles by providing a tuple of (offset, dash pairs).

set_linewidth(*w*)

Set the linewidth in points

set_sketch_params(*scale=None*, *length=None*, *randomness=None*)

Sets the sketch parameters.

Parameters scale : float, optional

The amplitude of the wiggle perpendicular to the source line, in pixels. If *scale* is None, or not provided, no sketch filter will be provided.

length : float, optional

The length of the wiggle along the line, in pixels (default 128.0)

randomness : float, optional

The scale factor by which the length is shrunken or expanded (default 16.0)

set_snap(*snap*)

Sets the snap setting which may be:

- True: snap vertices to the nearest pixel center
- False: leave vertices as-is

- None: (auto) If the path contains only rectilinear line segments, round to the nearest pixel center

set_url(*url*)

Sets the url for links in compatible backends

class matplotlib.backend_bases.**IdleEvent**(*name, canvas, guiEvent=None*)

Bases: [matplotlib.backend_bases.Event](#)

An event triggered by the GUI backend when it is idle – useful for passive animation

class matplotlib.backend_bases.**KeyEvent**(*name, canvas, key, x=0, y=0, guiEvent=None*)

Bases: [matplotlib.backend_bases.LocationEvent](#)

A key event (key press, key release).

Attach additional attributes as defined in [FigureCanvasBase.mpl_connect\(\)](#).

In addition to the [Event](#) and [LocationEvent](#) attributes, the following attributes are defined:

key the key(s) pressed. Could be **None**, a single case sensitive ascii character (“g”, “G”, “#”, etc.), a special key (“control”, “shift”, “f1”, “up”, etc.) or a combination of the above (e.g., “ctrl+alt+g”, “ctrl+alt+G”).

Note: Modifier keys will be prefixed to the pressed key and will be in the order “ctrl”, “alt”, “super”. The exception to this rule is when the pressed key is itself a modifier key, therefore “ctrl+alt” and “alt+control” can both be valid key values.

Example usage:

```
def on_key(event):
    print('you pressed', event.key, event.xdata, event.ydata)

cid = fig.canvas.mpl_connect('key_press_event', on_key)
```

class matplotlib.backend_bases.**LocationEvent**(*name, canvas, x, y, guiEvent=None*)

Bases: [matplotlib.backend_bases.Event](#)

An event that has a screen location

The following additional attributes are defined and shown with their default values.

In addition to the [Event](#) attributes, the following event attributes are defined:

x x position - pixels from left of canvas

y y position - pixels from bottom of canvas

inaxes the [Axes](#) instance if mouse is over axes

xdata x coord of mouse in data coords

ydata y coord of mouse in data coords

x, y in figure coords, 0,0 = bottom, left

inaxes = None

lastevent = None

x = None

xdata = None

y = None

ydata = None

class matplotlib.backend_bases.**MouseEvent**(*name, canvas, x, y, button=None, key=None, step=0, dblclick=False, guiEvent=None*)

Bases: [matplotlib.backend_bases.LocationEvent](#)

A mouse event ('button_press_event', 'button_release_event', 'scroll_event', 'motion_notify_event').

In addition to the [Event](#) and [LocationEvent](#) attributes, the following attributes are defined:

button button pressed None, 1, 2, 3, 'up', 'down' (up and down are used for scroll events). Note that in the nbagg backend, both the middle and right clicks return 3 since right clicking will bring up the context menu in some browsers.

key the key depressed when the mouse event triggered (see [KeyEvent](#))

step number of scroll steps (positive for 'up', negative for 'down')

Example usage:

```
def on_press(event):
    print('you pressed', event.button, event.xdata, event.ydata)

cid = fig.canvas.mpl_connect('button_press_event', on_press)
```

x, y in figure coords, 0,0 = bottom, left button pressed None, 1, 2, 3, 'up', 'down'

button = None

dblclick = None

inaxes = None

step = None

x = None

xdata = None

y = None

ydata = None

class matplotlib.backend_bases.**NavigationToolbar2**(*canvas*)

Bases: object

Base class for the navigation cursor, version 2

backends must implement a canvas that handles connections for ‘button_press_event’ and ‘button_release_event’. See *FigureCanvasBase.mpl_connect()* for more information

They must also define

save_figure() save the current figure

set_cursor() if you want the pointer icon to change

_init_toolbar() create your toolbar widget

draw_rubberband() (optional) draw the zoom to rect “rubberband” rectangle

press() (optional) whenever a mouse button is pressed, you’ll be notified with the event

release() (optional) whenever a mouse button is released, you’ll be notified with the event

dynamic_update() (optional) dynamically update the window while navigating

set_message() (optional) display message

set_history_buttons() (optional) you can change the history back / forward buttons to indicate disabled / enabled state.

That’s it, we’ll do the rest!

back(*args)

move back up the view lim stack

drag_pan(*event*)

the drag callback in pan/zoom mode

drag_zoom(*event*)

the drag callback in zoom mode

draw()

Redraw the canvases, update the locators

draw_rubberband(*event, x0, y0, x1, y1*)

Draw a rectangle rubberband to indicate zoom limits

dynamic_update()

forward(*args)

Move forward in the view lim stack

home(*args)

Restore the original view

mouse_move(event)

pan(*args)

Activate the pan/zoom tool. pan with left button, zoom with right

press(event)

Called whenever a mouse button is pressed.

press_pan(event)

the press mouse button in pan/zoom mode callback

press_zoom(event)

the press mouse button in zoom to rect mode callback

push_current()

push the current view limits and position onto the stack

release(event)

this will be called whenever mouse button is released

release_pan(event)

the release mouse button callback in pan/zoom mode

release_zoom(event)

the release mouse button callback in zoom to rect mode

remove_rubberband()

Remove the rubberband

save_figure(*args)

Save the current figure

set_cursor(cursor)

Set the current cursor to one of the Cursors enums values

set_history_buttons()

Enable or disable back/forward button

set_message(s)

Display a message on toolbar or in status bar

toolitems = (('Home', 'Reset original view', 'home', 'home'), ('Back', 'Back to previous view', 'back', 'back'))

update()

Reset the axes stack

zoom(*args)
Activate zoom to rect mode

exception matplotlib.backend_bases.NonGuiException

Bases: Exception

class matplotlib.backend_bases.PickEvent(name, canvas, mouseevent, artist, guiEvent=None, **kwargs)

Bases: *matplotlib.backend_bases.Event*

a pick event, fired when the user picks a location on the canvas sufficiently close to an artist.

Attrs: all the *Event* attributes plus

mouseevent the *MouseEvent* that generated the pick

artist the *Artist* picked

other extra class dependent attrs – e.g., a *Line2D* pick may define different extra attributes than a *PatchCollection* pick event

Example usage:

```
ax.plot(np.rand(100), 'o', picker=5) # 5 points tolerance

def on_pick(event):
    line = event.artist
    xdata, ydata = line.get_data()
    ind = event.ind
    print('on pick line:', np.array([xdata[ind], ydata[ind]]).T)

cid = fig.canvas.mpl_connect('pick_event', on_pick)
```

class matplotlib.backend_bases.RendererBase

Bases: object

An abstract base class to handle drawing/rendering operations.

The following methods must be implemented in the backend for full functionality (though just implementing *draw_path()* alone would give a highly capable backend):

- *draw_path()*
- *draw_image()*
- *draw_gouraud_triangle()*

The following methods *should* be implemented in the backend for optimization reasons:

- *draw_text()*
- *draw_markers()*
- *draw_path_collection()*
- *draw_quad_mesh()*

close_group(s)

Close a grouping element with label *s* Is only currently used by *backend_svg*

draw_gouraud_triangle(*gc, points, colors, transform*)

Draw a Gouraud-shaded triangle.

points is a 3x2 array of (x, y) points for the triangle.

colors is a 3x4 array of RGBA colors for each point of the triangle.

transform is an affine transform to apply to the points.

draw_gouraud_triangles(*gc, triangles_array, colors_array, transform*)

Draws a series of Gouraud triangles.

points is a Nx3x2 array of (x, y) points for the triangles.

colors is a Nx3x4 array of RGBA colors for each point of the triangles.

transform is an affine transform to apply to the points.

draw_image(*gc, x, y, im, transform=None*)

Draw an RGBA image.

gc a *GraphicsContextBase* instance with clipping information.

x the distance in physical units (i.e., dots or pixels) from the left hand side of the canvas.

y the distance in physical units (i.e., dots or pixels) from the bottom side of the canvas.

im An NxMx4 array of RGBA pixels (of dtype uint8).

transform If and only if the concrete backend is written such that *option_scale_image()* returns True, an affine transformation *may* be passed to *draw_image()*. It takes the form of a *Affine2DBase* instance. The translation vector of the transformation is given in physical units (i.e., dots or pixels). Note that the transformation does not override *x* and *y*, and has to be applied *before* translating the result by *x* and *y* (this can be accomplished by adding *x* and *y* to the translation vector defined by *transform*).

draw_markers(*gc, marker_path, marker_trans, path, trans, rgbFace=None*)

Draws a marker at each of the vertices in *path*. This includes all vertices, including control points on curves. To avoid that behavior, those vertices should be removed before calling this function.

gc the *GraphicsContextBase* instance

marker_trans is an affine transform applied to the marker.

trans is an affine transform applied to the path.

This provides a fallback implementation of *draw_markers* that makes multiple calls to *draw_path()*. Some backends may want to override this method in order to draw the marker only once and reuse it multiple times.

draw_path(*gc, path, transform, rgbFace=None*)

Draws a *Path* instance using the given affine transform.

draw_path_collection(*gc, master_transform, paths, all_transforms, offsets, offsetTrans, facecolors, edgecolors, linewidths, linestyle, antialiaseds, urls, offset_position*)

Draws a collection of paths selecting drawing properties from the lists *facecolors*, *edgecolors*,

linewidths, *linestyles* and *antialiaseds*. *offsets* is a list of offsets to apply to each of the paths. The offsets in *offsets* are first transformed by *offsetTrans* before being applied. *offset_position* may be either “screen” or “data” depending on the space that the offsets are in.

This provides a fallback implementation of `draw_path_collection()` that makes multiple calls to `draw_path()`. Some backends may want to override this in order to render each set of path data only once, and then reference that path multiple times with the different offsets, colors, styles etc. The generator methods `_iter_collection_raw_paths()` and `_iter_collection()` are provided to help with (and standardize) the implementation across backends. It is highly recommended to use those generators, so that changes to the behavior of `draw_path_collection()` can be made globally.

draw_quad_mesh(*gc*, *master_transform*, *meshWidth*, *meshHeight*, *coordinates*, *offsets*, *offset-Trans*, *facecolors*, *antialiased*, *edgecolors*)

This provides a fallback implementation of `draw_quad_mesh()` that generates paths and then calls `draw_path_collection()`.

draw_tex(*gc*, *x*, *y*, *s*, *prop*, *angle*, *ismath*='TeX!', *mtext*=None)

draw_text(*gc*, *x*, *y*, *s*, *prop*, *angle*, *ismath*=False, *mtext*=None)

Draw the text instance

gc the `GraphicsContextBase` instance

x the x location of the text in display coords

y the y location of the text baseline in display coords

s the text string

prop a `matplotlib.font_manager.FontProperties` instance

angle the rotation angle in degrees

mtext a `matplotlib.text.Text` instance

backend implementers note

When you are trying to determine if you have gotten your bounding box right (which is what enables the text layout/alignment to work properly), it helps to change the line in `text.py`:

```
if 0: bbox_artist(self, renderer)
```

to if 1, and then the actual bounding box will be plotted along with your text.

flipy()

Return true if y small numbers are top for renderer Is used for drawing text (`matplotlib.text`) and images (`matplotlib.image`) only

get_canvas_width_height()

return the canvas width and height in display coords

get_image_magnification()

Get the factor by which to magnify images passed to `draw_image()`. Allows a backend to have images at a different resolution to other artists.

get_texmanager()return the `matplotlib.texmanager.TextManager` instance**get_text_width_height_descent**(*s, prop, ismath*)get the width and height, and the offset from the bottom to the baseline (descent), in display coords of the string *s* with *FontProperties* prop**new_gc()**Return an instance of a *GraphicsContextBase***open_group**(*s, gid=None*)Open a grouping element with label *s*. If *gid* is given, use *gid* as the id of the group. Is only currently used by *backend_svg*.**option_image_nocomposite()**

override this method for renderers that do not necessarily always want to rescale and composite raster images. (like SVG, PDF, or PS)

option_scale_image()override this method for renderers that support arbitrary affine transformations in *draw_image()* (most vector backends).**points_to_pixels**(*points*)

Convert points to display units

points a float or a numpy array of float

return points converted to pixels

You need to override this function (unless your backend doesn't have a dpi, e.g., postscript or svg). Some imaging systems assume some value for pixels per inch:

$$\text{points to pixels} = \text{points} * \text{pixels_per_inch}/72.0 * \text{dpi}/72.0$$

start_filter()Used in *AggRenderer*. Switch to a temporary renderer for image filtering effects.**start_rasterizing()**Used in *MixedModeRenderer*. Switch to the raster renderer.**stop_filter**(*filter_func*)Used in *AggRenderer*. Switch back to the original renderer. The contents of the temporary renderer is processed with the *filter_func* and is drawn on the original renderer as an image.**stop_rasterizing()**Used in *MixedModeRenderer*. Switch back to the vector renderer and draw the contents of the raster renderer as an image on the vector renderer.**strip_math**(*s*)**class matplotlib.backend_bases.ResizeEvent**(*name, canvas*)Bases: *matplotlib.backend_bases.Event*

An event triggered by a canvas resize

In addition to the *Event* attributes, the following event attributes are defined:

width width of the canvas in pixels

height height of the canvas in pixels

class `matplotlib.backend_bases.ShowBase`

Bases: `object`

Simple base class to generate a `show()` callable in backends.

Subclass must override `mainloop()` method.

mainloop()

class `matplotlib.backend_bases.StatusbarBase(toolmanager)`

Bases: `object`

Base class for the statusbar

set_message(s)

Display a message on toolbar or in status bar

Parameters `s` : `str`

Message text

class `matplotlib.backend_bases.TimerBase(interval=None, callbacks=None)`

Bases: `object`

A base class for providing timer events, useful for things animations. Backends need to implement a few specific methods in order to use their own timing mechanisms so that the timer events are integrated into their event loops.

Mandatory functions that must be implemented:

- `_timer_start`: Contains backend-specific code for starting the timer
- `_timer_stop`: Contains backend-specific code for stopping the timer

Optional overrides:

- `_timer_set_single_shot`: Code for setting the timer to single shot operating mode, if supported by the timer object. If not, the `Timer` class itself will store the flag and the `_on_timer` method should be overridden to support such behavior.
- `_timer_set_interval`: Code for setting the interval on the timer, if there is a method for doing so on the timer object.
- `_on_timer`: This is the internal function that any timer object should call, which will handle the task of running all callbacks that have been set.

Attributes:

- `interval`: The time between timer events in milliseconds. Default is 1000 ms.
- `single_shot`: Boolean flag indicating whether this timer should operate as single shot (run once and then stop). Defaults to `False`.

- **callbacks**: Stores list of (func, args) tuples that will be called upon timer events. This list can be manipulated directly, or the functions `add_callback` and `remove_callback` can be used.

add_callback(*func*, *args, **kwargs)

Register *func* to be called by timer when the event fires. Any additional arguments provided will be passed to *func*.

interval

remove_callback(*func*, *args, **kwargs)

Remove *func* from list of callbacks. *args* and *kwargs* are optional and used to distinguish between copies of the same function registered to be called with different arguments.

single_shot

start(*interval=None*)

Start the timer object. *interval* is optional and will be used to reset the timer interval first if provided.

stop()

Stop the timer.

class matplotlib.backend_bases.**ToolContainerBase**(*toolmanager*)

Bases: object

Base class for all tool containers, e.g. toolbars.

Attributes

toolmanager	(ToolManager object that holds the tools that) this ToolContainer wants to communicate with.
-------------	----------------------------------------------------------------------------------------------

add_tool(*tool*, *group*, *position=-1*)

Adds a tool to this container

Parameters *tool* : tool_like

The tool to add, see `ToolManager.get_tool`.

group : str

The name of the group to add this tool to.

position : int (optional)

The position within the group to place this tool. Defaults to end.

add_toolitem(*name*, *group*, *position*, *image*, *description*, *toggle*)

Add a toolitem to the container

This method must get implemented per backend

The callback associated with the button click event, must be **EXACTLY** `self.trigger_tool(name)`

Parameters name : string

Name of the tool to add, this gets used as the tool's ID and as the default label of the buttons

group : String

Name of the group that this tool belongs to

position : Int

Position of the tool within its group, if -1 it goes at the End

image_file : String

Filename of the image for the button or None

description : String

Description of the tool, used for the tooltips

toggle : Bool

- True : The button is a toggle (change the pressed/unpressed state between consecutive clicks)
- False : The button is a normal button (returns to unpressed state after release)

remove_toolitem(*name*)

Remove a toolitem from the ToolContainer

This method must get implemented per backend

Called when ToolManager emits a `tool_removed_event`

Parameters name : string

Name of the tool to remove

toggle_toolitem(*name*, *toggled*)

Toggle the toolitem without firing event

Parameters name : String

Id of the tool to toggle

toggled : bool

Whether to set this tool as toggled or not.

trigger_tool(*name*)

Trigger the tool

Parameters name : String

Name(id) of the tool triggered from within the container

`matplotlib.backend_bases.get_registered_canvas_class`(*format*)

Return the registered default canvas for given file format. Handles deferred import of required backend.

matplotlib.backend_bases.**key_press_handler**(*event, canvas, toolbar=None*)

Implement the default mpl key bindings for the canvas and toolbar described at *Navigation Keyboard Shortcuts*

event a *KeyEvent* instance

canvas a *FigureCanvasBase* instance

toolbar a *NavigationToolbar2* instance

matplotlib.backend_bases.**register_backend**(*format, backend, description=None*)

Register a backend for saving to a given file format.

format [str] File extention

backend [module string or canvas class] Backend for handling file output

description [str, optional] Description of the file type. Defaults to an empty string

21.2 matplotlib.backend_managers

ToolManager Class that makes the bridge between user interaction (key press, toolbar clicks, ..) and the actions in response to the user inputs.

class matplotlib.backend_managers.**ToolEvent**(*name, sender, tool, data=None*)

Bases: object

Event for tool manipulation (add/remove)

class matplotlib.backend_managers.**ToolManager**(*canvas*)

Bases: object

Helper class that groups all the user interactions for a FigureManager

Attributes

manager: FigureManager	
keypresslock: widgets.LockDraw	LockDraw object to know if the canvas key_press_event is locked
messagelock: widgets.LockDraw	LockDraw object to know if the message is available to write

active_toggle

Currently toggled tools

add_tool(*name, tool, *args, **kwargs*)

Add *tool* to *ToolManager*

If successful adds a new event `tool_trigger_name` where **name** is the **name** of the tool, this event is fired everytime the tool is triggered.

Parameters name : str

Name of the tool, treated as the ID, has to be unique

tool : class_like, i.e. str or type

Reference to find the class of the Tool to added.

See also:

[*matplotlib.backend_tools.ToolBase*](#) The base class for tools.

Notes

args and kwargs get passed directly to the tools constructor.

get_tool(*name*, *warn=True*)

Return the tool object, also accepts the actual tool for convenience

Parameters *name* : str, ToolBase

Name of the tool, or the tool itself

warn : bool, optional

If this method should give warnings.

get_tool_keymap(*name*)

Get the keymap associated with the specified tool

Parameters *name* : string

Name of the Tool

Returns *list* : list of keys associated with the Tool

message_event(*message*, *sender=None*)

Emit a [*ToolManagerMessageEvent*](#)

remove_tool(*name*)

Remove tool from [*ToolManager*](#)

Parameters *name* : string

Name of the Tool

toolmanager_connect(*s*, *func*)

Connect event with string *s* to *func*.

Parameters *s* : String

Name of the event

The following events are recognized

- 'tool_message_event'
- 'tool_removed_event'
- 'tool_added_event'

For every tool added a new event is created

- ‘tool_trigger_TOOLNAME’ Where TOOLNAME is the id of the tool.

func : function

Function to be called with signature `def func(event)`

toolmanager_disconnect(*cid*)

Disconnect callback id *cid*

Example usage:

```
cid = toolmanager.toolmanager_connect('tool_trigger_zoom',
                                     on_press)
#...later
toolmanager.toolmanager_disconnect(cid)
```

tools

Return the tools controlled by *ToolManager*

trigger_tool(*name*, *sender=None*, *canvasevent=None*, *data=None*)

Trigger a tool and emit the tool_trigger_[name] event

Parameters name : string

Name of the tool

sender: object

Object that wishes to trigger the tool

canvasevent : Event

Original Canvas event or None

data : Object

Extra data to pass to the tool when triggering

update_keymap(*name*, **keys*)

Set the keymap to associate with the specified tool

Parameters name : string

Name of the Tool

keys : keys to associate with the Tool

class matplotlib.backend_managers.**ToolManagerMessageEvent**(*name*, *sender*, *message*)

Bases: object

Event carrying messages from toolmanager

Messages usually get displayed to the user by the toolbar

class matplotlib.backend_managers.**ToolTriggerEvent**(*name*, *sender*, *tool*, *canvasevent=None*, *data=None*)

Bases: *matplotlib.backend_managers.ToolEvent*

Event to inform that a tool has been triggered

21.3 matplotlib.backend_tools

Abstract base classes define the primitives for Tools. These tools are used by *matplotlib.backend_managers.ToolManager*

ToolBase Simple stateless tool

ToolToggleBase Tool that has two states, only one Toggle tool can be active at any given time for the same *matplotlib.backend_managers.ToolManager*

class matplotlib.backend_tools.AxisScaleBase(*args, **kwargs)

Bases: *matplotlib.backend_tools.ToolToggleBase*

Base Tool to toggle between linear and logarithmic

disable(*event*)

enable(*event*)

trigger(*sender, event, data=None*)

class matplotlib.backend_tools.ConfigureSubplotsBase(toolmanager, name)

Bases: *matplotlib.backend_tools.ToolBase*

Base tool for the configuration of subplots

description = 'Configure subplots'

image = 'subplots.png'

class matplotlib.backend_tools.Cursors

Bases: object

Simple namespace for cursor reference

HAND = 0

MOVE = 3

POINTER = 1

SELECT_REGION = 2

class matplotlib.backend_tools.**RubberbandBase**(*toolmanager, name*)

Bases: *matplotlib.backend_tools.ToolBase*

Draw and remove rubberband

draw_rubberband(**data*)

Draw rubberband

This method must get implemented per backend

remove_rubberband()

Remove rubberband

This method should get implemented per backend

trigger(*sender, event, data*)

Call *draw_rubberband* or *remove_rubberband* based on data

class matplotlib.backend_tools.**SaveFigureBase**(*toolmanager, name*)

Bases: *matplotlib.backend_tools.ToolBase*

Base tool for figure saving

default_keymap = ['s', 'ctrl+s']

description = 'Save the figure'

image = 'filesave.png'

class matplotlib.backend_tools.**SetCursorBase**(**args, **kwargs*)

Bases: *matplotlib.backend_tools.ToolBase*

Change to the current cursor while in axes

This tool, keeps track of all *ToolToggleBase* derived tools, and calls *set_cursor* when a tool gets triggered

set_cursor(*cursor*)

Set the cursor

This method has to be implemented per backend

class matplotlib.backend_tools.**ToolBack**(*toolmanager, name*)

Bases: *matplotlib.backend_tools.ViewsPositionsBase*

Move back up the view lim stack

default_keymap = ['left', 'c', 'backspace']

description = 'Back to previous view'

image = 'back.png'

class `matplotlib.backend_tools.ToolBase`(*toolmanager, name*)

Bases: `object`

Base tool class

A base tool, only implements `trigger` method or not method at all. The tool is instantiated by `matplotlib.backend_managers.ToolManager`

Attributes

<code>toolmanager: matplotlib.backend_managers.ToolManager</code>	ToolManager that controls this Tool
<code>figure: FigureCanvas</code>	Figure instance that is affected by this Tool
<code>name: String</code>	Used as Id of the tool, has to be unique among tools of the same ToolManager

default_keymap = None

Keymap to associate with this tool

String: List of comma separated keys that will be used to call this tool when the keypress event of `self.figure.canvas` is emitted

description = None

Description of the Tool

String: If the Tool is included in the Toolbar this text is used as a Tooltip

destroy()

Destroy the tool

This method is called when the tool is removed by `matplotlib.backend_managers.ToolManager.remove_tool`

figure

image = None

Filename of the image

String: Filename of the image to use in the toolbar. If None, the `name` is used as a label in the toolbar button

name

Tool Id

trigger(*sender, event, data=None*)

Called when this tool gets used

This method is called by `matplotlib.backend_managers.ToolManager.trigger_tool`

Parameters event: 'Event'

The Canvas event that caused this tool to be called

sender: object

Object that requested the tool to be triggered

data: object

Extra data

class matplotlib.backend_tools.**ToolCursorPosition**(*args, **kwargs)

Bases: *matplotlib.backend_tools.ToolBase*

Send message with the current pointer position

This tool runs in the background reporting the position of the cursor

send_message(event)

Call *matplotlib.backend_managers.ToolManager.message_event*

class matplotlib.backend_tools.**ToolEnableAllNavigation**(toolmanager, name)

Bases: *matplotlib.backend_tools.ToolBase*

Tool to enable all axes for toolmanager interaction

default_keymap = ['a']

description = 'Enables all axes toolmanager'

trigger(sender, event, data=None)

class matplotlib.backend_tools.**ToolEnableNavigation**(toolmanager, name)

Bases: *matplotlib.backend_tools.ToolBase*

Tool to enable a specific axes for toolmanager interaction

default_keymap = (1, 2, 3, 4, 5, 6, 7, 8, 9)

description = 'Enables one axes toolmanager'

trigger(sender, event, data=None)

class matplotlib.backend_tools.**ToolForward**(toolmanager, name)

Bases: *matplotlib.backend_tools.ViewsPositionsBase*

Move forward in the view lim stack

default_keymap = ['right', 'v']

description = 'Forward to next view'

image = 'forward.png'

```
class matplotlib.backend_tools.ToolFullScreen(*args, **kwargs)
```

```
    Bases: matplotlib.backend_tools.ToolToggleBase
```

```
    Tool to toggle full screen
```

```
    default_keymap = ['f', 'ctrl+f']
```

```
    description = 'Toggle Fullscreen mode'
```

```
    disable(event)
```

```
    enable(event)
```

```
class matplotlib.backend_tools.ToolGrid(*args, **kwargs)
```

```
    Bases: matplotlib.backend_tools.ToolToggleBase
```

```
    Tool to toggle the grid of the figure
```

```
    default_keymap = ['g']
```

```
    description = 'Toggle Grid'
```

```
    disable(event)
```

```
    enable(event)
```

```
    trigger(sender, event, data=None)
```

```
class matplotlib.backend_tools.ToolHome(toolmanager, name)
```

```
    Bases: matplotlib.backend_tools.ViewsPositionsBase
```

```
    Restore the original view lim
```

```
    default_keymap = ['h', 'r', 'home']
```

```
    description = 'Reset original view'
```

```
    image = 'home.png'
```

```
class matplotlib.backend_tools.ToolPan(*args)
```

```
    Bases: matplotlib.backend_tools.ZoomPanBase
```

```
    Pan axes with left mouse, zoom with right
```

```
    cursor = 3
```

```
default_keymap = ['p']
```

```
description = 'Pan axes with left mouse, zoom with right'
```

```
image = 'move.png'
```

```
radio_group = 'default'
```

```
class matplotlib.backend_tools.ToolQuit(toolmanager, name)
```

```
    Bases: matplotlib.backend_tools.ToolBase
```

```
    Tool to call the figure manager destroy method
```

```
    default_keymap = ['ctrl+w', 'cmd+w']
```

```
    description = 'Quit the figure'
```

```
    trigger(sender, event, data=None)
```

```
class matplotlib.backend_tools.ToolToggleBase(*args, **kwargs)
```

```
    Bases: matplotlib.backend_tools.ToolBase
```

```
    Toggleable tool
```

```
    Every time it is triggered, it switches between enable and disable
```

```
    cursor = None
```

```
        Cursor to use when the tool is active
```

```
    disable(event=None)
```

```
        Disable the toggle tool
```

```
        trigger call this method when toggled is True.
```

```
        This can happen in different circumstances
```

- Click on the toolbar tool button
- Call to *matplotlib.backend_managers.ToolManager.trigger_tool*
- Another *ToolToggleBase* derived tool is triggered (from the same *ToolManager*)

```
    enable(event=None)
```

```
        Enable the toggle tool
```

```
        trigger calls this method when toggled is False
```

```
    radio_group = None
```

```
        Attribute to group 'radio' like tools (mutually exclusive)
```

```
        String that identifies the group or None if not belonging to a group
```

toggled

State of the toggled tool

trigger(*sender, event, data=None*)

Calls *enable* or *disable* based on *toggled* value

class matplotlib.backend_tools.**ToolViewsPositions**(*args, **kwargs)

Bases: *matplotlib.backend_tools.ToolBase*

Auxiliary Tool to handle changes in views and positions

Runs in the background and should get used by all the tools that need to access the figure's history of views and positions, e.g.

- *ToolZoom*
- *ToolPan*
- *ToolHome*
- *ToolBack*
- *ToolForward*

add_figure()

Add the current figure to the stack of views and positions

back()

Back one step in the stack of views and positions

clear(*figure*)

Reset the axes stack

forward()

Forward one step in the stack of views and positions

home()

Recall the first view and position from the stack

push_current()

push the current view limits and position onto the stack

refresh_locators()

Redraw the canvases, update the locators

update_view()

Update the viewlim and position from the view and position stack for each axes

class matplotlib.backend_tools.**ToolXScale**(*args, **kwargs)

Bases: *matplotlib.backend_tools.AxisScaleBase*

Tool to toggle between linear and logarithmic scales on the X axis

default_keymap = ['k', 'L']

description = 'Toggle Scale X axis'

`set_scale(ax, scale)`

class `matplotlib.backend_tools.ToolYScale(*args, **kwargs)`

Bases: `matplotlib.backend_tools.AxisScaleBase`

Tool to toggle between linear and logarithmic scales on the Y axis

default_keymap = ['l']

description = 'Toggle Scale Y axis'

`set_scale(ax, scale)`

class `matplotlib.backend_tools.ToolZoom(*args)`

Bases: `matplotlib.backend_tools.ZoomPanBase`

Zoom to rectangle

cursor = 2

default_keymap = ['o']

description = 'Zoom to rectangle'

image = 'zoom_to_rect.png'

radio_group = 'default'

class `matplotlib.backend_tools.ViewsPositionsBase(toolmanager, name)`

Bases: `matplotlib.backend_tools.ToolBase`

Base class for `ToolHome`, `ToolBack` and `ToolForward`

trigger(*sender, event, data=None*)

class `matplotlib.backend_tools.ZoomPanBase(*args)`

Bases: `matplotlib.backend_tools.ToolToggleBase`

Base class for `ToolZoom` and `ToolPan`

disable(*event*)

Release the canvas and disconnect press/release events

enable(*event*)

Connect press/release events and lock the canvas

scroll_zoom(*event*)

`trigger(sender, event, data=None)`

`matplotlib.backend_tools.add_tools_to_container(container, tools=[['navigation',
['home', 'back', 'forward']], ['zoom-
pan', ['pan', 'zoom', 'subplots']],
['io', ['save']]])`

Add multiple tools to the container.

Parameters container: Container

`backend_bases.ToolContainerBase` object that will get the tools added

tools : list, optional

List in the form `[[group1, [tool1, tool2 ...]], [group2, [...]]]` Where the tools given by `tool1`, and `tool2` will display in `group1`. See `add_tool` for details.

`matplotlib.backend_tools.add_tools_to_manager(toolmanager, tools={'home': <class
'matplotlib.backend_tools.ToolHome'>,
'back': <class 'mat-
plotlib.backend_tools.ToolBack'>,
'forward': <class 'mat-
plotlib.backend_tools.ToolForward'>,
'zoom': <class 'mat-
plotlib.backend_tools.ToolZoom'>,
'pan': <class 'mat-
plotlib.backend_tools.ToolPan'>,
'subplots': 'ToolConfigureSubplots',
'save': 'ToolSaveFigure', 'grid': <class
'matplotlib.backend_tools.ToolGrid'>,
'fullscreen': <class 'mat-
plotlib.backend_tools.ToolFullScreen'>,
'quit': <class 'mat-
plotlib.backend_tools.ToolQuit'>,
'allnav': <class 'mat-
plotlib.backend_tools.ToolEnableAllNavigation'>,
'nav': <class 'mat-
plotlib.backend_tools.ToolEnableNavigation'>,
'xscale': <class 'mat-
plotlib.backend_tools.ToolXScale'>,
'yscale': <class 'mat-
plotlib.backend_tools.ToolYScale'>,
'position': <class 'mat-
plotlib.backend_tools.ToolCursorPosition'>,
'viewpos': <class 'mat-
plotlib.backend_tools.ToolViewsPositions'>,
'cursor': 'ToolSetCursor', 'rubber-
band': 'ToolRubberband'})`

Add multiple tools to ToolManager

Parameters toolmanager: ToolManager

`backend_managers.ToolManager` object that will get the tools added

tools : {str: class_like}, optional

The tools to add in a {name: tool} dict, see `add_tool` for more info.

`matplotlib.backend_tools.default_toolbar_tools` = [['navigation', 'home', 'back', 'forward']], ['zoompan', ...]
Default tools in the toolbar

`matplotlib.backend_tools.default_tools` = {'home': <class 'matplotlib.backend_tools.ToolHome'>, 'back': <...>
Default tools

21.4 matplotlib.backends.backend_gtkagg

TODO We'll add this later, importing the gtk backends requires an active X-session, which is not compatible with cron jobs.

21.5 matplotlib.backends.backend_qt4agg

Render to qt from agg

`matplotlib.backends.backend_qt4agg.FigureCanvas`
alias of `FigureCanvasQTAgg`

class `matplotlib.backends.backend_qt4agg.FigureCanvasQTAgg`(*figure*)
Bases: `matplotlib.backends.backend_qt4agg.FigureCanvasQTAggBase`, `matplotlib.backends.backend_qt4.FigureCanvasQT`, `matplotlib.backends.backend_agg.FigureCanvasAgg`

The canvas the figure renders into. Calls the draw and print fig methods, creates the renderers, etc...

Public attribute

`figure` - A Figure instance

class `matplotlib.backends.backend_qt4agg.FigureCanvasQTAggBase`(*figure*)
Bases: `matplotlib.backends.backend_qt5agg.FigureCanvasQTAggBase`

`matplotlib.backends.backend_qt4agg.new_figure_manager`(*num*, **args*, ***kwargs*)
Create a new figure manager instance

`matplotlib.backends.backend_qt4agg.new_figure_manager_given_figure`(*num*, *figure*)
Create a new figure manager instance for the given figure.

21.6 matplotlib.backends.backend_qt5agg

Render to qt from agg

`matplotlib.backends.backend_qt5agg.FigureCanvas`
alias of `FigureCanvasQTAgg`

class matplotlib.backends.backend_qt5agg.**FigureCanvasQTAgg**(*figure*)

Bases: `matplotlib.backends.backend_qt5agg.FigureCanvasQTAggBase`, `matplotlib.backends.backend_qt5.FigureCanvasQT`, `matplotlib.backends.backend_agg.FigureCanvasAgg`

The canvas the figure renders into. Calls the draw and print fig methods, creates the renderers, etc.

Modified to import from Qt5 backend for new-style mouse events.

Public attribute

`figure` - A Figure instance

class matplotlib.backends.backend_qt5agg.**FigureCanvasQTAggBase**(*figure*)

Bases: `object`

The canvas the figure renders into. Calls the draw and print fig methods, creates the renderers, etc...

Public attribute

`figure` - A Figure instance

blit(*bbox=None*)

Blit the region in `bbox`

draw()

Draw the figure with Agg, and queue a request for a Qt draw.

drawRectangle(*rect*)

draw_idle()

Queue redraw of the Agg buffer and request Qt `paintEvent`.

paintEvent(*e*)

Copy the image from the Agg canvas to the `qt.drawable`. In Qt, all drawing should be done inside of here when a widget is shown onscreen.

print_figure(**args*, ***kwargs*)

`matplotlib.backends.backend_qt5agg.new_figure_manager`(*num*, **args*, ***kwargs*)

Create a new figure manager instance

`matplotlib.backends.backend_qt5agg.new_figure_manager_given_figure`(*num*, *figure*)

Create a new figure manager instance for the given figure.

21.7 matplotlib.backends.backend_wxagg

`matplotlib.backends.backend_wxagg.FigureCanvas`

alias of `FigureCanvasWxAgg`

class matplotlib.backends.backend_wxagg.**FigureCanvasWxAgg**(*parent*, *id*, *figure*)

Bases: `matplotlib.backends.backend_agg.FigureCanvasAgg`, `matplotlib.backends.backend_wx.FigureCanvasWx`

The FigureCanvas contains the figure and does event handling.

In the wxPython backend, it is derived from wxPanel, and (usually) lives inside a frame instantiated by a FigureManagerWx. The parent window probably implements a wxSizer to control the displayed control size - but we give a hint as to our preferred minimum size.

Initialise a FigureWx instance.

- Initialise the FigureCanvasBase and wxPanel parents.
- Set event handlers for: EVT_SIZE (Resize event) EVT_PAINT (Paint event)

blit(*bbox=None*)

Transfer the region of the agg buffer defined by bbox to the display. If bbox is None, the entire buffer is transferred.

draw(*drawDC=None*)

Render the figure using agg.

filetypes = {'ps': 'Postscript', 'eps': 'Encapsulated Postscript', 'pdf': 'Portable Document Format', 'pgf': 'Pgf'}

print_figure(*filename, *args, **kwargs*)

class matplotlib.backends.backend_wxagg.**FigureFrameWxAgg**(*num, fig*)

Bases: matplotlib.backends.backend_wx.**FigureFrameWx**

get_canvas(*fig*)

class matplotlib.backends.backend_wxagg.**NavigationToolbar2WxAgg**(*canvas*)

Bases: matplotlib.backends.backend_wx.**NavigationToolbar2Wx**

get_canvas(*frame, fig*)

matplotlib.backends.backend_wxagg.**new_figure_manager**(*num, *args, **kwargs*)

Create a new figure manager instance

matplotlib.backends.backend_wxagg.**new_figure_manager_given_figure**(*num, figure*)

Create a new figure manager instance for the given figure.

21.8 matplotlib.backends.backend_pdf

A PDF matplotlib backend Author: Jouni K Seppänen <jks@iki.fi>

matplotlib.backends.backend_pdf.**FigureCanvas**

alias of *FigureCanvasPdf*

class matplotlib.backends.backend_pdf.**FigureCanvasPdf**(*figure*)

Bases: *matplotlib.backend_bases.FigureCanvasBase*

The canvas the figure renders into. Calls the draw and print fig methods, creates the renderers, etc...

Public attribute

figure - A Figure instance

class matplotlib.backends.backend_pdf.**Name**(*name*)

Bases: object

PDF name object.

class matplotlib.backends.backend_pdf.**Operator**(*op*)

Bases: object

PDF operator object.

class matplotlib.backends.backend_pdf.**PdfFile**(*filename*)

Bases: object

PDF file object.

alphaState(*alpha*)

Return name of an ExtGState that sets alpha to the given value

embedTTF(*filename, characters*)

Embed the TTF font from the named file into the document.

fontName(*fontprop*)

Select a font based on fontprop and return a name suitable for Op.selectfont. If fontprop is a string, it will be interpreted as the filename (or dvi name) of the font.

imageObject(*image*)

Return name of an image XObject representing the given image.

markerObject(*path, trans, fill, stroke, lw, joinstyle, capstyle*)

Return name of a marker XObject representing the given path.

reserveObject(*name=''*)

Reserve an ID for an indirect object. The name is used for debugging in case we forget to print out the object with writeObject.

writeInfoDict()

Write out the info dictionary, checking it for good form

writeTrailer()

Write out the PDF trailer.

writeXref()

Write out the xref table.

class matplotlib.backends.backend_pdf.**PdfPages**(*filename, keep_empty=True*)

Bases: object

A multi-page PDF file.

Notes

In reality *PdfPages* is a thin wrapper around *PdfFile*, in order to avoid confusion when using *savefig()* and forgetting the format argument.

Examples

```
>>> import matplotlib.pyplot as plt
>>> # Initialize:
>>> with PdfPages('foo.pdf') as pdf:
...     # As many times as you like, create a figure fig and save it:
...     fig = plt.figure()
...     pdf.savefig(fig)
...     # When no figure is specified the current figure is saved
...     pdf.savefig()
```

Create a new PdfPages object.

Parameters filename: str

Plots using *PdfPages.savefig()* will be written to a file at this location. The file is opened at once and any older file with the same name is overwritten.

keep_empty: bool, optional

If set to False, then empty pdf files will be deleted automatically when closed.

attach_note(text, positionRect=[-100, -100, 0, 0])

Add a new text note to the page to be saved next. The optional positionRect specifies the position of the new note on the page. It is outside the page per default to make sure it is invisible on printouts.

close()

Finalize this object, making the underlying file a complete PDF file.

get_pagecount()

Returns the current number of pages in the multipage pdf file.

infodict()

Return a modifiable information dictionary object (see PDF reference section 10.2.1 ‘Document Information Dictionary’).

savefig(*figure=None*, ***kwargs*)

Saves a *Figure* to this file as a new page.

Any other keyword arguments are passed to *savefig()*.

Parameters figure: :class:‘~matplotlib.figure.Figure’ or int, optional

Specifies what figure is saved to file. If not specified, the active figure is saved. If a *Figure* instance is provided, this figure is saved. If an int is specified, the figure instance to save is looked up by number.

class matplotlib.backends.backend_pdf.**Reference**(*id*)

Bases: object

PDF reference object. Use PdfFile.reserveObject() to create References.

class matplotlib.backends.backend_pdf.**Stream**(*id, len, file, extra=None, png=None*)

Bases: object

PDF stream object.

This has no pdfRepr method. Instead, call begin(), then output the contents of the stream by calling write(), and finally call end().

id: object id of stream; len: an unused Reference object for the length of the stream, or None (to use a memory buffer); file: a PdfFile; extra: a dictionary of extra key-value pairs to include in the stream header; png: if the data is already png compressed, the decode parameters

end()

Finalize stream.

write(*data*)

Write some data on the stream.

class matplotlib.backends.backend_pdf.**Verbatim**(*x*)

Bases: object

Store verbatim PDF command content for later inclusion in the stream.

matplotlib.backends.backend_pdf.**fill**(*strings, linelen=75*)

Make one string from sequence of strings, with whitespace in between. The whitespace is chosen to form lines of at most linelen characters, if possible.

matplotlib.backends.backend_pdf.**new_figure_manager**(*num, *args, **kwargs*)

Create a new figure manager instance

matplotlib.backends.backend_pdf.**new_figure_manager_given_figure**(*num, figure*)

Create a new figure manager instance for the given figure.

matplotlib.backends.backend_pdf.**pdfRepr**(*obj*)

Map Python objects to PDF syntax.

21.9 matplotlib.backends.backend_svg

matplotlib.backends.backend_svg.**new_figure_manager_given_figure**(*num, figure*)

Create a new figure manager instance for the given figure.

matplotlib.backends.backend_svg.**short_float_fmt**(*x*)

Create a short string representation of a float, which is %f formatting with trailing zeros and the decimal point removed.

22.1 matplotlib.cbook

A collection of utility functions and classes. Originally, many (but not all) were from the Python Cookbook – hence the name cbook.

This module is safe to import from anywhere within matplotlib; it imports matplotlib only at runtime.

class matplotlib.cbook.Bunch(kwds)**

Bases: object

Often we want to just collect a bunch of stuff together, naming each item of the bunch; a dictionary's OK for that, but a small do-nothing class is even handier, and prettier to use. Whenever you want to group a few variables:

```
>>> point = Bunch(datum=2, squared=4, coord=12)
>>> point.datum
```

By: Alex Martelli

From: <https://code.activestate.com/recipes/121294/>

class matplotlib.cbook.CallbackRegistry

Bases: object

Handle registering and disconnecting for a set of signals and callbacks:

```
>>> def oneat(x):
...     print('eat', x)
>>> def ondrink(x):
...     print('drink', x)
```

```
>>> from matplotlib.cbook import CallbackRegistry
>>> callbacks = CallbackRegistry()
```

```
>>> id_eat = callbacks.connect('eat', oneat)
>>> id_drink = callbacks.connect('drink', ondrink)
```

```
>>> callbacks.process('drink', 123)
drink 123
```

```

>>> callbacks.process('eat', 456)
eat 456
>>> callbacks.process('be merry', 456) # nothing will be called
>>> callbacks.disconnect(id_eat)
>>> callbacks.process('eat', 456)      # nothing will be called

```

In practice, one should always disconnect all callbacks when they are no longer needed to avoid dangling references (and thus memory leaks). However, real code in matplotlib rarely does so, and due to its design, it is rather difficult to place this kind of code. To get around this, and prevent this class of memory leaks, we instead store weak references to bound methods only, so when the destination object needs to die, the CallbackRegistry won't keep it alive. The Python stdlib weakref module can not create weak references to bound methods directly, so we need to create a proxy object to handle weak references to bound methods (or regular free functions). This technique was shared by Peter Parente on his “Mindtrove” blog.

connect(*s, func*)

register *func* to be called when a signal *s* is generated *func* will be called

disconnect(*cid*)

disconnect the callback registered with callback id *cid*

process(*s, *args, **kwargs*)

process signal *s*. All of the functions registered to receive callbacks on *s* will be called with **args* and ***kwargs*

class matplotlib.cbook.GetRealpathAndStat

Bases: object

class matplotlib.cbook.Grouper(*init=()*)

Bases: object

This class provides a lightweight way to group arbitrary objects together into disjoint sets when a full-blown graph data structure would be overkill.

Objects can be joined using *join()*, tested for connectedness using *joined()*, and all disjoint sets can be retrieved by using the object as an iterator.

The objects being joined must be hashable and weak-referenceable.

For example:

```

>>> from matplotlib.cbook import Grouper
>>> class Foo(object):
...     def __init__(self, s):
...         self.s = s
...     def __repr__(self):
...         return self.s
...
>>> a, b, c, d, e, f = [Foo(x) for x in 'abcdef']
>>> grp = Grouper()
>>> grp.join(a, b)
>>> grp.join(b, c)
>>> grp.join(d, e)
>>> sorted(map(tuple, grp))

```



```

[(a, b, c), (d, e)]
>>> grp.joined(a, b)
True
>>> grp.joined(a, c)
True
>>> grp.joined(a, d)
False

```

clean()

Clean dead weak references from the dictionary

get_siblings(*a*)

Returns all of the items joined with *a*, including itself.

join(*a*, **args*)

Join given arguments into the same set. Accepts one or more arguments.

joined(*a*, *b*)

Returns True if *a* and *b* are members of the same set.

remove(*a*)**exception matplotlib.cbook.IgnoredKeywordWarning**

Bases: UserWarning

A class for issuing warnings about keyword arguments that will be ignored by matplotlib

class matplotlib.cbook.Locked(*path*)

Bases: object

Context manager to handle locks.

Based on code from conda.

(c) 2012-2013 Continuum Analytics, Inc. / <https://www.continuum.io/> All Rights Reserved

conda is distributed under the terms of the BSD 3-clause license. Consult LICENSE_CONDA or <https://opensource.org/licenses/BSD-3-Clause>.

LOCKFN = '.matplotlib_lock'

exception TimeoutError

Bases: RuntimeError

exception matplotlib.cbook.MatplotlibDeprecationWarning

Bases: UserWarning

A class for issuing deprecation warnings for Matplotlib users.

In light of the fact that Python builtin DeprecationWarnings are ignored by default as of Python 2.7 (see link below), this class was put in to allow for the signaling of deprecation, but via UserWarnings which are not ignored by default.

<https://docs.python.org/dev/whatsnew/2.7.html#the-future-for-python-2-x>

```
class matplotlib.cbook.MemoryMonitor(nmax=20000)
```

```
    Bases: object
```

```
    clear()
```

```
    plot(i0=0, isub=1, fig=None)
```

```
    report(segments=4)
```

```
    xy(i0=0, isub=1)
```

```
class matplotlib.cbook.Null(*args, **kwargs)
```

```
    Bases: object
```

```
    Null objects always and reliably “do nothing.”
```

```
class matplotlib.cbook.RingBuffer(size_max)
```

```
    Bases: object
```

```
    class that implements a not-yet-full buffer
```

```
    append(x)
```

```
        append an element at the end of the buffer
```

```
    get()
```

```
        Return a list of elements from the oldest to the newest.
```

```
class matplotlib.cbook.Sorter
```

```
    Bases: object
```

```
    Sort by attribute or item
```

```
    Example usage:
```

```
sort = Sorter()

list = [(1, 2), (4, 8), (0, 3)]
dict = [{'a': 3, 'b': 4}, {'a': 5, 'b': 2}, {'a': 0, 'b': 0},
        {'a': 9, 'b': 9}]

sort(list)          # default sort
sort(list, 1)      # sort by index 1
sort(dict, 'a')    # sort a list of dicts by key 'a'
```

```
byAttribute(data, attributename, inplace=1)
```

```
byItem(data, itemindex=None, inplace=1)
```

```
sort(data, itemindex=None, inplace=1)
```

class matplotlib.cbook.**Stack**(*default=None*)

Bases: object

Implement a stack where elements can be pushed on and you can move back and forth. But no pop. Should mimic home / back / forward in a browser

back()

move the position back and return the current element

bubble(*o*)

raise *o* to the top of the stack and return *o*. *o* must be in the stack

clear()

empty the stack

empty()

forward()

move the position forward and return the current element

home()

push the first element onto the top of the stack

push(*o*)

push object onto stack at current position - all elements occurring later than the current position are discarded

remove(*o*)

remove element *o* from the stack

class matplotlib.cbook.**Xlator**

Bases: dict

All-in-one multiple-string-substitution class

Example usage:

```
text = "Larry Wall is the creator of Perl"
adict = {
    "Larry Wall" : "Guido van Rossum",
    "creator" : "Benevolent Dictator for Life",
    "Perl" : "Python",
}

print(multiple_replace(adict, text))

xlat = Xlator(adict)
print(xlat.xlat(text))
```

xlat(*text*)

Translate *text*, returns the modified text.

matplotlib.cbook.**align_iterators**(*func, *iterables*)

This generator takes a bunch of iterables that are ordered by *func*. It sends out ordered tuples:

```
(func(row), [rows from all iterators matching func(row)])
```

It is used by `matplotlib.mlab.recs_join()` to join record arrays

`matplotlib.cbook.allequal(seq)`

Return *True* if all elements of *seq* compare equal. If *seq* is 0 or 1 length, return *True*

`matplotlib.cbook.allpairs(x)`

return all possible pairs in sequence *x*

Condensed by Alex Martelli from this [thread](#) on c.l.python

`matplotlib.cbook.alltrue(seq)`

Return *True* if all elements of *seq* evaluate to *True*. If *seq* is empty, return *False*.

`matplotlib.cbook.boxplot_stats(X, whis=1.5, bootstrap=None, labels=None, autorange=False)`

Returns list of dictionaries of statistics used to draw a series of box and whisker plots. The Returns section enumerates the required keys of the dictionary. Users can skip this function and pass a user-defined set of dictionaries to the new `axes.bxp` method instead of relying on MPL to do the calculations.

Parameters X : array-like

Data that will be represented in the boxplots. Should have 2 or fewer dimensions.

whis : float, string, or sequence (default = 1.5)

As a float, determines the reach of the whiskers to the beyond the first and third quartiles. In other words, where IQR is the interquartile range (Q3-Q1), the upper whisker will extend to last datum less than $Q3 + whis * IQR$. Similarly, the lower whisker will extend to the first datum greater than $Q1 - whis * IQR$. Beyond the whiskers, data are considered outliers and are plotted as individual points. This can be set this to an ascending sequence of percentile (e.g., [5, 95]) to set the whiskers at specific percentiles of the data. Finally, *whis* can be the string 'range' to force the whiskers to the minimum and maximum of the data. In the edge case that the 25th and 75th percentiles are equivalent, *whis* can be automatically set to 'range' via the `autorange` option.

bootstrap : int, optional

Number of times the confidence intervals around the median should be bootstrapped (percentile method).

labels : array-like, optional

Labels for each dataset. Length must be compatible with dimensions of *X*.

autorange : bool, optional (False)

When *True* and the data are distributed such that the 25th and 75th percentiles are equal, *whis* is set to 'range' such that the whisker ends are at the minimum and maximum of the data.

Returns `bxpstats` : list of dict

A list of dictionaries containing the results for each column of data. Keys of each dictionary are the following:

Key	Value Description
label	tick label for the boxplot
mean	arithmetic mean value
med	50th percentile
q1	first quartile (25th percentile)
q3	third quartile (75th percentile)
cilo	lower notch around the median
cihi	upper notch around the median
whislo	end of the lower whisker
whishi	end of the upper whisker
fliers	outliers

Notes

Non-bootstrapping approach to confidence interval uses Gaussian- based asymptotic approximation:

$$\text{med} \pm 1.57 \times \frac{\text{iqr}}{\sqrt{N}} \quad (22.1)$$

General approach from: McGill, R., Tukey, J.W., and Larsen, W.A. (1978) "Variations of Boxplots", The American Statistician, 32:12-16.

class `matplotlib.cbook.converter`(*missing='Null', missingval=None*)

Bases: `object`

Base class for handling string -> python type with support for missing values

is_missing(*s*)

`matplotlib.cbook.dedent`(*s*)

Remove excess indentation from docstring *s*.

Discards any leading blank lines, then removes up to *n* whitespace characters from each line, where *n* is the number of leading whitespace characters in the first line. It differs from `textwrap.dedent` in its deletion of leading blank lines and its use of the first non-blank line to determine the indentation.

It is also faster in most cases.

matplotlib.cbook.delete_masked_points(**args*)

Find all masked and/or non-finite points in a set of arguments, and return the arguments with only the unmasked points remaining.

Arguments can be in any of 5 categories:

1.1-D masked arrays

2.1-D ndarrays

3.ndarrays with more than one dimension

4.other non-string iterables

5.anything else

The first argument must be in one of the first four categories; any argument with a length differing from that of the first argument (and hence anything in category 5) then will be passed through unchanged.

Masks are obtained from all arguments of the correct length in categories 1, 2, and 4; a point is bad if masked in a masked array or if it is a nan or inf. No attempt is made to extract a mask from categories 2, 3, and 4 if `np.isfinite()` does not yield a Boolean array.

All input arguments that are not passed unchanged are returned as ndarrays after removing the points or rows corresponding to masks in any of the arguments.

A vastly simpler version of this function was originally written as a helper for `Axes.scatter()`.

`matplotlib.cbook.deprecated`(*since*, *message*='', *name*='', *alternative*='', *pending*=False, *obj_type*='function')

Decorator to mark a function as deprecated.

Parameters *since* : str

The release at which this API became deprecated. This is required.

message : str, optional

Override the default deprecation message. The format specifier `%(func)s` may be used for the name of the function, and `%(alternative)s` may be used in the deprecation message to insert the name of an alternative to the deprecated function. `%(obj_type)` may be used to insert a friendly name for the type of object being deprecated.

name : str, optional

The name of the deprecated function; if not provided the name is automatically determined from the passed in function, though this is useful in the case of renamed functions, where the new function is just assigned to the name of the deprecated function. For example:

```
def new_function():
    ...
oldFunction = new_function
```

alternative : str, optional

An alternative function that the user may use in place of the deprecated function. The deprecation warning will tell the user about this alternative if provided.

pending : bool, optional

If True, uses a `PendingDeprecationWarning` instead of a `DeprecationWarning`.

Examples

Basic example:

```
@deprecated('1.4.0')
def the_function_to_deprecate():
    pass
```

`matplotlib.cbook.dict_delall(d, keys)`
delete all of the *keys* from the dict *d*

`matplotlib.cbook.exception_to_str(s=None)`

`matplotlib.cbook.file_requires_unicode(x)`
Returns True if the given writable file-like object requires Unicode to be written to it.

`matplotlib.cbook.finddir(o, match, case=False)`
return all attributes of *o* which match string in *match*. if *case* is True require an exact case match.

`matplotlib.cbook.flatten(seq, scalarp=<function is_scalar_or_string>)`
Returns a generator of flattened nested containers

For example:

```
>>> from matplotlib.cbook import flatten
>>> l = (('John', ['Hunter']), (1, 23), [[([42, (5, 23)], )]])
>>> print(list(flatten(l)))
['John', 'Hunter', 1, 23, 42, 5, 23]
```

By: Composite of Holger Krekel and Luther Blissett From: <https://code.activestate.com/recipes/121294/> and Recipe 1.12 in cookbook

`matplotlib.cbook.get_label(y, default_name)`

`matplotlib.cbook.get_recursive_filelist(args)`
Recurse all the files and dirs in *args* ignoring symbolic links and return the files as a list of strings

`matplotlib.cbook.get_sample_data(fname, asfileobj=True)`
Return a sample data file. *fname* is a path relative to the `mpl-data/sample_data` directory. If *asfileobj* is True return a file object, otherwise just a file path.

Set the `rc` parameter `examples.directory` to the directory where we should look, if `sample_data` files are stored in a location different than default (which is `'mpl-data/sample_data'` at the same level of `'matplotlib'` Python module files).

If the filename ends in `.gz`, the file is implicitly unzipped.

`matplotlib.cbook.get_split_ind(seq, N)`
seq is a list of words. Return the index into *seq* such that:

```
len(' '.join(seq[:ind]))<=N
```

`matplotlib.cbook.index_of(y)`

A helper function to get the index of an input to plot against if x values are not explicitly given.

Tries to get `y.index` (works if this is a `pd.Series`), if that fails, return `np.arange(y.shape[0])`.

This will be extended in the future to deal with more types of labeled data.

Parameters `y` : scalar or array-like

The proposed y-value

Returns `x, y` : ndarray

The x and y values to plot.

`matplotlib.cbook.is_hashable(obj)`

Returns true if `obj` can be hashed

`matplotlib.cbook.is_math_text(s)`

`matplotlib.cbook.is_numlike(obj)`

return true if `obj` looks like a number

`matplotlib.cbook.is_scalar(obj)`

return true if `obj` is not string like and is not iterable

`matplotlib.cbook.is_scalar_or_string(val)`

Return whether the given object is a scalar or string like.

`matplotlib.cbook.is_sequence_of_strings(obj)`

Returns true if `obj` is iterable and contains strings

`matplotlib.cbook.is_string_like(obj)`

Return True if `obj` looks like a string

`matplotlib.cbook.is_writable_file_like(obj)`

return true if `obj` looks like a file object with a `write` method

`matplotlib.cbook.issubclass_safe(x, klass)`

return `issubclass(x, klass)` and return False on a `TypeError`

`matplotlib.cbook.iterable(obj)`

return true if `obj` is iterable

`matplotlib.cbook.listFiles(root, patterns='*', recurse=1, return_folders=0)`

Recursively list files

from Parmar and Martelli in the Python Cookbook

`matplotlib.cbook.local_over_kwdict(local_var, kwargs, *keys)`

Enforces the priority of a local variable over potentially conflicting argument(s) from a kwargs dict.

The following possible output values are considered in order of priority:

`local_var > kwargs[keys[0]] > ... > kwargs[keys[-1]]`

The first of these whose value is not None will be returned. If all are None then None will be returned. Each key in keys will be removed from the kwargs dict in place.

Parameters local_var: any object

The local variable (highest priority)

kwargs: dict Dictionary of keyword arguments; modified in place

keys: str(s) Name(s) of keyword arguments to process, in descending order of priority

Returns out: any object

Either local_var or one of kwargs[key] for key in keys

Raises IgnoredKeywordWarning

For each key in keys that is removed from kwargs but not used as the output value

class matplotlib.cbook.maxdict(maxsize)

Bases: dict

A dictionary with a maximum size; this doesn't override all the relevant methods to constrain the size, just setitem, so use with caution

matplotlib.cbook.mkdirs(newdir, mode=511)

make directory *newdir* recursively, and set *mode*. Equivalent to

```
> mkdir -p NEWDIR
> chmod MODE NEWDIR
```

matplotlib.cbook.mplDeprecation

alias of [MatplotlibDeprecationWarning](#)

matplotlib.cbook.normalize_kwargs(kw, alias_mapping=None, required=(), forbidden=(), allowed=None)

Helper function to normalize kwarg inputs

The order they are resolved are:

- 1.aliasing
- 2.required
- 3.forbidden
- 4.allowed

This order means that only the canonical names need appear in allowed, forbidden, required

Parameters alias_mapping, dict, optional

A mapping between a canonical name to a list of aliases, in order of precedence from lowest to highest.

If the canonical value is not in the list it is assumed to have the highest priority.

required : iterable, optional

A tuple of fields that must be in kwargs.

forbidden : iterable, optional

A list of keys which may not be in kwargs

allowed : tuple, optional

A tuple of allowed fields. If this not None, then raise if kw contains any keys not in the union of required and allowed. To allow only the required fields pass in () for allowed

Raises TypeError

To match what python raises if invalid args/kwargs are passed to a callable.

`matplotlib.cbook.onetrue(seq)`

Return *True* if one element of *seq* is *True*. If *seq* is empty, return *False*.

`matplotlib.cbook.pieces(seq, num=2)`

Break up the *seq* into *num* tuples

`matplotlib.cbook.popall(seq)`

empty a list

`matplotlib.cbook.print_cycles(objects, outstream=<_io.TextIOWrapper name='<stdout>' mode='w' encoding='UTF-8'>, show_progress=False)`

objects A list of objects to find cycles in. It is often useful to pass in `gc.garbage` to find the cycles that are preventing some objects from being garbage collected.

outstream The stream for output.

show_progress If True, print the number of objects reached as they are found.

`matplotlib.cbook.pts_to_midstep(x, *args)`

Covert continuous line to pre-steps

Given a set of N points convert to 2 N -1 points which when connected linearly give a step function which changes values at the begining the intervals.

Parameters x : array

The x location of the steps

y1, y2, ... : array

Any number of y arrays to be turned into steps. All must be the same length as x

Returns x, y1, y2, .. : array

The x and y values converted to steps in the same order as the input. If the input is length N, each of these arrays will be length 2N + 1

Examples

```
>> x_s, y1_s, y2_s = pts_to_prestep(x, y1, y2)
```

```
matplotlib.cbook.pts_to_poststep(x, *args)
```

Covert continuous line to pre-steps

Given a set of N points convert to $2N - 1$ points which when connected linearly give a step function which changes values at the beginning the intervals.

Parameters x : array

The x location of the steps

$y1, y2, \dots$: array

Any number of y arrays to be turned into steps. All must be the same length as x

Returns $x, y1, y2, ..$: array

The x and y values converted to steps in the same order as the input. If the input is length N , each of these arrays will be length $2N + 1$

Examples

```
>> x_s, y1_s, y2_s = pts_to_prestep(x, y1, y2)
```

```
matplotlib.cbook.pts_to_prestep(x, *args)
```

Covert continuous line to pre-steps

Given a set of N points convert to $2N - 1$ points which when connected linearly give a step function which changes values at the beginning the intervals.

Parameters x : array

The x location of the steps

$y1, y2, \dots$: array

Any number of y arrays to be turned into steps. All must be the same length as x

Returns $x, y1, y2, ..$: array

The x and y values converted to steps in the same order as the input. If the input is length N , each of these arrays will be length $2N + 1$

Examples

```
>> x_s, y1_s, y2_s = pts_to_prestep(x, y1, y2)
```

```
matplotlib.cbook.recursive_remove(path)
```

`matplotlib.cbook.report_memory(i=0)`

return the memory consumed by process

`matplotlib.cbook.restrict_dict(d, keys)`

Return a dictionary that contains those keys that appear in both `d` and `keys`, with values from `d`.

`matplotlib.cbook.reverse_dict(d)`

reverse the dictionary – may lose data if values are not unique!

`matplotlib.cbook.safe_first_element(obj)`

`matplotlib.cbook.safe_masked_invalid(x, copy=False)`

`matplotlib.cbook.safezip(*args)`

make sure `args` are equal len before zipping

`class matplotlib.cbook.silent_list(type, seq=None)`

Bases: `list`

override `repr` when returning a list of matplotlib artists to prevent long, meaningless output. This is meant to be used for a homogeneous list of a given type

`matplotlib.cbook.simple_linear_interpolation(a, steps)`

`matplotlib.cbook.soundex(name, len=4)`

soundex module conforming to Odell-Russell algorithm

`matplotlib.cbook.strip_math(s)`

remove latex formatting from mathtext

`matplotlib.cbook.to_filehandle(fname, flag='rU', return_opened=False)`

`fname` can be a filename or a file handle. Support for gzipped files is automatic, if the filename ends in `.gz`. `flag` is a read/write flag for `file()`

`class matplotlib.cbook.todate(fmt='%Y-%m-%d', missing='Null', missingval=None)`

Bases: `matplotlib.cbook.converter`

convert to a date or None

use a `time.strptime()` format string for conversion

`class matplotlib.cbook.todatetime(fmt='%Y-%m-%d', missing='Null', missingval=None)`

Bases: `matplotlib.cbook.converter`

convert to a datetime or None

use a `time.strptime()` format string for conversion

`class matplotlib.cbook.tofloat(missing='Null', missingval=None)`

Bases: `matplotlib.cbook.converter`

convert to a float or None

`class matplotlib.cbook.toint(missing='Null', missingval=None)`

Bases: `matplotlib.cbook.converter`

convert to an int or None

class `matplotlib.cbook.tostr`(*missing='Null', missingval=''*)

Bases: `matplotlib.cbook.converter`

convert to string or None

`matplotlib.cbook.unicode_safe`(*s*)

`matplotlib.cbook.unique`(*x*)

Return a list of unique elements of *x*

`matplotlib.cbook.unmasked_index_ranges`(*mask, compressed=True*)

Find index ranges where *mask* is *False*.

mask will be flattened if it is not already 1-D.

Returns Nx2 `numpy.ndarray` with each row the start and stop indices for slices of the compressed `numpy.ndarray` corresponding to each of *N* uninterrupted runs of unmasked values. If optional argument *compressed* is *False*, it returns the start and stop indices into the original `numpy.ndarray`, not the compressed `numpy.ndarray`. Returns *None* if there are no unmasked values.

Example:

```
y = ma.array(np.arange(5), mask = [0,0,1,0,0])
ii = unmasked_index_ranges(ma.getmaskarray(y))
# returns array [[0,2,] [2,4,]]

y.compressed()[ii[1,0]:ii[1,1]]
# returns array [3,4,]

ii = unmasked_index_ranges(ma.getmaskarray(y), compressed=False)
# returns array [[0, 2], [3, 5]]

y.filled()[ii[1,0]:ii[1,1]]
# returns array [3,4,]
```

Prior to the transforms refactoring, this was used to support masked arrays in Line2D.

`matplotlib.cbook.violin_stats`(*X, method, points=100*)

Returns a list of dictionaries of data which can be used to draw a series of violin plots. See the Returns section below to view the required keys of the dictionary. Users can skip this function and pass a user-defined set of dictionaries to the `axes.vplot` method instead of using MPL to do the calculations.

Parameters X : array-like

Sample data that will be used to produce the gaussian kernel density estimates. Must have 2 or fewer dimensions.

method : callable

The method used to calculate the kernel density estimate for each column of data. When called via `method(v, coords)`, it should return a vector of the values of the KDE evaluated at the values specified in `coords`.

points : scalar, default = 100

Defines the number of points to evaluate each of the gaussian kernel density estimates at.

Returns A list of dictionaries containing the results for each column of data.

The dictionaries contain at least the following:

- **coords**: A list of scalars containing the coordinates this particular kernel density estimate was evaluated at.
- **vals**: A list of scalars containing the values of the kernel density estimate at each of the coordinates given in **coords**.
- **mean**: The mean value for this column of data.
- **median**: The median value for this column of data.
- **min**: The minimum value for this column of data.
- **max**: The maximum value for this column of data.

`matplotlib.cbook.warn_deprecated`(*since*, *message*='', *name*='', *alternative*='', *pending*=False, *obj_type*='attribute')

Used to display deprecation warning in a standard way.

Parameters **since** : str

The release at which this API became deprecated.

message : str, optional

Override the default deprecation message. The format specifier `%(func)s` may be used for the name of the function, and `%(alternative)s` may be used in the deprecation message to insert the name of an alternative to the deprecated function. `%(obj_type)` may be used to insert a friendly name for the type of object being deprecated.

name : str, optional

The name of the deprecated function; if not provided the name is automatically determined from the passed in function, though this is useful in the case of renamed functions, where the new function is just assigned to the name of the deprecated function. For example:

```
def new_function():
    ...
oldFunction = new_function
```

alternative : str, optional

An alternative function that the user may use in place of the deprecated function. The deprecation warning will tell the user about this alternative if provided.

pending : bool, optional

If True, uses a PendingDeprecationWarning instead of a DeprecationWarning.

obj_type : str, optional

The object type being deprecated.

Examples

Basic example:

```
# To warn of the deprecation of "matplotlib.name_of_module"
warn_deprecated('1.4.0', name='matplotlib.name_of_module',
                obj_type='module')
```

`matplotlib.cbook.wrap(prefix, text, cols)`
wrap *text* with *prefix* at length *cols*

CM (COLORMAP)

23.1 matplotlib.cm

This module provides a large set of colormaps, functions for registering new colormaps and for getting a colormap by name, and a mixin class for adding color mapping functionality.

class `matplotlib.cm.ScalarMappable`(*norm=None, cmap=None*)

Bases: `object`

This is a mixin class to support scalar data to RGBA mapping. The `ScalarMappable` makes use of data normalization before returning RGBA colors from the given colormap.

Parameters *norm* : `matplotlib.colors.Normalize` instance

The normalizing object which scales data, typically into the interval `[0, 1]`.
If *None*, *norm* defaults to a `colors.Normalize` object which initializes its scaling based on the first data processed.

cmap : str or `Colormap` instance

The colormap used to map normalized data values to RGBA colors.

add_checker(*checker*)

Add an entry to a dictionary of boolean flags that are set to True when the mappable is changed.

autoscale()

Autoscale the scalar limits on the *norm* instance using the current array

autoscale_None()

Autoscale the scalar limits on the *norm* instance using the current array, changing only limits that are None

changed()

Call this whenever the mappable is changed to notify all the callbackSM listeners to the 'changed' signal

check_update(*checker*)

If mappable has changed since the last check, return True; else return False

cmap = None

The `Colormap` instance of this `ScalarMappable`.

colorbar = None

The last colorbar associated with this ScalarMappable. May be None.

get_array()

Return the array

get_clim()

return the min, max of the color limits for image scaling

get_cmap()

return the colormap

norm = None

The Normalization instance of this ScalarMappable.

set_array(A)

Set the image array from numpy array *A*

set_clim(vmin=None, vmax=None)

set the norm limits for image scaling; if *vmin* is a length2 sequence, interpret it as (*vmin*, *vmax*) which is used to support setp

ACCEPTS: a length 2 sequence of floats

set_cmap(cmap)

set the colormap for luminance data

ACCEPTS: a colormap or registered colormap name

set_norm(norm)

set the normalization instance

to_rgba(x, alpha=None, bytes=False, norm=True)

Return a normalized rgba array corresponding to *x*.

In the normal case, *x* is a 1-D or 2-D sequence of scalars, and the corresponding ndarray of rgba values will be returned, based on the norm and colormap set for this ScalarMappable.

There is one special case, for handling images that are already rgb or rgba, such as might have been read from an image file. If *x* is an ndarray with 3 dimensions, and the last dimension is either 3 or 4, then it will be treated as an rgb or rgba array, and no mapping will be done. If the last dimension is 3, the *alpha* kwarg (defaulting to 1) will be used to fill in the transparency. If the last dimension is 4, the *alpha* kwarg is ignored; it does not replace the pre-existing alpha. A `ValueError` will be raised if the third dimension is other than 3 or 4.

In either case, if *bytes* is *False* (default), the rgba array will be floats in the 0-1 range; if it is *True*, the returned rgba array will be uint8 in the 0 to 255 range.

If *norm* is *False*, no normalization of the input data is performed, and it is assumed to already be in the range (0-1).

Note: this method assumes the input is well-behaved; it does not check for anomalies such as *x* being a masked rgba array, or being an integer type other than uint8, or being a floating point rgba array with values outside the 0-1 range.

`matplotlib.cm.get_cmap(name=None, lut=None)`

Get a colormap instance, defaulting to rc values if *name* is None.

Colormaps added with `register_cmap()` take precedence over built-in colormaps.

If *name* is a `matplotlib.colors.Colormap` instance, it will be returned.

If *lut* is not None it must be an integer giving the number of entries desired in the lookup table, and *name* must be a standard mpl colormap name.

`matplotlib.cm.register_cmap(name=None, cmap=None, data=None, lut=None)`

Add a colormap to the set recognized by `get_cmap()`.

It can be used in two ways:

```
register_cmap(name='swirly', cmap=swirly_cmap)
register_cmap(name='choppy', data=choppydata, lut=128)
```

In the first case, *cmap* must be a `matplotlib.colors.Colormap` instance. The *name* is optional; if absent, the name will be the name attribute of the *cmap*.

In the second case, the three arguments are passed to the `LinearSegmentedColormap` initializer, and the resulting colormap is registered.

`matplotlib.cm.revcmmap(data)`

Can only handle specification *data* in dictionary format.

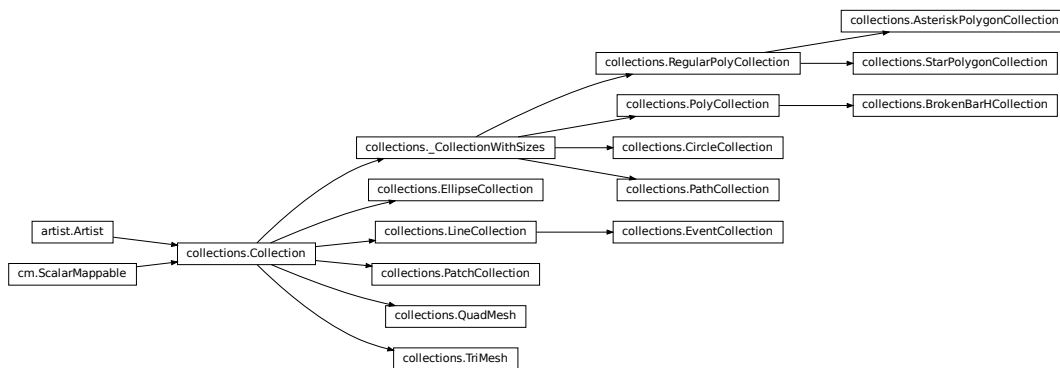

24.1 matplotlib.collections

Classes for the efficient drawing of large collections of objects that share most properties, e.g., a large number of line segments or polygons.

The classes are not meant to be as flexible as their single element counterparts (e.g., you may not be able to select all line styles) but they are meant to be fast for common use cases (e.g., a large set of solid line segments)

```
class matplotlib.collections.AsteriskPolygonCollection(numsides, rotation=0,  
                                                    sizes=(1, ), **kwargs)
```

Bases: `matplotlib.collections.RegularPolyCollection`

Draw a collection of regular asterisks with *numsides* points.

numsides the number of sides of the polygon

rotation the rotation of the polygon in radians

sizes gives the area of the circle circumscribing the regular polygon in points²

Valid Collection keyword arguments:

- edgecolors*: None
- facecolors*: None
- linewidths*: None
- antialiaseds*: None
- offsets*: None
- transOffset*: `transforms.IdentityTransform()`
- norm*: None (optional for `matplotlib.cm.ScalarMappable`)
- cmap*: None (optional for `matplotlib.cm.ScalarMappable`)

offsets and *transOffset* are used to translate the patch after rendering (default no offsets)

If any of *edgecolors*, *facecolors*, *linewidths*, *antialiaseds* are None, they default to their `matplotlib.rcParams` patch setting, in sequence form.

Example: see `examples/dynamic_collection.py` for complete example:

```
offsets = np.random.rand(20,2)
facecolors = [cm.jet(x) for x in np.random.rand(20)]
black = (0,0,0,1)

collection = RegularPolyCollection(
    numsides=5, # a pentagon
    rotation=0, sizes=(50,),
    facecolors = facecolors,
    edgecolors = (black,),
    linewidths = (1,),
    offsets = offsets,
    transOffset = ax.transData,
)
```

add_callback(*func*)

Adds a callback function that will be called whenever one of the `Artist`'s properties changes.

Returns an *id* that is useful for removing the callback with `remove_callback()` later.

add_checker(*checker*)

Add an entry to a dictionary of boolean flags that are set to True when the mappable is changed.

aname = 'Artist'

autoscale()

Autoscale the scalar limits on the norm instance using the current array

autoscale_None()

Autoscale the scalar limits on the norm instance using the current array, changing only limits that are None

axes

The `Axes` instance the artist resides in, or `None`.

changed()

Call this whenever the mappable is changed to notify all the callbackSM listeners to the 'changed' signal

check_update(*checker*)

If mappable has changed since the last check, return True; else return False

contains(*mouseevent*)

Test whether the mouse event occurred in the collection.

Returns True | False, dict(ind=itemlist), where every item in itemlist contains the event.

convert_xunits(*x*)

For artists in an axes, if the xaxis has units support, convert *x* using xaxis unit type

convert_yunits(*y*)

For artists in an axes, if the yaxis has units support, convert *y* using yaxis unit type

draw(*artist*, *renderer*, **args*, ***kwargs*)**findobj**(*match=None*, *include_self=True*)

Find artist objects.

Recursively find all *Artist* instances contained in self.

match can be

- None: return all objects contained in artist.
- function with signature `boolean = match(artist)` used to filter matches
- class instance: e.g., `Line2D`. Only return artists of class type.

If *include_self* is True (default), include self in the list to be checked for a match.

format_cursor_data(*data*)

Return *cursor data* string formatted.

get_agg_filter()

return filter function to be used for agg filter

get_alpha()

Return the alpha value used for blending - not supported on all backends

get_animated()

Return the artist's animated state

get_array()

Return the array

get_axes()

Return the *Axes* instance the artist resides in, or *None*.

This has been deprecated in mpl 1.5, please use the axes property. Will be removed in 1.7 or 2.0.

get_children()

Return a list of the child Artist`s `this :class:`Artist` contains.

get_clim()
return the min, max of the color limits for image scaling

get_clip_box()
Return artist clipbox

get_clip_on()
Return whether artist uses clipping

get_clip_path()
Return artist clip path

get_cmap()
return the colormap

get_contains()
Return the `_contains` test used by the artist, or *None* for default.

get_cursor_data(event)
Get the cursor data for a given event.

get_dashes()

get_datalim(transData)

get_edgecolor()

get_edgecolors()

get_facecolor()

get_facecolors()

get_figure()
Return the *Figure* instance the artist belongs to.

get_fill()
return whether fill is set

get_gid()
Returns the group id

get_hatch()
Return the current hatching pattern

get_label()
Get the label used for this artist in the legend.

get_linestyle()

`get_linestyles()`

`get_linewidth()`

`get_linewidths()`

`get_numsides()`

`get_offset_position()`

Returns how offsets are applied for the collection. If *offset_position* is 'screen', the offset is applied after the master transform has been applied, that is, the offsets are in screen coordinates. If *offset_position* is 'data', the offset is applied before the master transform, i.e., the offsets are in data coordinates.

`get_offset_transform()`

`get_offsets()`

Return the offsets for the collection.

`get_path_effects()`

`get_paths()`

`get_picker()`

Return the picker object used by this artist

`get_pickradius()`

`get_rasterized()`

return True if the artist is to be rasterized

`get_rotation()`

`get_sizes()`

Returns the sizes of the elements in the collection. The value represents the 'area' of the element.

Returns sizes : array

The 'area' of each element.

`get_sketch_params()`

Returns the sketch parameters for the artist.

Returns sketch_params : tuple or None

A 3-tuple with the following elements:

- scale: The amplitude of the wiggle perpendicular to the source line.

- length: The length of the wiggle along the line.
- randomness: The scale factor by which the length is shrunken or expanded.

May return `None` if no sketch parameters were set.

get_snap()

Returns the snap setting which may be:

- True: snap vertices to the nearest pixel center
- False: leave vertices as-is
- None: (auto) If the path contains only rectilinear line segments, round to the nearest pixel center

Only supported by the Agg and MacOSX backends.

get_transform()

Return the *Transform* instance used by this artist.

get_transformed_clip_path_and_affine()

Return the clip path with the non-affine part of its transformation applied, and the remaining affine part of its transformation.

get_transforms()

get_url()

Returns the url

get_urls()

get_visible()

Return the artist's visibility

get_window_extent(renderer)

get_zorder()

Return the Artist's zorder.

have_units()

Return *True* if units are set on the *x* or *y* axes

hitlist(event)

List the children of the artist which contain the mouse event *event*.

is_figure_set()

Returns *True* if the artist is assigned to a *Figure*.

is_transform_set()

Returns *True* if Artist has a transform explicitly set.

mouseover

pchanged()

Fire an event when property changed, calling all of the registered callbacks.

pick(*mouseevent*)

Process pick event

each child artist will fire a pick event if *mouseevent* is over the artist and the artist has picker set

pickable()

Return *True* if *Artist* is pickable.

properties()

return a dictionary mapping property name -> value for all *Artist* props

remove()

Remove the artist from the figure if possible. The effect will not be visible until the figure is redrawn, e.g., with `matplotlib.axes.Axes.draw_idle()`. Call `matplotlib.axes.Axes.relim()` to update the axes limits if desired.

Note: `relim()` will not see collections even if the collection was added to axes with `autolim = True`.

Note: there is no support for removing the artist's legend entry.

remove_callback(*oid*)

Remove a callback based on its *id*.

See also:

[`add_callback\(\)`](#) For adding callbacks

set(*kwargs*)**

A property batch setter. Pass *kwargs* to set properties.

set_agg_filter(*filter_func*)

set `agg_filter` fuction.

set_alpha(*alpha*)

Set the alpha transparencies of the collection. *alpha* must be a float or *None*.

ACCEPTS: float or None

set_animated(*b*)

Set the artist's animation state.

ACCEPTS: [True | False]

set_antialiased(*aa*)

Set the antialiasing state for rendering.

ACCEPTS: Boolean or sequence of booleans

set_antialiaseds(*aa*)

alias for `set_antialiased`

set_array(*A*)

Set the image array from numpy array *A*

set_axes(*axes*)

Set the *Axes* instance in which the artist resides, if any.

This has been deprecated in mpl 1.5, please use the axes property. Will be removed in 1.7 or 2.0.

ACCEPTS: an *Axes* instance

set_clim(*vmin=None, vmax=None*)

set the norm limits for image scaling; if *vmin* is a length2 sequence, interpret it as (*vmin*, *vmax*) which is used to support setp

ACCEPTS: a length 2 sequence of floats

set_clip_box(*clipbox*)

Set the artist's clip *Bbox*.

ACCEPTS: a *matplotlib.transforms.Bbox* instance

set_clip_on(*b*)

Set whether artist uses clipping.

When False artists will be visible out side of the axes which can lead to unexpected results.

ACCEPTS: [True | False]

set_clip_path(*path, transform=None*)

Set the artist's clip path, which may be:

- a *Patch* (or subclass) instance
- a *Path* instance, in which case an optional *Transform* instance may be provided, which will be applied to the path before using it for clipping.
- *None*, to remove the clipping path

For efficiency, if the path happens to be an axis-aligned rectangle, this method will set the clipping box to the corresponding rectangle and set the clipping path to *None*.

ACCEPTS: [(*Path, Transform*) | *Patch* | None]

set_cmap(*cmap*)

set the colormap for luminance data

ACCEPTS: a colormap or registered colormap name

set_color(*c*)

Set both the edgecolor and the facecolor.

ACCEPTS: matplotlib color arg or sequence of rgba tuples

See also:

[*set_facecolor\(\)*](#), [*set_edgecolor\(\)*](#) For setting the edge or face color individually.

set_contains(*picker*)

Replace the contains test used by this artist. The new picker should be a callable function which determines whether the artist is hit by the mouse event:

```
hit, props = picker(artist, mouseevent)
```

If the mouse event is over the artist, return *hit = True* and *props* is a dictionary of properties you want returned with the contains test.

ACCEPTS: a callable function

set_dashes(*ls*)

alias for `set_linestyle`

set_edgecolor(*c*)

Set the edgecolor(s) of the collection. *c* can be a matplotlib color spec (all patches have same color), or a sequence of specs; if it is a sequence the patches will cycle through the sequence.

If *c* is 'face', the edge color will always be the same as the face color. If it is 'none', the patch boundary will not be drawn.

ACCEPTS: matplotlib color spec or sequence of specs

set_edgecolors(*c*)

alias for `set_edgecolor`

set_facecolor(*c*)

Set the facecolor(s) of the collection. *c* can be a matplotlib color spec (all patches have same color), or a sequence of specs; if it is a sequence the patches will cycle through the sequence.

If *c* is 'none', the patch will not be filled.

ACCEPTS: matplotlib color spec or sequence of specs

set_facecolors(*c*)

alias for `set_facecolor`

set_figure(*fig*)

Set the *Figure* instance the artist belongs to.

ACCEPTS: a `matplotlib.figure.Figure` instance

set_gid(*gid*)

Sets the (group) id for the artist

ACCEPTS: an id string

set_hatch(*hatch*)

Set the hatching pattern

hatch can be one of:

```
/ - diagonal hatching
\ - back diagonal
| - vertical
- - horizontal
+ - crossed
x - crossed diagonal
o - small circle
O - large circle
```

```
. - dots
* - stars
```

Letters can be combined, in which case all the specified hatchings are done. If same letter repeats, it increases the density of hatching of that pattern.

Hatching is supported in the PostScript, PDF, SVG and Agg backends only.

Unlike other properties such as linewidth and colors, hatching can only be specified for the collection as a whole, not separately for each member.

ACCEPTS: ['/' | '\' | '|' | '-' | '+' | 'x' | 'o' | 'O' | ':' | '*']

set_label(*s*)

Set the label to *s* for auto legend.

ACCEPTS: string or anything printable with '%s' conversion.

set_linestyle(*ls*)

Set the linestyle(s) for the collection.

linestyle	description
'-' or 'solid'	solid line
'--' or 'dashed'	dashed line
'-.' or 'dashdot'	dash-dotted line
':' or 'dotted'	dotted line

Alternatively a dash tuple of the following form can be provided:

```
(offset, onoffseq),
```

where *onoffseq* is an even length tuple of on and off ink in points.

ACCEPTS: ['solid' | 'dashed', 'dashdot', 'dotted' | (offset, on-off-dash-seq) | '-' | '--' | '-.' | ':' | 'None' | ' ' | '']

Parameters *ls* : { '-', '-.', '-.', ':' } and more see description

The line style.

set_linestyles(*ls*)

alias for set_linestyle

set_linewidth(*lw*)

Set the linewidth(s) for the collection. *lw* can be a scalar or a sequence; if it is a sequence the patches will cycle through the sequence

ACCEPTS: float or sequence of floats

set_linewidths(*lw*)

alias for set_linewidth

set_lw(*lw*)

alias for set_linewidth

set_norm(*norm*)

set the normalization instance

set_offset_position(*offset_position*)

Set how offsets are applied. If *offset_position* is 'screen' (default) the offset is applied after the master transform has been applied, that is, the offsets are in screen coordinates. If *offset_position* is 'data', the offset is applied before the master transform, i.e., the offsets are in data coordinates.

set_offsets(*offsets*)

Set the offsets for the collection. *offsets* can be a scalar or a sequence.

ACCEPTS: float or sequence of floats

set_path_effects(*path_effects*)

set *path_effects*, which should be a list of instances of `matplotlib.patheffect._Base` class or its derivatives.

set_paths()**set_picker**(*picker*)

Set the epsilon for picking used by this artist

picker can be one of the following:

- *None*: picking is disabled for this artist (default)
- A boolean: if *True* then picking will be enabled and the artist will fire a pick event if the mouse event is over the artist
- A float: if *picker* is a number it is interpreted as an epsilon tolerance in points and the artist will fire off an event if it's data is within epsilon of the mouse event. For some artists like lines and patch collections, the artist may provide additional data to the pick event that is generated, e.g., the indices of the data within epsilon of the pick event
- A function: if *picker* is callable, it is a user supplied function which determines whether the artist is hit by the mouse event:

```
hit, props = picker(artist, mouseevent)
```

to determine the hit test. if the mouse event is over the artist, return *hit=True* and *props* is a dictionary of properties you want added to the `PickEvent` attributes.

ACCEPTS: [None|float|boolean|callable]

set_pickradius(*pr*)**set_rasterized**(*rasterized*)

Force rasterized (bitmap) drawing in vector backend output.

Defaults to *None*, which implies the backend's default behavior

ACCEPTS: [True | False | None]

set_sizes(*sizes*, *dpi*=72.0)

Set the sizes of each member of the collection.

Parameters *sizes* : ndarray or None

The size to set for each element of the collection. The value is the ‘area’ of the element.

dpi : float

The dpi of the canvas. Defaults to 72.0.

set_sketch_params(*scale*=None, *length*=None, *randomness*=None)

Sets the sketch parameters.

Parameters *scale* : float, optional

The amplitude of the wiggle perpendicular to the source line, in pixels. If *scale* is None, or not provided, no sketch filter will be provided.

length : float, optional

The length of the wiggle along the line, in pixels (default 128.0)

randomness : float, optional

The scale factor by which the length is shrunken or expanded (default 16.0)

set_snap(*snap*)

Sets the snap setting which may be:

- True: snap vertices to the nearest pixel center
- False: leave vertices as-is
- None: (auto) If the path contains only rectilinear line segments, round to the nearest pixel center

Only supported by the Agg and MacOSX backends.

set_transform(*t*)

Set the *Transform* instance used by this artist.

ACCEPTS: *Transform* instance

set_url(*url*)

Sets the url for the artist

ACCEPTS: a url string

set_urls(*urls*)

set_visible(*b*)

Set the artist’s visibility.

ACCEPTS: [True | False]

set_zorder(*level*)

Set the zorder for the artist. Artists with lower zorder values are drawn first.

ACCEPTS: any number

stale

If the artist is ‘stale’ and needs to be re-drawn for the output to match the internal state of the artist.

sticky_edges

x and y sticky edge lists.

When performing autoscaling, if a data limit coincides with a value in the corresponding sticky_edges list, then no margin will be added—the view limit “sticks” to the edge. A typical usecase is histograms, where one usually expects no margin on the bottom edge (0) of the histogram.

This attribute cannot be assigned to; however, the x and y lists can be modified in place as needed.

Examples

```
>>> artist.sticky_edges.x[:] = (xmin, xmax)
>>> artist.sticky_edges.y[:] = (ymin, ymax)
```

to_rgba(*x*, *alpha=None*, *bytes=False*, *norm=True*)

Return a normalized rgba array corresponding to *x*.

In the normal case, *x* is a 1-D or 2-D sequence of scalars, and the corresponding ndarray of rgba values will be returned, based on the norm and colormap set for this ScalarMappable.

There is one special case, for handling images that are already rgb or rgba, such as might have been read from an image file. If *x* is an ndarray with 3 dimensions, and the last dimension is either 3 or 4, then it will be treated as an rgb or rgba array, and no mapping will be done. If the last dimension is 3, the *alpha* kwarg (defaulting to 1) will be used to fill in the transparency. If the last dimension is 4, the *alpha* kwarg is ignored; it does not replace the pre-existing alpha. A ValueError will be raised if the third dimension is other than 3 or 4.

In either case, if *bytes* is *False* (default), the rgba array will be floats in the 0-1 range; if it is *True*, the returned rgba array will be uint8 in the 0 to 255 range.

If *norm* is *False*, no normalization of the input data is performed, and it is assumed to already be in the range (0-1).

Note: this method assumes the input is well-behaved; it does not check for anomalies such as *x* being a masked rgba array, or being an integer type other than uint8, or being a floating point rgba array with values outside the 0-1 range.

update(*props*)

Update the properties of this Artist from the dictionary *prop*.

update_from(*other*)

copy properties from other to self

update_scalarmappable()

If the scalar mappable array is not none, update colors from scalar data

zorder = 0

class matplotlib.collections.**BrokenBarHCollection**(*xranges*, *yrange*, ****kwargs**)

Bases: [matplotlib.collections.PolyCollection](#)

A collection of horizontal bars spanning *yrange* with a sequence of *xranges*.

xranges sequence of (*xmin*, *xwidth*)

yrange *ymin*, *ywidth*

Valid Collection keyword arguments:

- *edgecolors*: None
- *facecolors*: None
- *linewidths*: None
- *antialiaseds*: None
- *offsets*: None
- *transOffset*: [transforms.IdentityTransform\(\)](#)
- *norm*: None (optional for [matplotlib.cm.ScalarMappable](#))
- *cmap*: None (optional for [matplotlib.cm.ScalarMappable](#))

offsets and *transOffset* are used to translate the patch after rendering (default no offsets)

If any of *edgecolors*, *facecolors*, *linewidths*, *antialiaseds* are None, they default to their [matplotlib.rcParams](#) patch setting, in sequence form.

add_callback(*func*)

Adds a callback function that will be called whenever one of the `Artist`'s properties changes.

Returns an *id* that is useful for removing the callback with [remove_callback\(\)](#) later.

add_checker(*checker*)

Add an entry to a dictionary of boolean flags that are set to True when the mappable is changed.

aname = 'Artist'

autoscale()

Autoscale the scalar limits on the norm instance using the current array

autoscale_None()

Autoscale the scalar limits on the norm instance using the current array, changing only limits that are None

axes

The [Axes](#) instance the artist resides in, or *None*.

changed()

Call this whenever the mappable is changed to notify all the callbackSM listeners to the 'changed' signal

check_update(*checker*)

If mappable has changed since the last check, return True; else return False

contains(*mouseevent*)

Test whether the mouse event occurred in the collection.

Returns True | False, dict(ind=itemlist), where every item in itemlist contains the event.

convert_xunits(*x*)

For artists in an axes, if the xaxis has units support, convert *x* using xaxis unit type

convert_yunits(*y*)

For artists in an axes, if the yaxis has units support, convert *y* using yaxis unit type

draw(*artist*, *renderer*, **args*, ***kwargs*)**findobj**(*match=None*, *include_self=True*)

Find artist objects.

Recursively find all *Artist* instances contained in self.

match can be

- None: return all objects contained in artist.
- function with signature `boolean = match(artist)` used to filter matches
- class instance: e.g., Line2D. Only return artists of class type.

If *include_self* is True (default), include self in the list to be checked for a match.

format_cursor_data(*data*)

Return *cursor data* string formatted.

get_agg_filter()

return filter function to be used for agg filter

get_alpha()

Return the alpha value used for blending - not supported on all backends

get_animated()

Return the artist's animated state

get_array()

Return the array

get_axes()

Return the *Axes* instance the artist resides in, or *None*.

This has been deprecated in mpl 1.5, please use the axes property. Will be removed in 1.7 or 2.0.

get_children()

Return a list of the child Artist`s `this :class:`Artist` contains.

get_clim()
return the min, max of the color limits for image scaling

get_clip_box()
Return artist clipbox

get_clip_on()
Return whether artist uses clipping

get_clip_path()
Return artist clip path

get_cmap()
return the colormap

get_contains()
Return the `_contains` test used by the artist, or *None* for default.

get_cursor_data(event)
Get the cursor data for a given event.

get_dashes()

get_datalim(transData)

get_edgecolor()

get_edgecolors()

get_facecolor()

get_facecolors()

get_figure()
Return the *Figure* instance the artist belongs to.

get_fill()
return whether fill is set

get_gid()
Returns the group id

get_hatch()
Return the current hatching pattern

get_label()
Get the label used for this artist in the legend.

get_linestyle()

`get_linestyles()`

`get_linewidth()`

`get_linewidths()`

`get_offset_position()`

Returns how offsets are applied for the collection. If *offset_position* is 'screen', the offset is applied after the master transform has been applied, that is, the offsets are in screen coordinates. If *offset_position* is 'data', the offset is applied before the master transform, i.e., the offsets are in data coordinates.

`get_offset_transform()`

`get_offsets()`

Return the offsets for the collection.

`get_path_effects()`

`get_paths()`

`get_picker()`

Return the picker object used by this artist

`get_pickradius()`

`get_rasterized()`

return True if the artist is to be rasterized

`get_sizes()`

Returns the sizes of the elements in the collection. The value represents the 'area' of the element.

Returns sizes : array

The 'area' of each element.

`get_sketch_params()`

Returns the sketch parameters for the artist.

Returns sketch_params : tuple or None

A 3-tuple with the following elements:

- **scale**: The amplitude of the wiggle perpendicular to the source line.
- **length**: The length of the wiggle along the line.
- **randomness**: The scale factor by which the length is shrunken or expanded.

May return None if no sketch parameters were set.

get_snap()

Returns the snap setting which may be:

- True: snap vertices to the nearest pixel center
- False: leave vertices as-is
- None: (auto) If the path contains only rectilinear line segments, round to the nearest pixel center

Only supported by the Agg and MacOSX backends.

get_transform()

Return the *Transform* instance used by this artist.

get_transformed_clip_path_and_affine()

Return the clip path with the non-affine part of its transformation applied, and the remaining affine part of its transformation.

get_transforms()

get_url()

Returns the url

get_urls()

get_visible()

Return the artist's visibility

get_window_extent(*renderer*)

get_zorder()

Return the Artist's zorder.

have_units()

Return *True* if units are set on the *x* or *y* axes

hitlist(*event*)

List the children of the artist which contain the mouse event *event*.

is_figure_set()

Returns *True* if the artist is assigned to a *Figure*.

is_transform_set()

Returns *True* if Artist has a transform explicitly set.

mouseover

pchanged()

Fire an event when property changed, calling all of the registered callbacks.

pick(*mouseevent*)

Process pick event

each child artist will fire a pick event if *mouseevent* is over the artist and the artist has picker set

pickable()

Return *True* if *Artist* is pickable.

properties()

return a dictionary mapping property name -> value for all *Artist* props

remove()

Remove the artist from the figure if possible. The effect will not be visible until the figure is redrawn, e.g., with `matplotlib.axes.Axes.draw_idle()`. Call `matplotlib.axes.Axes.relim()` to update the axes limits if desired.

Note: `relim()` will not see collections even if the collection was added to axes with `autolim = True`.

Note: there is no support for removing the artist's legend entry.

remove_callback(*oid*)

Remove a callback based on its *id*.

See also:

[`add_callback\(\)`](#) For adding callbacks

set(*kwargs*)**

A property batch setter. Pass *kwargs* to set properties.

set_agg_filter(*filter_func*)

set `agg_filter` fuction.

set_alpha(*alpha*)

Set the alpha tranparencies of the collection. *alpha* must be a float or *None*.

ACCEPTS: float or *None*

set_animated(*b*)

Set the artist's animation state.

ACCEPTS: [True | False]

set_antialiased(*aa*)

Set the antialiasing state for rendering.

ACCEPTS: Boolean or sequence of booleans

set_antialiaseds(*aa*)

alias for `set_antialiased`

set_array(*A*)

Set the image array from numpy array *A*

set_axes(*axes*)

Set the *Axes* instance in which the artist resides, if any.

This has been deprecated in mpl 1.5, please use the axes property. Will be removed in 1.7 or 2.0.

ACCEPTS: an *Axes* instance

set_clim(*vmin=None, vmax=None*)

set the norm limits for image scaling; if *vmin* is a length2 sequence, interpret it as (*vmin*, *vmax*) which is used to support setp

ACCEPTS: a length 2 sequence of floats

set_clip_box(*clipbox*)

Set the artist's clip *Bbox*.

ACCEPTS: a *matplotlib.transforms.Bbox* instance

set_clip_on(*b*)

Set whether artist uses clipping.

When False artists will be visible out side of the axes which can lead to unexpected results.

ACCEPTS: [True | False]

set_clip_path(*path, transform=None*)

Set the artist's clip path, which may be:

- a *Patch* (or subclass) instance
- a *Path* instance, in which case an optional *Transform* instance may be provided, which will be applied to the path before using it for clipping.
- *None*, to remove the clipping path

For efficiency, if the path happens to be an axis-aligned rectangle, this method will set the clipping box to the corresponding rectangle and set the clipping path to *None*.

ACCEPTS: [(*Path, Transform*) | *Patch* | None]

set_cmap(*cmap*)

set the colormap for luminance data

ACCEPTS: a colormap or registered colormap name

set_color(*c*)

Set both the edgecolor and the facecolor.

ACCEPTS: matplotlib color arg or sequence of rgba tuples

See also:

[*set_facecolor\(\)*](#), [*set_edgecolor\(\)*](#) For setting the edge or face color individually.

set_contains(*picker*)

Replace the contains test used by this artist. The new picker should be a callable function which determines whether the artist is hit by the mouse event:

```
hit, props = picker(artist, mouseevent)
```

If the mouse event is over the artist, return *hit = True* and *props* is a dictionary of properties you want returned with the contains test.

ACCEPTS: a callable function

set_dashes(*ls*)

alias for `set_linestyle`

set_edgecolor(*c*)

Set the edgecolor(s) of the collection. *c* can be a matplotlib color spec (all patches have same color), or a sequence of specs; if it is a sequence the patches will cycle through the sequence.

If *c* is 'face', the edge color will always be the same as the face color. If it is 'none', the patch boundary will not be drawn.

ACCEPTS: matplotlib color spec or sequence of specs

set_edgecolors(*c*)

alias for `set_edgecolor`

set_facecolor(*c*)

Set the facecolor(s) of the collection. *c* can be a matplotlib color spec (all patches have same color), or a sequence of specs; if it is a sequence the patches will cycle through the sequence.

If *c* is 'none', the patch will not be filled.

ACCEPTS: matplotlib color spec or sequence of specs

set_facecolors(*c*)

alias for `set_facecolor`

set_figure(*fig*)

Set the *Figure* instance the artist belongs to.

ACCEPTS: a `matplotlib.figure.Figure` instance

set_gid(*gid*)

Sets the (group) id for the artist

ACCEPTS: an id string

set_hatch(*hatch*)

Set the hatching pattern

hatch can be one of:

```

/ - diagonal hatching
\ - back diagonal
| - vertical
- - horizontal
+ - crossed
x - crossed diagonal
o - small circle
O - large circle
. - dots
* - stars

```

Letters can be combined, in which case all the specified hatchings are done. If same letter repeats, it increases the density of hatching of that pattern.

Hatching is supported in the PostScript, PDF, SVG and Agg backends only.

Unlike other properties such as linewidth and colors, hatching can only be specified for the collection as a whole, not separately for each member.

ACCEPTS: ['/' | '\' | '|' | '-' | '+' | 'x' | 'o' | 'O' | ':' | '*']

set_label(*s*)

Set the label to *s* for auto legend.

ACCEPTS: string or anything printable with '%s' conversion.

set_linestyle(*ls*)

Set the linestyle(s) for the collection.

linestyle	description
'-' or 'solid'	solid line
'--' or 'dashed'	dashed line
'-.' or 'dashdot'	dash-dotted line
':' or 'dotted'	dotted line

Alternatively a dash tuple of the following form can be provided:

(offset, onoffseq),

where onoffseq is an even length tuple of on and off ink in points.

ACCEPTS: ['solid' | 'dashed', 'dashdot', 'dotted' | (offset, on-off-dash-seq) | '-' | '--' | '-.' | ':' | 'None' | ' ' | '']

Parameters ls : { '-', '-.', ':', ':' } and more see description

The line style.

set_linestyles(*ls*)

alias for set_linestyle

set_linewidth(*lw*)

Set the linewidth(s) for the collection. *lw* can be a scalar or a sequence; if it is a sequence the patches will cycle through the sequence

ACCEPTS: float or sequence of floats

set_linewidths(*lw*)

alias for set_linewidth

set_lw(*lw*)

alias for set_linewidth

set_norm(*norm*)

set the normalization instance

set_offset_position(*offset_position*)

Set how offsets are applied. If *offset_position* is 'screen' (default) the offset is applied after the master transform has been applied, that is, the offsets are in screen coordinates. If

`offset_position` is 'data', the offset is applied before the master transform, i.e., the offsets are in data coordinates.

set_offsets(*offsets*)

Set the offsets for the collection. *offsets* can be a scalar or a sequence.

ACCEPTS: float or sequence of floats

set_path_effects(*path_effects*)

set `path_effects`, which should be a list of instances of `matplotlib.patheffect._Base` class or its derivatives.

set_paths(*verts*, *closed=True*)

This allows one to delay initialization of the vertices.

set_picker(*picker*)

Set the epsilon for picking used by this artist

picker can be one of the following:

- *None*: picking is disabled for this artist (default)
- A boolean: if *True* then picking will be enabled and the artist will fire a pick event if the mouse event is over the artist
- A float: if *picker* is a number it is interpreted as an epsilon tolerance in points and the artist will fire off an event if it's data is within epsilon of the mouse event. For some artists like lines and patch collections, the artist may provide additional data to the pick event that is generated, e.g., the indices of the data within epsilon of the pick event
- A function: if *picker* is callable, it is a user supplied function which determines whether the artist is hit by the mouse event:

```
hit, props = picker(artist, mouseevent)
```

to determine the hit test. if the mouse event is over the artist, return `hit=True` and `props` is a dictionary of properties you want added to the `PickEvent` attributes.

ACCEPTS: [None|float|boolean|callable]

set_pickradius(*pr*)

set_rasterized(*rasterized*)

Force rasterized (bitmap) drawing in vector backend output.

Defaults to *None*, which implies the backend's default behavior

ACCEPTS: [True | False | None]

set_sizes(*sizes*, *dpi=72.0*)

Set the sizes of each member of the collection.

Parameters `sizes` : ndarray or None

The size to set for each element of the collection. The value is the 'area' of the element.

dpi : float

The dpi of the canvas. Defaults to 72.0.

set_sketch_params(*scale=None, length=None, randomness=None*)

Sets the sketch parameters.

Parameters scale : float, optional

The amplitude of the wiggle perpendicular to the source line, in pixels. If scale is `None`, or not provided, no sketch filter will be provided.

length : float, optional

The length of the wiggle along the line, in pixels (default 128.0)

randomness : float, optional

The scale factor by which the length is shrunken or expanded (default 16.0)

set_snap(*snap*)

Sets the snap setting which may be:

- True: snap vertices to the nearest pixel center
- False: leave vertices as-is
- None: (auto) If the path contains only rectilinear line segments, round to the nearest pixel center

Only supported by the Agg and MacOSX backends.

set_transform(*t*)

Set the *Transform* instance used by this artist.

ACCEPTS: *Transform* instance

set_url(*url*)

Sets the url for the artist

ACCEPTS: a url string

set_urls(*urls*)

set_verts(*verts, closed=True*)

This allows one to delay initialization of the vertices.

set_verts_and_codes(*verts, codes*)

This allows one to initialize vertices with path codes.

set_visible(*b*)

Set the artist's visibility.

ACCEPTS: [True | False]

set_zorder(*level*)

Set the zorder for the artist. Artists with lower zorder values are drawn first.

ACCEPTS: any number

static span_where(*x*, *ymin*, *ymax*, *where*, ***kwargs*)

Create a `BrokenBarHCollection` to plot horizontal bars from over the regions in *x* where *where* is `True`. The bars range on the *y*-axis from *ymin* to *ymax*

A `BrokenBarHCollection` is returned. *kwargs* are passed on to the collection.

stale

If the artist is ‘stale’ and needs to be re-drawn for the output to match the internal state of the artist.

sticky_edges

x and *y* sticky edge lists.

When performing autoscaling, if a data limit coincides with a value in the corresponding `sticky_edges` list, then no margin will be added—the view limit “sticks” to the edge. A typical usecase is histograms, where one usually expects no margin on the bottom edge (0) of the histogram.

This attribute cannot be assigned to; however, the *x* and *y* lists can be modified in place as needed.

Examples

```
>>> artist.sticky_edges.x[:] = (xmin, xmax)
>>> artist.sticky_edges.y[:] = (ymin, ymax)
```

to_rgba(*x*, *alpha=None*, *bytes=False*, *norm=True*)

Return a normalized rgba array corresponding to *x*.

In the normal case, *x* is a 1-D or 2-D sequence of scalars, and the corresponding ndarray of rgba values will be returned, based on the `norm` and `colormap` set for this `ScalarMappable`.

There is one special case, for handling images that are already `rgb` or `rgba`, such as might have been read from an image file. If *x* is an ndarray with 3 dimensions, and the last dimension is either 3 or 4, then it will be treated as an `rgb` or `rgba` array, and no mapping will be done. If the last dimension is 3, the `alpha` kwarg (defaulting to 1) will be used to fill in the transparency. If the last dimension is 4, the `alpha` kwarg is ignored; it does not replace the pre-existing alpha. A `ValueError` will be raised if the third dimension is other than 3 or 4.

In either case, if `bytes` is `False` (default), the rgba array will be floats in the 0-1 range; if it is `True`, the returned rgba array will be `uint8` in the 0 to 255 range.

If `norm` is `False`, no normalization of the input data is performed, and it is assumed to already be in the range (0-1).

Note: this method assumes the input is well-behaved; it does not check for anomalies such as *x* being a masked rgba array, or being an integer type other than `uint8`, or being a floating point rgba array with values outside the 0-1 range.

update(*props*)

Update the properties of this `Artist` from the dictionary *prop*.

update_from(*other*)

copy properties from other to self

update_scalarmappable()

If the scalar mappable array is not none, update colors from scalar data

zorder = 0

class matplotlib.collections.**CircleCollection**(*sizes, **kwargs*)

Bases: matplotlib.collections._CollectionWithSizes

A collection of circles, drawn using splines.

sizes Gives the area of the circle in points²

Valid Collection keyword arguments:

- *edgecolors*: None
- *facecolors*: None
- *linewidths*: None
- *antialiaseds*: None
- *offsets*: None
- *transOffset*: transforms.IdentityTransform()
- *norm*: None (optional for *matplotlib.cm.ScalarMappable*)
- *cmap*: None (optional for *matplotlib.cm.ScalarMappable*)

offsets and *transOffset* are used to translate the patch after rendering (default no offsets)

If any of *edgecolors*, *facecolors*, *linewidths*, *antialiaseds* are None, they default to their *matplotlib.rcParams* patch setting, in sequence form.

add_callback(*func*)

Adds a callback function that will be called whenever one of the *Artist*'s properties changes.

Returns an *id* that is useful for removing the callback with *remove_callback()* later.

add_checker(*checker*)

Add an entry to a dictionary of boolean flags that are set to True when the mappable is changed.

aname = 'Artist'

autoscale()

Autoscale the scalar limits on the norm instance using the current array

autoscale_None()

Autoscale the scalar limits on the norm instance using the current array, changing only limits that are None

axes

The *Axes* instance the artist resides in, or *None*.

changed()

Call this whenever the mappable is changed to notify all the callbackSM listeners to the 'changed' signal

check_update(*checker*)

If mappable has changed since the last check, return True; else return False

contains(*mouseevent*)

Test whether the mouse event occurred in the collection.

Returns True | False, dict(ind=itemlist), where every item in itemlist contains the event.

convert_xunits(*x*)

For artists in an axes, if the xaxis has units support, convert *x* using xaxis unit type

convert_yunits(*y*)

For artists in an axes, if the yaxis has units support, convert *y* using yaxis unit type

draw(*artist*, *renderer*, **args*, ***kwargs*)**findobj**(*match=None*, *include_self=True*)

Find artist objects.

Recursively find all *Artist* instances contained in self.

match can be

- None: return all objects contained in artist.
- function with signature `boolean = match(artist)` used to filter matches
- class instance: e.g., `Line2D`. Only return artists of class type.

If *include_self* is True (default), include self in the list to be checked for a match.

format_cursor_data(*data*)

Return *cursor data* string formatted.

get_agg_filter()

return filter function to be used for agg filter

get_alpha()

Return the alpha value used for blending - not supported on all backends

get_animated()

Return the artist's animated state

get_array()

Return the array

get_axes()

Return the *Axes* instance the artist resides in, or *None*.

This has been deprecated in mpl 1.5, please use the axes property. Will be removed in 1.7 or 2.0.

get_children()

Return a list of the child Artist`s `this :class:`Artist` contains.

get_clim()
return the min, max of the color limits for image scaling

get_clip_box()
Return artist clipbox

get_clip_on()
Return whether artist uses clipping

get_clip_path()
Return artist clip path

get_cmap()
return the colormap

get_contains()
Return the `_contains` test used by the artist, or *None* for default.

get_cursor_data(event)
Get the cursor data for a given event.

get_dashes()

get_datalim(transData)

get_edgecolor()

get_edgecolors()

get_facecolor()

get_facecolors()

get_figure()
Return the *Figure* instance the artist belongs to.

get_fill()
return whether fill is set

get_gid()
Returns the group id

get_hatch()
Return the current hatching pattern

get_label()
Get the label used for this artist in the legend.

get_linestyle()

`get_linestyles()`

`get_linewidth()`

`get_linewidths()`

`get_offset_position()`

Returns how offsets are applied for the collection. If *offset_position* is 'screen', the offset is applied after the master transform has been applied, that is, the offsets are in screen coordinates. If *offset_position* is 'data', the offset is applied before the master transform, i.e., the offsets are in data coordinates.

`get_offset_transform()`

`get_offsets()`

Return the offsets for the collection.

`get_path_effects()`

`get_paths()`

`get_picker()`

Return the picker object used by this artist

`get_pickradius()`

`get_rasterized()`

return True if the artist is to be rasterized

`get_sizes()`

Returns the sizes of the elements in the collection. The value represents the 'area' of the element.

Returns sizes : array

The 'area' of each element.

`get_sketch_params()`

Returns the sketch parameters for the artist.

Returns sketch_params : tuple or None

A 3-tuple with the following elements:

- **scale**: The amplitude of the wiggle perpendicular to the source line.
- **length**: The length of the wiggle along the line.
- **randomness**: The scale factor by which the length is shrunken or expanded.

May return None if no sketch parameters were set.

get_snap()

Returns the snap setting which may be:

- True: snap vertices to the nearest pixel center
- False: leave vertices as-is
- None: (auto) If the path contains only rectilinear line segments, round to the nearest pixel center

Only supported by the Agg and MacOSX backends.

get_transform()

Return the *Transform* instance used by this artist.

get_transformed_clip_path_and_affine()

Return the clip path with the non-affine part of its transformation applied, and the remaining affine part of its transformation.

get_transforms()

get_url()

Returns the url

get_urls()

get_visible()

Return the artist's visibility

get_window_extent(*renderer*)

get_zorder()

Return the Artist's zorder.

have_units()

Return *True* if units are set on the *x* or *y* axes

hitlist(*event*)

List the children of the artist which contain the mouse event *event*.

is_figure_set()

Returns *True* if the artist is assigned to a *Figure*.

is_transform_set()

Returns *True* if Artist has a transform explicitly set.

mouseover

pchanged()

Fire an event when property changed, calling all of the registered callbacks.

pick(*mouseevent*)

Process pick event

each child artist will fire a pick event if *mouseevent* is over the artist and the artist has picker set

pickable()

Return *True* if *Artist* is pickable.

properties()

return a dictionary mapping property name -> value for all *Artist* props

remove()

Remove the artist from the figure if possible. The effect will not be visible until the figure is redrawn, e.g., with `matplotlib.axes.Axes.draw_idle()`. Call `matplotlib.axes.Axes.relim()` to update the axes limits if desired.

Note: `relim()` will not see collections even if the collection was added to axes with `autolim = True`.

Note: there is no support for removing the artist's legend entry.

remove_callback(*oid*)

Remove a callback based on its *id*.

See also:

[`add_callback\(\)`](#) For adding callbacks

set(*kwargs*)**

A property batch setter. Pass *kwargs* to set properties.

set_agg_filter(*filter_func*)

set `agg_filter` fuction.

set_alpha(*alpha*)

Set the alpha tranparencies of the collection. *alpha* must be a float or *None*.

ACCEPTS: float or None

set_animated(*b*)

Set the artist's animation state.

ACCEPTS: [True | False]

set_antialiased(*aa*)

Set the antialiasing state for rendering.

ACCEPTS: Boolean or sequence of booleans

set_antialiaseds(*aa*)

alias for `set_antialiased`

set_array(*A*)

Set the image array from numpy array *A*

set_axes(*axes*)

Set the *Axes* instance in which the artist resides, if any.

This has been deprecated in mpl 1.5, please use the axes property. Will be removed in 1.7 or 2.0.

ACCEPTS: an *Axes* instance

set_clim(*vmin=None, vmax=None*)

set the norm limits for image scaling; if *vmin* is a length2 sequence, interpret it as (*vmin*, *vmax*) which is used to support setp

ACCEPTS: a length 2 sequence of floats

set_clip_box(*clipbox*)

Set the artist's clip *Bbox*.

ACCEPTS: a *matplotlib.transforms.Bbox* instance

set_clip_on(*b*)

Set whether artist uses clipping.

When False artists will be visible out side of the axes which can lead to unexpected results.

ACCEPTS: [True | False]

set_clip_path(*path, transform=None*)

Set the artist's clip path, which may be:

- a *Patch* (or subclass) instance
- a *Path* instance, in which case an optional *Transform* instance may be provided, which will be applied to the path before using it for clipping.
- *None*, to remove the clipping path

For efficiency, if the path happens to be an axis-aligned rectangle, this method will set the clipping box to the corresponding rectangle and set the clipping path to *None*.

ACCEPTS: [(*Path, Transform*) | *Patch* | None]

set_cmap(*cmap*)

set the colormap for luminance data

ACCEPTS: a colormap or registered colormap name

set_color(*c*)

Set both the edgecolor and the facecolor.

ACCEPTS: matplotlib color arg or sequence of rgba tuples

See also:

[*set_facecolor\(\)*](#), [*set_edgecolor\(\)*](#) For setting the edge or face color individually.

set_contains(*picker*)

Replace the contains test used by this artist. The new picker should be a callable function which determines whether the artist is hit by the mouse event:

```
hit, props = picker(artist, mouseevent)
```

If the mouse event is over the artist, return *hit = True* and *props* is a dictionary of properties you want returned with the contains test.

ACCEPTS: a callable function

set_dashes(*ls*)

alias for `set_linestyle`

set_edgecolor(*c*)

Set the edgecolor(s) of the collection. *c* can be a matplotlib color spec (all patches have same color), or a sequence of specs; if it is a sequence the patches will cycle through the sequence.

If *c* is 'face', the edge color will always be the same as the face color. If it is 'none', the patch boundary will not be drawn.

ACCEPTS: matplotlib color spec or sequence of specs

set_edgecolors(*c*)

alias for `set_edgecolor`

set_facecolor(*c*)

Set the facecolor(s) of the collection. *c* can be a matplotlib color spec (all patches have same color), or a sequence of specs; if it is a sequence the patches will cycle through the sequence.

If *c* is 'none', the patch will not be filled.

ACCEPTS: matplotlib color spec or sequence of specs

set_facecolors(*c*)

alias for `set_facecolor`

set_figure(*fig*)

Set the *Figure* instance the artist belongs to.

ACCEPTS: a `matplotlib.figure.Figure` instance

set_gid(*gid*)

Sets the (group) id for the artist

ACCEPTS: an id string

set_hatch(*hatch*)

Set the hatching pattern

hatch can be one of:

```

/ - diagonal hatching
\ - back diagonal
| - vertical
- - horizontal
+ - crossed
x - crossed diagonal
o - small circle
O - large circle
. - dots
* - stars

```

Letters can be combined, in which case all the specified hatchings are done. If same letter repeats, it increases the density of hatching of that pattern.

Hatching is supported in the PostScript, PDF, SVG and Agg backends only.

Unlike other properties such as linewidth and colors, hatching can only be specified for the collection as a whole, not separately for each member.

ACCEPTS: ['/' | '\' | '|' | '-' | '+' | 'x' | 'o' | 'O' | ':' | '*']

set_label(*s*)

Set the label to *s* for auto legend.

ACCEPTS: string or anything printable with '%s' conversion.

set_linestyle(*ls*)

Set the linestyle(s) for the collection.

linestyle	description
'-' or 'solid'	solid line
'--' or 'dashed'	dashed line
'-.' or 'dashdot'	dash-dotted line
':' or 'dotted'	dotted line

Alternatively a dash tuple of the following form can be provided:

(offset, onoffseq),

where onoffseq is an even length tuple of on and off ink in points.

ACCEPTS: ['solid' | 'dashed', 'dashdot', 'dotted' | (offset, on-off-dash-seq) | '-' | '--' | '-.' | ':' | 'None' | ' ' | '']

Parameters ls : { '-', '-.', ':', ':' } and more see description

The line style.

set_linestyles(*ls*)

alias for set_linestyle

set_linewidth(*lw*)

Set the linewidth(s) for the collection. *lw* can be a scalar or a sequence; if it is a sequence the patches will cycle through the sequence

ACCEPTS: float or sequence of floats

set_linewidths(*lw*)

alias for set_linewidth

set_lw(*lw*)

alias for set_linewidth

set_norm(*norm*)

set the normalization instance

set_offset_position(*offset_position*)

Set how offsets are applied. If *offset_position* is 'screen' (default) the offset is applied after the master transform has been applied, that is, the offsets are in screen coordinates. If

`offset_position` is 'data', the offset is applied before the master transform, i.e., the offsets are in data coordinates.

set_offsets(*offsets*)

Set the offsets for the collection. *offsets* can be a scalar or a sequence.

ACCEPTS: float or sequence of floats

set_path_effects(*path_effects*)

set `path_effects`, which should be a list of instances of `matplotlib.patheffect._Base` class or its derivatives.

set_paths()

set_picker(*picker*)

Set the epsilon for picking used by this artist

picker can be one of the following:

- *None*: picking is disabled for this artist (default)
- A boolean: if *True* then picking will be enabled and the artist will fire a pick event if the mouse event is over the artist
- A float: if *picker* is a number it is interpreted as an epsilon tolerance in points and the artist will fire off an event if it's data is within epsilon of the mouse event. For some artists like lines and patch collections, the artist may provide additional data to the pick event that is generated, e.g., the indices of the data within epsilon of the pick event
- A function: if *picker* is callable, it is a user supplied function which determines whether the artist is hit by the mouse event:

```
hit, props = picker(artist, mouseevent)
```

to determine the hit test. if the mouse event is over the artist, return `hit=True` and `props` is a dictionary of properties you want added to the `PickEvent` attributes.

ACCEPTS: [None|float|boolean|callable]

set_pickradius(*pr*)

set_rasterized(*rasterized*)

Force rasterized (bitmap) drawing in vector backend output.

Defaults to *None*, which implies the backend's default behavior

ACCEPTS: [True | False | None]

set_sizes(*sizes*, *dpi=72.0*)

Set the sizes of each member of the collection.

Parameters *sizes* : ndarray or None

The size to set for each element of the collection. The value is the 'area' of the element.

dpi : float

The dpi of the canvas. Defaults to 72.0.

set_sketch_params(*scale=None, length=None, randomness=None*)

Sets the sketch parameters.

Parameters scale : float, optional

The amplitude of the wiggle perpendicular to the source line, in pixels. If scale is `None`, or not provided, no sketch filter will be provided.

length : float, optional

The length of the wiggle along the line, in pixels (default 128.0)

randomness : float, optional

The scale factor by which the length is shrunken or expanded (default 16.0)

set_snap(*snap*)

Sets the snap setting which may be:

- True: snap vertices to the nearest pixel center
- False: leave vertices as-is
- None: (auto) If the path contains only rectilinear line segments, round to the nearest pixel center

Only supported by the Agg and MacOSX backends.

set_transform(*t*)

Set the *Transform* instance used by this artist.

ACCEPTS: *Transform* instance

set_url(*url*)

Sets the url for the artist

ACCEPTS: a url string

set_urls(*urls*)

set_visible(*b*)

Set the artist's visibility.

ACCEPTS: [True | False]

set_zorder(*level*)

Set the zorder for the artist. Artists with lower zorder values are drawn first.

ACCEPTS: any number

stale

If the artist is 'stale' and needs to be re-drawn for the output to match the internal state of the artist.

sticky_edges

`x` and `y` sticky edge lists.

When performing autoscaling, if a data limit coincides with a value in the corresponding `sticky_edges` list, then no margin will be added—the view limit “sticks” to the edge. A typical usecase is histograms, where one usually expects no margin on the bottom edge (0) of the histogram.

This attribute cannot be assigned to; however, the `x` and `y` lists can be modified in place as needed.

Examples

```
>>> artist.sticky_edges.x[:] = (xmin, xmax)
>>> artist.sticky_edges.y[:] = (ymin, ymax)
```

to_rgba(*x*, *alpha=None*, *bytes=False*, *norm=True*)

Return a normalized rgba array corresponding to *x*.

In the normal case, *x* is a 1-D or 2-D sequence of scalars, and the corresponding ndarray of rgba values will be returned, based on the `norm` and `colormap` set for this `ScalarMappable`.

There is one special case, for handling images that are already rgb or rgba, such as might have been read from an image file. If *x* is an ndarray with 3 dimensions, and the last dimension is either 3 or 4, then it will be treated as an rgb or rgba array, and no mapping will be done. If the last dimension is 3, the *alpha* kwarg (defaulting to 1) will be used to fill in the transparency. If the last dimension is 4, the *alpha* kwarg is ignored; it does not replace the pre-existing alpha. A `ValueError` will be raised if the third dimension is other than 3 or 4.

In either case, if *bytes* is `False` (default), the rgba array will be floats in the 0-1 range; if it is `True`, the returned rgba array will be `uint8` in the 0 to 255 range.

If *norm* is `False`, no normalization of the input data is performed, and it is assumed to already be in the range (0-1).

Note: this method assumes the input is well-behaved; it does not check for anomalies such as *x* being a masked rgba array, or being an integer type other than `uint8`, or being a floating point rgba array with values outside the 0-1 range.

update(*props*)

Update the properties of this `Artist` from the dictionary *prop*.

update_from(*other*)

copy properties from *other* to self

update_scalarmappable()

If the scalar mappable array is not none, update colors from scalar data

zorder = 0

```
class matplotlib.collections.Collection(edgecolors=None, facecolors=None,
                                       linewidths=None, linestyle='solid', antialiaseds=None, offsets=None, transOffset=None,
                                       norm=None, cmap=None, pickradius=5.0, hatch=None, urls=None, offset_position='screen',
                                       zorder=1, **kwargs)
```

Bases: [matplotlib.artist.Artist](#), [matplotlib.cm.ScalarMappable](#)

Base class for Collections. Must be subclassed to be usable.

All properties in a collection must be sequences or scalars; if scalars, they will be converted to sequences. The property of the *i*th element of the collection is:

```
prop[i % len(props)]
```

Keyword arguments and default values:

- *edgecolors*: None
- *facecolors*: None
- *linewidths*: None
- *antialiaseds*: None
- *offsets*: None
- *transOffset*: `transforms.IdentityTransform()`
- *offset_position*: 'screen' (default) or 'data'
- *norm*: None (optional for [matplotlib.cm.ScalarMappable](#))
- *cmap*: None (optional for [matplotlib.cm.ScalarMappable](#))
- *hatch*: None
- *zorder*: 1

offsets and *transOffset* are used to translate the patch after rendering (default no offsets). If *offset_position* is 'screen' (default) the offset is applied after the master transform has been applied, that is, the offsets are in screen coordinates. If *offset_position* is 'data', the offset is applied before the master transform, i.e., the offsets are in data coordinates.

If any of *edgecolors*, *facecolors*, *linewidths*, *antialiaseds* are None, they default to their [matplotlib.rcParams](#) patch setting, in sequence form.

The use of [ScalarMappable](#) is optional. If the [ScalarMappable](#) matrix *_A* is not None (i.e., a call to `set_array` has been made), at draw time a call to scalar mappable will be made to set the face colors.

Create a Collection

```
%(Collection)s
```

```
add_callback(func)
```

Adds a callback function that will be called whenever one of the `Artist`'s properties changes.

Returns an *id* that is useful for removing the callback with [remove_callback\(\)](#) later.

add_checker(*checker*)

Add an entry to a dictionary of boolean flags that are set to True when the mappable is changed.

aname = 'Artist'

autoscale()

Autoscale the scalar limits on the norm instance using the current array

autoscale_None()

Autoscale the scalar limits on the norm instance using the current array, changing only limits that are None

axes

The *Axes* instance the artist resides in, or *None*.

changed()

Call this whenever the mappable is changed to notify all the callbackSM listeners to the 'changed' signal

check_update(*checker*)

If mappable has changed since the last check, return True; else return False

contains(*mouseevent*)

Test whether the mouse event occurred in the collection.

Returns True | False, dict(ind=itemlist), where every item in itemlist contains the event.

convert_xunits(*x*)

For artists in an axes, if the xaxis has units support, convert *x* using xaxis unit type

convert_yunits(*y*)

For artists in an axes, if the yaxis has units support, convert *y* using yaxis unit type

draw(*artist*, *renderer*, **args*, ***kwargs*)

findobj(*match=None*, *include_self=True*)

Find artist objects.

Recursively find all *Artist* instances contained in self.

match can be

- None: return all objects contained in artist.
- function with signature `boolean = match(artist)` used to filter matches
- class instance: e.g., `Line2D`. Only return artists of class type.

If *include_self* is True (default), include self in the list to be checked for a match.

format_cursor_data(*data*)

Return *cursor data* string formatted.

get_agg_filter()

return filter function to be used for agg filter

get_alpha()

Return the alpha value used for blending - not supported on all backends

get_animated()

Return the artist's animated state

get_array()

Return the array

get_axes()

Return the [Axes](#) instance the artist resides in, or *None*.

This has been deprecated in mpl 1.5, please use the axes property. Will be removed in 1.7 or 2.0.

get_children()

Return a list of the child `Artist`'s `this :class:`Artist` contains.

get_clim()

return the min, max of the color limits for image scaling

get_clip_box()

Return artist clipbox

get_clip_on()

Return whether artist uses clipping

get_clip_path()

Return artist clip path

get_cmap()

return the colormap

get_contains()

Return the `_contains` test used by the artist, or *None* for default.

get_cursor_data(event)

Get the cursor data for a given event.

get_dashes()

get_datalim(transData)

get_edgecolor()

get_edgecolors()

get_facecolor()

get_facecolors()

get_figure()

Return the *Figure* instance the artist belongs to.

get_fill()

return whether fill is set

get_gid()

Returns the group id

get_hatch()

Return the current hatching pattern

get_label()

Get the label used for this artist in the legend.

get_linestyle()**get_linestyles()****get_linewidth()****get_linewidths()****get_offset_position()**

Returns how offsets are applied for the collection. If *offset_position* is 'screen', the offset is applied after the master transform has been applied, that is, the offsets are in screen coordinates. If *offset_position* is 'data', the offset is applied before the master transform, i.e., the offsets are in data coordinates.

get_offset_transform()**get_offsets()**

Return the offsets for the collection.

get_path_effects()**get_paths()****get_picker()**

Return the picker object used by this artist

get_pickradius()**get_rasterized()**

return True if the artist is to be rasterized

get_sketch_params()

Returns the sketch parameters for the artist.

Returns `sketch_params` : tuple or None

A 3-tuple with the following elements:

- scale**: The amplitude of the wiggle perpendicular to the source line.
- length**: The length of the wiggle along the line.
- randomness**: The scale factor by which the length is shrunken or expanded.

May return None if no sketch parameters were set.

get_snap()

Returns the snap setting which may be:

- True: snap vertices to the nearest pixel center
- False: leave vertices as-is
- None: (auto) If the path contains only rectilinear line segments, round to the nearest pixel center

Only supported by the Agg and MacOSX backends.

get_transform()

Return the *Transform* instance used by this artist.

get_transformed_clip_path_and_affine()

Return the clip path with the non-affine part of its transformation applied, and the remaining affine part of its transformation.

get_transforms()

get_url()

Returns the url

get_urls()

get_visible()

Return the artist's visibility

get_window_extent(*renderer*)

get_zorder()

Return the Artist's zorder.

have_units()

Return *True* if units are set on the *x* or *y* axes

hitlist(*event*)

List the children of the artist which contain the mouse event *event*.

is_figure_set()

Returns *True* if the artist is assigned to a *Figure*.

is_transform_set()

Returns *True* if `Artist` has a transform explicitly set.

mouseover**pchanged()**

Fire an event when property changed, calling all of the registered callbacks.

pick(*mouseevent*)

Process pick event

each child artist will fire a pick event if *mouseevent* is over the artist and the artist has picker set

pickable()

Return *True* if `Artist` is pickable.

properties()

return a dictionary mapping property name -> value for all `Artist` props

remove()

Remove the artist from the figure if possible. The effect will not be visible until the figure is redrawn, e.g., with `matplotlib.axes.Axes.draw_idle()`. Call `matplotlib.axes.Axes.relim()` to update the axes limits if desired.

Note: `relim()` will not see collections even if the collection was added to axes with `autolim = True`.

Note: there is no support for removing the artist's legend entry.

remove_callback(*oid*)

Remove a callback based on its *id*.

See also:

[`add_callback\(\)`](#) For adding callbacks

set(*kwargs*)**

A property batch setter. Pass *kwargs* to set properties.

set_agg_filter(*filter_func*)

set `agg_filter` fuction.

set_alpha(*alpha*)

Set the alpha tranparencies of the collection. *alpha* must be a float or *None*.

ACCEPTS: float or None

set_animated(*b*)

Set the artist's animation state.

ACCEPTS: [True | False]

set_antialiased(*aa*)

Set the antialiasing state for rendering.

ACCEPTS: Boolean or sequence of booleans

set_antialiaseds(*aa*)

alias for `set_antialiased`

set_array(*A*)

Set the image array from numpy array *A*

set_axes(*axes*)

Set the *Axes* instance in which the artist resides, if any.

This has been deprecated in mpl 1.5, please use the `axes` property. Will be removed in 1.7 or 2.0.

ACCEPTS: an *Axes* instance

set_clim(*vmin=None, vmax=None*)

set the norm limits for image scaling; if *vmin* is a length2 sequence, interpret it as (*vmin*, *vmax*) which is used to support `setp`

ACCEPTS: a length 2 sequence of floats

set_clip_box(*clipbox*)

Set the artist's clip *Bbox*.

ACCEPTS: a `matplotlib.transforms.Bbox` instance

set_clip_on(*b*)

Set whether artist uses clipping.

When False artists will be visible out side of the axes which can lead to unexpected results.

ACCEPTS: [True | False]

set_clip_path(*path, transform=None*)

Set the artist's clip path, which may be:

- a *Patch* (or subclass) instance
- a ***Path* instance, in which case** an optional *Transform* instance may be provided, which will be applied to the path before using it for clipping.
- *None*, to remove the clipping path

For efficiency, if the path happens to be an axis-aligned rectangle, this method will set the clipping box to the corresponding rectangle and set the clipping path to *None*.

ACCEPTS: [(*Path*, *Transform*) | *Patch* | None]

set_cmap(*cmap*)

set the colormap for luminance data

ACCEPTS: a colormap or registered colormap name

set_color(*c*)

Set both the edgecolor and the facecolor.

ACCEPTS: matplotlib color arg or sequence of rgba tuples

See also:

[`set_facecolor\(\)`](#), [`set_edgecolor\(\)`](#) For setting the edge or face color individually.

set_contains(*picker*)

Replace the contains test used by this artist. The new picker should be a callable function which determines whether the artist is hit by the mouse event:

```
hit, props = picker(artist, mouseevent)
```

If the mouse event is over the artist, return *hit = True* and *props* is a dictionary of properties you want returned with the contains test.

ACCEPTS: a callable function

set_dashes(*ls*)

alias for `set_linestyle`

set_edgecolor(*c*)

Set the edgecolor(s) of the collection. *c* can be a matplotlib color spec (all patches have same color), or a sequence of specs; if it is a sequence the patches will cycle through the sequence.

If *c* is 'face', the edge color will always be the same as the face color. If it is 'none', the patch boundary will not be drawn.

ACCEPTS: matplotlib color spec or sequence of specs

set_edgecolors(*c*)

alias for `set_edgecolor`

set_facecolor(*c*)

Set the facecolor(s) of the collection. *c* can be a matplotlib color spec (all patches have same color), or a sequence of specs; if it is a sequence the patches will cycle through the sequence.

If *c* is 'none', the patch will not be filled.

ACCEPTS: matplotlib color spec or sequence of specs

set_facecolors(*c*)

alias for `set_facecolor`

set_figure(*fig*)

Set the [Figure](#) instance the artist belongs to.

ACCEPTS: a `matplotlib.figure.Figure` instance

set_gid(*gid*)

Sets the (group) id for the artist

ACCEPTS: an id string

set_hatch(*hatch*)

Set the hatching pattern

hatch can be one of:

```
/ - diagonal hatching
\ - back diagonal
| - vertical
- - horizontal
```

```

+ - crossed
x - crossed diagonal
o - small circle
O - large circle
. - dots
* - stars
    
```

Letters can be combined, in which case all the specified hatchings are done. If same letter repeats, it increases the density of hatching of that pattern.

Hatching is supported in the PostScript, PDF, SVG and Agg backends only.

Unlike other properties such as linewidth and colors, hatching can only be specified for the collection as a whole, not separately for each member.

ACCEPTS: ['/' | '\' | '|' | '-' | '+' | 'x' | 'o' | 'O' | '.' | '*']

set_label(*s*)

Set the label to *s* for auto legend.

ACCEPTS: string or anything printable with '%s' conversion.

set_linestyle(*ls*)

Set the linestyle(*s*) for the collection.

linestyle	description
'-' or 'solid'	solid line
'--' or 'dashed'	dashed line
'-.' or 'dashdot'	dash-dotted line
':' or 'dotted'	dotted line

Alternatively a dash tuple of the following form can be provided:

```
(offset, onoffseq),
```

where *onoffseq* is an even length tuple of on and off ink in points.

ACCEPTS: ['solid' | 'dashed', 'dashdot', 'dotted' | (offset, on-off-dash-seq) | '-' | '--' | '-.' | ':' | 'None' | ' ' | '']

Parameters *ls* : { '-', '--', '-.', ':' } and more see description

The line style.

set_linestyles(*ls*)

alias for set_linestyle

set_linewidth(*lw*)

Set the linewidth(*s*) for the collection. *lw* can be a scalar or a sequence; if it is a sequence the patches will cycle through the sequence

ACCEPTS: float or sequence of floats

set_linewidths(*lw*)

alias for set_linewidth

set_lw(*lw*)

alias for set_linewidth

set_norm(*norm*)

set the normalization instance

set_offset_position(*offset_position*)

Set how offsets are applied. If *offset_position* is 'screen' (default) the offset is applied after the master transform has been applied, that is, the offsets are in screen coordinates. If *offset_position* is 'data', the offset is applied before the master transform, i.e., the offsets are in data coordinates.

set_offsets(*offsets*)

Set the offsets for the collection. *offsets* can be a scalar or a sequence.

ACCEPTS: float or sequence of floats

set_path_effects(*path_effects*)

set path_effects, which should be a list of instances of matplotlib.patheffect._Base class or its derivatives.

set_paths()**set_picker(*picker*)**

Set the epsilon for picking used by this artist

picker can be one of the following:

- *None*: picking is disabled for this artist (default)
- A boolean: if *True* then picking will be enabled and the artist will fire a pick event if the mouse event is over the artist
- A float: if *picker* is a number it is interpreted as an epsilon tolerance in points and the artist will fire off an event if it's data is within epsilon of the mouse event. For some artists like lines and patch collections, the artist may provide additional data to the pick event that is generated, e.g., the indices of the data within epsilon of the pick event
- A function: if *picker* is callable, it is a user supplied function which determines whether the artist is hit by the mouse event:

```
hit, props = picker(artist, mouseevent)
```

to determine the hit test. if the mouse event is over the artist, return *hit=True* and *props* is a dictionary of properties you want added to the PickEvent attributes.

ACCEPTS: [None|float|boolean|callable]

set_pickradius(*pr*)**set_rasterized(*rasterized*)**

Force rasterized (bitmap) drawing in vector backend output.

Defaults to None, which implies the backend's default behavior

ACCEPTS: [True | False | None]

set_sketch_params(*scale=None, length=None, randomness=None*)

Sets the sketch parameters.

Parameters scale : float, optional

The amplitude of the wiggle perpendicular to the source line, in pixels. If scale is `None`, or not provided, no sketch filter will be provided.

length : float, optional

The length of the wiggle along the line, in pixels (default 128.0)

randomness : float, optional

The scale factor by which the length is shrunken or expanded (default 16.0)

set_snap(*snap*)

Sets the snap setting which may be:

- True: snap vertices to the nearest pixel center
- False: leave vertices as-is
- None: (auto) If the path contains only rectilinear line segments, round to the nearest pixel center

Only supported by the Agg and MacOSX backends.

set_transform(*t*)

Set the *Transform* instance used by this artist.

ACCEPTS: *Transform* instance

set_url(*url*)

Sets the url for the artist

ACCEPTS: a url string

set_urls(*urls*)

set_visible(*b*)

Set the artist's visibility.

ACCEPTS: [True | False]

set_zorder(*level*)

Set the zorder for the artist. Artists with lower zorder values are drawn first.

ACCEPTS: any number

stale

If the artist is 'stale' and needs to be re-drawn for the output to match the internal state of the artist.

sticky_edges

x and y sticky edge lists.

When performing autoscaling, if a data limit coincides with a value in the corresponding `sticky_edges` list, then no margin will be added—the view limit “sticks” to the edge. A typical usecase is histograms, where one usually expects no margin on the bottom edge (0) of the histogram.

This attribute cannot be assigned to; however, the `x` and `y` lists can be modified in place as needed.

Examples

```
>>> artist.sticky_edges.x[:] = (xmin, xmax)
>>> artist.sticky_edges.y[:] = (ymin, ymax)
```

to_rgba(*x*, *alpha=None*, *bytes=False*, *norm=True*)

Return a normalized rgba array corresponding to *x*.

In the normal case, *x* is a 1-D or 2-D sequence of scalars, and the corresponding ndarray of rgba values will be returned, based on the `norm` and `colormap` set for this `ScalarMappable`.

There is one special case, for handling images that are already rgb or rgba, such as might have been read from an image file. If *x* is an ndarray with 3 dimensions, and the last dimension is either 3 or 4, then it will be treated as an rgb or rgba array, and no mapping will be done. If the last dimension is 3, the *alpha* kwarg (defaulting to 1) will be used to fill in the transparency. If the last dimension is 4, the *alpha* kwarg is ignored; it does not replace the pre-existing alpha. A `ValueError` will be raised if the third dimension is other than 3 or 4.

In either case, if *bytes* is *False* (default), the rgba array will be floats in the 0-1 range; if it is *True*, the returned rgba array will be uint8 in the 0 to 255 range.

If *norm* is *False*, no normalization of the input data is performed, and it is assumed to already be in the range (0-1).

Note: this method assumes the input is well-behaved; it does not check for anomalies such as *x* being a masked rgba array, or being an integer type other than uint8, or being a floating point rgba array with values outside the 0-1 range.

update(*props*)

Update the properties of this `Artist` from the dictionary *prop*.

update_from(*other*)

copy properties from other to self

update_scalarmappable()

If the scalar mappable array is not none, update colors from scalar data

zorder = 0

```
class matplotlib.collections.EllipseCollection(widths, heights, angles, units='points',
                                             **kwargs)
```

Bases: `matplotlib.collections.Collection`

A collection of ellipses, drawn using splines.

widths: sequence lengths of first axes (e.g., major axis lengths)

heights: sequence lengths of second axes

angles: sequence angles of first axes, degrees CCW from the X-axis

units: ['points' | 'inches' | 'dots' | 'width' | 'height' | 'x' | 'y' | 'xy']

units in which majors and minors are given; 'width' and 'height' refer to the dimensions of the axes, while 'x' and 'y' refer to the *offsets* data units. 'xy' differs from all others in that the angle as plotted varies with the aspect ratio, and equals the specified angle only when the aspect ratio is unity. Hence it behaves the same as the *Ellipse* with `axes.transData` as its transform.

Additional kwargs inherited from the base *Collection*:

Valid Collection keyword arguments:

- *edgecolors*: None
- *facecolors*: None
- *linewidths*: None
- *antialiaseds*: None
- *offsets*: None
- *transOffset*: `transforms.IdentityTransform()`
- *norm*: None (optional for *matplotlib.cm.ScalarMappable*)
- *cmap*: None (optional for *matplotlib.cm.ScalarMappable*)

offsets and *transOffset* are used to translate the patch after rendering (default no offsets)

If any of *edgecolors*, *facecolors*, *linewidths*, *antialiaseds* are None, they default to their *matplotlib.rcParams* patch setting, in sequence form.

add_callback(*func*)

Adds a callback function that will be called whenever one of the *Artist*'s properties changes.

Returns an *id* that is useful for removing the callback with *remove_callback()* later.

add_checker(*checker*)

Add an entry to a dictionary of boolean flags that are set to True when the mappable is changed.

aname = 'Artist'

autoscale()

Autoscale the scalar limits on the norm instance using the current array

autoscale_None()

Autoscale the scalar limits on the norm instance using the current array, changing only limits that are None

axes

The *Axes* instance the artist resides in, or *None*.

changed()

Call this whenever the mappable is changed to notify all the callbackSM listeners to the 'changed' signal

check_update(*checker*)

If mappable has changed since the last check, return True; else return False

contains(*mouseevent*)

Test whether the mouse event occurred in the collection.

Returns True | False, dict(ind=itemlist), where every item in itemlist contains the event.

convert_xunits(*x*)

For artists in an axes, if the xaxis has units support, convert *x* using xaxis unit type

convert_yunits(*y*)

For artists in an axes, if the yaxis has units support, convert *y* using yaxis unit type

draw(*artist*, *renderer*, **args*, ***kwargs*)**findobj**(*match=None*, *include_self=True*)

Find artist objects.

Recursively find all *Artist* instances contained in self.

match can be

- None: return all objects contained in artist.
- function with signature `boolean = match(artist)` used to filter matches
- class instance: e.g., Line2D. Only return artists of class type.

If *include_self* is True (default), include self in the list to be checked for a match.

format_cursor_data(*data*)

Return *cursor data* string formatted.

get_agg_filter()

return filter function to be used for agg filter

get_alpha()

Return the alpha value used for blending - not supported on all backends

get_animated()

Return the artist's animated state

get_array()

Return the array

get_axes()

Return the *Axes* instance the artist resides in, or *None*.

This has been deprecated in mpl 1.5, please use the axes property. Will be removed in 1.7 or 2.0.

get_children()

Return a list of the child Artist`s `this :class:`Artist` contains.

get_clim()
return the min, max of the color limits for image scaling

get_clip_box()
Return artist clipbox

get_clip_on()
Return whether artist uses clipping

get_clip_path()
Return artist clip path

get_cmap()
return the colormap

get_contains()
Return the `_contains` test used by the artist, or *None* for default.

get_cursor_data(event)
Get the cursor data for a given event.

get_dashes()

get_datalim(transData)

get_edgecolor()

get_edgecolors()

get_facecolor()

get_facecolors()

get_figure()
Return the *Figure* instance the artist belongs to.

get_fill()
return whether fill is set

get_gid()
Returns the group id

get_hatch()
Return the current hatching pattern

get_label()
Get the label used for this artist in the legend.

get_linestyle()

`get_linestyles()`

`get_linewidth()`

`get_linewidths()`

`get_offset_position()`

Returns how offsets are applied for the collection. If *offset_position* is 'screen', the offset is applied after the master transform has been applied, that is, the offsets are in screen coordinates. If *offset_position* is 'data', the offset is applied before the master transform, i.e., the offsets are in data coordinates.

`get_offset_transform()`

`get_offsets()`

Return the offsets for the collection.

`get_path_effects()`

`get_paths()`

`get_picker()`

Return the picker object used by this artist

`get_pickradius()`

`get_rasterized()`

return True if the artist is to be rasterized

`get_sketch_params()`

Returns the sketch parameters for the artist.

Returns `sketch_params` : tuple or None

A 3-tuple with the following elements:

- **scale:** The amplitude of the wiggle perpendicular to the source line.
- **length:** The length of the wiggle along the line.
- **randomness:** The scale factor by which the length is shrunken or expanded.

May return None if no sketch parameters were set.

`get_snap()`

Returns the snap setting which may be:

- True: snap vertices to the nearest pixel center
- False: leave vertices as-is

- None: (auto) If the path contains only rectilinear line segments, round to the nearest pixel center

Only supported by the Agg and MacOSX backends.

get_transform()

Return the *Transform* instance used by this artist.

get_transformed_clip_path_and_affine()

Return the clip path with the non-affine part of its transformation applied, and the remaining affine part of its transformation.

get_transforms()

get_url()

Returns the url

get_urls()

get_visible()

Return the artist's visibility

get_window_extent(renderer)

get_zorder()

Return the Artist's zorder.

have_units()

Return *True* if units are set on the *x* or *y* axes

hitlist(event)

List the children of the artist which contain the mouse event *event*.

is_figure_set()

Returns *True* if the artist is assigned to a *Figure*.

is_transform_set()

Returns *True* if Artist has a transform explicitly set.

mouseover

pchanged()

Fire an event when property changed, calling all of the registered callbacks.

pick(mouseevent)

Process pick event

each child artist will fire a pick event if *mouseevent* is over the artist and the artist has picker set

pickable()

Return *True* if Artist is pickable.

properties()

return a dictionary mapping property name -> value for all Artist props

remove()

Remove the artist from the figure if possible. The effect will not be visible until the figure is redrawn, e.g., with `matplotlib.axes.Axes.draw_idle()`. Call `matplotlib.axes.Axes.relim()` to update the axes limits if desired.

Note: `relim()` will not see collections even if the collection was added to axes with `autolim = True`.

Note: there is no support for removing the artist's legend entry.

remove_callback(*oid*)

Remove a callback based on its *id*.

See also:

[`add_callback\(\)`](#) For adding callbacks

set(*kwargs*)**

A property batch setter. Pass *kwargs* to set properties.

set_agg_filter(*filter_func*)

set `agg_filter` function.

set_alpha(*alpha*)

Set the alpha transparencies of the collection. *alpha* must be a float or *None*.

ACCEPTS: float or None

set_animated(*b*)

Set the artist's animation state.

ACCEPTS: [True | False]

set_antialiased(*aa*)

Set the antialiasing state for rendering.

ACCEPTS: Boolean or sequence of booleans

set_antialiaseds(*aa*)

alias for `set_antialiased`

set_array(*A*)

Set the image array from numpy array *A*

set_axes(*axes*)

Set the [`Axes`](#) instance in which the artist resides, if any.

This has been deprecated in mpl 1.5, please use the `axes` property. Will be removed in 1.7 or 2.0.

ACCEPTS: an [`Axes`](#) instance

set_clim(*vmin=None, vmax=None*)

set the norm limits for image scaling; if *vmin* is a length2 sequence, interpret it as (*vmin*, *vmax*) which is used to support `setp`

ACCEPTS: a length 2 sequence of floats

set_clip_box(*clipbox*)

Set the artist's clip *Bbox*.

ACCEPTS: a `matplotlib.transforms.Bbox` instance

set_clip_on(*b*)

Set whether artist uses clipping.

When False artists will be visible out side of the axes which can lead to unexpected results.

ACCEPTS: [True | False]

set_clip_path(*path*, *transform=None*)

Set the artist's clip path, which may be:

- a *Patch* (or subclass) instance
- a ***Path* instance, in which case** an optional *Transform* instance may be provided, which will be applied to the path before using it for clipping.
- *None*, to remove the clipping path

For efficiency, if the path happens to be an axis-aligned rectangle, this method will set the clipping box to the corresponding rectangle and set the clipping path to *None*.

ACCEPTS: [(*Path*, *Transform*) | *Patch* | None]

set_cmap(*cmap*)

set the colormap for luminance data

ACCEPTS: a colormap or registered colormap name

set_color(*c*)

Set both the edgecolor and the facecolor.

ACCEPTS: matplotlib color arg or sequence of rgba tuples

See also:

[`set_facecolor\(\)`](#), [`set_edgecolor\(\)`](#) For setting the edge or face color individually.

set_contains(*picker*)

Replace the contains test used by this artist. The new picker should be a callable function which determines whether the artist is hit by the mouse event:

```
hit, props = picker(artist, mouseevent)
```

If the mouse event is over the artist, return *hit = True* and *props* is a dictionary of properties you want returned with the contains test.

ACCEPTS: a callable function

set_dashes(*ls*)

alias for `set_linestyle`

set_edgcolor(*c*)

Set the edgcolor(s) of the collection. *c* can be a matplotlib color spec (all patches have same color), or a sequence of specs; if it is a sequence the patches will cycle through the sequence.

If *c* is 'face', the edge color will always be the same as the face color. If it is 'none', the patch boundary will not be drawn.

ACCEPTS: matplotlib color spec or sequence of specs

set_edgecolors(*c*)

alias for set_edgcolor

set_facecolor(*c*)

Set the facecolor(s) of the collection. *c* can be a matplotlib color spec (all patches have same color), or a sequence of specs; if it is a sequence the patches will cycle through the sequence.

If *c* is 'none', the patch will not be filled.

ACCEPTS: matplotlib color spec or sequence of specs

set_facecolors(*c*)

alias for set_facecolor

set_figure(*fig*)

Set the *Figure* instance the artist belongs to.

ACCEPTS: a *matplotlib.figure.Figure* instance

set_gid(*gid*)

Sets the (group) id for the artist

ACCEPTS: an id string

set_hatch(*hatch*)

Set the hatching pattern

hatch can be one of:

```

/ - diagonal hatching
\ - back diagonal
| - vertical
- - horizontal
+ - crossed
x - crossed diagonal
o - small circle
O - large circle
. - dots
* - stars

```

Letters can be combined, in which case all the specified hatchings are done. If same letter repeats, it increases the density of hatching of that pattern.

Hatching is supported in the PostScript, PDF, SVG and Agg backends only.

Unlike other properties such as linewidth and colors, hatching can only be specified for the collection as a whole, not separately for each member.

ACCEPTS: ['/' | '\' | '|' | '-' | '+' | 'x' | 'o' | 'O' | '.' | '*']

set_label(*s*)

Set the label to *s* for auto legend.

ACCEPTS: string or anything printable with '%s' conversion.

set_linestyle(*ls*)

Set the linestyle(*s*) for the collection.

linestyle	description
'-' or 'solid'	solid line
'--' or 'dashed'	dashed line
'-.' or 'dashdot'	dash-dotted line
':' or 'dotted'	dotted line

Alternatively a dash tuple of the following form can be provided:

(offset, onoffseq),

where *onoffseq* is an even length tuple of on and off ink in points.

ACCEPTS: ['solid' | 'dashed', 'dashdot', 'dotted' | (offset, on-off-dash-seq) | '-' | '--' | '-.' | ':' | 'None' | ' ' | '']

Parameters *ls* : { '-', '--', '-.', ':' } and more see description

The line style.

set_linestyles(*ls*)

alias for `set_linestyle`

set_linewidth(*lw*)

Set the linewidth(*s*) for the collection. *lw* can be a scalar or a sequence; if it is a sequence the patches will cycle through the sequence

ACCEPTS: float or sequence of floats

set_linewidths(*lw*)

alias for `set_linewidth`

set_lw(*lw*)

alias for `set_linewidth`

set_norm(*norm*)

set the normalization instance

set_offset_position(*offset_position*)

Set how offsets are applied. If *offset_position* is 'screen' (default) the offset is applied after the master transform has been applied, that is, the offsets are in screen coordinates. If *offset_position* is 'data', the offset is applied before the master transform, i.e., the offsets are in data coordinates.

set_offsets(*offsets*)

Set the offsets for the collection. *offsets* can be a scalar or a sequence.

ACCEPTS: float or sequence of floats

set_path_effects(*path_effects*)

set *path_effects*, which should be a list of instances of `matplotlib.patheffect._Base` class or its derivatives.

set_paths()

set_picker(*picker*)

Set the epsilon for picking used by this artist

picker can be one of the following:

- *None*: picking is disabled for this artist (default)
- A boolean: if *True* then picking will be enabled and the artist will fire a pick event if the mouse event is over the artist
- A float: if *picker* is a number it is interpreted as an epsilon tolerance in points and the artist will fire off an event if it's data is within epsilon of the mouse event. For some artists like lines and patch collections, the artist may provide additional data to the pick event that is generated, e.g., the indices of the data within epsilon of the pick event
- A function: if *picker* is callable, it is a user supplied function which determines whether the artist is hit by the mouse event:

```
hit, props = picker(artist, mouseevent)
```

to determine the hit test. if the mouse event is over the artist, return *hit=True* and *props* is a dictionary of properties you want added to the `PickEvent` attributes.

ACCEPTS: [None|float|boolean|callable]

set_pickradius(*pr*)

set_rasterized(*rasterized*)

Force rasterized (bitmap) drawing in vector backend output.

Defaults to *None*, which implies the backend's default behavior

ACCEPTS: [True | False | None]

set_sketch_params(*scale=None, length=None, randomness=None*)

Sets the sketch parameters.

Parameters scale : float, optional

The amplitude of the wiggle perpendicular to the source line, in pixels. If *scale* is *None*, or not provided, no sketch filter will be provided.

length : float, optional

The length of the wiggle along the line, in pixels (default 128.0)

randomness : float, optional

The scale factor by which the length is shrunken or expanded (default 16.0)

set_snap(*snap*)

Sets the snap setting which may be:

- True: snap vertices to the nearest pixel center
- False: leave vertices as-is
- None: (auto) If the path contains only rectilinear line segments, round to the nearest pixel center

Only supported by the Agg and MacOSX backends.

set_transform(*t*)

Set the *Transform* instance used by this artist.

ACCEPTS: *Transform* instance

set_url(*url*)

Sets the url for the artist

ACCEPTS: a url string

set_urls(*urls*)

set_visible(*b*)

Set the artist's visibility.

ACCEPTS: [True | False]

set_zorder(*level*)

Set the zorder for the artist. Artists with lower zorder values are drawn first.

ACCEPTS: any number

stale

If the artist is 'stale' and needs to be re-drawn for the output to match the internal state of the artist.

sticky_edges

x and y sticky edge lists.

When performing autoscaling, if a data limit coincides with a value in the corresponding sticky_edges list, then no margin will be added—the view limit “sticks” to the edge. A typical usecase is histograms, where one usually expects no margin on the bottom edge (0) of the histogram.

This attribute cannot be assigned to; however, the x and y lists can be modified in place as needed.

Examples

```
>>> artist.sticky_edges.x[:] = (xmin, xmax)
>>> artist.sticky_edges.y[:] = (ymin, ymax)
```

to_rgba(*x*, *alpha=None*, *bytes=False*, *norm=True*)

Return a normalized rgba array corresponding to *x*.

In the normal case, *x* is a 1-D or 2-D sequence of scalars, and the corresponding ndarray of rgba values will be returned, based on the norm and colormap set for this ScalarMappable.

There is one special case, for handling images that are already rgb or rgba, such as might have been read from an image file. If *x* is an ndarray with 3 dimensions, and the last dimension is either 3 or 4, then it will be treated as an rgb or rgba array, and no mapping will be done. If the last dimension is 3, the *alpha* kwarg (defaulting to 1) will be used to fill in the transparency. If the last dimension is 4, the *alpha* kwarg is ignored; it does not replace the pre-existing alpha. A `ValueError` will be raised if the third dimension is other than 3 or 4.

In either case, if *bytes* is *False* (default), the rgba array will be floats in the 0-1 range; if it is *True*, the returned rgba array will be uint8 in the 0 to 255 range.

If *norm* is *False*, no normalization of the input data is performed, and it is assumed to already be in the range (0-1).

Note: this method assumes the input is well-behaved; it does not check for anomalies such as *x* being a masked rgba array, or being an integer type other than uint8, or being a floating point rgba array with values outside the 0-1 range.

update(*props*)

Update the properties of this `Artist` from the dictionary *prop*.

update_from(*other*)

copy properties from other to self

update_scalarmappable()

If the scalar mappable array is not none, update colors from scalar data

zorder = 0

```
class matplotlib.collections.EventCollection(positions, orientation=None, lineoffset=0,
                                             linelength=1, linewidth=None, color=None,
                                             linestyle='solid', antialiased=None,
                                             **kwargs)
```

Bases: `matplotlib.collections.LineCollection`

A collection of discrete events.

An event is a 1-dimensional value, usually the position of something along an axis, such as time or length. Events do not have an amplitude. They are displayed as v

positions a sequence of numerical values or a 1D numpy array. Can be None

orientation ['horizontal' | 'vertical' | None] defaults to 'horizontal' if not specified or None

lineoffset a single numerical value, corresponding to the offset of the center of the markers from the origin

linelength a single numerical value, corresponding to the total height of the marker (i.e. the marker stretches from $\text{lineoffset} + \text{linelength}/2$ to $\text{lineoffset} - \text{linelength}/2$). Defaults to 1

linewidth a single numerical value

color must be a sequence of RGBA tuples (e.g., arbitrary color strings, etc, not allowed).

linestyle ['solid' | 'dashed' | 'dashdot' | 'dotted']

antialiased 1 or 2

If *linewidth*, *color*, or *antialiased* is None, they default to their rcParams setting, in sequence form.

norm None (optional for *matplotlib.cm.ScalarMappable*)

cmap None (optional for *matplotlib.cm.ScalarMappable*)

pickradius is the tolerance for mouse clicks picking a line. The default is 5 pt.

The use of *ScalarMappable* is optional. If the *ScalarMappable* array *_A* is not None (i.e., a call to *set_array()* has been made), at draw time a call to scalar mappable will be made to set the colors.

Example:

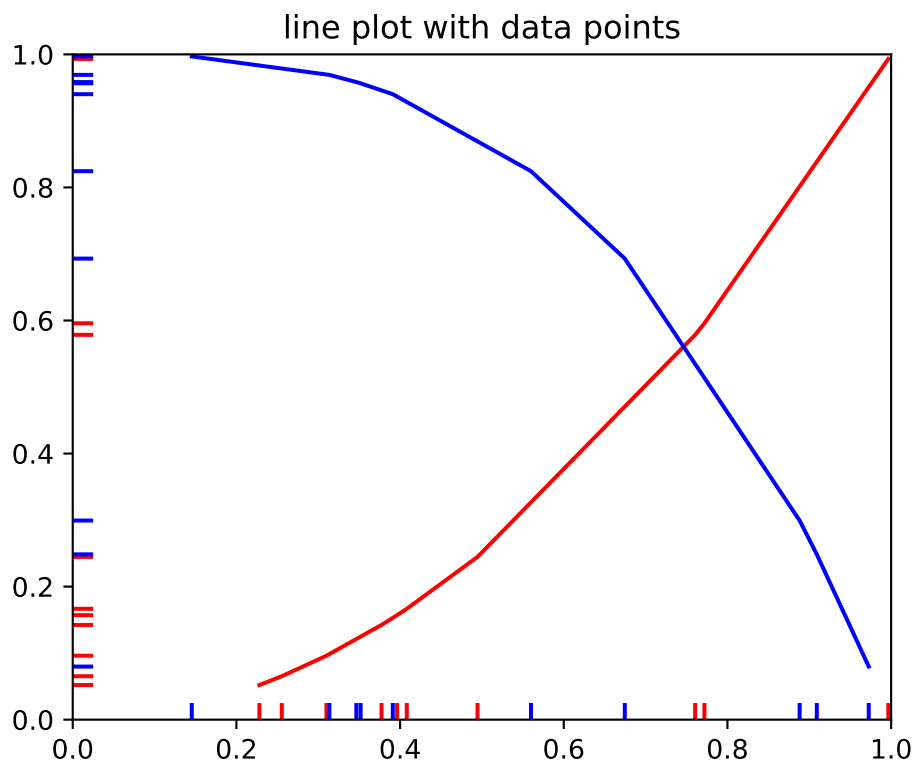

add_callback(func)

Adds a callback function that will be called whenever one of the Artist's properties changes.

Returns an *id* that is useful for removing the callback with `remove_callback()` later.

add_checker(*checker*)

Add an entry to a dictionary of boolean flags that are set to True when the mappable is changed.

add_positions(*position*)

add one or more events at the specified positions

aname = 'Artist'

append_positions(*position*)

add one or more events at the specified positions

autoscale()

Autoscale the scalar limits on the norm instance using the current array

autoscale_None()

Autoscale the scalar limits on the norm instance using the current array, changing only limits that are None

axes

The *Axes* instance the artist resides in, or *None*.

changed()

Call this whenever the mappable is changed to notify all the callbackSM listeners to the 'changed' signal

check_update(*checker*)

If mappable has changed since the last check, return True; else return False

contains(*mouseevent*)

Test whether the mouse event occurred in the collection.

Returns True | False, dict(ind=itemlist), where every item in itemlist contains the event.

convert_xunits(*x*)

For artists in an axes, if the xaxis has units support, convert *x* using xaxis unit type

convert_yunits(*y*)

For artists in an axes, if the yaxis has units support, convert *y* using yaxis unit type

draw(*artist*, *renderer*, **args*, ***kwargs*)

extend_positions(*position*)

add one or more events at the specified positions

findobj(*match=None*, *include_self=True*)

Find artist objects.

Recursively find all *Artist* instances contained in self.

match can be

- None: return all objects contained in artist.
- function with signature `boolean = match(artist)` used to filter matches

- class instance: e.g., Line2D. Only return artists of class type.

If `include_self` is True (default), include self in the list to be checked for a match.

format_cursor_data(*data*)

Return *cursor data* string formatted.

get_agg_filter()

return filter function to be used for agg filter

get_alpha()

Return the alpha value used for blending - not supported on all backends

get_animated()

Return the artist's animated state

get_array()

Return the array

get_axes()

Return the [Axes](#) instance the artist resides in, or *None*.

This has been deprecated in mpl 1.5, please use the axes property. Will be removed in 1.7 or 2.0.

get_children()

Return a list of the child `Artist`'s `this :class:`Artist` contains.

get_clim()

return the min, max of the color limits for image scaling

get_clip_box()

Return artist clipbox

get_clip_on()

Return whether artist uses clipping

get_clip_path()

Return artist clip path

get_cmap()

return the colormap

get_color()

get the color of the lines used to mark each event

get_colors()

get_contains()

Return the `_contains` test used by the artist, or *None* for default.

get_cursor_data(*event*)

Get the cursor data for a given event.

get_dashes()

get_datalim(*transData*)

get_edgecolor()

get_edgecolors()

get_facecolor()

get_facecolors()

get_figure()

Return the *Figure* instance the artist belongs to.

get_fill()

return whether fill is set

get_gid()

Returns the group id

get_hatch()

Return the current hatching pattern

get_label()

Get the label used for this artist in the legend.

get_linelength()

get the length of the lines used to mark each event

get_lineoffset()

get the offset of the lines used to mark each event

get_linestyle()

get the style of the lines used to mark each event ['solid' | 'dashed' | 'dashdot' | 'dotted']

get_linestyles()

get_linewidth()

get the width of the lines used to mark each event

get_linewidths()

get_offset_position()

Returns how offsets are applied for the collection. If *offset_position* is 'screen', the offset is applied after the master transform has been applied, that is, the offsets are in screen coordinates. If *offset_position* is 'data', the offset is applied before the master transform, i.e., the offsets are in data coordinates.

get_offset_transform()

get_offsets()

Return the offsets for the collection.

get_orientation()

get the orientation of the event line, may be: ['horizontal' | 'vertical']

get_path_effects()

get_paths()

get_picker()

Return the picker object used by this artist

get_pickradius()

get_positions()

return an array containing the floating-point values of the positions

get_rasterized()

return True if the artist is to be rasterized

get_segments()

get_sketch_params()

Returns the sketch parameters for the artist.

Returns sketch_params : tuple or None

A 3-tuple with the following elements:

- scale: The amplitude of the wiggle perpendicular to the source line.
- length: The length of the wiggle along the line.
- randomness: The scale factor by which the length is shrunken or expanded.

May return None if no sketch parameters were set.

get_snap()

Returns the snap setting which may be:

- True: snap vertices to the nearest pixel center
- False: leave vertices as-is
- None: (auto) If the path contains only rectilinear line segments, round to the nearest pixel center

Only supported by the Agg and MacOSX backends.

get_transform()

Return the *Transform* instance used by this artist.

get_transformed_clip_path_and_affine()

Return the clip path with the non-affine part of its transformation applied, and the remaining affine part of its transformation.

get_transforms()**get_url()**

Returns the url

get_urls()**get_visible()**

Return the artist's visibility

get_window_extent(renderer)**get_zorder()**

Return the Artist's zorder.

have_units()

Return *True* if units are set on the *x* or *y* axes

hitlist(event)

List the children of the artist which contain the mouse event *event*.

is_figure_set()

Returns *True* if the artist is assigned to a *Figure*.

is_horizontal()

True if the eventcollection is horizontal, *False* if vertical

is_transform_set()

Returns *True* if *Artist* has a transform explicitly set.

mouseover**pchanged()**

Fire an event when property changed, calling all of the registered callbacks.

pick(mouseevent)

Process pick event

each child artist will fire a pick event if *mouseevent* is over the artist and the artist has picker set

pickable()

Return *True* if *Artist* is pickable.

properties()

return a dictionary mapping property name -> value for all *Artist* props

remove()

Remove the artist from the figure if possible. The effect will not be visible until the figure is

redrawn, e.g., with `matplotlib.axes.Axes.draw_idle()`. Call `matplotlib.axes.Axes.relim()` to update the axes limits if desired.

Note: `relim()` will not see collections even if the collection was added to axes with `autolim = True`.

Note: there is no support for removing the artist's legend entry.

remove_callback(*oid*)

Remove a callback based on its *id*.

See also:

[`add_callback\(\)`](#) For adding callbacks

set(*kwargs*)**

A property batch setter. Pass *kwargs* to set properties.

set_agg_filter(*filter_func*)

set `agg_filter` fuction.

set_alpha(*alpha*)

Set the alpha tranparencies of the collection. *alpha* must be a float or *None*.

ACCEPTS: float or None

set_animated(*b*)

Set the artist's animation state.

ACCEPTS: [True | False]

set_antialiased(*aa*)

Set the antialiasing state for rendering.

ACCEPTS: Boolean or sequence of booleans

set_antialiaseds(*aa*)

alias for `set_antialiased`

set_array(*A*)

Set the image array from numpy array *A*

set_axes(*axes*)

Set the [*Axes*](#) instance in which the artist resides, if any.

This has been deprecated in mpl 1.5, please use the `axes` property. Will be removed in 1.7 or 2.0.

ACCEPTS: an [*Axes*](#) instance

set_clim(*vmin=None, vmax=None*)

set the norm limits for image scaling; if *vmin* is a length2 sequence, interpret it as (*vmin*, *vmax*) which is used to support `setp`

ACCEPTS: a length 2 sequence of floats

set_clip_box(*clipbox*)

Set the artist's clip [*Bbox*](#).

ACCEPTS: a `matplotlib.transforms.Bbox` instance

set_clip_on(*b*)

Set whether artist uses clipping.

When False artists will be visible out side of the axes which can lead to unexpected results.

ACCEPTS: [True | False]

set_clip_path(*path*, *transform=None*)

Set the artist's clip path, which may be:

- a `Patch` (or subclass) instance
- a `Path` instance, in which case an optional `Transform` instance may be provided, which will be applied to the path before using it for clipping.
- `None`, to remove the clipping path

For efficiency, if the path happens to be an axis-aligned rectangle, this method will set the clipping box to the corresponding rectangle and set the clipping path to `None`.

ACCEPTS: [(`Path`, `Transform`) | `Patch` | `None`]

set_cmap(*cmap*)

set the colormap for luminance data

ACCEPTS: a colormap or registered colormap name

set_color(*c*)

Set the color(s) of the line collection. *c* can be a matplotlib color arg (all patches have same color), or a sequence or rgba tuples; if it is a sequence the patches will cycle through the sequence.

ACCEPTS: matplotlib color arg or sequence of rgba tuples

set_contains(*picker*)

Replace the contains test used by this artist. The new picker should be a callable function which determines whether the artist is hit by the mouse event:

```
hit, props = picker(artist, mouseevent)
```

If the mouse event is over the artist, return `hit = True` and `props` is a dictionary of properties you want returned with the contains test.

ACCEPTS: a callable function

set_dashes(*ls*)

alias for `set_linestyle`

set_edgecolor(*c*)

Set the edgecolor(s) of the collection. *c* can be a matplotlib color spec (all patches have same color), or a sequence of specs; if it is a sequence the patches will cycle through the sequence.

If *c* is 'face', the edge color will always be the same as the face color. If it is 'none', the patch boundary will not be drawn.

ACCEPTS: matplotlib color spec or sequence of specs

set_edgecolors(*c*)
alias for set_edgecolor

set_facecolor(*c*)
Set the facecolor(s) of the collection. *c* can be a matplotlib color spec (all patches have same color), or a sequence of specs; if it is a sequence the patches will cycle through the sequence.

If *c* is 'none', the patch will not be filled.

ACCEPTS: matplotlib color spec or sequence of specs

set_facecolors(*c*)
alias for set_facecolor

set_figure(*fig*)
Set the *Figure* instance the artist belongs to.

ACCEPTS: a *matplotlib.figure.Figure* instance

set_gid(*gid*)
Sets the (group) id for the artist

ACCEPTS: an id string

set_hatch(*hatch*)
Set the hatching pattern

hatch can be one of:

```
/ - diagonal hatching
\ - back diagonal
| - vertical
- - horizontal
+ - crossed
x - crossed diagonal
o - small circle
O - large circle
. - dots
* - stars
```

Letters can be combined, in which case all the specified hatchings are done. If same letter repeats, it increases the density of hatching of that pattern.

Hatching is supported in the PostScript, PDF, SVG and Agg backends only.

Unlike other properties such as linewidth and colors, hatching can only be specified for the collection as a whole, not separately for each member.

ACCEPTS: ['/' | '\' | '|' | '-' | '+' | 'x' | 'o' | 'O' | '.' | '*']

set_label(*s*)
Set the label to *s* for auto legend.

ACCEPTS: string or anything printable with '%s' conversion.

set_linelength(*linelength*)
set the length of the lines used to mark each event

set_lineoffset(*lineoffset*)
set the offset of the lines used to mark each event

set_linestyle(*ls*)
Set the linestyle(s) for the collection.

linestyle	description
'-' or 'solid'	solid line
'--' or 'dashed'	dashed line
'-.' or 'dashdot'	dash-dotted line
':' or 'dotted'	dotted line

Alternatively a dash tuple of the following form can be provided:

```
(offset, onoffseq),
```

where *onoffseq* is an even length tuple of on and off ink in points.

ACCEPTS: ['solid' | 'dashed', 'dashdot', 'dotted' | (offset, on-off-dash-seq) | '-' | '--' | '-.' | ':' | 'None' | ' ' | '']

Parameters ls : { '-', '-.', ':', ':' } and more see description

The line style.

set_linestyles(*ls*)
alias for `set_linestyle`

set_linewidth(*lw*)
Set the linewidth(s) for the collection. *lw* can be a scalar or a sequence; if it is a sequence the patches will cycle through the sequence
ACCEPTS: float or sequence of floats

set_linewidths(*lw*)
alias for `set_linewidth`

set_lw(*lw*)
alias for `set_linewidth`

set_norm(*norm*)
set the normalization instance

set_offset_position(*offset_position*)
Set how offsets are applied. If *offset_position* is 'screen' (default) the offset is applied after the master transform has been applied, that is, the offsets are in screen coordinates. If *offset_position* is 'data', the offset is applied before the master transform, i.e., the offsets are in data coordinates.

set_offsets(*offsets*)
Set the offsets for the collection. *offsets* can be a scalar or a sequence.

ACCEPTS: float or sequence of floats

set_orientation(*orientation=None*)

set the orientation of the event line ['horizontal' | 'vertical' | None] defaults to 'horizontal' if not specified or None

set_path_effects(*path_effects*)

set path_effects, which should be a list of instances of matplotlib.patheffect._Base class or its derivatives.

set_paths(*segments*)

set_picker(*picker*)

Set the epsilon for picking used by this artist

picker can be one of the following:

- *None*: picking is disabled for this artist (default)
- A boolean: if *True* then picking will be enabled and the artist will fire a pick event if the mouse event is over the artist
- A float: if *picker* is a number it is interpreted as an epsilon tolerance in points and the artist will fire off an event if it's data is within epsilon of the mouse event. For some artists like lines and patch collections, the artist may provide additional data to the pick event that is generated, e.g., the indices of the data within epsilon of the pick event
- A function: if *picker* is callable, it is a user supplied function which determines whether the artist is hit by the mouse event:

```
hit, props = picker(artist, mouseevent)
```

to determine the hit test. if the mouse event is over the artist, return *hit=True* and *props* is a dictionary of properties you want added to the PickEvent attributes.

ACCEPTS: [None|float|boolean|callable]

set_pickradius(*pr*)

set_positions(*positions*)

set the positions of the events to the specified value

set_rasterized(*rasterized*)

Force rasterized (bitmap) drawing in vector backend output.

Defaults to None, which implies the backend's default behavior

ACCEPTS: [True | False | None]

set_segments(*segments*)

set_sketch_params(*scale=None, length=None, randomness=None*)

Sets the sketch parameters.

Parameters scale : float, optional

The amplitude of the wiggle perpendicular to the source line, in pixels. If scale is `None`, or not provided, no sketch filter will be provided.

length : float, optional

The length of the wiggle along the line, in pixels (default 128.0)

randomness : float, optional

The scale factor by which the length is shrunken or expanded (default 16.0)

set_snap(*snap*)

Sets the snap setting which may be:

- True: snap vertices to the nearest pixel center
- False: leave vertices as-is
- None: (auto) If the path contains only rectilinear line segments, round to the nearest pixel center

Only supported by the Agg and MacOSX backends.

set_transform(*t*)

Set the *Transform* instance used by this artist.

ACCEPTS: *Transform* instance

set_url(*url*)

Sets the url for the artist

ACCEPTS: a url string

set_urls(*urls*)

set_verts(*segments*)

set_visible(*b*)

Set the artist's visibility.

ACCEPTS: [True | False]

set_zorder(*level*)

Set the zorder for the artist. Artists with lower zorder values are drawn first.

ACCEPTS: any number

stale

If the artist is 'stale' and needs to be re-drawn for the output to match the internal state of the artist.

sticky_edges

x and y sticky edge lists.

When performing autoscaling, if a data limit coincides with a value in the corresponding `sticky_edges` list, then no margin will be added—the view limit “sticks” to the edge. A typical usecase is histograms, where one usually expects no margin on the bottom edge (0) of the histogram.

This attribute cannot be assigned to; however, the `x` and `y` lists can be modified in place as needed.

Examples

```
>>> artist.sticky_edges.x[:] = (xmin, xmax)
>>> artist.sticky_edges.y[:] = (ymin, ymax)
```

switch_orientation()

switch the orientation of the event line, either from vertical to horizontal or vice versus

to_rgba(*x*, *alpha=None*, *bytes=False*, *norm=True*)

Return a normalized rgba array corresponding to *x*.

In the normal case, *x* is a 1-D or 2-D sequence of scalars, and the corresponding ndarray of rgba values will be returned, based on the `norm` and `colormap` set for this `ScalarMappable`.

There is one special case, for handling images that are already rgb or rgba, such as might have been read from an image file. If *x* is an ndarray with 3 dimensions, and the last dimension is either 3 or 4, then it will be treated as an rgb or rgba array, and no mapping will be done. If the last dimension is 3, the *alpha* kwarg (defaulting to 1) will be used to fill in the transparency. If the last dimension is 4, the *alpha* kwarg is ignored; it does not replace the pre-existing alpha. A `ValueError` will be raised if the third dimension is other than 3 or 4.

In either case, if *bytes* is `False` (default), the rgba array will be floats in the 0-1 range; if it is `True`, the returned rgba array will be `uint8` in the 0 to 255 range.

If *norm* is `False`, no normalization of the input data is performed, and it is assumed to already be in the range (0-1).

Note: this method assumes the input is well-behaved; it does not check for anomalies such as *x* being a masked rgba array, or being an integer type other than `uint8`, or being a floating point rgba array with values outside the 0-1 range.

update(*props*)

Update the properties of this `Artist` from the dictionary *prop*.

update_from(*other*)

copy properties from *other* to self

update_scalarmappable()

If the scalar mappable array is not `none`, update colors from scalar data

zorder = 0

```
class matplotlib.collections.LineCollection(segments, linewidths=None, colors=None,
                                           antialiaseds=None, linestyles='solid', offsets=None,
                                           transOffset=None, norm=None, cmap=None,
                                           pickradius=5, zorder=2, facecolors='none',
                                           **kwargs)
```

Bases: `matplotlib.collections.Collection`

All parameters must be sequences or scalars; if scalars, they will be converted to sequences. The property of the *i*th line segment is:

```
prop[i % len(props)]
```

i.e., the properties cycle if the `len` of props is less than the number of segments.

segments a sequence of (*line0*, *line1*, *line2*), where:

```
linen = (x0, y0), (x1, y1), ... (xm, ym)
```

or the equivalent numpy array with two columns. Each line can be a different length.

colors must be a sequence of RGBA tuples (e.g., arbitrary color strings, etc, not allowed).

antialiaseds must be a sequence of ones or zeros

linestyles ['solid' | 'dashed' | 'dashdot' | 'dotted'] a string or dash tuple. The dash tuple is:

```
(offset, onoffseq),
```

where *onoffseq* is an even length tuple of on and off ink in points.

If *linewidths*, *colors*, or *antialiaseds* is None, they default to their rcParams setting, in sequence form.

If *offsets* and *transOffset* are not None, then *offsets* are transformed by *transOffset* and applied after the segments have been transformed to display coordinates.

If *offsets* is not None but *transOffset* is None, then the *offsets* are added to the segments before any transformation. In this case, a single offset can be specified as:

```
offsets=(xo,yo)
```

and this value will be added cumulatively to each successive segment, so as to produce a set of successively offset curves.

norm None (optional for `matplotlib.cm.ScalarMappable`)

cmap None (optional for `matplotlib.cm.ScalarMappable`)

pickradius is the tolerance for mouse clicks picking a line. The default is 5 pt.

zorder The zorder of the LineCollection. Default is 2

facecolors The facecolors of the LineCollection. Default is 'none' Setting to a value other than 'none' will lead to a filled polygon being drawn between points on each line.

The use of `ScalarMappable` is optional. If the `ScalarMappable` array `_A` is not None (i.e., a call to `set_array()` has been made), at draw time a call to scalar mappable will be made to set the colors.

add_callback(*func*)

Adds a callback function that will be called whenever one of the `Artist`'s properties changes.

Returns an *id* that is useful for removing the callback with `remove_callback()` later.

add_checker(*checker*)

Add an entry to a dictionary of boolean flags that are set to True when the mappable is changed.

aname = 'Artist'

autoscale()

Autoscale the scalar limits on the norm instance using the current array

autoscale_None()

Autoscale the scalar limits on the norm instance using the current array, changing only limits that are None

axes

The `Axes` instance the artist resides in, or `None`.

changed()

Call this whenever the mappable is changed to notify all the callbackSM listeners to the 'changed' signal

check_update(*checker*)

If mappable has changed since the last check, return True; else return False

contains(*mouseevent*)

Test whether the mouse event occurred in the collection.

Returns True | False, `dict(ind=itemlist)`, where every item in itemlist contains the event.

convert_xunits(*x*)

For artists in an axes, if the xaxis has units support, convert *x* using xaxis unit type

convert_yunits(*y*)

For artists in an axes, if the yaxis has units support, convert *y* using yaxis unit type

draw(*artist*, *renderer*, **args*, ***kwargs*)

findobj(*match=None*, *include_self=True*)

Find artist objects.

Recursively find all `Artist` instances contained in self.

match can be

- None: return all objects contained in artist.
- function with signature `boolean = match(artist)` used to filter matches
- class instance: e.g., `Line2D`. Only return artists of class type.

If *include_self* is True (default), include self in the list to be checked for a match.

format_cursor_data(*data*)

Return *cursor data* string formatted.

get_agg_filter()

return filter function to be used for agg filter

get_alpha()

Return the alpha value used for blending - not supported on all backends

get_animated()

Return the artist's animated state

get_array()

Return the array

get_axes()

Return the [Axes](#) instance the artist resides in, or *None*.

This has been deprecated in mpl 1.5, please use the axes property. Will be removed in 1.7 or 2.0.

get_children()

Return a list of the child Artist's `this :class:`Artist` contains.

get_clim()

return the min, max of the color limits for image scaling

get_clip_box()

Return artist clipbox

get_clip_on()

Return whether artist uses clipping

get_clip_path()

Return artist clip path

get_cmap()

return the colormap

get_color()

get_colors()

get_contains()

Return the `_contains` test used by the artist, or *None* for default.

get_cursor_data(*event*)

Get the cursor data for a given event.

get_dashes()

get_datalim(*transData*)

get_edgecolor()

get_edgecolors()

get_facecolor()

get_facecolors()

get_figure()

Return the *Figure* instance the artist belongs to.

get_fill()

return whether fill is set

get_gid()

Returns the group id

get_hatch()

Return the current hatching pattern

get_label()

Get the label used for this artist in the legend.

get_linestyle()

get_linestyles()

get_linewidth()

get_linewidths()

get_offset_position()

Returns how offsets are applied for the collection. If *offset_position* is 'screen', the offset is applied after the master transform has been applied, that is, the offsets are in screen coordinates. If *offset_position* is 'data', the offset is applied before the master transform, i.e., the offsets are in data coordinates.

get_offset_transform()

get_offsets()

Return the offsets for the collection.

get_path_effects()

get_paths()

get_picker()

Return the picker object used by this artist

get_pickradius()**get_rasterized()**

return True if the artist is to be rasterized

get_segments()**get_sketch_params()**

Returns the sketch parameters for the artist.

Returns sketch_params : tuple or None

A 3-tuple with the following elements:

- scale**: The amplitude of the wiggle perpendicular to the source line.
- length**: The length of the wiggle along the line.
- randomness**: The scale factor by which the length is shrunk or expanded.

May return None if no sketch parameters were set.

get_snap()

Returns the snap setting which may be:

- True**: snap vertices to the nearest pixel center
- False**: leave vertices as-is
- None**: (auto) If the path contains only rectilinear line segments, round to the nearest pixel center

Only supported by the Agg and MacOSX backends.

get_transform()

Return the *Transform* instance used by this artist.

get_transformed_clip_path_and_affine()

Return the clip path with the non-affine part of its transformation applied, and the remaining affine part of its transformation.

get_transforms()**get_url()**

Returns the url

get_urls()**get_visible()**

Return the artist's visibility

get_window_extent(*renderer*)

get_zorder()

Return the Artist's zorder.

have_units()

Return *True* if units are set on the *x* or *y* axes

hitlist(*event*)

List the children of the artist which contain the mouse event *event*.

is_figure_set()

Returns *True* if the artist is assigned to a *Figure*.

is_transform_set()

Returns *True* if Artist has a transform explicitly set.

mouseover

pchanged()

Fire an event when property changed, calling all of the registered callbacks.

pick(*mouseevent*)

Process pick event

each child artist will fire a pick event if *mouseevent* is over the artist and the artist has picker set

pickable()

Return *True* if Artist is pickable.

properties()

return a dictionary mapping property name -> value for all Artist props

remove()

Remove the artist from the figure if possible. The effect will not be visible until the figure is redrawn, e.g., with `matplotlib.axes.Axes.draw_idle()`. Call `matplotlib.axes.Axes.relim()` to update the axes limits if desired.

Note: `relim()` will not see collections even if the collection was added to axes with `autolim = True`.

Note: there is no support for removing the artist's legend entry.

remove_callback(*oid*)

Remove a callback based on its *id*.

See also:

[`add_callback\(\)`](#) For adding callbacks

set(***kwargs*)

A property batch setter. Pass *kwargs* to set properties.

set_agg_filter(*filter_func*)
set agg_filter fuction.

set_alpha(*alpha*)
Set the alpha tranparencies of the collection. *alpha* must be a float or *None*.
ACCEPTS: float or None

set_animated(*b*)
Set the artist's animation state.
ACCEPTS: [True | False]

set_antialiased(*aa*)
Set the antialiasing state for rendering.
ACCEPTS: Boolean or sequence of booleans

set_antialiaseds(*aa*)
alias for set_antialiased

set_array(*A*)
Set the image array from numpy array *A*

set_axes(*axes*)
Set the *Axes* instance in which the artist resides, if any.
This has been deprecated in mpl 1.5, please use the axes property. Will be removed in 1.7 or 2.0.
ACCEPTS: an *Axes* instance

set_clim(*vmin=None, vmax=None*)
set the norm limits for image scaling; if *vmin* is a length2 sequence, interpret it as (*vmin*, *vmax*) which is used to support setp
ACCEPTS: a length 2 sequence of floats

set_clip_box(*clipbox*)
Set the artist's clip *Bbox*.
ACCEPTS: a *matplotlib.transforms.Bbox* instance

set_clip_on(*b*)
Set whether artist uses clipping.
When False artists will be visible out side of the axes which can lead to unexpected results.
ACCEPTS: [True | False]

set_clip_path(*path, transform=None*)
Set the artist's clip path, which may be:

- a *Patch* (or subclass) instance
- a *Path* instance, in which case an optional *Transform* instance may be provided, which will be applied to the path before using it for clipping.
- *None*, to remove the clipping path

For efficiency, if the path happens to be an axis-aligned rectangle, this method will set the clipping box to the corresponding rectangle and set the clipping path to *None*.

ACCEPTS: [(*Path*, *Transform*) | *Patch* | *None*]

set_cmap(*cmap*)

set the colormap for luminance data

ACCEPTS: a colormap or registered colormap name

set_color(*c*)

Set the color(s) of the line collection. *c* can be a matplotlib color arg (all patches have same color), or a sequence or rgba tuples; if it is a sequence the patches will cycle through the sequence.

ACCEPTS: matplotlib color arg or sequence of rgba tuples

set_contains(*picker*)

Replace the contains test used by this artist. The new picker should be a callable function which determines whether the artist is hit by the mouse event:

```
hit, props = picker(artist, mouseevent)
```

If the mouse event is over the artist, return *hit = True* and *props* is a dictionary of properties you want returned with the contains test.

ACCEPTS: a callable function

set_dashes(*ls*)

alias for `set_linestyle`

set_edgecolor(*c*)

Set the edgecolor(s) of the collection. *c* can be a matplotlib color spec (all patches have same color), or a sequence of specs; if it is a sequence the patches will cycle through the sequence.

If *c* is 'face', the edge color will always be the same as the face color. If it is 'none', the patch boundary will not be drawn.

ACCEPTS: matplotlib color spec or sequence of specs

set_edgecolors(*c*)

alias for `set_edgecolor`

set_facecolor(*c*)

Set the facecolor(s) of the collection. *c* can be a matplotlib color spec (all patches have same color), or a sequence of specs; if it is a sequence the patches will cycle through the sequence.

If *c* is 'none', the patch will not be filled.

ACCEPTS: matplotlib color spec or sequence of specs

set_facecolors(*c*)

alias for `set_facecolor`

set_figure(*fig*)

Set the *Figure* instance the artist belongs to.

ACCEPTS: a `matplotlib.figure.Figure` instance

set_gid(*gid*)

Sets the (group) id for the artist

ACCEPTS: an id string

set_hatch(*hatch*)

Set the hatching pattern

hatch can be one of:

/	- diagonal hatching
\	- back diagonal
	- vertical
-	- horizontal
+	- crossed
x	- crossed diagonal
o	- small circle
O	- large circle
.	- dots
*	- stars

Letters can be combined, in which case all the specified hatchings are done. If same letter repeats, it increases the density of hatching of that pattern.

Hatching is supported in the PostScript, PDF, SVG and Agg backends only.

Unlike other properties such as linewidth and colors, hatching can only be specified for the collection as a whole, not separately for each member.

ACCEPTS: ['/' | '\' | '|' | '-' | '+' | 'x' | 'o' | 'O' | '.' | '*']

set_label(*s*)

Set the label to *s* for auto legend.

ACCEPTS: string or anything printable with '%s' conversion.

set_linestyle(*ls*)

Set the linestyle(s) for the collection.

linestyle	description
'-' or 'solid'	solid line
'--' or 'dashed'	dashed line
'-.' or 'dashdot'	dash-dotted line
':' or 'dotted'	dotted line

Alternatively a dash tuple of the following form can be provided:

```
(offset, onoffseq),
```

where *onoffseq* is an even length tuple of on and off ink in points.

ACCEPTS: ['solid' | 'dashed', 'dashdot', 'dotted' | (offset, on-off-dash-seq) | '-' | '--' | '-.' | ':' | 'None' | ' ' | '']

Parameters *ls* : { '-', '-.', ':', ':' } and more see description

The line style.

set_linestyles(*ls*)

alias for set_linestyle

set_linewidth(*lw*)

Set the linewidth(s) for the collection. *lw* can be a scalar or a sequence; if it is a sequence the patches will cycle through the sequence

ACCEPTS: float or sequence of floats

set_linewidths(*lw*)

alias for set_linewidth

set_lw(*lw*)

alias for set_linewidth

set_norm(*norm*)

set the normalization instance

set_offset_position(*offset_position*)

Set how offsets are applied. If *offset_position* is 'screen' (default) the offset is applied after the master transform has been applied, that is, the offsets are in screen coordinates. If *offset_position* is 'data', the offset is applied before the master transform, i.e., the offsets are in data coordinates.

set_offsets(*offsets*)

Set the offsets for the collection. *offsets* can be a scalar or a sequence.

ACCEPTS: float or sequence of floats

set_path_effects(*path_effects*)

set *path_effects*, which should be a list of instances of matplotlib.patheffect._Base class or its derivatives.

set_paths(*segments*)

set_picker(*picker*)

Set the epsilon for picking used by this artist

picker can be one of the following:

- *None*: picking is disabled for this artist (default)
- A boolean: if *True* then picking will be enabled and the artist will fire a pick event if the mouse event is over the artist
- A float: if *picker* is a number it is interpreted as an epsilon tolerance in points and the artist will fire off an event if it's data is within epsilon of the mouse event. For some artists like lines and patch collections, the artist may provide additional data to the pick event that is generated, e.g., the indices of the data within epsilon of the pick event

- A function: if picker is callable, it is a user supplied function which determines whether the artist is hit by the mouse event:

```
hit, props = picker(artist, mouseevent)
```

to determine the hit test. if the mouse event is over the artist, return *hit=True* and props is a dictionary of properties you want added to the PickEvent attributes.

ACCEPTS: [None|float|boolean|callable]

set_pickradius(*pr*)

set_rasterized(*rasterized*)

Force rasterized (bitmap) drawing in vector backend output.

Defaults to None, which implies the backend's default behavior

ACCEPTS: [True | False | None]

set_segments(*segments*)

set_sketch_params(*scale=None, length=None, randomness=None*)

Sets the sketch parameters.

Parameters scale : float, optional

The amplitude of the wiggle perpendicular to the source line, in pixels. If scale is None, or not provided, no sketch filter will be provided.

length : float, optional

The length of the wiggle along the line, in pixels (default 128.0)

randomness : float, optional

The scale factor by which the length is shrunken or expanded (default 16.0)

set_snap(*snap*)

Sets the snap setting which may be:

- True: snap vertices to the nearest pixel center
- False: leave vertices as-is
- None: (auto) If the path contains only rectilinear line segments, round to the nearest pixel center

Only supported by the Agg and MacOSX backends.

set_transform(*t*)

Set the *Transform* instance used by this artist.

ACCEPTS: *Transform* instance

set_url(*url*)

Sets the url for the artist

ACCEPTS: a url string

set_urls(*urls*)

set_verts(*segments*)

set_visible(*b*)

Set the artist's visibility.

ACCEPTS: [True | False]

set_zorder(*level*)

Set the zorder for the artist. Artists with lower zorder values are drawn first.

ACCEPTS: any number

stale

If the artist is 'stale' and needs to be re-drawn for the output to match the internal state of the artist.

sticky_edges

x and y sticky edge lists.

When performing autoscaling, if a data limit coincides with a value in the corresponding `sticky_edges` list, then no margin will be added—the view limit “sticks” to the edge. A typical usecase is histograms, where one usually expects no margin on the bottom edge (0) of the histogram.

This attribute cannot be assigned to; however, the x and y lists can be modified in place as needed.

Examples

```
>>> artist.sticky_edges.x[:] = (xmin, xmax)
>>> artist.sticky_edges.y[:] = (ymin, ymax)
```

to_rgba(*x*, *alpha=None*, *bytes=False*, *norm=True*)

Return a normalized rgba array corresponding to *x*.

In the normal case, *x* is a 1-D or 2-D sequence of scalars, and the corresponding ndarray of rgba values will be returned, based on the norm and colormap set for this `ScalarMappable`.

There is one special case, for handling images that are already rgb or rgba, such as might have been read from an image file. If *x* is an ndarray with 3 dimensions, and the last dimension is either 3 or 4, then it will be treated as an rgb or rgba array, and no mapping will be done. If the last dimension is 3, the *alpha* kwarg (defaulting to 1) will be used to fill in the transparency. If the last dimension is 4, the *alpha* kwarg is ignored; it does not replace the pre-existing alpha. A `ValueError` will be raised if the third dimension is other than 3 or 4.

In either case, if *bytes* is `False` (default), the rgba array will be floats in the 0-1 range; if it is `True`, the returned rgba array will be uint8 in the 0 to 255 range.

If `norm` is `False`, no normalization of the input data is performed, and it is assumed to already be in the range (0-1).

Note: this method assumes the input is well-behaved; it does not check for anomalies such as `x` being a masked `rgba` array, or being an integer type other than `uint8`, or being a floating point `rgba` array with values outside the 0-1 range.

update(*props*)

Update the properties of this `Artist` from the dictionary *prop*.

update_from(*other*)

copy properties from *other* to self

update_scalarmappable()

If the scalar mappable array is not `None`, update colors from scalar data

zorder = 0

class `matplotlib.collections.PatchCollection`(*patches*, *match_original=False*, ***kwargs*)

Bases: `matplotlib.collections.Collection`

A generic collection of patches.

This makes it easier to assign a color map to a heterogeneous collection of patches.

This also may improve plotting speed, since `PatchCollection` will draw faster than a large number of patches.

patches a sequence of `Patch` objects. This list may include a heterogeneous assortment of different patch types.

match_original If `True`, use the colors and linewidths of the original patches. If `False`, new colors may be assigned by providing the standard collection arguments, `facecolor`, `edgecolor`, `linewidths`, `norm` or `cmap`.

If any of *edgecolors*, *facecolors*, *linewidths*, *antialiaseds* are `None`, they default to their `matplotlib.rcParams` patch setting, in sequence form.

The use of `ScalarMappable` is optional. If the `ScalarMappable` matrix `_A` is not `None` (i.e., a call to `set_array` has been made), at draw time a call to scalar mappable will be made to set the face colors.

add_callback(*func*)

Adds a callback function that will be called whenever one of the `Artist`'s properties changes.

Returns an *id* that is useful for removing the callback with `remove_callback()` later.

add_checker(*checker*)

Add an entry to a dictionary of boolean flags that are set to `True` when the mappable is changed.

aname = 'Artist'

autoscale()

Autoscale the scalar limits on the `norm` instance using the current array

autoscale_None()

Autoscale the scalar limits on the norm instance using the current array, changing only limits that are None

axes

The *Axes* instance the artist resides in, or *None*.

changed()

Call this whenever the mappable is changed to notify all the callbackSM listeners to the 'changed' signal

check_update(*checker*)

If mappable has changed since the last check, return True; else return False

contains(*mouseevent*)

Test whether the mouse event occurred in the collection.

Returns True | False, dict(ind=itemlist), where every item in itemlist contains the event.

convert_xunits(*x*)

For artists in an axes, if the xaxis has units support, convert *x* using xaxis unit type

convert_yunits(*y*)

For artists in an axes, if the yaxis has units support, convert *y* using yaxis unit type

draw(*artist*, *renderer*, **args*, *kwargs*)****findobj(*match=None*, *include_self=True*)**

Find artist objects.

Recursively find all *Artist* instances contained in self.

match can be

- None: return all objects contained in artist.
- function with signature `boolean = match(artist)` used to filter matches
- class instance: e.g., `Line2D`. Only return artists of class type.

If *include_self* is True (default), include self in the list to be checked for a match.

format_cursor_data(*data*)

Return *cursor data* string formatted.

get_agg_filter()

return filter function to be used for agg filter

get_alpha()

Return the alpha value used for blending - not supported on all backends

get_animated()

Return the artist's animated state

get_array()

Return the array

get_axes()

Return the [Axes](#) instance the artist resides in, or *None*.

This has been deprecated in mpl 1.5, please use the axes property. Will be removed in 1.7 or 2.0.

get_children()

Return a list of the child `Artist`'s `this :class:`Artist` contains.

get_clim()

return the min, max of the color limits for image scaling

get_clip_box()

Return artist clipbox

get_clip_on()

Return whether artist uses clipping

get_clip_path()

Return artist clip path

get_cmap()

return the colormap

get_contains()

Return the `_contains` test used by the artist, or *None* for default.

get_cursor_data(event)

Get the cursor data for a given event.

get_dashes()**get_datalim(transData)****get_edgecolor()****get_edgecolors()****get_facecolor()****get_facecolors()****get_figure()**

Return the [Figure](#) instance the artist belongs to.

get_fill()

return whether fill is set

get_gid()

Returns the group id

get_hatch()

Return the current hatching pattern

get_label()

Get the label used for this artist in the legend.

get_linestyle()

get_linestyles()

get_linewidth()

get_linewidths()

get_offset_position()

Returns how offsets are applied for the collection. If *offset_position* is 'screen', the offset is applied after the master transform has been applied, that is, the offsets are in screen coordinates. If *offset_position* is 'data', the offset is applied before the master transform, i.e., the offsets are in data coordinates.

get_offset_transform()

get_offsets()

Return the offsets for the collection.

get_path_effects()

get_paths()

get_picker()

Return the picker object used by this artist

get_pickradius()

get_rasterized()

return True if the artist is to be rasterized

get_sketch_params()

Returns the sketch parameters for the artist.

Returns sketch_params : tuple or None

A 3-tuple with the following elements:

- scale: The amplitude of the wiggle perpendicular to the source line.
- length: The length of the wiggle along the line.
- randomness: The scale factor by which the length is shrunken or expanded.

May return `None` if no sketch parameters were set.

get_snap()

Returns the snap setting which may be:

- True: snap vertices to the nearest pixel center
- False: leave vertices as-is
- None: (auto) If the path contains only rectilinear line segments, round to the nearest pixel center

Only supported by the Agg and MacOSX backends.

get_transform()

Return the *Transform* instance used by this artist.

get_transformed_clip_path_and_affine()

Return the clip path with the non-affine part of its transformation applied, and the remaining affine part of its transformation.

get_transforms()**get_url()**

Returns the url

get_urls()**get_visible()**

Return the artist's visibility

get_window_extent(renderer)**get_zorder()**

Return the Artist's zorder.

have_units()

Return *True* if units are set on the *x* or *y* axes

hitlist(event)

List the children of the artist which contain the mouse event *event*.

is_figure_set()

Returns *True* if the artist is assigned to a *Figure*.

is_transform_set()

Returns *True* if Artist has a transform explicitly set.

mouseover**pchanged()**

Fire an event when property changed, calling all of the registered callbacks.

pick(*mouseevent*)

Process pick event

each child artist will fire a pick event if *mouseevent* is over the artist and the artist has picker set

pickable()

Return *True* if Artist is pickable.

properties()

return a dictionary mapping property name -> value for all Artist props

remove()

Remove the artist from the figure if possible. The effect will not be visible until the figure is redrawn, e.g., with `matplotlib.axes.Axes.draw_idle()`. Call `matplotlib.axes.Axes.relim()` to update the axes limits if desired.

Note: `relim()` will not see collections even if the collection was added to axes with `autolim = True`.

Note: there is no support for removing the artist's legend entry.

remove_callback(*oid*)

Remove a callback based on its *id*.

See also:

[`add_callback\(\)`](#) For adding callbacks

set(***kwargs*)

A property batch setter. Pass *kwargs* to set properties.

set_agg_filter(*filter_func*)

set `agg_filter` fuction.

set_alpha(*alpha*)

Set the alpha tranparencies of the collection. *alpha* must be a float or *None*.

ACCEPTS: float or None

set_animated(*b*)

Set the artist's animation state.

ACCEPTS: [True | False]

set_antialiased(*aa*)

Set the antialiasing state for rendering.

ACCEPTS: Boolean or sequence of booleans

set_antialiaseds(*aa*)

alias for `set_antialiased`

set_array(*A*)

Set the image array from numpy array *A*

set_axes(*axes*)

Set the *Axes* instance in which the artist resides, if any.

This has been deprecated in mpl 1.5, please use the axes property. Will be removed in 1.7 or 2.0.

ACCEPTS: an *Axes* instance

set_clim(*vmin=None, vmax=None*)

set the norm limits for image scaling; if *vmin* is a length2 sequence, interpret it as (*vmin*, *vmax*) which is used to support setp

ACCEPTS: a length 2 sequence of floats

set_clip_box(*clipbox*)

Set the artist's clip *Bbox*.

ACCEPTS: a *matplotlib.transforms.Bbox* instance

set_clip_on(*b*)

Set whether artist uses clipping.

When False artists will be visible out side of the axes which can lead to unexpected results.

ACCEPTS: [True | False]

set_clip_path(*path, transform=None*)

Set the artist's clip path, which may be:

- a *Patch* (or subclass) instance
- a *Path* instance, in which case an optional *Transform* instance may be provided, which will be applied to the path before using it for clipping.
- *None*, to remove the clipping path

For efficiency, if the path happens to be an axis-aligned rectangle, this method will set the clipping box to the corresponding rectangle and set the clipping path to *None*.

ACCEPTS: [(*Path, Transform*) | *Patch* | None]

set_cmap(*cmap*)

set the colormap for luminance data

ACCEPTS: a colormap or registered colormap name

set_color(*c*)

Set both the edgecolor and the facecolor.

ACCEPTS: matplotlib color arg or sequence of rgba tuples

See also:

[*set_facecolor\(\)*](#), [*set_edgecolor\(\)*](#) For setting the edge or face color individually.

set_contains(*picker*)

Replace the contains test used by this artist. The new picker should be a callable function which determines whether the artist is hit by the mouse event:

```
hit, props = picker(artist, mouseevent)
```

If the mouse event is over the artist, return *hit = True* and *props* is a dictionary of properties you want returned with the contains test.

ACCEPTS: a callable function

set_dashes(*ls*)

alias for set_linestyle

set_edgecolor(*c*)

Set the edgecolor(s) of the collection. *c* can be a matplotlib color spec (all patches have same color), or a sequence of specs; if it is a sequence the patches will cycle through the sequence.

If *c* is 'face', the edge color will always be the same as the face color. If it is 'none', the patch boundary will not be drawn.

ACCEPTS: matplotlib color spec or sequence of specs

set_edgecolors(*c*)

alias for set_edgecolor

set_facecolor(*c*)

Set the facecolor(s) of the collection. *c* can be a matplotlib color spec (all patches have same color), or a sequence of specs; if it is a sequence the patches will cycle through the sequence.

If *c* is 'none', the patch will not be filled.

ACCEPTS: matplotlib color spec or sequence of specs

set_facecolors(*c*)

alias for set_facecolor

set_figure(*fig*)

Set the *Figure* instance the artist belongs to.

ACCEPTS: a *matplotlib.figure.Figure* instance

set_gid(*gid*)

Sets the (group) id for the artist

ACCEPTS: an id string

set_hatch(*hatch*)

Set the hatching pattern

hatch can be one of:

```
/ - diagonal hatching
\ - back diagonal
| - vertical
- - horizontal
+ - crossed
x - crossed diagonal
o - small circle
O - large circle
```

.	- dots
*	- stars

Letters can be combined, in which case all the specified hatchings are done. If same letter repeats, it increases the density of hatching of that pattern.

Hatching is supported in the PostScript, PDF, SVG and Agg backends only.

Unlike other properties such as linewidth and colors, hatching can only be specified for the collection as a whole, not separately for each member.

ACCEPTS: ['/' | '\' | '|' | '-' | '+' | 'x' | 'o' | 'O' | ':' | '*']

set_label(*s*)

Set the label to *s* for auto legend.

ACCEPTS: string or anything printable with '%s' conversion.

set_linestyle(*ls*)

Set the linestyle(s) for the collection.

linestyle	description
'-' or 'solid'	solid line
'--' or 'dashed'	dashed line
'-.' or 'dashdot'	dash-dotted line
':' or 'dotted'	dotted line

Alternatively a dash tuple of the following form can be provided:

(offset, onoffseq),

where onoffseq is an even length tuple of on and off ink in points.

ACCEPTS: ['solid' | 'dashed', 'dashdot', 'dotted' | (offset, on-off-dash-seq) | '-' | '--' | '-.' | ':' | 'None' | ' ' | '']

Parameters *ls* : { '-', '-.', '-.', ':' } and more see description

The line style.

set_linestyles(*ls*)

alias for set_linestyle

set_linewidth(*lw*)

Set the linewidth(s) for the collection. *lw* can be a scalar or a sequence; if it is a sequence the patches will cycle through the sequence

ACCEPTS: float or sequence of floats

set_linewidths(*lw*)

alias for set_linewidth

set_lw(*lw*)

alias for set_linewidth

set_norm(*norm*)

set the normalization instance

set_offset_position(*offset_position*)

Set how offsets are applied. If *offset_position* is 'screen' (default) the offset is applied after the master transform has been applied, that is, the offsets are in screen coordinates. If *offset_position* is 'data', the offset is applied before the master transform, i.e., the offsets are in data coordinates.

set_offsets(*offsets*)

Set the offsets for the collection. *offsets* can be a scalar or a sequence.

ACCEPTS: float or sequence of floats

set_path_effects(*path_effects*)

set *path_effects*, which should be a list of instances of `matplotlib.patheffect._Base` class or its derivatives.

set_paths(*patches*)

set_picker(*picker*)

Set the epsilon for picking used by this artist

picker can be one of the following:

- *None*: picking is disabled for this artist (default)
- A boolean: if *True* then picking will be enabled and the artist will fire a pick event if the mouse event is over the artist
- A float: if *picker* is a number it is interpreted as an epsilon tolerance in points and the artist will fire off an event if it's data is within epsilon of the mouse event. For some artists like lines and patch collections, the artist may provide additional data to the pick event that is generated, e.g., the indices of the data within epsilon of the pick event
- A function: if *picker* is callable, it is a user supplied function which determines whether the artist is hit by the mouse event:

```
hit, props = picker(artist, mouseevent)
```

to determine the hit test. if the mouse event is over the artist, return *hit=True* and *props* is a dictionary of properties you want added to the `PickEvent` attributes.

ACCEPTS: [None|float|boolean|callable]

set_pickradius(*pr*)

set_rasterized(*rasterized*)

Force rasterized (bitmap) drawing in vector backend output.

Defaults to *None*, which implies the backend's default behavior

ACCEPTS: [True | False | None]

set_sketch_params(*scale=None, length=None, randomness=None*)

Sets the sketch parameters.

Parameters *scale* : float, optional

The amplitude of the wiggle perpendicular to the source line, in pixels. If *scale* is `None`, or not provided, no sketch filter will be provided.

length : float, optional

The length of the wiggle along the line, in pixels (default 128.0)

randomness : float, optional

The scale factor by which the length is shrunken or expanded (default 16.0)

set_snap(*snap*)

Sets the snap setting which may be:

- True: snap vertices to the nearest pixel center
- False: leave vertices as-is
- None: (auto) If the path contains only rectilinear line segments, round to the nearest pixel center

Only supported by the Agg and MacOSX backends.

set_transform(*t*)

Set the *Transform* instance used by this artist.

ACCEPTS: *Transform* instance

set_url(*url*)

Sets the url for the artist

ACCEPTS: a url string

set_urls(*urls*)

set_visible(*b*)

Set the artist's visibility.

ACCEPTS: [True | False]

set_zorder(*level*)

Set the zorder for the artist. Artists with lower zorder values are drawn first.

ACCEPTS: any number

stale

If the artist is 'stale' and needs to be re-drawn for the output to match the internal state of the artist.

sticky_edges

x and y sticky edge lists.

When performing autoscaling, if a data limit coincides with a value in the corresponding `sticky_edges` list, then no margin will be added—the view limit “sticks” to the edge. A typical usecase is histograms, where one usually expects no margin on the bottom edge (0) of the histogram.

This attribute cannot be assigned to; however, the `x` and `y` lists can be modified in place as needed.

Examples

```
>>> artist.sticky_edges.x[:] = (xmin, xmax)
>>> artist.sticky_edges.y[:] = (ymin, ymax)
```

to_rgba(*x*, *alpha=None*, *bytes=False*, *norm=True*)

Return a normalized rgba array corresponding to *x*.

In the normal case, *x* is a 1-D or 2-D sequence of scalars, and the corresponding ndarray of rgba values will be returned, based on the `norm` and `colormap` set for this `ScalarMappable`.

There is one special case, for handling images that are already `rgb` or `rgba`, such as might have been read from an image file. If *x* is an ndarray with 3 dimensions, and the last dimension is either 3 or 4, then it will be treated as an `rgb` or `rgba` array, and no mapping will be done. If the last dimension is 3, the *alpha* kwarg (defaulting to 1) will be used to fill in the transparency. If the last dimension is 4, the *alpha* kwarg is ignored; it does not replace the pre-existing alpha. A `ValueError` will be raised if the third dimension is other than 3 or 4.

In either case, if *bytes* is `False` (default), the rgba array will be floats in the 0-1 range; if it is `True`, the returned rgba array will be `uint8` in the 0 to 255 range.

If *norm* is `False`, no normalization of the input data is performed, and it is assumed to already be in the range (0-1).

Note: this method assumes the input is well-behaved; it does not check for anomalies such as *x* being a masked rgba array, or being an integer type other than `uint8`, or being a floating point rgba array with values outside the 0-1 range.

update(*props*)

Update the properties of this `Artist` from the dictionary *prop*.

update_from(*other*)

copy properties from other to self

update_scalarmappable()

If the scalar mappable array is not none, update colors from scalar data

zorder = 0

class `matplotlib.collections.PathCollection`(*paths*, *sizes=None*, ***kwargs*)

Bases: `matplotlib.collections._CollectionWithSizes`

This is the most basic `Collection` subclass.

paths is a sequence of `matplotlib.path.Path` instances.

Valid Collection keyword arguments:

- *edgecolors*: None
- *facecolors*: None
- *linewidths*: None
- *antialiaseds*: None
- *offsets*: None
- *transOffset*: `transforms.IdentityTransform()`
- *norm*: None (optional for `matplotlib.cm.ScalarMappable`)
- *cmap*: None (optional for `matplotlib.cm.ScalarMappable`)

offsets and *transOffset* are used to translate the patch after rendering (default no offsets)

If any of *edgecolors*, *facecolors*, *linewidths*, *antialiaseds* are None, they default to their `matplotlib.rcParams` patch setting, in sequence form.

add_callback(*func*)

Adds a callback function that will be called whenever one of the `Artist`'s properties changes.

Returns an *id* that is useful for removing the callback with `remove_callback()` later.

add_checker(*checker*)

Add an entry to a dictionary of boolean flags that are set to True when the mappable is changed.

aname = 'Artist'

autoscale()

Autoscale the scalar limits on the norm instance using the current array

autoscale_None()

Autoscale the scalar limits on the norm instance using the current array, changing only limits that are None

axes

The `Axes` instance the artist resides in, or `None`.

changed()

Call this whenever the mappable is changed to notify all the callbackSM listeners to the 'changed' signal

check_update(*checker*)

If mappable has changed since the last check, return True; else return False

contains(*mouseevent*)

Test whether the mouse event occurred in the collection.

Returns True | False, `dict(ind=itemlist)`, where every item in itemlist contains the event.

convert_xunits(*x*)

For artists in an axes, if the xaxis has units support, convert *x* using xaxis unit type

convert_yunits(*y*)

For artists in an axes, if the yaxis has units support, convert *y* using yaxis unit type

draw(*artist*, *renderer*, **args*, ***kwargs*)

findobj(*match=None*, *include_self=True*)

Find artist objects.

Recursively find all *Artist* instances contained in self.

match can be

- None: return all objects contained in artist.
- function with signature `boolean = match(artist)` used to filter matches
- class instance: e.g., *Line2D*. Only return artists of class type.

If *include_self* is True (default), include self in the list to be checked for a match.

format_cursor_data(*data*)

Return *cursor data* string formatted.

get_agg_filter()

return filter function to be used for agg filter

get_alpha()

Return the alpha value used for blending - not supported on all backends

get_animated()

Return the artist's animated state

get_array()

Return the array

get_axes()

Return the *Axes* instance the artist resides in, or *None*.

This has been deprecated in mpl 1.5, please use the axes property. Will be removed in 1.7 or 2.0.

get_children()

Return a list of the child *Artist*'s `this :class:`Artist` contains.

get_clim()

return the min, max of the color limits for image scaling

get_clip_box()

Return artist clipbox

get_clip_on()

Return whether artist uses clipping

get_clip_path()

Return artist clip path

get_cmap()
return the colormap

get_contains()
Return the `_contains` test used by the artist, or *None* for default.

get_cursor_data(*event*)
Get the cursor data for a given event.

get_dashes()

get_datalim(*transData*)

get_edgecolor()

get_edgecolors()

get_facecolor()

get_facecolors()

get_figure()
Return the *Figure* instance the artist belongs to.

get_fill()
return whether fill is set

get_gid()
Returns the group id

get_hatch()
Return the current hatching pattern

get_label()
Get the label used for this artist in the legend.

get_linestyle()

get_linestyles()

get_linewidth()

get_linewidths()

get_offset_position()
Returns how offsets are applied for the collection. If *offset_position* is 'screen', the offset is applied after the master transform has been applied, that is, the offsets are in screen coordinates.

If `offset_position` is 'data', the offset is applied before the master transform, i.e., the offsets are in data coordinates.

get_offset_transform()

get_offsets()

Return the offsets for the collection.

get_path_effects()

get_paths()

get_picker()

Return the picker object used by this artist

get_pickradius()

get_rasterized()

return True if the artist is to be rasterized

get_sizes()

Returns the sizes of the elements in the collection. The value represents the 'area' of the element.

Returns sizes : array

The 'area' of each element.

get_sketch_params()

Returns the sketch parameters for the artist.

Returns sketch_params : tuple or None

A 3-tuple with the following elements:

- **scale**: The amplitude of the wiggle perpendicular to the source line.
- **length**: The length of the wiggle along the line.
- **randomness**: The scale factor by which the length is shrunken or expanded.

May return None if no sketch parameters were set.

get_snap()

Returns the snap setting which may be:

- True: snap vertices to the nearest pixel center
- False: leave vertices as-is
- None: (auto) If the path contains only rectilinear line segments, round to the nearest pixel center

Only supported by the Agg and MacOSX backends.

get_transform()

Return the *Transform* instance used by this artist.

get_transformed_clip_path_and_affine()

Return the clip path with the non-affine part of its transformation applied, and the remaining affine part of its transformation.

get_transforms()**get_url()**

Returns the url

get_urls()**get_visible()**

Return the artist's visibility

get_window_extent(renderer)**get_zorder()**

Return the Artist's zorder.

have_units()

Return *True* if units are set on the *x* or *y* axes

hitlist(event)

List the children of the artist which contain the mouse event *event*.

is_figure_set()

Returns *True* if the artist is assigned to a *Figure*.

is_transform_set()

Returns *True* if Artist has a transform explicitly set.

mouseover**pchanged()**

Fire an event when property changed, calling all of the registered callbacks.

pick(mouseevent)

Process pick event

each child artist will fire a pick event if *mouseevent* is over the artist and the artist has picker set

pickable()

Return *True* if Artist is pickable.

properties()

return a dictionary mapping property name -> value for all Artist props

remove()

Remove the artist from the figure if possible. The effect will not be visible until the figure is

redrawn, e.g., with `matplotlib.axes.Axes.draw_idle()`. Call `matplotlib.axes.Axes.relim()` to update the axes limits if desired.

Note: `relim()` will not see collections even if the collection was added to axes with `autolim = True`.

Note: there is no support for removing the artist's legend entry.

remove_callback(*oid*)

Remove a callback based on its *id*.

See also:

[`add_callback\(\)`](#) For adding callbacks

set(*kwargs*)**

A property batch setter. Pass *kwargs* to set properties.

set_agg_filter(*filter_func*)

set `agg_filter` function.

set_alpha(*alpha*)

Set the alpha transparencies of the collection. *alpha* must be a float or *None*.

ACCEPTS: float or None

set_animated(*b*)

Set the artist's animation state.

ACCEPTS: [True | False]

set_antialiased(*aa*)

Set the antialiasing state for rendering.

ACCEPTS: Boolean or sequence of booleans

set_antialiaseds(*aa*)

alias for `set_antialiased`

set_array(*A*)

Set the image array from numpy array *A*

set_axes(*axes*)

Set the [*Axes*](#) instance in which the artist resides, if any.

This has been deprecated in mpl 1.5, please use the `axes` property. Will be removed in 1.7 or 2.0.

ACCEPTS: an [*Axes*](#) instance

set_clim(*vmin=None, vmax=None*)

set the norm limits for image scaling; if *vmin* is a length2 sequence, interpret it as (*vmin*, *vmax*) which is used to support `setp`

ACCEPTS: a length 2 sequence of floats

set_clip_box(*clipbox*)

Set the artist's clip [*Bbox*](#).

ACCEPTS: a `matplotlib.transforms.Bbox` instance

set_clip_on(*b*)

Set whether artist uses clipping.

When False artists will be visible out side of the axes which can lead to unexpected results.

ACCEPTS: [True | False]

set_clip_path(*path*, *transform=None*)

Set the artist's clip path, which may be:

- a `Path` (or subclass) instance
- a `Path` instance, in which case an optional `Transform` instance may be provided, which will be applied to the path before using it for clipping.
- `None`, to remove the clipping path

For efficiency, if the path happens to be an axis-aligned rectangle, this method will set the clipping box to the corresponding rectangle and set the clipping path to `None`.

ACCEPTS: [(`Path`, `Transform`) | `Path` | None]

set_cmap(*cmap*)

set the colormap for luminance data

ACCEPTS: a colormap or registered colormap name

set_color(*c*)

Set both the edgecolor and the facecolor.

ACCEPTS: matplotlib color arg or sequence of rgba tuples

See also:

[`set_facecolor\(\)`](#), [`set_edgecolor\(\)`](#) For setting the edge or face color individually.

set_contains(*picker*)

Replace the contains test used by this artist. The new picker should be a callable function which determines whether the artist is hit by the mouse event:

```
hit, props = picker(artist, mouseevent)
```

If the mouse event is over the artist, return `hit = True` and `props` is a dictionary of properties you want returned with the contains test.

ACCEPTS: a callable function

set_dashes(*ls*)

alias for `set_linestyle`

set_edgecolor(*c*)

Set the edgecolor(s) of the collection. `c` can be a matplotlib color spec (all patches have same color), or a sequence of specs; if it is a sequence the patches will cycle through the sequence.

If *c* is 'face', the edge color will always be the same as the face color. If it is 'none', the patch boundary will not be drawn.

ACCEPTS: matplotlib color spec or sequence of specs

set_edgecolors(*c*)

alias for set_edgecolor

set_facecolor(*c*)

Set the facecolor(s) of the collection. *c* can be a matplotlib color spec (all patches have same color), or a sequence of specs; if it is a sequence the patches will cycle through the sequence.

If *c* is 'none', the patch will not be filled.

ACCEPTS: matplotlib color spec or sequence of specs

set_facecolors(*c*)

alias for set_facecolor

set_figure(*fig*)

Set the *Figure* instance the artist belongs to.

ACCEPTS: a *matplotlib.figure.Figure* instance

set_gid(*gid*)

Sets the (group) id for the artist

ACCEPTS: an id string

set_hatch(*hatch*)

Set the hatching pattern

hatch can be one of:

```
/ - diagonal hatching
\ - back diagonal
| - vertical
- - horizontal
+ - crossed
x - crossed diagonal
o - small circle
O - large circle
. - dots
* - stars
```

Letters can be combined, in which case all the specified hatchings are done. If same letter repeats, it increases the density of hatching of that pattern.

Hatching is supported in the PostScript, PDF, SVG and Agg backends only.

Unlike other properties such as linewidth and colors, hatching can only be specified for the collection as a whole, not separately for each member.

ACCEPTS: ['/' | '\' | '|' | '-' | '+' | 'x' | 'o' | 'O' | '.' | '*']

set_label(*s*)

Set the label to *s* for auto legend.

ACCEPTS: string or anything printable with ‘%s’ conversion.

set_linestyle(*ls*)

Set the linestyle(s) for the collection.

linestyle	description
'-' or 'solid'	solid line
'--' or 'dashed'	dashed line
'-.' or 'dashdot'	dash-dotted line
':' or 'dotted'	dotted line

Alternatively a dash tuple of the following form can be provided:

```
(offset, onoffseq),
```

where *onoffseq* is an even length tuple of on and off ink in points.

ACCEPTS: ['solid' | 'dashed', 'dashdot', 'dotted' | (offset, on-off-dash-seq) | '-' | '--' | '-.' | ':' | 'None' | ' ' | '']

Parameters *ls* : { '-', '-.', ':', ':' } and more see description

The line style.

set_linestyles(*ls*)

alias for `set_linestyle`

set_linewidth(*lw*)

Set the linewidth(s) for the collection. *lw* can be a scalar or a sequence; if it is a sequence the patches will cycle through the sequence

ACCEPTS: float or sequence of floats

set_linewidths(*lw*)

alias for `set_linewidth`

set_lw(*lw*)

alias for `set_linewidth`

set_norm(*norm*)

set the normalization instance

set_offset_position(*offset_position*)

Set how offsets are applied. If *offset_position* is 'screen' (default) the offset is applied after the master transform has been applied, that is, the offsets are in screen coordinates. If *offset_position* is 'data', the offset is applied before the master transform, i.e., the offsets are in data coordinates.

set_offsets(*offsets*)

Set the offsets for the collection. *offsets* can be a scalar or a sequence.

ACCEPTS: float or sequence of floats

set_path_effects(*path_effects*)

set *path_effects*, which should be a list of instances of `matplotlib.patheffect._Base` class or its derivatives.

set_paths(*paths*)**set_picker**(*picker*)

Set the epsilon for picking used by this artist

picker can be one of the following:

- *None*: picking is disabled for this artist (default)
- A boolean: if *True* then picking will be enabled and the artist will fire a pick event if the mouse event is over the artist
- A float: if *picker* is a number it is interpreted as an epsilon tolerance in points and the artist will fire off an event if it's data is within epsilon of the mouse event. For some artists like lines and patch collections, the artist may provide additional data to the pick event that is generated, e.g., the indices of the data within epsilon of the pick event
- A function: if *picker* is callable, it is a user supplied function which determines whether the artist is hit by the mouse event:

```
hit, props = picker(artist, mouseevent)
```

to determine the hit test. if the mouse event is over the artist, return *hit=True* and *props* is a dictionary of properties you want added to the `PickEvent` attributes.

ACCEPTS: [None|float|boolean|callable]

set_pickradius(*pr*)**set_rasterized**(*rasterized*)

Force rasterized (bitmap) drawing in vector backend output.

Defaults to *None*, which implies the backend's default behavior

ACCEPTS: [True | False | None]

set_sizes(*sizes*, *dpi=72.0*)

Set the sizes of each member of the collection.

Parameters *sizes* : ndarray or None

The size to set for each element of the collection. The value is the 'area' of the element.

dpi : float

The dpi of the canvas. Defaults to 72.0.

set_sketch_params(*scale=None*, *length=None*, *randomness=None*)

Sets the sketch parameters.

Parameters scale : float, optional

The amplitude of the wiggle perpendicular to the source line, in pixels. If scale is `None`, or not provided, no sketch filter will be provided.

length : float, optional

The length of the wiggle along the line, in pixels (default 128.0)

randomness : float, optional

The scale factor by which the length is shrunken or expanded (default 16.0)

set_snap(*snap*)

Sets the snap setting which may be:

- True: snap vertices to the nearest pixel center
- False: leave vertices as-is
- None: (auto) If the path contains only rectilinear line segments, round to the nearest pixel center

Only supported by the Agg and MacOSX backends.

set_transform(*t*)

Set the *Transform* instance used by this artist.

ACCEPTS: *Transform* instance

set_url(*url*)

Sets the url for the artist

ACCEPTS: a url string

set_urls(*urls*)

set_visible(*b*)

Set the artist's visibility.

ACCEPTS: [True | False]

set_zorder(*level*)

Set the zorder for the artist. Artists with lower zorder values are drawn first.

ACCEPTS: any number

stale

If the artist is 'stale' and needs to be re-drawn for the output to match the internal state of the artist.

sticky_edges

x and y sticky edge lists.

When performing autoscaling, if a data limit coincides with a value in the corresponding `sticky_edges` list, then no margin will be added—the view limit “sticks” to the edge. A typical usecase is histograms, where one usually expects no margin on the bottom edge (0) of the histogram.

This attribute cannot be assigned to; however, the `x` and `y` lists can be modified in place as needed.

Examples

```
>>> artist.sticky_edges.x[:] = (xmin, xmax)
>>> artist.sticky_edges.y[:] = (ymin, ymax)
```

to_rgba(*x*, *alpha=None*, *bytes=False*, *norm=True*)

Return a normalized rgba array corresponding to *x*.

In the normal case, *x* is a 1-D or 2-D sequence of scalars, and the corresponding ndarray of rgba values will be returned, based on the norm and colormap set for this `ScalarMappable`.

There is one special case, for handling images that are already rgb or rgba, such as might have been read from an image file. If *x* is an ndarray with 3 dimensions, and the last dimension is either 3 or 4, then it will be treated as an rgb or rgba array, and no mapping will be done. If the last dimension is 3, the *alpha* kwarg (defaulting to 1) will be used to fill in the transparency. If the last dimension is 4, the *alpha* kwarg is ignored; it does not replace the pre-existing alpha. A `ValueError` will be raised if the third dimension is other than 3 or 4.

In either case, if *bytes* is `False` (default), the rgba array will be floats in the 0-1 range; if it is `True`, the returned rgba array will be uint8 in the 0 to 255 range.

If *norm* is `False`, no normalization of the input data is performed, and it is assumed to already be in the range (0-1).

Note: this method assumes the input is well-behaved; it does not check for anomalies such as *x* being a masked rgba array, or being an integer type other than uint8, or being a floating point rgba array with values outside the 0-1 range.

update(*props*)

Update the properties of this `Artist` from the dictionary *prop*.

update_from(*other*)

copy properties from other to self

update_scalarmappable()

If the scalar mappable array is not none, update colors from scalar data

zorder = 0

class matplotlib.collections.**PolyCollection**(*verts*, *sizes=None*, *closed=True*, ***kwargs*)

Bases: matplotlib.collections._CollectionWithSizes

verts is a sequence of (*verts0*, *verts1*, ...) where *verts_i* is a sequence of *xy* tuples of vertices, or an equivalent numpy array of shape (*nv*, 2).

sizes is `None` (default) or a sequence of floats that scale the corresponding *verts_i*. The scaling is applied before the Artist master transform; if the latter is an identity transform, then the overall scaling is such that if *verts_i* specify a unit square, then *sizes_i* is the area of that square in points². If $\text{len}(\textit{sizes}) < \textit{nv}$, the additional values will be taken cyclically from the array.

closed, when *True*, will explicitly close the polygon.

Valid Collection keyword arguments:

- *edgecolors*: None
- *facecolors*: None
- *linewidths*: None
- *antialiaseds*: None
- *offsets*: None
- *transOffset*: `transforms.IdentityTransform()`
- *norm*: None (optional for `matplotlib.cm.ScalarMappable`)
- *cmap*: None (optional for `matplotlib.cm.ScalarMappable`)

offsets and *transOffset* are used to translate the patch after rendering (default no offsets)

If any of *edgecolors*, *facecolors*, *linewidths*, *antialiaseds* are None, they default to their `matplotlib.rcParams` patch setting, in sequence form.

add_callback(*func*)

Adds a callback function that will be called whenever one of the `Artist`'s properties changes.

Returns an *id* that is useful for removing the callback with `remove_callback()` later.

add_checker(*checker*)

Add an entry to a dictionary of boolean flags that are set to True when the mappable is changed.

aname = 'Artist'

autoscale()

Autoscale the scalar limits on the norm instance using the current array

autoscale_None()

Autoscale the scalar limits on the norm instance using the current array, changing only limits that are None

axes

The `Axes` instance the artist resides in, or *None*.

changed()

Call this whenever the mappable is changed to notify all the callbackSM listeners to the 'changed' signal

check_update(*checker*)

If mappable has changed since the last check, return True; else return False

contains(*mouseevent*)

Test whether the mouse event occurred in the collection.

Returns True | False, `dict(ind=itemlist)`, where every item in itemlist contains the event.

convert_xunits(*x*)

For artists in an axes, if the xaxis has units support, convert *x* using xaxis unit type

convert_yunits(*y*)

For artists in an axes, if the yaxis has units support, convert *y* using yaxis unit type

draw(*artist*, *renderer*, **args*, ***kwargs*)

findobj(*match=None*, *include_self=True*)

Find artist objects.

Recursively find all *Artist* instances contained in self.

match can be

- None: return all objects contained in artist.
- function with signature `boolean = match(artist)` used to filter matches
- class instance: e.g., *Line2D*. Only return artists of class type.

If *include_self* is True (default), include self in the list to be checked for a match.

format_cursor_data(*data*)

Return *cursor data* string formatted.

get_agg_filter()

return filter function to be used for agg filter

get_alpha()

Return the alpha value used for blending - not supported on all backends

get_animated()

Return the artist's animated state

get_array()

Return the array

get_axes()

Return the *Axes* instance the artist resides in, or *None*.

This has been deprecated in mpl 1.5, please use the axes property. Will be removed in 1.7 or 2.0.

get_children()

Return a list of the child *Artist*'s `this :class:`Artist` contains.

get_clim()

return the min, max of the color limits for image scaling

get_clip_box()

Return artist clipbox

get_clip_on()

Return whether artist uses clipping

get_clip_path()

Return artist clip path

get_cmap()
return the colormap

get_contains()
Return the `_contains` test used by the artist, or *None* for default.

get_cursor_data(*event*)
Get the cursor data for a given event.

get_dashes()

get_datalim(*transData*)

get_edgecolor()

get_edgecolors()

get_facecolor()

get_facecolors()

get_figure()
Return the *Figure* instance the artist belongs to.

get_fill()
return whether fill is set

get_gid()
Returns the group id

get_hatch()
Return the current hatching pattern

get_label()
Get the label used for this artist in the legend.

get_linestyle()

get_linestyles()

get_linewidth()

get_linewidths()

get_offset_position()
Returns how offsets are applied for the collection. If *offset_position* is 'screen', the offset is applied after the master transform has been applied, that is, the offsets are in screen coordinates.

If `offset_position` is 'data', the offset is applied before the master transform, i.e., the offsets are in data coordinates.

get_offset_transform()

get_offsets()

Return the offsets for the collection.

get_path_effects()

get_paths()

get_picker()

Return the picker object used by this artist

get_pickradius()

get_rasterized()

return True if the artist is to be rasterized

get_sizes()

Returns the sizes of the elements in the collection. The value represents the 'area' of the element.

Returns sizes : array

The 'area' of each element.

get_sketch_params()

Returns the sketch parameters for the artist.

Returns sketch_params : tuple or None

A 3-tuple with the following elements:

- scale**: The amplitude of the wiggle perpendicular to the source line.
- length**: The length of the wiggle along the line.
- randomness**: The scale factor by which the length is shrunken or expanded.

May return None if no sketch parameters were set.

get_snap()

Returns the snap setting which may be:

- True: snap vertices to the nearest pixel center
- False: leave vertices as-is
- None: (auto) If the path contains only rectilinear line segments, round to the nearest pixel center

Only supported by the Agg and MacOSX backends.

get_transform()

Return the *Transform* instance used by this artist.

get_transformed_clip_path_and_affine()

Return the clip path with the non-affine part of its transformation applied, and the remaining affine part of its transformation.

get_transforms()**get_url()**

Returns the url

get_urls()**get_visible()**

Return the artist's visibility

get_window_extent(renderer)**get_zorder()**

Return the Artist's zorder.

have_units()

Return *True* if units are set on the *x* or *y* axes

hitlist(event)

List the children of the artist which contain the mouse event *event*.

is_figure_set()

Returns *True* if the artist is assigned to a *Figure*.

is_transform_set()

Returns *True* if Artist has a transform explicitly set.

mouseover**pchanged()**

Fire an event when property changed, calling all of the registered callbacks.

pick(mouseevent)

Process pick event

each child artist will fire a pick event if *mouseevent* is over the artist and the artist has picker set

pickable()

Return *True* if Artist is pickable.

properties()

return a dictionary mapping property name -> value for all Artist props

remove()

Remove the artist from the figure if possible. The effect will not be visible until the figure is

redrawn, e.g., with `matplotlib.axes.Axes.draw_idle()`. Call `matplotlib.axes.Axes.relim()` to update the axes limits if desired.

Note: `relim()` will not see collections even if the collection was added to axes with `autolim = True`.

Note: there is no support for removing the artist's legend entry.

remove_callback(*oid*)

Remove a callback based on its *id*.

See also:

[`add_callback\(\)`](#) For adding callbacks

set(*kwargs*)**

A property batch setter. Pass *kwargs* to set properties.

set_agg_filter(*filter_func*)

set `agg_filter` fuction.

set_alpha(*alpha*)

Set the alpha transparencies of the collection. *alpha* must be a float or *None*.

ACCEPTS: float or None

set_animated(*b*)

Set the artist's animation state.

ACCEPTS: [True | False]

set_antialiased(*aa*)

Set the antialiasing state for rendering.

ACCEPTS: Boolean or sequence of booleans

set_antialiaseds(*aa*)

alias for `set_antialiased`

set_array(*A*)

Set the image array from numpy array *A*

set_axes(*axes*)

Set the [*Axes*](#) instance in which the artist resides, if any.

This has been deprecated in mpl 1.5, please use the `axes` property. Will be removed in 1.7 or 2.0.

ACCEPTS: an [*Axes*](#) instance

set_clim(*vmin=None, vmax=None*)

set the norm limits for image scaling; if *vmin* is a length2 sequence, interpret it as (*vmin*, *vmax*) which is used to support `setp`

ACCEPTS: a length 2 sequence of floats

set_clip_box(*clipbox*)

Set the artist's clip [*Bbox*](#).

ACCEPTS: a `matplotlib.transforms.Bbox` instance

set_clip_on(*b*)

Set whether artist uses clipping.

When False artists will be visible out side of the axes which can lead to unexpected results.

ACCEPTS: [True | False]

set_clip_path(*path*, *transform=None*)

Set the artist's clip path, which may be:

- a `Patch` (or subclass) instance
- a `Path` instance, in which case an optional `Transform` instance may be provided, which will be applied to the path before using it for clipping.
- `None`, to remove the clipping path

For efficiency, if the path happens to be an axis-aligned rectangle, this method will set the clipping box to the corresponding rectangle and set the clipping path to `None`.

ACCEPTS: [(`Path`, `Transform`) | `Patch` | None]

set_cmap(*cmap*)

set the colormap for luminance data

ACCEPTS: a colormap or registered colormap name

set_color(*c*)

Set both the edgecolor and the facecolor.

ACCEPTS: matplotlib color arg or sequence of rgba tuples

See also:

[`set_facecolor\(\)`](#), [`set_edgecolor\(\)`](#) For setting the edge or face color individually.

set_contains(*picker*)

Replace the contains test used by this artist. The new picker should be a callable function which determines whether the artist is hit by the mouse event:

```
hit, props = picker(artist, mouseevent)
```

If the mouse event is over the artist, return `hit = True` and `props` is a dictionary of properties you want returned with the contains test.

ACCEPTS: a callable function

set_dashes(*ls*)

alias for `set_linestyle`

set_edgecolor(*c*)

Set the edgecolor(s) of the collection. `c` can be a matplotlib color spec (all patches have same color), or a sequence of specs; if it is a sequence the patches will cycle through the sequence.

If *c* is ‘face’, the edge color will always be the same as the face color. If it is ‘none’, the patch boundary will not be drawn.

ACCEPTS: matplotlib color spec or sequence of specs

set_edgecolors(*c*)
alias for set_edgecolor

set_facecolor(*c*)
Set the facecolor(s) of the collection. *c* can be a matplotlib color spec (all patches have same color), or a sequence of specs; if it is a sequence the patches will cycle through the sequence.

If *c* is ‘none’, the patch will not be filled.

ACCEPTS: matplotlib color spec or sequence of specs

set_facecolors(*c*)
alias for set_facecolor

set_figure(*fig*)
Set the *Figure* instance the artist belongs to.

ACCEPTS: a *matplotlib.figure.Figure* instance

set_gid(*gid*)
Sets the (group) id for the artist

ACCEPTS: an id string

set_hatch(*hatch*)
Set the hatching pattern

hatch can be one of:

/	- diagonal hatching
\	- back diagonal
	- vertical
-	- horizontal
+	- crossed
x	- crossed diagonal
o	- small circle
O	- large circle
.	- dots
*	- stars

Letters can be combined, in which case all the specified hatchings are done. If same letter repeats, it increases the density of hatching of that pattern.

Hatching is supported in the PostScript, PDF, SVG and Agg backends only.

Unlike other properties such as linewidth and colors, hatching can only be specified for the collection as a whole, not separately for each member.

ACCEPTS: ['/' | '\' | '|' | '-' | '+' | 'x' | 'o' | 'O' | '.' | '*']

set_label(*s*)
Set the label to *s* for auto legend.

ACCEPTS: string or anything printable with ‘%s’ conversion.

set_linestyle(*ls*)

Set the linestyle(s) for the collection.

linestyle	description
'-' or 'solid'	solid line
'--' or 'dashed'	dashed line
'-.' or 'dashdot'	dash-dotted line
':' or 'dotted'	dotted line

Alternatively a dash tuple of the following form can be provided:

```
(offset, onoffseq),
```

where *onoffseq* is an even length tuple of on and off ink in points.

ACCEPTS: ['solid' | 'dashed', 'dashdot', 'dotted' | (offset, on-off-dash-seq) | '-' | '--' | '-.' | ':' | 'None' | ' ' | '']

Parameters *ls* : { '-', '-.', ':', ':' } and more see description

The line style.

set_linestyles(*ls*)

alias for `set_linestyle`

set_linewidth(*lw*)

Set the linewidth(s) for the collection. *lw* can be a scalar or a sequence; if it is a sequence the patches will cycle through the sequence

ACCEPTS: float or sequence of floats

set_linewidths(*lw*)

alias for `set_linewidth`

set_lw(*lw*)

alias for `set_linewidth`

set_norm(*norm*)

set the normalization instance

set_offset_position(*offset_position*)

Set how offsets are applied. If *offset_position* is 'screen' (default) the offset is applied after the master transform has been applied, that is, the offsets are in screen coordinates. If *offset_position* is 'data', the offset is applied before the master transform, i.e., the offsets are in data coordinates.

set_offsets(*offsets*)

Set the offsets for the collection. *offsets* can be a scalar or a sequence.

ACCEPTS: float or sequence of floats

set_path_effects(*path_effects*)

set *path_effects*, which should be a list of instances of `matplotlib.patheffect._Base` class or its derivatives.

set_paths(*verts, closed=True*)

This allows one to delay initialization of the vertices.

set_picker(*picker*)

Set the epsilon for picking used by this artist

picker can be one of the following:

- *None*: picking is disabled for this artist (default)
- A boolean: if *True* then picking will be enabled and the artist will fire a pick event if the mouse event is over the artist
- A float: if *picker* is a number it is interpreted as an epsilon tolerance in points and the artist will fire off an event if it's data is within epsilon of the mouse event. For some artists like lines and patch collections, the artist may provide additional data to the pick event that is generated, e.g., the indices of the data within epsilon of the pick event
- A function: if *picker* is callable, it is a user supplied function which determines whether the artist is hit by the mouse event:

```
hit, props = picker(artist, mouseevent)
```

to determine the hit test. if the mouse event is over the artist, return *hit=True* and *props* is a dictionary of properties you want added to the `PickEvent` attributes.

ACCEPTS: [None|float|boolean|callable]

set_pickradius(*pr*)

set_rasterized(*rasterized*)

Force rasterized (bitmap) drawing in vector backend output.

Defaults to *None*, which implies the backend's default behavior

ACCEPTS: [True | False | None]

set_sizes(*sizes, dpi=72.0*)

Set the sizes of each member of the collection.

Parameters *sizes* : ndarray or None

The size to set for each element of the collection. The value is the 'area' of the element.

dpi : float

The dpi of the canvas. Defaults to 72.0.

set_sketch_params(*scale=None, length=None, randomness=None*)

Sets the sketch parameters.

Parameters scale : float, optional

The amplitude of the wiggle perpendicular to the source line, in pixels. If scale is `None`, or not provided, no sketch filter will be provided.

length : float, optional

The length of the wiggle along the line, in pixels (default 128.0)

randomness : float, optional

The scale factor by which the length is shrunken or expanded (default 16.0)

set_snap(*snap*)

Sets the snap setting which may be:

- True: snap vertices to the nearest pixel center
- False: leave vertices as-is
- None: (auto) If the path contains only rectilinear line segments, round to the nearest pixel center

Only supported by the Agg and MacOSX backends.

set_transform(*t*)

Set the *Transform* instance used by this artist.

ACCEPTS: *Transform* instance

set_url(*url*)

Sets the url for the artist

ACCEPTS: a url string

set_urls(*urls*)

set_verts(*verts*, *closed=True*)

This allows one to delay initialization of the vertices.

set_verts_and_codes(*verts*, *codes*)

This allows one to initialize vertices with path codes.

set_visible(*b*)

Set the artist's visibility.

ACCEPTS: [True | False]

set_zorder(*level*)

Set the zorder for the artist. Artists with lower zorder values are drawn first.

ACCEPTS: any number

stale

If the artist is 'stale' and needs to be re-drawn for the output to match the internal state of the artist.

sticky_edges

x and y sticky edge lists.

When performing autoscaling, if a data limit coincides with a value in the corresponding `sticky_edges` list, then no margin will be added—the view limit “sticks” to the edge. A typical usecase is histograms, where one usually expects no margin on the bottom edge (0) of the histogram.

This attribute cannot be assigned to; however, the x and y lists can be modified in place as needed.

Examples

```
>>> artist.sticky_edges.x[:] = (xmin, xmax)
>>> artist.sticky_edges.y[:] = (ymin, ymax)
```

to_rgba(*x*, *alpha=None*, *bytes=False*, *norm=True*)

Return a normalized rgba array corresponding to *x*.

In the normal case, *x* is a 1-D or 2-D sequence of scalars, and the corresponding ndarray of rgba values will be returned, based on the norm and colormap set for this `ScalarMappable`.

There is one special case, for handling images that are already rgb or rgba, such as might have been read from an image file. If *x* is an ndarray with 3 dimensions, and the last dimension is either 3 or 4, then it will be treated as an rgb or rgba array, and no mapping will be done. If the last dimension is 3, the *alpha* kwarg (defaulting to 1) will be used to fill in the transparency. If the last dimension is 4, the *alpha* kwarg is ignored; it does not replace the pre-existing alpha. A `ValueError` will be raised if the third dimension is other than 3 or 4.

In either case, if *bytes* is `False` (default), the rgba array will be floats in the 0-1 range; if it is `True`, the returned rgba array will be `uint8` in the 0 to 255 range.

If *norm* is `False`, no normalization of the input data is performed, and it is assumed to already be in the range (0-1).

Note: this method assumes the input is well-behaved; it does not check for anomalies such as *x* being a masked rgba array, or being an integer type other than `uint8`, or being a floating point rgba array with values outside the 0-1 range.

update(*props*)

Update the properties of this `Artist` from the dictionary *prop*.

update_from(*other*)

copy properties from other to self

update_scalarmappable()

If the scalar mappable array is not none, update colors from scalar data

zorder = 0

class matplotlib.collections.**QuadMesh**(*meshWidth*, *meshHeight*, *coordinates*, *antialiased=True*, *shading='flat'*, ***kwargs*)

Bases: [matplotlib.collections.Collection](#)

Class for the efficient drawing of a quadrilateral mesh.

A quadrilateral mesh consists of a grid of vertices. The dimensions of this array are (*meshWidth* + 1, *meshHeight* + 1). Each vertex in the mesh has a different set of “mesh coordinates” representing its position in the topology of the mesh. For any values (*m*, *n*) such that $0 \leq m \leq \text{meshWidth}$ and $0 \leq n \leq \text{meshHeight}$, the vertices at mesh coordinates (*m*, *n*), (*m*, *n* + 1), (*m* + 1, *n* + 1), and (*m* + 1, *n*) form one of the quadrilaterals in the mesh. There are thus (*meshWidth* * *meshHeight*) quadrilaterals in the mesh. The mesh need not be regular and the polygons need not be convex.

A quadrilateral mesh is represented by a $(2 \times ((\text{meshWidth} + 1) * (\text{meshHeight} + 1)))$ numpy array *coordinates*, where each row is the *x* and *y* coordinates of one of the vertices. To define the function that maps from a data point to its corresponding color, use the [set_cmap\(\)](#) method. Each of these arrays is indexed in row-major order by the mesh coordinates of the vertex (or the mesh coordinates of the lower left vertex, in the case of the colors).

For example, the first entry in *coordinates* is the coordinates of the vertex at mesh coordinates (0, 0), then the one at (0, 1), then at (0, 2) .. (0, *meshWidth*), (1, 0), (1, 1), and so on.

shading may be ‘flat’, or ‘gouraud’

add_callback(*func*)

Adds a callback function that will be called whenever one of the `Artist`’s properties changes.

Returns an *id* that is useful for removing the callback with [remove_callback\(\)](#) later.

add_checker(*checker*)

Add an entry to a dictionary of boolean flags that are set to True when the mappable is changed.

aname = ‘Artist’

autoscale()

Autoscale the scalar limits on the norm instance using the current array

autoscale_None()

Autoscale the scalar limits on the norm instance using the current array, changing only limits that are None

axes

The [Axes](#) instance the artist resides in, or *None*.

changed()

Call this whenever the mappable is changed to notify all the callbackSM listeners to the ‘changed’ signal

check_update(*checker*)

If mappable has changed since the last check, return True; else return False

contains(*mouseevent*)

Test whether the mouse event occurred in the collection.

Returns True | False, `dict(ind=itemlist)`, where every item in itemlist contains the event.

static convert_mesh_to_paths(*meshWidth, meshHeight, coordinates*)

Converts a given mesh into a sequence of `matplotlib.path.Path` objects for easier rendering by backends that do not directly support quadmeshes.

This function is primarily of use to backend implementers.

convert_mesh_to_triangles(*meshWidth, meshHeight, coordinates*)

Converts a given mesh into a sequence of triangles, each point with its own color. This is useful for experiments using `draw_qouraud_triangle`.

convert_xunits(*x*)

For artists in an axes, if the xaxis has units support, convert *x* using xaxis unit type

convert_yunits(*y*)

For artists in an axes, if the yaxis has units support, convert *y* using yaxis unit type

draw(*artist, renderer, *args, **kwargs*)

findobj(*match=None, include_self=True*)

Find artist objects.

Recursively find all `Artist` instances contained in self.

match can be

- None: return all objects contained in artist.
- function with signature `boolean = match(artist)` used to filter matches
- class instance: e.g., `Line2D`. Only return artists of class type.

If *include_self* is True (default), include self in the list to be checked for a match.

format_cursor_data(*data*)

Return *cursor data* string formatted.

get_agg_filter()

return filter function to be used for agg filter

get_alpha()

Return the alpha value used for blending - not supported on all backends

get_animated()

Return the artist's animated state

get_array()

Return the array

get_axes()

Return the `Axes` instance the artist resides in, or `None`.

This has been deprecated in mpl 1.5, please use the axes property. Will be removed in 1.7 or 2.0.

get_children()

Return a list of the child `Artist`'s `this :class:`Artist` contains.

get_clim()
return the min, max of the color limits for image scaling

get_clip_box()
Return artist clipbox

get_clip_on()
Return whether artist uses clipping

get_clip_path()
Return artist clip path

get_cmap()
return the colormap

get_contains()
Return the `_contains` test used by the artist, or *None* for default.

get_cursor_data(event)
Get the cursor data for a given event.

get_dashes()

get_datalim(transData)

get_edgecolor()

get_edgecolors()

get_facecolor()

get_facecolors()

get_figure()
Return the *Figure* instance the artist belongs to.

get_fill()
return whether fill is set

get_gid()
Returns the group id

get_hatch()
Return the current hatching pattern

get_label()
Get the label used for this artist in the legend.

get_linestyle()

get_linestyles()

get_linewidth()

get_linewidths()

get_offset_position()

Returns how offsets are applied for the collection. If *offset_position* is 'screen', the offset is applied after the master transform has been applied, that is, the offsets are in screen coordinates. If *offset_position* is 'data', the offset is applied before the master transform, i.e., the offsets are in data coordinates.

get_offset_transform()

get_offsets()

Return the offsets for the collection.

get_path_effects()

get_paths()

get_picker()

Return the picker object used by this artist

get_pickradius()

get_rasterized()

return True if the artist is to be rasterized

get_sketch_params()

Returns the sketch parameters for the artist.

Returns sketch_params : tuple or None

A 3-tuple with the following elements:

- scale**: The amplitude of the wiggle perpendicular to the source line.
- length**: The length of the wiggle along the line.
- randomness**: The scale factor by which the length is shrunken or expanded.

May return None if no sketch parameters were set.

get_snap()

Returns the snap setting which may be:

- True: snap vertices to the nearest pixel center
- False: leave vertices as-is

- None: (auto) If the path contains only rectilinear line segments, round to the nearest pixel center

Only supported by the Agg and MacOSX backends.

get_transform()

Return the *Transform* instance used by this artist.

get_transformed_clip_path_and_affine()

Return the clip path with the non-affine part of its transformation applied, and the remaining affine part of its transformation.

get_transforms()

get_url()

Returns the url

get_urls()

get_visible()

Return the artist's visibility

get_window_extent(renderer)

get_zorder()

Return the Artist's zorder.

have_units()

Return *True* if units are set on the *x* or *y* axes

hitlist(event)

List the children of the artist which contain the mouse event *event*.

is_figure_set()

Returns *True* if the artist is assigned to a *Figure*.

is_transform_set()

Returns *True* if Artist has a transform explicitly set.

mouseover

pchanged()

Fire an event when property changed, calling all of the registered callbacks.

pick(mouseevent)

Process pick event

each child artist will fire a pick event if *mouseevent* is over the artist and the artist has picker set

pickable()

Return *True* if Artist is pickable.

properties()

return a dictionary mapping property name -> value for all Artist props

remove()

Remove the artist from the figure if possible. The effect will not be visible until the figure is redrawn, e.g., with `matplotlib.axes.Axes.draw_idle()`. Call `matplotlib.axes.Axes.relim()` to update the axes limits if desired.

Note: `relim()` will not see collections even if the collection was added to axes with `autolim = True`.

Note: there is no support for removing the artist's legend entry.

remove_callback(*oid*)

Remove a callback based on its *id*.

See also:

[`add_callback\(\)`](#) For adding callbacks

set(*kwargs*)**

A property batch setter. Pass *kwargs* to set properties.

set_agg_filter(*filter_func*)

set `agg_filter` fuction.

set_alpha(*alpha*)

Set the alpha transparencies of the collection. *alpha* must be a float or *None*.

ACCEPTS: float or None

set_animated(*b*)

Set the artist's animation state.

ACCEPTS: [True | False]

set_antialiased(*aa*)

Set the antialiasing state for rendering.

ACCEPTS: Boolean or sequence of booleans

set_antialiaseds(*aa*)

alias for `set_antialiased`

set_array(*A*)

Set the image array from numpy array *A*

set_axes(*axes*)

Set the [`Axes`](#) instance in which the artist resides, if any.

This has been deprecated in mpl 1.5, please use the `axes` property. Will be removed in 1.7 or 2.0.

ACCEPTS: an [`Axes`](#) instance

set_clim(*vmin=None, vmax=None*)

set the norm limits for image scaling; if *vmin* is a length2 sequence, interpret it as (*vmin*, *vmax*) which is used to support setp

ACCEPTS: a length 2 sequence of floats

set_clip_box(*clipbox*)

Set the artist's clip *Bbox*.

ACCEPTS: a `matplotlib.transforms.Bbox` instance

set_clip_on(*b*)

Set whether artist uses clipping.

When False artists will be visible out side of the axes which can lead to unexpected results.

ACCEPTS: [True | False]

set_clip_path(*path*, *transform=None*)

Set the artist's clip path, which may be:

- a *Patch* (or subclass) instance
- a ***Path* instance, in which case** an optional *Transform* instance may be provided, which will be applied to the path before using it for clipping.
- *None*, to remove the clipping path

For efficiency, if the path happens to be an axis-aligned rectangle, this method will set the clipping box to the corresponding rectangle and set the clipping path to *None*.

ACCEPTS: [(*Path*, *Transform*) | *Patch* | None]

set_cmap(*cmap*)

set the colormap for luminance data

ACCEPTS: a colormap or registered colormap name

set_color(*c*)

Set both the edgecolor and the facecolor.

ACCEPTS: matplotlib color arg or sequence of rgba tuples

See also:

[`set_facecolor\(\)`](#), [`set_edgecolor\(\)`](#) For setting the edge or face color individually.

set_contains(*picker*)

Replace the contains test used by this artist. The new picker should be a callable function which determines whether the artist is hit by the mouse event:

```
hit, props = picker(artist, mouseevent)
```

If the mouse event is over the artist, return *hit = True* and *props* is a dictionary of properties you want returned with the contains test.

ACCEPTS: a callable function

set_dashes(*ls*)

alias for `set_linestyle`

set_edgcolor(*c*)

Set the edgcolor(s) of the collection. *c* can be a matplotlib color spec (all patches have same color), or a sequence of specs; if it is a sequence the patches will cycle through the sequence.

If *c* is 'face', the edge color will always be the same as the face color. If it is 'none', the patch boundary will not be drawn.

ACCEPTS: matplotlib color spec or sequence of specs

set_edgecolors(*c*)

alias for set_edgcolor

set_facecolor(*c*)

Set the facecolor(s) of the collection. *c* can be a matplotlib color spec (all patches have same color), or a sequence of specs; if it is a sequence the patches will cycle through the sequence.

If *c* is 'none', the patch will not be filled.

ACCEPTS: matplotlib color spec or sequence of specs

set_facecolors(*c*)

alias for set_facecolor

set_figure(*fig*)

Set the *Figure* instance the artist belongs to.

ACCEPTS: a *matplotlib.figure.Figure* instance

set_gid(*gid*)

Sets the (group) id for the artist

ACCEPTS: an id string

set_hatch(*hatch*)

Set the hatching pattern

hatch can be one of:

```
/ - diagonal hatching
\ - back diagonal
| - vertical
- - horizontal
+ - crossed
x - crossed diagonal
o - small circle
O - large circle
. - dots
* - stars
```

Letters can be combined, in which case all the specified hatchings are done. If same letter repeats, it increases the density of hatching of that pattern.

Hatching is supported in the PostScript, PDF, SVG and Agg backends only.

Unlike other properties such as linewidth and colors, hatching can only be specified for the collection as a whole, not separately for each member.

ACCEPTS: ['/' | '\' | '|' | '-' | '+' | 'x' | 'o' | 'O' | '.' | '*']

set_label(*s*)

Set the label to *s* for auto legend.

ACCEPTS: string or anything printable with '%s' conversion.

set_linestyle(*ls*)

Set the linestyle(*s*) for the collection.

linestyle	description
'-' or 'solid'	solid line
'--' or 'dashed'	dashed line
'-.' or 'dashdot'	dash-dotted line
':' or 'dotted'	dotted line

Alternatively a dash tuple of the following form can be provided:

(offset, onoffseq),

where *onoffseq* is an even length tuple of on and off ink in points.

ACCEPTS: ['solid' | 'dashed', 'dashdot', 'dotted' | (offset, on-off-dash-seq) | '-' | '--' | '-.' | ':' | 'None' | ' ' | '']

Parameters *ls* : { '-', '--', '-.', ':' } and more see description

The line style.

set_linestyles(*ls*)

alias for `set_linestyle`

set_linewidth(*lw*)

Set the linewidth(*s*) for the collection. *lw* can be a scalar or a sequence; if it is a sequence the patches will cycle through the sequence

ACCEPTS: float or sequence of floats

set_linewidths(*lw*)

alias for `set_linewidth`

set_lw(*lw*)

alias for `set_linewidth`

set_norm(*norm*)

set the normalization instance

set_offset_position(*offset_position*)

Set how offsets are applied. If *offset_position* is 'screen' (default) the offset is applied after the master transform has been applied, that is, the offsets are in screen coordinates. If *offset_position* is 'data', the offset is applied before the master transform, i.e., the offsets are in data coordinates.

set_offsets(*offsets*)

Set the offsets for the collection. *offsets* can be a scalar or a sequence.

ACCEPTS: float or sequence of floats

set_path_effects(*path_effects*)

set *path_effects*, which should be a list of instances of `matplotlib.patheffect._Base` class or its derivatives.

set_paths()

set_picker(*picker*)

Set the epsilon for picking used by this artist

picker can be one of the following:

- *None*: picking is disabled for this artist (default)
- A boolean: if *True* then picking will be enabled and the artist will fire a pick event if the mouse event is over the artist
- A float: if *picker* is a number it is interpreted as an epsilon tolerance in points and the artist will fire off an event if it's data is within epsilon of the mouse event. For some artists like lines and patch collections, the artist may provide additional data to the pick event that is generated, e.g., the indices of the data within epsilon of the pick event
- A function: if *picker* is callable, it is a user supplied function which determines whether the artist is hit by the mouse event:

```
hit, props = picker(artist, mouseevent)
```

to determine the hit test. if the mouse event is over the artist, return *hit=True* and *props* is a dictionary of properties you want added to the `PickEvent` attributes.

ACCEPTS: [None|float|boolean|callable]

set_pickradius(*pr*)

set_rasterized(*rasterized*)

Force rasterized (bitmap) drawing in vector backend output.

Defaults to *None*, which implies the backend's default behavior

ACCEPTS: [True | False | None]

set_sketch_params(*scale=None, length=None, randomness=None*)

Sets the sketch parameters.

Parameters scale : float, optional

The amplitude of the wiggle perpendicular to the source line, in pixels. If *scale* is *None*, or not provided, no sketch filter will be provided.

length : float, optional

The length of the wiggle along the line, in pixels (default 128.0)

randomness : float, optional

The scale factor by which the length is shrunken or expanded (default 16.0)

set_snap(*snap*)

Sets the snap setting which may be:

- True: snap vertices to the nearest pixel center
- False: leave vertices as-is
- None: (auto) If the path contains only rectilinear line segments, round to the nearest pixel center

Only supported by the Agg and MacOSX backends.

set_transform(*t*)

Set the *Transform* instance used by this artist.

ACCEPTS: *Transform* instance

set_url(*url*)

Sets the url for the artist

ACCEPTS: a url string

set_urls(*urls*)**set_visible**(*b*)

Set the artist's visibility.

ACCEPTS: [True | False]

set_zorder(*level*)

Set the zorder for the artist. Artists with lower zorder values are drawn first.

ACCEPTS: any number

stale

If the artist is 'stale' and needs to be re-drawn for the output to match the internal state of the artist.

sticky_edges

x and y sticky edge lists.

When performing autoscaling, if a data limit coincides with a value in the corresponding `sticky_edges` list, then no margin will be added—the view limit “sticks” to the edge. A typical usecase is histograms, where one usually expects no margin on the bottom edge (0) of the histogram.

This attribute cannot be assigned to; however, the x and y lists can be modified in place as needed.

Examples

```
>>> artist.sticky_edges.x[:] = (xmin, xmax)
>>> artist.sticky_edges.y[:] = (ymin, ymax)
```

to_rgba(*x*, *alpha=None*, *bytes=False*, *norm=True*)

Return a normalized rgba array corresponding to *x*.

In the normal case, *x* is a 1-D or 2-D sequence of scalars, and the corresponding ndarray of rgba values will be returned, based on the norm and colormap set for this ScalarMappable.

There is one special case, for handling images that are already rgb or rgba, such as might have been read from an image file. If *x* is an ndarray with 3 dimensions, and the last dimension is either 3 or 4, then it will be treated as an rgb or rgba array, and no mapping will be done. If the last dimension is 3, the *alpha* kwarg (defaulting to 1) will be used to fill in the transparency. If the last dimension is 4, the *alpha* kwarg is ignored; it does not replace the pre-existing alpha. A `ValueError` will be raised if the third dimension is other than 3 or 4.

In either case, if *bytes* is *False* (default), the rgba array will be floats in the 0-1 range; if it is *True*, the returned rgba array will be uint8 in the 0 to 255 range.

If *norm* is *False*, no normalization of the input data is performed, and it is assumed to already be in the range (0-1).

Note: this method assumes the input is well-behaved; it does not check for anomalies such as *x* being a masked rgba array, or being an integer type other than uint8, or being a floating point rgba array with values outside the 0-1 range.

update(*props*)

Update the properties of this `Artist` from the dictionary *prop*.

update_from(*other*)

copy properties from other to self

update_scalarmappable()

If the scalar mappable array is not none, update colors from scalar data

zorder = 0

class matplotlib.collections.RegularPolyCollection(*numsides*, *rotation=0*, *sizes=(1,)*,
***kwargs*)

Bases: `matplotlib.collections._CollectionWithSizes`

Draw a collection of regular polygons with *numsides*.

numsides the number of sides of the polygon

rotation the rotation of the polygon in radians

sizes gives the area of the circle circumscribing the regular polygon in points²

Valid Collection keyword arguments:

- ***edgecolors***: None

- facecolors*: None
- linewidths*: None
- antialiaseds*: None
- offsets*: None
- transOffset*: `transforms.IdentityTransform()`
- norm*: None (optional for `matplotlib.cm.ScalarMappable`)
- cmap*: None (optional for `matplotlib.cm.ScalarMappable`)

offsets and *transOffset* are used to translate the patch after rendering (default no offsets)

If any of *edgecolors*, *facecolors*, *linewidths*, *antialiaseds* are None, they default to their `matplotlib.rcParams` patch setting, in sequence form.

Example: see `examples/dynamic_collection.py` for complete example:

```
offsets = np.random.rand(20,2)
facecolors = [cm.jet(x) for x in np.random.rand(20)]
black = (0,0,0,1)

collection = RegularPolyCollection(
    numsides=5, # a pentagon
    rotation=0, sizes=(50,),
    facecolors = facecolors,
    edgecolors = (black,),
    linewidths = (1,),
    offsets = offsets,
    transOffset = ax.transData,
)
```

add_callback(*func*)

Adds a callback function that will be called whenever one of the `Artist`'s properties changes.

Returns an *id* that is useful for removing the callback with `remove_callback()` later.

add_checker(*checker*)

Add an entry to a dictionary of boolean flags that are set to True when the mappable is changed.

aname = 'Artist'

autoscale()

Autoscale the scalar limits on the norm instance using the current array

autoscale_None()

Autoscale the scalar limits on the norm instance using the current array, changing only limits that are None

axes

The `Axes` instance the artist resides in, or `None`.

changed()

Call this whenever the mappable is changed to notify all the callbackSM listeners to the 'changed' signal

check_update(*checker*)

If mappable has changed since the last check, return True; else return False

contains(*mouseevent*)

Test whether the mouse event occurred in the collection.

Returns True | False, dict(ind=itemlist), where every item in itemlist contains the event.

convert_xunits(*x*)

For artists in an axes, if the xaxis has units support, convert *x* using xaxis unit type

convert_yunits(*y*)

For artists in an axes, if the yaxis has units support, convert *y* using yaxis unit type

draw(*artist*, *renderer*, **args*, *kwargs*)**

findobj(*match=None*, *include_self=True*)

Find artist objects.

Recursively find all *Artist* instances contained in self.

match can be

- None: return all objects contained in artist.
- function with signature `boolean = match(artist)` used to filter matches
- class instance: e.g., Line2D. Only return artists of class type.

If *include_self* is True (default), include self in the list to be checked for a match.

format_cursor_data(*data*)

Return *cursor data* string formatted.

get_agg_filter()

return filter function to be used for agg filter

get_alpha()

Return the alpha value used for blending - not supported on all backends

get_animated()

Return the artist's animated state

get_array()

Return the array

get_axes()

Return the *Axes* instance the artist resides in, or *None*.

This has been deprecated in mpl 1.5, please use the axes property. Will be removed in 1.7 or 2.0.

get_children()

Return a list of the child Artist`s this :class:`Artist` contains.

get_clim()
return the min, max of the color limits for image scaling

get_clip_box()
Return artist clipbox

get_clip_on()
Return whether artist uses clipping

get_clip_path()
Return artist clip path

get_cmap()
return the colormap

get_contains()
Return the `_contains` test used by the artist, or *None* for default.

get_cursor_data(event)
Get the cursor data for a given event.

get_dashes()

get_datalim(transData)

get_edgecolor()

get_edgecolors()

get_facecolor()

get_facecolors()

get_figure()
Return the *Figure* instance the artist belongs to.

get_fill()
return whether fill is set

get_gid()
Returns the group id

get_hatch()
Return the current hatching pattern

get_label()
Get the label used for this artist in the legend.

get_linestyle()

`get_linestyles()`

`get_linewidth()`

`get_linewidths()`

`get_numsides()`

`get_offset_position()`

Returns how offsets are applied for the collection. If *offset_position* is 'screen', the offset is applied after the master transform has been applied, that is, the offsets are in screen coordinates. If *offset_position* is 'data', the offset is applied before the master transform, i.e., the offsets are in data coordinates.

`get_offset_transform()`

`get_offsets()`

Return the offsets for the collection.

`get_path_effects()`

`get_paths()`

`get_picker()`

Return the picker object used by this artist

`get_pickradius()`

`get_rasterized()`

return True if the artist is to be rasterized

`get_rotation()`

`get_sizes()`

Returns the sizes of the elements in the collection. The value represents the 'area' of the element.

Returns sizes : array

The 'area' of each element.

`get_sketch_params()`

Returns the sketch parameters for the artist.

Returns sketch_params : tuple or None

A 3-tuple with the following elements:

- **scale:** The amplitude of the wiggle perpendicular to the source line.

- length**: The length of the wiggle along the line.
- randomness**: The scale factor by which the length is shrunken or expanded.

May return `None` if no sketch parameters were set.

get_snap()

Returns the snap setting which may be:

- True**: snap vertices to the nearest pixel center
- False**: leave vertices as-is
- None**: (auto) If the path contains only rectilinear line segments, round to the nearest pixel center

Only supported by the Agg and MacOSX backends.

get_transform()

Return the *Transform* instance used by this artist.

get_transformed_clip_path_and_affine()

Return the clip path with the non-affine part of its transformation applied, and the remaining affine part of its transformation.

get_transforms()

get_url()

Returns the url

get_urls()

get_visible()

Return the artist's visibility

get_window_extent(renderer)

get_zorder()

Return the Artist's zorder.

have_units()

Return *True* if units are set on the *x* or *y* axes

hitlist(event)

List the children of the artist which contain the mouse event *event*.

is_figure_set()

Returns *True* if the artist is assigned to a *Figure*.

is_transform_set()

Returns *True* if Artist has a transform explicitly set.

mouseover

pchanged()

Fire an event when property changed, calling all of the registered callbacks.

pick(*mouseevent*)

Process pick event

each child artist will fire a pick event if *mouseevent* is over the artist and the artist has picker set

pickable()

Return *True* if *Artist* is pickable.

properties()

return a dictionary mapping property name -> value for all *Artist* props

remove()

Remove the artist from the figure if possible. The effect will not be visible until the figure is redrawn, e.g., with `matplotlib.axes.Axes.draw_idle()`. Call `matplotlib.axes.Axes.relim()` to update the axes limits if desired.

Note: `relim()` will not see collections even if the collection was added to axes with `autolim = True`.

Note: there is no support for removing the artist's legend entry.

remove_callback(*oid*)

Remove a callback based on its *id*.

See also:

[`add_callback\(\)`](#) For adding callbacks

set(*kwargs*)**

A property batch setter. Pass *kwargs* to set properties.

set_agg_filter(*filter_func*)

set `agg_filter` fuction.

set_alpha(*alpha*)

Set the alpha tranparencies of the collection. *alpha* must be a float or *None*.

ACCEPTS: float or *None*

set_animated(*b*)

Set the artist's animation state.

ACCEPTS: [True | False]

set_antialiased(*aa*)

Set the antialiasing state for rendering.

ACCEPTS: Boolean or sequence of booleans

set_antialiaseds(*aa*)

alias for `set_antialiased`

set_array(*A*)

Set the image array from numpy array *A*

set_axes(*axes*)

Set the *Axes* instance in which the artist resides, if any.

This has been deprecated in mpl 1.5, please use the axes property. Will be removed in 1.7 or 2.0.

ACCEPTS: an *Axes* instance

set_clim(*vmin=None, vmax=None*)

set the norm limits for image scaling; if *vmin* is a length2 sequence, interpret it as (*vmin*, *vmax*) which is used to support setp

ACCEPTS: a length 2 sequence of floats

set_clip_box(*clipbox*)

Set the artist's clip *Bbox*.

ACCEPTS: a *matplotlib.transforms.Bbox* instance

set_clip_on(*b*)

Set whether artist uses clipping.

When False artists will be visible out side of the axes which can lead to unexpected results.

ACCEPTS: [True | False]

set_clip_path(*path, transform=None*)

Set the artist's clip path, which may be:

- a *Patch* (or subclass) instance
- a *Path* instance, in which case an optional *Transform* instance may be provided, which will be applied to the path before using it for clipping.
- *None*, to remove the clipping path

For efficiency, if the path happens to be an axis-aligned rectangle, this method will set the clipping box to the corresponding rectangle and set the clipping path to *None*.

ACCEPTS: [(*Path, Transform*) | *Patch* | None]

set_cmap(*cmap*)

set the colormap for luminance data

ACCEPTS: a colormap or registered colormap name

set_color(*c*)

Set both the edgecolor and the facecolor.

ACCEPTS: matplotlib color arg or sequence of rgba tuples

See also:

[*set_facecolor\(\)*](#), [*set_edgecolor\(\)*](#) For setting the edge or face color individually.

set_contains(*picker*)

Replace the contains test used by this artist. The new picker should be a callable function which determines whether the artist is hit by the mouse event:

```
hit, props = picker(artist, mouseevent)
```

If the mouse event is over the artist, return *hit = True* and *props* is a dictionary of properties you want returned with the contains test.

ACCEPTS: a callable function

set_dashes(*ls*)

alias for `set_linestyle`

set_edgecolor(*c*)

Set the edgecolor(s) of the collection. *c* can be a matplotlib color spec (all patches have same color), or a sequence of specs; if it is a sequence the patches will cycle through the sequence.

If *c* is 'face', the edge color will always be the same as the face color. If it is 'none', the patch boundary will not be drawn.

ACCEPTS: matplotlib color spec or sequence of specs

set_edgecolors(*c*)

alias for `set_edgecolor`

set_facecolor(*c*)

Set the facecolor(s) of the collection. *c* can be a matplotlib color spec (all patches have same color), or a sequence of specs; if it is a sequence the patches will cycle through the sequence.

If *c* is 'none', the patch will not be filled.

ACCEPTS: matplotlib color spec or sequence of specs

set_facecolors(*c*)

alias for `set_facecolor`

set_figure(*fig*)

Set the *Figure* instance the artist belongs to.

ACCEPTS: a `matplotlib.figure.Figure` instance

set_gid(*gid*)

Sets the (group) id for the artist

ACCEPTS: an id string

set_hatch(*hatch*)

Set the hatching pattern

hatch can be one of:

```
/ - diagonal hatching
\ - back diagonal
| - vertical
- - horizontal
+ - crossed
x - crossed diagonal
o - small circle
O - large circle
```

.	- dots
*	- stars

Letters can be combined, in which case all the specified hatchings are done. If same letter repeats, it increases the density of hatching of that pattern.

Hatching is supported in the PostScript, PDF, SVG and Agg backends only.

Unlike other properties such as linewidth and colors, hatching can only be specified for the collection as a whole, not separately for each member.

ACCEPTS: ['/' | '\' | '|' | '-' | '+' | 'x' | 'o' | 'O' | ':' | '*']

set_label(*s*)

Set the label to *s* for auto legend.

ACCEPTS: string or anything printable with '%s' conversion.

set_linestyle(*ls*)

Set the linestyle(s) for the collection.

linestyle	description
'-' or 'solid'	solid line
'--' or 'dashed'	dashed line
'-.' or 'dashdot'	dash-dotted line
':' or 'dotted'	dotted line

Alternatively a dash tuple of the following form can be provided:

(offset, onoffseq),

where onoffseq is an even length tuple of on and off ink in points.

ACCEPTS: ['solid' | 'dashed', 'dashdot', 'dotted' | (offset, on-off-dash-seq) | '-' | '--' | '-.' | ':' | 'None' | ' ' | '']

Parameters *ls* : { '-', '-.', '-.', ':' } and more see description

The line style.

set_linestyles(*ls*)

alias for set_linestyle

set_linewidth(*lw*)

Set the linewidth(s) for the collection. *lw* can be a scalar or a sequence; if it is a sequence the patches will cycle through the sequence

ACCEPTS: float or sequence of floats

set_linewidths(*lw*)

alias for set_linewidth

set_lw(*lw*)

alias for set_linewidth

set_norm(*norm*)

set the normalization instance

set_offset_position(*offset_position*)

Set how offsets are applied. If *offset_position* is 'screen' (default) the offset is applied after the master transform has been applied, that is, the offsets are in screen coordinates. If *offset_position* is 'data', the offset is applied before the master transform, i.e., the offsets are in data coordinates.

set_offsets(*offsets*)

Set the offsets for the collection. *offsets* can be a scalar or a sequence.

ACCEPTS: float or sequence of floats

set_path_effects(*path_effects*)

set *path_effects*, which should be a list of instances of `matplotlib.patheffect._Base` class or its derivatives.

set_paths()**set_picker**(*picker*)

Set the epsilon for picking used by this artist

picker can be one of the following:

- *None*: picking is disabled for this artist (default)
- A boolean: if *True* then picking will be enabled and the artist will fire a pick event if the mouse event is over the artist
- A float: if *picker* is a number it is interpreted as an epsilon tolerance in points and the artist will fire off an event if it's data is within epsilon of the mouse event. For some artists like lines and patch collections, the artist may provide additional data to the pick event that is generated, e.g., the indices of the data within epsilon of the pick event
- A function: if *picker* is callable, it is a user supplied function which determines whether the artist is hit by the mouse event:

```
hit, props = picker(artist, mouseevent)
```

to determine the hit test. if the mouse event is over the artist, return *hit=True* and *props* is a dictionary of properties you want added to the `PickEvent` attributes.

ACCEPTS: [None|float|boolean|callable]

set_pickradius(*pr*)**set_rasterized**(*rasterized*)

Force rasterized (bitmap) drawing in vector backend output.

Defaults to *None*, which implies the backend's default behavior

ACCEPTS: [True | False | None]

set_sizes(*sizes*, *dpi*=72.0)

Set the sizes of each member of the collection.

Parameters *sizes* : ndarray or None

The size to set for each element of the collection. The value is the ‘area’ of the element.

dpi : float

The dpi of the canvas. Defaults to 72.0.

set_sketch_params(*scale*=None, *length*=None, *randomness*=None)

Sets the sketch parameters.

Parameters *scale* : float, optional

The amplitude of the wiggle perpendicular to the source line, in pixels. If *scale* is None, or not provided, no sketch filter will be provided.

length : float, optional

The length of the wiggle along the line, in pixels (default 128.0)

randomness : float, optional

The scale factor by which the length is shrunken or expanded (default 16.0)

set_snap(*snap*)

Sets the snap setting which may be:

- True: snap vertices to the nearest pixel center
- False: leave vertices as-is
- None: (auto) If the path contains only rectilinear line segments, round to the nearest pixel center

Only supported by the Agg and MacOSX backends.

set_transform(*t*)

Set the *Transform* instance used by this artist.

ACCEPTS: *Transform* instance

set_url(*url*)

Sets the url for the artist

ACCEPTS: a url string

set_urls(*urls*)

set_visible(*b*)

Set the artist’s visibility.

ACCEPTS: [True | False]

set_zorder(*level*)

Set the zorder for the artist. Artists with lower zorder values are drawn first.

ACCEPTS: any number

stale

If the artist is 'stale' and needs to be re-drawn for the output to match the internal state of the artist.

sticky_edges

x and y sticky edge lists.

When performing autoscaling, if a data limit coincides with a value in the corresponding sticky_edges list, then no margin will be added—the view limit “sticks” to the edge. A typical usecase is histograms, where one usually expects no margin on the bottom edge (0) of the histogram.

This attribute cannot be assigned to; however, the x and y lists can be modified in place as needed.

Examples

```
>>> artist.sticky_edges.x[:] = (xmin, xmax)
>>> artist.sticky_edges.y[:] = (ymin, ymax)
```

to_rgba(*x*, *alpha=None*, *bytes=False*, *norm=True*)

Return a normalized rgba array corresponding to *x*.

In the normal case, *x* is a 1-D or 2-D sequence of scalars, and the corresponding ndarray of rgba values will be returned, based on the norm and colormap set for this ScalarMappable.

There is one special case, for handling images that are already rgb or rgba, such as might have been read from an image file. If *x* is an ndarray with 3 dimensions, and the last dimension is either 3 or 4, then it will be treated as an rgb or rgba array, and no mapping will be done. If the last dimension is 3, the *alpha* kwarg (defaulting to 1) will be used to fill in the transparency. If the last dimension is 4, the *alpha* kwarg is ignored; it does not replace the pre-existing alpha. A `ValueError` will be raised if the third dimension is other than 3 or 4.

In either case, if *bytes* is *False* (default), the rgba array will be floats in the 0-1 range; if it is *True*, the returned rgba array will be uint8 in the 0 to 255 range.

If *norm* is *False*, no normalization of the input data is performed, and it is assumed to already be in the range (0-1).

Note: this method assumes the input is well-behaved; it does not check for anomalies such as *x* being a masked rgba array, or being an integer type other than uint8, or being a floating point rgba array with values outside the 0-1 range.

update(*props*)

Update the properties of this `Artist` from the dictionary *prop*.

update_from(*other*)

copy properties from other to self

update_scalarmappable()

If the scalar mappable array is not none, update colors from scalar data

zorder = 0

class matplotlib.collections.StarPolygonCollection(*numsides*, *rotation*=0, *sizes*=(1,),
***kwargs*)

Bases: [matplotlib.collections.RegularPolyCollection](#)

Draw a collection of regular stars with *numsides* points.

numsides the number of sides of the polygon

rotation the rotation of the polygon in radians

sizes gives the area of the circle circumscribing the regular polygon in points²

Valid Collection keyword arguments:

- ***edgecolors***: None
- ***facecolors***: None
- ***linewidths***: None
- ***antialiaseds***: None
- ***offsets***: None
- ***transOffset***: `transforms.IdentityTransform()`
- ***norm***: None (optional for [matplotlib.cm.ScalarMappable](#))
- ***cmap***: None (optional for [matplotlib.cm.ScalarMappable](#))

offsets and *transOffset* are used to translate the patch after rendering (default no offsets)

If any of *edgecolors*, *facecolors*, *linewidths*, *antialiaseds* are None, they default to their [matplotlib.rcParams](#) patch setting, in sequence form.

Example: see `examples/dynamic_collection.py` for complete example:

```
offsets = np.random.rand(20,2)
facecolors = [cm.jet(x) for x in np.random.rand(20)]
black = (0,0,0,1)

collection = RegularPolyCollection(
    numsides=5, # a pentagon
    rotation=0, sizes=(50,),
    facecolors = facecolors,
    edgecolors = (black,),
    linewidths = (1,),
    offsets = offsets,
    transOffset = ax.transData,
)
```

add_callback(*func*)

Adds a callback function that will be called whenever one of the Artist's properties changes.

Returns an *id* that is useful for removing the callback with `remove_callback()` later.

add_checker(*checker*)

Add an entry to a dictionary of boolean flags that are set to True when the mappable is changed.

aname = 'Artist'

autoscale()

Autoscale the scalar limits on the norm instance using the current array

autoscale_None()

Autoscale the scalar limits on the norm instance using the current array, changing only limits that are None

axes

The *Axes* instance the artist resides in, or *None*.

changed()

Call this whenever the mappable is changed to notify all the callbackSM listeners to the 'changed' signal

check_update(*checker*)

If mappable has changed since the last check, return True; else return False

contains(*mouseevent*)

Test whether the mouse event occurred in the collection.

Returns True | False, dict(ind=itemlist), where every item in itemlist contains the event.

convert_xunits(*x*)

For artists in an axes, if the xaxis has units support, convert *x* using xaxis unit type

convert_yunits(*y*)

For artists in an axes, if the yaxis has units support, convert *y* using yaxis unit type

draw(*artist*, *renderer*, **args*, ***kwargs*)

findobj(*match=None*, *include_self=True*)

Find artist objects.

Recursively find all *Artist* instances contained in self.

match can be

- None: return all objects contained in artist.
- function with signature `boolean = match(artist)` used to filter matches
- class instance: e.g., *Line2D*. Only return artists of class type.

If *include_self* is True (default), include self in the list to be checked for a match.

format_cursor_data(*data*)

Return *cursor data* string formatted.

get_agg_filter()
return filter function to be used for agg filter

get_alpha()
Return the alpha value used for blending - not supported on all backends

get_animated()
Return the artist's animated state

get_array()
Return the array

get_axes()
Return the [Axes](#) instance the artist resides in, or *None*.

This has been deprecated in mpl 1.5, please use the axes property. Will be removed in 1.7 or 2.0.

get_children()
Return a list of the child `Artist`'s `this :class:`Artist` contains.

get_clim()
return the min, max of the color limits for image scaling

get_clip_box()
Return artist clipbox

get_clip_on()
Return whether artist uses clipping

get_clip_path()
Return artist clip path

get_cmap()
return the colormap

get_contains()
Return the `_contains` test used by the artist, or *None* for default.

get_cursor_data(event)
Get the cursor data for a given event.

get_dashes()

get_datalim(transData)

get_edgecolor()

get_edgecolors()

get_facecolor()

get_facecolors()

get_figure()

Return the *Figure* instance the artist belongs to.

get_fill()

return whether fill is set

get_gid()

Returns the group id

get_hatch()

Return the current hatching pattern

get_label()

Get the label used for this artist in the legend.

get_linestyle()

get_linestyles()

get_linewidth()

get_linewidths()

get_numsides()

get_offset_position()

Returns how offsets are applied for the collection. If *offset_position* is 'screen', the offset is applied after the master transform has been applied, that is, the offsets are in screen coordinates. If *offset_position* is 'data', the offset is applied before the master transform, i.e., the offsets are in data coordinates.

get_offset_transform()

get_offsets()

Return the offsets for the collection.

get_path_effects()

get_paths()

get_picker()

Return the picker object used by this artist

get_pickradius()

get_rasterized()

return True if the artist is to be rasterized

get_rotation()**get_sizes()**

Returns the sizes of the elements in the collection. The value represents the 'area' of the element.

Returns sizes : array

The 'area' of each element.

get_sketch_params()

Returns the sketch parameters for the artist.

Returns sketch_params : tuple or None

A 3-tuple with the following elements:

- scale: The amplitude of the wiggle perpendicular to the source line.
- length: The length of the wiggle along the line.
- randomness: The scale factor by which the length is shrunk or expanded.

May return None if no sketch parameters were set.

get_snap()

Returns the snap setting which may be:

- True: snap vertices to the nearest pixel center
- False: leave vertices as-is
- None: (auto) If the path contains only rectilinear line segments, round to the nearest pixel center

Only supported by the Agg and MacOSX backends.

get_transform()

Return the *Transform* instance used by this artist.

get_transformed_clip_path_and_affine()

Return the clip path with the non-affine part of its transformation applied, and the remaining affine part of its transformation.

get_transforms()**get_url()**

Returns the url

get_urls()**get_visible()**

Return the artist's visibility

get_window_extent(*renderer*)

get_zorder()

Return the Artist's zorder.

have_units()

Return *True* if units are set on the *x* or *y* axes

hitlist(*event*)

List the children of the artist which contain the mouse event *event*.

is_figure_set()

Returns *True* if the artist is assigned to a *Figure*.

is_transform_set()

Returns *True* if Artist has a transform explicitly set.

mouseover

pchanged()

Fire an event when property changed, calling all of the registered callbacks.

pick(*mouseevent*)

Process pick event

each child artist will fire a pick event if *mouseevent* is over the artist and the artist has picker set

pickable()

Return *True* if Artist is pickable.

properties()

return a dictionary mapping property name -> value for all Artist props

remove()

Remove the artist from the figure if possible. The effect will not be visible until the figure is redrawn, e.g., with `matplotlib.axes.Axes.draw_idle()`. Call `matplotlib.axes.Axes.relim()` to update the axes limits if desired.

Note: `relim()` will not see collections even if the collection was added to axes with `autolim = True`.

Note: there is no support for removing the artist's legend entry.

remove_callback(*oid*)

Remove a callback based on its *id*.

See also:

[`add_callback\(\)`](#) For adding callbacks

set(***kwargs*)

A property batch setter. Pass *kwargs* to set properties.

set_agg_filter(*filter_func*)
set agg_filter fuction.

set_alpha(*alpha*)
Set the alpha tranparencies of the collection. *alpha* must be a float or *None*.
ACCEPTS: float or None

set_animated(*b*)
Set the artist's animation state.
ACCEPTS: [True | False]

set_antialiased(*aa*)
Set the antialiasing state for rendering.
ACCEPTS: Boolean or sequence of booleans

set_antialiaseds(*aa*)
alias for set_antialiased

set_array(*A*)
Set the image array from numpy array *A*

set_axes(*axes*)
Set the *Axes* instance in which the artist resides, if any.
This has been deprecated in mpl 1.5, please use the axes property. Will be removed in 1.7 or 2.0.
ACCEPTS: an *Axes* instance

set_clim(*vmin=None, vmax=None*)
set the norm limits for image scaling; if *vmin* is a length2 sequence, interpret it as (*vmin*, *vmax*) which is used to support setp
ACCEPTS: a length 2 sequence of floats

set_clip_box(*clipbox*)
Set the artist's clip *Bbox*.
ACCEPTS: a *matplotlib.transforms.Bbox* instance

set_clip_on(*b*)
Set whether artist uses clipping.
When False artists will be visible out side of the axes which can lead to unexpected results.
ACCEPTS: [True | False]

set_clip_path(*path, transform=None*)
Set the artist's clip path, which may be:

- a *Patch* (or subclass) instance
- a *Path* instance, in which case an optional *Transform* instance may be provided, which will be applied to the path before using it for clipping.
- *None*, to remove the clipping path

For efficiency, if the path happens to be an axis-aligned rectangle, this method will set the clipping box to the corresponding rectangle and set the clipping path to *None*.

ACCEPTS: [(*Path*, *Transform*) | *Patch* | *None*]

set_cmap(*cmap*)

set the colormap for luminance data

ACCEPTS: a colormap or registered colormap name

set_color(*c*)

Set both the edgecolor and the facecolor.

ACCEPTS: matplotlib color arg or sequence of rgba tuples

See also:

[*set_facecolor\(\)*](#), [*set_edgecolor\(\)*](#) For setting the edge or face color individually.

set_contains(*picker*)

Replace the contains test used by this artist. The new picker should be a callable function which determines whether the artist is hit by the mouse event:

```
hit, props = picker(artist, mouseevent)
```

If the mouse event is over the artist, return *hit = True* and *props* is a dictionary of properties you want returned with the contains test.

ACCEPTS: a callable function

set_dashes(*ls*)

alias for [*set_linestyle*](#)

set_edgecolor(*c*)

Set the edgecolor(s) of the collection. *c* can be a matplotlib color spec (all patches have same color), or a sequence of specs; if it is a sequence the patches will cycle through the sequence.

If *c* is 'face', the edge color will always be the same as the face color. If it is 'none', the patch boundary will not be drawn.

ACCEPTS: matplotlib color spec or sequence of specs

set_edgecolors(*c*)

alias for [*set_edgecolor*](#)

set_facecolor(*c*)

Set the facecolor(s) of the collection. *c* can be a matplotlib color spec (all patches have same color), or a sequence of specs; if it is a sequence the patches will cycle through the sequence.

If *c* is 'none', the patch will not be filled.

ACCEPTS: matplotlib color spec or sequence of specs

set_facecolors(*c*)

alias for [*set_facecolor*](#)

set_figure(*fig*)

Set the *Figure* instance the artist belongs to.

ACCEPTS: a `matplotlib.figure.Figure` instance

set_gid(*gid*)

Sets the (group) id for the artist

ACCEPTS: an id string

set_hatch(*hatch*)

Set the hatching pattern

hatch can be one of:

/	- diagonal hatching
\	- back diagonal
	- vertical
-	- horizontal
+	- crossed
x	- crossed diagonal
o	- small circle
O	- large circle
.	- dots
*	- stars

Letters can be combined, in which case all the specified hatchings are done. If same letter repeats, it increases the density of hatching of that pattern.

Hatching is supported in the PostScript, PDF, SVG and Agg backends only.

Unlike other properties such as linewidth and colors, hatching can only be specified for the collection as a whole, not separately for each member.

ACCEPTS: ['/' | '\' | '|' | '-' | '+' | 'x' | 'o' | 'O' | '.' | '*']

set_label(*s*)

Set the label to *s* for auto legend.

ACCEPTS: string or anything printable with '%s' conversion.

set_linestyle(*ls*)

Set the linestyle(s) for the collection.

linestyle	description
'-' or 'solid'	solid line
'--' or 'dashed'	dashed line
'-.' or 'dashdot'	dash-dotted line
':' or 'dotted'	dotted line

Alternatively a dash tuple of the following form can be provided:

(offset, onoffseq),

where *onoffseq* is an even length tuple of on and off ink in points.

ACCEPTS: ['solid' | 'dashed', 'dashdot', 'dotted' | (offset, on-off-dash-seq) | '-' | '--' | '-.' | ':' | 'None' | ' ' | '']

Parameters ls : { '-', '-.', '-.', ':' } and more see description

The line style.

set_linestyles(*ls*)

alias for set_linestyle

set_linewidth(*lw*)

Set the linewidth(s) for the collection. *lw* can be a scalar or a sequence; if it is a sequence the patches will cycle through the sequence

ACCEPTS: float or sequence of floats

set_linewidths(*lw*)

alias for set_linewidth

set_lw(*lw*)

alias for set_linewidth

set_norm(*norm*)

set the normalization instance

set_offset_position(*offset_position*)

Set how offsets are applied. If *offset_position* is 'screen' (default) the offset is applied after the master transform has been applied, that is, the offsets are in screen coordinates. If *offset_position* is 'data', the offset is applied before the master transform, i.e., the offsets are in data coordinates.

set_offsets(*offsets*)

Set the offsets for the collection. *offsets* can be a scalar or a sequence.

ACCEPTS: float or sequence of floats

set_path_effects(*path_effects*)

set *path_effects*, which should be a list of instances of matplotlib.patheffect._Base class or its derivatives.

set_paths()

set_picker(*picker*)

Set the epsilon for picking used by this artist

picker can be one of the following:

- *None*: picking is disabled for this artist (default)
- A boolean: if *True* then picking will be enabled and the artist will fire a pick event if the mouse event is over the artist
- A float: if *picker* is a number it is interpreted as an epsilon tolerance in points and the artist will fire off an event if it's data is within epsilon of the mouse event. For some artists like

lines and patch collections, the artist may provide additional data to the pick event that is generated, e.g., the indices of the data within epsilon of the pick event

- A function: if picker is callable, it is a user supplied function which determines whether the artist is hit by the mouse event:

```
hit, props = picker(artist, mouseevent)
```

to determine the hit test. if the mouse event is over the artist, return *hit=True* and props is a dictionary of properties you want added to the PickEvent attributes.

ACCEPTS: [None|float|boolean|callable]

set_pickradius(*pr*)

set_rasterized(*rasterized*)

Force rasterized (bitmap) drawing in vector backend output.

Defaults to None, which implies the backend's default behavior

ACCEPTS: [True | False | None]

set_sizes(*sizes*, *dpi=72.0*)

Set the sizes of each member of the collection.

Parameters sizes : ndarray or None

The size to set for each element of the collection. The value is the 'area' of the element.

dpi : float

The dpi of the canvas. Defaults to 72.0.

set_sketch_params(*scale=None*, *length=None*, *randomness=None*)

Sets the sketch parameters.

Parameters scale : float, optional

The amplitude of the wiggle perpendicular to the source line, in pixels. If scale is None, or not provided, no sketch filter will be provided.

length : float, optional

The length of the wiggle along the line, in pixels (default 128.0)

randomness : float, optional

The scale factor by which the length is shrunken or expanded (default 16.0)

set_snap(*snap*)

Sets the snap setting which may be:

- True: snap vertices to the nearest pixel center
- False: leave vertices as-is

- None: (auto) If the path contains only rectilinear line segments, round to the nearest pixel center

Only supported by the Agg and MacOSX backends.

set_transform(*t*)

Set the *Transform* instance used by this artist.

ACCEPTS: *Transform* instance

set_url(*url*)

Sets the url for the artist

ACCEPTS: a url string

set_urls(*urls*)

set_visible(*b*)

Set the artist's visibility.

ACCEPTS: [True | False]

set_zorder(*level*)

Set the zorder for the artist. Artists with lower zorder values are drawn first.

ACCEPTS: any number

stale

If the artist is 'stale' and needs to be re-drawn for the output to match the internal state of the artist.

sticky_edges

x and y sticky edge lists.

When performing autoscaling, if a data limit coincides with a value in the corresponding sticky_edges list, then no margin will be added—the view limit “sticks” to the edge. A typical usecase is histograms, where one usually expects no margin on the bottom edge (0) of the histogram.

This attribute cannot be assigned to; however, the x and y lists can be modified in place as needed.

Examples

```
>>> artist.sticky_edges.x[:] = (xmin, xmax)
>>> artist.sticky_edges.y[:] = (ymin, ymax)
```

to_rgba(*x*, *alpha=None*, *bytes=False*, *norm=True*)

Return a normalized rgba array corresponding to *x*.

In the normal case, *x* is a 1-D or 2-D sequence of scalars, and the corresponding ndarray of rgba values will be returned, based on the norm and colormap set for this ScalarMappable.

There is one special case, for handling images that are already rgb or rgba, such as might have been read from an image file. If x is an ndarray with 3 dimensions, and the last dimension is either 3 or 4, then it will be treated as an rgb or rgba array, and no mapping will be done. If the last dimension is 3, the *alpha* kwarg (defaulting to 1) will be used to fill in the transparency. If the last dimension is 4, the *alpha* kwarg is ignored; it does not replace the pre-existing alpha. A `ValueError` will be raised if the third dimension is other than 3 or 4.

In either case, if *bytes* is *False* (default), the rgba array will be floats in the 0-1 range; if it is *True*, the returned rgba array will be uint8 in the 0 to 255 range.

If *norm* is *False*, no normalization of the input data is performed, and it is assumed to already be in the range (0-1).

Note: this method assumes the input is well-behaved; it does not check for anomalies such as x being a masked rgba array, or being an integer type other than uint8, or being a floating point rgba array with values outside the 0-1 range.

update(*props*)

Update the properties of this `Artist` from the dictionary *prop*.

update_from(*other*)

copy properties from other to self

update_scalarmappable()

If the scalar mappable array is not none, update colors from scalar data

zorder = 0

class `matplotlib.collections.TriMesh`(*triangulation*, ***kwargs*)

Bases: `matplotlib.collections.Collection`

Class for the efficient drawing of a triangular mesh using Gouraud shading.

A triangular mesh is a `Triangulation` object.

add_callback(*func*)

Adds a callback function that will be called whenever one of the `Artist`'s properties changes.

Returns an *id* that is useful for removing the callback with `remove_callback()` later.

add_checker(*checker*)

Add an entry to a dictionary of boolean flags that are set to True when the mappable is changed.

aname = 'Artist'

autoscale()

Autoscale the scalar limits on the norm instance using the current array

autoscale_None()

Autoscale the scalar limits on the norm instance using the current array, changing only limits that are None

axes

The `Axes` instance the artist resides in, or *None*.

changed()

Call this whenever the mappable is changed to notify all the callbackSM listeners to the 'changed' signal

check_update(*checker*)

If mappable has changed since the last check, return True; else return False

contains(*mouseevent*)

Test whether the mouse event occurred in the collection.

Returns True | False, dict(ind=itemlist), where every item in itemlist contains the event.

static convert_mesh_to_paths(*tri*)

Converts a given mesh into a sequence of `matplotlib.path.Path` objects for easier rendering by backends that do not directly support meshes.

This function is primarily of use to backend implementers.

convert_xunits(*x*)

For artists in an axes, if the xaxis has units support, convert *x* using xaxis unit type

convert_yunits(*y*)

For artists in an axes, if the yaxis has units support, convert *y* using yaxis unit type

draw(*artist*, *renderer*, **args*, *kwargs*)****findobj(*match=None*, *include_self=True*)**

Find artist objects.

Recursively find all `Artist` instances contained in self.

match can be

- None: return all objects contained in artist.
- function with signature `boolean = match(artist)` used to filter matches
- class instance: e.g., `Line2D`. Only return artists of class type.

If *include_self* is True (default), include self in the list to be checked for a match.

format_cursor_data(*data*)

Return *cursor data* string formatted.

get_agg_filter()

return filter function to be used for agg filter

get_alpha()

Return the alpha value used for blending - not supported on all backends

get_animated()

Return the artist's animated state

get_array()

Return the array

get_axes()

Return the [Axes](#) instance the artist resides in, or *None*.

This has been deprecated in mpl 1.5, please use the axes property. Will be removed in 1.7 or 2.0.

get_children()

Return a list of the child `Artist`'s `this :class:`Artist` contains.

get_clim()

return the min, max of the color limits for image scaling

get_clip_box()

Return artist clipbox

get_clip_on()

Return whether artist uses clipping

get_clip_path()

Return artist clip path

get_cmap()

return the colormap

get_contains()

Return the `_contains` test used by the artist, or *None* for default.

get_cursor_data(event)

Get the cursor data for a given event.

get_dashes()**get_datalim(transData)****get_edgecolor()****get_edgecolors()****get_facecolor()****get_facecolors()****get_figure()**

Return the [Figure](#) instance the artist belongs to.

get_fill()

return whether fill is set

get_gid()

Returns the group id

get_hatch()

Return the current hatching pattern

get_label()

Get the label used for this artist in the legend.

get_linestyle()

get_linestyles()

get_linewidth()

get_linewidths()

get_offset_position()

Returns how offsets are applied for the collection. If *offset_position* is 'screen', the offset is applied after the master transform has been applied, that is, the offsets are in screen coordinates. If *offset_position* is 'data', the offset is applied before the master transform, i.e., the offsets are in data coordinates.

get_offset_transform()

get_offsets()

Return the offsets for the collection.

get_path_effects()

get_paths()

get_picker()

Return the picker object used by this artist

get_pickradius()

get_rasterized()

return True if the artist is to be rasterized

get_sketch_params()

Returns the sketch parameters for the artist.

Returns sketch_params : tuple or None

A 3-tuple with the following elements:

- **scale**: The amplitude of the wiggle perpendicular to the source line.
- **length**: The length of the wiggle along the line.
- **randomness**: The scale factor by which the length is shrunken or expanded.

May return `None` if no sketch parameters were set.

get_snap()

Returns the snap setting which may be:

- `True`: snap vertices to the nearest pixel center
- `False`: leave vertices as-is
- `None`: (auto) If the path contains only rectilinear line segments, round to the nearest pixel center

Only supported by the Agg and MacOSX backends.

get_transform()

Return the *Transform* instance used by this artist.

get_transformed_clip_path_and_affine()

Return the clip path with the non-affine part of its transformation applied, and the remaining affine part of its transformation.

get_transforms()**get_url()**

Returns the url

get_urls()**get_visible()**

Return the artist's visibility

get_window_extent(renderer)**get_zorder()**

Return the Artist's zorder.

have_units()

Return *True* if units are set on the *x* or *y* axes

hitlist(event)

List the children of the artist which contain the mouse event *event*.

is_figure_set()

Returns *True* if the artist is assigned to a *Figure*.

is_transform_set()

Returns *True* if Artist has a transform explicitly set.

mouseover**pchanged()**

Fire an event when property changed, calling all of the registered callbacks.

pick(*mouseevent*)

Process pick event

each child artist will fire a pick event if *mouseevent* is over the artist and the artist has picker set

pickable()

Return *True* if Artist is pickable.

properties()

return a dictionary mapping property name -> value for all Artist props

remove()

Remove the artist from the figure if possible. The effect will not be visible until the figure is redrawn, e.g., with `matplotlib.axes.Axes.draw_idle()`. Call `matplotlib.axes.Axes.relim()` to update the axes limits if desired.

Note: `relim()` will not see collections even if the collection was added to axes with `autolim = True`.

Note: there is no support for removing the artist's legend entry.

remove_callback(*oid*)

Remove a callback based on its *id*.

See also:

[`add_callback\(\)`](#) For adding callbacks

set(***kwargs*)

A property batch setter. Pass *kwargs* to set properties.

set_agg_filter(*filter_func*)

set `agg_filter` fuction.

set_alpha(*alpha*)

Set the alpha tranparencies of the collection. *alpha* must be a float or *None*.

ACCEPTS: float or None

set_animated(*b*)

Set the artist's animation state.

ACCEPTS: [True | False]

set_antialiased(*aa*)

Set the antialiasing state for rendering.

ACCEPTS: Boolean or sequence of booleans

set_antialiaseds(*aa*)

alias for `set_antialiased`

set_array(*A*)

Set the image array from numpy array *A*

set_axes(*axes*)

Set the *Axes* instance in which the artist resides, if any.

This has been deprecated in mpl 1.5, please use the axes property. Will be removed in 1.7 or 2.0.

ACCEPTS: an *Axes* instance

set_clim(*vmin=None, vmax=None*)

set the norm limits for image scaling; if *vmin* is a length2 sequence, interpret it as (*vmin*, *vmax*) which is used to support setp

ACCEPTS: a length 2 sequence of floats

set_clip_box(*clipbox*)

Set the artist's clip *Bbox*.

ACCEPTS: a *matplotlib.transforms.Bbox* instance

set_clip_on(*b*)

Set whether artist uses clipping.

When False artists will be visible out side of the axes which can lead to unexpected results.

ACCEPTS: [True | False]

set_clip_path(*path, transform=None*)

Set the artist's clip path, which may be:

- a *Patch* (or subclass) instance
- a *Path* instance, in which case an optional *Transform* instance may be provided, which will be applied to the path before using it for clipping.
- *None*, to remove the clipping path

For efficiency, if the path happens to be an axis-aligned rectangle, this method will set the clipping box to the corresponding rectangle and set the clipping path to *None*.

ACCEPTS: [(*Path, Transform*) | *Patch* | None]

set_cmap(*cmap*)

set the colormap for luminance data

ACCEPTS: a colormap or registered colormap name

set_color(*c*)

Set both the edgecolor and the facecolor.

ACCEPTS: matplotlib color arg or sequence of rgba tuples

See also:

[*set_facecolor\(\)*](#), [*set_edgecolor\(\)*](#) For setting the edge or face color individually.

set_contains(*picker*)

Replace the contains test used by this artist. The new picker should be a callable function which determines whether the artist is hit by the mouse event:

```
hit, props = picker(artist, mouseevent)
```

If the mouse event is over the artist, return *hit = True* and *props* is a dictionary of properties you want returned with the contains test.

ACCEPTS: a callable function

set_dashes(*ls*)

alias for set_linestyle

set_edgecolor(*c*)

Set the edgecolor(s) of the collection. *c* can be a matplotlib color spec (all patches have same color), or a sequence of specs; if it is a sequence the patches will cycle through the sequence.

If *c* is 'face', the edge color will always be the same as the face color. If it is 'none', the patch boundary will not be drawn.

ACCEPTS: matplotlib color spec or sequence of specs

set_edgecolors(*c*)

alias for set_edgecolor

set_facecolor(*c*)

Set the facecolor(s) of the collection. *c* can be a matplotlib color spec (all patches have same color), or a sequence of specs; if it is a sequence the patches will cycle through the sequence.

If *c* is 'none', the patch will not be filled.

ACCEPTS: matplotlib color spec or sequence of specs

set_facecolors(*c*)

alias for set_facecolor

set_figure(*fig*)

Set the *Figure* instance the artist belongs to.

ACCEPTS: a *matplotlib.figure.Figure* instance

set_gid(*gid*)

Sets the (group) id for the artist

ACCEPTS: an id string

set_hatch(*hatch*)

Set the hatching pattern

hatch can be one of:

```
/ - diagonal hatching
\ - back diagonal
| - vertical
- - horizontal
+ - crossed
x - crossed diagonal
o - small circle
O - large circle
```

```
. - dots
* - stars
```

Letters can be combined, in which case all the specified hatchings are done. If same letter repeats, it increases the density of hatching of that pattern.

Hatching is supported in the PostScript, PDF, SVG and Agg backends only.

Unlike other properties such as linewidth and colors, hatching can only be specified for the collection as a whole, not separately for each member.

ACCEPTS: ['/' | '\' | '|' | '-' | '+' | 'x' | 'o' | 'O' | ':' | '*']

set_label(*s*)

Set the label to *s* for auto legend.

ACCEPTS: string or anything printable with '%s' conversion.

set_linestyle(*ls*)

Set the linestyle(s) for the collection.

linestyle	description
'-' or 'solid'	solid line
'--' or 'dashed'	dashed line
'-.' or 'dashdot'	dash-dotted line
':' or 'dotted'	dotted line

Alternatively a dash tuple of the following form can be provided:

```
(offset, onoffseq),
```

where onoffseq is an even length tuple of on and off ink in points.

ACCEPTS: ['solid' | 'dashed', 'dashdot', 'dotted' | (offset, on-off-dash-seq) | '-' | '--' | '-.' | ':' | 'None' | ' ' | '']

Parameters *ls* : { '-', '-.', '-.', ':' } and more see description

The line style.

set_linestyles(*ls*)

alias for set_linestyle

set_linewidth(*lw*)

Set the linewidth(s) for the collection. *lw* can be a scalar or a sequence; if it is a sequence the patches will cycle through the sequence

ACCEPTS: float or sequence of floats

set_linewidths(*lw*)

alias for set_linewidth

set_lw(*lw*)

alias for set_linewidth

set_norm(*norm*)

set the normalization instance

set_offset_position(*offset_position*)

Set how offsets are applied. If *offset_position* is 'screen' (default) the offset is applied after the master transform has been applied, that is, the offsets are in screen coordinates. If *offset_position* is 'data', the offset is applied before the master transform, i.e., the offsets are in data coordinates.

set_offsets(*offsets*)

Set the offsets for the collection. *offsets* can be a scalar or a sequence.

ACCEPTS: float or sequence of floats

set_path_effects(*path_effects*)

set *path_effects*, which should be a list of instances of `matplotlib.patheffect._Base` class or its derivatives.

set_paths()**set_picker**(*picker*)

Set the epsilon for picking used by this artist

picker can be one of the following:

- *None*: picking is disabled for this artist (default)
- A boolean: if *True* then picking will be enabled and the artist will fire a pick event if the mouse event is over the artist
- A float: if *picker* is a number it is interpreted as an epsilon tolerance in points and the artist will fire off an event if it's data is within epsilon of the mouse event. For some artists like lines and patch collections, the artist may provide additional data to the pick event that is generated, e.g., the indices of the data within epsilon of the pick event
- A function: if *picker* is callable, it is a user supplied function which determines whether the artist is hit by the mouse event:

```
hit, props = picker(artist, mouseevent)
```

to determine the hit test. if the mouse event is over the artist, return *hit=True* and *props* is a dictionary of properties you want added to the `PickEvent` attributes.

ACCEPTS: [None|float|boolean|callable]

set_pickradius(*pr*)**set_rasterized**(*rasterized*)

Force rasterized (bitmap) drawing in vector backend output.

Defaults to *None*, which implies the backend's default behavior

ACCEPTS: [True | False | None]

set_sketch_params(*scale=None, length=None, randomness=None*)

Sets the sketch parameters.

Parameters *scale* : float, optional

The amplitude of the wiggle perpendicular to the source line, in pixels. If *scale* is `None`, or not provided, no sketch filter will be provided.

length : float, optional

The length of the wiggle along the line, in pixels (default 128.0)

randomness : float, optional

The scale factor by which the length is shrunken or expanded (default 16.0)

set_snap(*snap*)

Sets the snap setting which may be:

- True: snap vertices to the nearest pixel center
- False: leave vertices as-is
- None: (auto) If the path contains only rectilinear line segments, round to the nearest pixel center

Only supported by the Agg and MacOSX backends.

set_transform(*t*)

Set the *Transform* instance used by this artist.

ACCEPTS: *Transform* instance

set_url(*url*)

Sets the url for the artist

ACCEPTS: a url string

set_urls(*urls*)

set_visible(*b*)

Set the artist's visibility.

ACCEPTS: [True | False]

set_zorder(*level*)

Set the zorder for the artist. Artists with lower zorder values are drawn first.

ACCEPTS: any number

stale

If the artist is 'stale' and needs to be re-drawn for the output to match the internal state of the artist.

sticky_edges

x and y sticky edge lists.

When performing autoscaling, if a data limit coincides with a value in the corresponding `sticky_edges` list, then no margin will be added—the view limit “sticks” to the edge. A typical usecase is histograms, where one usually expects no margin on the bottom edge (0) of the histogram.

This attribute cannot be assigned to; however, the `x` and `y` lists can be modified in place as needed.

Examples

```
>>> artist.sticky_edges.x[:] = (xmin, xmax)
>>> artist.sticky_edges.y[:] = (ymin, ymax)
```

to_rgba(*x*, *alpha=None*, *bytes=False*, *norm=True*)

Return a normalized rgba array corresponding to *x*.

In the normal case, *x* is a 1-D or 2-D sequence of scalars, and the corresponding ndarray of rgba values will be returned, based on the `norm` and `colormap` set for this `ScalarMappable`.

There is one special case, for handling images that are already `rgb` or `rgba`, such as might have been read from an image file. If *x* is an ndarray with 3 dimensions, and the last dimension is either 3 or 4, then it will be treated as an `rgb` or `rgba` array, and no mapping will be done. If the last dimension is 3, the *alpha* kwarg (defaulting to 1) will be used to fill in the transparency. If the last dimension is 4, the *alpha* kwarg is ignored; it does not replace the pre-existing alpha. A `ValueError` will be raised if the third dimension is other than 3 or 4.

In either case, if *bytes* is `False` (default), the rgba array will be floats in the 0-1 range; if it is `True`, the returned rgba array will be `uint8` in the 0 to 255 range.

If `norm` is `False`, no normalization of the input data is performed, and it is assumed to already be in the range (0-1).

Note: this method assumes the input is well-behaved; it does not check for anomalies such as *x* being a masked rgba array, or being an integer type other than `uint8`, or being a floating point rgba array with values outside the 0-1 range.

update(*props*)

Update the properties of this `Artist` from the dictionary *prop*.

update_from(*other*)

copy properties from *other* to self

update_scalarmappable()

If the scalar mappable array is not `None`, update colors from scalar data

zorder = 0

25.1 matplotlib.colorbar

Colorbar toolkit with two classes and a function:

ColorbarBase the base class with full colorbar drawing functionality. It can be used as-is to make a colorbar for a given colormap; a mappable object (e.g., image) is not needed.

Colorbar the derived class for use with images or contour plots.

make_axes() a function for resizing an axes and adding a second axes suitable for a colorbar

The `colorbar()` method uses `make_axes()` and `Colorbar`; the `colorbar()` function is a thin wrapper over `colorbar()`.

class `matplotlib.colorbar.Colorbar`(*ax, mappable, **kw*)

Bases: `matplotlib.colorbar.ColorbarBase`

This class connects a `ColorbarBase` to a `ScalarMappable` such as a `AxesImage` generated via `imshow()`.

It is not intended to be instantiated directly; instead, use `colorbar()` or `colorbar()` to make your colorbar.

add_lines(*CS, erase=True*)

Add the lines from a non-filled `ContourSet` to the colorbar.

Set *erase* to `False` if these lines should be added to any pre-existing lines.

on_mappable_changed(*mappable*)

Updates this colorbar to match the mappable's properties.

Typically this is automatically registered as an event handler by `colorbar_factory()` and should not be called manually.

remove()

Remove this colorbar from the figure. If the colorbar was created with `use_gridspec=True` then restore the `gridspec` to its previous value.

update_bruteforce(*mappable*)

Destroy and rebuild the colorbar. This is intended to become obsolete, and will probably be

deprecated and then removed. It is not called when the `pyplot.colorbar` function or the `Figure.colorbar` method are used to create the colorbar.

update_normal(*mappable*)

update solid, lines, etc. Unlike `update_bruteforce`, it does not clear the axes. This is meant to be called when the image or contour plot to which this colorbar belongs is changed.

```
class matplotlib.colorbar.ColorbarBase(ax, cmap=None, norm=None, alpha=None,
                                       values=None, boundaries=None, orientation='vertical',
                                       ticklocation='auto', extend='neither', spacing='uniform',
                                       ticks=None, format=None, drawedges=False, filled=True,
                                       extendfrac=None, extendrect=False, label='')
```

Bases: `matplotlib.cm.ScalarMappable`

Draw a colorbar in an existing axes.

This is a base class for the `Colorbar` class, which is the basis for the `colorbar()` function and the `colorbar()` method, which are the usual ways of creating a colorbar.

It is also useful by itself for showing a colormap. If the `cmap` kwarg is given but `boundaries` and `values` are left as `None`, then the colormap will be displayed on a 0-1 scale. To show the under- and over-value colors, specify the `norm` as:

```
colors.Normalize(clip=False)
```

To show the colors versus index instead of on the 0-1 scale, use:

```
norm=colors.NoNorm.
```

Useful attributes:

ax the Axes instance in which the colorbar is drawn

lines a list of LineCollection if lines were drawn, otherwise an empty list

dividers a LineCollection if `drawedges` is `True`, otherwise `None`

Useful public methods are `set_label()` and `add_lines()`.

add_lines(*levels, colors, linewidths, erase=True*)

Draw lines on the colorbar.

colors and *linewidths* must be scalars or sequences the same length as *levels*.

Set *erase* to `False` to add lines without first removing any previously added lines.

ax = None

The axes that this colorbar lives in.

config_axis()

draw_all()

Calculate any free parameters based on the current `cmap` and `norm`, and do all the drawing.

n_rasterize = 50

remove()

Remove this colorbar from the figure

set_alpha(alpha)

set_label(label, **kw)

Label the long axis of the colorbar

set_ticklabels(ticklabels, update_ticks=True)

set tick labels. Tick labels are updated immediately unless *update_ticks* is *False*. To manually update the ticks, call *update_ticks* method explicitly.

set_ticks(ticks, update_ticks=True)

set tick locations. Tick locations are updated immediately unless *update_ticks* is *False*. To manually update the ticks, call *update_ticks* method explicitly.

update_ticks()

Force the update of the ticks and ticklabels. This must be called whenever the tick locator and/or tick formatter changes.

class matplotlib.colorbar.ColorbarPatch(ax, mappable, **kw)

Bases: [matplotlib.colorbar.Colorbar](#)

A Colorbar which is created using *Patch* rather than the default *pcolor()*.

It uses a list of Patch instances instead of a *PatchCollection* because the latter does not allow the hatch pattern to vary among the members of the collection.

matplotlib.colorbar.colorbar_factory(cax, mappable, **kwargs)

Creates a colorbar on the given axes for the given mappable.

Typically, for automatic colorbar placement given only a mappable use [colorbar\(\)](#).

matplotlib.colorbar.make_axes(parents, location=None, orientation=None, fraction=0.15, shrink=1.0, aspect=20, **kw)

Resize and reposition parent axes, and return a child axes suitable for a colorbar.

Keyword arguments may include the following (with defaults):

location `[[None|'left'|'right'|'top'|'bottom']]` The position, relative to **parents**, where the colorbar axes should be created. If *None*, the value will either come from the given **orientation**, else it will default to 'right'.

orientation `[[None|'vertical'|'horizontal']]` The orientation of the colorbar. Typically, this keyword shouldn't be used, as it can be derived from the **location** keyword.

Property	Description
<i>orientation</i>	vertical or horizontal
<i>fraction</i>	0.15; fraction of original axes to use for colorbar
<i>pad</i>	0.05 if vertical, 0.15 if horizontal; fraction of original axes between colorbar and new image axes
<i>shrink</i>	1.0; fraction by which to shrink the colorbar
<i>aspect</i>	20; ratio of long to short dimensions
<i>anchor</i>	(0.0, 0.5) if vertical; (0.5, 1.0) if horizontal; the anchor point of the colorbar axes
<i>panchor</i>	(1.0, 0.5) if vertical; (0.5, 0.0) if horizontal; the anchor point of the colorbar parent axes. If False, the parent axes' anchor will be unchanged

Returns (cax, kw), the child axes and the reduced kw dictionary to be passed when creating the colorbar instance.

`matplotlib.colorbar.make_axes_gridspec`(parent, **kw)

Resize and reposition a parent axes, and return a child axes suitable for a colorbar. This function is similar to `make_axes`. Primary differences are

- *make_axes_gridspec* only handles the *orientation* keyword and cannot handle the “location” keyword.
- *make_axes_gridspec* should only be used with a subplot parent.
- *make_axes* creates an instance of `Axes`. *make_axes_gridspec* creates an instance of `Subplot`.
- *make_axes* updates the position of the parent. *make_axes_gridspec* replaces the `grid_spec` attribute of the parent with a new one.

While this function is meant to be compatible with *make_axes*, there could be some minor differences.

Keyword arguments may include the following (with defaults):

orientation ‘vertical’ or ‘horizontal’

Property	Description
<i>orientation</i>	vertical or horizontal
<i>fraction</i>	0.15; fraction of original axes to use for colorbar
<i>pad</i>	0.05 if vertical, 0.15 if horizontal; fraction of original axes between colorbar and new image axes
<i>shrink</i>	1.0; fraction by which to shrink the colorbar
<i>aspect</i>	20; ratio of long to short dimensions
<i>anchor</i>	(0.0, 0.5) if vertical; (0.5, 1.0) if horizontal; the anchor point of the colorbar axes
<i>panchor</i>	(1.0, 0.5) if vertical; (0.5, 0.0) if horizontal; the anchor point of the colorbar parent axes. If False, the parent axes' anchor will be unchanged

All but the first of these are stripped from the input kw set.

Returns (cax, kw), the child axes and the reduced kw dictionary to be passed when creating the colorbar instance.

For a visual representation of the matplotlib colormaps, see the “Color” section in the gallery.

26.1 matplotlib.colors

A module for converting numbers or color arguments to *RGB* or *RGBA*

RGB and *RGBA* are sequences of, respectively, 3 or 4 floats in the range 0-1.

This module includes functions and classes for color specification conversions, and for mapping numbers to colors in a 1-D array of colors called a colormap. Colormapping typically involves two steps: a data array is first mapped onto the range 0-1 using an instance of *Normalize* or of a subclass; then this number in the 0-1 range is mapped to a color using an instance of a subclass of *Colormap*. Two are provided here: *LinearSegmentedColormap*, which is used to generate all the built-in colormap instances, but is also useful for making custom colormaps, and *ListedColormap*, which is used for generating a custom colormap from a list of color specifications.

The module also provides functions for checking whether an object can be interpreted as a color (*is_color_like()*), for converting such an object to an RGBA tuple (*to_rgba()*) or to an HTML-like hex string in the #rrggbb format (*to_hex()*), and a sequence of colors to an (n, 4) RGBA array (*to_rgba_array()*). Caching is used for efficiency.

Commands which take color arguments can use several formats to specify the colors. For the basic built-in colors, you can use a single letter

- b: blue
- g: green
- r: red
- c: cyan
- m: magenta
- y: yellow
- k: black
- w: white

To use the colors that are part of the active color cycle in the current style, use C followed by a digit. For example:

- C0: The first color in the cycle
- C1: The second color in the cycle

Gray shades can be given as a string encoding a float in the 0-1 range, e.g.:

```
color = '0.75'
```

For a greater range of colors, you have two options. You can specify the color using an html hex string, as in:

```
color = '#eeffff'
```

(possibly specifying an alpha value as well), or you can pass an (r, g, b) or (r, g, b, a) tuple, where each of r, g, b and a are in the range [0,1].

Finally, legal html names for colors, like 'red', 'burlywood' and 'chartreuse' are supported.

class matplotlib.colors.**BoundaryNorm**(boundaries, ncolors, clip=False)

Bases: [matplotlib.colors.Normalize](#)

Generate a colormap index based on discrete intervals.

Unlike [Normalize](#) or [LogNorm](#), [BoundaryNorm](#) maps values to integers instead of to the interval 0-1.

Mapping to the 0-1 interval could have been done via piece-wise linear interpolation, but using integers seems simpler, and reduces the number of conversions back and forth between integer and floating point.

boundaries a monotonically increasing sequence

ncolors number of colors in the colormap to be used

If:

```
b[i] <= v < b[i+1]
```

then v is mapped to color j; as i varies from 0 to len(boundaries)-2, j goes from 0 to ncolors-1.

Out-of-range values are mapped to -1 if low and ncolors if high; these are converted to valid indices by `Colormap.__call__()`. If `clip == True`, out-of-range values are mapped to 0 if low and ncolors-1 if high.

inverse(value)

class matplotlib.colors.**Colormap**(name, N=256)

Bases: object

Baseclass for all scalar to RGBA mappings.

Typically Colormap instances are used to convert data values (floats) from the interval [0, 1] to the RGBA color that the respective Colormap represents. For scaling of data into the [0, 1] interval

see `matplotlib.colors.Normalize`. It is worth noting that `matplotlib.cm.ScalarMappable` subclasses make heavy use of this data->normalize->map-to-color processing chain.

Parameters name : str

The name of the colormap.

N : int

The number of rgb quantization levels.

colorbar_extend = None

When this colormap exists on a scalar mappable and `colorbar_extend` is not False, colorbar creation will pick up `colorbar_extend` as the default value for the `extend` keyword in the `matplotlib.colorbar.Colorbar` constructor.

is_gray()

set_bad(*color='k', alpha=None*)

Set color to be used for masked values.

set_over(*color='k', alpha=None*)

Set color to be used for high out-of-range values. Requires `norm.clip = False`

set_under(*color='k', alpha=None*)

Set color to be used for low out-of-range values. Requires `norm.clip = False`

class matplotlib.colors.LightSource(*azdeg=315, altdeg=45, hsv_min_val=0, hsv_max_val=1, hsv_min_sat=1, hsv_max_sat=0*)

Bases: object

Create a light source coming from the specified azimuth and elevation. Angles are in degrees, with the azimuth measured clockwise from north and elevation up from the zero plane of the surface.

The `shade()` is used to produce “shaded” rgb values for a data array. `shade_rgb()` can be used to combine an rgb image with The `shade_rgb()` The `hillshade()` produces an illumination map of a surface.

Specify the azimuth (measured clockwise from south) and altitude (measured up from the plane of the surface) of the light source in degrees.

Parameters azdeg : number, optional

The azimuth (0-360, degrees clockwise from North) of the light source. Defaults to 315 degrees (from the northwest).

altdeg : number, optional

The altitude (0-90, degrees up from horizontal) of the light source. Defaults to 45 degrees from horizontal.

Notes

For backwards compatibility, the parameters *hsv_min_val*, *hsv_max_val*, *hsv_min_sat*, and *hsv_max_sat* may be supplied at initialization as well. However, these parameters will only be used if “blend_mode=’hsv” is passed into *shade()* or *shade_rgb()*. See the documentation for *blend_hsv()* for more details.

blend_hsv(*rgb*, *intensity*, *hsv_max_sat=None*, *hsv_max_val=None*, *hsv_min_val=None*, *hsv_min_sat=None*)

Take the input data array, convert to HSV values in the given colormap, then adjust those color values to give the impression of a shaded relief map with a specified light source. RGBA values are returned, which can then be used to plot the shaded image with *imshow*.

The color of the resulting image will be darkened by moving the (s,v) values (in hsv colorspace) toward (hsv_min_sat, hsv_min_val) in the shaded regions, or lightened by sliding (s,v) toward (hsv_max_sat, hsv_max_val) in regions that are illuminated. The default extremes are chosen so that completely shaded points are nearly black (s = 1, v = 0) and completely illuminated points are nearly white (s = 0, v = 1).

Parameters *rgb* : ndarray

An MxNx3 RGB array of floats ranging from 0 to 1 (color image).

intensity : ndarray

An MxNx1 array of floats ranging from 0 to 1 (grayscale image).

hsv_max_sat : number, optional

The maximum saturation value that the *intensity* map can shift the output image to. Defaults to 1.

hsv_min_sat : number, optional

The minimum saturation value that the *intensity* map can shift the output image to. Defaults to 0.

hsv_max_val : number, optional

The maximum value (“v” in “hsv”) that the *intensity* map can shift the output image to. Defaults to 1.

hsv_min_val: number, optional

The minimum value (“v” in “hsv”) that the *intensity* map can shift the output image to. Defaults to 0.

Returns *rgb* : ndarray

An MxNx3 RGB array representing the combined images.

blend_overlay(*rgb*, *intensity*)

Combines an *rgb* image with an *intensity* map using “overlay” blending.

Parameters *rgb* : ndarray

An MxNx3 RGB array of floats ranging from 0 to 1 (color image).

intensity : ndarray

An MxNx1 array of floats ranging from 0 to 1 (grayscale image).

Returns rgb : ndarray

An MxNx3 RGB array representing the combined images.

blend_soft_light(*rgb, intensity*)

Combines an rgb image with an intensity map using “soft light” blending. Uses the “pegtop” formula.

Parameters rgb : ndarray

An MxNx3 RGB array of floats ranging from 0 to 1 (color image).

intensity : ndarray

An MxNx1 array of floats ranging from 0 to 1 (grayscale image).

Returns rgb : ndarray

An MxNx3 RGB array representing the combined images.

hillshade(*elevation, vert_exag=1, dx=1, dy=1, fraction=1.0*)

Calculates the illumination intensity for a surface using the defined azimuth and elevation for the light source.

Imagine an artificial sun placed at infinity in some azimuth and elevation position illuminating our surface. The parts of the surface that slope toward the sun should brighten while those sides facing away should become darker.

Parameters elevation : array-like

A 2d array (or equivalent) of the height values used to generate an illumination map

vert_exag : number, optional

The amount to exaggerate the elevation values by when calculating illumination. This can be used either to correct for differences in units between the x-y coordinate system and the elevation coordinate system (e.g. decimal degrees vs meters) or to exaggerate or de-emphasize topographic effects.

dx : number, optional

The x-spacing (columns) of the input *elevation* grid.

dy : number, optional

The y-spacing (rows) of the input *elevation* grid.

fraction : number, optional

Increases or decreases the contrast of the hillshade. Values greater than one will cause intermediate values to move closer to full illumination or shadow (and clipping any values that move beyond 0 or 1). Note that this is not visually or mathematically the same as vertical exaggeration.

Returns

intensity : ndarray

A 2d array of illumination values between 0-1, where 0 is completely in shadow and 1 is completely illuminated.

shade(*data*, *cmap*, *norm=None*, *blend_mode='overlay'*, *vmin=None*, *vmax=None*, *vert_exag=1*, *dx=1*, *dy=1*, *fraction=1*, ***kwargs*)
Combine colormapped data values with an illumination intensity map (a.k.a. “hillshade”) of the values.

Parameters data : array-like

A 2d array (or equivalent) of the height values used to generate a shaded map.

cmap : *Colormap* instance

The colormap used to color the *data* array. Note that this must be a *Colormap* instance. For example, rather than passing in *cmap='gist_earth'*, use *cmap=plt.get_cmap('gist_earth')* instead.

norm : *Normalize* instance, optional

The normalization used to scale values before colormapping. If *None*, the input will be linearly scaled between its min and max.

blend_mode : {‘hsv’, ‘overlay’, ‘soft’} or callable, optional

The type of blending used to combine the colormapped data values with the illumination intensity. Default is “overlay”. Note that for most topographic surfaces, “overlay” or “soft” appear more visually realistic. If a user-defined function is supplied, it is expected to combine an $M \times N \times 3$ RGB array of floats (ranging 0 to 1) with an $M \times N \times 1$ hillshade array (also 0 to 1). (Call signature *func(rgb, illum, **kwargs)*) Additional *kwargs* supplied to this function will be passed on to the *blend_mode* function.

vmin : scalar or *None*, optional

The minimum value used in colormapping *data*. If *None* the minimum value in *data* is used. If *norm* is specified, then this argument will be ignored.

vmax : scalar or *None*, optional

The maximum value used in colormapping *data*. If *None* the maximum value in *data* is used. If *norm* is specified, then this argument will be ignored.

vert_exag : number, optional

The amount to exaggerate the elevation values by when calculating illumination. This can be used either to correct for differences in units between the x-y coordinate system and the elevation coordinate system (e.g. decimal degrees vs meters) or to exaggerate or de-emphasize topography.

dx : number, optional

The x-spacing (columns) of the input *elevation* grid.

dy : number, optional

The y-spacing (rows) of the input *elevation* grid.

fraction : number, optional

Increases or decreases the contrast of the hillshade. Values greater than one will cause intermediate values to move closer to full illumination or shadow (and clipping any values that move beyond 0 or 1). Note that this is not visually or mathematically the same as vertical exaggeration.

Additional kwargs are passed on to the **blend_mode function.**

Returns rgba : ndarray

An MxNx4 array of floats ranging between 0-1.

shade_rgb(*rgb*, *elevation*, *fraction=1.0*, *blend_mode='hsv'*, *vert_exag=1*, *dx=1*, *dy=1*, ***kwargs*)

Take the input RGB array (*ny*nx*3*) adjust their color values to given the impression of a shaded relief map with a specified light source using the elevation (*ny*nx*). A new RGB array (*(ny*nx*3)*) is returned.

Parameters rgb : array-like

An MxNx3 RGB array, assumed to be in the range of 0 to 1.

elevation : array-like

A 2d array (or equivalent) of the height values used to generate a shaded map.

fraction : number

Increases or decreases the contrast of the hillshade. Values greater than one will cause intermediate values to move closer to full illumination or shadow (and clipping any values that move beyond 0 or 1). Note that this is not visually or mathematically the same as vertical exaggeration.

blend_mode : { 'hsv', 'overlay', 'soft' } or callable, optional

The type of blending used to combine the colormapped data values with the illumination intensity. For backwards compatibility, this defaults to "hsv". Note that for most topographic surfaces, "overlay" or "soft" appear more visually realistic. If a user-defined function is supplied, it is expected to combine an MxNx3 RGB array of floats (ranging 0 to 1) with an MxNx1 hillshade array (also 0 to 1). (Call signature `func(rgb, illum, **kwargs)`) Additional kwargs supplied to this function will be passed on to the *blend_mode* function.

vert_exag : number, optional

The amount to exaggerate the elevation values by when calculating illumination. This can be used either to correct for differences in units between the x-y coordinate system and the elevation coordinate system (e.g. decimal degrees vs meters) or to exaggerate or de-emphasize topography.

dx : number, optional

The x-spacing (columns) of the input *elevation* grid.

dy : number, optional

The y-spacing (rows) of the input *elevation* grid.

Additional kwargs are passed on to the **blend_mode function.**

Returns *shaded_rgb* : ndarray

An MxNx3 array of floats ranging between 0-1.

```
class matplotlib.colors.LinearSegmentedColormap(name, segmentdata, N=256,
                                                gamma=1.0)
```

Bases: *matplotlib.colors.Colormap*

Colormap objects based on lookup tables using linear segments.

The lookup table is generated using linear interpolation for each primary color, with the 0-1 domain divided into any number of segments.

Create color map from linear mapping segments

segmentdata argument is a dictionary with a red, green and blue entries. Each entry should be a list of *x, y0, y1* tuples, forming rows in a table. Entries for alpha are optional.

Example: suppose you want red to increase from 0 to 1 over the bottom half, green to do the same over the middle half, and blue over the top half. Then you would use:

```
cdict = {'red': [(0.0, 0.0, 0.0),
                (0.5, 1.0, 1.0),
                (1.0, 1.0, 1.0)],
         'green': [(0.0, 0.0, 0.0),
                  (0.25, 0.0, 0.0),
                  (0.75, 1.0, 1.0),
                  (1.0, 1.0, 1.0)],
         'blue': [(0.0, 0.0, 0.0),
                  (0.5, 0.0, 0.0),
                  (1.0, 1.0, 1.0)]}
```

Each row in the table for a given color is a sequence of *x, y0, y1* tuples. In each sequence, *x* must increase monotonically from 0 to 1. For any input value *z* falling between *x[i]* and *x[i+1]*, the output value of a given color will be linearly interpolated between *y1[i]* and *y0[i+1]*:

```
row i:   x  y0  y1
         /
row i+1: x  y0  y1
```

Hence *y0* in the first row and *y1* in the last row are never used.

See also:

`LinearSegmentedColormap.from_list()` Static method; factory function for generating a smoothly-varying `LinearSegmentedColormap`.

`makeMappingArray()` For information about making a mapping array.

static from_list(*name*, *colors*, *N*=256, *gamma*=1.0)

Make a linear segmented colormap with *name* from a sequence of *colors* which evenly transitions from `colors[0]` at `val=0` to `colors[-1]` at `val=1`. *N* is the number of rgb quantization levels. Alternatively, a list of (value, color) tuples can be given to divide the range unevenly.

set_gamma(*gamma*)

Set a new gamma value and regenerate color map.

class matplotlib.colors.ListedColormap(*colors*, *name*='from_list', *N*=None)

Bases: `matplotlib.colors.Colormap`

Colormap object generated from a list of colors.

This may be most useful when indexing directly into a colormap, but it can also be used to generate special colormaps for ordinary mapping.

Make a colormap from a list of colors.

colors a list of matplotlib color specifications, or an equivalent Nx3 or Nx4 floating point array (*N* rgb or rgba values)

name a string to identify the colormap

N the number of entries in the map. The default is `None`, in which case there is one colormap entry for each element in the list of colors. If:

```
N < len(colors)
```

the list will be truncated at *N*. If:

```
N > len(colors)
```

the list will be extended by repetition.

class matplotlib.colors.LogNorm(*vmin*=None, *vmax*=None, *clip*=False)

Bases: `matplotlib.colors.Normalize`

Normalize a given value to the 0-1 range on a log scale

If *vmin* or *vmax* is not given, they are initialized from the minimum and maximum value respectively of the first input processed. That is, `__call__(A)` calls `autoscale_None(A)`. If *clip* is `True` and the given value falls outside the range, the returned value will be 0 or 1, whichever is closer. Returns 0 if:

```
vmin==vmax
```

Works with scalars or arrays, including masked arrays. If *clip* is `True`, masked values are set to 1; otherwise they remain masked. Clipping silently defeats the purpose of setting the over, under, and masked colors in the colormap, so it is likely to lead to surprises; therefore the default is `clip = False`.

autoscale(*A*)

Set *vmin*, *vmax* to min, max of *A*.

autoscale_None(*A*)

autoscale only None-valued *vmin* or *vmax*

inverse(*value*)

class matplotlib.colors.NoNorm(*vmin=None, vmax=None, clip=False*)

Bases: [matplotlib.colors.Normalize](#)

Dummy replacement for [Normalize](#), for the case where we want to use indices directly in a [ScalarMappable](#).

If *vmin* or *vmax* is not given, they are initialized from the minimum and maximum value respectively of the first input processed. That is, `__call__(A)` calls `autoscale_None(A)`. If *clip* is *True* and the given value falls outside the range, the returned value will be 0 or 1, whichever is closer. Returns 0 if:

```
vmin==vmax
```

Works with scalars or arrays, including masked arrays. If *clip* is *True*, masked values are set to 1; otherwise they remain masked. Clipping silently defeats the purpose of setting the over, under, and masked colors in the colormap, so it is likely to lead to surprises; therefore the default is *clip = False*.

inverse(*value*)

class matplotlib.colors.Normalize(*vmin=None, vmax=None, clip=False*)

Bases: object

A class which, when called, can normalize data into the `[0.0, 1.0]` interval.

If *vmin* or *vmax* is not given, they are initialized from the minimum and maximum value respectively of the first input processed. That is, `__call__(A)` calls `autoscale_None(A)`. If *clip* is *True* and the given value falls outside the range, the returned value will be 0 or 1, whichever is closer. Returns 0 if:

```
vmin==vmax
```

Works with scalars or arrays, including masked arrays. If *clip* is *True*, masked values are set to 1; otherwise they remain masked. Clipping silently defeats the purpose of setting the over, under, and masked colors in the colormap, so it is likely to lead to surprises; therefore the default is *clip = False*.

autoscale(*A*)

Set *vmin*, *vmax* to min, max of *A*.

autoscale_None(*A*)

autoscale only None-valued *vmin* or *vmax*

inverse(*value*)

static process_value(*value*)

Homogenize the input *value* for easy and efficient normalization.

value can be a scalar or sequence.

Returns *result*, *is_scalar*, where *result* is a masked array matching *value*. Float dtypes are preserved; integer types with two bytes or smaller are converted to np.float32, and larger types are converted to np.float. Preserving float32 when possible, and using in-place operations, can greatly improve speed for large arrays.

Experimental; we may want to add an option to force the use of float32.

scaled()

return true if vmin and vmax set

class matplotlib.colors.**PowerNorm**(*gamma*, *vmin=None*, *vmax=None*, *clip=False*)

Bases: [matplotlib.colors.Normalize](#)

Normalize a given value to the [0, 1] interval with a power-law scaling. This will clip any negative data points to 0.

autoscale(*A*)

Set *vmin*, *vmax* to min, max of *A*.

autoscale_None(*A*)

autoscale only None-valued *vmin* or *vmax*

inverse(*value*)

class matplotlib.colors.**SymLogNorm**(*linthresh*, *linscale=1.0*, *vmin=None*, *vmax=None*, *clip=False*)

Bases: [matplotlib.colors.Normalize](#)

The symmetrical logarithmic scale is logarithmic in both the positive and negative directions from the origin.

Since the values close to zero tend toward infinity, there is a need to have a range around zero that is linear. The parameter *linthresh* allows the user to specify the size of this range (*-linthresh*, *linthresh*).

linthresh: The range within which the plot is linear (to avoid having the plot go to infinity around zero).

linscale: This allows the linear range (*-linthresh* to *linthresh*) to be stretched relative to the logarithmic range. Its value is the number of decades to use for each half of the linear range. For example, when *linscale* == 1.0 (the default), the space used for the positive and negative halves of the linear range will be equal to one decade in the logarithmic range. Defaults to 1.

autoscale(*A*)

Set *vmin*, *vmax* to min, max of *A*.

autoscale_None(*A*)

autoscale only None-valued *vmin* or *vmax*

inverse(*value*)

`matplotlib.colors.from_levels_and_colors(levels, colors, extend='neither')`

A helper routine to generate a `cmap` and a `norm` instance which behave similar to `contourf`'s `levels` and `colors` arguments.

Parameters `levels` : sequence of numbers

The quantization levels used to construct the *BoundaryNorm*. Values `v` are quantized to level `i` if `lev[i] <= v < lev[i+1]`.

colors : sequence of colors

The fill color to use for each level. If `extend` is “neither” there must be `n_level - 1` colors. For an `extend` of “min” or “max” add one extra color, and for an `extend` of “both” add two colors.

extend : { ‘neither’, ‘min’, ‘max’, ‘both’ }, optional

The behaviour when a value falls out of range of the given levels. See *contourf()* for details.

Returns (`cmap`, `norm`) : tuple containing a *Colormap* and a *Normalize* instance

`matplotlib.colors.get_named_colors_mapping()`

Return the global mapping of names to named colors.

`matplotlib.colors.hsv_to_rgb(hsv)`

convert hsv values in a numpy array to rgb values all values assumed to be in range [0, 1]

Parameters `hsv` : (... , 3) array-like

All values assumed to be in range [0, 1]

Returns `rgb` : (... , 3) ndarray

Colors converted to RGB values in range [0, 1]

`matplotlib.colors.is_color_like(c)`

Return whether `c` can be interpreted as an RGB(A) color.

`matplotlib.colors.makeMappingArray(N, data, gamma=1.0)`

Create an `N`-element 1-d lookup table

`data` represented by a list of `x,y0,y1` mapping correspondences. Each element in this list represents how a value between 0 and 1 (inclusive) represented by `x` is mapped to a corresponding value between 0 and 1 (inclusive). The two values of `y` are to allow for discontinuous mapping functions (say as might be found in a sawtooth) where `y0` represents the value of `y` for values of `x <=` to that given, and `y1` is the value to be used for `x >` than that given). The list must start with `x=0`, end with `x=1`, and all values of `x` must be in increasing order. Values between the given mapping points are determined by simple linear interpolation.

Alternatively, `data` can be a function mapping values between 0 - 1 to 0 - 1.

The function returns an array “result” where `result[x*(N-1)]` gives the closest value for values of `x` between 0 and 1.

`matplotlib.colors.rgb_to_hsv(arr)`

convert float rgb values (in the range [0, 1]), in a numpy array to hsv values.

Parameters arr : (... , 3) array-like

All values must be in the range [0, 1]

Returns hsv : (... , 3) ndarray

Colors converted to hsv values in range [0, 1]

`matplotlib.colors.to_hex(c, keep_alpha=False)`

Convert *c* to a hex color.

Uses the `#rrggbb` format if `keep_alpha` is `False` (the default), `#rrggbbaa` otherwise.

`matplotlib.colors.to_rgb(c)`

Convert *c* to an RGB color, silently dropping the alpha channel.

`matplotlib.colors.to_rgba(c, alpha=None)`

Convert *c* to an RGBA color.

If `alpha` is not `None`, it forces the alpha value, except if *c* is “none” (case-insensitive), which always maps to `(0, 0, 0, 0)`.

`matplotlib.colors.to_rgba_array(c, alpha=None)`

Convert *c* to a `(n, 4)` array of RGBA colors.

If `alpha` is not `None`, it forces the alpha value. If *c* is “none” (case-insensitive) or an empty list, an empty array is returned.

27.1 matplotlib.container

class matplotlib.container.**BarContainer**(*patches, errorbar=None, **kwargs*)

Bases: *matplotlib.container.Container*

class matplotlib.container.**Container**(*kl, label=None*)

Bases: tuple

Base class for containers.

add_callback(*func*)

Adds a callback function that will be called whenever one of the `Artist`'s properties changes.

Returns an *id* that is useful for removing the callback with *remove_callback()* later.

get_children()

get_label()

Get the label used for this artist in the legend.

pchanged()

Fire an event when property changed, calling all of the registered callbacks.

remove()

remove_callback(*oid*)

Remove a callback based on its *id*.

See also:

add_callback() For adding callbacks

set_label(*s*)

Set the label to *s* for auto legend.

ACCEPTS: string or anything printable with '%s' conversion.

set_remove_method(*f*)

```
class matplotlib.container.ErrorbarContainer(lines, has_xerr=False, has_yerr=False,  
                                              **kwargs)
```

Bases: *matplotlib.container.Container*

```
class matplotlib.container.StemContainer(markerline_stemlines_baseline, **kwargs)
```

Bases: *matplotlib.container.Container*

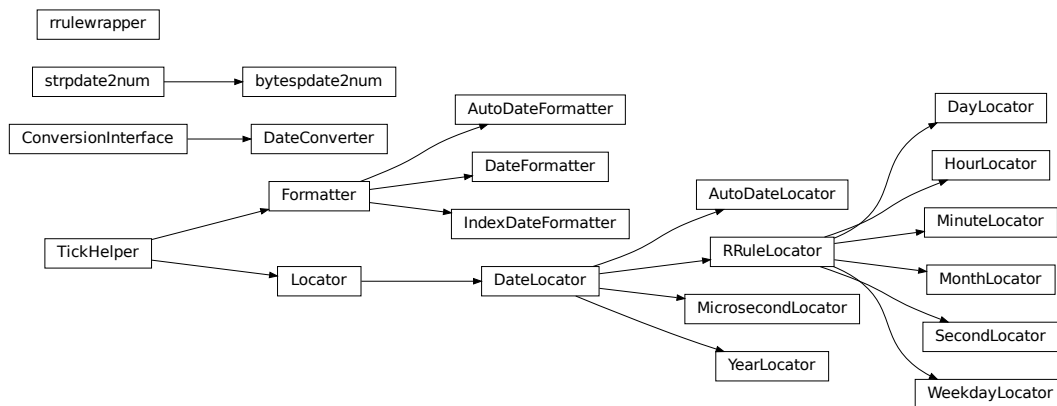

28.1 matplotlib.dates

Matplotlib provides sophisticated date plotting capabilities, standing on the shoulders of python `datetime`, the add-on modules `pytz` and `dateutil`. `datetime` objects are converted to floating point numbers which represent time in days since 0001-01-01 UTC, plus 1. For example, 0001-01-01, 06:00 is 1.25, not 0.25. The helper functions `date2num()`, `num2date()` and `drange()` are used to facilitate easy conversion to and from `datetime` and numeric ranges.

Note: Like Python's `datetime`, `mpl` uses the Gregorian calendar for all conversions between dates and floating point numbers. This practice is not universal, and calendar differences can cause confusing differences between what Python and `mpl` give as the number of days since 0001-01-01 and what other software and databases yield. For example, the US Naval Observatory uses a calendar that switches from Julian to Gregorian in October, 1582. Hence, using their calculator, the number of days between 0001-01-01 and 2006-04-01 is 732403, whereas using the Gregorian calendar via the `datetime` module we find:

```
In [31]:date(2006,4,1).toordinal() - date(1,1,1).toordinal()
Out[31]:732401
```

A wide range of specific and general purpose date tick locators and formatters are provided in this module. See `matplotlib.ticker` for general information on tick locators and formatters. These are described below.

All the matplotlib date converters, tickers and formatters are timezone aware, and the default timezone is given by the `timezone` parameter in your `matplotlibrc` file. If you leave out a `tz` timezone instance, the default from your rc file will be assumed. If you want to use a custom time zone, pass a `pytz.timezone` instance with the `tz` keyword argument to `num2date()`, `plot_date()`, and any custom date tickers or locators you create. See `pytz` for information on `pytz` and timezone handling.

The `dateutil` module provides additional code to handle date ticking, making it easy to place ticks on any kinds of dates. See examples below.

28.1.1 Date tickers

Most of the date tickers can locate single or multiple values. For example:

```
# import constants for the days of the week
from matplotlib.dates import MO, TU, WE, TH, FR, SA, SU

# tick on mondays every week
loc = WeekdayLocator(byweekday=MO, tz=tz)

# tick on mondays and saturdays
loc = WeekdayLocator(byweekday=(MO, SA))
```

In addition, most of the constructors take an interval argument:

```
# tick on mondays every second week
loc = WeekdayLocator(byweekday=MO, interval=2)
```

The rule locator allows completely general date ticking:

```
# tick every 5th easter
rule = rrulewrapper(YEARLY, byeaster=1, interval=5)
loc = RRuleLocator(rule)
```

Here are all the date tickers:

- `MinuteLocator`: locate minutes
- `HourLocator`: locate hours
- `DayLocator`: locate specified days of the month
- `WeekdayLocator`: Locate days of the week, e.g., MO, TU
- `MonthLocator`: locate months, e.g., 7 for July
- `YearLocator`: locate years that are multiples of base

- *RRuleLocator*: locate using a `matplotlib.dates.rrulewrapper`. The `rrulewrapper` is a simple wrapper around a `dateutil.rrule` (`dateutil`) which allow almost arbitrary date tick specifications. See `rrule` example.
- *AutoDateLocator*: On autoscale, this class picks the best `MultipleDateLocator` to set the view limits and the tick locations.

28.1.2 Date formatters

Here all all the date formatters:

- *AutoDateFormatter*: attempts to figure out the best format to use. This is most useful when used with the *AutoDateLocator*.
- *DateFormatter*: use `strftime()` format strings
- *IndexDateFormatter*: date plots with implicit *x* indexing.

`matplotlib.dates.date2num(d)`

d is either a `datetime` instance or a sequence of datetimes.

Return value is a floating point number (or sequence of floats) which gives the number of days (fraction part represents hours, minutes, seconds) since 0001-01-01 00:00:00 UTC, *plus one*. The addition of one here is a historical artifact. Also, note that the Gregorian calendar is assumed; this is not universal practice. For details, see the module docstring.

`matplotlib.dates.num2date(x, tz=None)`

x is a float value which gives the number of days (fraction part represents hours, minutes, seconds) since 0001-01-01 00:00:00 UTC *plus one*. The addition of one here is a historical artifact. Also, note that the Gregorian calendar is assumed; this is not universal practice. For details, see the module docstring.

Return value is a `datetime` instance in timezone *tz* (default to `rcparams` TZ value).

If *x* is a sequence, a sequence of `datetime` objects will be returned.

`matplotlib.dates.drange(dstart, dend, delta)`

Return a date range as float Gregorian ordinals. *dstart* and *dend* are `datetime` instances. *delta* is a `datetime.timedelta` instance.

`matplotlib.dates.epoch2num(e)`

Convert an epoch or sequence of epochs to the new date format, that is days since 0001.

`matplotlib.dates.num2epoch(d)`

Convert days since 0001 to epoch. *d* can be a number or sequence.

`matplotlib.dates.mx2num(mxdates)`

Convert *mx* `datetime` instance (or sequence of *mx* instances) to the new date format.

`class matplotlib.dates.DateFormatter(fmt, tz=None)`

Bases: `matplotlib.ticker.Formatter`

Tick location is seconds since the epoch. Use a `strftime()` format string.

Python only supports datetime `strftime()` formatting for years greater than 1900. Thanks to Andrew Dalke, Dalke Scientific Software who contributed the `strftime()` code below to include dates earlier than this year.

fmt is a `strftime()` format string; *tz* is the `tzinfo` instance.

```
illegal_s = re.compile('((^[^%])(% %)*%s)')
```

```
set_tzinfo(tz)
```

```
strftime(dt, fmt=None)
```

Refer to documentation for `datetime.strftime`.

fmt is a `strftime()` format string.

Warning: For years before 1900, depending upon the current locale it is possible that the year displayed with `%x` might be incorrect. For years before 100, `%y` and `%Y` will yield zero-padded strings.

```
strftime_pre_1900(dt, fmt=None)
```

Call `time.strftime` for years before 1900 by rolling forward a multiple of 28 years.

fmt is a `strftime()` format string.

Dalke: I hope I did this math right. Every 28 years the calendar repeats, except through century leap years excepting the 400 year leap years. But only if you're using the Gregorian calendar.

```
class matplotlib.dates.IndexDateFormatter(t, fmt, tz=None)
```

Bases: `matplotlib.ticker.Formatter`

Use with `IndexLocator` to cycle format strings by index.

t is a sequence of dates (floating point days). *fmt* is a `strftime()` format string.

```
class matplotlib.dates.AutoDateFormatter(locator, tz=None, defaultfmt='%Y-%m-%d')
```

Bases: `matplotlib.ticker.Formatter`

This class attempts to figure out the best format to use. This is most useful when used with the `AutoDateLocator`.

The `AutoDateFormatter` has a scale dictionary that maps the scale of the tick (the distance in days between one major tick) and a format string. The default looks like this:

```
self.scaled = {
    DAYS_PER_YEAR: rcParams['date.autoformat.year'],
    DAYS_PER_MONTH: rcParams['date.autoformat.month'],
    1.0: rcParams['date.autoformat.day'],
    1. / HOURS_PER_DAY: rcParams['date.autoformat.hour'],
    1. / (MINUTES_PER_DAY): rcParams['date.autoformat.minute'],
    1. / (SEC_PER_DAY): rcParams['date.autoformat.second'],
    1. / (MUSECONDS_PER_DAY): rcParams['date.autoformat.microsecond'],
}
```

The algorithm picks the key in the dictionary that is \geq the current scale and uses that format string. You can customize this dictionary by doing:

```
>>> locator = AutoDateLocator()
>>> formatter = AutoDateFormatter(locator)
>>> formatter.scaled[1/(24.*60.)] = '%M:%S' # only show min and sec
```

A custom *FuncFormatter* can also be used. The following example shows how to use a custom format function to strip trailing zeros from decimal seconds and adds the date to the first ticklabel:

```
>>> def my_format_function(x, pos=None):
...     x = matplotlib.dates.num2date(x)
...     if pos == 0:
...         fmt = '%D %H:%M:%S.%f'
...     else:
...         fmt = '%H:%M:%S.%f'
...     label = x.strftime(fmt)
...     label = label.rstrip("0")
...     label = label.rstrip(".")
...     return label
>>> from matplotlib.ticker import FuncFormatter
>>> formatter.scaled[1/(24.*60.)] = FuncFormatter(my_format_function)
```

Autoformat the date labels. The default format is the one to use if none of the values in `self.scaled` are greater than the unit returned by `locator._get_unit()`.

class `matplotlib.dates.DateLocator` (*tz=None*)

Bases: `matplotlib.ticker.Locator`

Determines the tick locations when plotting dates.

tz is a `tzinfo` instance.

datalim_to_dt()

Convert axis data interval to datetime objects.

hms0d = {'byhour': 0, 'byminute': 0, 'bysecond': 0}

nonsingular (*vmin, vmax*)

Given the proposed upper and lower extent, adjust the range if it is too close to being singular (i.e. a range of ~ 0).

set_tzinfo (*tz*)

Set time zone info.

viewlim_to_dt()

Converts the view interval to datetime objects.

class `matplotlib.dates.RRRuleLocator` (*o, tz=None*)

Bases: `matplotlib.dates.DateLocator`

autoscale()

Set the view limits to include the data range.

`static get_unit_generic(freq)`

`tick_values(vmin, vmax)`

`class matplotlib.dates.AutoDateLocator(tz=None, minticks=5, maxticks=None, interval_multiples=False)`

Bases: `matplotlib.dates.DateLocator`

On autoscale, this class picks the best `DateLocator` to set the view limits and the tick locations.

`minticks` is the minimum number of ticks desired, which is used to select the type of ticking (yearly, monthly, etc.).

`maxticks` is the maximum number of ticks desired, which controls any interval between ticks (ticking every other, every 3, etc.). For really fine-grained control, this can be a dictionary mapping individual rule frequency constants (YEARLY, MONTHLY, etc.) to their own maximum number of ticks. This can be used to keep the number of ticks appropriate to the format chosen in `AutoDateFormatter`. Any frequency not specified in this dictionary is given a default value.

`tz` is a `tzinfo` instance.

`interval_multiples` is a boolean that indicates whether ticks should be chosen to be multiple of the interval. This will lock ticks to ‘nicer’ locations. For example, this will force the ticks to be at hours 0,6,12,18 when hourly ticking is done at 6 hour intervals.

The `AutoDateLocator` has an interval dictionary that maps the frequency of the tick (a constant from `dateutil.rule`) and a multiple allowed for that ticking. The default looks like this:

```
self.intervald = {
    YEARLY : [1, 2, 4, 5, 10, 20, 40, 50, 100, 200, 400, 500,
              1000, 2000, 4000, 5000, 10000],
    MONTHLY : [1, 2, 3, 4, 6],
    DAILY : [1, 2, 3, 7, 14],
    HOURLY : [1, 2, 3, 4, 6, 12],
    MINUTELY: [1, 5, 10, 15, 30],
    SECONDLY: [1, 5, 10, 15, 30],
    MICROSECONDLY: [1, 2, 5, 10, 20, 50, 100, 200, 500, 1000, 2000,
                    5000, 10000, 20000, 50000, 100000, 200000, 500000,
                    1000000],
}
```

The interval is used to specify multiples that are appropriate for the frequency of ticking. For instance, every 7 days is sensible for daily ticks, but for minutes/seconds, 15 or 30 make sense. You can customize this dictionary by doing:

```
locator = AutoDateLocator()
locator.intervald[HOURLY] = [3] # only show every 3 hours
```

`autoscale()`

Try to choose the view limits intelligently.

get_locator(*dmin, dmax*)

Pick the best locator based on a distance.

nonsingular(*vmin, vmax*)

refresh()

Refresh internal information based on current limits.

set_axis(*axis*)

tick_values(*vmin, vmax*)

class matplotlib.dates.**YearLocator**(*base=1, month=1, day=1, tz=None*)

Bases: [matplotlib.dates.DateLocator](#)

Make ticks on a given day of each year that is a multiple of base.

Examples:

```
# Tick every year on Jan 1st
locator = YearLocator()

# Tick every 5 years on July 4th
locator = YearLocator(5, month=7, day=4)
```

Mark years that are multiple of base on a given month and day (default jan 1).

autoscale()

Set the view limits to include the data range.

tick_values(*vmin, vmax*)

class matplotlib.dates.**MonthLocator**(*bymonth=None, bymonthday=1, interval=1, tz=None*)

Bases: [matplotlib.dates.RRuleLocator](#)

Make ticks on occurrences of each month *month*, e.g., 1, 3, 12.

Mark every month in *bymonth*; *bymonth* can be an int or sequence. Default is `range(1, 13)`, i.e. every month.

interval is the interval between each iteration. For example, if `interval=2`, mark every second occurrence.

class matplotlib.dates.**WeekdayLocator**(*byweekday=1, interval=1, tz=None*)

Bases: [matplotlib.dates.RRuleLocator](#)

Make ticks on occurrences of each weekday.

Mark every weekday in *byweekday*; *byweekday* can be a number or sequence.

Elements of *byweekday* must be one of MO, TU, WE, TH, FR, SA, SU, the constants from `dateutil.rrule`, which have been imported into the `matplotlib.dates` namespace.

interval specifies the number of weeks to skip. For example, `interval=2` plots every second week.

class `matplotlib.dates.DayLocator`(*bymonthday=None, interval=1, tz=None*)

Bases: `matplotlib.dates.RRuleLocator`

Make ticks on occurrences of each day of the month. For example, 1, 15, 30.

Mark every day in *bymonthday*; *bymonthday* can be an int or sequence.

Default is to tick every day of the month: `bymonthday=range(1, 32)`

class `matplotlib.dates.HourLocator`(*byhour=None, interval=1, tz=None*)

Bases: `matplotlib.dates.RRuleLocator`

Make ticks on occurrences of each hour.

Mark every hour in *byhour*; *byhour* can be an int or sequence. Default is to tick every hour: `byhour=range(24)`

interval is the interval between each iteration. For example, if `interval=2`, mark every second occurrence.

class `matplotlib.dates.MinuteLocator`(*byminute=None, interval=1, tz=None*)

Bases: `matplotlib.dates.RRuleLocator`

Make ticks on occurrences of each minute.

Mark every minute in *byminute*; *byminute* can be an int or sequence. Default is to tick every minute: `byminute=range(60)`

interval is the interval between each iteration. For example, if `interval=2`, mark every second occurrence.

class `matplotlib.dates.SecondLocator`(*bysecond=None, interval=1, tz=None*)

Bases: `matplotlib.dates.RRuleLocator`

Make ticks on occurrences of each second.

Mark every second in *bysecond*; *bysecond* can be an int or sequence. Default is to tick every second: `bysecond = range(60)`

interval is the interval between each iteration. For example, if `interval=2`, mark every second occurrence.

class `matplotlib.dates.MicrosecondLocator`(*interval=1, tz=None*)

Bases: `matplotlib.dates.DateLocator`

Make ticks on occurrences of each microsecond.

interval is the interval between each iteration. For example, if `interval=2`, mark every second microsecond.

set_axis(*axis*)

set_data_interval(*vmin, vmax*)

`set_view_interval(vmin, vmax)`

`tick_values(vmin, vmax)`

```
class matplotlib.dates.rrule(freq, dtstart=None, interval=1, wkst=None, count=None, until=None, bysetpos=None, bymonth=None, bymonthday=None, byyearday=None, byeaster=None, byweekno=None, byweekday=None, byhour=None, byminute=None, bysecond=None, cache=False)
```

Bases: `dateutil.rrule.rrulebase`

That's the base of the rrule operation. It accepts all the keywords defined in the RFC as its constructor parameters (except byday, which was renamed to byweekday) and more. The constructor prototype is:

```
rrule(freq)
```

Where freq must be one of YEARLY, MONTHLY, WEEKLY, DAILY, HOURLY, MINUTELY, or SECONDLY.

Note: Per RFC section 3.3.10, recurrence instances falling on invalid dates and times are ignored rather than coerced:

Recurrence rules may generate recurrence instances with an invalid date (e.g., February 30) or nonexistent local time (e.g., 1:30 AM on a day where the local time is moved forward by an hour at 1:00 AM). Such recurrence instances **MUST** be ignored and **MUST NOT** be counted as part of the recurrence set.

This can lead to possibly surprising behavior when, for example, the start date occurs at the end of the month:

```
>>> from dateutil.rrule import rrule, MONTHLY
>>> from datetime import datetime
>>> start_date = datetime(2014, 12, 31)
>>> list(rrule(freq=MONTHLY, count=4, dtstart=start_date))
...
[datetime.datetime(2014, 12, 31, 0, 0),
 datetime.datetime(2015, 1, 31, 0, 0),
 datetime.datetime(2015, 3, 31, 0, 0),
 datetime.datetime(2015, 5, 31, 0, 0)]
```

Additionally, it supports the following keyword arguments:

Parameters

- **cache** – If given, it must be a boolean value specifying to enable or disable caching of results. If you will use the same rrule instance multiple times, enabling caching will improve the performance considerably.

- **dtstart** – The recurrence start. Besides being the base for the recurrence, missing parameters in the final recurrence instances will also be extracted from this date. If not given, `datetime.now()` will be used instead.
- **interval** – The interval between each freq iteration. For example, when using `YEARLY`, an interval of 2 means once every two years, but with `HOURLY`, it means once every two hours. The default interval is 1.
- **wkst** – The week start day. Must be one of the `MO`, `TU`, `WE` constants, or an integer, specifying the first day of the week. This will affect recurrences based on weekly periods. The default week start is got from `calendar.firstweekday()`, and may be modified by `calendar.setfirstweekday()`.
- **count** – How many occurrences will be generated.

Note: As of version 2.5.0, the use of the `until` keyword together with the `count` keyword is deprecated per RFC-2445 Sec. 4.3.10.

- **until** – If given, this must be a datetime instance, that will specify the limit of the recurrence. The last recurrence in the rule is the greatest datetime that is less than or equal to the value specified in the `until` parameter.

Note: As of version 2.5.0, the use of the `until` keyword together with the `count` keyword is deprecated per RFC-2445 Sec. 4.3.10.

- **bysetpos** – If given, it must be either an integer, or a sequence of integers, positive or negative. Each given integer will specify an occurrence number, corresponding to the nth occurrence of the rule inside the frequency period. For example, a `bysetpos` of -1 if combined with a `MONTHLY` frequency, and a `byweekday` of (`MO`, `TU`, `WE`, `TH`, `FR`), will result in the last work day of every month.
- **bymonth** – If given, it must be either an integer, or a sequence of integers, meaning the months to apply the recurrence to.
- **bymonthday** – If given, it must be either an integer, or a sequence of integers, meaning the month days to apply the recurrence to.
- **byyearday** – If given, it must be either an integer, or a sequence of integers, meaning the year days to apply the recurrence to.
- **byweekno** – If given, it must be either an integer, or a sequence of integers, meaning the week numbers to apply the recurrence to. Week numbers have the meaning described in ISO8601, that is, the first week of the year is that containing at least four days of the new year.
- **byweekday** – If given, it must be either an integer (`0 == MO`), a sequence of integers, one of the weekday constants (`MO`, `TU`, etc), or a sequence of these constants. When given, these variables will define the weekdays where the recurrence will be applied. It's also possible to use an argument `n` for the weekday instances, which will mean the nth occurrence of this weekday in the period. For

example, with MONTHLY, or with YEARLY and BYMONTH, using FR(+1) in byweekday will specify the first friday of the month where the recurrence happens. Notice that in the RFC documentation, this is specified as BYDAY, but was renamed to avoid the ambiguity of that keyword.

- **byhour** – If given, it must be either an integer, or a sequence of integers, meaning the hours to apply the recurrence to.
- **byminute** – If given, it must be either an integer, or a sequence of integers, meaning the minutes to apply the recurrence to.
- **bysecond** – If given, it must be either an integer, or a sequence of integers, meaning the seconds to apply the recurrence to.
- **byeaster** – If given, it must be either an integer, or a sequence of integers, positive or negative. Each integer will define an offset from the Easter Sunday. Passing the offset 0 to byeaster will yield the Easter Sunday itself. This is an extension to the RFC specification.

replace(kwargs)**

Return new rrule with same attributes except for those attributes given new values by whichever keyword arguments are specified.

```
class matplotlib.dates.relativedelta(dt1=None, dt2=None, years=0, months=0, days=0,
                                     leapdays=0, weeks=0, hours=0, minutes=0, seconds=0,
                                     microseconds=0, year=None, month=None, day=None,
                                     weekday=None, yearday=None, nlyear-day=None,
                                     hour=None, minute=None, second=None,
                                     microsecond=None)
```

Bases: object

The relativedelta type is based on the specification of the excellent work done by M.-A. Lemburg in his `mx.DateTime` extension. However, notice that this type does *NOT* implement the same algorithm as his work. Do *NOT* expect it to behave like `mx.DateTime`'s counterpart.

There are two different ways to build a relativedelta instance. The first one is passing it two date/datetime classes:

```
relativedelta(datetime1, datetime2)
```

The second one is passing it any number of the following keyword arguments:

```
relativedelta(arg1=x, arg2=y, arg3=z...)
```

year, month, day, hour, minute, second, microsecond:

Absolute information (argument **is** singular); adding **or** subtracting a relativedelta **with** absolute information does **not** perform an arithmetic operation, but rather REPLACES the corresponding value **in** the original datetime **with** the value(s) **in** relativedelta.

years, months, weeks, days, hours, minutes, seconds, microseconds:

Relative information, may be negative (argument **is** plural); adding **or** subtracting a relativedelta **with** relative information performs the corresponding arithmetic operation on the original datetime value

with the information **in** the `relativedelta`.

weekday:

One of the weekday instances (MO, TU, etc). These instances may receive a parameter N, specifying the Nth weekday, which could be positive **or** negative (like MO(+1) **or** MO(-2)). Not specifying it **is** the same **as** specifying +1. You can also use an integer, where 0=MO.

leapdays:

Will add given days to the date found, **if** year **is** a leap year, **and** the date found **is** post 28 of february.

yearday, nlyearday:

Set the yearday **or** the non-leap year day (jump leap days). These are converted to day/month/leapdays information.

Here is the behavior of operations with `relativedelta`:

1. Calculate the absolute year, using the 'year' argument, or the original datetime year, if the argument is not present.
2. Add the relative 'years' argument to the absolute year.
3. Do steps 1 and 2 for month/months.
4. Calculate the absolute day, using the 'day' argument, or the original datetime day, if the argument is not present. Then, subtract from the day until it fits in the year and month found after their operations.
5. Add the relative 'days' argument to the absolute day. Notice that the 'weeks' argument is multiplied by 7 and added to 'days'.
6. Do steps 1 and 2 for hour/hours, minute/minutes, second/seconds, microsecond/microseconds.
7. If the 'weekday' argument is present, calculate the weekday, with the given (wday, nth) tuple. wday is the index of the weekday (0-6, 0=Mon), and nth is the number of weeks to add forward or backward, depending on its signal. Notice that if the calculated date is already Monday, for example, using (0, 1) or (0, -1) won't change the day.

normalized()

Return a version of this object represented entirely using integer values for the relative attributes.

```
>>> relativedelta(days=1.5, hours=2).normalized()
relativedelta(days=1, hours=14)
```

Returns Returns a `dateutil.relativedelta.relativedelta` object.

weeks

`matplotlib.dates.seconds(s)`

Return seconds as days.

`matplotlib.dates.minutes(m)`

Return minutes as days.

`matplotlib.dates.hours(h)`

Return hours as days.

`matplotlib.dates.weeks(w)`

Return weeks as days.

29.1 matplotlib.dviread

An experimental module for reading dvi files output by TeX. Several limitations make this not (currently) useful as a general-purpose dvi preprocessor, but it is currently used by the pdf backend for processing usetex text.

Interface:

```
dvi = Dvi(filename, 72)
# iterate over pages (but only one page is supported for now):
for page in dvi:
    w, h, d = page.width, page.height, page.descent
    for x,y,font,glyph,width in page.text:
        fontname = font.texname
        pointsize = font.size
        ...
    for x,y,height,width in page.bboxes:
        ...
```

class matplotlib.dviread.Dvi(*filename, dpi*)

Bases: object

A dvi (“device-independent”) file, as produced by TeX. The current implementation only reads the first page and does not even attempt to verify the postamble.

Initialize the object. This takes the filename as input and opens the file; actually reading the file happens when iterating through the pages of the file.

close()

Close the underlying file if it is open.

class matplotlib.dviread.DviFont(*scale, tfm, texname, vf*)

Bases: object

Object that holds a font’s texname and size, supports comparison, and knows the widths of glyphs in the same units as the AFM file. There are also internal attributes (for use by dviread.py) that are *not* used for comparison.

The size is in Adobe points (converted from TeX points).

texname

Name of the font as used internally by TeX and friends. This is usually very different from any external font names, and `dviread.PsfontsMap` can be used to find the external name of the font.

size

Size of the font in Adobe points, converted from the slightly smaller TeX points.

widths

Widths of glyphs in glyph-space units, typically 1/1000ths of the point size.

size**texname****widths**

class `matplotlib.dviread.Encoding`(*filename*)

Bases: object

Parses a *.enc file referenced from a psfonts.map style file. The format this class understands is a very limited subset of PostScript.

Usage (subject to change):

```
for name in Encoding(filename):
    whatever(name)
```

encoding

class `matplotlib.dviread.PsfontsMap`(*filename*)

Bases: object

A psfonts.map formatted file, mapping TeX fonts to PS fonts. Usage:

```
>>> map = PsfontsMap(find_tex_file('pdftex.map'))
>>> entry = map['ptmbo8r']
>>> entry.texname
'ptmbo8r'
>>> entry.psname
'Times-Bold'
>>> entry.encoding
'/usr/local/texlive/2008/texmf-dist/fonts/enc/dvips/base/8r.enc'
>>> entry.effects
{'slant': 0.16700000000000001}
>>> entry.filename
```

For historical reasons, TeX knows many Type-1 fonts by different names than the outside world. (For one thing, the names have to fit in eight characters.) Also, TeX's native fonts are not Type-1 but Metafont, which is nontrivial to convert to PostScript except as a bitmap. While high-quality conversions to Type-1 format exist and are shipped with modern TeX distributions, we need to know

which Type-1 fonts are the counterparts of which native fonts. For these reasons a mapping is needed from internal font names to font file names.

A texmf tree typically includes mapping files called e.g. psfonts.map, pdftex.map, dvipdfm.map. psfonts.map is used by dvips, pdftex.map by pdfTeX, and dvipdfm.map by dvipdfm. psfonts.map might avoid embedding the 35 PostScript fonts (i.e., have no filename for them, as in the Times-Bold example above), while the pdf-related files perhaps only avoid the “Base 14” pdf fonts. But the user may have configured these files differently.

class matplotlib.dviread.**Tfm**(*filename*)

Bases: object

A TeX Font Metric file. This implementation covers only the bare minimum needed by the Dvi class.

checksum

Used for verifying against the dvi file.

design_size

Design size of the font (in what units?)

width

Width of each character, needs to be scaled by the factor specified in the dvi file. This is a dict because indexing may not start from 0.

height

Height of each character.

depth

Depth of each character.

checksum

depth

design_size

height

width

class matplotlib.dviread.**Vf**(*filename*)

Bases: *matplotlib.dviread.Dvi*

A virtual font (*.vf file) containing subroutines for dvi files.

Usage:

```
vf = Vf(filename)
glyph = vf[code]
glyph.text, glyph.bboxes, glyph.width
```

`matplotlib.dviread.find_tex_file(filename, format=None)`

Call **kpsewhich** to find a file in the texmf tree. If *format* is not `None`, it is used as the value for the `--format` option.

Apparently most existing TeX distributions on Unix-like systems use `kpathsea`. I hear MikTeX (a popular distribution on Windows) doesn't use `kpathsea`, so what do we do? (TODO)

See also:

[Kpathsea documentation](#) The library that **kpsewhich** is part of.

`matplotlib.dviread.ord(x)`

30.1 matplotlib.figure

The figure module provides the top-level *Artist*, the *Figure*, which contains all the plot elements. The following classes are defined

SubplotParams control the default spacing of the subplots

Figure top level container for all plot elements

class matplotlib.figure.**AxesStack**

Bases: *matplotlib.cbook.Stack*

Specialization of the Stack to handle all tracking of Axes in a Figure. This stack stores *key*, (*ind*, *axes*) pairs, where:

- **key** should be a hash of the args and kwargs used in generating the Axes.
- **ind** is a serial number for tracking the order in which axes were added.

The AxesStack is a callable, where *ax_stack()* returns the current axes. Alternatively the *current_key_axes()* will return the current key and associated axes.

add(*key*, *a*)

Add Axes *a*, with key *key*, to the stack, and return the stack.

If *a* is already on the stack, don't add it again, but return *None*.

as_list()

Return a list of the Axes instances that have been added to the figure

bubble(*a*)

Move the given axes, which must already exist in the stack, to the top.

current_key_axes()

Return a tuple of (*key*, *axes*) for the active axes.

If no axes exists on the stack, then returns (*None*, *None*).

get(*key*)

Return the Axes instance that was added with *key*. If it is not present, return *None*.

remove(*a*)

Remove the axes from the stack.

class matplotlib.figure.Figure(*figsize=None, dpi=None, facecolor=None, edgecolor=None, linewidth=0.0, frameon=None, subplotpars=None, tight_layout=None*)

Bases: *matplotlib.artist.Artist*

The Figure instance supports callbacks through a *callbacks* attribute which is a *matplotlib.cbook.CallbackRegistry* instance. The events you can connect to are ‘dpi_changed’, and the callback will be called with `func(fig)` where *fig* is the *Figure* instance.

patch The figure patch is drawn by a *matplotlib.patches.Rectangle* instance

suppressComposite For multiple figure images, the figure will make composite images depending on the renderer option `image_nocomposite` function. If `suppressComposite` is `True|False`, this will override the renderer.

figsize w,h tuple in inches

dpi Dots per inch

facecolor The figure patch facecolor; defaults to `rc figure.facecolor`

edgecolor The figure patch edge color; defaults to `rc figure.edgecolor`

linewidth The figure patch edge linewidth; the default linewidth of the frame

frameon If `False`, suppress drawing the figure frame

subplotpars A *SubplotParams* instance, defaults to `rc`

tight_layout If `False` use *subplotpars*; if `True` adjust subplot parameters using `tight_layout()` with default padding. When providing a dict containing the keys `pad`, `w_pad`, `h_pad` and `rect`, the default `tight_layout()` paddings will be overridden. Defaults to `rc figure.autolayout`.

add_axes(**args, **kwargs*)

Add an axes at position *rect* [*left, bottom, width, height*] where all quantities are in fractions of figure width and height. *kwargs* are legal *Axes* *kwargs* plus *projection* which sets the projection type of the axes. (For backward compatibility, `polar=True` may also be provided, which is equivalent to `projection='polar'`). Valid values for *projection* are: [`'aitoff'`, `'hammer'`, `'lambert'`, `'mollweide'`, `'polar'`, `'rectilinear'`]. Some of these projections support additional *kwargs*, which may be provided to `add_axes()`. Typical usage:

```
rect = l,b,w,h
fig.add_axes(rect)
fig.add_axes(rect, frameon=False, facecolor='g')
fig.add_axes(rect, polar=True)
fig.add_axes(rect, projection='polar')
fig.add_axes(ax)
```

If the figure already has an axes with the same parameters, then it will simply make that axes current and return it. If you do not want this behavior, e.g., you want to force the creation of a new *Axes*, you must use a unique set of *args* and *kwargs*. The axes `label` attribute has been

exposed for this purpose. e.g., if you want two axes that are otherwise identical to be added to the figure, make sure you give them unique labels:

```
fig.add_axes(rect, label='axes1')
fig.add_axes(rect, label='axes2')
```

In rare circumstances, `add_axes` may be called with a single argument, an `Axes` instance already created in the present figure but not in the figure's list of axes. For example, if an axes has been removed with `delaxes()`, it can be restored with:

```
fig.add_axes(ax)
```

In all cases, the `Axes` instance will be returned.

In addition to *projection*, the following kwargs are supported:

Property	Description
<code>adjustable</code>	['box' 'datalim' 'box-forced']
<code>agg_filter</code>	unknown
<code>alpha</code>	float (0.0 transparent through 1.0 opaque)
<code>anchor</code>	unknown
<code>animated</code>	[True False]
<code>aspect</code>	unknown
<code>autoscale_on</code>	unknown
<code>autoscalex_on</code>	unknown
<code>autoscaley_on</code>	unknown
<code>axes</code>	an <code>Axes</code> instance
<code>axes_locator</code>	unknown
<code>axisbelow</code>	[<i>True</i> <i>False</i> 'line']
<code>clip_box</code>	a <code>matplotlib.transforms.Bbox</code> instance
<code>clip_on</code>	[True False]
<code>clip_path</code>	[(<code>Path</code> , <code>Transform</code>) <code>Patch</code> None]
<code>color_cycle</code>	unknown
<code>contains</code>	a callable function
<code>facecolor</code>	unknown
<code>fc</code>	unknown
<code>figure</code>	unknown
<code>frame_on</code>	[<i>True</i> <i>False</i>]
<code>gid</code>	an id string
<code>label</code>	string or anything printable with '%s' conversion.
<code>navigate</code>	[<i>True</i> <i>False</i>]
<code>navigate_mode</code>	unknown
<code>path_effects</code>	unknown
<code>picker</code>	[None float boolean callable]
<code>position</code>	unknown
<code>rasterization_zorder</code>	unknown
<code>rasterized</code>	[True False None]

Continued on next page

Table 30.1 – continued from previous page

Property	Description
<i>sketch_params</i>	unknown
<i>snap</i>	unknown
<code>title</code>	unknown
<i>transform</i>	<i>Transform</i> instance
<i>url</i>	a url string
<i>visible</i>	[True False]
<code>xbound</code>	unknown
<code>xlabel</code>	unknown
<code>xlim</code>	unknown
<code>xmargin</code>	unknown
<code>xscale</code>	['linear' 'log' 'logit' 'symlog']
<code>xticklabels</code>	sequence of strings
<code>xticks</code>	sequence of floats
<code>ybound</code>	unknown
<code>ylabel</code>	unknown
<code>ylim</code>	unknown
<code>ymargin</code>	unknown
<code>yscale</code>	['linear' 'log' 'logit' 'symlog']
<code>yticklabels</code>	sequence of strings
<code>yticks</code>	sequence of floats
<i>zorder</i>	any number

add_axobserver(*func*)

whenever the axes state change, `func(self)` will be called

add_subplot(**args*, ***kwargs*)

Add a subplot. Examples:

```
fig.add_subplot(111)

# equivalent but more general
fig.add_subplot(1,1,1)

# add subplot with red background
fig.add_subplot(212, facecolor='r')

# add a polar subplot
fig.add_subplot(111, projection='polar')

# add Subplot instance sub
fig.add_subplot(sub)
```

kwargs are legal *Axes* *kwargs* plus *projection*, which chooses a projection type for the axes. (For backward compatibility, *polar=True* may also be provided, which is equivalent to *projection='polar'*). Valid values for *projection* are: ['aitoff', 'hammer', 'lambert', 'mollweide', 'po-

lar', 'rectilinear']. Some of these projections support additional *kwargs*, which may be provided to `add_axes()`.

The *Axes* instance will be returned.

If the figure already has a subplot with key (*args*, *kwargs*) then it will simply make that subplot current and return it.

See also:

`subplot()` for an explanation of the args.

The following *kwargs* are supported:

Property	Description
<code>adjustable</code>	['box' 'datalim' 'box-forced']
<code>agg_filter</code>	unknown
<code>alpha</code>	float (0.0 transparent through 1.0 opaque)
<code>anchor</code>	unknown
<code>animated</code>	[True False]
<code>aspect</code>	unknown
<code>autoscale_on</code>	unknown
<code>autoscalex_on</code>	unknown
<code>autoscaley_on</code>	unknown
<code>axes</code>	an <i>Axes</i> instance
<code>axes_locator</code>	unknown
<code>axisbelow</code>	[True False 'line']
<code>clip_box</code>	a <code>matplotlib.transforms.Bbox</code> instance
<code>clip_on</code>	[True False]
<code>clip_path</code>	[(<i>Path</i> , <i>Transform</i>) <i>Patch</i> None]
<code>color_cycle</code>	unknown
<code>contains</code>	a callable function
<code>facecolor</code>	unknown
<code>fc</code>	unknown
<code>figure</code>	unknown
<code>frame_on</code>	[True False]
<code>gid</code>	an id string
<code>label</code>	string or anything printable with '%s' conversion.
<code>navigate</code>	[True False]
<code>navigate_mode</code>	unknown
<code>path_effects</code>	unknown
<code>picker</code>	[None float boolean callable]
<code>position</code>	unknown
<code>rasterization_zorder</code>	unknown
<code>rasterized</code>	[True False None]
<code>sketch_params</code>	unknown
<code>snap</code>	unknown
<code>title</code>	unknown

Continued on next page

Table 30.2 – continued from previous page

Property	Description
<i>transform</i>	<i>Transform</i> instance
<i>url</i>	a url string
<i>visible</i>	[True False]
<i>xbound</i>	unknown
<i>xlabel</i>	unknown
<i>xlim</i>	unknown
<i>xmargin</i>	unknown
<i>xscale</i>	['linear' 'log' 'logit' 'symlog']
<i>xticklabels</i>	sequence of strings
<i>xticks</i>	sequence of floats
<i>ybound</i>	unknown
<i>ylabel</i>	unknown
<i>ylim</i>	unknown
<i>ymargin</i>	unknown
<i>yscale</i>	['linear' 'log' 'logit' 'symlog']
<i>yticklabels</i>	sequence of strings
<i>yticks</i>	sequence of floats
<i>zorder</i>	any number

autofmt_xdate(*bottom=0.2, rotation=30, ha='right'*)

Date ticklabels often overlap, so it is useful to rotate them and right align them. Also, a common use case is a number of subplots with shared xaxes where the x-axis is date data. The ticklabels are often long, and it helps to rotate them on the bottom subplot and turn them off on other subplots, as well as turn off xlabels.

bottom The bottom of the subplots for *subplots_adjust()*

rotation The rotation of the xtick labels

ha The horizontal alignment of the xticklabels

axes

Read-only: list of axes in Figure

clear()

Clear the figure – synonym for *clf()*.

clf(*keep_observers=False*)

Clear the figure.

Set *keep_observers* to True if, for example, a gui widget is tracking the axes in the figure.

colorbar(*mappable, cax=None, ax=None, use_gridspec=True, **kw*)

Create a colorbar for a *ScalarMappable* instance, *mappable*.

Documentation for the pylab thin wrapper:

Add a colorbar to a plot.

Function signatures for the *pyplot* interface; all but the first are also method signatures for the *colorbar()* method:

```
colorbar(**kwargs)
colorbar(mappable, **kwargs)
colorbar(mappable, cax=cax, **kwargs)
colorbar(mappable, ax=ax, **kwargs)
```

arguments:

mappable the Image, ContourSet, etc. to which the colorbar applies; this argument is mandatory for the *colorbar()* method but optional for the *colorbar()* function, which sets the default to the current image.

keyword arguments:

cax None | axes object into which the colorbar will be drawn

ax None | parent axes object(s) from which space for a new colorbar axes will be stolen. If a list of axes is given they will all be resized to make room for the colorbar axes.

use_gridspec False | If *cax* is None, a new *cax* is created as an instance of Axes. If *ax* is an instance of Subplot and *use_gridspec* is True, *cax* is created as an instance of Subplot using the *grid_spec* module.

Additional keyword arguments are of two kinds:

axes properties:

Property	Description
<i>orientation</i>	vertical or horizontal
<i>fraction</i>	0.15; fraction of original axes to use for colorbar
<i>pad</i>	0.05 if vertical, 0.15 if horizontal; fraction of original axes between colorbar and new image axes
<i>shrink</i>	1.0; fraction by which to shrink the colorbar
<i>aspect</i>	20; ratio of long to short dimensions
<i>anchor</i>	(0.0, 0.5) if vertical; (0.5, 1.0) if horizontal; the anchor point of the colorbar axes
<i>panchor</i>	(1.0, 0.5) if vertical; (0.5, 0.0) if horizontal; the anchor point of the colorbar parent axes. If False, the parent axes' anchor will be unchanged

colorbar properties:

Property	Description
<i>extend</i>	['neither' 'both' 'min' 'max'] If not 'neither', make pointed end(s) for out-of-range values. These are set for a given colormap using the colormap <code>set_under</code> and <code>set_over</code> methods.
<i>extendfrac</i>	[<i>None</i> 'auto' length lengths] If set to <i>None</i> , both the minimum and maximum triangular colorbar extensions will have a length of 5% of the interior colorbar length (this is the default setting). If set to 'auto', makes the triangular colorbar extensions the same lengths as the interior boxes (when <i>spacing</i> is set to 'uniform') or the same lengths as the respective adjacent interior boxes (when <i>spacing</i> is set to 'proportional'). If a scalar, indicates the length of both the minimum and maximum triangular colorbar extensions as a fraction of the interior colorbar length. A two-element sequence of fractions may also be given, indicating the lengths of the minimum and maximum colorbar extensions respectively as a fraction of the interior colorbar length.
<i>extended</i>	[<i>False</i> <i>True</i>] If <i>False</i> the minimum and maximum colorbar extensions will be triangular (the default). If <i>True</i> the extensions will be rectangular.
<i>spacing</i>	['uniform' 'proportional'] Uniform spacing gives each discrete color the same space; proportional makes the space proportional to the data interval.
<i>ticks</i>	[<i>None</i> list of ticks Locator object] If <i>None</i> , ticks are determined automatically from the input.
<i>format</i>	[<i>None</i> format string Formatter object] If <i>None</i> , the <i>ScalarFormatter</i> is used. If a format string is given, e.g., '%.3f', that is used. An alternative <i>Formatter</i> object may be given instead.
<i>drawedges</i>	[<i>False</i> <i>True</i>] If true, draw lines at color boundaries.

The following will probably be useful only in the context of indexed colors (that is, when the mappable has `norm=NoNorm()`), or other unusual circumstances.

Property	Description
<i>boundaries</i>	<i>None</i> or a sequence
<i>values</i>	<i>None</i> or a sequence which must be of length 1 less than the sequence of <i>boundaries</i> . For each region delimited by adjacent entries in <i>boundaries</i> , the color mapped to the corresponding value in values will be used.

If *mappable* is a `ContourSet`, its *extend* kwarg is included automatically.

Note that the *shrink* kwarg provides a simple way to keep a vertical colorbar, for example, from being taller than the axes of the mappable to which the colorbar is attached; but it is a manual method requiring some trial and error. If the colorbar is too tall (or a horizontal colorbar is too wide) use a smaller value of *shrink*.

For more precise control, you can manually specify the positions of the axes objects in which the mappable and the colorbar are drawn. In this case, do not use any of the axes properties kwargs.

It is known that some vector graphics viewer (svg and pdf) renders white gaps between segments of the colorbar. This is due to bugs in the viewers not matplotlib. As a workaround the colorbar can be rendered with overlapping segments:

```
cbar = colorbar()
cbar.solids.set_edgecolor("face")
draw()
```

However this has negative consequences in other circumstances. Particularly with semi transparent images ($\alpha < 1$) and colorbar extensions and is not enabled by default see (issue #1188).

returns: *Colorbar* instance; see also its base class, *ColorbarBase*. Call the *set_label()* method to label the colorbar.

contains(*mouseevent*)

Test whether the mouse event occurred on the figure.

Returns True, { }

delaxes(*a*)

remove *a* from the figure and update the current axes

dpi

draw(*artist*, *renderer*, **args*, ***kwargs*)

Render the figure using *matplotlib.backend_bases.RendererBase* instance *renderer*.

draw_artist(*a*)

draw *matplotlib.artist.Artist* instance *a* only – this is available only after the figure is drawn

figimage(*X*, *xo=0*, *yo=0*, *alpha=None*, *norm=None*, *cmap=None*, *vmin=None*, *vmax=None*, *origin=None*, *resize=False*, ***kwargs*)

Adds a non-resampled image to the figure.

call signatures:

```
figimage(X, **kwargs)
```

adds a non-resampled array *X* to the figure.

```
figimage(X, xo, yo)
```

with pixel offsets *xo*, *yo*,

X must be a float array:

- If *X* is *MxN*, assume luminance (grayscale)
- If *X* is *MxNx3*, assume RGB
- If *X* is *MxNx4*, assume RGBA

Optional keyword arguments:

Key-word	Description
re-size	a boolean, True or False. If “True”, then re-size the Figure to match the given image size.
xo or yo	An integer, the <i>x</i> and <i>y</i> image offset in pixels
cmap	a <code>matplotlib.colors.Colormap</code> instance, e.g., <code>cm.jet</code> . If <i>None</i> , default to the <code>rc image.cmap</code> value
norm	a <code>matplotlib.colors.Normalize</code> instance. The default is <code>normalization()</code> . This scales luminance -> 0-1
vmin vmax	used to scale a luminance image to 0-1. If either is <i>None</i> , the min and max of the luminance values will be used. Note if you pass a <code>norm</code> instance, the settings for <i>vmin</i> and <i>vmax</i> will be ignored.
al-pha	the alpha blending value, default is <i>None</i>
ori-gin	[‘upper’ ‘lower’] Indicates where the [0,0] index of the array is in the upper left or lower left corner of the axes. Defaults to the <code>rc image.origin</code> value

`figimage` complements the axes image (`imshow()`) which will be resampled to fit the current axes. If you want a resampled image to fill the entire figure, you can define an `Axes` with extent `[0,0,1,1]`.

An `matplotlib.image.FigureImage` instance is returned.

Additional kwargs are Artist kwargs passed on to *FigureImage*

`gca(**kwargs)`

Get the current axes, creating one if necessary

The following kwargs are supported for ensuring the returned axes adheres to the given projection etc., and for axes creation if the active axes does not exist:

Property	Description
<code>adjustable</code>	['box' 'datalim' 'box-forced']
<code>agg_filter</code>	unknown
<code>alpha</code>	float (0.0 transparent through 1.0 opaque)
<code>anchor</code>	unknown
<code>animated</code>	[True False]
<code>aspect</code>	unknown
<code>autoscale_on</code>	unknown
<code>autoscalex_on</code>	unknown
<code>autoscaley_on</code>	unknown
<code>axes</code>	an <i>Axes</i> instance
<code>axes_locator</code>	unknown
<code>axisbelow</code>	[<i>True</i> <i>False</i> 'line']
<code>clip_box</code>	a <i>matplotlib.transforms.Bbox</i> instance
<code>clip_on</code>	[True False]
Continued on next page	

Table 30.3 – continued from previous page

Property	Description
<i>clip_path</i>	[(<i>Path</i> , <i>Transform</i>) <i>Patch</i> None]
color_cycle	unknown
<i>contains</i>	a callable function
facecolor	unknown
fc	unknown
figure	unknown
frame_on	[<i>True</i> <i>False</i>]
<i>gid</i>	an id string
<i>label</i>	string or anything printable with ‘%s’ conversion.
navigate	[<i>True</i> <i>False</i>]
navigate_mode	unknown
<i>path_effects</i>	unknown
<i>picker</i>	[None float boolean callable]
position	unknown
rasterization_zorder	unknown
<i>rasterized</i>	[<i>True</i> <i>False</i> None]
<i>sketch_params</i>	unknown
<i>snap</i>	unknown
title	unknown
<i>transform</i>	<i>Transform</i> instance
<i>url</i>	a url string
<i>visible</i>	[<i>True</i> <i>False</i>]
xbound	unknown
xlabel	unknown
xlim	unknown
xmargin	unknown
xscale	[‘linear’ ‘log’ ‘logit’ ‘symlog’]
xticklabels	sequence of strings
xticks	sequence of floats
ybound	unknown
ylabel	unknown
ylim	unknown
ymargin	unknown
yscale	[‘linear’ ‘log’ ‘logit’ ‘symlog’]
yticklabels	sequence of strings
yticks	sequence of floats
<i>zorder</i>	any number

get_axes()

get_children()

get a list of artists contained in the figure

get_default_bbox_extra_artists()

get_dpi()

Return the dpi as a float

get_edgecolor()

Get the edge color of the Figure rectangle

get_facecolor()

Get the face color of the Figure rectangle

get_figheight()

Return the figheight as a float

get_figwidth()

Return the figwidth as a float

get_frameon()

get the boolean indicating frameon

get_size_inches()

Returns the current size of the figure in inches (1in == 2.54cm) as a numpy array.

Returns size : ndarray

The size of the figure in inches

See also:

`matplotlib.Figure.set_size_inches`

get_tight_layout()

Return the Boolean flag, True to use :meth'tight_layout' when drawing.

get_tightbbox(*renderer*)

Return a (tight) bounding box of the figure in inches.

It only accounts axes title, axis labels, and axis ticklabels. Needs improvement.

get_window_extent(args, **kwargs*)**

get the figure bounding box in display space; kwargs are void

ginput(*n=1, timeout=30, show_clicks=True, mouse_add=1, mouse_pop=3, mouse_stop=2*)

Blocking call to interact with the figure.

This will wait for *n* clicks from the user and return a list of the coordinates of each click.

If *timeout* is zero or negative, does not timeout.

If *n* is zero or negative, accumulate clicks until a middle click (or potentially both mouse buttons at once) terminates the input.

Right clicking cancels last input.

The buttons used for the various actions (adding points, removing points, terminating the inputs) can be overridden via the arguments *mouse_add*, *mouse_pop* and *mouse_stop*, that give the associated mouse button: 1 for left, 2 for middle, 3 for right.

The keyboard can also be used to select points in case your mouse does not have one or more of the buttons. The delete and backspace keys act like right clicking (i.e., remove last point), the enter key terminates input and any other key (not already used by the window manager) selects a point.

hold(*b=None*)

Deprecated since version 2.0: The hold function was deprecated in version 2.0.

Set the hold state. If hold is None (default), toggle the hold state. Else set the hold state to boolean value b.

e.g.:

```
hold()      # toggle hold
hold(True)  # hold is on
hold(False) # hold is off
```

All “hold” machinery is deprecated.

legend(*handles, labels, *args, **kwargs*)

Place a legend in the figure. Labels are a sequence of strings, handles is a sequence of *Line2D* or *Patch* instances, and loc can be a string or an integer specifying the legend location

USAGE:

```
legend( (line1, line2, line3),
        ('label1', 'label2', 'label3'),
        'upper right')
```

The *loc* location codes are:

```
'best' : 0,          (currently not supported for figure legends)
'upper right' : 1,
'upper left' : 2,
'lower left' : 3,
'lower right' : 4,
'right' : 5,
'center left' : 6,
'center right' : 7,
'lower center' : 8,
'upper center' : 9,
'center' : 10,
```

loc can also be an (x,y) tuple in figure coords, which specifies the lower left of the legend box. figure coords are (0,0) is the left, bottom of the figure and 1,1 is the right, top.

Keyword arguments:

prop: [*None* | *FontProperties* | *dict*] A *matplotlib.font_manager.FontProperties* instance. If *prop* is a dictionary, a new instance will be created with *prop*. If *None*, use rc settings.

numpoints: *integer* The number of points in the legend line, default is 4

scatterpoints: *integer* The number of points in the legend line, default is 4

- scatteryoffsets:** **list of floats** a list of yoffsets for scatter symbols in legend
- markerscale:** [*None* | **scalar**] The relative size of legend markers vs. original. If *None*, use rc settings.
- markerfirst:** [*True* | *False*] if *True*, legend marker is placed to the left of the legend label if *False*, legend marker is placed to the right of the legend label
- frameon:** [*None* | **bool**] Control whether the legend should be drawn on a patch (frame). Default is *None* which will take the value from the `legend.frameon` *rcParam*.
- fancybox:** [*None* | *False* | *True*] if *True*, draw a frame with a round fancybox. If *None*, use rc
- shadow:** [*None* | *False* | *True*] If *True*, draw a shadow behind legend. If *None*, use rc settings.
- framealpha:** [*None* | **float**] Control the alpha transparency of the legend's background. Default is *None* which will take the value from the `legend.framealpha` *rcParam*.
- facecolor:** [*None* | "inherit" | **a color spec**] Control the legend's background color. Default is *None* which will take the value from the `legend.facecolor` *rcParam*. If "inherit", it will take the axes.`facecolor` *rcParam*.
- edgecolor:** [*None* | "inherit" | **a color spec**] Control the legend's background patch edge color. Default is *None* which will take the value from the `legend.edgecolor` *rcParam*. If "inherit", it will take the axes.`edgecolor` *rcParam*.
- ncol** [integer] number of columns. default is 1
- mode** [["expand" | *None*]] if mode is "expand", the legend will be horizontally expanded to fill the axes area (or `bbox_to_anchor`)
- title** [string] the legend title

Padding and spacing between various elements use following keywords parameters. The dimensions of these values are given as a fraction of the fontsize. Values from rcParams will be used if None.

Keyword	Description
<code>borderpad</code>	the fractional whitespace inside the legend border
<code>labelspacing</code>	the vertical space between the legend entries
<code>handlelength</code>	the length of the legend handles
<code>handletextpad</code>	the pad between the legend handle and text
<code>borderaxespad</code>	the pad between the axes and legend border
<code>columnspacing</code>	the spacing between columns

Note: Not all kinds of artist are supported by the legend. See [LINK \(FIXME\)](#) for details.

Example:

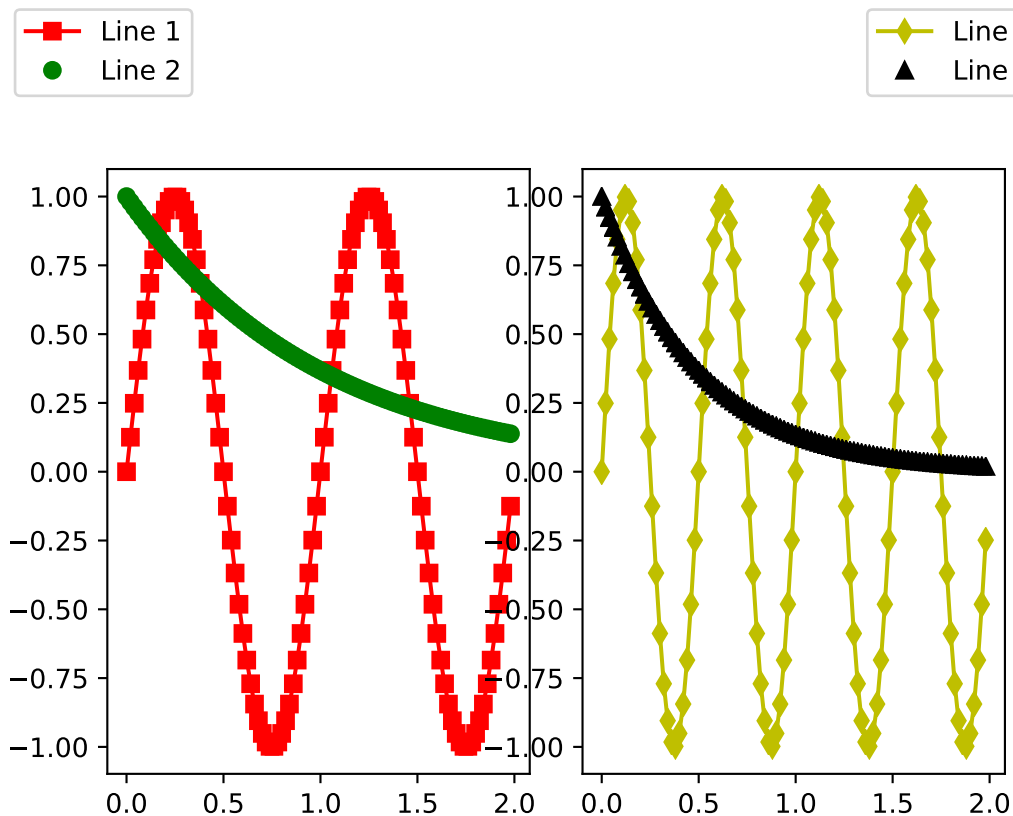

savefig(*args, **kwargs)

Save the current figure.

Call signature:

```
savefig(fname, dpi=None, facecolor='w', edgecolor='w',
        orientation='portrait', papertype=None, format=None,
        transparent=False, bbox_inches=None, pad_inches=0.1,
        frameon=None)
```

The output formats available depend on the backend being used.

Arguments:

fname: A string containing a path to a filename, or a Python file-like object, or possibly some backend-dependent object such as *PdfPages*.

If *format* is *None* and *fname* is a string, the output format is deduced from the extension of the filename. If the filename has no extension, the value of the rc parameter `savefig.format` is used.

If *fname* is not a string, remember to specify *format* to ensure that the correct backend is used.

Keyword arguments:

dpi: [*None* | **scalar** > 0 | 'figure'] The resolution in dots per inch. If *None* it will

default to the value `savefig.dpi` in the `matplotlibrc` file. If `'figure'` it will set the dpi to be the value of the figure.

facecolor, edgecolor: the colors of the figure rectangle

orientation: [`'landscape'` | `'portrait'`] not supported on all backends; currently only on postscript output

papertype: One of `'letter'`, `'legal'`, `'executive'`, `'ledger'`, `'a0'` through `'a10'`, `'b0'` through `'b10'`. Only supported for postscript output.

format: One of the file extensions supported by the active backend. Most backends support `png`, `pdf`, `ps`, `eps` and `svg`.

transparent: If *True*, the axes patches will all be transparent; the figure patch will also be transparent unless `facecolor` and/or `edgecolor` are specified via `kwargs`. This is useful, for example, for displaying a plot on top of a colored background on a web page. The transparency of these patches will be restored to their original values upon exit of this function.

frameon: If *True*, the figure patch will be colored, if *False*, the figure background will be transparent. If not provided, the `rcParam` `'savefig.frameon'` will be used.

bbox_inches: Bbox in inches. Only the given portion of the figure is saved. If `'tight'`, try to figure out the tight bbox of the figure.

pad_inches: Amount of padding around the figure when `bbox_inches` is `'tight'`.

bbox_extra_artists: A list of extra artists that will be considered when the tight bbox is calculated.

sca(*a*)

Set the current axes to be *a* and return *a*

set_canvas(*canvas*)

Set the canvas that contains the figure

ACCEPTS: a `FigureCanvas` instance

set_dpi(*val*)

Set the dots-per-inch of the figure

ACCEPTS: float

set_edgecolor(*color*)

Set the edge color of the Figure rectangle

ACCEPTS: any matplotlib color - see `help(colors)`

set_facecolor(*color*)

Set the face color of the Figure rectangle

ACCEPTS: any matplotlib color - see `help(colors)`

set_figheight(*val*, *forward=False*)

Set the height of the figure in inches

ACCEPTS: float

set_figwidth(*val*, *forward=False*)
Set the width of the figure in inches

ACCEPTS: float

set_frameon(*b*)
Set whether the figure frame (background) is displayed or invisible

ACCEPTS: boolean

set_size_inches(*w*, *h=None*, *forward=True*)
Set the figure size in inches (1 in == 2.54cm)

Usage

```
fig.set_size_inches(w,h) # OR
fig.set_size_inches((w,h))
```

optional kwarg *forward=True* will cause the canvas size to be automatically updated; e.g., you can resize the figure window from the shell

ACCEPTS: a w,h tuple with w,h in inches

See also:

`matplotlib.Figure.get_size_inches`

set_tight_layout(*tight*)
Set whether `tight_layout()` is used upon drawing. If None, the rcParams['figure.autolayout'] value will be set.

When providing a dict containing the keys `pad`, `w_pad`, `h_pad` and `rect`, the default `tight_layout()` paddings will be overridden.

ACCEPTS: [True | False | dict | None]

show(*warn=True*)
If using a GUI backend with pyplot, display the figure window.

If the figure was not created using `figure()`, it will lack a `FigureManagerBase`, and will raise an `AttributeError`.

For non-GUI backends, this does nothing, in which case a warning will be issued if *warn* is True (default).

subplots_adjust(**args*, ***kwargs*)
Call signature:

```
subplots_adjust(left=None, bottom=None, right=None, top=None,
                wspace=None, hspace=None)
```

Update the `SubplotParams` with *kwargs* (defaulting to rc when None) and update the subplot locations

suptitle(*t*, ***kwargs*)
Add a centered title to the figure.

kwargs are `matplotlib.text.Text` properties. Using figure coordinates, the defaults are:

x [0.5] The x location of the text in figure coords

y [0.98] The y location of the text in figure coords

horizontalalignment ['center'] The horizontal alignment of the text

verticalalignment ['top'] The vertical alignment of the text

If the `fontproperties` keyword argument is given then the rcParams defaults for `fontsize` (`figure.titlesize`) and `fontweight` (`figure.titleweight`) will be ignored in favour of the `FontProperties` defaults.

A `matplotlib.text.Text` instance is returned.

Example:

```
fig.suptitle('this is the figure title', fontsize=12)
```

text(*x, y, s, *args, **kwargs*)

Add text to figure.

Call signature:

```
text(x, y, s, fontdict=None, **kwargs)
```

Add text to figure at location *x, y* (relative 0-1 coords). See `text()` for the meaning of the other arguments.

kwargs control the `Text` properties:

Property	Description
<code>agg_filter</code>	unknown
<code>alpha</code>	float (0.0 transparent through 1.0 opaque)
<code>animated</code>	[True False]
<code>axes</code>	an <code>Axes</code> instance
<code>backgroundcolor</code>	any matplotlib color
<code>bbox</code>	FancyBboxPatch prop dict
<code>clip_box</code>	a <code>matplotlib.transforms.Bbox</code> instance
<code>clip_on</code>	[True False]
<code>clip_path</code>	[(<code>Path, Transform</code>) <code>Patch</code> None]
<code>color</code>	any matplotlib color
<code>contains</code>	a callable function
<code>family</code> or <code>fontfamily</code> or <code>fontname</code> or <code>name</code>	[FONTNAME 'serif' 'sans-serif' 'cursive' 'fantasy' 'monospace']
<code>figure</code>	a <code>matplotlib.figure.Figure</code> instance
<code>fontproperties</code> or <code>font_properties</code>	a <code>matplotlib.font_manager.FontProperties</code> instance
<code>gid</code>	an id string
<code>horizontalalignment</code> or <code>ha</code>	['center' 'right' 'left']
<code>label</code>	string or anything printable with '%s' conversion.
<code>linespacing</code>	float (multiple of font size)

Table 30.4 – continued from

Property	Description
<i>multialignment</i>	['left' 'right' 'center']
<i>path_effects</i>	unknown
<i>picker</i>	[None float boolean callable]
<i>position</i>	(x,y)
<i>rasterized</i>	[True False None]
<i>rotation</i>	[angle in degrees 'vertical' 'horizontal']
<i>rotation_mode</i>	unknown
<i>size</i> or <i>fontsize</i>	[size in points 'xx-small' 'x-small' 'small' 'medium' 'large' 'x-large']
<i>sketch_params</i>	unknown
<i>snap</i>	unknown
<i>stretch</i> or <i>fontstretch</i>	[a numeric value in range 0-1000 'ultra-condensed' 'extra-condensed' 'c
<i>style</i> or <i>fontstyle</i>	['normal' 'italic' 'oblique']
<i>text</i>	string or anything printable with '%s' conversion.
<i>transform</i>	<i>Transform</i> instance
<i>url</i>	a url string
<i>usetex</i>	unknown
<i>variant</i> or <i>fontvariant</i>	['normal' 'small-caps']
<i>verticalalignment</i> or <i>ma</i> or <i>va</i>	['center' 'top' 'bottom' 'baseline']
<i>visible</i>	[True False]
<i>weight</i> or <i>fontweight</i>	[a numeric value in range 0-1000 'ultralight' 'light' 'normal' 'regular'
<i>wrap</i>	unknown
<i>x</i>	float
<i>y</i>	float
<i>zorder</i>	any number

tight_layout (*renderer=None, pad=1.08, h_pad=None, w_pad=None, rect=None*)

Adjust subplot parameters to give specified padding.

Parameters:

pad [float] padding between the figure edge and the edges of subplots, as a fraction of the font-size.

h_pad, w_pad [float] padding (height/width) between edges of adjacent subplots. Defaults to `pad_inches`.

rect [if `rect` is given, it is interpreted as a rectangle] (left, bottom, right, top) in the normalized figure coordinate that the whole subplots area (including labels) will fit into. Default is (0, 0, 1, 1).

waitforbuttonpress (*timeout=-1*)

Blocking call to interact with the figure.

This will return True if a key was pressed, False if a mouse button was pressed and None if *timeout* was reached without either being pressed.

If *timeout* is negative, does not timeout.

class matplotlib.figure.**SubplotParams**(*left=None, bottom=None, right=None, top=None, wspace=None, hspace=None*)

Bases: object

A class to hold the parameters for a subplot

All dimensions are fraction of the figure width or height. All values default to their rc params

The following attributes are available

left [0.125] The left side of the subplots of the figure

right [0.9] The right side of the subplots of the figure

bottom [0.1] The bottom of the subplots of the figure

top [0.9] The top of the subplots of the figure

wspace [0.2] The amount of width reserved for blank space between subplots, expressed as a fraction of the average axis width

hspace [0.2] The amount of height reserved for white space between subplots, expressed as a fraction of the average axis height

update(*left=None, bottom=None, right=None, top=None, wspace=None, hspace=None*)

Update the current values. If any kwarg is None, default to the current value, if set, otherwise to rc

matplotlib.figure.**figaspect**(*arg*)

Create a figure with specified aspect ratio. If *arg* is a number, use that aspect ratio. If *arg* is an array, figaspect will determine the width and height for a figure that would fit array preserving aspect ratio. The figure width, height in inches are returned. Be sure to create an axes with equal width and height, e.g.,

Example usage:

```
# make a figure twice as tall as it is wide
w, h = figaspect(2.)
fig = Figure(figsize=(w,h))
ax = fig.add_axes([0.1, 0.1, 0.8, 0.8])
ax.imshow(A, **kwargs)

# make a figure with the proper aspect for an array
A = rand(5,3)
w, h = figaspect(A)
fig = Figure(figsize=(w,h))
ax = fig.add_axes([0.1, 0.1, 0.8, 0.8])
ax.imshow(A, **kwargs)
```

Thanks to Fernando Perez for this function

31.1 `matplotlib.finance`

A collection of functions for collecting, analyzing and plotting financial data.

This module is deprecated in 2.0 and has been moved to a module called `mpl_finance`.

`matplotlib.finance.candlestick2_ochl` (*ax*, *opens*, *closes*, *highs*, *lows*, *width=4*, *colorup='k'*,
colordown='r', *alpha=0.75*)

Represent the open, close as a bar line and high low range as a vertical line.

Preserves the original argument order.

Parameters *ax* : Axes

an Axes instance to plot to

opens : sequence

sequence of opening values

closes : sequence

sequence of closing values

highs : sequence

sequence of high values

lows : sequence

sequence of low values

ticksize : int

size of open and close ticks in points

colorup : color

the color of the lines where close \geq open

colordown : color

the color of the lines where close $<$ open

alpha : float

bar transparency

Returns ret : tuple

(lineCollection, barCollection)

`matplotlib.finance.candlestick2_ohlc(ax, opens, highs, lows, closes, width=4, colorup='k',
color=down='r', alpha=0.75)`

Represent the open, close as a bar line and high low range as a vertical line.

NOTE: this code assumes if any value open, low, high, close is missing they all are missing

Parameters ax : Axes

an Axes instance to plot to

opens : sequence

sequence of opening values

highs : sequence

sequence of high values

lows : sequence

sequence of low values

closes : sequence

sequence of closing values

ticksize : int

size of open and close ticks in points

colorup : color

the color of the lines where close >= open

colordown : color

the color of the lines where close < open

alpha : float

bar transparency

Returns ret : tuple

(lineCollection, barCollection)

`matplotlib.finance.candlestick_ochl(ax, quotes, width=0.2, colorup='k', colordown='r',
alpha=1.0)`

Plot the time, open, close, high, low as a vertical line ranging from low to high. Use a rectangular bar to represent the open-close span. If close >= open, use colorup to color the bar, otherwise use colordown

Parameters ax : Axes

an Axes instance to plot to

quotes : sequence of (time, open, close, high, low, ...) sequences

As long as the first 5 elements are these values, the record can be as long as you want (e.g., it may store volume).

time must be in float days format - see `date2num`

width : float

fraction of a day for the rectangle width

colorup : color

the color of the rectangle where `close >= open`

colordown : color

the color of the rectangle where `close < open`

alpha : float

the rectangle alpha level

Returns ret : tuple

returns (lines, patches) where lines is a list of lines added and patches is a list of the rectangle patches added

`matplotlib.finance.candlestick_ohlc(ax, quotes, width=0.2, colorup='k', colordown='r', alpha=1.0)`

Plot the time, open, high, low, close as a vertical line ranging from low to high. Use a rectangular bar to represent the open-close span. If `close >= open`, use `colorup` to color the bar, otherwise use `colordown`

Parameters ax : Axes

an Axes instance to plot to

quotes : sequence of (time, open, high, low, close, ...) sequences

As long as the first 5 elements are these values, the record can be as long as you want (e.g., it may store volume).

time must be in float days format - see `date2num`

width : float

fraction of a day for the rectangle width

colorup : color

the color of the rectangle where `close >= open`

colordown : color

the color of the rectangle where `close < open`

alpha : float

the rectangle alpha level

Returns ret : tuple

returns (lines, patches) where lines is a list of lines added and patches is a list of the rectangle patches added

`matplotlib.finance.fetch_historical_yahoo`(*ticker*, *date1*, *date2*, *cachename=None*, *dividends=False*)

Fetch historical data for ticker between date1 and date2. date1 and date2 are date or datetime instances, or (year, month, day) sequences.

Parameters ticker : str

ticker

date1 : sequence of form (year, month, day), `datetime`, or date

start date

date2 : sequence of form (year, month, day), `datetime`, or date

end date

cachename : str

cachename is the name of the local file cache. If None, will default to the md5 hash or the url (which incorporates the ticker and date range)

dividends : bool

set dividends=True to return dividends instead of price data. With this option set, parse functions will not work

Returns file_handle : file handle

a file handle is returned

Examples

```
>>> fh = fetch_historical_yahoo('^GSPC', (2000, 1, 1), (2001, 12, 31))
```

`matplotlib.finance.index_bar`(*ax*, *vals*, *facecolor='b'*, *edgecolor='l'*, *width=4*, *alpha=1.0*)

Add a bar collection graph with height vals (-1 is missing).

Parameters ax : Axes

an Axes instance to plot to

vals : sequence

a sequence of values

facecolor : color

the color of the bar face

edgecolor : color

the color of the bar edges

width : int

the bar width in points

alpha : float

bar transparency

Returns ret : barCollection

The barCollection added to the axes

`matplotlib.finance.md5(x)`

`matplotlib.finance.parse_yahoo_historical_ohl(fh, adjusted=True, asobject=False)`

Parse the historical data in file handle fh from yahoo finance.

Parameters adjusted : bool

If True (default) replace open, close, high, low prices with their adjusted values. The adjustment is by a scale factor, $S = \text{adjusted_close}/\text{close}$. Adjusted prices are actual prices multiplied by S.

Volume is not adjusted as it is already backward split adjusted by Yahoo. If you want to compute dollars traded, multiply volume by the adjusted close, regardless of whether you choose `adjusted = True|False`.

asobject : bool or None

If False (default for compatibility with earlier versions) return a list of tuples containing

d, open, close, high, low, volume

If None (preferred alternative to False), return a 2-D ndarray corresponding to the list of tuples.

Otherwise return a numpy recarray with

date, year, month, day, d, open, close, high, low, volume, adjusted_close

where d is a floating point representation of date, as returned by `date2num`, and date is a python standard library `datetime.date` instance.

The name of this kwarg is a historical artifact. Formerly, True returned a cbook Bunch holding 1-D ndarrays. The behavior of a numpy recarray is very similar to the Bunch.

`matplotlib.finance.parse_yahoo_historical_ohlc(fh, adjusted=True, asobject=False)`

Parse the historical data in file handle fh from yahoo finance.

Parameters adjusted : bool

If True (default) replace open, high, low, close prices with their adjusted values. The adjustment is by a scale factor, $S = \text{adjusted_close}/\text{close}$. Adjusted prices are actual prices multiplied by S.

Volume is not adjusted as it is already backward split adjusted by Yahoo. If you want to compute dollars traded, multiply volume by the adjusted close, regardless of whether you choose `adjusted = True|False`.

asobject : bool or None

If False (default for compatibility with earlier versions) return a list of tuples containing

d, open, high, low, close, volume

If None (preferred alternative to False), return a 2-D ndarray corresponding to the list of tuples.

Otherwise return a numpy recarray with

date, year, month, day, d, open, high, low, close, volume, adjusted_close

where d is a floating point representation of date, as returned by `date2num`, and date is a python standard library `datetime.date` instance.

The name of this kwarg is a historical artifact. Formerly, True returned a cbook Bunch holding 1-D ndarrays. The behavior of a numpy recarray is very similar to the Bunch.

`matplotlib.finance.plot_day_summary2_ochl` (*ax, opens, closes, highs, lows, ticksize=4, colorup='k', colordown='r'*)

Represent the time, open, close, high, low, as a vertical line ranging from low to high. The left tick is the open and the right tick is the close.

Parameters ax : Axes

an Axes instance to plot to

opens : sequence

sequence of opening values

closes : sequence

sequence of closing values

highs : sequence

sequence of high values

lows : sequence

sequence of low values

ticksize : int

size of open and close ticks in points

colorup : color

the color of the lines where close >= open

colordown : color

the color of the lines where close < open

Returns ret : list

a list of lines added to the axes

`matplotlib.finance.plot_day_summary2_ohlc`(*ax, opens, highs, lows, closes, ticksize=4, colorup='k', colordown='r'*)

Represent the time, open, high, low, close as a vertical line ranging from low to high. The left tick is the open and the right tick is the close. *opens, highs, lows* and *closes* must have the same length. NOTE: this code assumes if any value open, high, low, close is missing (-1) they all are missing

Parameters ax : Axes

an Axes instance to plot to

opens : sequence

sequence of opening values

highs : sequence

sequence of high values

lows : sequence

sequence of low values

closes : sequence

sequence of closing values

ticksize : int

size of open and close ticks in points

colorup : color

the color of the lines where close >= open

colordown : color

the color of the lines where close < open

Returns ret : list

a list of lines added to the axes

`matplotlib.finance.plot_day_summary_ohlh`(*ax, quotes, ticksize=3, colorup='k', colordown='r'*)

Plots day summary

Represent the time, open, close, high, low as a vertical line ranging from low to high. The left tick is the open and the right tick is the close.

Parameters ax : Axes

an Axes instance to plot to

quotes : sequence of (time, open, close, high, low, ...) sequences

data to plot. time must be in float date format - see `date2num`

ticksiz : int

open/close tick marker in points

colorup : color

the color of the lines where close \geq open

colordown : color

the color of the lines where close $<$ open

Returns lines : list

list of tuples of the lines added (one tuple per quote)

`matplotlib.finance.plot_day_summary_ohlc`(*ax*, *quotes*, *ticksiz*=3, *colorup*='k', *colordown*='r')

Plots day summary

Represent the time, open, high, low, close as a vertical line ranging from low to high. The left tick is the open and the right tick is the close.

Parameters ax : Axes

an Axes instance to plot to

quotes : sequence of (time, open, high, low, close, ...) sequences

data to plot. time must be in float date format - see `date2num`

ticksiz : int

open/close tick marker in points

colorup : color

the color of the lines where close \geq open

colordown : color

the color of the lines where close $<$ open

Returns lines : list

list of tuples of the lines added (one tuple per quote)

`matplotlib.finance.quotes_historical_yahoo_ochl`(*ticker*, *date1*, *date2*, *asobject*=False, *adjusted*=True, *cachename*=None)

Get historical data for ticker between date1 and date2.

See `parse_yahoo_historical()` for explanation of output formats and the *asobject* and *adjusted* kwargs.

Parameters ticker : str

stock ticker

date1 : sequence of form (year, month, day), datetime, or date
start date

date2 : sequence of form (year, month, day), datetime, or date
end date

cachename : str or None

is the name of the local file cache. If None, will default to the md5 hash or the url (which incorporates the ticker and date range)

Examples

```
>>> sp = f.quotes_historical_yahoo_ochl('^GSPC', d1, d2,
                                     asobject=True, adjusted=True)
>>> returns = (sp.open[1:] - sp.open[:-1])/sp.open[1:]
>>> [n,bins,patches] = hist(returns, 100)
>>> mu = mean(returns)
>>> sigma = std(returns)
>>> x = normpdf(bins, mu, sigma)
>>> plot(bins, x, color='red', lw=2)
```

`matplotlib.finance.quotes_historical_yahoo_ohlc`(*ticker*, *date1*, *date2*, *asobject=False*,
adjusted=True, *cachename=None*)

Get historical data for ticker between date1 and date2.

See `parse_yahoo_historical()` for explanation of output formats and the *asobject* and *adjusted* kwargs.

Parameters ticker : str

stock ticker

date1 : sequence of form (year, month, day), datetime, or date
start date

date2 : sequence of form (year, month, day), datetime, or date
end date

cachename : str or None

is the name of the local file cache. If None, will default to the md5 hash or the url (which incorporates the ticker and date range)

Examples

```
>>> sp = f.quotes_historical_yahoo_ohlc('^GSPC', d1, d2,
                                     asobject=True, adjusted=True)
>>> returns = (sp.open[1:] - sp.open[:-1])/sp.open[1:]
>>> [n,bins,patches] = hist(returns, 100)
```

```
>>> mu = mean(returns)
>>> sigma = std(returns)
>>> x = normpdf(bins, mu, sigma)
>>> plot(bins, x, color='red', lw=2)
```

`matplotlib.finance.volume_overlay`(*ax, opens, closes, volumes, colorup='k', colordown='r', width=4, alpha=1.0*)

Add a volume overlay to the current axes. The opens and closes are used to determine the color of the bar. -1 is missing. If a value is missing on one it must be missing on all

Parameters ax : Axes

an Axes instance to plot to

opens : sequence

a sequence of opens

closes : sequence

a sequence of closes

volumes : sequence

a sequence of volumes

width : int

the bar width in points

colorup : color

the color of the lines where close >= open

colordown : color

the color of the lines where close < open

alpha : float

bar transparency

Returns ret : barCollection

The barCollection added to the axes

`matplotlib.finance.volume_overlay2`(*ax, closes, volumes, colorup='k', colordown='r', width=4, alpha=1.0*)

Add a volume overlay to the current axes. The closes are used to determine the color of the bar. -1 is missing. If a value is missing on one it must be missing on all

nb: first point is not displayed - it is used only for choosing the right color

Parameters ax : Axes

an Axes instance to plot to

closes : sequence

a sequence of closes

volumes : sequence

a sequence of volumes

width : int

the bar width in points

colorup : color

the color of the lines where close \geq open

colordown : color

the color of the lines where close $<$ open

alpha : float

bar transparency

Returns ret : barCollection

The barCollection added to the axes

`matplotlib.finance.volume_overlay3(ax, quotes, colorup='k', colordown='r', width=4, alpha=1.0)`

Add a volume overlay to the current axes. `quotes` is a list of (d, open, high, low, close, volume) and `close-open` is used to determine the color of the bar

Parameters ax : Axes

an Axes instance to plot to

quotes : sequence of (time, open, high, low, close, ...) sequences

data to plot. time must be in float date format - see `date2num`

width : int

the bar width in points

colorup : color

the color of the lines where `close1` \geq `close0`

colordown : color

the color of the lines where `close1` $<$ `close0`

alpha : float

bar transparency

Returns ret : barCollection

The barCollection added to the axes

FONT_MANAGER

32.1 matplotlib.font_manager

A module for finding, managing, and using fonts across platforms.

This module provides a single *FontManager* instance that can be shared across backends and platforms. The *findfont()* function returns the best TrueType (TTF) font file in the local or system font path that matches the specified *FontProperties* instance. The *FontManager* also handles Adobe Font Metrics (AFM) font files for use by the PostScript backend.

The design is based on the [W3C Cascading Style Sheet, Level 1 \(CSS1\) font specification](#). Future versions may implement the Level 2 or 2.1 specifications.

Experimental support is included for using `fontconfig` on Unix variant platforms (Linux, OS X, Solaris). To enable it, set the constant `USE_FONTCONFIG` in this file to `True`. `Fontconfig` has the advantage that it is the standard way to look up fonts on X11 platforms, so if a font is installed, it is much more likely to be found.

```
class matplotlib.font_manager.FontEntry(fname='', name='', style='normal',
                                         variant='normal', weight='normal',
                                         stretch='normal', size='medium')
```

Bases: object

A class for storing Font properties. It is used when populating the font lookup dictionary.

```
class matplotlib.font_manager.FontManager(size=None, weight='normal')
```

Bases: object

On import, the *FontManager* singleton instance creates a list of TrueType fonts based on the font properties: name, style, variant, weight, stretch, and size. The *findfont()* method does a nearest neighbor search to find the font that most closely matches the specification. If no good enough match is found, a default font is returned.

```
findfont(prop, fontext='tff', directory=None, fallback_to_default=True, re-
          build_if_missing=True)
```

Search the font list for the font that most closely matches the *FontProperties* *prop*.

findfont() performs a nearest neighbor search. Each font is given a similarity score to the target font properties. The first font with the highest score is returned. If no matches below a certain threshold are found, the default font (usually DejaVu Sans) is returned.

`directory`, is specified, will only return fonts from the given directory (or subdirectory of that directory).

The result is cached, so subsequent lookups don't have to perform the $O(n)$ nearest neighbor search.

If `fallback_to_default` is True, will fallback to the default font family (usually "DejaVu Sans" or "Helvetica") if the first lookup hard-fails.

See the [W3C Cascading Style Sheet, Level 1](#) documentation for a description of the font finding algorithm.

static get_default_size()

Return the default font size.

get_default_weight()

Return the default font weight.

score_family(*families*, *family2*)

Returns a match score between the list of font families in *families* and the font family name *family2*.

An exact match at the head of the list returns 0.0.

A match further down the list will return between 0 and 1.

No match will return 1.0.

score_size(*size1*, *size2*)

Returns a match score between *size1* and *size2*.

If *size2* (the size specified in the font file) is 'scalable', this function always returns 0.0, since any font size can be generated.

Otherwise, the result is the absolute distance between *size1* and *size2*, normalized so that the usual range of font sizes (6pt - 72pt) will lie between 0.0 and 1.0.

score_stretch(*stretch1*, *stretch2*)

Returns a match score between *stretch1* and *stretch2*.

The result is the absolute value of the difference between the CSS numeric values of *stretch1* and *stretch2*, normalized between 0.0 and 1.0.

score_style(*style1*, *style2*)

Returns a match score between *style1* and *style2*.

An exact match returns 0.0.

A match between 'italic' and 'oblique' returns 0.1.

No match returns 1.0.

score_variant(*variant1*, *variant2*)

Returns a match score between *variant1* and *variant2*.

An exact match returns 0.0, otherwise 1.0.

score_weight(*weight1*, *weight2*)

Returns a match score between *weight1* and *weight2*.

The result is the absolute value of the difference between the CSS numeric values of *weight1* and *weight2*, normalized between 0.0 and 1.0.

set_default_weight(*weight*)

Set the default font weight. The initial value is 'normal'.

update_fonts(*filenames*)

Update the font dictionary with new font files. Currently not implemented.

class matplotlib.font_manager.FontProperties(*family=None*, *style=None*, *variant=None*,
weight=None, *stretch=None*, *size=None*,
fname=None, *_init=None*)

Bases: object

A class for storing and manipulating font properties.

The font properties are those described in the [W3C Cascading Style Sheet, Level 1](#) font specification. The six properties are:

- **family**: A list of font names in decreasing order of priority. The items may include a generic font family name, either 'serif', 'sans-serif', 'cursive', 'fantasy', or 'monospace'. In that case, the actual font to be used will be looked up from the associated rcParam in `matplotlibrc`.
- **style**: Either 'normal', 'italic' or 'oblique'.
- **variant**: Either 'normal' or 'small-caps'.
- **stretch**: A numeric value in the range 0-1000 or one of 'ultra-condensed', 'extra-condensed', 'condensed', 'semi-condensed', 'normal', 'semi-expanded', 'expanded', 'extra-expanded' or 'ultra-expanded'
- **weight**: A numeric value in the range 0-1000 or one of 'ultralight', 'light', 'normal', 'regular', 'book', 'medium', 'roman', 'semibold', 'demibold', 'demi', 'bold', 'heavy', 'extra bold', 'black'
- **size**: Either an relative value of 'xx-small', 'x-small', 'small', 'medium', 'large', 'x-large', 'xx-large' or an absolute font size, e.g., 12

The default font property for TrueType fonts (as specified in the default `matplotlibrc` file) is:

```
sans-serif, normal, normal, normal, normal, scalable.
```

Alternatively, a font may be specified using an absolute path to a .ttf file, by using the *fname* kwarg.

The preferred usage of font sizes is to use the relative values, e.g., 'large', instead of absolute font sizes, e.g., 12. This approach allows all text sizes to be made larger or smaller based on the font manager's default font size.

This class will also accept a `fontconfig` pattern, if it is the only argument provided. See the documentation on [fontconfig patterns](#). This support does not require fontconfig to be installed. We are merely borrowing its pattern syntax for use here.

Note that matplotlib's internal font manager and fontconfig use a different algorithm to lookup fonts, so the results of the same pattern may be different in matplotlib than in other applications that use fontconfig.

copy()

Return a deep copy of self

get_family()

Return a list of font names that comprise the font family.

get_file()

Return the filename of the associated font.

get_fontconfig_pattern()

Get a fontconfig pattern suitable for looking up the font as specified with fontconfig's `fc-match` utility.

See the documentation on [fontconfig patterns](#).

This support does not require fontconfig to be installed or support for it to be enabled. We are merely borrowing its pattern syntax for use here.

get_name()

Return the name of the font that best matches the font properties.

get_size()

Return the font size.

get_size_in_points()**get_slant()**

Return the font style. Values are: 'normal', 'italic' or 'oblique'.

get_stretch()

Return the font stretch or width. Options are: 'ultra-condensed', 'extra-condensed', 'condensed', 'semi-condensed', 'normal', 'semi-expanded', 'expanded', 'extra-expanded', 'ultra-expanded'.

get_style()

Return the font style. Values are: 'normal', 'italic' or 'oblique'.

get_variant()

Return the font variant. Values are: 'normal' or 'small-caps'.

get_weight()

Set the font weight. Options are: A numeric value in the range 0-1000 or one of 'light', 'normal', 'regular', 'book', 'medium', 'roman', 'semibold', 'demibold', 'demi', 'bold', 'heavy', 'extra bold', 'black'

set_family(*family*)

Change the font family. May be either an alias (generic name is CSS parlance), such as: 'serif', 'sans-serif', 'cursive', 'fantasy', or 'monospace', a real font name or a list of real font names. Real font names are not supported when `text.usetex` is True.

set_file(*file*)

Set the filename of the fontfile to use. In this case, all other properties will be ignored.

set_fontconfig_pattern(*pattern*)

Set the properties by parsing a fontconfig *pattern*.

See the documentation on [fontconfig patterns](#).

This support does not require fontconfig to be installed or support for it to be enabled. We are merely borrowing its pattern syntax for use here.

set_name(*family*)

Change the font family. May be either an alias (generic name is CSS parlance), such as: ‘serif’, ‘sans-serif’, ‘cursive’, ‘fantasy’, or ‘monospace’, a real font name or a list of real font names. Real font names are not supported when `text.usetex` is True.

set_size(*size*)

Set the font size. Either an relative value of ‘xx-small’, ‘x-small’, ‘small’, ‘medium’, ‘large’, ‘x-large’, ‘xx-large’ or an absolute font size, e.g., 12.

set_slant(*style*)

Set the font style. Values are: ‘normal’, ‘italic’ or ‘oblique’.

set_stretch(*stretch*)

Set the font stretch or width. Options are: ‘ultra-condensed’, ‘extra-condensed’, ‘condensed’, ‘semi-condensed’, ‘normal’, ‘semi-expanded’, ‘expanded’, ‘extra-expanded’ or ‘ultra-expanded’, or a numeric value in the range 0-1000.

set_style(*style*)

Set the font style. Values are: ‘normal’, ‘italic’ or ‘oblique’.

set_variant(*variant*)

Set the font variant. Values are: ‘normal’ or ‘small-caps’.

set_weight(*weight*)

Set the font weight. May be either a numeric value in the range 0-1000 or one of ‘ultralight’, ‘light’, ‘normal’, ‘regular’, ‘book’, ‘medium’, ‘roman’, ‘semibold’, ‘demibold’, ‘demi’, ‘bold’, ‘heavy’, ‘extra bold’, ‘black’

`matplotlib.font_manager.OSXInstalledFonts`(*directories=None, fonttext='ttf'*)

Get list of font files on OS X - ignores font suffix by default.

class `matplotlib.font_manager.TempCache`

Bases: `object`

A class to store temporary caches that are (a) not saved to disk and (b) invalidated whenever certain font-related rcParams—namely the family lookup lists—are changed or the font cache is reloaded. This avoids the expensive linear search through all fonts every time a font is looked up.

get(*prop*)

invalidating_rcparams = (‘font.serif’, ‘font.sans-serif’, ‘font.cursive’, ‘font.fantasy’, ‘font.monospace’)

make_rcparams_key()

set(prop, value)

matplotlib.font_manager.afmFontProperty(fontpath, font)

A function for populating a FontKey instance by extracting information from the AFM font file.

font is a class:AFM instance.

matplotlib.font_manager.createFontList(fontfiles, fontext='tff')

A function to create a font lookup list. The default is to create a list of TrueType fonts. An AFM font list can optionally be created.

matplotlib.font_manager.findSystemFonts(fontpaths=None, fontext='tff')

Search for fonts in the specified font paths. If no paths are given, will use a standard set of system paths, as well as the list of fonts tracked by fontconfig if fontconfig is installed and available. A list of TrueType fonts are returned by default with AFM fonts as an option.

matplotlib.font_manager.findfont(prop, **kw)

matplotlib.font_manager.get_fontconfig_fonts(fontext='tff')

List the font filenames known to fc-list having the given extension.

matplotlib.font_manager.get_fontext_synonyms(fontext)

Return a list of file extensions extensions that are synonyms for the given file extension *fileext*.

matplotlib.font_manager.is_opentype_cff_font(filename)

Returns True if the given font is a Postscript Compact Font Format Font embedded in an OpenType wrapper. Used by the PostScript and PDF backends that can not subset these fonts.

matplotlib.font_manager.list_fonts(directory, extensions)

Return a list of all fonts matching any of the extensions, possibly upper-cased, found recursively under the directory.

matplotlib.font_manager.pickle_dump(data, filename)

Equivalent to pickle.dump(data, open(filename, 'w')) but closes the file to prevent filehandle leakage.

matplotlib.font_manager.pickle_load(filename)

Equivalent to pickle.load(open(filename, 'r')) but closes the file to prevent filehandle leakage.

matplotlib.font_manager.ttfFontProperty(font)

A function for populating the FontKey by extracting information from the TrueType font file.

font is a FT2Font instance.

matplotlib.font_manager.ttfdict_to_fnames(d)

flatten a ttfdict to all the filenames it contains

matplotlib.font_manager.weight_as_number(weight)

Return the weight property as a numeric value. String values are converted to their corresponding numeric value.

`matplotlib.font_manager.win32FontDirectory()`

Return the user-specified font directory for Win32. This is looked up from the registry key:

```
\HKEY_CURRENT_USER\Software\Microsoft\Windows\CurrentVersion\Explorer\Shell_
  ↳Folders\Fonts
```

If the key is not found, `$WINDIR/Fonts` will be returned.

`matplotlib.font_manager.win32InstalledFonts(directory=None, fontext='tff')`

Search for fonts in the specified font directory, or use the system directories if none given. A list of TrueType font filenames are returned by default, or AFM fonts if `fontext == 'afm'`.

32.2 matplotlib.fontconfig_pattern

A module for parsing and generating fontconfig patterns.

See the [fontconfig pattern specification](#) for more information.

class `matplotlib.fontconfig_pattern.FontconfigPatternParser`

Bases: `object`

A simple pyparsing-based parser for fontconfig-style patterns.

See the [fontconfig pattern specification](#) for more information.

parse(*pattern*)

Parse the given fontconfig *pattern* and return a dictionary of key/value pairs useful for initializing a `font_manager.FontProperties` object.

`matplotlib.fontconfig_pattern.family_escape()`

Return the string obtained by replacing the leftmost non-overlapping occurrences of *pattern* in *string* by the replacement *repl*.

`matplotlib.fontconfig_pattern.family_unescape()`

Return the string obtained by replacing the leftmost non-overlapping occurrences of *pattern* in *string* by the replacement *repl*.

`matplotlib.fontconfig_pattern.generate_fontconfig_pattern(d)`

Given a dictionary of key/value pairs, generates a fontconfig pattern string.

`matplotlib.fontconfig_pattern.value_escape()`

Return the string obtained by replacing the leftmost non-overlapping occurrences of *pattern* in *string* by the replacement *repl*.

`matplotlib.fontconfig_pattern.value_unescape()`

Return the string obtained by replacing the leftmost non-overlapping occurrences of *pattern* in *string* by the replacement *repl*.

33.1 `matplotlib.gridspec`

gridspec is a module which specifies the location of the subplot in the figure.

GridSpec specifies the geometry of the grid that a subplot will be placed. The number of rows and number of columns of the grid need to be set. Optionally, the subplot layout parameters (e.g., left, right, etc.) can be tuned.

SubplotSpec specifies the location of the subplot in the given *GridSpec*.

```
class matplotlib.gridspec.GridSpec(nrows, ncols, left=None, bottom=None, right=None,
                                   top=None,          wspace=None,          hspace=None,
                                   width_ratios=None, height_ratios=None)
```

Bases: *matplotlib.gridspec.GridSpecBase*

A class that specifies the geometry of the grid that a subplot will be placed. The location of grid is determined by similar way as the *SubplotParams*.

The number of rows and number of columns of the grid need to be set. Optionally, the subplot layout parameters (e.g., left, right, etc.) can be tuned.

get_subplot_params(*fig=None*)

return a dictionary of subplot layout parameters. The default parameters are from *rcParams* unless a figure attribute is set.

locally_modified_subplot_params()

tight_layout(*fig, renderer=None, pad=1.08, h_pad=None, w_pad=None, rect=None*)

Adjust subplot parameters to give specified padding.

Parameters:

pad [float] padding between the figure edge and the edges of subplots, as a fraction of the font-size.

h_pad, w_pad [float] padding (height/width) between edges of adjacent subplots. Defaults to *pad_inches*.

rect [if rect is given, it is interpreted as a rectangle] (left, bottom, right, top) in the normalized figure coordinate that the whole subplots area (including labels) will fit into. Default is (0, 0, 1, 1).

update(**kwargs)

Update the current values. If any kwarg is None, default to the current value, if set, otherwise to rc.

class matplotlib.gridspec.GridSpecBase(*nrows*, *ncols*, *height_ratios=None*,
width_ratios=None)

Bases: object

A base class of GridSpec that specifies the geometry of the grid that a subplot will be placed.

The number of rows and number of columns of the grid need to be set. Optionally, the ratio of heights and widths of rows and columns can be specified.

get_geometry()

get the geometry of the grid, e.g., 2,3

get_grid_positions(*fig*)

return lists of bottom and top position of rows, left and right positions of columns.

get_height_ratios()

get_subplot_params(*fig=None*)

get_width_ratios()

new_subplotspec(*loc*, *rowspan=1*, *colspan=1*)

create and return a SubplotSpec instance.

set_height_ratios(*height_ratios*)

set_width_ratios(*width_ratios*)

class matplotlib.gridspec.GridSpecFromSubplotSpec(*nrows*, *ncols*, *subplot_spec*,
wspace=None, *hspace=None*,
height_ratios=None,
width_ratios=None)

Bases: *matplotlib.gridspec.GridSpecBase*

GridSpec whose subplot layout parameters are inherited from the location specified by a given SubplotSpec.

The number of rows and number of columns of the grid need to be set. An instance of SubplotSpec is also needed to be set from which the layout parameters will be inherited. The *wspace* and *hspace* of the layout can be optionally specified or the default values (from the figure or rcParams) will be used.

get_subplot_params(*fig=None*)
return a dictionary of subplot layout parameters.

get_topmost_subplotspec()
get the topmost SubplotSpec instance associated with the subplot

class matplotlib.gridspec.**SubplotSpec**(*gridspec, num1, num2=None*)
Bases: object

specifies the location of the subplot in the given *GridSpec*.

The subplot will occupy the num1-th cell of the given gridspec. If num2 is provided, the subplot will span between num1-th cell and num2-th cell.

The index starts from 0.

get_geometry()
get the subplot geometry, e.g., 2,2,3. Unlike SuplorParams, index is 0-based

get_gridspec()

get_position(*fig, return_all=False*)
update the subplot position from fig.subplotspars

get_topmost_subplotspec()
get the topmost SubplotSpec instance associated with the subplot

34.1 matplotlib.image

The image module supports basic image loading, rescaling and display operations.

```
class matplotlib.image.AxesImage(ax, cmap=None, norm=None, interpolation=None, origin=None, extent=None, filtnorm=1, filtrrad=4.0, resample=False, **kwargs)
```

Bases: matplotlib.image._ImageBase

interpolation and cmap default to their rc settings

cmap is a colors.Colormap instance norm is a colors.Normalize instance to map luminance to 0-1

extent is data axes (left, right, bottom, top) for making image plots registered with data plots. Default is to label the pixel centers with the zero-based row and column indices.

Additional kwargs are matplotlib.artist properties

get_cursor_data(*event*)

Get the cursor data for a given event

get_extent()

Get the image extent: left, right, bottom, top

get_window_extent(*renderer=None*)

make_image(*renderer, magnification=1.0, unsampled=False*)

set_extent(*extent*)

extent is data axes (left, right, bottom, top) for making image plots

This updates ax.dataLim, and, if autoscaling, sets viewLim to tightly fit the image, regardless of dataLim. Autoscaling state is not changed, so following this with ax.autoscale_view will redo the autoscaling in accord with dataLim.

```
class matplotlib.image.BboxImage(bbox, cmap=None, norm=None, interpolation=None, origin=None, filtnorm=1, filtrrad=4.0, resample=False, interp_at_native=True, **kwargs)
```

Bases: matplotlib.image._ImageBase

The Image class whose size is determined by the given bbox.

cmap is a colors.Colormap instance norm is a colors.Normalize instance to map luminance to 0-1

interp_at_native is a flag that determines whether or not interpolation should still be applied when the image is displayed at its native resolution. A common use case for this is when displaying an image for annotational purposes; it is treated similarly to Photoshop (interpolation is only used when displaying the image at non-native resolutions).

kwargs are an optional list of Artist keyword args

contains(*mouseevent*)

Test whether the mouse event occurred within the image.

get_transform()

get_window_extent(*renderer=None*)

make_image(*renderer, magnification=1.0, unsampled=False*)

class matplotlib.image.FigureImage(*fig, cmap=None, norm=None, offsetx=0, offsety=0, origin=None, **kwargs*)

Bases: `matplotlib.image._ImageBase`

cmap is a colors.Colormap instance norm is a colors.Normalize instance to map luminance to 0-1

kwargs are an optional list of Artist keyword args

get_extent()

Get the image extent: left, right, bottom, top

make_image(*renderer, magnification=1.0, unsampled=False*)

set_data(*A*)

Set the image array.

zorder = 0

class matplotlib.image.NonUniformImage(*ax, **kwargs*)

Bases: `matplotlib.image.AxesImage`

kwargs are identical to those for AxesImage, except that 'nearest' and 'bilinear' are the only supported 'interpolation' options.

get_extent()

make_image(*renderer, magnification=1.0, unsampled=False*)

set_array(*args)

set_cmap(*cmap*)

set_data(*x*, *y*, *A*)

Set the grid for the pixel centers, and the pixel values.

x and *y* are **monotonic 1-D ndarrays of lengths N and M**, respectively, specifying pixel centers

A is an **(M,N) ndarray or masked array of values to be colormapped**, or a (M,N,3) RGB array, or a (M,N,4) RGBA array.

set_filternorm(*s*)

set_filterrad(*s*)

set_interpolation(*s*)

set_norm(*norm*)

class matplotlib.image.PcolorImage(*ax*, *x=None*, *y=None*, *A=None*, *cmap=None*,
norm=None, ***kwargs*)

Bases: [matplotlib.image.AxesImage](#)

Make a pcolor-style plot with an irregular rectangular grid.

This uses a variation of the original irregular image code, and it is used by pcolorfast for the corresponding grid type.

cmap defaults to its rc setting

cmap is a colors.Colormap instance *norm* is a colors.Normalize instance to map luminance to 0-1

Additional *kwargs* are matplotlib.artist properties

get_cursor_data(*event*)

Get the cursor data for a given event

make_image(*renderer*, *magnification=1.0*, *unsampled=False*)

set_array(**args*)

set_data(*x*, *y*, *A*)

Set the grid for the rectangle boundaries, and the data values.

x and *y* are **monotonic 1-D ndarrays of lengths N+1 and M+1**, respectively, specifying rectangle boundaries. If None, they will be created as uniform arrays from 0 through N and 0 through M, respectively.

A is an **(M,N) ndarray or masked array of values to be colormapped**, or a (M,N,3) RGB array, or a (M,N,4) RGBA array.

`matplotlib.image.composite_images(images, renderer, magnification=1.0)`

Composite a number of RGBA images into one. The images are composited in the order in which they appear in the `images` list.

Parameters `images` : list of Images

Each must have a `make_image` method. For each image, `can_composite` should return `True`, though this is not enforced by this function. Each image must have a purely affine transformation with no shear.

renderer : `RendererBase` instance

magnification : float

The additional magnification to apply for the renderer in use.

Returns tuple : image, `offset_x`, `offset_y`

Returns the tuple:

- `image`: A numpy array of the same type as the input images.
- `offset_x`, `offset_y`: The offset of the image (left, bottom) in the output figure.

`matplotlib.image.imread(fname, format=None)`

Read an image from a file into an array.

`fname` may be a string path, a valid URL, or a Python file-like object. If using a file object, it must be opened in binary mode.

If `format` is provided, will try to read file of that type, otherwise the format is deduced from the filename. If nothing can be deduced, PNG is tried.

Return value is a `numpy.array`. For grayscale images, the return array is `MxN`. For RGB images, the return value is `MxNx3`. For RGBA images the return value is `MxNx4`.

matplotlib can only read PNGs natively, but if `PIL` is installed, it will use it to load the image and return an array (if possible) which can be used with `imshow()`. Note, URL strings may not be compatible with `PIL`. Check the `PIL` documentation for more information.

`matplotlib.image.imsave(fname, arr, vmin=None, vmax=None, cmap=None, format=None, origin=None, dpi=100)`

Save an array as in image file.

The output formats available depend on the backend being used.

Arguments:

`fname`: A string containing a path to a filename, or a Python file-like object. If `format` is `None` and `fname` is a string, the output format is deduced from the extension of the filename.

`arr`: An `MxN` (luminance), `MxNx3` (RGB) or `MxNx4` (RGBA) array.

Keyword arguments:

vmin/vmax: [**None** | **scalar**] *vmin* and *vmax* set the color scaling for the image by fixing the values that map to the colormap color limits. If either *vmin* or *vmax* is **None**, that limit is determined from the *arr* min/max value.

cmap: *cmap* is a `colors.Colormap` instance, e.g., `cm.jet`. If **None**, default to the `rc` `image.cmap` value.

format: One of the file extensions supported by the active backend. Most backends support `png`, `pdf`, `ps`, `eps` and `svg`.

origin [`'upper'` | `'lower'`] Indicates where the `[0,0]` index of the array is in the upper left or lower left corner of the axes. Defaults to the `rc` `image.origin` value.

dpi The DPI to store in the metadata of the file. This does not affect the resolution of the output image.

`matplotlib.image.pil_to_array(pillImage)`

Load a PIL image and return it as a numpy array. For grayscale images, the return array is `MxN`. For RGB images, the return value is `MxNx3`. For RGBA images the return value is `MxNx4`

`matplotlib.image.thumbnail(infile, thumbfile, scale=0.1, interpolation='bilinear', preview=False)`

make a thumbnail of image in *infile* with output filename *thumbfile*.

infile the image file – must be **PNG** or **Pillow-readable** if you have [Pillow](#) installed

thumbfile the thumbnail filename

scale the scale factor for the thumbnail

interpolation the interpolation scheme used in the resampling

preview if **True**, the default backend (presumably a user interface backend) will be used which will cause a figure to be raised if `show()` is called. If it is **False**, a pure image backend will be used depending on the extension, `'png'`->`FigureCanvasAgg`, `'pdf'`->`FigureCanvasPdf`, `'svg'`->`FigureCanvasSVG`

See `examples/misc/image_thumbnail.py`.

Return value is the figure instance containing the thumbnail

LEGEND AND LEGEND_HANDLER

35.1 matplotlib.legend

The legend module defines the Legend class, which is responsible for drawing legends associated with axes and/or figures.

Important: It is unlikely that you would ever create a Legend instance manually. Most users would normally create a legend via the `legend()` function. For more details on legends there is also a *legend guide*.

The Legend class can be considered as a container of legend handles and legend texts. Creation of corresponding legend handles from the plot elements in the axes or figures (e.g., lines, patches, etc.) are specified by the handler map, which defines the mapping between the plot elements and the legend handlers to be used (the default legend handlers are defined in the `legend_handler` module). Note that not all kinds of artist are supported by the legend yet by default but it is possible to extend the legend handler's capabilities to support arbitrary objects. See the *legend guide* for more information.

class `matplotlib.legend.DraggableLegend`(*legend, use_blit=False, update='loc'*)

Bases: `matplotlib.offsetbox.DraggableOffsetBox`

update [If “loc”, update *loc* parameter of] legend upon finalizing. If “bbox”, update *bbox_to_anchor* parameter.

artist_picker(*legend, evt*)

finalize_offset()

class `matplotlib.legend.Legend`(*parent, handles, labels, loc=None, numpoints=None, markerscale=None, markerfirst=True, scatterpoints=None, scatteryoffsets=None, prop=None, fontsize=None, borderpad=None, labelspacing=None, handlelength=None, handleheight=None, handletextpad=None, borderaxespad=None, columnspacing=None, ncol=1, mode=None, fancybox=None, shadow=None, title=None, framealpha=None, edgecolor=None, facecolor=None, bbox_to_anchor=None, bbox_transform=None, frameon=None, handler_map=None*)

Bases: `matplotlib.artist.Artist`

Place a legend on the axes at location `loc`. Labels are a sequence of strings and `loc` can be a string or an integer specifying the legend location

The location codes are:

```
'best'      : 0, (only implemented for axes legends)
'upper right' : 1,
'upper left'  : 2,
'lower left'  : 3,
'lower right' : 4,
'right'       : 5,
'center left' : 6,
'center right': 7,
'lower center': 8,
'upper center': 9,
'center'      : 10,
```

`loc` can be a tuple of the normalized coordinate values with respect its parent.

- *parent*: the artist that contains the legend
- *handles*: a list of artists (lines, patches) to be added to the legend
- *labels*: a list of strings to label the legend

Optional keyword arguments:

Keyword	Description
<code>loc</code>	Location code string, or tuple (see below).
<code>prop</code>	the font property
<code>fontsize</code>	the font size (used only if <code>prop</code> is not specified)
<code>markerscale</code>	the relative size of legend markers vs. original
<code>markerfirst</code>	If True (default), marker is to left of the label.
<code>numpoints</code>	the number of points in the legend for line
<code>scatterpoints</code>	the number of points in the legend for scatter plot
<code>scatteryoffsets</code>	a list of yoffsets for scatter symbols in legend
<code>frameon</code>	If True, draw the legend on a patch (frame).
<code>fancybox</code>	If True, draw the frame with a round fancybox.
<code>shadow</code>	If True, draw a shadow behind legend.
<code>framealpha</code>	Transparency of the frame.
<code>edgecolor</code>	Frame edgecolor.
<code>facecolor</code>	Frame facecolor.
<code>ncol</code>	number of columns
<code>borderpad</code>	the fractional whitespace inside the legend border
<code>labelspacing</code>	the vertical space between the legend entries
<code>handlelength</code>	the length of the legend handles
<code>handleheight</code>	the height of the legend handles
<code>handletextpad</code>	the pad between the legend handle and text
<code>borderaxespad</code>	the pad between the axes and legend border
<code>columnspacing</code>	the spacing between columns
<code>title</code>	the legend title
<code>bbox_to_anchor</code>	the bbox that the legend will be anchored.
<code>bbox_transform</code>	the transform for the bbox. <code>transAxes</code> if None.

The pad and spacing parameters are measured in font-size units. e.g., a `fontsize` of 10 points and a `handlelength=5` implies a `handlelength` of 50 points. Values from `rcParams` will be used if None.

Users can specify any arbitrary location for the legend using the `bbox_to_anchor` keyword argument. `bbox_to_anchor` can be an instance of `BboxBase`(or its derivatives) or a tuple of 2 or 4 floats. See [set_bbox_to_anchor\(\)](#) for more detail.

The legend location can be specified by setting `loc` with a tuple of 2 floats, which is interpreted as the lower-left corner of the legend in the normalized axes coordinate.

codes = {'best': 0, 'upper right': 1, 'upper left': 2, 'lower left': 3, 'lower right': 4, 'right': 5, 'center left': 6, 'center right': 7, 'left': 8, 'right': 9}

contains(*event*)

draggable(*state=None, use_blit=False, update='loc'*)

Set the draggable state – if state is

- None : toggle the current state
- True : turn draggable on
- False : turn draggable off

If `draggable` is on, you can drag the legend on the canvas with the mouse. The `DraggableLegend` helper instance is returned if `draggable` is on.

The `update` parameter control which parameter of the legend changes when dragged. If `update` is “loc”, the `loc` parameter of the legend is changed. If “bbox”, the `bbox_to_anchor` parameter is changed.

draw(*artist, renderer, *args, **kwargs*)

Draw everything that belongs to the legend

draw_frame(*b*)

b is a boolean. Set draw frame to *b*

get_bbox_to_anchor()

return the bbox that the legend will be anchored

get_children()

return a list of child artists

classmethod get_default_handler_map()

A class method that returns the default handler map.

get_frame()

return the Rectangle instance used to frame the legend

get_frame_on()

Get whether the legend box patch is drawn

static get_legend_handler(*legend_handler_map, orig_handle*)

return a legend handler from *legend_handler_map* that corresponds to *orig_handle*.

legend_handler_map should be a dictionary object (that is returned by the `get_legend_handler_map` method).

It first checks if the *orig_handle* itself is a key in the *legend_handler_map* and return the associated value. Otherwise, it checks for each of the classes in its method-resolution-order. If no matching key is found, it returns `None`.

get_legend_handler_map()

return the handler map.

get_lines()

return a list of `lines.Line2D` instances in the legend

get_patches()

return a list of patch instances in the legend

get_texts()

return a list of `text.Text` instance in the legend

get_title()

return `Text` instance for the legend title

get_window_extent(**args, **kwargs*)

return a extent of the legend

set_bbox_to_anchor(*bbox*, *transform=None*)

set the bbox that the legend will be anchored.

bbox can be a BboxBase instance, a tuple of [left, bottom, width, height] in the given transform (normalized axes coordinate if None), or a tuple of [left, bottom] where the width and height will be assumed to be zero.

classmethod set_default_handler_map(*handler_map*)

A class method to set the default handler map.

set_frame_on(*b*)

Set whether the legend box patch is drawn

ACCEPTS: [*True* | *False*]

set_title(*title*, *prop=None*)

set the legend title. Fontproperties can be optionally set with *prop* parameter.

classmethod update_default_handler_map(*handler_map*)

A class method to update the default handler map.

zorder = 5

35.2 matplotlib.legend_handler

This module defines default legend handlers.

It is strongly encouraged to have read the [legend guide](#) before this documentation.

Legend handlers are expected to be a callable object with a following signature.

```
legend_handler(legend, orig_handle, fontsize, handlebox)
```

Where *legend* is the legend itself, *orig_handle* is the original plot, *fontsize* is the fontsize in pixels, and *handlebox* is a OffsetBox instance. Within the call, you should create relevant artists (using relevant properties from the *legend* and/or *orig_handle*) and add them into the handlebox. The artists needs to be scaled according to the fontsize (note that the size is in pixel, i.e., this is dpi-scaled value).

This module includes definition of several legend handler classes derived from the base class (HandlerBase) with the following method.

```
def legend_artist(self, legend, orig_handle, fontsize, handlebox):
```

class matplotlib.legend_handler.HandlerBase(*xpad=0.0*, *ypad=0.0*, *update_func=None*)

A Base class for default legend handlers.

The derived classes are meant to override *create_artists* method, which has a following signature.:

```
def create_artists(self, legend, orig_handle,
                  xdescent, ydescent, width, height, fontsize,
                  trans):
```

The overridden method needs to create artists of the given transform that fits in the given dimension (xdescent, ydescent, width, height) that are scaled by fontsize if necessary.

adjust_drawing_area(*legend, orig_handle, xdescent, ydescent, width, height, fontsize*)

create_artists(*legend, orig_handle, xdescent, ydescent, width, height, fontsize, trans*)

legend_artist(*legend, orig_handle, fontsize, handlebox*)

Return the artist that this HandlerBase generates for the given original artist/handle.

Parameters legend : *matplotlib.legend.Legend* instance

The legend for which these legend artists are being created.

orig_handle : *matplotlib.artist.Artist* or similar

The object for which these legend artists are being created.

fontsize : float or int

The fontsize in pixels. The artists being created should be scaled according to the given fontsize.

handlebox : *matplotlib.offsetbox.OffsetBox* instance

The box which has been created to hold this legend entry's artists. Artists created in the *legend_artist* method must be added to this handlebox inside this method.

update_prop(*legend_handle, orig_handle, legend*)

class *matplotlib.legend_handler.HandlerCircleCollection*(*yoffsets=None, sizes=None, **kw*)

Handler for CircleCollections

create_collection(*orig_handle, sizes, offsets, transOffset*)

class *matplotlib.legend_handler.HandlerErrorbar*(*xerr_size=0.5, yerr_size=None, marker_pad=0.3, numpoints=None, **kw*)

Handler for Errorbars

create_artists(*legend, orig_handle, xdescent, ydescent, width, height, fontsize, trans*)

get_err_size(*legend, xdescent, ydescent, width, height, fontsize*)

class *matplotlib.legend_handler.HandlerLine2D*(*marker_pad=0.3, numpoints=None, **kw*)

Handler for Line2D instances.

create_artists(*legend, orig_handle, xdescent, ydescent, width, height, fontsize, trans*)

```
class matplotlib.legend_handler.HandlerLineCollection(marker_pad=0.3,      num-
                                                    points=None, **kw)
```

Handler for LineCollection instances.

```
create_artists(legend, orig_handle, xdescent, ydescent, width, height, fontsize, trans)
```

```
get_numpoints(legend)
```

```
class matplotlib.legend_handler.HandlerNpoints(marker_pad=0.3,      numpoints=None,
                                                    **kw)
```

```
get_numpoints(legend)
```

```
get_xdata(legend, xdescent, ydescent, width, height, fontsize)
```

```
class matplotlib.legend_handler.HandlerNpointsYoffsets(numpoints=None,      yoff-
                                                    sets=None, **kw)
```

```
get_ydata(legend, xdescent, ydescent, width, height, fontsize)
```

```
class matplotlib.legend_handler.HandlerPatch(patch_func=None, **kw)
```

Handler for Patch instances.

The HandlerPatch class optionally takes a function `patch_func` who's responsibility is to create the legend key artist. The `patch_func` should have the signature:

```
def patch_func(legend=legend, orig_handle=orig_handle,
               xdescent=xdescent, ydescent=ydescent,
               width=width, height=height, fontsize=fontsize)
```

Subsequently the created artist will have its `update_prop` method called and the appropriate transform will be applied.

```
create_artists(legend, orig_handle, xdescent, ydescent, width, height, fontsize, trans)
```

```
class matplotlib.legend_handler.HandlerPathCollection(yoffsets=None,      sizes=None,
                                                    **kw)
```

Handler for PathCollections, which are used by scatter

```
create_collection(orig_handle, sizes, offsets, transOffset)
```

```
class matplotlib.legend_handler.HandlerPolyCollection(xpad=0.0,      ypad=0.0,      up-
                                                    date_func=None)
```

Handler for PolyCollection used in `fill_between` and `stackplot`.

```
create_artists(legend, orig_handle, xdescent, ydescent, width, height, fontsize, trans)
```

```
class matplotlib.legend_handler.HandlerRegularPolyCollection(yoffsets=None,  
                                                             sizes=None, **kw)
```

Handler for RegularPolyCollections.

```
create_artists(legend, orig_handle, xdescent, ydescent, width, height, fontsize, trans)
```

```
create_collection(orig_handle, sizes, offsets, transOffset)
```

```
get_numpoints(legend)
```

```
get_sizes(legend, orig_handle, xdescent, ydescent, width, height, fontsize)
```

```
update_prop(legend_handle, orig_handle, legend)
```

```
class matplotlib.legend_handler.HandlerStem(marker_pad=0.3, numpoints=None, bot-  
                                              tom=None, yoffsets=None, **kw)
```

Handler for Errorbars

```
create_artists(legend, orig_handle, xdescent, ydescent, width, height, fontsize, trans)
```

```
get_ydata(legend, xdescent, ydescent, width, height, fontsize)
```

```
class matplotlib.legend_handler.HandlerTuple(**kwargs)
```

Handler for Tuple

```
create_artists(legend, orig_handle, xdescent, ydescent, width, height, fontsize, trans)
```

```
matplotlib.legend_handler.update_from_first_child(tgt, src)
```

36.1 matplotlib.lines

This module contains all the 2D line class which can draw with a variety of line styles, markers and colors.

```
class matplotlib.lines.Line2D(xdata, ydata, linewidth=None, linestyle=None,
                               color=None, marker=None, markersize=None, mark-
                               eredgewidth=None, markeredgewidth=None, markerface-
                               color=None, markerfacecoloralt='none', fillstyle=None,
                               antialiased=None, dash_capstyle=None, solid_capstyle=None,
                               dash_joinstyle=None, solid_joinstyle=None, pickradius=5,
                               drawstyle=None, markevery=None, **kwargs)
```

Bases: `matplotlib.artist.Artist`

A line - the line can have both a solid linestyle connecting all the vertices, and a marker at each vertex. Additionally, the drawing of the solid line is influenced by the drawstyle, e.g., one can create “stepped” lines in various styles.

Create a `Line2D` instance with x and y data in sequences `xdata`, `ydata`.

The kwargs are `Line2D` properties:

Property	Description
<code>agg_filter</code>	unknown
<code>alpha</code>	float (0.0 transparent through 1.0 opaque)
<code>animated</code>	[True False]
<code>antialiased</code> or <code>aa</code>	[True False]
<code>axes</code>	an <code>Axes</code> instance
<code>clip_box</code>	a <code>matplotlib.transforms.Bbox</code> instance
<code>clip_on</code>	[True False]
<code>clip_path</code>	[(<code>Path</code> , <code>Transform</code>) <code>Patch</code> None]
<code>color</code> or <code>c</code>	any matplotlib color
<code>contains</code>	a callable function
<code>dash_capstyle</code>	['butt' 'round' 'projecting']
<code>dash_joinstyle</code>	['miter' 'round' 'bevel']
<code>dashes</code>	sequence of on/off ink in points
<code>drawstyle</code>	['default' 'steps' 'steps-pre' 'steps-mid' 'steps-post']

Table 36.1 – continued from previous page

Property	Description
<i>figure</i>	a <i>matplotlib.figure.Figure</i> instance
<i>fillstyle</i>	['full' 'left' 'right' 'bottom' 'top' 'none']
<i>gid</i>	an id string
<i>label</i>	string or anything printable with '%s' conversion.
<i>linestyle</i> or <i>ls</i>	['solid' 'dashed', 'dashdot', 'dotted' (offset, on-off-dash-seq) '-' '--' '-.' ' ']
<i>linewidth</i> or <i>lw</i>	float value in points
<i>marker</i>	<i>A valid marker style</i>
<i>markeredgecolor</i> or <i>mec</i>	any matplotlib color
<i>markeredgewidth</i> or <i>mew</i>	float value in points
<i>markerfacecolor</i> or <i>mfc</i>	any matplotlib color
<i>markerfacecoloralt</i> or <i>mfcalt</i>	any matplotlib color
<i>markersize</i> or <i>ms</i>	float
<i>markevery</i>	[None int length-2 tuple of int slice list/array of int float length-2 tuple of float]
<i>path_effects</i>	unknown
<i>picker</i>	float distance in points or callable pick function <code>fn(artist, event)</code>
<i>pickradius</i>	float distance in points
<i>rasterized</i>	[True False None]
<i>sketch_params</i>	unknown
<i>snap</i>	unknown
<i>solid_capstyle</i>	['butt' 'round' 'projecting']
<i>solid_joinstyle</i>	['miter' 'round' 'bevel']
<i>transform</i>	a <i>matplotlib.transforms.Transform</i> instance
<i>url</i>	a url string
<i>visible</i>	[True False]
<i>xdata</i>	1D array
<i>ydata</i>	1D array
<i>zorder</i>	any number

See `set_linestyle()` for a description of the line styles, `set_marker()` for a description of the markers, and `set_drawstyle()` for a description of the draw styles.

axes

The *Axes* instance the artist resides in, or *None*.

contains(*mouseevent*)

Test whether the mouse event occurred on the line. The pick radius determines the precision of the location test (usually within five points of the value). Use `get_pickradius()` or `set_pickradius()` to view or modify it.

Returns *True* if any values are within the radius along with {'ind': *pointlist*}, where *pointlist* is the set of points within the radius.

TODO: sort returned indices by distance

draw(*artist*, *renderer*, **args*, ***kwargs*)

draw the Line with renderer unless visibility is False

drawStyleKeys = ['default', 'steps-mid', 'steps-pre', 'steps-post', 'steps']

drawStyles = {'default': '_draw_lines', 'steps-mid': '_draw_steps_mid', 'steps-pre': '_draw_steps_pre', 'steps-post': '_draw_steps_post'}

fillStyles = ('full', 'left', 'right', 'bottom', 'top', 'none')

filled_markers = ('o', 'v', '^', '<', '>', '8', 's', 'p', '*', 'h', 'H', 'D', 'd', 'P', 'X')

get_aa()

alias for `get_antialiased`

get_antialiased()

get_c()

alias for `get_color`

get_color()

get_dash_capstyle()

Get the cap style for dashed linestyles

get_dash_joinstyle()

Get the join style for dashed linestyles

get_data(*orig=True*)

Return the xdata, ydata.

If *orig* is *True*, return the original data.

get_drawstyle()

get_fillstyle()

return the marker fillstyle

get_linestyle()

get_linewidth()

get_ls()

alias for `get_linestyle`

get_lw()

alias for `get_linewidth`

get_marker()

get_markeredgcolor()

get_markeredgewidth()

get_markerfacecolor()

get_markerfacecoloralt()

get_markersize()

get_markevery()

return the markevery setting

get_mec()

alias for get_markeredgcolor

get_mew()

alias for get_markeredgewidth

get_mfc()

alias for get_markerfacecolor

get_mfcalt(*alt=False*)

alias for get_markerfacecoloralt

get_ms()

alias for get_markersize

get_path()

Return the *Path* object associated with this line.

get_pickradius()

return the pick radius used for containment tests

get_solid_capstyle()

Get the cap style for solid linestyles

get_solid_joinstyle()

Get the join style for solid linestyles

get_window_extent(*renderer*)

get_xdata(*orig=True*)

Return the xdata.

If *orig* is *True*, return the original data, else the processed data.

get_xydata()

Return the *xy* data as a Nx2 numpy array.

get_ydata(*orig=True*)

Return the ydata.

If *orig* is *True*, return the original data, else the processed data.

is_dashed()

return True if line is dashstyle

lineStyles = {'-': '_draw_solid', '-': '_draw_dashed', '-.': '_draw_dash_dot', ':': '_draw_dotted', 'None': '_draw_solid'}

markers = {'.': 'point', ',': 'pixel', 'o': 'circle', 'v': 'triangle_down', '^': 'triangle_up', '<': 'triangle_left', '>': 'triangle_right'}

recache(*always=False*)

recache_always()

set_aa(*val*)

alias for `set_antialiased`

set_antialiased(*b*)

True if line should be drawn with antialiased rendering

ACCEPTS: [True | False]

set_c(*val*)

alias for `set_color`

set_color(*color*)

Set the color of the line

ACCEPTS: any matplotlib color

set_dash_capstyle(*s*)

Set the cap style for dashed linestyles

ACCEPTS: ['butt' | 'round' | 'projecting']

set_dash_joinstyle(*s*)

Set the join style for dashed linestyles ACCEPTS: ['miter' | 'round' | 'bevel']

set_dashes(*seq*)

Set the dash sequence, sequence of dashes with on off ink in points. If *seq* is empty or if *seq* = (None, None), the linestyle will be set to solid.

ACCEPTS: sequence of on/off ink in points

set_data(**args*)

Set the x and y data

ACCEPTS: 2D array (rows are x, y) or two 1D arrays

set_drawstyle(*drawstyle*)

Set the drawstyle of the plot

‘default’ connects the points with lines. The steps variants produce step-plots. ‘steps’ is equivalent to ‘steps-pre’ and is maintained for backward-compatibility.

ACCEPTS: [`'default'` | `'steps'` | `'steps-pre'` | `'steps-mid'` | `'steps-post'`]

set_fillstyle(*fs*)

Set the marker fill style; ‘full’ means fill the whole marker. ‘none’ means no filling; other options are for half-filled markers.

ACCEPTS: [`'full'` | `'left'` | `'right'` | `'bottom'` | `'top'` | `'none'`]

set_linestyle(*ls*)

Set the linestyle of the line (also accepts drawstyles, e.g., `'steps--'`)

linestyle	description
<code>'-'</code> or <code>'solid'</code>	solid line
<code>'--'</code> or <code>'dashed'</code>	dashed line
<code>'-.'</code> or <code>'dashdot'</code>	dash-dotted line
<code>':'</code> or <code>'dotted'</code>	dotted line
<code>'None'</code>	draw nothing
<code>' '</code>	draw nothing
<code>' '</code>	draw nothing

‘steps’ is equivalent to ‘steps-pre’ and is maintained for backward-compatibility.

Alternatively a dash tuple of the following form can be provided:

(*offset*, *onoffseq*),

where *onoffseq* is an even length tuple of on and off ink in points.

ACCEPTS: [`'solid'` | `'dashed'`, `'dashdot'`, `'dotted'` | (*offset*, *on-off-dash-seq*) | `'-'` | `'--'` | `'-.'` | `':'` | `'None'` | `' '` | `' '`]

See also:

[`set_drawstyle\(\)`](#) To set the drawing style (stepping) of the plot.

Parameters *ls* : { `'-'`, `'--'`, `'-.'`, `':'` } and more see description

The line style.

set_linewidth(*w*)

Set the line width in points

ACCEPTS: float value in points

set_ls(*val*)

alias for `set_linestyle`

set_lw(*val*)

alias for `set_linewidth`

set_marker(*marker*)

Set the line marker

ACCEPTS: *A valid marker style*

Parameters marker: marker style

See *markers* for full description of possible argument

set_markeredgecolor(*ec*)

Set the marker edge color

ACCEPTS: any matplotlib color

set_markeredgewidth(*ew*)

Set the marker edge width in points

ACCEPTS: float value in points

set_markerfacecolor(*fc*)

Set the marker face color.

ACCEPTS: any matplotlib color

set_markerfacecoloralt(*fc*)

Set the alternate marker face color.

ACCEPTS: any matplotlib color

set_markersize(*sz*)

Set the marker size in points

ACCEPTS: float

set_markevery(*every*)

Set the markevery property to subsample the plot when using markers.

e.g., if every=5, every 5-th marker will be plotted.

ACCEPTS: [None | int | length-2 tuple of int | slice | list/array of int | float | length-2 tuple of float]

Parameters every: None | int | length-2 tuple of int | slice | list/array of int | float | length-2 tuple of float

Which markers to plot.

- every=None, every point will be plotted.
- every=N, every N-th marker will be plotted starting with marker 0.
- every=(start, N), every N-th marker, starting at point start, will be plotted.
- every=slice(start, end, N), every N-th marker, starting at point start, upto but not including point end, will be plotted.
- every=[i, j, m, n], only markers at points i, j, m, and n will be plotted.
- every=0.1, (i.e. a float) then markers will be spaced at approximately equal distances along the line; the distance along the line between markers is determined by multiplying the display-coordinate distance of the axes bounding-box diagonal by the value of every.

- `every=(0.5, 0.1)` (i.e. a length-2 tuple of float), the same functionality as `every=0.1` is exhibited but the first marker will be 0.5 multiplied by the display-coordinate-diagonal-distance along the line.

Notes

Setting the `markevery` property will only show markers at actual data points. When using float arguments to set the `markevery` property on irregularly spaced data, the markers will likely not appear evenly spaced because the actual data points do not coincide with the theoretical spacing between markers.

When using a start offset to specify the first marker, the offset will be from the first data point which may be different from the first the visible data point if the plot is zoomed in.

If zooming in on a plot when using float arguments then the actual data points that have markers will change because the distance between markers is always determined from the display-coordinates axes-bounding-box-diagonal regardless of the actual axes data limits.

set_mec(*val*)

alias for `set_markeredgecolor`

set_mew(*val*)

alias for `set_markeredgewidth`

set_mfc(*val*)

alias for `set_markerfacecolor`

set_mfcalt(*val*)

alias for `set_markerfacecoloralt`

set_ms(*val*)

alias for `set_markersize`

set_picker(*p*)

Sets the event picker details for the line.

ACCEPTS: float distance in points or callable pick function `fn(artist, event)`

set_pickradius(*d*)

Sets the pick radius used for containment tests

ACCEPTS: float distance in points

set_solid_capstyle(*s*)

Set the cap style for solid linestyles

ACCEPTS: ['butt' | 'round' | 'projecting']

set_solid_joinstyle(*s*)

Set the join style for solid linestyles ACCEPTS: ['miter' | 'round' | 'bevel']

set_transform(*t*)

set the Transformation instance used by this artist

ACCEPTS: a `matplotlib.transforms.Transform` instance

set_xdata(*x*)

Set the data np.array for x

ACCEPTS: 1D array

set_ydata(*y*)

Set the data np.array for y

ACCEPTS: 1D array

update_from(*other*)

copy properties from other to self

validCap = ('butt', 'round', 'projecting')

validJoin = ('miter', 'round', 'bevel')

zorder = 2

class matplotlib.lines.**VertexSelector**(*line*)

Bases: object

Manage the callbacks to maintain a list of selected vertices for *matplotlib.lines.Line2D*. Derived classes should override *process_selected()* to do something with the picks.

Here is an example which highlights the selected verts with red circles:

```
import numpy as np
import matplotlib.pyplot as plt
import matplotlib.lines as lines

class HighlightSelected(lines.VertexSelector):
    def __init__(self, line, fmt='ro', **kwargs):
        lines.VertexSelector.__init__(self, line)
        self.markers, = self.axes.plot([], [], fmt, **kwargs)

    def process_selected(self, ind, xs, ys):
        self.markers.set_data(xs, ys)
        self.canvas.draw()

fig = plt.figure()
ax = fig.add_subplot(111)
x, y = np.random.rand(2, 30)
line, = ax.plot(x, y, 'bs-', picker=5)

selector = HighlightSelected(line)
plt.show()
```

Initialize the class with a *matplotlib.lines.Line2D* instance. The line should already be added to some *matplotlib.axes.Axes* instance and should have the picker property set.

onpick(*event*)

When the line is picked, update the set of selected indices.

process_selected(*ind, xs, ys*)

Default “do nothing” implementation of the `process_selected()` method.

ind are the indices of the selected vertices. *xs* and *ys* are the coordinates of the selected vertices.

`matplotlib.lines.segment_hits`(*cx, cy, x, y, radius*)

Determine if any line segments are within radius of a point. Returns the list of line segments that are within that radius.

MARKERS

37.1 matplotlib.markers

This module contains functions to handle markers. Used by both the marker functionality of *plot* and *scatter*.

All possible markers are defined here:

marker	description
"."	point
","	pixel
"o"	circle
"v"	triangle_down
"^"	triangle_up
"<"	triangle_left
">"	triangle_right
"1"	tri_down
"2"	tri_up
"3"	tri_left
"4"	tri_right
"8"	octagon
"s"	square
"p"	pentagon
"P"	plus (filled)
"*"	star
"h"	hexagon1
"H"	hexagon2
"+"	plus
"x"	x
"X"	x (filled)
"D"	diamond
"d"	thin_diamond
" "	vline
"_"	hline
TICKLEFT	tickleft

Continued on next page

Table 37.1 – continued from previous page

marker	description
TICKRIGHT	tickright
TICKUP	tickup
TICKDOWN	tickdown
CARETLEFT	caretleft (centered at tip)
CARETRIGHT	caretright (centered at tip)
CARETUP	caretup (centered at tip)
CARETDOWN	caretdown (centered at tip)
CARETLEFTBASE	caretleft (centered at base)
CARETRIGHTBASE	caretright (centered at base)
CARETUPBASE	caretup (centered at base)
"None", " " or ""	nothing
'\$...\$'	render the string using <code>mathtext</code> .
verts	a list of (x, y) pairs used for Path vertices. The center of the marker is located at (0,0) and the size is normalized.
path	a <i>Path</i> instance.
(numsides, style, angle)	<p>The marker can also be a tuple (numsides, style, angle), which will create a custom, regular symbol.</p> <p>numsides: the number of sides</p> <p>style: the style of the regular symbol:</p> <ul style="list-style-type: none"> 0 a regular polygon 1 a star-like symbol 2 an asterisk 3 a circle (numsides and angle is ignored) <p>angle: the angle of rotation of the symbol</p>

For backward compatibility, the form (verts, 0) is also accepted, but it is equivalent to just verts for giving a raw set of vertices that define the shape.

None is the default which means ‘nothing’, however this table is referred to from other docs for the valid inputs from marker inputs and in those cases None still means ‘default’.

`class matplotlib.markers.MarkerStyle(marker=None, fillstyle=None)`

Bases: object

Parameters marker : string or array_like, optional, default: None

See the descriptions of possible markers in the module docstring.

fillstyle : string, optional, default: ‘full’

‘full’, ‘left’, ‘right’, ‘bottom’, ‘top’, ‘none’

Attributes

markers	(list of known markes)
fillstyles	(list of known fillstyles)
filled_markers	(list of known filled markers.)

filled_markers = ('o', 'v', '^', '<', '>', '8', 's', 'p', '*', 'h', 'H', 'D', 'd', 'P', 'X')

fillstyles = ('full', 'left', 'right', 'bottom', 'top', 'none')

get_alt_path()

get_alt_transform()

get_capstyle()

get_fillstyle()

get_joinstyle()

get_marker()

get_path()

get_snap_threshold()

get_transform()

is_filled()

markers = {':': 'point', ',': 'pixel', 'o': 'circle', 'v': 'triangle_down', '^': 'triangle_up', '<': 'triangle_left', '>': 'triangle_right'}

set_fillstyle(*fillstyle*)

Sets fillstyle

Parameters *fillstyle* : string amongst known fillstyles

set_marker(*marker*)

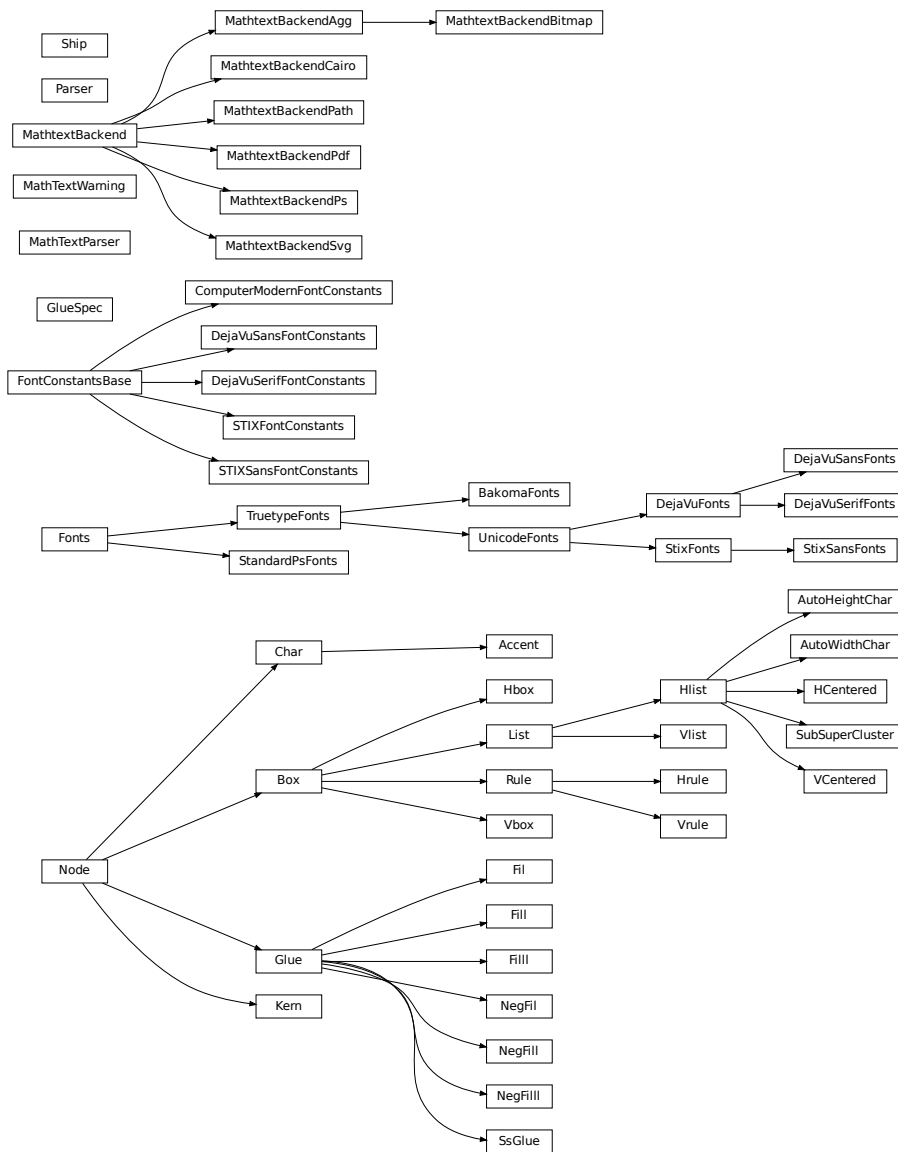

38.1 matplotlib.mathtext

mathtext is a module for parsing a subset of the TeX math syntax and drawing them to a matplotlib backend.

For a tutorial of its usage see *Writing mathematical expressions*. This document is primarily concerned with implementation details.

The module uses *pyarsing* to parse the TeX expression.

The Bakoma distribution of the TeX Computer Modern fonts, and STIX fonts are supported. There is experimental support for using arbitrary fonts, but results may vary without proper tweaking and metrics for those fonts.

class matplotlib.mathtext.**Accent**(*c, state, math=True*)

Bases: *matplotlib.mathtext.Char*

The font metrics need to be dealt with differently for accents, since they are already offset correctly from the baseline in TrueType fonts.

grow()

render(*x, y*)

Render the character to the canvas.

shrink()

class matplotlib.mathtext.**AutoHeightChar**(*c, height, depth, state, always=False, factor=None*)

Bases: *matplotlib.mathtext.Hlist*

AutoHeightChar will create a character as close to the given height and depth as possible. When using a font with multiple height versions of some characters (such as the BaKoMa fonts), the correct glyph will be selected, otherwise this will always just return a scaled version of the glyph.

class matplotlib.mathtext.**AutoWidthChar**(*c, width, state, always=False, char_class=<class 'matplotlib.mathtext.Char'>*)

Bases: *matplotlib.mathtext.Hlist*

AutoWidthChar will create a character as close to the given width as possible. When using a font with multiple width versions of some characters (such as the BaKoMa fonts), the correct glyph will be selected, otherwise this will always just return a scaled version of the glyph.

class matplotlib.mathtext.**BakomaFonts**(*args, **kwargs)

Bases: *matplotlib.mathtext.TruetypeFonts*

Use the Bakoma TrueType fonts for rendering.

Symbols are strewn about a number of font files, each of which has its own proprietary 8-bit encoding.

alias = '\\j'

```
get_sized_alternatives_for_symbol(fontname, sym)
```

```
target = ']
```

```
class matplotlib.mathtext.Box(width, height, depth)
```

```
    Bases: matplotlib.mathtext.Node
```

Represents any node with a physical location.

```
grow()
```

```
render(x1, y1, x2, y2)
```

```
shrink()
```

```
class matplotlib.mathtext.Char(c, state, math=True)
```

```
    Bases: matplotlib.mathtext.Node
```

Represents a single character. Unlike TeX, the font information and metrics are stored with each *Char* to make it easier to lookup the font metrics when needed. Note that TeX boxes have a width, height, and depth, unlike Type1 and Truetype which use a full bounding box and an advance in the x-direction. The metrics must be converted to the TeX way, and the advance (if different from width) must be converted into a *Kern* node when the *Char* is added to its parent *Hlist*.

```
get_kerning(next)
```

Return the amount of kerning between this and the given character. Called when characters are strung together into *Hlist* to create *Kern* nodes.

```
grow()
```

```
is_slanted()
```

```
render(x, y)
```

Render the character to the canvas

```
shrink()
```

```
class matplotlib.mathtext.ComputerModernFontConstants
```

```
    Bases: matplotlib.mathtext.FontConstantsBase
```

```
delta = 0.075
```

```
delta_integral = 0.3
```

```
delta_slanted = 0.3
```

script_space = 0.075

sub1 = 0.2

sub2 = 0.3

subdrop = 0.2

sup1 = 0.45

class matplotlib.mathtext.DejaVuFonts(*args, **kwargs)

Bases: *matplotlib.mathtext.UnicodeFonts*

use_cmex = False

class matplotlib.mathtext.DejaVuSansFontConstants

Bases: *matplotlib.mathtext.FontConstantsBase*

class matplotlib.mathtext.DejaVuSansFonts(*args, **kwargs)

Bases: *matplotlib.mathtext.DejaVuFonts*

A font handling class for the DejaVu Sans fonts

If a glyph is not found it will fallback to Stix Sans

class matplotlib.mathtext.DejaVuSerifFontConstants

Bases: *matplotlib.mathtext.FontConstantsBase*

class matplotlib.mathtext.DejaVuSerifFonts(*args, **kwargs)

Bases: *matplotlib.mathtext.DejaVuFonts*

A font handling class for the DejaVu Serif fonts

If a glyph is not found it will fallback to Stix Serif

matplotlib.mathtext.Error(msg)

Helper class to raise parser errors.

class matplotlib.mathtext.Fil

Bases: *matplotlib.mathtext.Glue*

class matplotlib.mathtext.Fill

Bases: *matplotlib.mathtext.Glue*

class matplotlib.mathtext.Filll

Bases: *matplotlib.mathtext.Glue*

class matplotlib.mathtext.FontConstantsBase

Bases: object

A set of constants that controls how certain things, such as sub- and superscripts are laid out. These are all metrics that can't be reliably retrieved from the font metrics in the font itself.

delta = 0.025

delta_integral = 0.1

delta_slanted = 0.2

script_space = 0.05

sub1 = 0.3

sub2 = 0.5

subdrop = 0.4

sup1 = 0.7

class matplotlib.mathtext.**Fonts**(*default_font_prop*, *mathtext_backend*)

Bases: object

An abstract base class for a system of fonts to use for mathtext.

The class must be able to take symbol keys and font file names and return the character metrics. It also delegates to a backend class to do the actual drawing.

default_font_prop: A *FontProperties* object to use for the default non-math font, or the base font for Unicode (generic) font rendering.

mathtext_backend: A subclass of *MathTextBackend* used to delegate the actual rendering.

destroy()

Fix any cyclical references before the object is about to be destroyed.

get_kern(*font1*, *fontclass1*, *sym1*, *fontsize1*, *font2*, *fontclass2*, *sym2*, *fontsize2*, *dpi*)

Get the kerning distance for font between *sym1* and *sym2*.

fontX: one of the TeX font names:

tt, it, rm, cal, sf, bf or default/regular (non-math)

fontclassX: TODO

symX: a symbol in raw TeX form. e.g., '1', 'x' or 'sigma'

fontsizeX: the fontsize in points

dpi: the current dots-per-inch

get_metrics(*font*, *font_class*, *sym*, *fontsize*, *dpi*, *math=True*)

font: one of the TeX font names:

tt, it, rm, cal, sf, bf or default/regular (non-math)

font_class: TODO

sym: a symbol in raw TeX form. e.g., ‘1’, ‘x’ or ‘sigma’

fontsize: font size in points

dpi: current dots-per-inch

math: whether sym is a math character

Returns an object with the following attributes:

- *advance*: The advance distance (in points) of the glyph.
- *height*: The height of the glyph in points.
- *width*: The width of the glyph in points.
- *xmin, xmax, ymin, ymax* - the ink rectangle of the glyph
- *iceberg* - the distance from the baseline to the top of the glyph. This corresponds to TeX’s definition of “height”.

get_results(*box*)

Get the data needed by the backend to render the math expression. The return value is backend-specific.

get_sized_alternatives_for_symbol(*fontname, sym*)

Override if your font provides multiple sizes of the same symbol. Should return a list of symbols matching *sym* in various sizes. The expression renderer will select the most appropriate size for a given situation from this list.

get_underline_thickness(*font, fontsize, dpi*)

Get the line thickness that matches the given font. Used as a base unit for drawing lines such as in a fraction or radical.

get_used_characters()

Get the set of characters that were used in the math expression. Used by backends that need to subset fonts so they know which glyphs to include.

get_xheight(*font, fontsize, dpi*)

Get the xheight for the given *font* and *fontsize*.

render_glyph(*ox, oy, facename, font_class, sym, fontsize, dpi*)

Draw a glyph at

- *ox, oy*: position
- *facename*: One of the TeX face names
- *font_class*:
- *sym*: TeX symbol name or single character
- *fontsize*: fontsize in points

- dpi*: The dpi to draw at.

render_rect_filled(*x1*, *y1*, *x2*, *y2*)

Draw a filled rectangle from (*x1*, *y1*) to (*x2*, *y2*).

set_canvas_size(*w*, *h*, *d*)

Set the size of the buffer used to render the math expression. Only really necessary for the bitmap backends.

class matplotlib.mathtext.**Glue**(*glue_type*, *copy=False*)

Bases: [matplotlib.mathtext.Node](#)

Most of the information in this object is stored in the underlying [GlueSpec](#) class, which is shared between multiple glue objects. (This is a memory optimization which probably doesn't matter anymore, but it's easier to stick to what TeX does.)

grow()

shrink()

class matplotlib.mathtext.**GlueSpec**(*width=0.0*, *stretch=0.0*, *stretch_order=0*, *shrink=0.0*,
shrink_order=0)

Bases: object

See [Glue](#).

copy()

classmethod **factory**(*glue_type*)

class matplotlib.mathtext.**HCentered**(*elements*)

Bases: [matplotlib.mathtext.Hlist](#)

A convenience class to create an [Hlist](#) whose contents are centered within its enclosing box.

class matplotlib.mathtext.**Hbox**(*width*)

Bases: [matplotlib.mathtext.Box](#)

A box with only width (zero height and depth).

class matplotlib.mathtext.**Hlist**(*elements*, *w=0.0*, *m='additional'*, *do_kern=True*)

Bases: [matplotlib.mathtext.List](#)

A horizontal list of boxes.

hpack(*w=0.0*, *m='additional'*)

The main duty of [hpack\(\)](#) is to compute the dimensions of the resulting boxes, and to adjust the glue if one of those dimensions is pre-specified. The computed sizes normally enclose all of the material inside the new box; but some items may stick out if negative glue is used, if the box is overfull, or if a `\vbox` includes other boxes that have been shifted left.

- w*: specifies a width

- *m*: is either ‘exactly’ or ‘additional’.

Thus, `hpack(w, 'exactly')` produces a box whose width is exactly w , while `hpack(w, 'additional')` yields a box whose width is the natural width plus w . The default values produce a box with the natural width.

kern()

Insert *Kern* nodes between *Char* nodes to set kerning. The *Char* nodes themselves determine the amount of kerning they need (in `get_kerning()`), and this function just creates the linked list in the correct way.

class `matplotlib.mathtext.Hrule`(*state*, *thickness=None*)

Bases: `matplotlib.mathtext.Rule`

Convenience class to create a horizontal rule.

class `matplotlib.mathtext.Kern`(*width*)

Bases: `matplotlib.mathtext.Node`

A *Kern* node has a *width* field to specify a (normally negative) amount of spacing. This spacing correction appears in horizontal lists between letters like A and V when the font designer said that it looks better to move them closer together or further apart. A kern node can also appear in a vertical list, when its *width* denotes additional spacing in the vertical direction.

depth = 0

grow()

height = 0

shrink()

class `matplotlib.mathtext.List`(*elements*)

Bases: `matplotlib.mathtext.Box`

A list of nodes (either horizontal or vertical).

grow()

shrink()

class `matplotlib.mathtext.MathTextParser`(*output*)

Bases: `object`

Create a `MathTextParser` for the given backend *output*.

get_depth(*texstr*, *dpi=120*, *fontsize=14*)

Returns the offset of the baseline from the bottom of the image in pixels.

texstr A valid mathtext string, e.g., `r'IQ: \sigma_i=15$'`

dpi The dots-per-inch to render the text

fontsize The font size in points

parse(*s*, *dpi*=72, *prop*=None)

Parse the given math expression *s* at the given *dpi*. If *prop* is provided, it is a *FontProperties* object specifying the “default” font to use in the math expression, used for all non-math text.

The results are cached, so multiple calls to `parse()` with the same expression should be fast.

to_mask(*texstr*, *dpi*=120, *fontsize*=14)

texstr A valid mathtext string, e.g., `r'IQ: $\sigma_i=15$'`

dpi The dots-per-inch to render the text

fontsize The font size in points

Returns a tuple (*array*, *depth*)

- *array* is an NxM uint8 alpha ubyte mask array of rasterized tex.
- *depth* is the offset of the baseline from the bottom of the image in pixels.

to_png(*filename*, *texstr*, *color*='black', *dpi*=120, *fontsize*=14)

Writes a tex expression to a PNG file.

Returns the offset of the baseline from the bottom of the image in pixels.

filename A writable filename or fileobject

texstr A valid mathtext string, e.g., `r'IQ: $\sigma_i=15$'`

color A valid matplotlib color argument

dpi The dots-per-inch to render the text

fontsize The font size in points

Returns the offset of the baseline from the bottom of the image in pixels.

to_rgba(*texstr*, *color*='black', *dpi*=120, *fontsize*=14)

texstr A valid mathtext string, e.g., `r'IQ: $\sigma_i=15$'`

color Any matplotlib color argument

dpi The dots-per-inch to render the text

fontsize The font size in points

Returns a tuple (*array*, *depth*)

- *array* is an NxM uint8 alpha ubyte mask array of rasterized tex.
- *depth* is the offset of the baseline from the bottom of the image in pixels.

exception matplotlib.mathtext.**MathTextWarning**

Bases: Warning

class matplotlib.mathtext.MathtextBackend

Bases: object

The base class for the mathtext backend-specific code. The purpose of *MathtextBackend* subclasses is to interface between mathtext and a specific matplotlib graphics backend.

Subclasses need to override the following:

- *render_glyph()*
- *render_rect_filled()*
- *get_results()*

And optionally, if you need to use a FreeType hinting style:

- *get_hinting_type()*

get_hinting_type()

Get the FreeType hinting type to use with this particular backend.

get_results(*box*)

Return a backend-specific tuple to return to the backend after all processing is done.

render_glyph(*ox, oy, info*)

Draw a glyph described by *info* to the reference point (*ox, oy*).

render_rect_filled(*x1, y1, x2, y2*)

Draw a filled black rectangle from (*x1, y1*) to (*x2, y2*).

set_canvas_size(*w, h, d*)

Dimension the drawing canvas

class matplotlib.mathtext.MathtextBackendAggBases: *matplotlib.mathtext.MathtextBackend*

Render glyphs and rectangles to an FTImage buffer, which is later transferred to the Agg image by the Agg backend.

get_hinting_type()**get_results(*box, used_characters*)****render_glyph(*ox, oy, info*)****render_rect_filled(*x1, y1, x2, y2*)****set_canvas_size(*w, h, d*)****class matplotlib.mathtext.MathtextBackendBitmap**Bases: *matplotlib.mathtext.MathtextBackendAgg*

get_results(*box, used_characters*)

class matplotlib.mathtext.MathtextBackendCairo

Bases: *matplotlib.mathtext.MathtextBackend*

Store information to write a mathtext rendering to the Cairo backend.

get_results(*box, used_characters*)

render_glyph(*ox, oy, info*)

render_rect_filled(*x1, y1, x2, y2*)

class matplotlib.mathtext.MathtextBackendPath

Bases: *matplotlib.mathtext.MathtextBackend*

Store information to write a mathtext rendering to the text path machinery.

get_results(*box, used_characters*)

render_glyph(*ox, oy, info*)

render_rect_filled(*x1, y1, x2, y2*)

class matplotlib.mathtext.MathtextBackendPdf

Bases: *matplotlib.mathtext.MathtextBackend*

Store information to write a mathtext rendering to the PDF backend.

get_results(*box, used_characters*)

render_glyph(*ox, oy, info*)

render_rect_filled(*x1, y1, x2, y2*)

class matplotlib.mathtext.MathtextBackendPs

Bases: *matplotlib.mathtext.MathtextBackend*

Store information to write a mathtext rendering to the PostScript backend.

get_results(*box, used_characters*)

render_glyph(*ox, oy, info*)

render_rect_filled(*x1, y1, x2, y2*)

class matplotlib.mathtext.**MathtextBackendSvg**

Bases: *matplotlib.mathtext.MathtextBackend*

Store information to write a mathtext rendering to the SVG backend.

get_results(*box, used_characters*)

render_glyph(*ox, oy, info*)

render_rect_filled(*x1, y1, x2, y2*)

class matplotlib.mathtext.**NegFil**

Bases: *matplotlib.mathtext.Glue*

class matplotlib.mathtext.**NegFill**

Bases: *matplotlib.mathtext.Glue*

class matplotlib.mathtext.**NegFilll**

Bases: *matplotlib.mathtext.Glue*

class matplotlib.mathtext.**Node**

Bases: object

A node in the TeX box model

get_kerning(*next*)

grow()

Grows one level larger. There is no limit to how big something can get.

render(*x, y*)

shrink()

Shrinks one level smaller. There are only three levels of sizes, after which things will no longer get smaller.

class matplotlib.mathtext.**Parser**

Bases: object

This is the pyparsing-based parser for math expressions. It actually parses full strings *containing* math expressions, in that raw text may also appear outside of pairs of \$.

The grammar is based directly on that in TeX, though it cuts a few corners.

class **State**(*font_output, font, font_class, fontsize, dpi*)

Bases: object

Stores the state of the parser.

States are pushed and popped from a stack as necessary, and the “current” state is always at the top of the stack.

copy()

font

accent(*s, loc, toks*)

auto_delim(*s, loc, toks*)

binom(*s, loc, toks*)

c_over_c(*s, loc, toks*)

customspace(*s, loc, toks*)

end_group(*s, loc, toks*)

font(*s, loc, toks*)

frac(*s, loc, toks*)

function(*s, loc, toks*)

genfrac(*s, loc, toks*)

get_state()

Get the current *State* of the parser.

group(*s, loc, toks*)

is_between_brackets(*s, loc*)

is_dropsup(*nucleus*)

is_overunder(*nucleus*)

is_slanted(*nucleus*)

main(*s, loc, toks*)

math(*s, loc, toks*)

math_string(*s, loc, toks*)

non_math(*s, loc, toks*)

operatorname(*s, loc, toks*)

overline(*s, loc, toks*)

parse(*s, fonts_object, fontsize, dpi*)

Parse expression *s* using the given *fonts_object* for output, at the given *fontsize* and *dpi*.

Returns the parse tree of *Node* instances.

pop_state()

Pop a *State* off of the stack.

push_state()

Push a new *State* onto the stack which is just a copy of the current state.

required_group(*s, loc, toks*)

simple_group(*s, loc, toks*)

snowflake(*s, loc, toks*)

space(*s, loc, toks*)

sqrt(*s, loc, toks*)

stackrel(*s, loc, toks*)

start_group(*s, loc, toks*)

subsuper(*s, loc, toks*)

symbol(*s, loc, toks*)

unknown_symbol(*s, loc, toks*)

class matplotlib.mathtext.**Rule**(*width, height, depth, state*)

Bases: *matplotlib.mathtext.Box*

A *Rule* node stands for a solid black rectangle; it has *width*, *depth*, and *height* fields just as in an *Hlist*. However, if any of these dimensions is *inf*, the actual value will be determined by running the rule up to the boundary of the innermost enclosing box. This is called a “running dimension.” The width is never running in an *Hlist*; the height and depth are never running in a *Vlist*.

render(*x, y, w, h*)

class matplotlib.mathtext.**STIXFontConstants**

Bases: *matplotlib.mathtext.FontConstantsBase*

delta = 0.05

delta_integral = 0.3

delta_slanted = 0.3

script_space = 0.1

sub2 = 0.6

sup1 = 0.8

class matplotlib.mathtext.**STIXSansFontConstants**

Bases: *matplotlib.mathtext.FontConstantsBase*

delta_integral = 0.3

delta_slanted = 0.6

script_space = 0.05

sup1 = 0.8

class matplotlib.mathtext.**Ship**

Bases: *object*

Once the boxes have been set up, this sends them to output. Since boxes can be inside of boxes inside of boxes, the main work of *Ship* is done by two mutually recursive routines, *hlist_out()* and *vlist_out()*, which traverse the *Hlist* nodes and *Vlist* nodes inside of horizontal and vertical boxes. The global variables used in TeX to store state as it processes have become member variables here.

`static clamp(value)`

`hlist_out(box)`

`vlist_out(box)`

`class matplotlib.mathtext.SsGlue`

Bases: `matplotlib.mathtext.Glue`

`class matplotlib.mathtext.StandardPsFonts(default_font_prop)`

Bases: `matplotlib.mathtext.Fonts`

Use the standard postscript fonts for rendering to backend_ps

Unlike the other font classes, BakomaFont and UnicodeFont, this one requires the Ps backend.

`basepath = '/tmp/mpl_clean/lib/python3.6/site-packages/matplotlib/mpl-data/fonts/afm'`

`fontmap = {'cal': 'pzcmi8a', 'rm': 'pncr8a', 'tt': 'pcrr8a', 'it': 'pncr8a', 'sf': 'phvr8a', 'bf': 'pncb8a', None:`

`get_kern(font1, fontclass1, sym1, fontsize1, font2, fontclass2, sym2, fontsize2, dpi)`

`get_underline_thickness(font, fontsize, dpi)`

`get_xheight(font, fontsize, dpi)`

`class matplotlib.mathtext.StixFonts(*args, **kwargs)`

Bases: `matplotlib.mathtext.UnicodeFonts`

A font handling class for the STIX fonts.

In addition to what UnicodeFonts provides, this class:

- supports “virtual fonts” which are complete alpha numeric character sets with different font styles at special Unicode code points, such as “Blackboard”.
- handles sized alternative characters for the STIXSizeX fonts.

`cm_fallback = False`

`get_sized_alternatives_for_symbol(fontname, sym)`

`use_cmex = False`

`class matplotlib.mathtext.StixSansFonts(*args, **kwargs)`

Bases: `matplotlib.mathtext.StixFonts`

A font handling class for the STIX fonts (that uses sans-serif characters by default).

class `matplotlib.mathtext.SubSuperCluster`

Bases: `matplotlib.mathtext.Hlist`

SubSuperCluster is a sort of hack to get around that fact that this code do a two-pass parse like TeX. This lets us store enough information in the *hlist* itself, namely the nucleus, sub- and super-script, such that if another script follows that needs to be attached, it can be reconfigured on the fly.

class `matplotlib.mathtext.TruetypeFonts`(*default_font_prop*, *mathtext_backend*)

Bases: `matplotlib.mathtext.Fonts`

A generic base class for all font setups that use Truetype fonts (through FT2Font).

destroy()

get_kern(*font1*, *fontclass1*, *sym1*, *fontsize1*, *font2*, *fontclass2*, *sym2*, *fontsize2*, *dpi*)

get_underline_thickness(*font*, *fontsize*, *dpi*)

get_xheight(*fontname*, *fontsize*, *dpi*)

class `matplotlib.mathtext.UnicodeFonts`(**args*, ***kwargs*)

Bases: `matplotlib.mathtext.TruetypeFonts`

An abstract base class for handling Unicode fonts.

While some reasonably complete Unicode fonts (such as DejaVu) may work in some situations, the only Unicode font I'm aware of with a complete set of math symbols is STIX.

This class will “fallback” on the Bakoma fonts when a required symbol can not be found in the font.

get_sized_alternatives_for_symbol(*fontname*, *sym*)

use_cmex = True

class `matplotlib.mathtext.VCentered`(*elements*)

Bases: `matplotlib.mathtext.Hlist`

A convenience class to create a *Vlist* whose contents are centered within its enclosing box.

class `matplotlib.mathtext.Vbox`(*height*, *depth*)

Bases: `matplotlib.mathtext.Box`

A box with only height (zero width).

class `matplotlib.mathtext.Vlist`(*elements*, *h=0.0*, *m='additional'*)

Bases: `matplotlib.mathtext.List`

A vertical list of boxes.

vpack($h=0.0$, $m='additional'$, $l=inf$)

The main duty of `vpack()` is to compute the dimensions of the resulting boxes, and to adjust the glue if one of those dimensions is pre-specified.

- h : specifies a height
- m : is either 'exactly' or 'additional'.
- l : a maximum height

Thus, `vpack(h, 'exactly')` produces a box whose height is exactly h , while `vpack(h, 'additional')` yields a box whose height is the natural height plus h . The default values produce a box with the natural width.

class `matplotlib.mathtext.Vrule`(*state*)

Bases: `matplotlib.mathtext.Rule`

Convenience class to create a vertical rule.

`matplotlib.mathtext.get_unicode_index`(*symbol*[, *bool*]) → integer

Return the integer index (from the Unicode table) of *symbol*. *symbol* can be a single unicode character, a TeX command (i.e. `r'pi'`), or a Type1 symbol name (i.e. `'phi'`). If *math* is `False`, the current symbol should be treated as a non-math symbol.

`matplotlib.mathtext.math_to_image`(*s*, *filename_or_obj*, *prop=None*, *dpi=None*, *format=None*)

Given a math expression, renders it in a closely-clipped bounding box to an image file.

s A math expression. The math portion should be enclosed in dollar signs.

filename_or_obj A filepath or writable file-like object to write the image data to.

prop If provided, a `FontProperties()` object describing the size and style of the text.

dpi Override the output dpi, otherwise use the default associated with the output format.

format The output format, e.g., `'svg'`, `'pdf'`, `'ps'` or `'png'`. If not provided, will be deduced from the filename.

`matplotlib.mathtext.unichr_safe`(*index*)

Return the Unicode character corresponding to the index, or the replacement character if this is a narrow build of Python and the requested character is outside the BMP.

39.1 matplotlib.mlab

Numerical python functions written for compatability with MATLAB commands with the same names.

39.1.1 MATLAB compatible functions

cohere() Coherence (normalized cross spectral density)

csd() Cross spectral density using Welch's average periodogram

detrend() Remove the mean or best fit line from an array

find() Return the indices where some condition is true; `numpy.nonzero` is similar but more general.

griddata() Interpolate irregularly distributed data to a regular grid.

prctile() Find the percentiles of a sequence

prepca() Principal Component Analysis

psd() Power spectral density using Welch's average periodogram

rk4() A 4th order runge kutta integrator for 1D or ND systems

specgram() Spectrogram (spectrum over segments of time)

39.1.2 Miscellaneous functions

Functions that don't exist in MATLAB, but are useful anyway:

cohere_pairs() Coherence over all pairs. This is not a MATLAB function, but we compute coherence a lot in my lab, and we compute it for a lot of pairs. This function is optimized to do this efficiently by caching the direct FFTs.

rk4() A 4th order Runge-Kutta ODE integrator in case you ever find yourself stranded without scipy (and the far superior `scipy.integrate` tools)

contiguous_regions() Return the indices of the regions spanned by some logical mask

cross_from_below() Return the indices where a 1D array crosses a threshold from below

`cross_from_above()` Return the indices where a 1D array crosses a threshold from above

`complex_spectrum()` Return the complex-valued frequency spectrum of a signal

`magnitude_spectrum()` Return the magnitude of the frequency spectrum of a signal

`angle_spectrum()` Return the angle (wrapped phase) of the frequency spectrum of a signal

`phase_spectrum()` Return the phase (unwrapped angle) of the frequency spectrum of a signal

`detrend_mean()` Remove the mean from a line.

`demean()` Remove the mean from a line. This function is the same as `detrend_mean()` except for the default *axis*.

`detrend_linear()` Remove the best fit line from a line.

`detrend_none()` Return the original line.

`stride_windows()` Get all windows in an array in a memory-efficient manner

`stride_repeat()` Repeat an array in a memory-efficient manner

`apply_window()` Apply a window along a given axis

39.1.3 record array helper functions

A collection of helper methods for numpyrecord arrays

See *misc Examples*

`rec2txt()` Pretty print a record array

`rec2csv()` Store record array in CSV file

`csv2rec()` Import record array from CSV file with type inspection

`rec_append_fields()` Adds field(s)/array(s) to record array

`rec_drop_fields()` Drop fields from record array

`rec_join()` Join two record arrays on sequence of fields

`recs_join()` A simple join of multiple recarrays using a single column as a key

`rec_groupby()` Summarize data by groups (similar to SQL GROUP BY)

`rec_summarize()` Helper code to filter rec array fields into new fields

For the rec viewer functions(e `rec2csv`), there are a bunch of Format objects you can pass into the functions that will do things like color negative values red, set percent formatting and scaling, etc.

Example usage:

```
r = csv2rec('somefile.csv', checkrows=0)

formatd = dict(
    weight = FormatFloat(2),
    change = FormatPercent(2),
```

```

    cost = FormatThousands(2),
    )

rec2excel(r, 'test.xls', formatd=formatd)
rec2csv(r, 'test.csv', formatd=formatd)
scroll = rec2gtk(r, formatd=formatd)

win = gtk.Window()
win.set_size_request(600,800)
win.add(scroll)
win.show_all()
gtk.main()

```

class matplotlib.mlab.FormatBool

Bases: *matplotlib.mlab.FormatObj*

fromstr(*s*)

toval(*x*)

class matplotlib.mlab.FormatDate(*fmt*)

Bases: *matplotlib.mlab.FormatObj*

fromstr(*x*)

toval(*x*)

class matplotlib.mlab.FormatDatetime(*fmt*='%Y-%m-%d %H:%M:%S')

Bases: *matplotlib.mlab.FormatDate*

fromstr(*x*)

class matplotlib.mlab.FormatFloat(*precision*=4, *scale*=1.0)

Bases: *matplotlib.mlab.FormatFormatStr*

fromstr(*s*)

toval(*x*)

class matplotlib.mlab.FormatFormatStr(*fmt*)

Bases: *matplotlib.mlab.FormatObj*

tostr(*x*)

class matplotlib.mlab.FormatInt

Bases: *matplotlib.mlab.FormatObj*

fromstr(*s*)

tostr(*x*)

toval(*x*)

class matplotlib.mlab.**FormatMillions**(*precision=4*)

Bases: *matplotlib.mlab.FormatFloat*

class matplotlib.mlab.**FormatObj**

Bases: object

fromstr(*s*)

tostr(*x*)

toval(*x*)

class matplotlib.mlab.**FormatPercent**(*precision=4*)

Bases: *matplotlib.mlab.FormatFloat*

class matplotlib.mlab.**FormatString**

Bases: *matplotlib.mlab.FormatObj*

tostr(*x*)

class matplotlib.mlab.**FormatThousands**(*precision=4*)

Bases: *matplotlib.mlab.FormatFloat*

class matplotlib.mlab.**GaussianKDE**(*dataset, bw_method=None*)

Bases: object

Representation of a kernel-density estimate using Gaussian kernels.

Parameters dataset : array_like

Datapoints to estimate from. In case of univariate data this is a 1-D array, otherwise a 2-D array with shape (# of dims, # of data).

bw_method : str, scalar or callable, optional

The method used to calculate the estimator bandwidth. This can be 'scott', 'silverman', a scalar constant or a callable. If a scalar, this will be used directly as `kde.factor`. If a callable, it should take a *GaussianKDE* instance as only parameter and return a scalar. If None (default), 'scott' is used.

Attributes

dataset	(ndarray) The dataset with which <code>gaussian_kde</code> was initialized.
dim	(int) Number of dimensions.
num_dp	(int) Number of datapoints.
factor	(float) The bandwidth factor, obtained from <code>kde.covariance_factor</code> , with which the covariance matrix is multiplied.
covariance	(ndarray) The covariance matrix of <code>dataset</code> , scaled by the calculated bandwidth (<code>kde.factor</code>).
inv_cov	(ndarray) The inverse of <code>covariance</code> .

Methods

<code>kde.evaluate(points)</code>	(ndarray) Evaluate the estimated pdf on a provided set of points.
<code>kde(points)</code>	(ndarray) Same as <code>kde.evaluate(points)</code>

`covariance_factor()`

`evaluate(points)`

Evaluate the estimated pdf on a set of points.

Parameters `points` : (# of dimensions, # of points)-array

Alternatively, a (# of dimensions,) vector can be passed in and treated as a single point.

Returns values : (# of points,)-array

The values at each point.

Raises ValueError : if the dimensionality of the input points is different than the dimensionality of the KDE.

`scotts_factor()`

`silverman_factor()`

`class matplotlib.mlab.PCA(a, standardize=True)`

Bases: object

compute the SVD of `a` and store data for PCA. Use `project` to project the data onto a reduced set of dimensions

Parameters `a` : np.ndarray

A numobservations x numdims array

standardize : bool

True if input data are to be standardized. If False, only centering will be carried out.

Notes

The factor loadings are in the `Wt` factor, i.e., the factor loadings for the first principal component are given by `Wt[0]`. This row is also the first eigenvector.

Attributes

<code>a</code>	A centered unit sigma version of input <code>a</code> .
<code>numrows</code> , <code>numcols</code>	The dimensions of <code>a</code> .
<code>mu</code>	A numdims array of means of <code>a</code> . This is the vector that points to the origin of PCA space.
<code>sigma</code>	A numdims array of standard deviation of <code>a</code> .
<code>fracs</code>	The proportion of variance of each of the principal components.
<code>s</code>	The actual eigenvalues of the decomposition.
<code>Wt</code>	The weight vector for projecting a numdims point or array into PCA space.
<code>Y</code>	A projected into PCA space.

`center(x)`

center and optionally standardize the data using the mean and sigma from training set `a`

`project(x, minfrac=0.0)`

project `x` onto the principle axes, dropping any axes where fraction of variance < `minfrac`

`matplotlib.mlab.amap(function, sequence[, sequence, ...])` → array.

Works like `map()`, but it returns an array. This is just a convenient shorthand for `numpy.array(map(...))`.

`matplotlib.mlab.angle_spectrum(x, Fs=None, window=None, pad_to=None, sides=None)`

Compute the angle of the frequency spectrum (wrapped phase spectrum) of `x`. Data is padded to a length of `pad_to` and the windowing function `window` is applied to the signal.

Parameters `x` : 1-D array or sequence

Array or sequence containing the data

`Fs` : scalar

The sampling frequency (samples per time unit). It is used to calculate the Fourier frequencies, `freqs`, in cycles per time unit. The default value is 2.

`window` : callable or ndarray

A function or a vector of length `NFFT`. To create window vectors see `window_hanning()`, `window_none()`, `numpy.blackman()`, `numpy.hamming()`, `numpy.bartlett()`, `scipy.signal()`, `scipy.signal.get_window()`, etc. The default is `window_hanning()`. If a function is

passed as the argument, it must take a data segment as an argument and return the windowed version of the segment.

sides : ['default' | 'onesided' | 'twosided']

Specifies which sides of the spectrum to return. Default gives the default behavior, which returns one-sided for real data and both for complex data. 'onesided' forces the return of a one-sided spectrum, while 'twosided' forces two-sided.

pad_to : integer

The number of points to which the data segment is padded when performing the FFT. While not increasing the actual resolution of the spectrum (the minimum distance between resolvable peaks), this can give more points in the plot, allowing for more detail. This corresponds to the n parameter in the call to `fft()`. The default is `None`, which sets `pad_to` equal to the length of the input signal (i.e. no padding).

Returns spectrum : 1-D array

The values for the angle spectrum in radians (real valued)

freqs : 1-D array

The frequencies corresponding to the elements in `spectrum`

See also:

`complex_spectrum()` This function returns the angle value of `complex_spectrum()`.

`magnitude_spectrum()` `angle_spectrum()` returns the magnitudes of the corresponding frequencies.

`phase_spectrum()` `phase_spectrum()` returns the unwrapped version of this function.

`specgram()` `specgram()` can return the angle spectrum of segments within the signal.

`matplotlib.mlab.apply_window(x, window, axis=0, return_window=None)`

Apply the given window to the given 1D or 2D array along the given axis.

Parameters x : 1D or 2D array or sequence

Array or sequence containing the data.

window : function or array.

Either a function to generate a window or an array with length `x.shape[axis]`

axis : integer

The axis over which to do the repetition. Must be 0 or 1. The default is 0

return_window : bool

If true, also return the 1D values of the window that was applied

`matplotlib.mlab.base_repr(number, base=2, padding=0)`

Return the representation of a *number* in any given *base*.

`matplotlib.mlab.binary_repr(number, max_length=1025)`

Return the binary representation of the input *number* as a string.

This is more efficient than using `base_repr()` with base 2.

Increase the value of `max_length` for very large numbers. Note that on 32-bit machines, `2**1023` is the largest integer power of 2 which can be converted to a Python float.

`matplotlib.mlab.bivariate_normal(X, Y, sigmax=1.0, sigmay=1.0, mux=0.0, muy=0.0, sigmaxy=0.0)`

Bivariate Gaussian distribution for equal shape *X*, *Y*.

See [bivariate normal](#) at mathworld.

`matplotlib.mlab.center_matrix(M, dim=0)`

Return the matrix *M* with each row having zero mean and unit std.

If `dim = 1` operate on columns instead of rows. (*dim* is opposite to the numpy axis kwarg.)

`matplotlib.mlab.cohere(x, y, NFFT=256, Fs=2, detrend=<function detrend_none>, window=<function window_hanning>, noverlap=0, pad_to=None, sides='default', scale_by_freq=None)`

The coherence between *x* and *y*. Coherence is the normalized cross spectral density:

$$C_{xy} = \frac{|P_{xy}|^2}{P_{xx}P_{yy}} \quad (39.1)$$

Parameters *x*, *y*

Array or sequence containing the data

Fs : scalar

The sampling frequency (samples per time unit). It is used to calculate the Fourier frequencies, `freqs`, in cycles per time unit. The default value is 2.

window : callable or ndarray

A function or a vector of length *NFFT*. To create window vectors see `window_hanning()`, `window_none()`, `numpy.blackman()`, `numpy.hamming()`, `numpy.bartlett()`, `scipy.signal()`, `scipy.signal.get_window()`, etc. The default is `window_hanning()`. If a function is passed as the argument, it must take a data segment as an argument and return the windowed version of the segment.

sides : ['default' | 'onesided' | 'twosided']

Specifies which sides of the spectrum to return. Default gives the default behavior, which returns one-sided for real data and both for complex data. 'onesided' forces the return of a one-sided spectrum, while 'twosided' forces two-sided.

pad_to : integer

The number of points to which the data segment is padded when performing the FFT. This can be different from *NFFT*, which specifies the number of data points used. While not increasing the actual resolution of the spectrum (the minimum distance between resolvable peaks), this can give more points in the plot, allowing for more detail. This corresponds to the *n* parameter in the call to `fft()`. The default is `None`, which sets *pad_to* equal to *NFFT*

NFFT : integer

The number of data points used in each block for the FFT. A power 2 is most efficient. The default value is 256. This should *NOT* be used to get zero padding, or the scaling of the result will be incorrect. Use *pad_to* for this instead.

detrend : { 'default', 'constant', 'mean', 'linear', 'none' } or callable

The function applied to each segment before fit-ting, designed to remove the mean or linear trend. Unlike in MATLAB, where the *detrend* parameter is a vector, in matplotlib is it a function. The `pylab` module defines `detrend_none()`, `detrend_mean()`, and `detrend_linear()`, but you can use a custom function as well. You can also use a string to choose one of the functions. 'default', 'constant', and 'mean' call `detrend_mean()`. 'linear' calls `detrend_linear()`. 'none' calls `detrend_none()`.

scale_by_freq : boolean, optional

Specifies whether the resulting density values should be scaled by the scaling frequency, which gives density in units of Hz^{-1} . This allows for integration over the returned frequency values. The default is `True` for MATLAB compatibility.

noverlap : integer

The number of points of overlap between blocks. The default value is 0 (no overlap).

Returns The return value is the tuple (C_{xy}, f) , where *f* are the frequencies of the coherence vector. For `cohere`, scaling the individual densities by the sampling frequency has no effect, since the factors cancel out.

See also:

[`psd\(\)`](#), [`csd\(\)`](#)

`matplotlib.mlab.cohere_pairs(X, ij, NFFT=256, Fs=2, detrend=<function detrend_none>, window=<function window_hanning>, noverlap=0, preferSpeedOverMemory=True, progressCallback=<function donothing_callback>, returnPxx=False)`

Compute the coherence and phase for all pairs *ij*, in *X*.

X is a `numSamples * numCols` array

ij is a list of tuples. Each tuple is a pair of indexes into the columns of *X* for which you want to compute coherence. For example, if *X* has 64 columns, and you want to compute all nonredundant pairs, define *ij* as:

```
ij = []
for i in range(64):
    for j in range(i+1,64):
        ij.append( (i,j) )
```

preferSpeedOverMemory is an optional bool. Defaults to true. If False, limits the caching by only making one, rather than two, complex cache arrays. This is useful if memory becomes critical. Even when *preferSpeedOverMemory* is False, *cohere_pairs()* will still give significant performance gains over calling *cohere()* for each pair, and will use substantially less memory than if *preferSpeedOverMemory* is True. In my tests with a 43000,64 array over all nonredundant pairs, *preferSpeedOverMemory* = True delivered a 33% performance boost on a 1.7GHZ Athlon with 512MB RAM compared with *preferSpeedOverMemory* = False. But both solutions were more than 10x faster than naively crunching all possible pairs through *cohere()*.

Returns Cxy : dictionary of (*i, j*) tuples -> coherence vector for

that pair. i.e., $Cxy[(i, j)] = \text{cohere}(X[:, i], X[:, j])$. Number of dictionary keys is $\text{len}(ij)$.

Phase : dictionary of phases of the cross spectral density at

each frequency for each pair. Keys are (*i, j*).

freqs : vector of frequencies, equal in length to either the

coherence or phase vectors for any (*i, j*) key.

e.g., to make a coherence Bode plot:

```
subplot(211)
plot( freqs, Cxy[(12,19)])
subplot(212)
plot( freqs, Phase[(12,19)])
```

For a large number of pairs, *cohere_pairs()* can be much more efficient than just calling *cohere()* for each pair, because it caches most of the intensive computations. If *N* is the number of pairs, this function is $O(N)$ for most of the heavy lifting, whereas calling *cohere* for each pair is $O(N^2)$. However, because of the caching, it is also more memory intensive, making 2 additional complex arrays with approximately the same number of elements as *X*.

See `test/cohere_pairs_test.py` in the src tree for an example script that shows that this *cohere_pairs()* and

[`cohere\(\)`](#) give the same results for a given pair.

See also:

[`psd\(\)`](#) For information about the methods used to compute P_{xy} , P_{xx} and P_{yy} .

`matplotlib.mlab.complex_spectrum(x, Fs=None, window=None, pad_to=None, sides=None)`

Compute the complex-valued frequency spectrum of x . Data is padded to a length of pad_to and the windowing function $window$ is applied to the signal.

Parameters x : 1-D array or sequence

Array or sequence containing the data

Fs : scalar

The sampling frequency (samples per time unit). It is used to calculate the Fourier frequencies, `freqs`, in cycles per time unit. The default value is 2.

window : callable or ndarray

A function or a vector of length $NFFT$. To create window vectors see [`window_hanning\(\)`](#), [`window_none\(\)`](#), `numpy.blackman()`, `numpy.hamming()`, `numpy.bartlett()`, `scipy.signal()`, `scipy.signal.get_window()`, etc. The default is [`window_hanning\(\)`](#). If a function is passed as the argument, it must take a data segment as an argument and return the windowed version of the segment.

sides : ['default' | 'onesided' | 'twosided']

Specifies which sides of the spectrum to return. Default gives the default behavior, which returns one-sided for real data and both for complex data. 'onesided' forces the return of a one-sided spectrum, while 'twosided' forces two-sided.

pad_to : integer

The number of points to which the data segment is padded when performing the FFT. While not increasing the actual resolution of the spectrum (the minimum distance between resolvable peaks), this can give more points in the plot, allowing for more detail. This corresponds to the n parameter in the call to `fft()`. The default is `None`, which sets pad_to equal to the length of the input signal (i.e. no padding).

Returns spectrum : 1-D array

The values for the complex spectrum (complex valued)

freqs : 1-D array

The frequencies corresponding to the elements in *spectrum*

See also:

[`magnitude_spectrum\(\)`](#) [`magnitude_spectrum\(\)`](#) returns the absolute value of this function.

`angle_spectrum()` `angle_spectrum()` returns the angle of this function.

`phase_spectrum()` `phase_spectrum()` returns the phase (unwrapped angle) of this function.

`specgram()` `specgram()` can return the complex spectrum of segments within the signal.

`matplotlib.mlab.contiguous_regions(mask)`

return a list of (ind0, ind1) such that `mask[ind0:ind1].all()` is True and we cover all such regions

`matplotlib.mlab.cross_from_above(x, threshold)`

return the indices into `x` where `x` crosses some threshold from below, e.g., the `i`'s where:

```
x[i-1]>threshold and x[i]<=threshold
```

See also:

`cross_from_below()`

`matplotlib.mlab.cross_from_below(x, threshold)`

return the indices into `x` where `x` crosses some threshold from below, e.g., the `i`'s where:

```
x[i-1]<threshold and x[i]>=threshold
```

Example code:

```
import matplotlib.pyplot as plt

t = np.arange(0.0, 2.0, 0.1)
s = np.sin(2*np.pi*t)

fig = plt.figure()
ax = fig.add_subplot(111)
ax.plot(t, s, '-o')
ax.axhline(0.5)
ax.axhline(-0.5)

ind = cross_from_below(s, 0.5)
ax.vlines(t[ind], -1, 1)

ind = cross_from_above(s, -0.5)
ax.vlines(t[ind], -1, 1)

plt.show()
```

See also:

`cross_from_above()`

`matplotlib.mlab.csd(x, y, NFFT=None, Fs=None, detrend=None, window=None, overlap=None, pad_to=None, sides=None, scale_by_freq=None)`
Compute the cross-spectral density.

Call signature:

```
csd(x, y, NFFT=256, Fs=2, detrend=mlab.detrend_none,
    window=mlab.window_hanning, noverlap=0, pad_to=None,
    sides='default', scale_by_freq=None)
```

The cross spectral density P_{xy} by Welch's average periodogram method. The vectors x and y are divided into $NFFT$ length segments. Each segment is detrended by function *detrend* and windowed by function *window*. *noverlap* gives the length of the overlap between segments. The product of the direct FFTs of x and y are averaged over each segment to compute P_{xy} , with a scaling to correct for power loss due to windowing.

If $\text{len}(x) < NFFT$ or $\text{len}(y) < NFFT$, they will be zero padded to $NFFT$.

Parameters x, y : 1-D arrays or sequences

Arrays or sequences containing the data

Fs : scalar

The sampling frequency (samples per time unit). It is used to calculate the Fourier frequencies, *freqs*, in cycles per time unit. The default value is 2.

window : callable or ndarray

A function or a vector of length $NFFT$. To create window vectors see [window_hanning\(\)](#), [window_none\(\)](#), [numpy.blackman\(\)](#), [numpy.hamming\(\)](#), [numpy.bartlett\(\)](#), [scipy.signal\(\)](#), [scipy.signal.get_window\(\)](#), etc. The default is [window_hanning\(\)](#). If a function is passed as the argument, it must take a data segment as an argument and return the windowed version of the segment.

sides : ['default' | 'onesided' | 'twosided']

Specifies which sides of the spectrum to return. Default gives the default behavior, which returns one-sided for real data and both for complex data. 'onesided' forces the return of a one-sided spectrum, while 'twosided' forces two-sided.

pad_to : integer

The number of points to which the data segment is padded when performing the FFT. This can be different from $NFFT$, which specifies the number of data points used. While not increasing the actual resolution of the spectrum (the minimum distance between resolvable peaks), this can give more points in the plot, allowing for more detail. This corresponds to the n parameter in the call to [fft\(\)](#). The default is None, which sets *pad_to* equal to $NFFT$

NFFT : integer

The number of data points used in each block for the FFT. A power 2 is most efficient. The default value is 256. This should *NOT* be used to get zero padding, or the scaling of the result will be incorrect. Use *pad_to* for this instead.

detrend : { 'default', 'constant', 'mean', 'linear', 'none' } or callable

The function applied to each segment before fft-ing, designed to remove the mean or linear trend. Unlike in MATLAB, where the *detrend* parameter is a vector, in matplotlib it is a function. The `pylab` module defines `detrend_none()`, `detrend_mean()`, and `detrend_linear()`, but you can use a custom function as well. You can also use a string to choose one of the functions. 'default', 'constant', and 'mean' call `detrend_mean()`. 'linear' calls `detrend_linear()`. 'none' calls `detrend_none()`.

scale_by_freq : boolean, optional

Specifies whether the resulting density values should be scaled by the scaling frequency, which gives density in units of Hz^{-1} . This allows for integration over the returned frequency values. The default is True for MATLAB compatibility.

noverlap : integer

The number of points of overlap between segments. The default value is 0 (no overlap).

Returns Pxy : 1-D array

The values for the cross spectrum $P_{\{xy\}}$ before scaling (real valued)

freqs : 1-D array

The frequencies corresponding to the elements in P_{xy}

See also:

`psd()` `psd()` is the equivalent to setting $y=x$.

References

Bendat & Piersol – Random Data: Analysis and Measurement Procedures, John Wiley & Sons (1986)

`matplotlib.mlab.csv2rec(fname, comments='#', skiprows=0, checkrows=0, delimiter=',',
, converterd=None, names=None, missing=',', missingd=None,
use_mrecords=False, dayfirst=False, yearfirst=False)`

Load data from comma/space/tab delimited file in *fname* into a numpy record array and return the record array.

If *names* is *None*, a header row is required to automatically assign the recarray names. The headers will be lower cased, spaces will be converted to underscores, and illegal attribute name characters removed. If *names* is not *None*, it is a sequence of names to use for the column names. In this case, it is assumed there is no header row.

- *fname*: can be a filename or a file handle. Support for gzipped files is automatic, if the filename ends in '.gz'
- *comments*: the character used to indicate the start of a comment in the file, or *None* to switch off the removal of comments
- *skiprows*: is the number of rows from the top to skip

- *checkrows*: is the number of rows to check to validate the column data type. When set to zero all rows are validated.
- *converterd*: if not *None*, is a dictionary mapping column number or munged column name to a converter function.
- *names*: if not *None*, is a list of header names. In this case, no header will be read from the file
- *missingd* is a dictionary mapping munged column names to field values which signify that the field does not contain actual data and should be masked, e.g., '0000-00-00' or 'unused'
- *missing*: a string whose value signals a missing field regardless of the column it appears in
- *use_mrecords*: if *True*, return an `mrecords.fromrecords` record array if any of the data are missing
- *dayfirst*: default is *False* so that MM-DD-YY has precedence over DD-MM-YY. See <http://labix.org/python-dateutil#head-b95ce2094d189a89f80f5ae52a05b4ab7b41af47> for further information.
- *yearfirst*: default is *False* so that MM-DD-YY has precedence over YY-MM-DD. See <http://labix.org/python-dateutil#head-b95ce2094d189a89f80f5ae52a05b4ab7b41af47> for further information.

If no rows are found, *None* is returned – see `examples/loadrec.py`

`matplotlib.mlab.csvformat_factory(format)`

`matplotlib.mlab.demean(x, axis=0)`

Return *x* minus its mean along the specified axis.

Parameters *x* : array or sequence

Array or sequence containing the data Can have any dimensionality

axis : integer

The axis along which to take the mean. See `numpy.mean` for a description of this argument.

See also:

`delinear()`

`denone()` `delinear()` and `denone()` are other detrend algorithms.

`detrend_mean()` This function is the same as `detrend_mean()` except for the default *axis*.

`matplotlib.mlab.detrend(x, key=None, axis=None)`

Return *x* with its trend removed.

Parameters *x* : array or sequence

Array or sequence containing the data.

key : ['default' | 'constant' | 'mean' | 'linear' | 'none'] or function

Specifies the detrend algorithm to use. 'default' is 'mean', which is the same as `detrend_mean()`. 'constant' is the same. 'linear' is the same as

detrend_linear(). 'none' is the same as *detrend_none()*. The default is 'mean'. See the corresponding functions for more details regarding the algorithms. Can also be a function that carries out the detrend operation.

axis : integer

The axis along which to do the detrending.

See also:

detrend_mean() *detrend_mean()* implements the 'mean' algorithm.

detrend_linear() *detrend_linear()* implements the 'linear' algorithm.

detrend_none() *detrend_none()* implements the 'none' algorithm.

matplotlib.mlab.**detrend_linear**(y)

Return x minus best fit line; 'linear' detrending.

Parameters y : 0-D or 1-D array or sequence

Array or sequence containing the data

axis : integer

The axis along which to take the mean. See numpy.mean for a description of this argument.

See also:

delinear() This function is the same as *delinear()* except for the default *axis*.

detrend_mean()

detrend_none() *detrend_mean()* and *detrend_none()* are other detrend algorithms.

detrend() *detrend()* is a wrapper around all the detrend algorithms.

matplotlib.mlab.**detrend_mean**(x, axis=None)

Return x minus the mean(x).

Parameters x : array or sequence

Array or sequence containing the data Can have any dimensionality

axis : integer

The axis along which to take the mean. See numpy.mean for a description of this argument.

See also:

demean() This function is the same as *demean()* except for the default *axis*.

detrend_linear()

detrend_none() *detrend_linear()* and *detrend_none()* are other detrend algorithms.

detrend() *detrend()* is a wrapper around all the detrend algorithms.

`matplotlib.mlab.detrend_none(x, axis=None)`

Return x: no detrending.

Parameters x : any object

An object containing the data

axis : integer

This parameter is ignored. It is included for compatibility with `detrend_mean`

See also:

denone() This function is the same as `denone()` except for the default *axis*, which has no effect.

detrend_mean()

detrend_linear() *detrend_mean()* and *detrend_linear()* are other detrend algorithms.

detrend() *detrend()* is a wrapper around all the detrend algorithms.

`matplotlib.mlab.dist(x, y)`

Return the distance between two points.

`matplotlib.mlab.dist_point_to_segment(p, s0, s1)`

Get the distance of a point to a segment.

p, s0, s1 are *xy* sequences

This algorithm from http://geomalgorithms.com/a02-_lines.html

`matplotlib.mlab.distances_along_curve(X)`

Computes the distance between a set of successive points in *N* dimensions.

Where *X* is an *M* x *N* array or matrix. The distances between successive rows is computed. Distance is the standard Euclidean distance.

`matplotlib.mlab.donothing_callback(*args)`

`matplotlib.mlab.entropy(y, bins)`

Return the entropy of the data in *y* in units of nat.

$$-\sum p_i \ln(p_i) \quad (39.2)$$

where p_i is the probability of observing *y* in the i^{th} bin of *bins*. *bins* can be a number of bins or a range of bins; see `numpy.histogram()`.

Compare *S* with analytic calculation for a Gaussian:

```
x = mu + sigma * randn(2000000)
Sanalytic = 0.5 * ( 1.0 + log(2*pi*sigma**2.0) )
```

`matplotlib.mlab.exp_safe(x)`

Compute exponentials which safely underflow to zero.

Slow, but convenient to use. Note that numpy provides proper floating point exception handling with access to the underlying hardware.

`matplotlib.mlab.fftsurr(x, detrend=<function detrend_none>, window=<function window_none>)`

Compute an FFT phase randomized surrogate of x .

`matplotlib.mlab.find(condition)`

Return the indices where `ravel(condition)` is true

`matplotlib.mlab.frange([start], stop[, step, keywords])` → array of floats

Return a numpy ndarray containing a progression of floats. Similar to `numpy.arange()`, but defaults to a closed interval.

`frange(x0, x1)` returns `[x0, x0+1, x0+2, ..., x1]`; *start* defaults to 0, and the endpoint is included. This behavior is different from that of `range()` and `numpy.arange()`. This is deliberate, since `frange()` will probably be more useful for generating lists of points for function evaluation, and endpoints are often desired in this use. The usual behavior of `range()` can be obtained by setting the keyword `closed = 0`, in this case, `frange()` basically becomes `:func:numpy.arange'`.

When *step* is given, it specifies the increment (or decrement). All arguments can be floating point numbers.

`frange(x0, x1, d)` returns `[x0, x0+d, x0+2d, ..., xfin]` where $x_{fin} \leq x1$.

`frange()` can also be called with the keyword *npts*. This sets the number of points the list should contain (and overrides the value *step* might have been given). `numpy.arange()` doesn't offer this option.

Examples:

```
>>> frange(3)
array([ 0.,  1.,  2.,  3.])
>>> frange(3,closed=0)
array([ 0.,  1.,  2.])
>>> frange(1,6,2)
array([1, 3, 5]) or 1,3,5,7, depending on floating point vagueries
>>> frange(1,6.5,npts=5)
array([ 1.    ,  2.375,  3.75  ,  5.125,  6.5   ])
```

`matplotlib.mlab.get_formatd(r, formatd=None)`

build a `formatd` guaranteed to have a key for every dtype name

`matplotlib.mlab.get_sparse_matrix(M, N, frac=0.1)`

Return a $M \times N$ sparse matrix with *frac* elements randomly filled.

`matplotlib.mlab.get_xyz_where(Z, Cond)`

Z and $Cond$ are $M \times N$ matrices. Z are data and $Cond$ is a boolean matrix where some condition is satisfied. Return value is (x, y, z) where x and y are the indices into Z and z are the values of Z at those indices. x , y , and z are 1D arrays.

`matplotlib.mlab.griddata(x, y, z, xi, yi, interp='nn')`

Interpolates from a nonuniformly spaced grid to some other grid.

Fits a surface of the form $z = f(x, y)$ to the data in the (usually) nonuniformly spaced vectors (x, y, z) , then interpolates this surface at the points specified by (xi, yi) to produce zi .

Parameters x, y, z : 1d array_like

Coordinates of grid points to interpolate from.

xi, yi : 1d or 2d array_like

Coordinates of grid points to interpolate to.

interp: string key from {'nn', 'linear'}

Interpolation algorithm, either 'nn' for natural neighbor, or 'linear' for linear interpolation.

Returns 2d float array

Array of values interpolated at (xi, yi) points. Array will be masked if any of (xi, yi) are outside the convex hull of (x, y) .

Notes

If **interp** is 'nn' (the default), uses natural neighbor interpolation based on Delaunay triangulation. This option is only available if the `mpl_toolkits.natgrid` module is installed. This can be downloaded from <https://github.com/matplotlib/natgrid>. The (xi, yi) grid must be regular and monotonically increasing in this case.

If **interp** is 'linear', linear interpolation is used via `matplotlib.tri.LinearTriInterpolator`.

Instead of using `griddata`, more flexible functionality and other interpolation options are available using a `matplotlib.tri.Triangulation` and a `matplotlib.tri.TriInterpolator`.

`matplotlib.mlab.identity(n, rank=2, dtype='l', typecode=None)`

Returns the identity matrix of shape (n, n, \dots, n) (rank r).

For ranks higher than 2, this object is simply a multi-index Kronecker delta:

```

id[i0,i1,...,iR] = -|
                  / 1 if i0=i1=...=iR,
                  \ 0 otherwise.
```

Optionally a *dtype* (or *typecode*) may be given (it defaults to 'l').

Since rank defaults to 2, this function behaves in the default case (when only n is given) like `numpy.identity(n)` – but surprisingly, it is much faster.

`matplotlib.mlab.inside_poly(points, verts)`

points is a sequence of x, y points. *verts* is a sequence of x, y vertices of a polygon.

Return value is a sequence of indices into points for the points that are inside the polygon.

`matplotlib.mlab.is_closed_polygon(X)`

Tests whether first and last object in a sequence are the same. These are presumably coordinates on a polygonal curve, in which case this function tests if that curve is closed.

`matplotlib.mlab.ispower2(n)`

Returns the log base 2 of n if n is a power of 2, zero otherwise.

Note the potential ambiguity if $n == 1$: $2^{**0} == 1$, interpret accordingly.

`matplotlib.mlab.isvector(X)`

Like the MATLAB function with the same name, returns *True* if the supplied numpy array or matrix X looks like a vector, meaning it has a one non-singleton axis (i.e., it can have multiple axes, but all must have length 1, except for one of them).

If you just want to see if the array has 1 axis, use $X.ndim == 1$.

`matplotlib.mlab.l1norm(a)`

Return the $l1$ norm of a , flattened out.

Implemented as a separate function (not a call to `norm()` for speed).

`matplotlib.mlab.l2norm(a)`

Return the $l2$ norm of a , flattened out.

Implemented as a separate function (not a call to `norm()` for speed).

`matplotlib.mlab.less_simple_linear_interpolation(x, y, xi, extrap=False)`

This function provides simple (but somewhat less so than `cbook.simple_linear_interpolation()`) linear interpolation. `simple_linear_interpolation()` will give a list of point between a start and an end, while this does true linear interpolation at an arbitrary set of points.

This is very inefficient linear interpolation meant to be used only for a small number of points in relatively non-intensive use cases. For real linear interpolation, use `scipy`.

`matplotlib.mlab.log2(x, ln2=0.6931471805599453)`

Return the $\log(x)$ in base 2.

This is a `_slow_` function but which is guaranteed to return the correct integer value if the input is an integer exact power of 2.

`matplotlib.mlab.logspace(xmin, xmax, N)`

Return N values logarithmically spaced between $xmin$ and $xmax$.

`matplotlib.mlab.longest_contiguous_ones(x)`

Return the indices of the longest stretch of contiguous ones in x , assuming x is a vector of zeros and ones. If there are two equally long stretches, pick the first.

`matplotlib.mlab.longest_ones(x)`

alias for `longest_contiguous_ones`

`matplotlib.mlab.magnitude_spectrum(x, Fs=None, window=None, pad_to=None, sides=None)`

Compute the magnitude (absolute value) of the frequency spectrum of x . Data is padded to a length of `pad_to` and the windowing function `window` is applied to the signal.

Parameters x : 1-D array or sequence

Array or sequence containing the data

Fs : scalar

The sampling frequency (samples per time unit). It is used to calculate the Fourier frequencies, *freqs*, in cycles per time unit. The default value is 2.

window : callable or ndarray

A function or a vector of length *NFFT*. To create window vectors see [window_hanning\(\)](#), [window_none\(\)](#), `numpy.blackman()`, `numpy.hamming()`, `numpy.bartlett()`, `scipy.signal()`, `scipy.signal.get_window()`, etc. The default is [window_hanning\(\)](#). If a function is passed as the argument, it must take a data segment as an argument and return the windowed version of the segment.

sides : ['default' | 'onesided' | 'twosided']

Specifies which sides of the spectrum to return. Default gives the default behavior, which returns one-sided for real data and both for complex data. 'onesided' forces the return of a one-sided spectrum, while 'twosided' forces two-sided.

pad_to : integer

The number of points to which the data segment is padded when performing the FFT. While not increasing the actual resolution of the spectrum (the minimum distance between resolvable peaks), this can give more points in the plot, allowing for more detail. This corresponds to the *n* parameter in the call to `fft()`. The default is `None`, which sets *pad_to* equal to the length of the input signal (i.e. no padding).

Returns spectrum : 1-D array

The values for the magnitude spectrum (real valued)

freqs : 1-D array

The frequencies corresponding to the elements in *spectrum*

See also:

[psd\(\)](#) *psd()* returns the power spectral density.

[complex_spectrum\(\)](#) This function returns the absolute value of [complex_spectrum\(\)](#).

[angle_spectrum\(\)](#) *angle_spectrum()* returns the angles of the corresponding frequencies.

[phase_spectrum\(\)](#) *phase_spectrum()* returns the phase (unwrapped angle) of the corresponding frequencies.

[specgram\(\)](#) *specgram()* can return the magnitude spectrum of segments within the signal.

`matplotlib.mlab.movavg(x, n)`

Compute the $\text{len}(n)$ moving average of *x*.

`matplotlib.mlab.norm_flat(a, p=2)`

`norm(a,p=2) -> l-p norm of a.flat`

Return the l-p norm of *a*, considered as a flat array. This is NOT a true matrix norm, since arrays of arbitrary rank are always flattened.

p can be a number or the string 'Infinity' to get the L-infinity norm.

`matplotlib.mlab.normpdf(x, *args)`

Return the normal pdf evaluated at *x*; args provides *mu*, *sigma*

`matplotlib.mlab.offset_line(y, yerr)`

Offsets an array *y* by +/- an error and returns a tuple (*y* - *err*, *y* + *err*).

The error term can be:

- A scalar. In this case, the returned tuple is obvious.
- A vector of the same length as *y*. The quantities *y* +/- *err* are computed component-wise.
- A tuple of length 2. In this case, *yerr*[0] is the error below *y* and *yerr*[1] is error above *y*. For example:

```
from pylab import *
x = linspace(0, 2*pi, num=100, endpoint=True)
y = sin(x)
y_minus, y_plus = mlab.offset_line(y, 0.1)
plot(x, y)
fill_between(x, ym, y2=yp)
show()
```

`matplotlib.mlab.path_length(X)`

Computes the distance travelled along a polygonal curve in *N* dimensions.

Where *X* is an *M* x *N* array or matrix. Returns an array of length *M* consisting of the distance along the curve at each point (i.e., the rows of *X*).

`matplotlib.mlab.phase_spectrum(x, Fs=None, window=None, pad_to=None, sides=None)`

Compute the phase of the frequency spectrum (unwrapped angle spectrum) of *x*. Data is padded to a length of *pad_to* and the windowing function *window* is applied to the signal.

Parameters x : 1-D array or sequence

Array or sequence containing the data

Fs : scalar

The sampling frequency (samples per time unit). It is used to calculate the Fourier frequencies, *freqs*, in cycles per time unit. The default value is 2.

window : callable or ndarray

A function or a vector of length *NFFT*. To create window vectors see `window_hanning()`, `window_none()`, `numpy.blackman()`, `numpy.hamming()`, `numpy.bartlett()`, `scipy.signal()`, `scipy.signal.get_window()`, etc. The default is `window_hanning()`. If a function is

passed as the argument, it must take a data segment as an argument and return the windowed version of the segment.

sides : ['default' | 'onesided' | 'twosided']

Specifies which sides of the spectrum to return. Default gives the default behavior, which returns one-sided for real data and both for complex data. 'onesided' forces the return of a one-sided spectrum, while 'twosided' forces two-sided.

pad_to : integer

The number of points to which the data segment is padded when performing the FFT. While not increasing the actual resolution of the spectrum (the minimum distance between resolvable peaks), this can give more points in the plot, allowing for more detail. This corresponds to the n parameter in the call to `fft()`. The default is `None`, which sets `pad_to` equal to the length of the input signal (i.e. no padding).

Returns spectrum : 1-D array

The values for the phase spectrum in radians (real valued)

freqs : 1-D array

The frequencies corresponding to the elements in `spectrum`

See also:

`complex_spectrum()` This function returns the angle value of `complex_spectrum()`.

`magnitude_spectrum()` `magnitude_spectrum()` returns the magnitudes of the corresponding frequencies.

`angle_spectrum()` `angle_spectrum()` returns the wrapped version of this function.

`specgram()` `specgram()` can return the phase spectrum of segments within the signal.

`matplotlib.mlab.poly_below(xmin, xs, ys)`

Given a sequence of `xs` and `ys`, return the vertices of a polygon that has a horizontal base at `xmin` and an upper bound at the `ys`. `xmin` is a scalar.

Intended for use with `matplotlib.axes.Axes.fill()`, e.g.:

```
xv, yv = poly_below(0, x, y)
ax.fill(xv, yv)
```

`matplotlib.mlab.poly_between(x, ylower, yupper)`

Given a sequence of `x`, `ylower` and `yupper`, return the polygon that fills the regions between them. `ylower` or `yupper` can be scalar or iterable. If they are iterable, they must be equal in length to `x`.

Return value is `x`, `y` arrays for use with `matplotlib.axes.Axes.fill()`.

`matplotlib.mlab.prctile(x, p=(0.0, 25.0, 50.0, 75.0, 100.0))`

Return the percentiles of `x`. `p` can either be a sequence of percentile values or a scalar. If `p` is a

sequence, the i th element of the return sequence is the $p^{*(i)}$ -th percentile of x . If p is a scalar, the largest value of x less than or equal to the p percentage point in the sequence is returned.

`matplotlib.mlab.prctile_rank(x, p)`

Return the rank for each element in x , return the rank $0..\text{len}(p)$. e.g., if $p = (25, 50, 75)$, the return value will be a $\text{len}(x)$ array with values in $[0,1,2,3]$ where 0 indicates the value is less than the 25th percentile, 1 indicates the value is \geq the 25th and $<$ 50th percentile, ... and 3 indicates the value is above the 75th percentile cutoff.

p is either an array of percentiles in $[0..100]$ or a scalar which indicates how many quantiles of data you want ranked.

`matplotlib.mlab.psd(x, NFFT=None, Fs=None, detrend=None, window=None, noverlap=None, pad_to=None, sides=None, scale_by_freq=None)`

Compute the power spectral density.

Call signature:

```
psd(x, NFFT=256, Fs=2, detrend=mlab.detrend_none,
    window=mlab.window_hanning, noverlap=0, pad_to=None,
    sides='default', scale_by_freq=None)
```

The power spectral density P_{xx} by Welch's average periodogram method. The vector x is divided into $NFFT$ length segments. Each segment is detrended by function *detrend* and windowed by function *window*. *noverlap* gives the length of the overlap between segments. The $|\text{fft}(i)|^2$ of each segment i are averaged to compute P_{xx} .

If $\text{len}(x) < NFFT$, it will be zero padded to $NFFT$.

Parameters x : 1-D array or sequence

Array or sequence containing the data

Fs : scalar

The sampling frequency (samples per time unit). It is used to calculate the Fourier frequencies, freqs, in cycles per time unit. The default value is 2.

window : callable or ndarray

A function or a vector of length $NFFT$. To create window vectors see [window_hanning\(\)](#), [window_none\(\)](#), `numpy.blackman()`, `numpy.hamming()`, `numpy.bartlett()`, `scipy.signal()`, `scipy.signal.get_window()`, etc. The default is [window_hanning\(\)](#). If a function is passed as the argument, it must take a data segment as an argument and return the windowed version of the segment.

sides : ['default' | 'onesided' | 'twosided']

Specifies which sides of the spectrum to return. Default gives the default behavior, which returns one-sided for real data and both for complex data. 'onesided' forces the return of a one-sided spectrum, while 'twosided' forces two-sided.

pad_to : integer

The number of points to which the data segment is padded when performing the FFT. This can be different from *NFFT*, which specifies the number of data points used. While not increasing the actual resolution of the spectrum (the minimum distance between resolvable peaks), this can give more points in the plot, allowing for more detail. This corresponds to the *n* parameter in the call to `fft()`. The default is `None`, which sets *pad_to* equal to *NFFT*

NFFT : integer

The number of data points used in each block for the FFT. A power 2 is most efficient. The default value is 256. This should *NOT* be used to get zero padding, or the scaling of the result will be incorrect. Use *pad_to* for this instead.

detrend : { 'default', 'constant', 'mean', 'linear', 'none' } or callable

The function applied to each segment before `fft`-ing, designed to remove the mean or linear trend. Unlike in MATLAB, where the *detrend* parameter is a vector, in matplotlib it is a function. The `pylab` module defines `detrend_none()`, `detrend_mean()`, and `detrend_linear()`, but you can use a custom function as well. You can also use a string to choose one of the functions. 'default', 'constant', and 'mean' call `detrend_mean()`. 'linear' calls `detrend_linear()`. 'none' calls `detrend_none()`.

scale_by_freq : boolean, optional

Specifies whether the resulting density values should be scaled by the scaling frequency, which gives density in units of Hz^{-1} . This allows for integration over the returned frequency values. The default is `True` for MATLAB compatibility.

noverlap : integer

The number of points of overlap between segments. The default value is 0 (no overlap).

Returns Pxx : 1-D array

The values for the power spectrum $P_{\{xx\}}$ (real valued)

freqs : 1-D array

The frequencies corresponding to the elements in *Pxx*

See also:

[`specgram\(\)`](#) `specgram()` differs in the default overlap; in not returning the mean of the segment periodograms; and in returning the times of the segments.

[`magnitude_spectrum\(\)`](#) `magnitude_spectrum()` returns the magnitude spectrum.

[`csd\(\)`](#) `csd()` returns the spectral density between two signals.

References

Bendat & Piersol – Random Data: Analysis and Measurement Procedures, John Wiley & Sons (1986)

`matplotlib.mlab.quad2cubic(q0x, q0y, q1x, q1y, q2x, q2y)`

Converts a quadratic Bezier curve to a cubic approximation.

The inputs are the x and y coordinates of the three control points of a quadratic curve, and the output is a tuple of x and y coordinates of the four control points of the cubic curve.

`matplotlib.mlab.rec2csv(r, fname, delimiter=',', formatd=None, missing='', missingd=None, withheader=True)`

Save the data from numpy recarray r into a comma-/space-/tab-delimited file. The record array dtype names will be used for column headers.

***fname*: can be a filename or a file handle. Support for gzipped files** is automatic, if the filename ends in `'.gz'`

***withheader*: if withheader is False, do not write the attribute names** in the first row

for `formatd` type `FormatFloat`, we override the precision to store full precision floats in the CSV file

See also:

[`csv2rec\(\)`](#) For information about *missing* and *missingd*, which can be used to fill in masked values into your CSV file.

`matplotlib.mlab.rec2txt(r, header=None, padding=3, precision=3, fields=None)`

Returns a textual representation of a record array.

Parameters r : numpy recarray

header: list

column headers

padding:

space between each column

precision: number of decimal places to use for floats.

Set to an integer to apply to all floats. Set to a list of integers to apply precision individually. Precision for non-floats is simply ignored.

fields : list

If not None, a list of field names to print. `fields` can be a list of strings like `['field1', 'field2']` or a single comma separated string like `'field1,field2'`

Examples

For `precision=[0, 2, 3]`, the output is

ID	Price	Return
ABC	12.54	0.234
XYZ	6.32	-0.076

`matplotlib.mlab.rec_append_fields(rec, names, arrs, dtypes=None)`

Return a new record array with field names populated with data from arrays in *arrs*. If appending a single field, then *names*, *arrs* and *dtypes* do not have to be lists. They can just be the values themselves.

`matplotlib.mlab.rec_drop_fields(rec, names)`

Return a new numpy record array with fields in *names* dropped.

`matplotlib.mlab.rec_groupby(r, groupby, stats)`

r is a numpy record array

groupby is a sequence of record array attribute names that together form the grouping key. e.g., ('date', 'productcode')

stats is a sequence of (*attr*, *func*, *outname*) tuples which will call `x = func(attr)` and assign *x* to the record array output with attribute *outname*. For example:

```
stats = ( ('sales', len, 'numsales'), ('sales', np.mean, 'avgsale') )
```

Return record array has *dtype* names for each attribute name in the *groupby* argument, with the associated group values, and for each *outname* name in the *stats* argument, with the associated stat summary output.

`matplotlib.mlab.rec_join(key, r1, r2, jointype='inner', defaults=None, r1postfix='1', r2postfix='2')`

Join record arrays *r1* and *r2* on *key*; *key* is a tuple of field names – if *key* is a string it is assumed to be a single attribute name. If *r1* and *r2* have equal values on all the keys in the *key* tuple, then their fields will be merged into a new record array containing the intersection of the fields of *r1* and *r2*.

r1 (also *r2*) must not have any duplicate keys.

The *jointype* keyword can be 'inner', 'outer', 'leftouter'. To do a rightouter join just reverse *r1* and *r2*.

The *defaults* keyword is a dictionary filled with {column_name:default_value} pairs.

The keywords *r1postfix* and *r2postfix* are postfixed to column names (other than keys) that are both in *r1* and *r2*.

`matplotlib.mlab.rec_keep_fields(rec, names)`

Return a new numpy record array with only fields listed in *names*

`matplotlib.mlab.rec_summarize(r, summaryfuncs)`

r is a numpy record array

summaryfuncs is a list of (*attr*, *func*, *outname*) tuples which will apply *func* to the array *r*[attr]* and assign the output to a new attribute name **outname*. The returned record array is identical to *r*, with extra arrays for each element in *summaryfuncs*.

`matplotlib.mlab.recs_join(key, name, recs, jointype='outer', missing=0.0, postfixes=None)`
Join a sequence of record arrays on single column key.

This function only joins a single column of the multiple record arrays

key is the column name that acts as a key

name is the name of the column that we want to join

recs is a list of record arrays to join

jointype is a string 'inner' or 'outer'

missing is what any missing field is replaced by

postfixes if not None, a len recs sequence of postfixes

returns a record array with columns [rowkey, name0, name1, ... namen-1]. or if postfixes [PF0, PF1, ..., PFN-1] are supplied, [rowkey, namePF0, namePF1, ... namePFN-1].

Example:

```
r = recs_join("date", "close", recs=[r0, r1], missing=0.)
```

`matplotlib.mlab.rk4(derivs, y0, t)`

Integrate 1D or ND system of ODEs using 4-th order Runge-Kutta. This is a toy implementation which may be useful if you find yourself stranded on a system w/o scipy. Otherwise use `scipy.integrate()`.

Parameters *y0*

initial state vector

t

sample times

derivs

returns the derivative of the system and has the signature `dy = derivs(yi, ti)`

Examples

A 2D system:

```
def derivs6(x, t):  
    d1 = x[0] + 2*x[1]  
    d2 = -3*x[0] + 4*x[1]  
    return (d1, d2)  
dt = 0.0005  
t = arange(0.0, 2.0, dt)  
y0 = (1, 2)  
yout = rk4(derivs6, y0, t)
```

A 1D system:

```
alpha = 2
def derivs(x,t):
    return -alpha*x + exp(-t)

y0 = 1
yout = rk4(derivs, y0, t)
```

If you have access to `scipy`, you should probably be using the `scipy.integrate` tools rather than this function.

`matplotlib.mlab.rms_flat(a)`

Return the root mean square of all the elements of *a*, flattened out.

`matplotlib.mlab.safe_isinf(x)`

`numpy.isinf()` for arbitrary types

`matplotlib.mlab.safe_isnan(x)`

`numpy.isnan()` for arbitrary types

`matplotlib.mlab.segments_intersect(s1, s2)`

Return *True* if *s1* and *s2* intersect. *s1* and *s2* are defined as:

```
s1: (x1, y1), (x2, y2)
s2: (x3, y3), (x4, y4)
```

`matplotlib.mlab.slopes(x, y)`

`slopes()` calculates the slope $y'(x)$

The slope is estimated using the slope obtained from that of a parabola through any three consecutive points.

This method should be superior to that described in the appendix of A CONSISTENTLY WELL BEHAVED METHOD OF INTERPOLATION by Russel W. Stineman (Creative Computing July 1980) in at least one aspect:

Circles for interpolation demand a known aspect ratio between *x*- and *y*-values. For many functions, however, the abscissa are given in different dimensions, so an aspect ratio is completely arbitrary.

The parabola method gives very similar results to the circle method for most regular cases but behaves much better in special cases.

Norbert Nemeč, Institute of Theoretical Physics, University of Regensburg, April 2006 Norbert.Nemeč at physik.uni-regensburg.de

(inspired by a original implementation by Halldor Bjornsson, Icelandic Meteorological Office, March 2006 halldor at vedur.is)

`matplotlib.mlab.specgram(x, NFFT=None, Fs=None, detrend=None, window=None, overlap=None, pad_to=None, sides=None, scale_by_freq=None, mode=None)`

Compute a spectrogram.

Compute and plot a spectrogram of data in *x*. Data are split into *NFFT* length segments and the spectrum of each section is computed. The windowing function *window* is applied to each segment, and the amount of overlap of each segment is specified with *noverlap*.

Parameters *x* : array_like

1-D array or sequence.

Fs : scalar

The sampling frequency (samples per time unit). It is used to calculate the Fourier frequencies, *freqs*, in cycles per time unit. The default value is 2.

window : callable or ndarray

A function or a vector of length *NFFT*. To create window vectors see [window_hanning\(\)](#), [window_none\(\)](#), `numpy.blackman()`, `numpy.hamming()`, `numpy.bartlett()`, `scipy.signal()`, `scipy.signal.get_window()`, etc. The default is [window_hanning\(\)](#). If a function is passed as the argument, it must take a data segment as an argument and return the windowed version of the segment.

sides : ['default' | 'onesided' | 'twosided']

Specifies which sides of the spectrum to return. Default gives the default behavior, which returns one-sided for real data and both for complex data. 'onesided' forces the return of a one-sided spectrum, while 'twosided' forces two-sided.

pad_to : integer

The number of points to which the data segment is padded when performing the FFT. This can be different from *NFFT*, which specifies the number of data points used. While not increasing the actual resolution of the spectrum (the minimum distance between resolvable peaks), this can give more points in the plot, allowing for more detail. This corresponds to the *n* parameter in the call to `fft()`. The default is None, which sets *pad_to* equal to *NFFT*

NFFT : integer

The number of data points used in each block for the FFT. A power 2 is most efficient. The default value is 256. This should *NOT* be used to get zero padding, or the scaling of the result will be incorrect. Use *pad_to* for this instead.

detrend : { 'default', 'constant', 'mean', 'linear', 'none' } or callable

The function applied to each segment before `fft`-ing, designed to remove the mean or linear trend. Unlike in MATLAB, where the *detrend* parameter is a vector, in matplotlib it is a function. The `pylab` module defines `detrend_none()`, `detrend_mean()`, and `detrend_linear()`, but you can use a custom function as well. You can also use a string to choose one of the functions. 'default', 'constant', and 'mean' call `detrend_mean()`. 'linear' calls `detrend_linear()`. 'none' calls `detrend_none()`.

scale_by_freq : boolean, optional

Specifies whether the resulting density values should be scaled by the scaling frequency, which gives density in units of Hz^{-1} . This allows for integration over the returned frequency values. The default is True for MATLAB compatibility.

noverlap : int, optional

The number of points of overlap between blocks. The default value is 128.

mode : str, optional

What sort of spectrum to use, default is 'psd'.

'psd' Returns the power spectral density.

'complex' Returns the complex-valued frequency spectrum.

'magnitude' Returns the magnitude spectrum.

'angle' Returns the phase spectrum without unwrapping.

'phase' Returns the phase spectrum with unwrapping.

Returns spectrum : array_like

2-D array, columns are the periodograms of successive segments.

freqs : array_like

1-D array, frequencies corresponding to the rows in *spectrum*.

t : array_like

1-D array, the times corresponding to midpoints of segments (i.e the columns in *spectrum*).

See also:

psd differs in the overlap and in the return values.

complex_spectrum similar, but with complex valued frequencies.

magnitude_spectrum similar single segment when mode is 'magnitude'.

angle_spectrum similar to single segment when mode is 'angle'.

phase_spectrum similar to single segment when mode is 'phase'.

Notes

detrend and scale_by_freq only apply when *mode* is set to 'psd'.

matplotlib.mlab.**stineman_interp**(*xi*, *x*, *y*, *yp=None*)

Given data vectors *x* and *y*, the slope vector *yp* and a new abscissa vector *xi*, the function *stineman_interp()* uses Stineman interpolation to calculate a vector *yi* corresponding to *xi*.

Here's an example that generates a coarse sine curve, then interpolates over a finer abscissa:

```
x = linspace(0,2*pi,20); y = sin(x); yp = cos(x)
xi = linspace(0,2*pi,40);
yi = stineman_interp(xi,x,y,yp);
plot(x,y,'o',xi,yi)
```

The interpolation method is described in the article **A CONSISTENTLY WELL BEHAVED METHOD OF INTERPOLATION** by Russell W. Stineman. The article appeared in the July 1980 issue of Creative Computing with a note from the editor stating that while they were:

not an academic journal but once in a while something serious and original comes in adding that this was “apparently a real solution” to a well known problem.

For `yp = None`, the routine automatically determines the slopes using the `slopes()` routine.

`x` is assumed to be sorted in increasing order.

For values `xi[j] < x[0]` or `xi[j] > x[-1]`, the routine tries an extrapolation. The relevance of the data obtained from this, of course, is questionable...

Original implementation by Halldor Bjornsson, Icelandic Meteorological Office, March 2006 halldor at vedur.is

Completely reworked and optimized for Python by Norbert Nemeč, Institute of Theoretical Physics, University of Regensburg, April 2006 Norbert.Nemeč at physik.uni-regensburg.de

`matplotlib.mlab.stride_repeat(x, n, axis=0)`

Repeat the values in an array in a memory-efficient manner. Array `x` is stacked vertically `n` times.

Warning: It is not safe to write to the output array. Multiple elements may point to the same piece of memory, so modifying one value may change others.

Parameters `x` : 1D array or sequence

Array or sequence containing the data.

n : integer

The number of time to repeat the array.

axis : integer

The axis along which the data will run.

References

[stackoverflow: Repeat NumPy array without replicating data?](#)

`matplotlib.mlab.stride_windows(x, n, overlap=None, axis=0)`

Get all windows of `x` with length `n` as a single array, using strides to avoid data duplication.

Warning: It is not safe to write to the output array. Multiple elements may point to the same piece of memory, so modifying one value may change others.

Parameters *x* : 1D array or sequence

Array or sequence containing the data.

n : integer

The number of data points in each window.

noverlap : integer

The overlap between adjacent windows. Default is 0 (no overlap)

axis : integer

The axis along which the windows will run.

References

[stackoverflow: Rolling window for 1D arrays in Numpy?](#) [stackoverflow: Using strides for an efficient moving average filter](#)

`matplotlib.mlab.vector_lengths(X, P=2.0, axis=None)`

Finds the length of a set of vectors in *n* dimensions. This is like the `numpy.norm()` function for vectors, but has the ability to work over a particular axis of the supplied array or matrix.

Computes $(\sum((x_i)^P))^{(1/P)}$ for each $\{x_i\}$ being the elements of *X* along the given axis. If *axis* is *None*, compute over all elements of *X*.

`matplotlib.mlab.window_hanning(x)`

Return *x* times the hanning window of `len(x)`.

See also:

[`window_none\(\)`](#) `window_none()` is another window algorithm.

`matplotlib.mlab.window_none(x)`

No window function; simply return *x*.

See also:

[`window_hanning\(\)`](#) `window_hanning()` is another window algorithm.

OFFSETBOX

40.1 `matplotlib.offsetbox`

The `OffsetBox` is a simple container artist. The child artists are meant to be drawn at a relative position to its parent. The `[VH]Packer`, `DrawingArea` and `TextArea` are derived from the `OffsetBox`.

The `[VH]Packer` automatically adjust the relative positions of their children, which should be instances of the `OffsetBox`. This is used to align similar artists together, e.g., in legend.

The `DrawingArea` can contain any `Artist` as a child. The `DrawingArea` has a fixed width and height. The position of children relative to the parent is fixed. The `TextArea` contains a single `Text` instance. The width and height of the `TextArea` instance is the width and height of its child text.

```
class matplotlib.offsetbox.AnchoredOffsetbox(loc,          pad=0.4,          borderpad=0.5,
                                             child=None,          prop=None,
                                             frameon=True,      bbox_to_anchor=None,
                                             bbox_transform=None, **kwargs)
```

Bases: `matplotlib.offsetbox.OffsetBox`

An offset box placed according to the legend location `loc`. `AnchoredOffsetbox` has a single child. When multiple children is needed, use other `OffsetBox` class to enclose them. By default, the offset box is anchored against its parent axes. You may explicitly specify the `bbox_to_anchor`.

`loc` is a string or an integer specifying the legend location. The valid location codes are:

```
'upper right' : 1,
'upper left'  : 2,
'lower left'  : 3,
'lower right' : 4,
'right'       : 5,
'center left' : 6,
'center right': 7,
'lower center': 8,
'upper center': 9,
'center'      : 10,
```

pad [pad around the child for drawing a frame. given in] fraction of fontsize.

borderpad : pad between offsetbox frame and the `bbox_to_anchor`,

`child` : `OffsetBox` instance that will be anchored.

`prop` : font property. This is only used as a reference for paddings.

`frameon` : draw a frame box if `True`.

`bbox_to_anchor` : `bbox` to anchor. Use `self.axes.bbox` if `None`.

`bbox_transform` : with which the `bbox_to_anchor` will be transformed.

`draw`(*renderer*)
draw the artist

`get_bbox_to_anchor`()
return the `bbox` that the legend will be anchored

`get_child`()
return the child

`get_children`()
return the list of children

`get_extent`(*renderer*)
return the extent of the artist. The extent of the child added with the pad is returned

`get_window_extent`(*renderer*)
get the bounding box in display space.

`set_bbox_to_anchor`(*bbox, transform=None*)
set the `bbox` that the child will be anchored.

bbox can be a `Bbox` instance, a list of [left, bottom, width, height], or a list of [left, bottom] where the width and height will be assumed to be zero. The `bbox` will be transformed to display coordinate by the given transform.

`set_child`(*child*)
set the child to be anchored

`update_frame`(*bbox, fontsize=None*)

`zorder = 5`

`class matplotlib.offsetbox.AnchoredText`(*s, loc, pad=0.4, borderpad=0.5, prop=None, **kwargs*)

Bases: `matplotlib.offsetbox.AnchoredOffsetbox`

AnchoredOffsetbox with Text.

Parameters *s* : string

Text.

loc : str

Location code.

pad : float, optional

Pad between the text and the frame as fraction of the font size.

borderpad : float, optional

Pad between the frame and the axes (or *bbox_to_anchor*).

prop : *matplotlib.font_manager.FontProperties*

Font properties.

Notes

Other keyword parameters of *AnchoredOffsetbox* are also allowed.

```
class matplotlib.offsetbox.AnnotationBbox(offsetbox, xy, xybox=None, xycoords='data',
                                          boxcoords=None, frameon=True, pad=0.4,
                                          annotation_clip=None, box_alignment=(0.5,
                                          0.5), bboxprops=None, arrowprops=None,
                                          fontsize=None, **kwargs)
```

Bases: *matplotlib.artist.Artist*, *matplotlib.text._AnnotationBase*

Annotation-like class, but with *offsetbox* instead of *Text*.

offsetbox : *OffsetBox* instance

xycoords [same as *Annotation* but can be a tuple of two] strings which are interpreted as x and y coordinates.

boxcoords [similar to *textcoords* as *Annotation* but can be a] tuple of two strings which are interpreted as x and y coordinates.

box_alignment [a tuple of two floats for a vertical and] horizontal alignment of the offset box w.r.t. the *boxcoords*. The lower-left corner is (0.0) and upper-right corner is (1.1).

other parameters are identical to that of *Annotation*.

anncoords

contains(*event*)

draw(*renderer*)

Draw the *Annotation* object to the given *renderer*.

get_children()

get_fontsize(*s=None*)

return *fontsize* in points

set_figure(*fig*)

set_fontsize(*s=None*)

set *fontsize* in points

update_positions(*renderer*)

Update the pixel positions of the annotated point and the text.

xyann

zorder = 3

class matplotlib.offsetbox.**AuxTransformBox**(*aux_transform*)

Bases: *matplotlib.offsetbox.OffsetBox*

Offset Box with the *aux_transform* . Its children will be transformed with the *aux_transform* first then will be offseted. The absolute coordinate of the *aux_transform* is meaning as it will be automatically adjust so that the left-lower corner of the bounding box of children will be set to (0,0) before the offset transform.

It is similar to drawing area, except that the extent of the box is not predetermined but calculated from the window extent of its children. Furthermore, the extent of the children will be calculated in the transformed coordinate.

add_artist(*a*)

Add any *Artist* to the container box

draw(*renderer*)

Draw the children

get_extent(*renderer*)

get_offset()

return offset of the container.

get_transform()

Return the *Transform* applied to the children

get_window_extent(*renderer*)

get the bounding box in display space.

set_offset(*xy*)

set offset of the container.

Accept : tuple of x,y coordinate in display units.

set_transform(*t*)

set_transform is ignored.

class matplotlib.offsetbox.**DraggableAnnotation**(*annotation, use_blit=False*)

Bases: *matplotlib.offsetbox.DraggableBase*

save_offset()

update_offset(*dx, dy*)

```
class matplotlib.offsetbox.DraggableBase(ref_artist, use_blit=False)
```

```
    Bases: object
```

helper code for a draggable artist (legend, offsetbox) The derived class must override following two method.

```
    def saveoffset(self): pass
```

```
    def update_offset(self, dx, dy): pass
```

saveoffset is called when the object is picked for dragging and it is meant to save reference position of the artist.

update_offset is called during the dragging. **dx** and **dy** is the **pixel** offset from the point where the mouse drag started.

Optionally you may override following two methods.

```
    def artist_picker(self, artist, evt): return self.ref_artist.contains(evt)
```

```
    def finalize_offset(self): pass
```

artist_picker is a picker method that will be used. *finalize_offset* is called when the mouse is released. In current implementaion of *DraggableLegend* and *DraggableAnnotation*, *update_offset* places the artists simply in display coordinates. And *finalize_offset* recalculate their position in the normalized axes coordinate and set a relavant attribute.

```
    artist_picker(artist, evt)
```

```
    disconnect()
```

```
        disconnect the callbacks
```

```
    finalize_offset()
```

```
    on_motion(evt)
```

```
    on_motion_blit(evt)
```

```
    on_pick(evt)
```

```
    on_release(event)
```

```
    save_offset()
```

```
    update_offset(dx, dy)
```

```
class matplotlib.offsetbox.DraggableOffsetBox(ref_artist, offsetbox, use_blit=False)
```

```
    Bases: matplotlib.offsetbox.DraggableBase
```

`get_loc_in_canvas()`

`save_offset()`

`update_offset(dx, dy)`

`class matplotlib.offsetbox.DrawingArea`(*width*, *height*, *xdescent*=0.0, *ydescent*=0.0,
clip=False)

Bases: `matplotlib.offsetbox.OffsetBox`

The `DrawingArea` can contain any `Artist` as a child. The `DrawingArea` has a fixed width and height. The position of children relative to the parent is fixed. The children can be clipped at the boundaries of the parent.

width, *height* : width and height of the container box. *xdescent*, *ydescent* : descent of the box in x- and y-direction. *clip* : Whether to clip the children

`add_artist(a)`

Add any `Artist` to the container box

`clip_children`

If the children of this `DrawingArea` should be clipped by `DrawingArea` bounding box.

`draw(renderer)`

Draw the children

`get_extent(renderer)`

Return with, height, xdescent, ydescent of box

`get_offset()`

return offset of the container.

`get_transform()`

Return the `Transform` applied to the children

`get_window_extent(renderer)`

get the bounding box in display space.

`set_offset(xy)`

set offset of the container.

Accept : tuple of x,y coordinate in display units.

`set_transform(t)`

set_transform is ignored.

`class matplotlib.offsetbox.HPacker`(*pad*=None, *sep*=None, *width*=None, *height*=None,
align='baseline', *mode*='fixed', *children*=None)

Bases: `matplotlib.offsetbox.PackerBase`

The `HPacker` has its children packed horizontally. It automatically adjusts the relative positions of children at draw time.

Parameters pad : float, optional

Boundary pad.

sep : float, optional

Spacing between items.

width : float, optional

height : float, optional

Width and height of the container box, calculated if None.

align : str

Alignment of boxes.

mode : str

Packing mode.

Notes

pad and *sep* need to be given in points and will be scaled with the renderer dpi, while *width* and *height* need to be in pixels.

get_extent_offsets(*renderer*)

update offset of children and return the extents of the box

class `matplotlib.offsetbox.OffsetBox`(*args, **kwargs)

Bases: `matplotlib.artist.Artist`

The `OffsetBox` is a simple container artist. The child artists are meant to be drawn at a relative position to its parent.

axes

The `Axes` instance the artist resides in, or `None`.

contains(*mouseevent*)

draw(*renderer*)

Update the location of children if necessary and draw them to the given *renderer*.

get_children()

Return a list of artists it contains.

get_extent(*renderer*)

Return width, height, xdescent, ydescent of box

get_extent_offsets(*renderer*)

get_offset(*width*, *height*, *xdescent*, *ydescent*, *renderer*)

Get the offset

accepts extent of the box

get_visible_children()

Return a list of visible artists it contains.

get_window_extent(*renderer*)

get the bounding box in display space.

set_figure(*fig*)

Set the figure

accepts a class:*Figure* instance

set_height(*height*)

Set the height

accepts float

set_offset(*xy*)

Set the offset

accepts x, y, tuple, or a callable object.

set_width(*width*)

Set the width

accepts float

class matplotlib.offsetbox.OffsetImage(*arr*, *zoom=1*, *cmap=None*, *norm=None*, *interpolation=None*, *origin=None*, *filternorm=1*, *filterrad=4.0*, *resample=False*, *dpi_cor=True*, ***kwargs*)

Bases: *matplotlib.offsetbox.OffsetBox*

draw(*renderer*)

Draw the children

get_children()

get_data()

get_extent(*renderer*)

get_offset()

return offset of the container.

get_window_extent(*renderer*)

get the bounding box in display space.

get_zoom()

set_data(*arr*)

set_zoom(*zoom*)

class matplotlib.offsetbox.**PackerBase**(*pad=None, sep=None, width=None, height=None, align=None, mode=None, children=None*)

Bases: *matplotlib.offsetbox.OffsetBox*

Parameters **pad** : float, optional

Boundary pad.

sep : float, optional

Spacing between items.

width : float, optional

height : float, optional

Width and height of the container box, calculated if *None*.

align : str, optional

Alignment of boxes. Can be one of *top*, *bottom*, *left*, *right*, *center* and *baseline*

mode : str, optional

Packing mode.

Notes

pad and *sep* need to be given in points and will be scaled with the renderer dpi, while *width* and *height* need to be in pixels.

class matplotlib.offsetbox.**PaddedBox**(*child, pad=None, draw_frame=False, patch_attrs=None*)

Bases: *matplotlib.offsetbox.OffsetBox*

pad : boundary pad

Note: *pad* need to be given in points and will be scaled with the renderer dpi, while *width* and *height* need to be in pixels.

draw(*renderer*)

Update the location of children if necessary and draw them to the given *renderer*.

draw_frame(*renderer*)

get_extent_offsets(*renderer*)

update offset of childrens and return the extents of the box

update_frame(*bbox, fontsize=None*)

class matplotlib.offsetbox.**TextArea**(*s*, *textprops=None*, *multilinebaseline=None*, *minimumdescent=True*)
Bases: [matplotlib.offsetbox.OffsetBox](#)

The TextArea contains a single Text instance. The text is placed at (0,0) with baseline+left alignment. The width and height of the TextArea instance is the width and height of its child text.

Parameters *s* : str

a string to be displayed.

textprops : [FontProperties](#), optional

multilinebaseline : bool, optional

If True, baseline for multiline text is adjusted so that it is (approximately) center-aligned with singleline text.

minimumdescent : bool, optional

If True, the box has a minimum descent of “p”.

draw(*renderer*)

Draw the children

get_extent(*renderer*)

get_minimumdescent()

get minimumdescent.

get_multilinebaseline()

get multilinebaseline .

get_offset()

return offset of the container.

get_text()

Returns the string representation of this area’s text

get_window_extent(*renderer*)

get the bounding box in display space.

set_minimumdescent(*t*)

Set minimumdescent .

If True, extent of the single line text is adjusted so that it has minimum descent of “p”

set_multilinebaseline(*t*)

Set multilinebaseline .

If True, baseline for multiline text is adjusted so that it is (approximately) center-aligned with singleline text.

set_offset(*xy*)

set offset of the container.

Accept : tuple of x,y coordinates in display units.

set_text(*s*)

Set the text of this area as a string.

set_transform(*t*)

set_transform is ignored.

class matplotlib.offsetbox.VPacker(*pad=None, sep=None, width=None, height=None, align='baseline', mode='fixed', children=None*)

Bases: *matplotlib.offsetbox.PackerBase*

The VPacker has its children packed vertically. It automatically adjust the relative positions of children in the drawing time.

Parameters **pad** : float, optional

Boundary pad.

sep : float, optional

Spacing between items.

width : float, optional

height : float, optional

width and height of the container box, calculated if None.

align : str, optional

Alignment of boxes.

mode : str, optional

Packing mode.

Notes

pad and *sep* need to given in points and will be scale with the renderer dpi, while *width* and *height* need to be in pixels.

get_extent_offsets(*renderer*)

update offset of childrens and return the extents of the box

matplotlib.offsetbox.bbox_artist(**args, **kwargs*)

41.1 matplotlib.patches

`class matplotlib.patches.Arc(xy, width, height, angle=0.0, theta1=0.0, theta2=360.0, **kwargs)`

Bases: `matplotlib.patches.Ellipse`

An elliptical arc. Because it performs various optimizations, it can not be filled.

The arc must be used in an `Axes` instance—it can not be added directly to a `Figure`—because it is optimized to only render the segments that are inside the axes bounding box with high resolution.

The following args are supported:

xy center of ellipse

width length of horizontal axis

height length of vertical axis

angle rotation in degrees (anti-clockwise)

theta1 starting angle of the arc in degrees

theta2 ending angle of the arc in degrees

If `theta1` and `theta2` are not provided, the arc will form a complete ellipse.

Valid kwargs are:

Property	Description
<code>agg_filter</code>	unknown
<code>alpha</code>	float or None
<code>animated</code>	[True False]
<code>antialiased</code> or <code>aa</code>	[True False] or None for default
<code>axes</code>	an <code>Axes</code> instance
<code>capstyle</code>	['butt' 'round' 'projecting']
<code>clip_box</code>	a <code>matplotlib.transforms.Bbox</code> instance
<code>clip_on</code>	[True False]
<code>clip_path</code>	[(<code>Path</code> , <code>Transform</code>) <code>Patch</code> None]

Continued on

Table 41.1 – continued from previous page

Property	Description
<i>color</i>	matplotlib color spec
<i>contains</i>	a callable function
<i>edgecolor</i> or <i>ec</i>	mpl color spec, None, ‘none’, or ‘auto’
<i>facecolor</i> or <i>fc</i>	mpl color spec, or None for default, or ‘none’ for no color
<i>figure</i>	a <i>matplotlib.figure.Figure</i> instance
<i>fill</i>	[True False]
<i>gid</i>	an id string
<i>hatch</i>	[‘/’ ‘\’ ‘ ’ ‘-’ ‘+’ ‘x’ ‘o’ ‘O’ ‘.’ ‘*’]
<i>joinstyle</i>	[‘miter’ ‘round’ ‘bevel’]
<i>label</i>	string or anything printable with ‘%s’ conversion.
<i>linestyle</i> or <i>ls</i>	[‘solid’ ‘dashed’, ‘dashdot’, ‘dotted’ (offset, on-off-dash-seq) ‘-’ ‘--’ ‘-.’ ‘:’ ‘None’]
<i>linewidth</i> or <i>lw</i>	float or None for default
<i>path_effects</i>	unknown
<i>picker</i>	[None float boolean callable]
<i>rasterized</i>	[True False None]
<i>sketch_params</i>	unknown
<i>snap</i>	unknown
<i>transform</i>	<i>Transform</i> instance
<i>url</i>	a url string
<i>visible</i>	[True False]
<i>zorder</i>	any number

draw(*artist*, *renderer*, **args*, ***kwargs*)

Ellipses are normally drawn using an approximation that uses eight cubic bezier splines. The error of this approximation is 1.89818e-6, according to this unverified source:

Lancaster, Don. Approximating a Circle or an Ellipse Using Four Bezier Cubic Splines.

<http://www.tinaja.com/glib/ellipse4.pdf>

There is a use case where very large ellipses must be drawn with very high accuracy, and it is too expensive to render the entire ellipse with enough segments (either splines or line segments). Therefore, in the case where either radius of the ellipse is large enough that the error of the spline approximation will be visible (greater than one pixel offset from the ideal), a different technique is used.

In that case, only the visible parts of the ellipse are drawn, with each visible arc using a fixed number of spline segments (8). The algorithm proceeds as follows:

1. The points where the ellipse intersects the axes bounding box are located. (This is done by performing an inverse transformation on the axes bbox such that it is relative to the unit circle – this makes the intersection calculation much easier than doing rotated ellipse intersection directly).

This uses the “line intersecting a circle” algorithm from:

Vince, John. Geometry for Computer Graphics: Formulae, Examples & Proofs.
London: Springer-Verlag, 2005.

2.The angles of each of the intersection points are calculated.

3.Proceeding counterclockwise starting in the positive x-direction, each of the visible arc-segments between the pairs of vertices are drawn using the bezier arc approximation technique implemented in `matplotlib.path.Path.arc()`.

class `matplotlib.patches.Arrow`(*x, y, dx, dy, width=1.0, **kwargs*)

Bases: `matplotlib.patches.Patch`

An arrow patch.

Draws an arrow, starting at (*x, y*), direction and length given by (*dx, dy*) the width of the arrow is scaled by *width*.

Valid kwargs are:

Property	Description
<code>agg_filter</code>	unknown
<code>alpha</code>	float or None
<code>animated</code>	[True False]
<code>antialiased</code> or <code>aa</code>	[True False] or None for default
<code>axes</code>	an <code>Axes</code> instance
<code>capstyle</code>	['butt' 'round' 'projecting']
<code>clip_box</code>	a <code>matplotlib.transforms.Bbox</code> instance
<code>clip_on</code>	[True False]
<code>clip_path</code>	[(<code>Path, Transform</code>) <code>Patch</code> None]
<code>color</code>	matplotlib color spec
<code>contains</code>	a callable function
<code>edgecolor</code> or <code>ec</code>	mpl color spec, None, 'none', or 'auto'
<code>facecolor</code> or <code>fc</code>	mpl color spec, or None for default, or 'none' for no color
<code>figure</code>	a <code>matplotlib.figure.Figure</code> instance
<code>fill</code>	[True False]
<code>gid</code>	an id string
<code>hatch</code>	['/' '\' ' ' '-' '+' 'x' 'o' 'O' '.' '*']
<code>joinstyle</code>	['miter' 'round' 'bevel']
<code>label</code>	string or anything printable with '%s' conversion.
<code>linestyle</code> or <code>ls</code>	['solid' 'dashed', 'dashdot', 'dotted' (offset, on-off-dash-seq) '-' '--' '-.' ':' 'None']
<code>linewidth</code> or <code>lw</code>	float or None for default
<code>path_effects</code>	unknown
<code>picker</code>	[None float boolean callable]
<code>rasterized</code>	[True False None]
<code>sketch_params</code>	unknown
<code>snap</code>	unknown
<code>transform</code>	<code>Transform</code> instance
<code>url</code>	a url string
<code>visible</code>	[True False]

Continued on

Table 41.2 – continued from previous page

Property	Description
<i>zorder</i>	any number

`get_patch_transform()`

`get_path()`

class matplotlib.patches.ArrowStyle

Bases: matplotlib.patches._Style

ArrowStyle is a container class which defines several arrowstyle classes, which is used to create an arrow path along a given path. These are mainly used with *FancyArrowPatch*.

A arrowstyle object can be either created as:

```
ArrowStyle.Fancy(head_length=.4, head_width=.4, tail_width=.4)
```

or:

```
ArrowStyle("Fancy", head_length=.4, head_width=.4, tail_width=.4)
```

or:

```
ArrowStyle("Fancy, head_length=.4, head_width=.4, tail_width=.4")
```

The following classes are defined

Class	Name	Attrs
Curve	-	None
CurveB	->	head_length=0.4,head_width=0.2
BracketB	-[widthB=1.0,lengthB=0.2,angleB=None
Curve-FilledB	- >	head_length=0.4,head_width=0.2
CurveA	<-	head_length=0.4,head_width=0.2
CurveAB	<->	head_length=0.4,head_width=0.2
Curve-FilledA	< -	head_length=0.4,head_width=0.2
Curve-FilledAB	< - >	head_length=0.4,head_width=0.2
BracketA] -	widthA=1.0,lengthA=0.2,angleA=None
BracketAB] -[widthA=1.0,lengthA=0.2,angleA=None,widthB=1.0,lengthB=0.2,angleB=None
Fancy	fancy	head_length=0.4,head_width=0.4,tail_width=0.4
Simple	simple	head_length=0.5,head_width=0.5,tail_width=0.2
Wedge	wedge	tail_width=0.3,shrink_factor=0.5
BarAB	-	widthA=1.0,angleA=None,widthB=1.0,angleB=None

An instance of any arrow style class is a callable object, whose call signature is:

```
__call__(self, path, mutation_size, linewidth, aspect_ratio=1.)
```

and it returns a tuple of a `Path` instance and a boolean value. `path` is a `Path` instance along which the arrow will be drawn. `mutation_size` and `aspect_ratio` have the same meaning as in `BoxStyle`. `linewidth` is a line width to be stroked. This is meant to be used to correct the location of the head so that it does not overshoot the destination point, but not all classes support it.

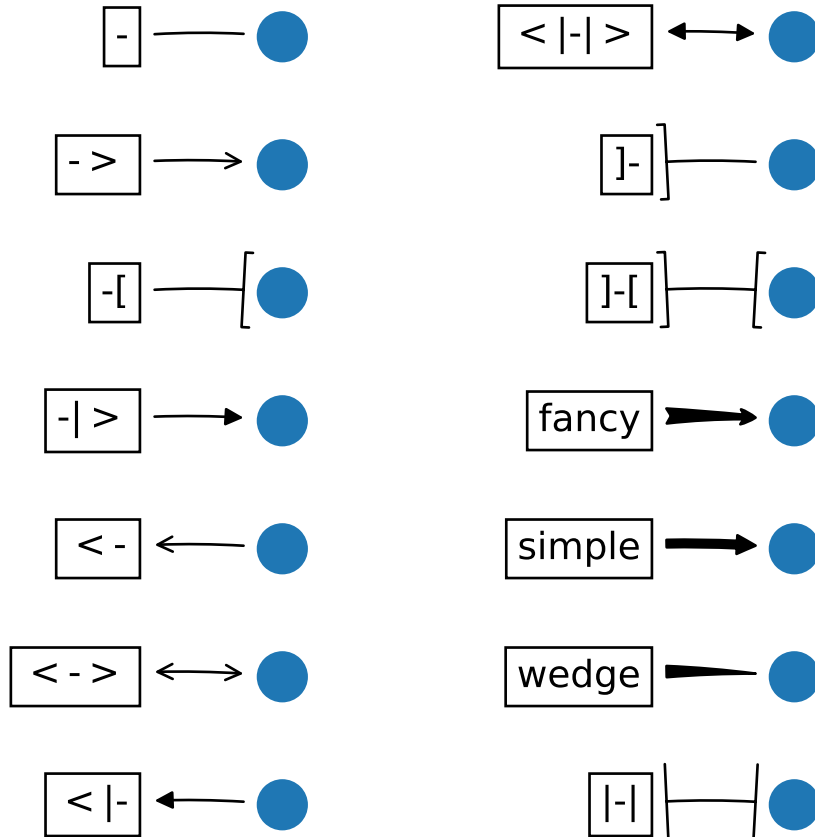

return the instance of the subclass with the given style name.

```
class BarAB(widthA=1.0, angleA=None, widthB=1.0, angleB=None)
```

Bases: `matplotlib.patches._Bracket`

An arrow with a bar() at both ends.

Parameters `widthA` : float, optional, default

Width of the bracket

angleA : float, optional, default

Angle between the bracket and the line

widthB : float, optional, default

Width of the bracket

angleB : float, optional, default

Angle between the bracket and the line

class BracketA(*widthA=1.0, lengthA=0.2, angleA=None*)

Bases: `matplotlib.patches._Bracket`

An arrow with a `bracket()` at its end.

Parameters widthA : float, optional, default

Width of the bracket

lengthA : float, optional, default

Length of the bracket

angleA : float, optional, default

Angle between the bracket and the line

class BracketAB(*widthA=1.0, lengthA=0.2, angleA=None, widthB=1.0, lengthB=0.2, angleB=None*)

Bases: `matplotlib.patches._Bracket`

An arrow with a `bracket()` at both ends.

Parameters widthA : float, optional, default

Width of the bracket

lengthA : float, optional, default

Length of the bracket

angleA : float, optional, default

Angle between the bracket and the line

widthB : float, optional, default

Width of the bracket

lengthB : float, optional, default

Length of the bracket

angleB : float, optional, default

Angle between the bracket and the line

class BracketB(*widthB=1.0, lengthB=0.2, angleB=None*)

Bases: `matplotlib.patches._Bracket`

An arrow with a `bracket()` at its end.

Parameters widthB : float, optional, default

Width of the bracket

lengthB : float, optional, default

Length of the bracket

angleB : float, optional, default

Angle between the bracket and the line

class Curve

Bases: `matplotlib.patches._Curve`

A simple curve without any arrow head.

class CurveA(*head_length=0.4, head_width=0.2*)

Bases: `matplotlib.patches._Curve`

An arrow with a head at its begin point.

Parameters head_length : float, optional, default

Length of the arrow head

head_width : float, optional, default

Width of the arrow head

class CurveAB(*head_length=0.4, head_width=0.2*)

Bases: `matplotlib.patches._Curve`

An arrow with heads both at the begin and the end point.

Parameters head_length : float, optional, default

Length of the arrow head

head_width : float, optional, default

Width of the arrow head

class CurveB(*head_length=0.4, head_width=0.2*)

Bases: `matplotlib.patches._Curve`

An arrow with a head at its end point.

Parameters head_length : float, optional, default

Length of the arrow head

head_width : float, optional, default

Width of the arrow head

class CurveFilledA(*head_length=0.4, head_width=0.2*)

Bases: `matplotlib.patches._Curve`

An arrow with filled triangle head at the begin.

Parameters head_length : float, optional, default

Length of the arrow head

head_width : float, optional, default

Width of the arrow head

class CurveFilledAB(*head_length=0.4, head_width=0.2*)

Bases: `matplotlib.patches._Curve`

An arrow with filled triangle heads at both ends.

Parameters head_length : float, optional, default

Length of the arrow head

head_width : float, optional, default

Width of the arrow head

class CurveFilledB(*head_length=0.4, head_width=0.2*)

Bases: `matplotlib.patches._Curve`

An arrow with filled triangle head at the end.

Parameters head_length : float, optional, default

Length of the arrow head

head_width : float, optional, default

Width of the arrow head

class Fancy(*head_length=0.4, head_width=0.4, tail_width=0.4*)

Bases: `matplotlib.patches._Base`

A fancy arrow. Only works with a quadratic bezier curve.

Parameters head_length : float, optional, default

Length of the arrow head

head_width : float, optional, default

Width of the arrow head

tail_width : float, optional, default

Width of the arrow tail

transmute(*path, mutation_size, linewidth*)

class Simple(*head_length=0.5, head_width=0.5, tail_width=0.2*)

Bases: `matplotlib.patches._Base`

A simple arrow. Only works with a quadratic bezier curve.

Parameters head_length : float, optional, default

Length of the arrow head

head_width : float, optional, default

Width of the arrow head

tail_width : float, optional, default

Width of the arrow tail

transmute(*path, mutation_size, linewidth*)

class Wedge(*tail_width=0.3, shrink_factor=0.5*)

Bases: `matplotlib.patches._Base`

Wedge(?) shape. Only works with a quadratic bezier curve. The begin point has a width of the `tail_width` and the end point has a width of 0. At the middle, the width is `shrink_factor*tail_width`.

Parameters `tail_width` : float, optional, default

Width of the tail

shrink_factor : float, optional, default

Fraction of the arrow width at the middle point

transmute(*path, mutation_size, linewidth*)

class `matplotlib.patches.BoxStyle`

Bases: `matplotlib.patches._Style`

BoxStyle is a container class which defines several boxstyle classes, which are used for *FancyBboxPatch*.

A style object can be created as:

```
BoxStyle.Round(pad=0.2)
```

or:

```
BoxStyle("Round", pad=0.2)
```

or:

```
BoxStyle("Round, pad=0.2")
```

Following boxstyle classes are defined.

Class	Name	Attrs
Circle	<code>circle</code>	<code>pad=0.3</code>
DArrow	<code>darrow</code>	<code>pad=0.3</code>
LArrow	<code>larrow</code>	<code>pad=0.3</code>
RArrow	<code>rarrow</code>	<code>pad=0.3</code>
Round	<code>round</code>	<code>pad=0.3,rounding_size=None</code>
Round4	<code>round4</code>	<code>pad=0.3,rounding_size=None</code>
Roundtooth	<code>roundtooth</code>	<code>pad=0.3,tooth_size=None</code>
Sawtooth	<code>sawtooth</code>	<code>pad=0.3,tooth_size=None</code>
Square	<code>square</code>	<code>pad=0.3</code>

An instance of any boxstyle class is an callable object, whose call signature is:

```
__call__(self, x0, y0, width, height, mutation_size, aspect_ratio=1.)
```

and returns a Path instance. *x0*, *y0*, *width* and *height* specify the location and size of the box to be drawn. *mutation_scale* determines the overall size of the mutation (by which I mean the transformation of the rectangle to the fancy box). *mutation_aspect* determines the aspect-ratio of the mutation.

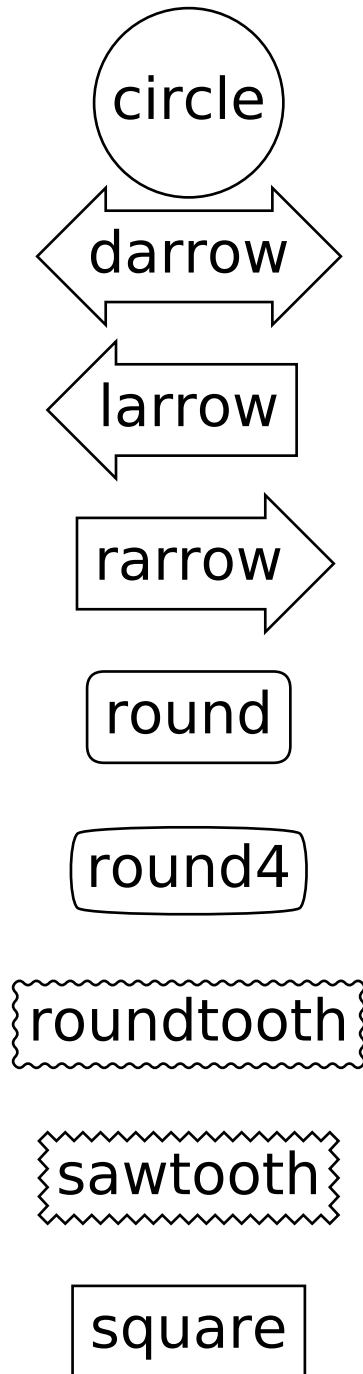

return the instance of the subclass with the given style name.

class Circle(*pad=0.3*)

Bases: `matplotlib.patches._Base`

A simple circle box.

Parameters *pad* : float

The amount of padding around the original box.

transmute(*x0, y0, width, height, mutation_size*)

class DArrow(*pad=0.3*)

Bases: `matplotlib.patches._Base`

(Double) Arrow Box

transmute(*x0, y0, width, height, mutation_size*)

class LArrow(*pad=0.3*)

Bases: `matplotlib.patches._Base`

(left) Arrow Box

transmute(*x0, y0, width, height, mutation_size*)

class RArrow(*pad=0.3*)

Bases: `matplotlib.patches.LArrow`

(right) Arrow Box

transmute(*x0, y0, width, height, mutation_size*)

class Round(*pad=0.3, rounding_size=None*)

Bases: `matplotlib.patches._Base`

A box with round corners.

pad amount of padding

rounding_size rounding radius of corners. *pad* if None

transmute(*x0, y0, width, height, mutation_size*)

class Round4(*pad=0.3, rounding_size=None*)

Bases: `matplotlib.patches._Base`

Another box with round edges.

pad amount of padding

rounding_size rounding size of edges. *pad* if None

transmute(*x0, y0, width, height, mutation_size*)

class Roundtooth(*pad=0.3, tooth_size=None*)
 Bases: `matplotlib.patches.Sawtooth`
 A rounded tooth box.
pad amount of padding
tooth_size size of the sawtooth. *pad** if None
transmute(*x0, y0, width, height, mutation_size*)

class Sawtooth(*pad=0.3, tooth_size=None*)
 Bases: `matplotlib.patches._Base`
 A sawtooth box.
pad amount of padding
tooth_size size of the sawtooth. *pad** if None
transmute(*x0, y0, width, height, mutation_size*)

class Square(*pad=0.3*)
 Bases: `matplotlib.patches._Base`
 A simple square box.
pad amount of padding
transmute(*x0, y0, width, height, mutation_size*)

class matplotlib.patches.Circle(*xy, radius=5, **kwargs*)
 Bases: `matplotlib.patches.Ellipse`

A circle patch.

Create true circle at center $xy = (x, y)$ with given *radius*. Unlike `CirclePolygon` which is a polygonal approximation, this uses Bézier splines and is much closer to a scale-free circle.

Valid kwargs are:

Property	Description
<i>agg_filter</i>	unknown
<i>alpha</i>	float or None
<i>animated</i>	[True False]
<i>antialiased</i> or <i>aa</i>	[True False] or None for default
<i>axes</i>	an <code>Axes</code> instance
<i>capstyle</i>	['butt' 'round' 'projecting']
<i>clip_box</i>	a <code>matplotlib.transforms.Bbox</code> instance
<i>clip_on</i>	[True False]
<i>clip_path</i>	[(<code>Path</code> , <code>Transform</code>) <code>Patch</code> None]
<i>color</i>	matplotlib color spec

Continued on

Table 41.3 – continued from previous page

Property	Description
<i>contains</i>	a callable function
<i>edgecolor</i> or <i>ec</i>	mpl color spec, None, ‘none’, or ‘auto’
<i>facecolor</i> or <i>fc</i>	mpl color spec, or None for default, or ‘none’ for no color
<i>figure</i>	a <i>matplotlib.figure.Figure</i> instance
<i>fill</i>	[True False]
<i>gid</i>	an id string
<i>hatch</i>	['/' '\ ' ' ' '- ' '+ ' 'x' 'o' 'O' ':' '*']
<i>joinstyle</i>	['miter' 'round' 'bevel']
<i>label</i>	string or anything printable with ‘%s’ conversion.
<i>linestyle</i> or <i>ls</i>	['solid' 'dashed', 'dashdot', 'dotted' (offset, on-off-dash-seq) '- ' '-- ' '- .' ':' 'None']
<i>linewidth</i> or <i>lw</i>	float or None for default
<i>path_effects</i>	unknown
<i>picker</i>	[None float boolean callable]
<i>rasterized</i>	[True False None]
<i>sketch_params</i>	unknown
<i>snap</i>	unknown
<i>transform</i>	<i>Transform</i> instance
<i>url</i>	a url string
<i>visible</i>	[True False]
<i>zorder</i>	any number

get_radius()

return the radius of the circle

radius

return the radius of the circle

set_radius(radius)

Set the radius of the circle

ACCEPTS: float

class matplotlib.patches.CirclePolygon(xy, radius=5, resolution=20, **kwargs)

Bases: *matplotlib.patches.RegularPolygon*

A polygon-approximation of a circle patch.

Create a circle at $xy = (x, y)$ with given *radius*. This circle is approximated by a regular polygon with *resolution* sides. For a smoother circle drawn with splines, see *Circle*.

Valid kwargs are:

Property	Description
<i>agg_filter</i>	unknown
<i>alpha</i>	float or None

Continued on

Table 41.4 – continued from previous page

Property	Description
<i>animated</i>	[True False]
<i>antialiased</i> or <i>aa</i>	[True False] or None for default
<i>axes</i>	an <i>Axes</i> instance
<i>capstyle</i>	['butt' 'round' 'projecting']
<i>clip_box</i>	a <i>matplotlib.transforms.Bbox</i> instance
<i>clip_on</i>	[True False]
<i>clip_path</i>	[(<i>Path</i> , <i>Transform</i>) <i>Patch</i> None]
<i>color</i>	matplotlib color spec
<i>contains</i>	a callable function
<i>edgecolor</i> or <i>ec</i>	mpl color spec, None, 'none', or 'auto'
<i>facecolor</i> or <i>fc</i>	mpl color spec, or None for default, or 'none' for no color
<i>figure</i>	a <i>matplotlib.figure.Figure</i> instance
<i>fill</i>	[True False]
<i>gid</i>	an id string
<i>hatch</i>	['/' '\' ' ' '-' '+' 'x' 'o' 'O' '.' '*']
<i>joinstyle</i>	['miter' 'round' 'bevel']
<i>label</i>	string or anything printable with '%s' conversion.
<i>linestyle</i> or <i>ls</i>	['solid' 'dashed', 'dashdot', 'dotted' (offset, on-off-dash-seq) '-' '--' '-.' ':' 'None']
<i>linewidth</i> or <i>lw</i>	float or None for default
<i>path_effects</i>	unknown
<i>picker</i>	[None float boolean callable]
<i>rasterized</i>	[True False None]
<i>sketch_params</i>	unknown
<i>snap</i>	unknown
<i>transform</i>	<i>Transform</i> instance
<i>url</i>	a url string
<i>visible</i>	[True False]
<i>zorder</i>	any number

```
class matplotlib.patches.ConnectionPatch(xyA, xyB, coordsA, coordsB=None, axesA=None, axesB=None, arrowstyle='-', arrow_transmuter=None, connectionstyle='arc3', connector=None, patchA=None, patchB=None, shrinkA=0.0, shrinkB=0.0, mutation_scale=10.0, mutation_aspect=None, clip_on=False, dpi_cor=1.0, **kwargs)
```

Bases: *matplotlib.patches.FancyArrowPatch*

A *ConnectionPatch* class is to make connecting lines between two points (possibly in different axes).

Connect point *xyA* in *coordsA* with point *xyB* in *coordsB*

Valid keys are

Key	Description
arrowstyle	the arrow style
connectionstyle	the connection style
relpos	default is (0.5, 0.5)
patchA	default is bounding box of the text
patchB	default is None
shrinkA	default is 2 points
shrinkB	default is 2 points
mutation_scale	default is text size (in points)
mutation_aspect	default is 1.
?	any key for <code>matplotlib.patches.PathPatch</code>

`coordsA` and `coordsB` are strings that indicate the coordinates of `xyA` and `xyB`.

Property	Description
'figure points'	points from the lower left corner of the figure
'figure pixels'	pixels from the lower left corner of the figure
'figure fraction'	0,0 is lower left of figure and 1,1 is upper, right
'axes points'	points from lower left corner of axes
'axes pixels'	pixels from lower left corner of axes
'axes fraction'	0,1 is lower left of axes and 1,1 is upper right
'data'	use the coordinate system of the object being annotated (default)
'offset points'	Specify an offset (in points) from the <code>xy</code> value
'polar'	you can specify <i>theta</i> , <i>r</i> for the annotation, even in cartesian plots. Note that if you are using a polar axes, you do not need to specify polar for the coordinate system since that is the native "data" coordinate system.

draw(*renderer*)

Draw.

get_annotation_clip()

Return `annotation_clip` attribute. See `set_annotation_clip()` for the meaning of return values.

get_path_in_displaycoord()

Return the mutated path of the arrow in the display coord

set_annotation_clip(*b*)

set `annotation_clip` attribute.

- **True:** the annotation will only be drawn when `self.xy` is inside the axes.

- False:** the annotation will always be drawn regardless of its position.
- None:** the self.xy will be checked only if *xycoords* is “data”

class matplotlib.patches.ConnectionStyle

Bases: matplotlib.patches._Style

ConnectionStyle is a container class which defines several connectionstyle classes, which is used to create a path between two points. These are mainly used with *FancyArrowPatch*.

A connectionstyle object can be either created as:

```
ConnectionStyle.Arc3(rad=0.2)
```

or:

```
ConnectionStyle("Arc3", rad=0.2)
```

or:

```
ConnectionStyle("Arc3, rad=0.2")
```

The following classes are defined

Class	Name	Attrs
Angle	angle	angleA=90,angleB=0,rad=0.0
Angle3	angle3	angleA=90,angleB=0
Arc	arc	angleA=0,angleB=0,armA=None,armB=None,rad=0.0
Arc3	arc3	rad=0.0
Bar	bar	armA=0.0,armB=0.0,fraction=0.3,angle=None

An instance of any connection style class is an callable object, whose call signature is:

```
__call__(self, posA, posB,
         patchA=None, patchB=None,
         shrinkA=2., shrinkB=2.)
```

and it returns a *Path* instance. *posA* and *posB* are tuples of x,y coordinates of the two points to be connected. *patchA* (or *patchB*) is given, the returned path is clipped so that it start (or end) from the boundary of the patch. The path is further shrunk by *shrinkA* (or *shrinkB*) which is given in points.

return the instance of the subclass with the given style name.

class Angle(angleA=90, angleB=0, rad=0.0)

Bases: matplotlib.patches._Base

Creates a piecewise continuous quadratic bezier path between two points. The path has a one passing-through point placed at the intersecting point of two lines which crosses the start (or end) point and has a angle of angleA (or angleB). The connecting edges are rounded with *rad*.

angleA starting angle of the path

angleB ending angle of the path

rad rounding radius of the edge

connect(*posA*, *posB*)

class Angle3(*angleA=90*, *angleB=0*)

Bases: `matplotlib.patches._Base`

Creates a simple quadratic bezier curve between two points. The middle control points is placed at the intersecting point of two lines which crosses the start (or end) point and has a angle of *angleA* (or *angleB*).

angleA starting angle of the path

angleB ending angle of the path

connect(*posA*, *posB*)

class Arc(*angleA=0*, *angleB=0*, *armA=None*, *armB=None*, *rad=0.0*)

Bases: `matplotlib.patches._Base`

Creates a piecewise continuous quadratic bezier path between two points. The path can have two passing-through points, a point placed at the distance of *armA* and angle of *angleA* from point A, another point with respect to point B. The edges are rounded with *rad*.

angleA : starting angle of the path

angleB : ending angle of the path

armA : length of the starting arm

armB : length of the ending arm

rad : rounding radius of the edges

connect(*posA*, *posB*)

class Arc3(*rad=0.0*)

Bases: `matplotlib.patches._Base`

Creates a simple quadratic bezier curve between two points. The curve is created so that the middle control points (C1) is located at the same distance from the start (C0) and end points(C2) and the distance of the C1 to the line connecting C0-C2 is *rad* times the distance of C0-C2.

rad curvature of the curve.

connect(*posA*, *posB*)

class Bar(*armA=0.0*, *armB=0.0*, *fraction=0.3*, *angle=None*)

Bases: `matplotlib.patches._Base`

A line with *angle* between A and B with *armA* and *armB*. One of the arms is extended so that they are connected in a right angle. The length of *armA* is determined by (*armA* + *fraction* x AB distance). Same for *armB*.

Parameters *armA* : float

minimum length of armA

armB : float

minimum length of armB

fraction : float

a fraction of the distance between two points that will be added to armA and armB.

angle : float or None

angle of the connecting line (if None, parallel to A and B)

connect(*posA*, *posB*)

class matplotlib.patches.**Ellipse**(*xy*, *width*, *height*, *angle=0.0*, ***kwargs*)

Bases: *matplotlib.patches.Patch*

A scale-free ellipse.

xy center of ellipse

width total length (diameter) of horizontal axis

height total length (diameter) of vertical axis

angle rotation in degrees (anti-clockwise)

Valid kwargs are:

Property	Description
<i>agg_filter</i>	unknown
<i>alpha</i>	float or None
<i>animated</i>	[True False]
<i>antialiased</i> or <i>aa</i>	[True False] or None for default
<i>axes</i>	an <i>Axes</i> instance
<i>capstyle</i>	['butt' 'round' 'projecting']
<i>clip_box</i>	a <i>matplotlib.transforms.Bbox</i> instance
<i>clip_on</i>	[True False]
<i>clip_path</i>	[(<i>Path</i> , <i>Transform</i>) <i>Patch</i> None]
<i>color</i>	matplotlib color spec
<i>contains</i>	a callable function
<i>edgecolor</i> or <i>ec</i>	mpl color spec, None, 'none', or 'auto'
<i>facecolor</i> or <i>fc</i>	mpl color spec, or None for default, or 'none' for no color
<i>figure</i>	a <i>matplotlib.figure.Figure</i> instance
<i>fill</i>	[True False]
<i>gid</i>	an id string
<i>hatch</i>	['/' '\' ' ' '- ' '+ ' 'x' 'o' 'O' '.' '*']
<i>joinstyle</i>	['miter' 'round' 'bevel']
<i>label</i>	string or anything printable with '%s' conversion.

Continued on

Table 41.5 – continued from previous page

Property	Description
<i>linestyle</i> or <i>ls</i>	['solid' 'dashed', 'dashdot', 'dotted' (offset, on-off-dash-seq) '-' '--' '-.' ':' 'None']
<i>linewidth</i> or <i>lw</i>	float or None for default
<i>path_effects</i>	unknown
<i>picker</i>	[None float boolean callable]
<i>rasterized</i>	[True False None]
<i>sketch_params</i>	unknown
<i>snap</i>	unknown
<i>transform</i>	<i>Transform</i> instance
<i>url</i>	a url string
<i>visible</i>	[True False]
<i>zorder</i>	any number

get_patch_transform()**get_path()**

Return the vertices of the rectangle

```
class matplotlib.patches.FancyArrow(x, y, dx, dy, width=0.001, length_includes_head=False,
                                     head_width=None, head_length=None, shape='full',
                                     overhang=0, head_starts_at_zero=False, **kwargs)
```

Bases: *matplotlib.patches.Polygon*

Like Arrow, but lets you set head width and head height independently.

Constructor arguments

width: float (default: 0.001) width of full arrow tail

length_includes_head: [True | False] (default: False) True if head is to be counted in calculating the length.

head_width: float or None (default: 3*width) total width of the full arrow head

head_length: float or None (default: 1.5 * head_width) length of arrow head

shape: ['full', 'left', 'right'] (default: 'full') draw the left-half, right-half, or full arrow

overhang: float (default: 0) fraction that the arrow is swept back (0 overhang means triangular shape). Can be negative or greater than one.

head_starts_at_zero: [True | False] (default: False) if True, the head starts being drawn at coordinate 0 instead of ending at coordinate 0.

Other valid kwargs (inherited from *Patch*) are:

Property	Description
<i>agg_filter</i>	unknown

Continued on

Table 41.6 – continued from previous page

Property	Description
<i>alpha</i>	float or None
<i>animated</i>	[True False]
<i>antialiased</i> or <i>aa</i>	[True False] or None for default
<i>axes</i>	an <i>Axes</i> instance
<i>capstyle</i>	['butt' 'round' 'projecting']
<i>clip_box</i>	a <i>matplotlib.transforms.Bbox</i> instance
<i>clip_on</i>	[True False]
<i>clip_path</i>	[(<i>Path</i> , <i>Transform</i>) <i>Patch</i> None]
<i>color</i>	matplotlib color spec
<i>contains</i>	a callable function
<i>edgecolor</i> or <i>ec</i>	mpl color spec, None, 'none', or 'auto'
<i>facecolor</i> or <i>fc</i>	mpl color spec, or None for default, or 'none' for no color
<i>figure</i>	a <i>matplotlib.figure.Figure</i> instance
<i>fill</i>	[True False]
<i>gid</i>	an id string
<i>hatch</i>	['/' '\' ' ' '-' '+' 'x' 'o' 'O' '.' '*']
<i>joinstyle</i>	['miter' 'round' 'bevel']
<i>label</i>	string or anything printable with '%s' conversion.
<i>linestyle</i> or <i>ls</i>	['solid' 'dashed', 'dashdot', 'dotted' (offset, on-off-dash-seq) '-' '--' '-.' ':' 'None']
<i>linewidth</i> or <i>lw</i>	float or None for default
<i>path_effects</i>	unknown
<i>picker</i>	[None float boolean callable]
<i>rasterized</i>	[True False None]
<i>sketch_params</i>	unknown
<i>snap</i>	unknown
<i>transform</i>	<i>Transform</i> instance
<i>url</i>	a url string
<i>visible</i>	[True False]
<i>zorder</i>	any number

```
class matplotlib.patches.FancyArrowPatch(posA=None, posB=None, path=None, arrowstyle='simple', arrow_transmuter=None, connectionstyle='arc3', connector=None, patchA=None, patchB=None, shrinkA=2.0, shrinkB=2.0, mutation_scale=1.0, mutation_aspect=None, dpi_cor=1.0, **kwargs)
```

Bases: *matplotlib.patches.Patch*

A fancy arrow patch. It draws an arrow using the :class:ArrowStyle.

If *posA* and *posB* is given, a path connecting two point are created according to the *connectionstyle*. The path will be clipped with *patchA* and *patchB* and further shrunken by *shrinkA* and *shrinkB*. An arrow is drawn along this resulting path using the *arrowstyle* parameter. If *path* provided, an arrow is drawn along this path and *patchA*, *patchB*, *shrinkA*, and *shrinkB* are ignored.

The *connectionstyle* describes how *posA* and *posB* are connected. It can be an instance of the `ConnectionStyle` class (`matplotlib.patches.ConnectionStyle`) or a string of the connectionstyle name, with optional comma-separated attributes. The following connection styles are available.

Class	Name	Attrs
Angle	angle	angleA=90,angleB=0,rad=0.0
Angle3	angle3	angleA=90,angleB=0
Arc	arc	angleA=0,angleB=0,armA=None,armB=None,rad=0.0
Arc3	arc3	rad=0.0
Bar	bar	armA=0.0,armB=0.0,fraction=0.3,angle=None

The *arrowstyle* describes how the fancy arrow will be drawn. It can be string of the available arrowstyle names, with optional comma-separated attributes, or one of the `ArrowStyle` instance. The optional attributes are meant to be scaled with the *mutation_scale*. The following arrow styles are available.

Class	Name	Attrs
Curve	-	None
CurveB	->	head_length=0.4,head_width=0.2
BracketB	-[widthB=1.0,lengthB=0.2,angleB=None
Curve-FilledB	- >	head_length=0.4,head_width=0.2
CurveA	<-	head_length=0.4,head_width=0.2
CurveAB	<->	head_length=0.4,head_width=0.2
Curve-FilledA	< -	head_length=0.4,head_width=0.2
Curve-FilledAB	< - >	head_length=0.4,head_width=0.2
BracketA] -	widthA=1.0,lengthA=0.2,angleA=None
BracketAB] - [widthA=1.0,lengthA=0.2,angleA=None,widthB=1.0,lengthB=0.2,angleB=None
Fancy	fancy	head_length=0.4,head_width=0.4,tail_width=0.4
Simple	simple	head_length=0.5,head_width=0.5,tail_width=0.2
Wedge	wedge	tail_width=0.3,shrink_factor=0.5
BarAB	-	widthA=1.0,angleA=None,widthB=1.0,angleB=None

mutation_scale [a value with which attributes of arrowstyle] (e.g., *head_length*) will be scaled. default=1.

mutation_aspect [The height of the rectangle will be] squeezed by this value before the mutation and the mutated box will be stretched by the inverse of it. default=None.

Valid kwargs are:

Property	Description
<i>agg_filter</i>	unknown
<i>alpha</i>	float or None
<i>animated</i>	[True False]
<i>antialiased</i> or <i>aa</i>	[True False] or None for default

Continued on

Table 41.7 – continued from previous page

Property	Description
<i>axes</i>	an <i>Axes</i> instance
<i>capstyle</i>	['butt' 'round' 'projecting']
<i>clip_box</i>	a <i>matplotlib.transforms.Bbox</i> instance
<i>clip_on</i>	[True False]
<i>clip_path</i>	[(<i>Path</i> , <i>Transform</i>) <i>Patch</i> None]
<i>color</i>	matplotlib color spec
<i>contains</i>	a callable function
<i>edgecolor</i> or <i>ec</i>	mpl color spec, None, 'none', or 'auto'
<i>facecolor</i> or <i>fc</i>	mpl color spec, or None for default, or 'none' for no color
<i>figure</i>	a <i>matplotlib.figure.Figure</i> instance
<i>fill</i>	[True False]
<i>gid</i>	an id string
<i>hatch</i>	['/' '\' ' ' '-' '+' 'x' 'o' 'O' '.' '*']
<i>joinstyle</i>	['miter' 'round' 'bevel']
<i>label</i>	string or anything printable with '%s' conversion.
<i>linestyle</i> or <i>ls</i>	['solid' 'dashed', 'dashdot', 'dotted' (offset, on-off-dash-seq) '-' '--' '-.' ':' 'None']
<i>linewidth</i> or <i>lw</i>	float or None for default
<i>path_effects</i>	unknown
<i>picker</i>	[None float boolean callable]
<i>rasterized</i>	[True False None]
<i>sketch_params</i>	unknown
<i>snap</i>	unknown
<i>transform</i>	<i>Transform</i> instance
<i>url</i>	a url string
<i>visible</i>	[True False]
<i>zorder</i>	any number

draw(*renderer*)

get_arrowstyle()

Return the arrowstyle object

get_connectionstyle()

Return the ConnectionStyle instance

get_dpi_cor()

dpi_cor is currently used for linewidth-related things and shrink factor. Mutation scale is affected by this.

get_mutation_aspect()

Return the aspect ratio of the bbox mutation.

get_mutation_scale()

Return the mutation scale.

get_path()

return the path of the arrow in the data coordinate. Use `get_path_in_displaycoord()` method to retrieve the arrow path in the display coord.

get_path_in_displaycoord()

Return the mutated path of the arrow in the display coord

set_arrowstyle(*arrowstyle=None, **kw*)

Set the arrow style.

***arrowstyle* can be a string with arrowstyle name with optional** comma-separated attributes. Alternatively, the attrs can be provided as keywords.

```
set_arrowstyle("Fancy,head_length=0.2") set_arrowstyle("fancy", head_length=0.2)
```

Old attrs simply are forgotten.

Without argument (or with `arrowstyle=None`), return available box styles as a list of strings.

set_connectionstyle(*connectionstyle, **kw*)

Set the connection style.

***connectionstyle* can be a string with connectionstyle name with optional** comma-separated attributes. Alternatively, the attrs can be provided as keywords.

```
set_connectionstyle("arc,angleA=0,armA=30,rad=10") set_connectionstyle("arc", angleA=0,armA=30,rad=10)
```

Old attrs simply are forgotten.

Without argument (or with `connectionstyle=None`), return available styles as a list of strings.

set_dpi_cor(*dpi_cor*)

`dpi_cor` is currently used for linewidth-related things and shrink factor. Mutation scale is affected by this.

set_mutation_aspect(*aspect*)

Set the aspect ratio of the bbox mutation.

ACCEPTS: float

set_mutation_scale(*scale*)

Set the mutation scale.

ACCEPTS: float

set_patchA(*patchA*)

set the begin patch.

set_patchB(*patchB*)

set the begin patch

set_positions(*posA, posB*)

set the begin and end positions of the connecting path. Use current value if `None`.

```
class matplotlib.patches.FancyBboxPatch(xy, width, height, boxstyle='round',
                                       bbox_transmuter=None, mutation_scale=1.0,
                                       mutation_aspect=None, **kwargs)
```

Bases: `matplotlib.patches.Patch`

Draw a fancy box around a rectangle with lower left at `xy*=(*x, y)` with specified width and height.

`FancyBboxPatch` class is similar to `Rectangle` class, but it draws a fancy box around the rectangle. The transformation of the rectangle box to the fancy box is delegated to the `BoxTransmuterBase` and its derived classes.

`xy` = lower left corner

`width, height`

`boxstyle` determines what kind of fancy box will be drawn. It can be a string of the style name with a comma separated attribute, or an instance of `BoxStyle`. Following box styles are available.

Class	Name	Attrs
Circle	circle	pad=0.3
DArrow	darrow	pad=0.3
LArrow	larrow	pad=0.3
RArrow	rarrow	pad=0.3
Round	round	pad=0.3,rounding_size=None
Round4	round4	pad=0.3,rounding_size=None
Roundtooth	roundtooth	pad=0.3,tooth_size=None
Sawtooth	sawtooth	pad=0.3,tooth_size=None
Square	square	pad=0.3

`mutation_scale` : a value with which attributes of boxstyle (e.g., pad) will be scaled. default=1.

`mutation_aspect` : The height of the rectangle will be squeezed by this value before the mutation and the mutated box will be stretched by the inverse of it. default=None.

Valid kwargs are:

Property	Description
<code>agg_filter</code>	unknown
<code>alpha</code>	float or None
<code>animated</code>	[True False]
<code>antialiased</code> or <code>aa</code>	[True False] or None for default
<code>axes</code>	an <code>Axes</code> instance
<code>capstyle</code>	['butt' 'round' 'projecting']
<code>clip_box</code>	a <code>matplotlib.transforms.Bbox</code> instance
<code>clip_on</code>	[True False]
<code>clip_path</code>	[(<code>Path, Transform</code>) <code>Patch</code> None]
<code>color</code>	matplotlib color spec
<code>contains</code>	a callable function
<code>edgecolor</code> or <code>ec</code>	mpl color spec, None, 'none', or 'auto'
<code>facecolor</code> or <code>fc</code>	mpl color spec, or None for default, or 'none' for no color
<code>figure</code>	a <code>matplotlib.figure.Figure</code> instance

Continued on

Table 41.8 – continued from previous page

Property	Description
<i>fill</i>	[True False]
<i>gid</i>	an id string
<i>hatch</i>	['/' '\ ' ' ' '- ' '+ ' 'x' 'o' 'O' '.' '*']
<i>joinstyle</i>	['miter' 'round' 'bevel']
<i>label</i>	string or anything printable with '%s' conversion.
<i>linestyle</i> or <i>ls</i>	['solid' 'dashed', 'dashdot', 'dotted' (offset, on-off-dash-seq) '- ' '-- ' '- .' ':' 'None']
<i>linewidth</i> or <i>lw</i>	float or None for default
<i>path_effects</i>	unknown
<i>picker</i>	[None float boolean callable]
<i>rasterized</i>	[True False None]
<i>sketch_params</i>	unknown
<i>snap</i>	unknown
<i>transform</i>	<i>Transform</i> instance
<i>url</i>	a url string
<i>visible</i>	[True False]
<i>zorder</i>	any number

get_bbox()

get_boxstyle()

Return the boxstyle object

get_height()

Return the height of the rectangle

get_mutation_aspect()

Return the aspect ratio of the bbox mutation.

get_mutation_scale()

Return the mutation scale.

get_path()

Return the mutated path of the rectangle

get_width()

Return the width of the rectangle

get_x()

Return the left coord of the rectangle

get_y()

Return the bottom coord of the rectangle

set_bounds(*args)

Set the bounds of the rectangle: l,b,w,h

ACCEPTS: (left, bottom, width, height)

set_boxstyle(*boxstyle=None, **kw*)

Set the box style.

boxstyle can be a string with boxstyle name with optional comma-separated attributes. Alternatively, the attrs can be provided as keywords:

```
set_boxstyle("round,pad=0.2")
set_boxstyle("round", pad=0.2)
```

Old attrs simply are forgotten.

Without argument (or with *boxstyle = None*), it returns available box styles.

The following boxstyles are available:

Class	Name	Attrs
Circle	circle	pad=0.3
DArrow	darrow	pad=0.3
LArrow	larrow	pad=0.3
RArrow	rarrow	pad=0.3
Round	round	pad=0.3,rounding_size=None
Round4	round4	pad=0.3,rounding_size=None
Roundtooth	roundtooth	pad=0.3,tooth_size=None
Sawtooth	sawtooth	pad=0.3,tooth_size=None
Square	square	pad=0.3

ACCEPTS: ['circle' | 'darrow' | 'larrow' | 'rarrow' | 'round' | 'round4' | 'roundtooth' | 'sawtooth' | 'square']

set_height(*h*)

Set the width rectangle

ACCEPTS: float

set_mutation_aspect(*aspect*)

Set the aspect ratio of the bbox mutation.

ACCEPTS: float

set_mutation_scale(*scale*)

Set the mutation scale.

ACCEPTS: float

set_width(*w*)

Set the width rectangle

ACCEPTS: float

set_x(*x*)

Set the left coord of the rectangle

ACCEPTS: float

set_y(*y*)

Set the bottom coord of the rectangle

ACCEPTS: float

```
class matplotlib.patches.Patch(edgecolor=None, facecolor=None, color=None,
                               linewidth=None, linestyle=None, antialiased=None,
                               hatch=None, fill=True, capstyle=None, joinstyle=None,
                               **kwargs)
```

Bases: `matplotlib.artist.Artist`

A patch is a 2D artist with a face color and an edge color.

If any of `edgecolor`, `facecolor`, `linewidth`, or `antialiased` are `None`, they default to their rc params setting.

The following kwarg properties are supported

Property	Description
<code>agg_filter</code>	unknown
<code>alpha</code>	float or None
<code>animated</code>	[True False]
<code>antialiased</code> or <code>aa</code>	[True False] or None for default
<code>axes</code>	an <code>Axes</code> instance
<code>capstyle</code>	['butt' 'round' 'projecting']
<code>clip_box</code>	a <code>matplotlib.transforms.Bbox</code> instance
<code>clip_on</code>	[True False]
<code>clip_path</code>	[(<code>Path</code> , <code>Transform</code>) <code>Patch</code> None]
<code>color</code>	matplotlib color spec
<code>contains</code>	a callable function
<code>edgecolor</code> or <code>ec</code>	mpl color spec, None, 'none', or 'auto'
<code>facecolor</code> or <code>fc</code>	mpl color spec, or None for default, or 'none' for no color
<code>figure</code>	a <code>matplotlib.figure.Figure</code> instance
<code>fill</code>	[True False]
<code>gid</code>	an id string
<code>hatch</code>	['/' '\' ' ' '-' '+' 'x' 'o' 'O' '.' '*']
<code>joinstyle</code>	['miter' 'round' 'bevel']
<code>label</code>	string or anything printable with '%s' conversion.
<code>linestyle</code> or <code>ls</code>	['solid' 'dashed', 'dashdot', 'dotted' (offset, on-off-dash-seq) '-' '--' '-.' ':' 'None']
<code>linewidth</code> or <code>lw</code>	float or None for default
<code>path_effects</code>	unknown
<code>picker</code>	[None float boolean callable]
<code>rasterized</code>	[True False None]
<code>sketch_params</code>	unknown
<code>snap</code>	unknown
<code>transform</code>	<code>Transform</code> instance
<code>url</code>	a url string
<code>visible</code>	[True False]
<code>zorder</code>	any number

`contains(mouseevent, radius=None)`

Test whether the mouse event occurred in the patch.

Returns T/F, { }

contains_point(*point*, *radius=None*)

Returns *True* if the given point is inside the path (transformed with its transform attribute).

draw(*artist*, *renderer*, **args*, ***kwargs*)

Draw the *Patch* to the given *renderer*.

fill

return whether fill is set

get_aa()

Returns True if the *Patch* is to be drawn with antialiasing.

get_antialiased()

Returns True if the *Patch* is to be drawn with antialiasing.

get_capstyle()

Return the current capstyle

get_data_transform()

Return the *Transform* instance which maps data coordinates to physical coordinates.

get_ec()

Return the edge color of the *Patch*.

get_edgecolor()

Return the edge color of the *Patch*.

get_extents()

Return a *Bbox* object defining the axis-aligned extents of the *Patch*.

get_facecolor()

Return the face color of the *Patch*.

get_fc()

Return the face color of the *Patch*.

get_fill()

return whether fill is set

get_hatch()

Return the current hatching pattern

get_joinstyle()

Return the current joinstyle

get_linestyle()

Return the linestyle. Will be one of ['solid' | 'dashed' | 'dashdot' | 'dotted']

get_linewidth()

Return the line width in points.

get_ls()

Return the linestyle. Will be one of ['solid' | 'dashed' | 'dashdot' | 'dotted']

get_lw()

Return the line width in points.

get_patch_transform()

Return the *Transform* instance which takes patch coordinates to data coordinates.

For example, one may define a patch of a circle which represents a radius of 5 by providing coordinates for a unit circle, and a transform which scales the coordinates (the patch coordinate) by 5.

get_path()

Return the path of this patch

get_transform()

Return the *Transform* applied to the *Patch*.

get_verts()

Return a copy of the vertices used in this patch

If the patch contains Bezier curves, the curves will be interpolated by line segments. To access the curves as curves, use *get_path()*.

get_window_extent(renderer=None)**set_aa(aa)**

alias for *set_antialiased*

set_alpha(alpha)

Set the alpha transparency of the patch.

ACCEPTS: float or None

set_antialiased(aa)

Set whether to use antialiased rendering

ACCEPTS: [True | False] or None for default

set_capstyle(s)

Set the patch capstyle

ACCEPTS: ['butt' | 'round' | 'projecting']

set_color(c)

Set both the edgecolor and the facecolor.

ACCEPTS: matplotlib color spec

See also:

[*set_facecolor\(\)*](#), [*set_edgecolor\(\)*](#) For setting the edge or face color individually.

set_ec(color)

alias for *set_edgecolor*

set_edgcolor(*color*)

Set the patch edge color

ACCEPTS: mpl color spec, None, 'none', or 'auto'

set_facecolor(*color*)

Set the patch face color

ACCEPTS: mpl color spec, or None for default, or 'none' for no color

set_fc(*color*)

alias for set_facecolor

set_fill(*b*)

Set whether to fill the patch

ACCEPTS: [True | False]

set_hatch(*hatch*)

Set the hatching pattern

hatch can be one of:

/	- diagonal hatching
\	- back diagonal
	- vertical
-	- horizontal
+	- crossed
x	- crossed diagonal
o	- small circle
O	- large circle
.	- dots
*	- stars

Letters can be combined, in which case all the specified hatchings are done. If same letter repeats, it increases the density of hatching of that pattern.

Hatching is supported in the PostScript, PDF, SVG and Agg backends only.

ACCEPTS: ['/' | '\ ' | ' | ' - ' | ' + ' | ' x ' | ' o ' | ' O ' | ' . ' | ' * ']

set_joinstyle(*s*)

Set the patch joinstyle

ACCEPTS: ['miter' | 'round' | 'bevel']

set_linestyle(*ls*)

Set the patch linestyle

linestyle	description
'-' or 'solid'	solid line
'--' or 'dashed'	dashed line
'-.' or 'dashdot'	dash-dotted line
':' or 'dotted'	dotted line

Alternatively a dash tuple of the following form can be provided:

(offset, onoffseq),

where `onoffseq` is an even length tuple of on and off ink in points.

ACCEPTS: [`'solid'` | `'dashed'`, `'dashdot'`, `'dotted'` | (offset, on-off-dash-seq) | `'-'` | `'--'` | `'-.'` | `'::'` | `'None'` | `' '` | `''`]

Parameters `ls`: { `'-'`, `'--'`, `'-.'`, `'::'` } and more see description

The line style.

set_linewidth(*w*)

Set the patch linewidth in points

ACCEPTS: float or None for default

set_ls(*ls*)

alias for `set_linestyle`

set_lw(*lw*)

alias for `set_linewidth`

update_from(*other*)

Updates this *Patch* from the properties of *other*.

validCap = ('butt', 'round', 'projecting')

validJoin = ('miter', 'round', 'bevel')

zorder = 1

class matplotlib.patches.PathPatch(*path*, *kwargs*)**

Bases: `matplotlib.patches.Patch`

A general polycurve path patch.

path is a `matplotlib.path.Path` object.

Valid kwargs are:

Property	Description
<code>agg_filter</code>	unknown
<code>alpha</code>	float or None
<code>animated</code>	[True False]
<code>antialiased</code> or <code>aa</code>	[True False] or None for default
<code>axes</code>	an <i>Axes</i> instance
<code>capstyle</code>	[<code>'butt'</code> <code>'round'</code> <code>'projecting'</code>]
<code>clip_box</code>	a <code>matplotlib.transforms.Bbox</code> instance
<code>clip_on</code>	[True False]

Continued on

Table 41.10 – continued from previous page

Property	Description
<i>clip_path</i>	[(<i>Path</i> , <i>Transform</i>) <i>Patch</i> None]
<i>color</i>	matplotlib color spec
<i>contains</i>	a callable function
<i>edgecolor</i> or <i>ec</i>	mpl color spec, None, ‘none’, or ‘auto’
<i>facecolor</i> or <i>fc</i>	mpl color spec, or None for default, or ‘none’ for no color
<i>figure</i>	a <i>matplotlib.figure.Figure</i> instance
<i>fill</i>	[True False]
<i>gid</i>	an id string
<i>hatch</i>	['/' '\ ' ' ' '- ' '+ ' 'x' 'o' 'O' '.' '*']
<i>joinstyle</i>	['miter' 'round' 'bevel']
<i>label</i>	string or anything printable with ‘%s’ conversion.
<i>linestyle</i> or <i>ls</i>	['solid' 'dashed', 'dashdot', 'dotted' (offset, on-off-dash-seq) '- ' '-- ' '- .' ':' 'None']
<i>linewidth</i> or <i>lw</i>	float or None for default
<i>path_effects</i>	unknown
<i>picker</i>	[None float boolean callable]
<i>rasterized</i>	[True False None]
<i>sketch_params</i>	unknown
<i>snap</i>	unknown
<i>transform</i>	<i>Transform</i> instance
<i>url</i>	a url string
<i>visible</i>	[True False]
<i>zorder</i>	any number

See also:

Patch For additional kwargs

get_path()

class matplotlib.patches.Polygon(*xy*, *closed=True*, ***kwargs*)

Bases: *matplotlib.patches.Patch*

A general polygon patch.

xy is a numpy array with shape Nx2.

If *closed* is *True*, the polygon will be closed so the starting and ending points are the same.

Valid kwargs are:

Property	Description
<i>agg_filter</i>	unknown
<i>alpha</i>	float or None

Continued on

Table 41.11 – continued from previous page

Property	Description
<i>animated</i>	[True False]
<i>antialiased</i> or <i>aa</i>	[True False] or None for default
<i>axes</i>	an <i>Axes</i> instance
<i>capstyle</i>	['butt' 'round' 'projecting']
<i>clip_box</i>	a <i>matplotlib.transforms.Bbox</i> instance
<i>clip_on</i>	[True False]
<i>clip_path</i>	[(<i>Path</i> , <i>Transform</i>) <i>Patch</i> None]
<i>color</i>	matplotlib color spec
<i>contains</i>	a callable function
<i>edgecolor</i> or <i>ec</i>	mpl color spec, None, 'none', or 'auto'
<i>facecolor</i> or <i>fc</i>	mpl color spec, or None for default, or 'none' for no color
<i>figure</i>	a <i>matplotlib.figure.Figure</i> instance
<i>fill</i>	[True False]
<i>gid</i>	an id string
<i>hatch</i>	['/' '\' ' ' '-' '+' 'x' 'o' 'O' '.' '*']
<i>joinstyle</i>	['miter' 'round' 'bevel']
<i>label</i>	string or anything printable with '%s' conversion.
<i>linestyle</i> or <i>ls</i>	['solid' 'dashed', 'dashdot', 'dotted' (offset, on-off-dash-seq) '-' '--' '-.' ':' 'None']
<i>linewidth</i> or <i>lw</i>	float or None for default
<i>path_effects</i>	unknown
<i>picker</i>	[None float boolean callable]
<i>rasterized</i>	[True False None]
<i>sketch_params</i>	unknown
<i>snap</i>	unknown
<i>transform</i>	<i>Transform</i> instance
<i>url</i>	a url string
<i>visible</i>	[True False]
<i>zorder</i>	any number

See also:*Patch* For additional kwargs**get_closed()**

Returns if the polygon is closed

Returns closed : bool

If the path is closed

get_path()

Get the path of the polygon

Returns path : Path

The *Path* object for the polygon

get_xy()

Get the vertices of the path

Returns vertices : numpy array

The coordinates of the vertices as a Nx2 ndarray.

set_closed(*closed*)

Set if the polygon is closed

Parameters closed : bool

True if the polygon is closed

set_xy(*xy*)

Set the vertices of the polygon

Parameters xy : numpy array or iterable of pairs

The coordinates of the vertices as a Nx2 ndarray or iterable of pairs.

xy

Set/get the vertices of the polygon. This property is provided for backward compatibility with matplotlib 0.91.x only. New code should use *get_xy()* and *set_xy()* instead.

class matplotlib.patches.Rectangle(*xy, width, height, angle=0.0, **kwargs*)

Bases: *matplotlib.patches.Patch*

Draw a rectangle with lower left at *xy* = (*x*, *y*) with specified *width* and *height*.

angle rotation in degrees (anti-clockwise)

fill is a boolean indicating whether to fill the rectangle

Valid kwargs are:

Property	Description
<i>agg_filter</i>	unknown
<i>alpha</i>	float or None
<i>animated</i>	[True False]
<i>antialiased</i> or <i>aa</i>	[True False] or None for default
<i>axes</i>	an <i>Axes</i> instance
<i>capstyle</i>	['butt' 'round' 'projecting']
<i>clip_box</i>	a <i>matplotlib.transforms.Bbox</i> instance
<i>clip_on</i>	[True False]
<i>clip_path</i>	[(<i>Path, Transform</i>) <i>Patch</i> None]
<i>color</i>	matplotlib color spec
<i>contains</i>	a callable function
<i>edgecolor</i> or <i>ec</i>	mpl color spec, None, 'none', or 'auto'
<i>facecolor</i> or <i>fc</i>	mpl color spec, or None for default, or 'none' for no color
<i>figure</i>	a <i>matplotlib.figure.Figure</i> instance
<i>fill</i>	[True False]

Continued on

Table 41.12 – continued from previous page

Property	Description
<i>gid</i>	an id string
<i>hatch</i>	['/' '\ ' ' '-' '+' 'x' 'o' 'O' '.' '*']
<i>joinstyle</i>	['miter' 'round' 'bevel']
<i>label</i>	string or anything printable with '%s' conversion.
<i>linestyle</i> or <i>ls</i>	['solid' 'dashed', 'dashdot', 'dotted' (offset, on-off-dash-seq) '-' '--' '-.' ':' 'None']
<i>linewidth</i> or <i>lw</i>	float or None for default
<i>path_effects</i>	unknown
<i>picker</i>	[None float boolean callable]
<i>rasterized</i>	[True False None]
<i>sketch_params</i>	unknown
<i>snap</i>	unknown
<i>transform</i>	<i>Transform</i> instance
<i>url</i>	a url string
<i>visible</i>	[True False]
<i>zorder</i>	any number

get_bbox()

get_height()

Return the height of the rectangle

get_patch_transform()

get_path()

Return the vertices of the rectangle

get_width()

Return the width of the rectangle

get_x()

Return the left coord of the rectangle

get_xy()

Return the left and bottom coords of the rectangle

get_y()

Return the bottom coord of the rectangle

set_bounds(*args)

Set the bounds of the rectangle: l,b,w,h

ACCEPTS: (left, bottom, width, height)

set_height(h)

Set the width rectangle

ACCEPTS: float

set_width(*w*)

Set the width rectangle

ACCEPTS: float

set_x(*x*)

Set the left coord of the rectangle

ACCEPTS: float

set_xy(*xy*)

Set the left and bottom coords of the rectangle

ACCEPTS: 2-item sequence

set_y(*y*)

Set the bottom coord of the rectangle

ACCEPTS: float

xy

Return the left and bottom coords of the rectangle

class matplotlib.patches.RegularPolygon(*xy*, *numVertices*, *radius=5*, *orientation=0*,
***kwargs*)

Bases: *matplotlib.patches.Patch*

A regular polygon patch.

Constructor arguments:

xy A length 2 tuple (*x*, *y*) of the center.

numVertices the number of vertices.

radius The distance from the center to each of the vertices.

orientation rotates the polygon (in radians).

Valid kwargs are:

Property	Description
<i>agg_filter</i>	unknown
<i>alpha</i>	float or None
<i>animated</i>	[True False]
<i>antialiased</i> or <i>aa</i>	[True False] or None for default
<i>axes</i>	an <i>Axes</i> instance
<i>capstyle</i>	['butt' 'round' 'projecting']
<i>clip_box</i>	a <i>matplotlib.transforms.Bbox</i> instance
<i>clip_on</i>	[True False]
<i>clip_path</i>	[(<i>Path</i> , <i>Transform</i>) <i>Patch</i> None]
<i>color</i>	matplotlib color spec
<i>contains</i>	a callable function
<i>edgecolor</i> or <i>ec</i>	mpl color spec, None, 'none', or 'auto'

Continued on

Table 41.13 – continued from previous page

Property	Description
<i>facecolor</i> or <i>fc</i>	mpl color spec, or None for default, or ‘none’ for no color
<i>figure</i>	a <i>matplotlib.figure.Figure</i> instance
<i>fill</i>	[True False]
<i>gid</i>	an id string
<i>hatch</i>	[‘/’ ‘\’ ‘ ’ ‘-’ ‘+’ ‘x’ ‘o’ ‘O’ ‘.’ ‘*’]
<i>joinstyle</i>	[‘miter’ ‘round’ ‘bevel’]
<i>label</i>	string or anything printable with ‘%s’ conversion.
<i>linestyle</i> or <i>ls</i>	[‘solid’ ‘dashed’, ‘dashdot’, ‘dotted’ (offset, on-off-dash-seq) ‘-’ ‘--’ ‘-.’ ‘:’ ‘None’]
<i>linewidth</i> or <i>lw</i>	float or None for default
<i>path_effects</i>	unknown
<i>picker</i>	[None float boolean callable]
<i>rasterized</i>	[True False None]
<i>sketch_params</i>	unknown
<i>snap</i>	unknown
<i>transform</i>	<i>Transform</i> instance
<i>url</i>	a url string
<i>visible</i>	[True False]
<i>zorder</i>	any number

get_patch_transform()

get_path()

numvertices

orientation

radius

xy

class `matplotlib.patches.Shadow`(*patch*, *ox*, *oy*, *props=None*, ***kwargs*)

Bases: `matplotlib.patches.Patch`

Create a shadow of the given *patch* offset by *ox*, *oy*. *props*, if not *None*, is a patch property update dictionary. If *None*, the shadow will have the same color as the face, but darkened.

kwargs are

Property	Description
<i>agg_filter</i>	unknown
<i>alpha</i>	float or None
<i>animated</i>	[True False]
<i>antialiased</i> or <i>aa</i>	[True False] or None for default
<i>axes</i>	an <i>Axes</i> instance
<i>capstyle</i>	['butt' 'round' 'projecting']
<i>clip_box</i>	a <i>matplotlib.transforms.Bbox</i> instance
<i>clip_on</i>	[True False]
<i>clip_path</i>	[(<i>Path</i> , <i>Transform</i>) <i>Patch</i> None]
<i>color</i>	matplotlib color spec
<i>contains</i>	a callable function
<i>edgecolor</i> or <i>ec</i>	mpl color spec, None, 'none', or 'auto'
<i>facecolor</i> or <i>fc</i>	mpl color spec, or None for default, or 'none' for no color
<i>figure</i>	a <i>matplotlib.figure.Figure</i> instance
<i>fill</i>	[True False]
<i>gid</i>	an id string
<i>hatch</i>	['/' '\' ' ' '-' '+' 'x' 'o' 'O' '.' '*']
<i>joinstyle</i>	['miter' 'round' 'bevel']
<i>label</i>	string or anything printable with '%s' conversion.
<i>linestyle</i> or <i>ls</i>	['solid' 'dashed', 'dashdot', 'dotted' (offset, on-off-dash-seq) '-' '--' '-.' ':' 'None']
<i>linewidth</i> or <i>lw</i>	float or None for default
<i>path_effects</i>	unknown
<i>picker</i>	[None float boolean callable]
<i>rasterized</i>	[True False None]
<i>sketch_params</i>	unknown
<i>snap</i>	unknown
<i>transform</i>	<i>Transform</i> instance
<i>url</i>	a url string
<i>visible</i>	[True False]
<i>zorder</i>	any number

draw(*renderer*)

get_patch_transform()

get_path()

class matplotlib.patches.Wedge(*center*, *r*, *theta1*, *theta2*, *width*=None, ***kwargs*)

Bases: *matplotlib.patches.Patch*

Wedge shaped patch.

Draw a wedge centered at *x*, *y* center with radius *r* that sweeps *theta1* to *theta2* (in degrees). If *width*

is given, then a partial wedge is drawn from inner radius $r - width$ to outer radius r .

Valid kwargs are:

Property	Description
<i>agg_filter</i>	unknown
<i>alpha</i>	float or None
<i>animated</i>	[True False]
<i>antialiased</i> or <i>aa</i>	[True False] or None for default
<i>axes</i>	an <i>Axes</i> instance
<i>capstyle</i>	['butt' 'round' 'projecting']
<i>clip_box</i>	a <i>matplotlib.transforms.Bbox</i> instance
<i>clip_on</i>	[True False]
<i>clip_path</i>	[(<i>Path</i> , <i>Transform</i>) <i>Patch</i> None]
<i>color</i>	matplotlib color spec
<i>contains</i>	a callable function
<i>edgecolor</i> or <i>ec</i>	mpl color spec, None, 'none', or 'auto'
<i>facecolor</i> or <i>fc</i>	mpl color spec, or None for default, or 'none' for no color
<i>figure</i>	a <i>matplotlib.figure.Figure</i> instance
<i>fill</i>	[True False]
<i>gid</i>	an id string
<i>hatch</i>	['/' '\' ' ' '-' '+' 'x' 'o' 'O' '.' '*']
<i>joinstyle</i>	['miter' 'round' 'bevel']
<i>label</i>	string or anything printable with '%s' conversion.
<i>linestyle</i> or <i>ls</i>	['solid' 'dashed', 'dashdot', 'dotted' (offset, on-off-dash-seq) '-' '--' '-.' ':' 'None']
<i>linewidth</i> or <i>lw</i>	float or None for default
<i>path_effects</i>	unknown
<i>picker</i>	[None float boolean callable]
<i>rasterized</i>	[True False None]
<i>sketch_params</i>	unknown
<i>snap</i>	unknown
<i>transform</i>	<i>Transform</i> instance
<i>url</i>	a url string
<i>visible</i>	[True False]
<i>zorder</i>	any number

get_path()

set_center(*center*)

set_radius(*radius*)

set_theta1(*theta1*)

`set_theta2(theta2)`

`set_width(width)`

`class matplotlib.patches.YAArrow`(*figure*, *xytip*, *xybase*, *width=4*, *frac=0.1*, *headwidth=12*, ***kwargs*)

Bases: `matplotlib.patches.Patch`

Yet another arrow class.

This is an arrow that is defined in display space and has a tip at *x1*, *y1* and a base at *x2*, *y2*.

Constructor arguments:

xytip (*x*, *y*) location of arrow tip

xybase (*x*, *y*) location the arrow base mid point

figure The `Figure` instance (fig.dpi)

width The width of the arrow in points

frac The fraction of the arrow length occupied by the head

headwidth The width of the base of the arrow head in points

Valid kwargs are:

Property	Description
<code>agg_filter</code>	unknown
<code>alpha</code>	float or None
<code>animated</code>	[True False]
<code>antialiased</code> or <code>aa</code>	[True False] or None for default
<code>axes</code>	an <code>Axes</code> instance
<code>capstyle</code>	['butt' 'round' 'projecting']
<code>clip_box</code>	a <code>matplotlib.transforms.Bbox</code> instance
<code>clip_on</code>	[True False]
<code>clip_path</code>	[(<code>Path</code> , <code>Transform</code>) <code>Patch</code> None]
<code>color</code>	matplotlib color spec
<code>contains</code>	a callable function
<code>edgecolor</code> or <code>ec</code>	mpl color spec, None, 'none', or 'auto'
<code>facecolor</code> or <code>fc</code>	mpl color spec, or None for default, or 'none' for no color
<code>figure</code>	a <code>matplotlib.figure.Figure</code> instance
<code>fill</code>	[True False]
<code>gid</code>	an id string
<code>hatch</code>	['/' '\' ' ' '-' '+' 'x' 'o' 'O' '.' '*']
<code>joinstyle</code>	['miter' 'round' 'bevel']
<code>label</code>	string or anything printable with '%s' conversion.
<code>linestyle</code> or <code>ls</code>	['solid' 'dashed', 'dashdot', 'dotted' (offset, on-off-dash-seq) '-' '--' '-.' ':' 'None']
<code>linewidth</code> or <code>lw</code>	float or None for default

Continued on

Table 41.16 – continued from previous page

Property	Description
<i>path_effects</i>	unknown
<i>picker</i>	[None float boolean callable]
<i>rasterized</i>	[True False None]
<i>sketch_params</i>	unknown
<i>snap</i>	unknown
<i>transform</i>	<i>Transform</i> instance
<i>url</i>	a url string
<i>visible</i>	[True False]
<i>zorder</i>	any number

get_patch_transform()

get_path()

getpoints(*x1*, *y1*, *x2*, *y2*, *k*)

For line segment defined by (*x1*, *y1*) and (*x2*, *y2*) return the points on the line that is perpendicular to the line and intersects (*x2*, *y2*) and the distance from (*x2*, *y2*) of the returned points is *k*.

matplotlib.patches.bbox_artist(*artist*, *renderer*, *props=None*, *fill=True*)

This is a debug function to draw a rectangle around the bounding box returned by [get_window_extent\(\)](#) of an artist, to test whether the artist is returning the correct bbox.

props is a dict of rectangle props with the additional property ‘pad’ that sets the padding around the bbox in points.

matplotlib.patches.draw_bbox(*bbox*, *renderer*, *color='k'*, *trans=None*)

This is a debug function to draw a rectangle around the bounding box returned by [get_window_extent\(\)](#) of an artist, to test whether the artist is returning the correct bbox.

42.1 matplotlib.path

A module for dealing with the polylines used throughout matplotlib.

The primary class for polyline handling in matplotlib is *Path*. Almost all vector drawing makes use of Paths somewhere in the drawing pipeline.

Whilst a *Path* instance itself cannot be drawn, there exists *Artist* subclasses which can be used for convenient Path visualisation - the two most frequently used of these are *PathPatch* and *PathCollection*.

```
class matplotlib.path.Path(vertices, codes=None, _interpolation_steps=1, closed=False, read-only=False)
```

Bases: object

Path represents a series of possibly disconnected, possibly closed, line and curve segments.

The underlying storage is made up of two parallel numpy arrays:

- *vertices*: an Nx2 float array of vertices
- *codes*: an N-length uint8 array of vertex types

These two arrays always have the same length in the first dimension. For example, to represent a cubic curve, you must provide three vertices as well as three codes CURVE3.

The code types are:

- **STOP** [1 vertex (ignored)] A marker for the end of the entire path (currently not required and ignored)
- **MOVETO** [1 vertex] Pick up the pen and move to the given vertex.
- **LINETO** [1 vertex] Draw a line from the current position to the given vertex.
- **CURVE3** [1 control point, 1 endpoint] Draw a quadratic Bezier curve from the current position, with the given control point, to the given end point.
- **CURVE4** [2 control points, 1 endpoint] Draw a cubic Bezier curve from the current position, with the given control points, to the given end point.
- **CLOSEPOLY** [1 vertex (ignored)] Draw a line segment to the start point of the current polyline.

Users of Path objects should not access the vertices and codes arrays directly. Instead, they should use `iter_segments()` or `cleaned()` to get the vertex/code pairs. This is important, since many *Path* objects, as an optimization, do not store a *codes* at all, but have a default one provided for them by `iter_segments()`.

Note: The vertices and codes arrays should be treated as immutable – there are a number of optimizations and assumptions made up front in the constructor that will not change when the data changes.

Create a new path with the given vertices and codes.

Parameters `vertices` : array_like

The (n, 2) float array, masked array or sequence of pairs representing the vertices of the path.

If *vertices* contains masked values, they will be converted to NaNs which are then handled correctly by the Agg PathIterator and other consumers of path data, such as `iter_segments()`.

codes : {None, array_like}, optional

n-length array integers representing the codes of the path. If not None, codes must be the same length as vertices. If None, *vertices* will be treated as a series of line segments.

`_interpolation_steps` : int, optional

Used as a hint to certain projections, such as Polar, that this path should be linearly interpolated immediately before drawing. This attribute is primarily an implementation detail and is not intended for public use.

closed : bool, optional

If *codes* is None and closed is True, vertices will be treated as line segments of a closed polygon.

readonly : bool, optional

Makes the path behave in an immutable way and sets the vertices and codes as read-only arrays.

CLOSEPOLY = 79

CURVE3 = 3

CURVE4 = 4

LINETO = 2

MOVETO = 1

NUM_VERTICES_FOR_CODE = {0: 1, 1: 1, 2: 1, 3: 2, 4: 3, 79: 1}

A dictionary mapping Path codes to the number of vertices that the code expects.

STOP = 0

classmethod arc(*theta1, theta2, n=None, is_wedge=False*)

Return an arc on the unit circle from angle *theta1* to angle *theta2* (in degrees).

If *n* is provided, it is the number of spline segments to make. If *n* is not provided, the number of spline segments is determined based on the delta between *theta1* and *theta2*.

Masionobe, L. 2003. [Drawing an elliptical arc using polylines, quadratic or cubic Bezier curves.](#)

classmethod circle(*center=(0.0, 0.0), radius=1.0, readonly=False*)

Return a Path representing a circle of a given radius and center.

Parameters center : pair of floats

The center of the circle. Default (0, 0).

radius : float

The radius of the circle. Default is 1.

readonly : bool

Whether the created path should have the “readonly” argument set when creating the Path instance.

Notes

The circle is approximated using cubic Bezier curves. This uses 8 splines around the circle using the approach presented here:

Lancaster, Don. [Approximating a Circle or an Ellipse Using Four Bezier Cubic Splines.](#)

cleaned(*transform=None, remove_nans=False, clip=None, quantize=False, simplify=False, curves=False, stroke_width=1.0, snap=False, sketch=None*)

Cleans up the path according to the parameters returning a new Path instance.

See also:

See [iter_segments\(\)](#) for details of the keyword arguments.

Returns Path instance with cleaned up vertices and codes.

clip_to_bbox(*bbox, inside=True*)

Clip the path to the given bounding box.

The path must be made up of one or more closed polygons. This algorithm will not behave correctly for unclosed paths.

If *inside* is `True`, clip to the inside of the box, otherwise to the outside of the box.

code_type

alias of `uint8`

codes

The list of codes in the *Path* as a 1-D numpy array. Each code is one of *STOP*, *MOVETO*, *LINETO*, *CURVE3*, *CURVE4* or *CLOSEPOLY*. For codes that correspond to more than one vertex (*CURVE3* and *CURVE4*), that code will be repeated so that the length of `self.vertices` and `self.codes` is always the same.

contains_path(*path*, *transform=None*)

Returns whether this (closed) path completely contains the given path.

If *transform* is not `None`, the path will be transformed before performing the test.

contains_point(*point*, *transform=None*, *radius=0.0*)

Returns whether the (closed) path contains the given point.

If *transform* is not `None`, the path will be transformed before performing the test.

radius allows the path to be made slightly larger or smaller.

contains_points(*points*, *transform=None*, *radius=0.0*)

Returns a bool array which is `True` if the (closed) path contains the corresponding point.

If *transform* is not `None`, the path will be transformed before performing the test.

radius allows the path to be made slightly larger or smaller.

copy()

Returns a shallow copy of the *Path*, which will share the vertices and codes with the source *Path*.

deepcopy(*memo=None*)

Returns a deepcopy of the *Path*. The *Path* will not be readonly, even if the source *Path* is.

get_extents(*transform=None*)

Returns the extents (*xmin*, *ymin*, *xmax*, *ymax*) of the path.

Unlike computing the extents on the *vertices* alone, this algorithm will take into account the curves and deal with control points appropriately.

has_nonfinite

`True` if the vertices array has nonfinite values.

classmethod hatch(*hatchpattern*, *density=6*)

Given a hatch specifier, *hatchpattern*, generates a *Path* that can be used in a repeated hatching pattern. *density* is the number of lines per unit square.

interpolated(*steps*)

Returns a new path resampled to length *N* x *steps*. Does not currently handle interpolating curves.

intersects_bbox(*bbox*, *filled=True*)

Returns `True` if this path intersects a given *Bbox*.

filled, when `True`, treats the path as if it was filled. That is, if one path completely encloses the other, `intersects_path()` will return `True`.

intersects_path(*other*, *filled=True*)

Returns `True` if this path intersects another given path.

filled, when `True`, treats the paths as if they were filled. That is, if one path completely encloses the other, `intersects_path()` will return `True`.

iter_segments(*transform=None*, *remove_nans=True*, *clip=None*, *snap=False*,
stroke_width=1.0, *simplify=None*, *curves=True*, *sketch=None*)

Iterates over all of the curve segments in the path. Each iteration returns a 2-tuple (*vertices*, *code*), where *vertices* is a sequence of 1 - 3 coordinate pairs, and *code* is one of the `Path` codes.

Additionally, this method can provide a number of standard cleanups and conversions to the path.

Parameters transform : None or `Transform` instance

If not `None`, the given affine transformation will be applied to the path.

remove_nans : {`False`, `True`}, optional

If `True`, will remove all NaNs from the path and insert MOVETO commands to skip over them.

clip : None or sequence, optional

If not `None`, must be a four-tuple (`x1`, `y1`, `x2`, `y2`) defining a rectangle in which to clip the path.

snap : None or `bool`, optional

If `None`, auto-snap to pixels, to reduce fuzziness of rectilinear lines. If `True`, force snapping, and if `False`, don't snap.

stroke_width : `float`, optional

The width of the stroke being drawn. Needed as a hint for the snapping algorithm.

simplify : None or `bool`, optional

If True, perform simplification, to remove vertices that do not affect the appearance of the path. If `False`, perform no simplification. If `None`, use the `should_simplify` member variable.

curves : {`True`, `False`}, optional

If `True`, curve segments will be returned as curve segments. If `False`, all curves will be converted to line segments.

sketch : None or sequence, optional

If not `None`, must be a 3-tuple of the form (`scale`, `length`, `randomness`), representing the sketch parameters.

classmethod `make_compound_path(*args)`

Make a compound path from a list of *Path* objects.

classmethod `make_compound_path_from_polys(XY)`

Make a compound path object to draw a number of polygons with equal numbers of sides *XY* is a (numpolys x numsides x 2) numpy array of vertices. Return object is a *Path*

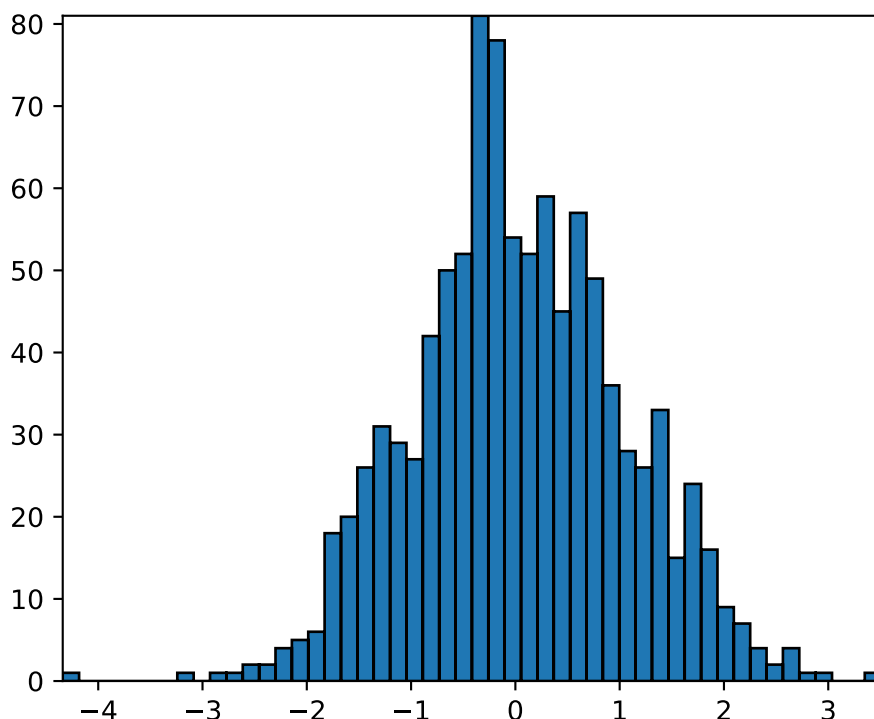

readonly

True if the *Path* is read-only.

should_simplify

True if the vertices array should be simplified.

simplify_threshold

The fraction of a pixel difference below which vertices will be simplified out.

to_polygons(*transform=None, width=0, height=0, closed_only=True*)

Convert this path to a list of polygons or polylines. Each polygon/polyline is an *Nx2* array of vertices. In other words, each polygon has no *MOVETO* instructions or curves. This is useful for displaying in backends that do not support compound paths or Bezier curves, such as GDK.

If *width* and *height* are both non-zero then the lines will be simplified so that vertices outside of (0, 0), (width, height) will be clipped.

If *closed_only* is *True* (default), only closed polygons, with the last point being the same as the first point, will be returned. Any unclosed polylines in the path will be explicitly closed. If

closed_only is `False`, any unclosed polygons in the path will be returned as unclosed polygons, and the closed polygons will be returned explicitly closed by setting the last point to the same as the first point.

transformed(*transform*)

Return a transformed copy of the path.

See also:

matplotlib.transforms.TransformPath A specialized path class that will cache the transformed result and automatically update when the transform changes.

classmethod unit_circle()

Return the readonly *Path* of the unit circle.

For most cases, *Path.circle*() will be what you want.

classmethod unit_circle_righthalf()

Return a *Path* of the right half of a unit circle. The circle is approximated using cubic Bezier curves. This uses 4 splines around the circle using the approach presented here:

Lancaster, Don. [Approximating a Circle or an Ellipse Using Four Bezier Cubic Splines](#).

classmethod unit_rectangle()

Return a *Path* instance of the unit rectangle from (0, 0) to (1, 1).

classmethod unit_regular_asterisk(*numVertices*)

Return a *Path* for a unit regular asterisk with the given *numVertices* and radius of 1.0, centered at (0, 0).

classmethod unit_regular_polygon(*numVertices*)

Return a *Path* instance for a unit regular polygon with the given *numVertices* and radius of 1.0, centered at (0, 0).

classmethod unit_regular_star(*numVertices*, *innerCircle=0.5*)

Return a *Path* for a unit regular star with the given *numVertices* and radius of 1.0, centered at (0, 0).

vertices

The list of vertices in the *Path* as an Nx2 numpy array.

classmethod wedge(*theta1*, *theta2*, *n=None*)

Return a wedge of the unit circle from angle *theta1* to angle *theta2* (in degrees).

If *n* is provided, it is the number of spline segments to make. If *n* is not provided, the number of spline segments is determined based on the delta between *theta1* and *theta2*.

matplotlib.path.get_path_collection_extents(*master_transform*, *paths*, *transforms*, *offsets*, *offset_transform*)

Given a sequence of *Path* objects, *Transform* objects and offsets, as found in a *PathCollection*, returns the bounding box that encapsulates all of them.

master_transform is a global transformation to apply to all paths

paths is a sequence of *Path* instances.

transforms is a sequence of *Affine2D* instances.

offsets is a sequence of (x, y) offsets (or an Nx2 array)

offset_transform is a *Affine2D* to apply to the offsets before applying the offset to the path.

The way that *paths*, *transforms* and *offsets* are combined follows the same method as for collections. Each is iterated over independently, so if you have 3 paths, 2 transforms and 1 offset, their combinations are as follows:

(A, A, A), (B, B, A), (C, A, A)

`matplotlib.path.get_paths_extents(paths, transforms=[])`

Given a sequence of *Path* objects and optional *Transform* objects, returns the bounding box that encapsulates all of them.

paths is a sequence of *Path* instances.

transforms is an optional sequence of *Affine2D* instances to apply to each path.

43.1 matplotlib.patheffects

Defines classes for path effects. The path effects are supported in *Text*, *Line2D* and *Patch*.

class `matplotlib.patheffects.AbstractPathEffect` (*offset=(0.0, 0.0)*)

Bases: `object`

A base class for path effects.

Subclasses should override the `draw_path` method to add effect functionality.

Parameters `offset` : pair of floats

The offset to apply to the path, measured in points.

draw_path (*renderer, gc, tpath, affine, rgbFace=None*)

Derived should override this method. The arguments are the same as `matplotlib.backend_bases.RendererBase.draw_path()` except the first argument is a renderer.

class `matplotlib.patheffects.Normal` (*offset=(0.0, 0.0)*)

Bases: `matplotlib.patheffects.AbstractPathEffect`

The “identity” PathEffect.

The Normal PathEffect’s sole purpose is to draw the original artist with no special path effect.

Parameters `offset` : pair of floats

The offset to apply to the path, measured in points.

class `matplotlib.patheffects.PathEffectRenderer` (*path_effects, renderer*)

Bases: `matplotlib.backend_bases.RendererBase`

Implements a `Renderer` which contains another `renderer`.

This proxy then intercepts draw calls, calling the appropriate `AbstractPathEffect` draw method.

Note: Not all methods have been overridden on this `RendererBase` subclass. It may be necessary to add further methods to extend the `PathEffects` capabilities further.

Parameters `path_effects` : iterable of *AbstractPathEffect*

The path effects which this renderer represents.

renderer : *matplotlib.backend_bases.RendererBase* instance

copy_with_path_effect(*path_effects*)

draw_markers(*gc, marker_path, marker_trans, path, *args, **kwargs*)

draw_path(*gc, tpath, affine, rgbFace=None*)

draw_path_collection(*gc, master_transform, paths, *args, **kwargs*)

new_gc()

points_to_pixels(*points*)

class *matplotlib.patheffects.PathPatchEffect*(*offset=(0, 0), **kwargs*)

Bases: *matplotlib.patheffects.AbstractPathEffect*

Draws a *PathPatch* instance whose *Path* comes from the original *PathEffect* artist.

Parameters `offset` : pair of floats

The offset to apply to the path, in points.

****kwargs** :

All keyword arguments are passed through to the *PathPatch* constructor. The properties which cannot be overridden are “*path*”, “*clip_box*” “*transform*” and “*clip_path*”.

draw_path(*renderer, gc, tpath, affine, rgbFace*)

class *matplotlib.patheffects.SimpleLineShadow*(*offset=(2, -2), shadow_color='k', alpha=0.3, rho=0.3, **kwargs*)

Bases: *matplotlib.patheffects.AbstractPathEffect*

A simple shadow via a line.

Parameters `offset` : pair of floats

The offset to apply to the path, in points.

shadow_color : color

The shadow color. Default is black. A value of *None* takes the original artist’s color with a scale factor of *rho*.

alpha : float

The alpha transparency of the created shadow patch. Default is 0.3.

rho : float

A scale factor to apply to the `rgbFace` color if `shadow_rgbFace` is `None`. Default is 0.3.

****kwargs**

Extra keywords are stored and passed through to `AbstractPathEffect._update_gc()`.

draw_path(*renderer, gc, tpath, affine, rgbFace*)

Overrides the standard `draw_path` to add the shadow offset and necessary color changes for the shadow.

class `matplotlib.patheffects.SimplePatchShadow`(*offset=(2, -2), shadow_rgbFace=None, alpha=None, rho=0.3, **kwargs*)

Bases: `matplotlib.patheffects.AbstractPathEffect`

A simple shadow via a filled patch.

Parameters **offset** : pair of floats

The offset of the shadow in points.

shadow_rgbFace : color

The shadow color.

alpha : float

The alpha transparency of the created shadow patch. Default is 0.3. <http://matplotlib.1069221.n5.nabble.com/path-effects-question-td27630.html>

rho : float

A scale factor to apply to the `rgbFace` color if `shadow_rgbFace` is not specified. Default is 0.3.

****kwargs**

Extra keywords are stored and passed through to `AbstractPathEffect._update_gc()`.

draw_path(*renderer, gc, tpath, affine, rgbFace*)

Overrides the standard `draw_path` to add the shadow offset and necessary color changes for the shadow.

class `matplotlib.patheffects.Stroke`(*offset=(0, 0), **kwargs*)

Bases: `matplotlib.patheffects.AbstractPathEffect`

A line based `PathEffect` which re-draws a stroke.

The path will be stroked with its `gc` updated with the given keyword arguments, i.e., the keyword arguments should be valid `gc` parameter values.

draw_path(*renderer, gc, tpath, affine, rgbFace*)

draw the path with updated `gc`.

```
class matplotlib.patheffects.withSimplePatchShadow(offset=(2, -2),
                                                    shadow_rgbFace=None, alpha=
                                                    pha=None, rho=0.3, **kwargs)
```

Bases: `matplotlib.patheffects.SimplePatchShadow`

Adds a simple `SimplePatchShadow` and then draws the original Artist to avoid needing to call `Normal`.

Parameters offset : pair of floats

The offset of the shadow in points.

shadow_rgbFace : color

The shadow color.

alpha : float

The alpha transparency of the created shadow patch. Default is 0.3. <http://matplotlib.1069221.n5.nabble.com/path-effects-question-td27630.html>

rho : float

A scale factor to apply to the rgbFace color if shadow_rgbFace is not specified. Default is 0.3.

****kwargs**

Extra keywords are stored and passed through to `AbstractPathEffect._update_gc()`.

draw_path(*renderer, gc, tpath, affine, rgbFace*)

```
class matplotlib.patheffects.withStroke(offset=(0, 0), **kwargs)
```

Bases: `matplotlib.patheffects.Stroke`

Adds a simple `Stroke` and then draws the original Artist to avoid needing to call `Normal`.

The path will be stroked with its gc updated with the given keyword arguments, i.e., the keyword arguments should be valid gc parameter values.

draw_path(*renderer, gc, tpath, affine, rgbFace*)

44.1 matplotlib.projections

class matplotlib.projections.ProjectionRegistry

Bases: object

Manages the set of projections available to the system.

get_projection_class(*name*)

Get a projection class from its *name*.

get_projection_names()

Get a list of the names of all projections currently registered.

register(**projections*)

Register a new set of projection(s).

matplotlib.projections.**get_projection_class**(*projection=None*)

Get a projection class from its name.

If *projection* is None, a standard rectilinear projection is returned.

matplotlib.projections.**get_projection_names**()

Get a list of acceptable projection names.

matplotlib.projections.**process_projection_requirements**(*figure, *args, **kwargs*)

Handle the args/kwargs to for add_axes/add_subplot/gca, returning:

(axes_proj_class, proj_class_kwargs, proj_stack_key)

Which can be used for new axes initialization/identification.

Note: **kwargs** is modified in place.

44.2 matplotlib.projections.polar

class matplotlib.projections.polar.**InvertedPolarTransform**(*axis=None*,
use_rmin=True)

Bases: *matplotlib.transforms.Transform*

The inverse of the polar transform, mapping Cartesian coordinate space x and y back to θ and r .

inverted()

Return the corresponding inverse transformation.

The return value of this method should be treated as temporary. An update to *self* does not cause a corresponding update to its inverted copy.

```
x === self.inverted().transform(self.transform(x))
```

transform_non_affine(*xy*)

Performs only the non-affine part of the transformation.

`transform(values)` is always equivalent to `transform_affine(transform_non_affine(values))`.

In non-affine transformations, this is generally equivalent to `transform(values)`. In affine transformations, this is always a no-op.

Accepts a numpy array of shape (N x `input_dims`) and returns a numpy array of shape (N x `output_dims`).

Alternatively, accepts a numpy array of length `input_dims` and returns a numpy array of length `output_dims`.

class matplotlib.projections.polar.**PolarAffine**(*scale_transform*, *limits*)

Bases: *matplotlib.transforms.Affine2DBase*

The affine part of the polar projection. Scales the output so that maximum radius rests on the edge of the axes circle.

limits is the view limit of the data. The only part of its bounds that is used is `y`max (for the radius maximum). The θ range is always fixed to (0, 2pi).

get_matrix()

Get the Affine transformation array for the affine part of this transform.

class matplotlib.projections.polar.**PolarAxes**(**args*, ***kwargs*)

Bases: *matplotlib.axes._axes.Axes*

A polar graph projection, where the input dimensions are θ , r .

θ starts pointing east and goes anti-clockwise.

class **InvertedPolarTransform**(*axis=None*, *use_rmin=True*)

Bases: *matplotlib.transforms.Transform*

The inverse of the polar transform, mapping Cartesian coordinate space x and y back to θ and r .

inverted()

Return the corresponding inverse transformation.

The return value of this method should be treated as temporary. An update to *self* does not cause a corresponding update to its inverted copy.

```
x === self.inverted().transform(self.transform(x))
```

transform_non_affine(*xy*)

Performs only the non-affine part of the transformation.

`transform(values)` is always equivalent to `transform_affine(transform_non_affine(values))`.

In non-affine transformations, this is generally equivalent to `transform(values)`. In affine transformations, this is always a no-op.

Accepts a numpy array of shape (N x `input_dims`) and returns a numpy array of shape (N x `output_dims`).

Alternatively, accepts a numpy array of length `input_dims` and returns a numpy array of length `output_dims`.

class PolarAffine(*scale_transform, limits*)

Bases: `matplotlib.transforms.Affine2DBase`

The affine part of the polar projection. Scales the output so that maximum radius rests on the edge of the axes circle.

limits is the view limit of the data. The only part of its bounds that is used is `ymin` (for the radius maximum). The theta range is always fixed to (0, 2pi).

get_matrix()

Get the Affine transformation array for the affine part of this transform.

class PolarTransform(*axis=None, use_rmin=True*)

Bases: `matplotlib.transforms.Transform`

The base polar transform. This handles projection *theta* and *r* into Cartesian coordinate space *x* and *y*, but does not perform the ultimate affine transformation into the correct position.

inverted()

Return the corresponding inverse transformation.

The return value of this method should be treated as temporary. An update to *self* does not cause a corresponding update to its inverted copy.

```
x === self.inverted().transform(self.transform(x))
```

transform_non_affine(*tr*)

Performs only the non-affine part of the transformation.

`transform(values)` is always equivalent to `transform_affine(transform_non_affine(values))`.

In non-affine transformations, this is generally equivalent to `transform(values)`. In affine transformations, this is always a no-op.

Accepts a numpy array of shape (N x `input_dims`) and returns a numpy array of shape (N x `output_dims`).

Alternatively, accepts a numpy array of length `input_dims` and returns a numpy array of length `output_dims`.

transform_path_non_affine(*path*)

Returns a path, transformed only by the non-affine part of this transform.

path: a *Path* instance.

`transform_path(path)` is equivalent to `transform_path_affine(transform_path_non_affine(va`

class RadialLocator(*base*)

Bases: *matplotlib.ticker.Locator*

Used to locate radius ticks.

Ensures that all ticks are strictly positive. For all other tasks, it delegates to the base *Locator* (which may be different depending on the scale of the *r*-axis).

class ThetaFormatter

Bases: *matplotlib.ticker.Formatter*

Used to format the *theta* tick labels. Converts the native unit of radians into degrees and adds a degree symbol.

can_pan()

Return *True* if this axes supports the pan/zoom button functionality.

For polar axes, this is slightly misleading. Both panning and zooming are performed by the same button. Panning is performed in azimuth while zooming is done along the radial.

can_zoom()

Return *True* if this axes supports the zoom box button functionality.

Polar axes do not support zoom boxes.

format_coord(*theta*, *r*)

Return a format string formatting the coordinate using Unicode characters.

get_data_ratio()

Return the aspect ratio of the data itself. For a polar plot, this should always be 1.0

get_rlabel_position()

Returns float

The theta position of the radius labels in degrees.

get_theta_direction()

Get the direction in which theta increases.

-1: Theta increases in the clockwise direction

1: Theta increases in the counterclockwise direction

get_theta_offset()

Get the offset for the location of 0 in radians.

set_rgrids(*radii*, *labels=None*, *angle=None*, *fnt=None*, ***kwargs*)

Set the radial locations and labels of the *r* grids.

The labels will appear at radial distances *radii* at the given *angle* in degrees.

labels, if not None, is a `len(radii)` list of strings of the labels to use at each radius.

If *labels* is None, the built-in formatter will be used.

Return value is a list of tuples (*line*, *label*), where *line* is *Line2D* instances and the *label* is *Text* instances.

kwargs are optional text properties for the labels:

Property	Description
<i>agg_filter</i>	unknown
<i>alpha</i>	float (0.0 transparent through 1.0 opaque)
<i>animated</i>	[True False]
<i>axes</i>	an <i>Axes</i> instance
<i>backgroundcolor</i>	any matplotlib color
<i>bbox</i>	FancyBboxPatch prop dict
<i>clip_box</i>	a <i>matplotlib.transforms.Bbox</i> instance
<i>clip_on</i>	[True False]
<i>clip_path</i>	[(<i>Path</i> , <i>Transform</i>) <i>Patch</i> None]
<i>color</i>	any matplotlib color
<i>contains</i>	a callable function
<i>family</i> or fontfamily or fontname or name	[FONTNAME 'serif' 'sans-serif' 'cursive' 'fantasy' 'monospace']
<i>figure</i>	a <i>matplotlib.figure.Figure</i> instance
<i>fontproperties</i> or font_properties	a <i>matplotlib.font_manager.FontProperties</i> instance
<i>gid</i>	an id string
<i>horizontalalignment</i> or ha	['center' 'right' 'left']
<i>label</i>	string or anything printable with '%s' conversion.
<i>linespacing</i>	float (multiple of font size)
<i>multialignment</i>	['left' 'right' 'center']
<i>path_effects</i>	unknown
<i>picker</i>	[None float boolean callable]
<i>position</i>	(x,y)
<i>rasterized</i>	[True False None]
<i>rotation</i>	[angle in degrees 'vertical' 'horizontal']
<i>rotation_mode</i>	unknown
<i>size</i> or fontsize	[size in points 'xx-small' 'x-small' 'small' 'medium' 'large' 'x-large']
<i>sketch_params</i>	unknown
<i>snap</i>	unknown
<i>stretch</i> or fontstretch	[a numeric value in range 0-1000 'ultra-condensed' 'extra-condensed' 'c
<i>style</i> or fontstyle	['normal' 'italic' 'oblique']
<i>text</i>	string or anything printable with '%s' conversion.
<i>transform</i>	<i>Transform</i> instance
<i>url</i>	a url string
<i>usetex</i>	unknown
<i>variant</i> or fontvariant	['normal' 'small-caps']
<i>verticalalignment</i> or ma or va	['center' 'top' 'bottom' 'baseline']
<i>visible</i>	[True False]

Table 44.1 – continued from

Property	Description
<i>weight</i> or fontweight	[a numeric value in range 0-1000 ‘ultralight’ ‘light’ ‘normal’ ‘regular’
<i>wrap</i>	unknown
<i>x</i>	float
<i>y</i>	float
<i>zorder</i>	any number

ACCEPTS: sequence of floats

set_rlabel_position(*value*)

Updates the theta position of the radius labels.

Parameters value : number

The angular position of the radius labels in degrees.

set_theta_direction(*direction*)

Set the direction in which theta increases.

clockwise, -1: Theta increases in the clockwise direction

counterclockwise, anticlockwise, 1: Theta increases in the counterclockwise direction

set_theta_offset(*offset*)

Set the offset for the location of 0 in radians.

set_theta_zero_location(*loc*)

Sets the location of theta’s zero. (Calls `set_theta_offset` with the correct value in radians under the hood.)

May be one of “N”, “NW”, “W”, “SW”, “S”, “SE”, “E”, or “NE”.

set_thetagrids(*angles, labels=None, frac=None, fmt=None, **kwargs*)

Set the angles at which to place the theta grids (these gridlines are equal along the theta dimension). *angles* is in degrees.

labels, if not None, is a `len(angles)` list of strings of the labels to use at each angle.

If *labels* is None, the labels will be `fmt % angle`

frac is the fraction of the polar axes radius at which to place the label (1 is the edge). e.g., 1.05 is outside the axes and 0.95 is inside the axes.

Return value is a list of tuples (*line, label*), where *line* is `Line2D` instances and the *label* is `Text` instances.

kwargs are optional text properties for the labels:

Property	Description
<i>agg_filter</i>	unknown
<i>alpha</i>	float (0.0 transparent through 1.0 opaque)

Table 44.2 – continued from

Property	Description
<i>animated</i>	[True False]
<i>axes</i>	an <i>Axes</i> instance
<i>backgroundcolor</i>	any matplotlib color
<i>bbox</i>	FancyBboxPatch prop dict
<i>clip_box</i>	a <i>matplotlib.transforms.Bbox</i> instance
<i>clip_on</i>	[True False]
<i>clip_path</i>	[(<i>Path</i> , <i>Transform</i>) <i>Patch</i> None]
<i>color</i>	any matplotlib color
<i>contains</i>	a callable function
<i>family</i> or fontfamily or fontname or name	[FONTNAME ‘serif’ ‘sans-serif’ ‘cursive’ ‘fantasy’ ‘monospace’]
<i>figure</i>	a <i>matplotlib.figure.Figure</i> instance
<i>fontproperties</i> or font_properties	a <i>matplotlib.font_manager.FontProperties</i> instance
<i>gid</i>	an id string
<i>horizontalalignment</i> or ha	[‘center’ ‘right’ ‘left’]
<i>label</i>	string or anything printable with ‘%s’ conversion.
<i>linespacing</i>	float (multiple of font size)
<i>multialignment</i>	[‘left’ ‘right’ ‘center’]
<i>path_effects</i>	unknown
<i>picker</i>	[None float boolean callable]
<i>position</i>	(x,y)
<i>rasterized</i>	[True False None]
<i>rotation</i>	[angle in degrees ‘vertical’ ‘horizontal’]
<i>rotation_mode</i>	unknown
<i>size</i> or fontsize	[size in points ‘xx-small’ ‘x-small’ ‘small’ ‘medium’ ‘large’ ‘x-large’]
<i>sketch_params</i>	unknown
<i>snap</i>	unknown
<i>stretch</i> or fontstretch	[a numeric value in range 0-1000 ‘ultra-condensed’ ‘extra-condensed’ ‘c
<i>style</i> or fontstyle	[‘normal’ ‘italic’ ‘oblique’]
<i>text</i>	string or anything printable with ‘%s’ conversion.
<i>transform</i>	<i>Transform</i> instance
<i>url</i>	a url string
<i>usetex</i>	unknown
<i>variant</i> or fontvariant	[‘normal’ ‘small-caps’]
<i>verticalalignment</i> or ma or va	[‘center’ ‘top’ ‘bottom’ ‘baseline’]
<i>visible</i>	[True False]
<i>weight</i> or fontweight	[a numeric value in range 0-1000 ‘ultralight’ ‘light’ ‘normal’ ‘regular’
<i>wrap</i>	unknown
<i>x</i>	float
<i>y</i>	float
<i>zorder</i>	any number

ACCEPTS: sequence of floats

class matplotlib.projections.polar.**PolarTransform**(*axis=None, use_rmin=True*)

Bases: [matplotlib.transforms.Transform](#)

The base polar transform. This handles projection *theta* and *r* into Cartesian coordinate space *x* and *y*, but does not perform the ultimate affine transformation into the correct position.

inverted()

Return the corresponding inverse transformation.

The return value of this method should be treated as temporary. An update to *self* does not cause a corresponding update to its inverted copy.

```
x == self.inverted().transform(self.transform(x))
```

transform_non_affine(*tr*)

Performs only the non-affine part of the transformation.

`transform(values)` is always equivalent to `transform_affine(transform_non_affine(values))`.

In non-affine transformations, this is generally equivalent to `transform(values)`. In affine transformations, this is always a no-op.

Accepts a numpy array of shape (N x `input_dims`) and returns a numpy array of shape (N x `output_dims`).

Alternatively, accepts a numpy array of length `input_dims` and returns a numpy array of length `output_dims`.

transform_path_non_affine(*path*)

Returns a path, transformed only by the non-affine part of this transform.

path: a [Path](#) instance.

`transform_path(path)` is equivalent to `transform_path_affine(transform_path_non_affine(values))`.

class matplotlib.projections.polar.**RadialLocator**(*base*)

Bases: [matplotlib.ticker.Locator](#)

Used to locate radius ticks.

Ensures that all ticks are strictly positive. For all other tasks, it delegates to the base [Locator](#) (which may be different depending on the scale of the *r*-axis).

class matplotlib.projections.polar.**ThetaFormatter**

Bases: [matplotlib.ticker.Formatter](#)

Used to format the *theta* tick labels. Converts the native unit of radians into degrees and adds a degree symbol.

45.1 matplotlib.pyplot

Provides a MATLAB-like plotting framework.

pylab combines pyplot with numpy into a single namespace. This is convenient for interactive work, but for programming it is recommended that the namespaces be kept separate, e.g.:

```
import numpy as np
import matplotlib.pyplot as plt

x = np.arange(0, 5, 0.1);
y = np.sin(x)
plt.plot(x, y)
```

`matplotlib.pyplot.acorr(x, hold=None, data=None, **kwargs)`
Plot the autocorrelation of `x`.

Parameters `x` : sequence of scalar

hold : boolean, optional, *deprecated*, default: True

detrend : callable, optional, default: `mlab.detrend_none`

`x` is detrended by the `detrend` callable. Default is no normalization.

normed : boolean, optional, default: True

if True, input vectors are normalised to unit length.

usevlines : boolean, optional, default: True

if True, `Axes.vlines` is used to plot the vertical lines from the origin to the `acorr`. Otherwise, `Axes.plot` is used.

maxlags : integer, optional, default: 10

number of lags to show. If None, will return all $2 * \text{len}(x) - 1$ lags.

Returns (`lags`, `c`, `line`, `b`) : where:

- `lags` are a length $2 * \text{maxlags} + 1$ lag vector.
- `c` is the $2 * \text{maxlags} + 1$ auto correlation vector

- `line` is a `Line2D` instance returned by `plot`.
- `b` is the x-axis.

Other Parameters `linestyle` : `Line2D` prop, optional, default: None

Only used if `usevlines` is False.

marker : string, optional, default: 'o'

Notes

The cross correlation is performed with `numpy.correlate()` with `mode = 2`.

Examples

`xcorr` is top graph, and `acorr` is bottom graph.

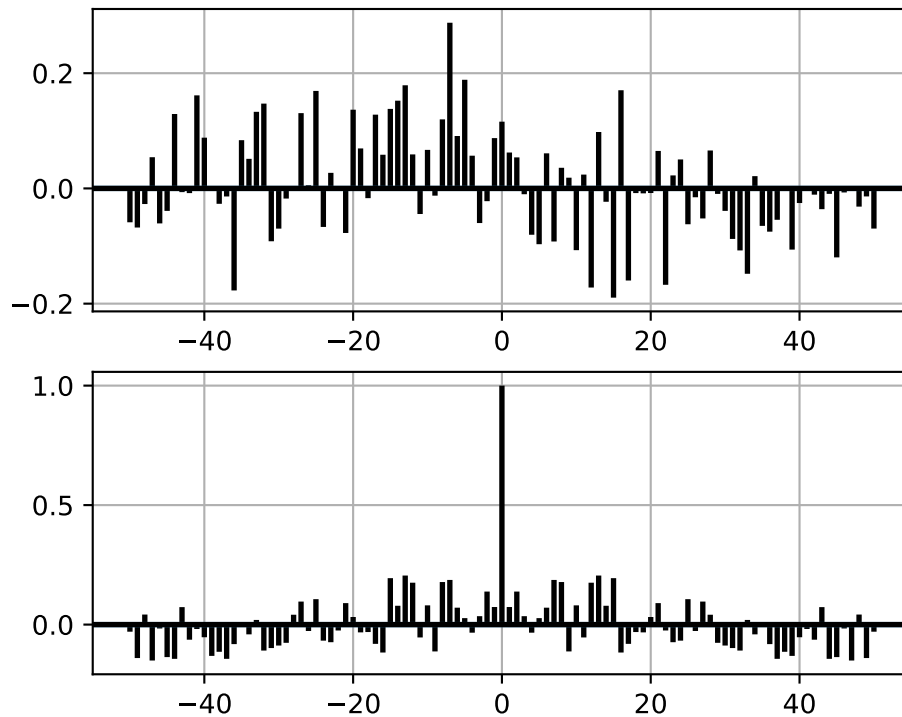

Note: In addition to the above described arguments, this function can take a **data** keyword argument. If such a **data** argument is given, the following arguments are replaced by `data[<arg>]`:

- All arguments with the following names: 'x'.
-

`matplotlib.pyplot.angle_spectrum(x, Fs=None, Fc=None, window=None, pad_to=None, sides=None, hold=None, data=None, **kwargs)`

Plot the angle spectrum.

Call signature:

```
angle_spectrum(x, Fs=2, Fc=0, window=mlab.window_hanning,
              pad_to=None, sides='default', **kwargs)
```

Compute the angle spectrum (wrapped phase spectrum) of x . Data is padded to a length of pad_to and the windowing function $window$ is applied to the signal.

Parameters x : 1-D array or sequence

Array or sequence containing the data

Fs : scalar

The sampling frequency (samples per time unit). It is used to calculate the Fourier frequencies, `freqs`, in cycles per time unit. The default value is 2.

window : callable or ndarray

A function or a vector of length $NFFT$. To create window vectors see `window_hanning()`, `window_none()`, `numpy.blackman()`, `numpy.hamming()`, `numpy.bartlett()`, `scipy.signal()`, `scipy.signal.get_window()`, etc. The default is `window_hanning()`. If a function is passed as the argument, it must take a data segment as an argument and return the windowed version of the segment.

sides : ['default' | 'onesided' | 'twosided']

Specifies which sides of the spectrum to return. Default gives the default behavior, which returns one-sided for real data and both for complex data. 'onesided' forces the return of a one-sided spectrum, while 'twosided' forces two-sided.

pad_to : integer

The number of points to which the data segment is padded when performing the FFT. While not increasing the actual resolution of the spectrum (the minimum distance between resolvable peaks), this can give more points in the plot, allowing for more detail. This corresponds to the n parameter in the call to `fft()`. The default is `None`, which sets pad_to equal to the length of the input signal (i.e. no padding).

Fc : integer

The center frequency of x (defaults to 0), which offsets the x extents of the plot to reflect the frequency range used when a signal is acquired and then filtered and downsampled to baseband.

****kwargs** :

Keyword arguments control the [Line2D](#) properties:

Property	Description
<i>agg_filter</i>	unknown
<i>alpha</i>	float (0.0 transparent through 1.0 opaque)
<i>animated</i>	[True False]
<i>antialiased</i> or <i>aa</i>	[True False]
<i>axes</i>	an <i>Axes</i> instance
<i>clip_box</i>	a <i>matplotlib.transforms.Bbox</i> instance
<i>clip_on</i>	[True False]
<i>clip_path</i>	[(<i>Path</i> , <i>Transform</i>) <i>Patch</i> None]
<i>color</i> or <i>c</i>	any matplotlib color
<i>contains</i>	a callable function
<i>dash_capstyle</i>	['butt' 'round' 'projecting']
<i>dash_joinstyle</i>	['miter' 'round' 'bevel']
<i>dashes</i>	sequence of on/off ink in points
<i>drawstyle</i>	['default' 'steps' 'steps-pre' 'steps-mid' 'steps-post']
<i>figure</i>	a <i>matplotlib.figure.Figure</i> instance
<i>fillstyle</i>	['full' 'left' 'right' 'bottom' 'top' 'none']
<i>gid</i>	an id string
<i>label</i>	string or anything printable with '%s' conversion.
<i>linestyle</i> or <i>ls</i>	['solid' 'dashed', 'dashdot', 'dotted' (offset, on-off-dash-seq) '-' '--' '-.' ' ']
<i>linewidth</i> or <i>lw</i>	float value in points
<i>marker</i>	<i>A valid marker style</i>
<i>markeredgecolor</i> or <i>mec</i>	any matplotlib color
<i>markeredgewidth</i> or <i>mew</i>	float value in points
<i>markerfacecolor</i> or <i>mfc</i>	any matplotlib color
<i>markerfacecoloralt</i> or <i>mfcalt</i>	any matplotlib color
<i>markersize</i> or <i>ms</i>	float
<i>markevery</i>	[None int length-2 tuple of int slice list/array of int float length-2 tuple of float]
<i>path_effects</i>	unknown
<i>picker</i>	float distance in points or callable pick function <code>fn(artist, event)</code>
<i>pickradius</i>	float distance in points
<i>rasterized</i>	[True False None]
<i>sketch_params</i>	unknown
<i>snap</i>	unknown
<i>solid_capstyle</i>	['butt' 'round' 'projecting']
<i>solid_joinstyle</i>	['miter' 'round' 'bevel']
<i>transform</i>	a <i>matplotlib.transforms.Transform</i> instance
<i>url</i>	a url string
<i>visible</i>	[True False]
<i>xdata</i>	1D array
<i>ydata</i>	1D array
<i>zorder</i>	any number

Returns spectrum : 1-D array

The values for the angle spectrum in radians (real valued)

freqs : 1-D array

The frequencies corresponding to the elements in *spectrum*

line : a *Line2D* instance

The line created by this function

See also:

magnitude_spectrum() *angle_spectrum()* plots the magnitudes of the corresponding frequencies.

phase_spectrum() *phase_spectrum()* plots the unwrapped version of this function.

specgram() *specgram()* can plot the angle spectrum of segments within the signal in a colormap.

In addition to the above described arguments, this function can take a **data** keyword argument. If such a **data** argument is given, the following arguments are replaced by **data[<arg>]**: * All arguments with the following names: 'x'.

Examples

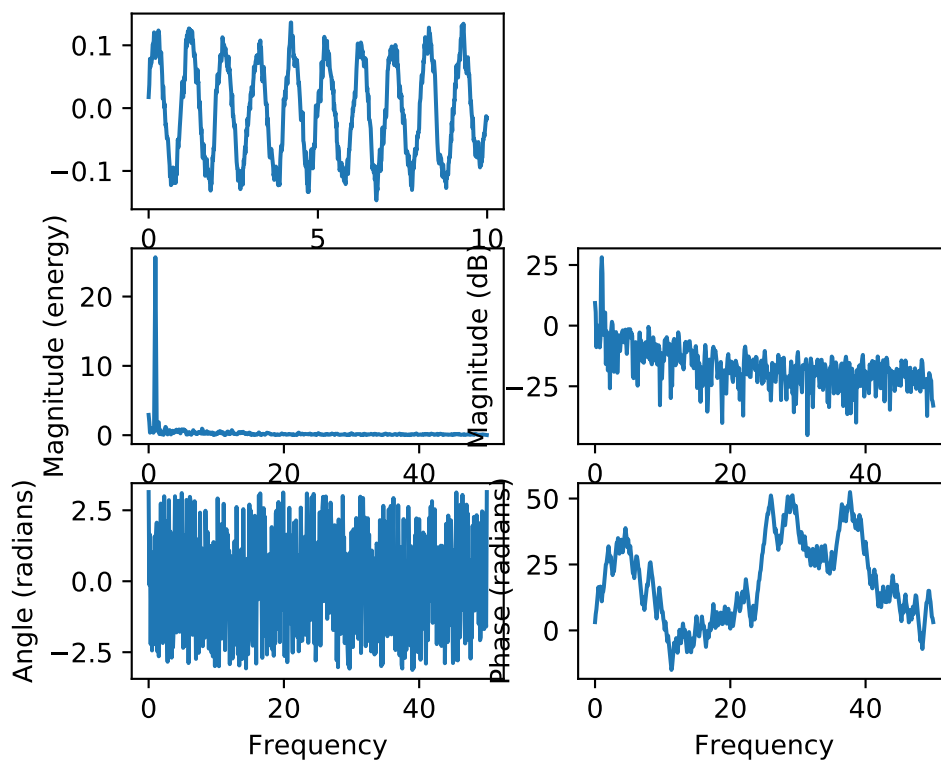

`matplotlib.pyplot.annotate(*args, **kwargs)`

Annotate the point *xy* with text *s*.

Additional kwargs are passed to *Text*.

Parameters s : str

The text of the annotation

xy : iterable

Length 2 sequence specifying the (x,y) point to annotate

xytext : iterable, optional

Length 2 sequence specifying the (x,y) to place the text at. If None, defaults to xy.

xycoords : str, Artist, Transform, callable or tuple, optional

The coordinate system that xy is given in.

For a str the allowed values are:

Property	Description
'figure points'	points from the lower left of the figure
'figure pixels'	pixels from the lower left of the figure
'figure fraction'	fraction of figure from lower left
'axes points'	points from lower left corner of axes
'axes pixels'	pixels from lower left corner of axes
'axes fraction'	fraction of axes from lower left
'data'	use the coordinate system of the object being annotated (default)
'polar'	(theta,r) if not native 'data' coordinates

If a *Artist* object is passed in the units are fraction if it's bounding box.

If a *Transform* object is passed in use that to transform xy to screen coordinates

If a callable it must take a *RendererBase* object as input and return a *Transform* or *Bbox* object

If a tuple must be length 2 tuple of str, Artist, Transform or callable objects. The first transform is used for the x coordinate and the second for y.

See *Advanced Annotation* for more details.

Defaults to 'data'

textcoords : str, Artist, Transform, callable or tuple, optional

The coordinate system that xytext is given, which may be different than the coordinate system used for xy.

All xycoords values are valid as well as the following strings:

Property	Description
'offset points'	offset (in points) from the <i>xy</i> value
'offset pixels'	offset (in pixels) from the <i>xy</i> value

defaults to the input of *xycoords*

arrowprops : dict, optional

If not None, properties used to draw a *FancyArrowPatch* arrow between *xy* and *xytext*.

If *arrowprops* does not contain the key 'arrowstyle' the allowed keys are:

Key	Description
width	the width of the arrow in points
headwidth	the width of the base of the arrow head in points
headlength	the length of the arrow head in points
shrink	fraction of total length to 'shrink' from both ends
?	any key to <i>matplotlib.patches.FancyArrowPatch</i>

If the *arrowprops* contains the key 'arrowstyle' the above keys are forbidden. The allowed values of 'arrowstyle' are:

Name	Attrs
'-'	None
'->'	head_length=0.4,head_width=0.2
'-['	widthB=1.0,lengthB=0.2,angleB=None
' -'	widthA=1.0,widthB=1.0
'- >'	head_length=0.4,head_width=0.2
'<-'	head_length=0.4,head_width=0.2
'<->'	head_length=0.4,head_width=0.2
'< -'	head_length=0.4,head_width=0.2
'< ->'	head_length=0.4,head_width=0.2
'fancy'	head_length=0.4,head_width=0.4,tail_width=0.4
'simple'	head_length=0.5,head_width=0.5,tail_width=0.2
'wedge'	tail_width=0.3,shrink_factor=0.5

Valid keys for *FancyArrowPatch* are:

Key	Description
arrowstyle	the arrow style
connectionstyle	the connection style
relpos	default is (0.5, 0.5)
patchA	default is bounding box of the text
patchB	default is None
shrinkA	default is 2 points
shrinkB	default is 2 points
mutation_scale	default is text size (in points)
mutation_aspect	default is 1.
?	any key for <i>matplotlib.patches.PathPatch</i>

Defaults to None

annotation_clip : bool, optional

Controls the visibility of the annotation when it goes outside the axes area.

If True, the annotation will only be drawn when the *xy* is inside the axes. If False, the annotation will always be drawn regardless of its position.

The default is None, which behave as True only if *xycoords* is “data”.

Returns Annotation

`matplotlib.pyplot.arrow(x, y, dx, dy, hold=None, **kwargs)`

Add an arrow to the axes.

Draws arrow on specified axis from (x, y) to (x + dx, y + dy). Uses FancyArrow patch to construct the arrow.

Parameters **x** : float

X-coordinate of the arrow base

y : float

Y-coordinate of the arrow base

dx : float

Length of arrow along x-coordinate

dy : float

Length of arrow along y-coordinate

Returns **a** : FancyArrow

patches.FancyArrow object

Other Parameters Optional **kwargs** (inherited from FancyArrow patch) control the arrow

construction and properties:

Constructor arguments

width: float (default: 0.001) width of full arrow tail

length_includes_head: [True | False] (default: False) True if head is to be counted in calculating the length.

head_width: float or None (default: 3*width) total width of the full arrow head

head_length: float or None (default: 1.5 * head_width) length of arrow head

shape: ['full', 'left', 'right'] (default: 'full') draw the left-half, right-half, or full arrow

overhang: float (default: 0) fraction that the arrow is swept back (0 overhang means triangular shape). Can be negative or greater than one.

head_starts_at_zero: [True | False] (default: False) if True, the head starts being drawn at coordinate 0 instead of ending at coordinate 0.

Other valid kwargs (inherited from :class:'Patch') are:

Property	Description
<i>agg_filter</i>	unknown
<i>alpha</i>	float or None
<i>animated</i>	[True False]
<i>antialiased</i> or <i>aa</i>	[True False] or None for default
<i>axes</i>	an <i>Axes</i> instance
<i>capstyle</i>	['butt' 'round' 'projecting']
<i>clip_box</i>	a <i>matplotlib.transforms.Bbox</i> instance
<i>clip_on</i>	[True False]
<i>clip_path</i>	[(<i>Path</i> , <i>Transform</i>) <i>Patch</i> None]
<i>color</i>	matplotlib color spec
<i>contains</i>	a callable function
<i>edgecolor</i> or <i>ec</i>	mpl color spec, None, 'none', or 'auto'
<i>facecolor</i> or <i>fc</i>	mpl color spec, or None for default, or 'none' for no color
<i>figure</i>	a <i>matplotlib.figure.Figure</i> instance
<i>fill</i>	[True False]
<i>gid</i>	an id string
<i>hatch</i>	['/' '\' ' ' '-' '+' 'x' 'o' 'O' '.' '*']
<i>joinstyle</i>	['miter' 'round' 'bevel']
<i>label</i>	string or anything printable with '%s' conversion.
<i>linestyle</i> or <i>ls</i>	['solid' 'dashed', 'dashdot', 'dotted' (offset, on-off-dash-seq) '- ' '-- ' '- .' ': ' 'None']
<i>linewidth</i> or <i>lw</i>	float or None for default
<i>path_effects</i>	unknown
<i>picker</i>	[None float boolean callable]
<i>rasterized</i>	[True False None]
<i>sketch_params</i>	unknown
<i>snap</i>	unknown
<i>transform</i>	<i>Transform</i> instance
<i>url</i>	a url string
<i>visible</i>	[True False]
<i>zorder</i>	any number

Notes

The resulting arrow is affected by the axes aspect ratio and limits. This may produce an arrow whose head is not square with its stem. To create an arrow whose head is square with its stem,

use `annotate()` for example:

```
ax.annotate("", xy=(0.5, 0.5), xytext=(0, 0),
            arrowprops=dict(arrowstyle="->"))
```

Examples

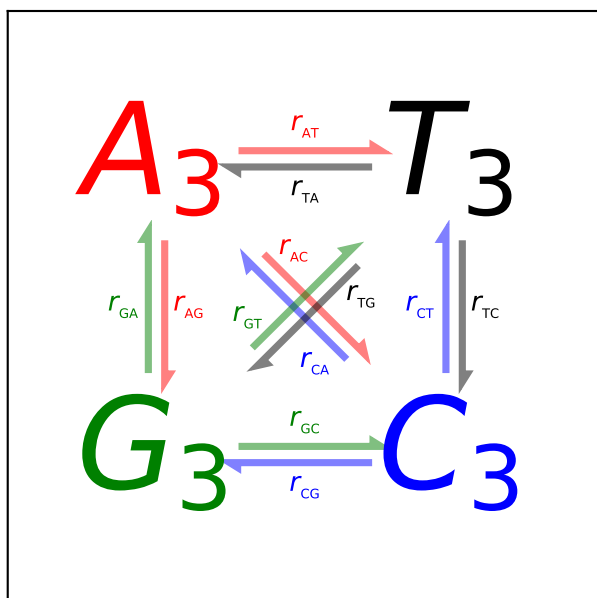

`matplotlib.pyplot.autoscale(enable=True, axis='both', tight=None)`

Autoscale the axis view to the data (toggle).

Convenience method for simple axis view autoscaling. It turns autoscaling on or off, and then, if autoscaling for either axis is on, it performs the autoscaling on the specified axis or axes.

enable: [**True** | **False** | **None**] True (default) turns autoscaling on, False turns it off. None leaves the autoscaling state unchanged.

axis: ['x' | 'y' | 'both'] which axis to operate on; default is 'both'

tight: [**True** | **False** | **None**] If True, set view limits to data limits; if False, let the locator and margins expand the view limits; if None, use tight scaling if the only artist is an image, otherwise treat *tight* as False. The *tight* setting is retained for future autoscaling until it is explicitly changed.

Returns None.

`matplotlib.pyplot.autumn()`

set the default colormap to autumn and apply to current image if any. See `help(colormaps)` for more information

`matplotlib.pyplot.axes(*args, **kwargs)`

Add an axes to the figure.

The axes is added at position *rect* specified by:

- `axes()` by itself creates a default full `subplot(111)` window axis.
- `axes(rect, facecolor='w')` where *rect* = [left, bottom, width, height] in normalized (0, 1) units. *facecolor* is the background color for the axis, default white.
- `axes(h)` where *h* is an axes instance makes *h* the current axis. An `Axes` instance is returned.

kwarg	Accepts	Description
face-color	color	the axes background color
frameon	[True False]	display the frame?
sharex	otherax	current axes shares xaxis attribute with otherax
sharey	otherax	current axes shares yaxis attribute with otherax
polar	[True False]	use a polar axes?
aspect	[str num]	['equal', 'auto'] or a number. If a number the ratio of x-unit/y-unit in screen-space. Also see <code>set_aspect()</code> .

Examples:

- `examples/pylab_examples/axes_demo.py` places custom axes.
- `examples/pylab_examples/shared_axis_demo.py` uses *sharex* and *sharey*.

`matplotlib.pyplot.axhline(y=0, xmin=0, xmax=1, hold=None, **kwargs)`

Add a horizontal line across the axis.

Parameters *y* : scalar, optional, default: 0

y position in data coordinates of the horizontal line.

xmin : scalar, optional, default: 0

Should be between 0 and 1, 0 being the far left of the plot, 1 the far right of the plot.

xmax : scalar, optional, default: 1

Should be between 0 and 1, 0 being the far left of the plot, 1 the far right of the plot.

Returns `Line2D`

See also:

`axhspan` for example plot and source code

Notes

kwargs are passed to `Line2D` and can be used to control the line properties.

Examples

- draw a thick red hline at 'y' = 0 that spans the xrange:

```
>>> axhline(linewidth=4, color='r')
```

- draw a default hline at 'y' = 1 that spans the xrange:

```
>>> axhline(y=1)
```

- draw a default hline at 'y' = .5 that spans the middle half of the xrange:

```
>>> axhline(y=.5, xmin=0.25, xmax=0.75)
```

Valid kwargs are *Line2D* properties, with the exception of 'transform':

Property	Description
<i>agg_filter</i>	unknown
<i>alpha</i>	float (0.0 transparent through 1.0 opaque)
<i>animated</i>	[True False]
<i>antialiased</i> or <i>aa</i>	[True False]
<i>axes</i>	an <i>Axes</i> instance
<i>clip_box</i>	a <i>matplotlib.transforms.Bbox</i> instance
<i>clip_on</i>	[True False]
<i>clip_path</i>	[(<i>Path</i> , <i>Transform</i>) <i>Patch</i> None]
<i>color</i> or <i>c</i>	any matplotlib color
<i>contains</i>	a callable function
<i>dash_capstyle</i>	['butt' 'round' 'projecting']
<i>dash_joinstyle</i>	['miter' 'round' 'bevel']
<i>dashes</i>	sequence of on/off ink in points
<i>drawstyle</i>	['default' 'steps' 'steps-pre' 'steps-mid' 'steps-post']
<i>figure</i>	a <i>matplotlib.figure.Figure</i> instance
<i>fillstyle</i>	['full' 'left' 'right' 'bottom' 'top' 'none']
<i>gid</i>	an id string
<i>label</i>	string or anything printable with '%s' conversion.
<i>linestyle</i> or <i>ls</i>	['solid' 'dashed', 'dashdot', 'dotted' (offset, on-off-dash-seq) '-' '--' '-.' ' ']
<i>linewidth</i> or <i>lw</i>	float value in points
<i>marker</i>	<i>A valid marker style</i>
<i>markeredgecolor</i> or <i>mec</i>	any matplotlib color
<i>markeredgewidth</i> or <i>mew</i>	float value in points
<i>markerfacecolor</i> or <i>mfc</i>	any matplotlib color
<i>markerfacecoloralt</i> or <i>mfcalt</i>	any matplotlib color
<i>markersize</i> or <i>ms</i>	float
<i>markevery</i>	[None int length-2 tuple of int slice list/array of int float length-2 tuple of float]
<i>path_effects</i>	unknown
<i>picker</i>	float distance in points or callable pick function <code>fn(artist, event)</code>

Table 45.3 – continued from previous page

Property	Description
<i>pickradius</i>	float distance in points
<i>rasterized</i>	[True False None]
<i>sketch_params</i>	unknown
<i>snap</i>	unknown
<i>solid_capstyle</i>	['butt' 'round' 'projecting']
<i>solid_joinstyle</i>	['miter' 'round' 'bevel']
<i>transform</i>	a <i>matplotlib.transforms.Transform</i> instance
<i>url</i>	a url string
<i>visible</i>	[True False]
<i>xdata</i>	1D array
<i>ydata</i>	1D array
<i>zorder</i>	any number

`matplotlib.pyplot.axhspan`(*ymin*, *ymax*, *xmin=0*, *xmax=1*, *hold=None*, ***kwargs*)

Add a horizontal span (rectangle) across the axis.

Draw a horizontal span (rectangle) from *ymin* to *ymax*. With the default values of *xmin* = 0 and *xmax* = 1, this always spans the xrange, regardless of the xlim settings, even if you change them, e.g., with the `set_xlim()` command. That is, the horizontal extent is in axes coords: 0=left, 0.5=middle, 1.0=right but the y location is in data coordinates.

Parameters *ymin* : float

Lower limit of the horizontal span in data units.

ymax : float

Upper limit of the horizontal span in data units.

xmin : float, optional, default: 0

Lower limit of the vertical span in axes (relative 0-1) units.

xmax : float, optional, default: 1

Upper limit of the vertical span in axes (relative 0-1) units.

Returns Polygon : *Polygon*

Other Parameters *kwargs* : *Polygon* properties.

Property	Description
<i>agg_filter</i>	unknown
<i>alpha</i>	float or None
<i>animated</i>	[True False]
<i>antialiased</i> or <i>aa</i>	[True False] or None for default
<i>axes</i>	an <i>Axes</i> instance

Continued on

Table 45.4 – continued from previous page

Property	Description
<i>capstyle</i>	['butt' 'round' 'projecting']
<i>clip_box</i>	a <i>matplotlib.transforms.Bbox</i> instance
<i>clip_on</i>	[True False]
<i>clip_path</i>	[(<i>Path</i> , <i>Transform</i>) <i>Patch</i> None]
<i>color</i>	matplotlib color spec
<i>contains</i>	a callable function
<i>edgecolor</i> or <i>ec</i>	mpl color spec, None, 'none', or 'auto'
<i>facecolor</i> or <i>fc</i>	mpl color spec, or None for default, or 'none' for no color
<i>figure</i>	a <i>matplotlib.figure.Figure</i> instance
<i>fill</i>	[True False]
<i>gid</i>	an id string
<i>hatch</i>	['/' '\' ' ' '-' '+' 'x' 'o' 'O' '.' '*']
<i>joinstyle</i>	['miter' 'round' 'bevel']
<i>label</i>	string or anything printable with '%s' conversion.
<i>linestyle</i> or <i>ls</i>	['solid' 'dashed', 'dashdot', 'dotted' (offset, on-off-dash-seq) '-' '--' '-.' ':' 'None']
<i>linewidth</i> or <i>lw</i>	float or None for default
<i>path_effects</i>	unknown
<i>picker</i>	[None float boolean callable]
<i>rasterized</i>	[True False None]
<i>sketch_params</i>	unknown
<i>snap</i>	unknown
<i>transform</i>	<i>Transform</i> instance
<i>url</i>	a url string
<i>visible</i>	[True False]
<i>zorder</i>	any number

See also:

axvspan Add a vertical span (rectangle) across the axes.

Examples

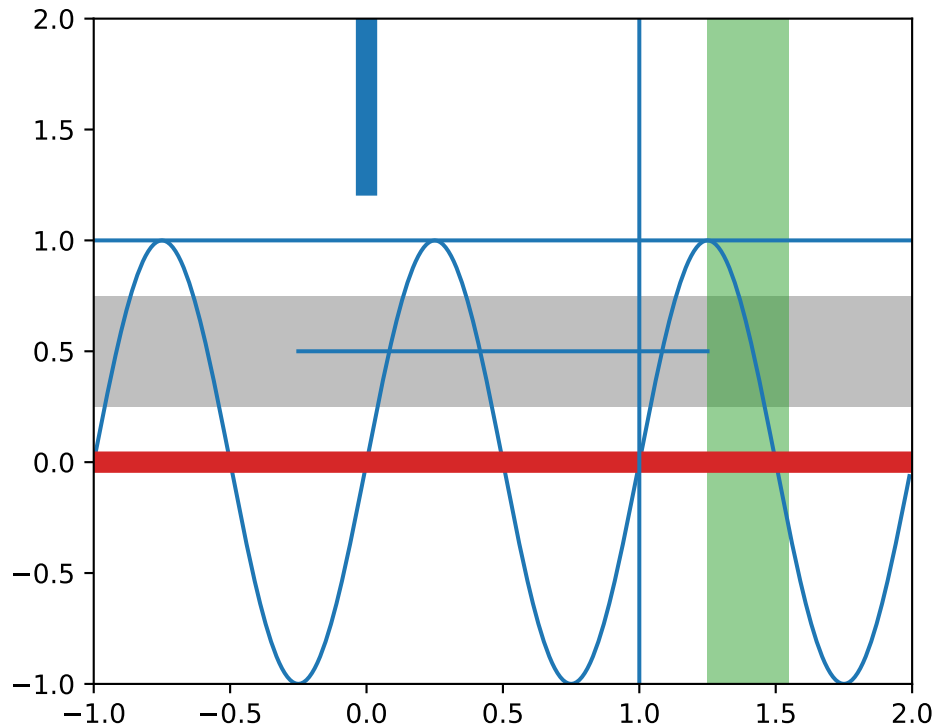

`matplotlib.pyplot.axis(*v, **kwargs)`

Convenience method to get or set axis properties.

Calling with no arguments:

```
>>> axis()
```

returns the current axes limits `[xmin, xmax, ymin, ymax]`..

```
>>> axis(v)
```

sets the min and max of the x and y axes, with `v = [xmin, xmax, ymin, ymax]`..

```
>>> axis('off')
```

turns off the axis lines and labels.:

```
>>> axis('equal')
```

changes limits of `x` or `y` axis so that equal increments of `x` and `y` have the same length; a circle is circular.:

```
>>> axis('scaled')
```

achieves the same result by changing the dimensions of the plot box instead of the axis data limits.:

```
>>> axis('tight')
```

changes x and y axis limits such that all data is shown. If all data is already shown, it will move it to the center of the figure without modifying $(x_{max} - x_{min})$ or $(y_{max} - y_{min})$. Note this is slightly different than in MATLAB.:

```
>>> axis('image')
```

is 'scaled' with the axis limits equal to the data limits.:

```
>>> axis('auto')
```

and:

```
>>> axis('normal')
```

are deprecated. They restore default behavior; axis limits are automatically scaled to make the data fit comfortably within the plot box.

if `len(*v)==0`, you can pass in x_{min} , x_{max} , y_{min} , y_{max} as kwargs selectively to alter just those limits without changing the others.

```
>>> axis('square')
```

changes the limit ranges $(x_{max}-x_{min})$ and $(y_{max}-y_{min})$ of the x and y axes to be the same, and have the same scaling, resulting in a square plot.

The x_{min} , x_{max} , y_{min} , y_{max} tuple is returned

See also:

[`xlim\(\)`](#), [`ylim\(\)`](#) For setting the x- and y-limits individually.

`matplotlib.pyplot.axvline(x=0, ymin=0, ymax=1, hold=None, **kwargs)`

Add a vertical line across the axes.

Parameters x : scalar, optional, default: 0

x position in data coordinates of the vertical line.

ymin : scalar, optional, default: 0

Should be between 0 and 1, 0 being the bottom of the plot, 1 the top of the plot.

ymax : scalar, optional, default: 1

Should be between 0 and 1, 0 being the bottom of the plot, 1 the top of the plot.

Returns *Line2D*

See also:

[axhspan](#) for example plot and source code

Examples

- draw a thick red vline at $x = 0$ that spans the yrange:

```
>>> axvline(linewidth=4, color='r')
```

- draw a default vline at $x = 1$ that spans the yrange:

```
>>> axvline(x=1)
```

- draw a default vline at $x = .5$ that spans the middle half of the yrange:

```
>>> axvline(x=.5, ymin=0.25, ymax=0.75)
```

Valid kwargs are *Line2D* properties, with the exception of ‘transform’:

Property	Description
<i>agg_filter</i>	unknown
<i>alpha</i>	float (0.0 transparent through 1.0 opaque)
<i>animated</i>	[True False]
<i>antialiased</i> or <i>aa</i>	[True False]
<i>axes</i>	an <i>Axes</i> instance
<i>clip_box</i>	a <i>matplotlib.transforms.Bbox</i> instance
<i>clip_on</i>	[True False]
<i>clip_path</i>	[(<i>Path</i> , <i>Transform</i>) <i>Patch</i> None]
<i>color</i> or <i>c</i>	any matplotlib color
<i>contains</i>	a callable function
<i>dash_capstyle</i>	[‘butt’ ‘round’ ‘projecting’]
<i>dash_joinstyle</i>	[‘miter’ ‘round’ ‘bevel’]
<i>dashes</i>	sequence of on/off ink in points
<i>drawstyle</i>	[‘default’ ‘steps’ ‘steps-pre’ ‘steps-mid’ ‘steps-post’]
<i>figure</i>	a <i>matplotlib.figure.Figure</i> instance
<i>fillstyle</i>	[‘full’ ‘left’ ‘right’ ‘bottom’ ‘top’ ‘none’]
<i>gid</i>	an id string
<i>label</i>	string or anything printable with ‘%s’ conversion.
<i>linestyle</i> or <i>ls</i>	[‘solid’ ‘dashed’, ‘dashdot’, ‘dotted’ (offset, on-off-dash-seq) ‘-’ ‘--’ ‘-.’ ‘.’]
<i>linewidth</i> or <i>lw</i>	float value in points
<i>marker</i>	<i>A valid marker style</i>
<i>markeredgecolor</i> or <i>mec</i>	any matplotlib color
<i>markeredgewidth</i> or <i>mew</i>	float value in points

Table 45.5 – continued from previous page

Property	Description
<code>markerfacecolor</code> or <code>mfc</code>	any matplotlib color
<code>markerfacecoloralt</code> or <code>mfcalt</code>	any matplotlib color
<code>markersize</code> or <code>ms</code>	float
<code>markevery</code>	[None int length-2 tuple of int slice list/array of int float length-2 tuple of float]
<code>path_effects</code>	unknown
<code>picker</code>	float distance in points or callable pick function <code>fn(artist, event)</code>
<code>pickradius</code>	float distance in points
<code>rasterized</code>	[True False None]
<code>sketch_params</code>	unknown
<code>snap</code>	unknown
<code>solid_capstyle</code>	['butt' 'round' 'projecting']
<code>solid_joinstyle</code>	['miter' 'round' 'bevel']
<code>transform</code>	a <code>matplotlib.transforms.Transform</code> instance
<code>url</code>	a url string
<code>visible</code>	[True False]
<code>xdata</code>	1D array
<code>ydata</code>	1D array
<code>zorder</code>	any number

`matplotlib.pyplot.axvspan(xmin, xmax, ymin=0, ymax=1, hold=None, **kwargs)`

Add a vertical span (rectangle) across the axes.

Draw a vertical span (rectangle) from `xmin` to `xmax`. With the default values of `ymin = 0` and `ymax = 1`. This always spans the yrange, regardless of the `ylim` settings, even if you change them, e.g., with the `set_ylim()` command. That is, the vertical extent is in axes coords: 0=bottom, 0.5=middle, 1.0=top but the y location is in data coordinates.

Parameters `xmin` : scalar

Number indicating the first X-axis coordinate of the vertical span rectangle in data units.

xmax : scalar

Number indicating the second X-axis coordinate of the vertical span rectangle in data units.

ymin : scalar, optional

Number indicating the first Y-axis coordinate of the vertical span rectangle in relative Y-axis units (0-1). Default to 0.

ymax : scalar, optional

Number indicating the second Y-axis coordinate of the vertical span rectangle in relative Y-axis units (0-1). Default to 1.

Returns `rectangle` : `matplotlib.patches.Polygon`

Vertical span (rectangle) from (xmin, ymin) to (xmax, ymax).

Other Parameters ****kwargs**

Optional parameters are properties of the class `matplotlib.patches.Polygon`.

See also:

[`axhspan`](#)

Examples

Draw a vertical, green, translucent rectangle from $x = 1.25$ to $x = 1.55$ that spans the yrange of the axes.

```
>>> axvspan(1.25, 1.55, facecolor='g', alpha=0.5)
```

```
matplotlib.pyplot.bar(left, height, width=0.8, bottom=None, hold=None, data=None,
                       **kwargs)
```

Make a bar plot.

Make a bar plot with rectangles bounded by:

left, left + width, bottom, bottom + height (left, right, bottom and top edges)

Parameters left : sequence of scalars

the x coordinates of the left sides of the bars

height : sequence of scalars

the heights of the bars

width : scalar or array-like, optional

the width(s) of the bars default: 0.8

bottom : scalar or array-like, optional

the y coordinate(s) of the bars default: None

color : scalar or array-like, optional

the colors of the bar faces

edgecolor : scalar or array-like, optional

the colors of the bar edges

linewidth : scalar or array-like, optional

width of bar edge(s). If None, use default linewidth; If 0, don't draw edges.
default: None

tick_label : string or array-like, optional

the tick labels of the bars default: None

xerr : scalar or array-like, optional

if not None, will be used to generate errorbar(s) on the bar chart default: None

yerr : scalar or array-like, optional

if not None, will be used to generate errorbar(s) on the bar chart default: None

ecolor : scalar or array-like, optional

specifies the color of errorbar(s) default: None

capsize : scalar, optional

determines the length in points of the error bar caps default: None, which will take the value from the `errorbar.capsize` *rcParam*.

error_kw : dict, optional

dictionary of kwargs to be passed to errorbar method. *ecolor* and *capsize* may be specified here rather than as independent kwargs.

align : { 'center', 'edge' }, optional

If 'edge', aligns bars by their left edges (for vertical bars) and by their bottom edges (for horizontal bars). If 'center', interpret the `left` argument as the coordinates of the centers of the bars. To align on the right edge pass a negative `width`.

orientation : { 'vertical', 'horizontal' }, optional

The orientation of the bars.

log : boolean, optional

If true, sets the axis to be log scale. default: False

Returns bars : `matplotlib.container.BarContainer`

Container with all of the bars + errorbars

See also:

barh Plot a horizontal bar plot.

Notes

The optional arguments `color`, `edgecolor`, `linewidth`, `xerr`, and `yerr` can be either scalars or sequences of length equal to the number of bars. This enables you to use `bar` as the basis for stacked bar charts, or candlestick plots. Detail: `xerr` and `yerr` are passed directly to `errorbar()`, so they can also have shape `2xN` for independent specification of lower and upper errors.

Other optional kwargs:

Property	Description
<i>agg_filter</i>	unknown
<i>alpha</i>	float or None
<i>animated</i>	[True False]
<i>antialiased</i> or <i>aa</i>	[True False] or None for default
<i>axes</i>	an <i>Axes</i> instance
<i>capstyle</i>	['butt' 'round' 'projecting']
<i>clip_box</i>	a <i>matplotlib.transforms.Bbox</i> instance
<i>clip_on</i>	[True False]
<i>clip_path</i>	[(<i>Path</i> , <i>Transform</i>) <i>Patch</i> None]
<i>color</i>	matplotlib color spec
<i>contains</i>	a callable function
<i>edgecolor</i> or <i>ec</i>	mpl color spec, None, 'none', or 'auto'
<i>facecolor</i> or <i>fc</i>	mpl color spec, or None for default, or 'none' for no color
<i>figure</i>	a <i>matplotlib.figure.Figure</i> instance
<i>fill</i>	[True False]
<i>gid</i>	an id string
<i>hatch</i>	['/' '\' ' ' '-' '+' 'x' 'o' 'O' '.' '*']
<i>joinstyle</i>	['miter' 'round' 'bevel']
<i>label</i>	string or anything printable with '%s' conversion.
<i>linestyle</i> or <i>ls</i>	['solid' 'dashed', 'dashdot', 'dotted' (offset, on-off-dash-seq) '-' '--' '-.' ':' 'None']
<i>linewidth</i> or <i>lw</i>	float or None for default
<i>path_effects</i>	unknown
<i>picker</i>	[None float boolean callable]
<i>rasterized</i>	[True False None]
<i>sketch_params</i>	unknown
<i>snap</i>	unknown
<i>transform</i>	<i>Transform</i> instance
<i>url</i>	a url string
<i>visible</i>	[True False]
<i>zorder</i>	any number

Examples

Example: A stacked bar chart.

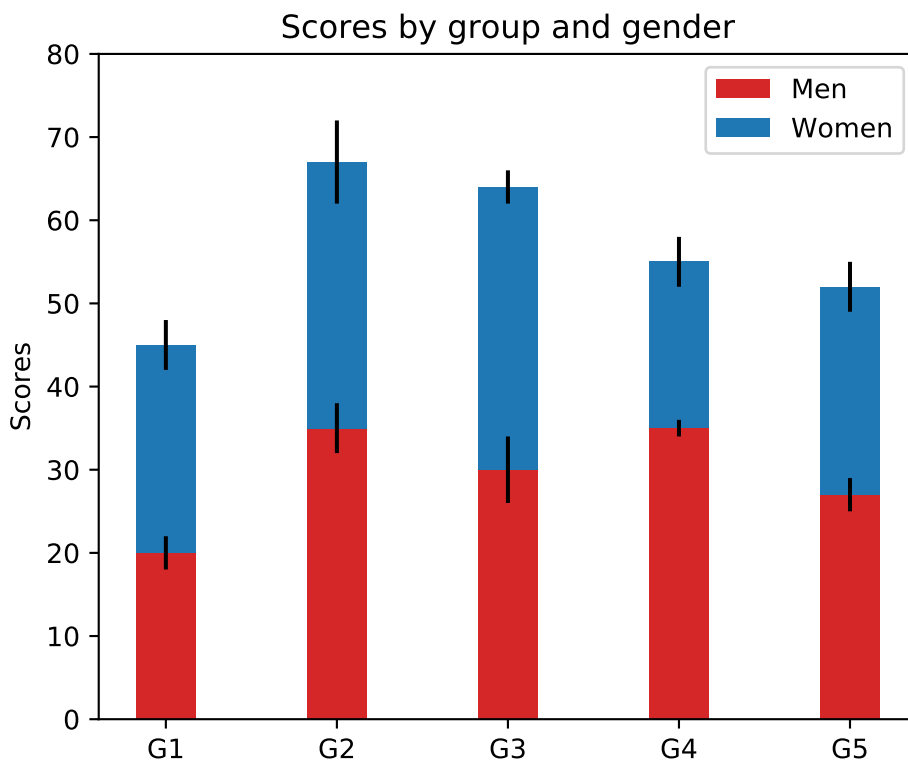

Note: In addition to the above described arguments, this function can take a **data** keyword argument. If such a **data** argument is given, the following arguments are replaced by **data[<arg>]**:

- All arguments with the following names: 'bottom', 'color', 'ecolor', 'edgecolor', 'height', 'left', 'linewidth', 'tick_label', 'width', 'xerr', 'yerr'.
-

`matplotlib.pyplot.barbs(*args, **kw)`

Plot a 2-D field of barbs.

Call signatures:

```
barb(U, V, **kw)
barb(U, V, C, **kw)
barb(X, Y, U, V, **kw)
barb(X, Y, U, V, C, **kw)
```

Arguments:

X, Y: The x and y coordinates of the barb locations (default is head of barb; see *pivot* kwarg)

U, V: Give the x and y components of the barb shaft

C: An optional array used to map colors to the barbs

All arguments may be 1-D or 2-D arrays or sequences. If X and Y are absent, they will be generated as a uniform grid. If U and V are 2-D arrays but X and Y are 1-D, and if $\text{len}(X)$ and $\text{len}(Y)$ match the column and row dimensions of U , then X and Y will be expanded with `numpy.meshgrid()`.

U , V , C may be masked arrays, but masked X , Y are not supported at present.

Keyword arguments:

length: Length of the barb in points; the other parts of the barb are scaled against this. Default is 9

pivot: [**'tip'** | **'middle'**] The part of the arrow that is at the grid point; the arrow rotates about this point, hence the name *pivot*. Default is 'tip'

barbcolor: [**color** | **color sequence**] Specifies the color all parts of the barb except any flags. This parameter is analogous to the *edgecolor* parameter for polygons, which can be used instead. However this parameter will override *facecolor*.

flagcolor: [**color** | **color sequence**] Specifies the color of any flags on the barb. This parameter is analogous to the *facecolor* parameter for polygons, which can be used instead. However this parameter will override *facecolor*. If this is not set (and C has not either) then *flagcolor* will be set to match *barbcolor* so that the barb has a uniform color. If C has been set, *flagcolor* has no effect.

sizes: A dictionary of coefficients specifying the ratio of a given feature to the length of the barb. Only those values one wishes to override need to be included. These features include:

- 'spacing' - space between features (flags, full/half barbs)
- 'height' - height (distance from shaft to top) of a flag or full barb
- 'width' - width of a flag, twice the width of a full barb
- 'emptybarb' - radius of the circle used for low magnitudes

fill_empty: A flag on whether the empty barbs (circles) that are drawn should be filled with the flag color. If they are not filled, they will be drawn such that no color is applied to the center. Default is False

rounding: A flag to indicate whether the vector magnitude should be rounded when allocating barb components. If True, the magnitude is rounded to the nearest multiple of the half-barb increment. If False, the magnitude is simply truncated to the next lowest multiple. Default is True

barb_increments: A dictionary of increments specifying values to associate with different parts of the barb. Only those values one wishes to override need to be included.

- 'half' - half barbs (Default is 5)
- 'full' - full barbs (Default is 10)
- 'flag' - flags (default is 50)

flip_barb: Either a single boolean flag or an array of booleans. Single boolean indicates whether the lines and flags should point opposite to normal for all barbs. An array (which should be the same size as the other data arrays) indicates whether to flip for

each individual barb. Normal behavior is for the barbs and lines to point right (comes from wind barbs having these features point towards low pressure in the Northern Hemisphere.) Default is False

Barbs are traditionally used in meteorology as a way to plot the speed and direction of wind observations, but can technically be used to plot any two dimensional vector quantity. As opposed to arrows, which give vector magnitude by the length of the arrow, the barbs give more quantitative information about the vector magnitude by putting slanted lines or a triangle for various increments in magnitude, as show schematically below:



The largest increment is given by a triangle (or “flag”). After those come full lines (barbs). The smallest increment is a half line. There is only, of course, ever at most 1 half line. If the magnitude is small and only needs a single half-line and no full lines or triangles, the half-line is offset from the end of the barb so that it can be easily distinguished from barbs with a single full line. The magnitude for the barb shown above would nominally be 65, using the standard increments of 50, 10, and 5.

linewidths and edgecolors can be used to customize the barb. Additional *PolyCollection* keyword arguments:

Property	Description
<i>agg_filter</i>	unknown
<i>alpha</i>	float or None
<i>animated</i>	[True False]
<i>antialiased</i> or <i>antialiaseds</i>	Boolean or sequence of booleans
<i>array</i>	unknown
<i>axes</i>	an <i>Axes</i> instance
<i>clim</i>	a length 2 sequence of floats
<i>clip_box</i>	a <i>matplotlib.transforms.Bbox</i> instance
<i>clip_on</i>	[True False]
<i>clip_path</i>	[(<i>Path</i> , <i>Transform</i>) <i>Patch</i> None]
<i>cmap</i>	a colormap or registered colormap name
<i>color</i>	matplotlib color arg or sequence of rgba tuples
<i>contains</i>	a callable function
<i>edgecolor</i> or <i>edgecolors</i>	matplotlib color spec or sequence of specs
<i>facecolor</i> or <i>facecolors</i>	matplotlib color spec or sequence of specs
<i>figure</i>	a <i>matplotlib.figure.Figure</i> instance
<i>gid</i>	an id string
<i>hatch</i>	['/' '\' ' ' '-' '+' 'x' 'o' 'O' '.' '*']
<i>label</i>	string or anything printable with '%s' conversion.
<i>linestyle</i> or <i>dashes</i> or <i>linestyles</i>	['solid' 'dashed', 'dashdot', 'dotted' (offset, on-off-dash-seq) '-' '--' '-.' ...]
<i>linewidth</i> or <i>linewidths</i> or <i>lw</i>	float or sequence of floats
<i>norm</i>	unknown

Table 45.7 – continued from previous page

Property	Description
<code>offset_position</code>	unknown
<code>offsets</code>	float or sequence of floats
<code>path_effects</code>	unknown
<code>picker</code>	[None float boolean callable]
<code>pickradius</code>	unknown
<code>rasterized</code>	[True False None]
<code>sketch_params</code>	unknown
<code>snap</code>	unknown
<code>transform</code>	<i>Transform</i> instance
<code>url</code>	a url string
<code>urls</code>	unknown
<code>visible</code>	[True False]
<code>zorder</code>	any number

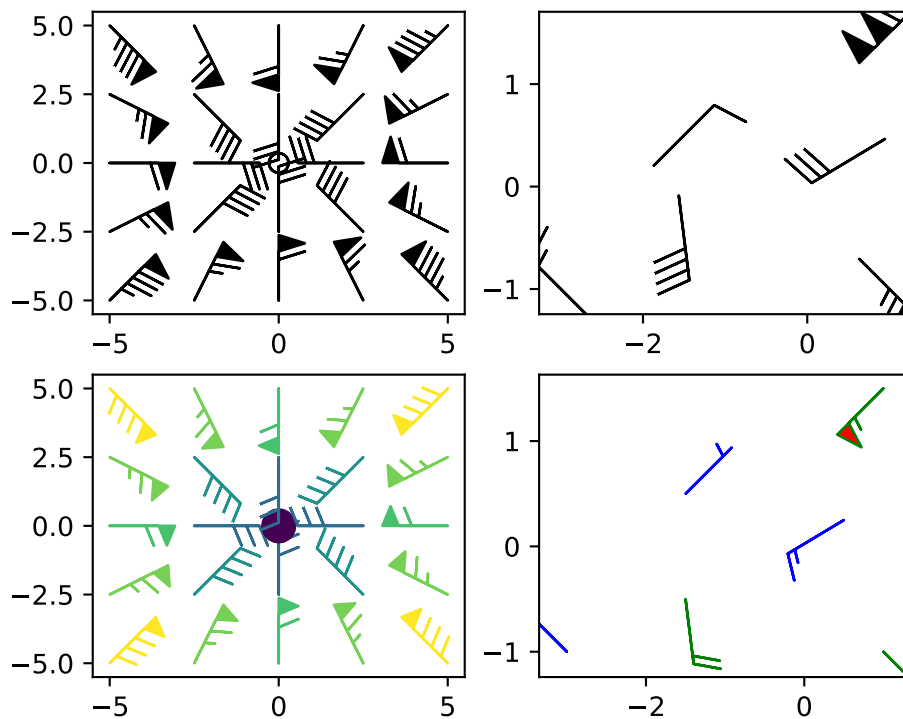
Example:

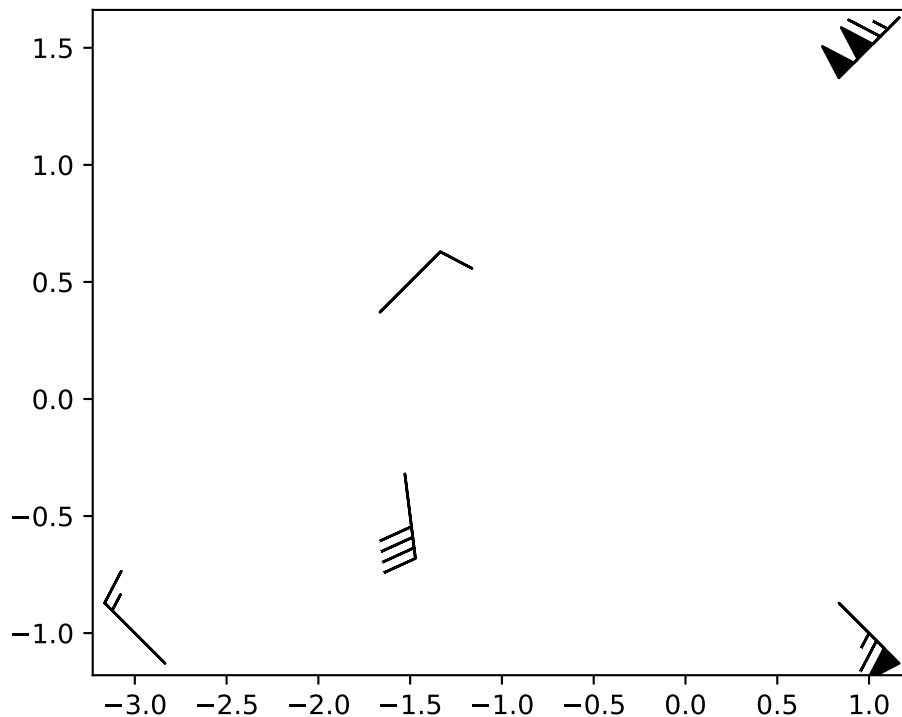

Note: In addition to the above described arguments, this function can take a **data** keyword argument. If such a **data** argument is given, the following arguments are replaced by **data[<arg>]**:

- All positional and all keyword arguments.
-

`matplotlib.pyplot.barh(bottom, width, height=0.8, left=None, hold=None, **kwargs)`

Make a horizontal bar plot.

Make a horizontal bar plot with rectangles bounded by:

left, left + width, bottom, bottom + height (left, right, bottom and top edges)

bottom, width, height, and left can be either scalars or sequences

Parameters bottom : scalar or array-like

the y coordinate(s) of the bars

width : scalar or array-like

the width(s) of the bars

height : sequence of scalars, optional, default: 0.8

the heights of the bars

left : sequence of scalars

the x coordinates of the left sides of the bars

Returns `matplotlib.patches.Rectangle` instances.

Other Parameters **color** : scalar or array-like, optional

the colors of the bars

edgecolor : scalar or array-like, optional

the colors of the bar edges

linewidth : scalar or array-like, optional, default: None

width of bar edge(s). If None, use default linewidth; If 0, don't draw edges.

tick_label : string or array-like, optional, default: None

the tick labels of the bars

xerr : scalar or array-like, optional, default: None

if not None, will be used to generate errorbar(s) on the bar chart

yerr : scalar or array-like, optional, default: None

if not None, will be used to generate errorbar(s) on the bar chart

ecolor : scalar or array-like, optional, default: None

specifies the color of errorbar(s)

capsize : scalar, optional

determines the length in points of the error bar caps default: None, which will take the value from the `errorbar.capsize` *rcParam*.

error_kw :

dictionary of kwargs to be passed to errorbar method. `ecolor` and `capsize` may be specified here rather than as independent kwargs.

align : { 'center', 'edge' }, optional

If 'edge', aligns bars by their left edges (for vertical bars) and by their bottom edges (for horizontal bars). If 'center', interpret the `bottom` argument as the coordinates of the centers of the bars. To align on the align bars on the top edge pass a negative 'height'.

log : boolean, optional, default: False

If true, sets the axis to be log scale

See also:

bar Plot a vertical bar plot.

Notes

The optional arguments `color`, `edgecolor`, `linewidth`, `xerr`, and `yerr` can be either scalars or sequences of length equal to the number of bars. This enables you to use bar as the basis for stacked bar charts, or candlestick plots. Detail: `xerr` and `yerr` are passed directly to `errorbar()`, so they can also have shape `2xN` for independent specification of lower and upper errors.

Other optional kwargs:

Property	Description
<code>agg_filter</code>	unknown
<code>alpha</code>	float or None
<code>animated</code>	[True False]
<code>antialiased</code> or <code>aa</code>	[True False] or None for default
<code>axes</code>	an <i>Axes</i> instance
<code>capstyle</code>	['butt' 'round' 'projecting']
<code>clip_box</code>	a <code>matplotlib.transforms.Bbox</code> instance
<code>clip_on</code>	[True False]
<code>clip_path</code>	[(<i>Path</i> , <i>Transform</i>) <i>Patch</i> None]
<code>color</code>	matplotlib color spec
<code>contains</code>	a callable function
<code>edgecolor</code> or <code>ec</code>	mpl color spec, None, 'none', or 'auto'
<code>facecolor</code> or <code>fc</code>	mpl color spec, or None for default, or 'none' for no color
<code>figure</code>	a <code>matplotlib.figure.Figure</code> instance
<code>fill</code>	[True False]
<code>gid</code>	an id string
<code>hatch</code>	['/' '\' ' ' '-' '+' 'x' 'o' 'O' '.' '*']
<code>joinstyle</code>	['miter' 'round' 'bevel']
<code>label</code>	string or anything printable with '%s' conversion.
<code>linestyle</code> or <code>ls</code>	['solid' 'dashed', 'dashdot', 'dotted' (offset, on-off-dash-seq) '-.' '---' '-.' ':' 'None']
<code>linewidth</code> or <code>lw</code>	float or None for default
<code>path_effects</code>	unknown
<code>picker</code>	[None float boolean callable]
<code>rasterized</code>	[True False None]
<code>sketch_params</code>	unknown
<code>snap</code>	unknown
<code>transform</code>	<i>Transform</i> instance
<code>url</code>	a url string
<code>visible</code>	[True False]
<code>zorder</code>	any number

`matplotlib.pyplot.bone()`

set the default colormap to bone and apply to current image if any. See `help(colormaps)` for more information

`matplotlib.pyplot.box(on=None)`

Turn the axes box on or off. *on* may be a boolean or a string, 'on' or 'off'.

If *on* is *None*, toggle state.

`matplotlib.pyplot.boxplot(x, notch=None, sym=None, vert=None, whis=None, positions=None, widths=None, patch_artist=None, bootstrap=None, usermedians=None, conf_intervals=None, meanline=None, showmeans=None, showcaps=None, showbox=None, showfliers=None, boxprops=None, labels=None, flierprops=None, medianprops=None, meanprops=None, capprops=None, whiskerprops=None, manage_xticks=True, autorange=False, zorder=None, hold=None, data=None)`

Make a box and whisker plot.

Make a box and whisker plot for each column of *x* or each vector in sequence *x*. The box extends from the lower to upper quartile values of the data, with a line at the median. The whiskers extend from the box to show the range of the data. Flier points are those past the end of the whiskers.

Parameters *x* : Array or a sequence of vectors.

The input data.

notch : bool, optional (False)

If *True*, will produce a notched box plot. Otherwise, a rectangular boxplot is produced. The notches represent the confidence interval (CI) around the median. See the entry for the `bootstrap` parameter for information regarding how the locations of the notches are computed.

Note: In cases where the values of the CI are less than the lower quartile or greater than the upper quartile, the notches will extend beyond the box, giving it a distinctive “flipped” appearance. This is expected behavior and consistent with other statistical visualization packages.

sym : str, optional

The default symbol for flier points. Enter an empty string (‘’) if you don’t want to show fliers. If *None*, then the fliers default to ‘b+’ If you want more control use the `flierprops` kwarg.

vert : bool, optional (True)

If *True* (default), makes the boxes vertical. If *False*, everything is drawn horizontally.

whis : float, sequence, or string (default = 1.5)

As a float, determines the reach of the whiskers to the beyond the first and third quartiles. In other words, where *IQR* is the interquartile range ($Q3 - Q1$), the upper whisker will extend to last datum less than $Q3 + whis * IQR$. Similarly, the lower whisker will extend to the first datum greater than $Q1 -$

`whis*IQR`. Beyond the whiskers, data are considered outliers and are plotted as individual points. Set this to an unreasonably high value to force the whiskers to show the min and max values. Alternatively, set this to an ascending sequence of percentile (e.g., `[5, 95]`) to set the whiskers at specific percentiles of the data. Finally, `whis` can be the string `'range'` to force the whiskers to the min and max of the data.

bootstrap : int, optional

Specifies whether to bootstrap the confidence intervals around the median for notched boxplots. If `bootstrap` is `None`, no bootstrapping is performed, and notches are calculated using a Gaussian-based asymptotic approximation (see McGill, R., Tukey, J.W., and Larsen, W.A., 1978, and Kendall and Stuart, 1967). Otherwise, `bootstrap` specifies the number of times to bootstrap the median to determine its 95% confidence intervals. Values between 1000 and 10000 are recommended.

usermedians : array-like, optional

An array or sequence whose first dimension (or length) is compatible with `x`. This overrides the medians computed by matplotlib for each element of `usermedians` that is not `None`. When an element of `usermedians` is `None`, the median will be computed by matplotlib as normal.

conf_intervals : array-like, optional

Array or sequence whose first dimension (or length) is compatible with `x` and whose second dimension is 2. When the an element of `conf_intervals` is not `None`, the notch locations computed by matplotlib are overridden (provided `notch` is `True`). When an element of `conf_intervals` is `None`, the notches are computed by the method specified by the other kwargs (e.g., `bootstrap`).

positions : array-like, optional

Sets the positions of the boxes. The ticks and limits are automatically set to match the positions. Defaults to `range(1, N+1)` where `N` is the number of boxes to be drawn.

widths : scalar or array-like

Sets the width of each box either with a scalar or a sequence. The default is 0.5, or `0.15*(distance between extreme positions)`, if that is smaller.

patch_artist : bool, optional (False)

If `False` produces boxes with the `Line2D` artist. Otherwise, boxes and drawn with `Patch` artists.

labels : sequence, optional

Labels for each dataset. Length must be compatible with dimensions of `x`.

manage_xticks : bool, optional (True)

If the function should adjust the xlim and xtick locations.

autorange : bool, optional (False)

When True and the data are distributed such that the 25th and 75th percentiles are equal, **whis** is set to 'range' such that the whisker ends are at the minimum and maximum of the data.

meanline : bool, optional (False)

If True (and **showmeans** is True), will try to render the mean as a line spanning the full width of the box according to **meanprops** (see below). Not recommended if **shownotches** is also True. Otherwise, means will be shown as points.

zorder : scalar, optional (None)

Sets the zorder of the boxplot.

Returns result : dict

A dictionary mapping each component of the boxplot to a list of the *matplotlib.lines.Line2D* instances created. That dictionary has the following keys (assuming vertical boxplots):

- **boxes**: the main body of the boxplot showing the quartiles and the median's confidence intervals if enabled.
- **medians**: horizontal lines at the median of each box.
- **whiskers**: the vertical lines extending to the most extreme, non-outlier data points.
- **caps**: the horizontal lines at the ends of the whiskers.
- **fliers**: points representing data that extend beyond the whiskers (fliers).
- **means**: points or lines representing the means.

Other Parameters showcaps : bool, optional (True)

Show the caps on the ends of whiskers.

showbox : bool, optional (True)

Show the central box.

showfliers : bool, optional (True)

Show the outliers beyond the caps.

showmeans : bool, optional (False)

Show the arithmetic means.

capprops : dict, optional (None)

Specifies the style of the caps.

boxprops : dict, optional (None)

Specifies the style of the box.

whiskerprops : dict, optional (None)

Specifies the style of the whiskers.

flierprops : dict, optional (None)

Specifies the style of the fliers.

medianprops : dict, optional (None)

Specifies the style of the median.

meanprops : dict, optional (None)

Specifies the style of the mean.

Examples

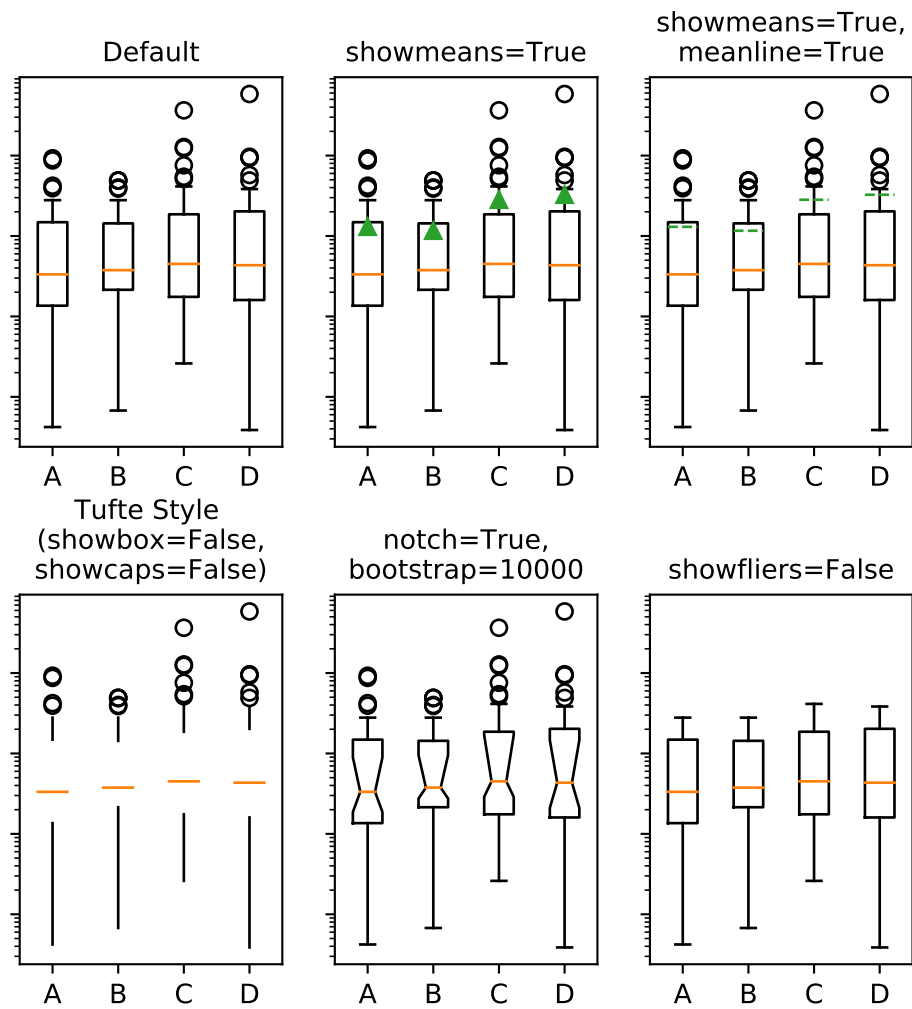

I never said they'd be pretty

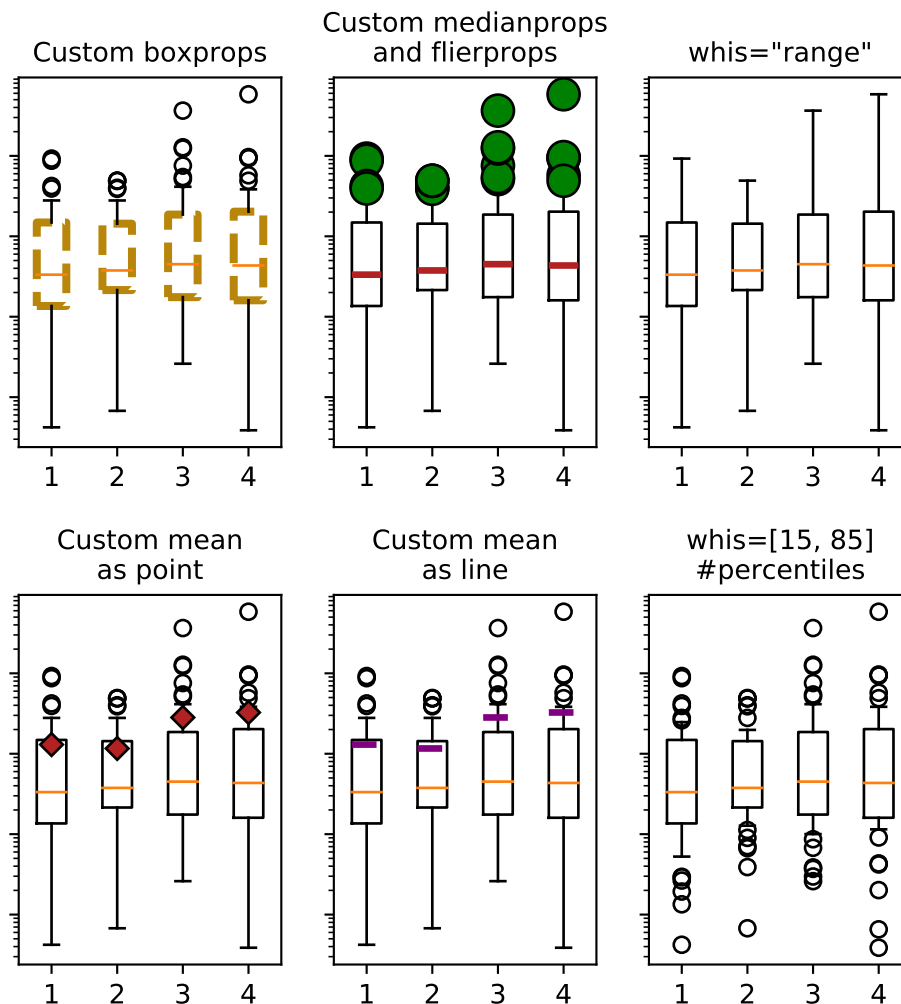

Note: In addition to the above described arguments, this function can take a **data** keyword argument. If such a **data** argument is given, the following arguments are replaced by **data[<arg>]**:

- All positional and all keyword arguments.

`matplotlib.pyplot.broken_barh(xranges, yrange, hold=None, data=None, **kwargs)`
 Plot horizontal bars.

A collection of horizontal bars spanning *yrange* with a sequence of *xranges*.

Required arguments:

Argument	Description
<i>xranges</i>	sequence of (<i>xmin</i> , <i>xwidth</i>)
<i>yrange</i>	sequence of (<i>ymin</i> , <i>ywidth</i>)

kwargs are `matplotlib.collections.BrokenBarHCollection` properties:

Property	Description
<code>agg_filter</code>	unknown
<code>alpha</code>	float or None
<code>animated</code>	[True False]
<code>antialiased</code> or <code>antialiaseds</code>	Boolean or sequence of booleans
<code>array</code>	unknown
<code>axes</code>	an <code>Axes</code> instance
<code>clim</code>	a length 2 sequence of floats
<code>clip_box</code>	a <code>matplotlib.transforms.Bbox</code> instance
<code>clip_on</code>	[True False]
<code>clip_path</code>	[(<code>Path</code> , <code>Transform</code>) <code>Patch</code> None]
<code>cmap</code>	a colormap or registered colormap name
<code>color</code>	matplotlib color arg or sequence of rgba tuples
<code>contains</code>	a callable function
<code>edgecolor</code> or <code>edgecolors</code>	matplotlib color spec or sequence of specs
<code>facecolor</code> or <code>facecolors</code>	matplotlib color spec or sequence of specs
<code>figure</code>	a <code>matplotlib.figure.Figure</code> instance
<code>gid</code>	an id string
<code>hatch</code>	['/' '\' ' ' '-' '+' 'x' 'o' 'O' '.' '*']
<code>label</code>	string or anything printable with '%s' conversion.
<code>linestyle</code> or <code>dashes</code> or <code>linestyles</code>	['solid' 'dashed', 'dashdot', 'dotted' (offset, on-off-dash-seq) '-' '--' '-. '
<code>linewidth</code> or <code>linewidths</code> or <code>lw</code>	float or sequence of floats
<code>norm</code>	unknown
<code>offset_position</code>	unknown
<code>offsets</code>	float or sequence of floats
<code>path_effects</code>	unknown
<code>picker</code>	[None float boolean callable]
<code>pickradius</code>	unknown
<code>rasterized</code>	[True False None]
<code>sketch_params</code>	unknown
<code>snap</code>	unknown
<code>transform</code>	<code>Transform</code> instance
<code>url</code>	a url string
<code>urls</code>	unknown
<code>visible</code>	[True False]
<code>zorder</code>	any number

these can either be a single argument, i.e.,:

```
facecolors = 'black'
```

or a sequence of arguments for the various bars, i.e.,:

```
facecolors = ('black', 'red', 'green')
```

Example:

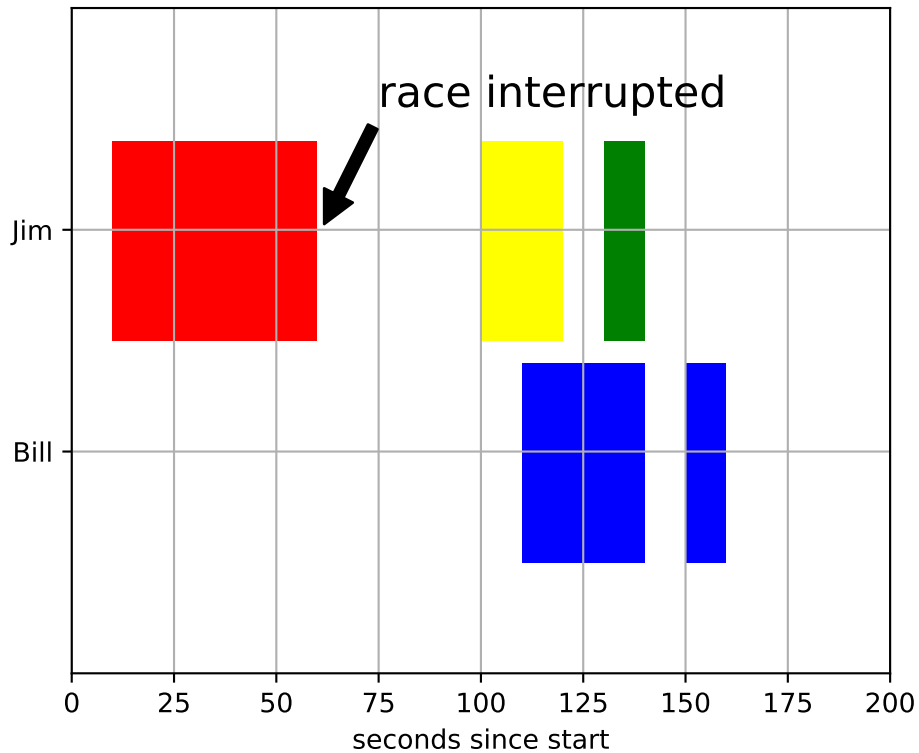

Note: In addition to the above described arguments, this function can take a **data** keyword argument. If such a **data** argument is given, the following arguments are replaced by **data[<arg>]**:

- All positional and all keyword arguments.

`matplotlib.pyplot.cla()`

Clear the current axes.

`matplotlib.pyplot.clabel(CS, *args, **kwargs)`

Label a contour plot.

Call signature:

```
clabel(cs, **kwargs)
```

Adds labels to line contours in *cs*, where *cs* is a `ContourSet` object returned by `contour`.

```
clabel(cs, v, **kwargs)
```

only labels contours listed in *v*.

Optional keyword arguments:

fontsize: size in points or relative size e.g., 'smaller', 'x-large'

colors:

- if *None*, the color of each label matches the color of the corresponding contour
- if one string color, e.g., *colors* = 'r' or *colors* = 'red', all labels will be plotted in this color
- if a tuple of matplotlib color args (string, float, rgb, etc), different labels will be plotted in different colors in the order specified

inline: controls whether the underlying contour is removed or not. Default is *True*.

inline_spacing: space in pixels to leave on each side of label when placing inline. Defaults to 5. This spacing will be exact for labels at locations where the contour is straight, less so for labels on curved contours.

fmt: a format string for the label. Default is '%1.3f' Alternatively, this can be a dictionary matching contour levels with arbitrary strings to use for each contour level (i.e., *fmt*[level]=string), or it can be any callable, such as a *Formatter* instance, that returns a string when called with a numeric contour level.

manual: if *True*, contour labels will be placed manually using mouse clicks. Click the first button near a contour to add a label, click the second button (or potentially both mouse buttons at once) to finish adding labels. The third button can be used to remove the last label added, but only if labels are not inline. Alternatively, the keyboard can be used to select label locations (enter to end label placement, delete or backspace act like the third mouse button, and any other key will select a label location).

manual can be an iterable object of x,y tuples. Contour labels will be created as if mouse is clicked at each x,y positions.

rightside_up: if *True* (default), label rotations will always be plus or minus 90 degrees from level.

use_clabeltext: if *True* (default is *False*), *ClabelText* class (instead of *matplotlib.Text*) is used to create labels. *ClabelText* recalculates rotation angles of texts during the drawing time, therefore this can be used if aspect of the axes changes.

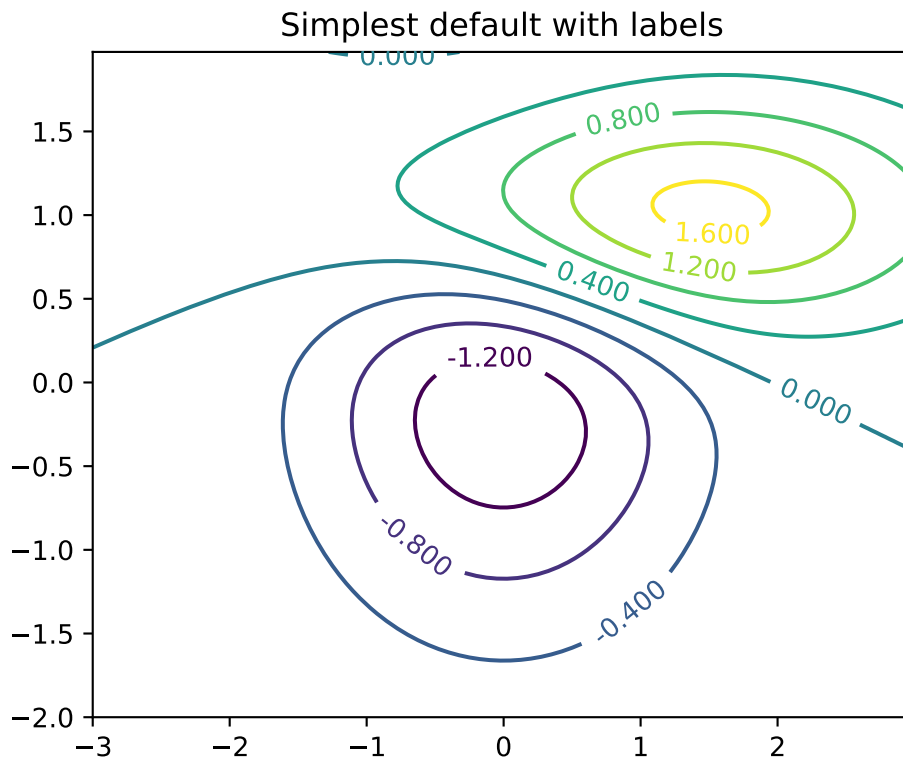

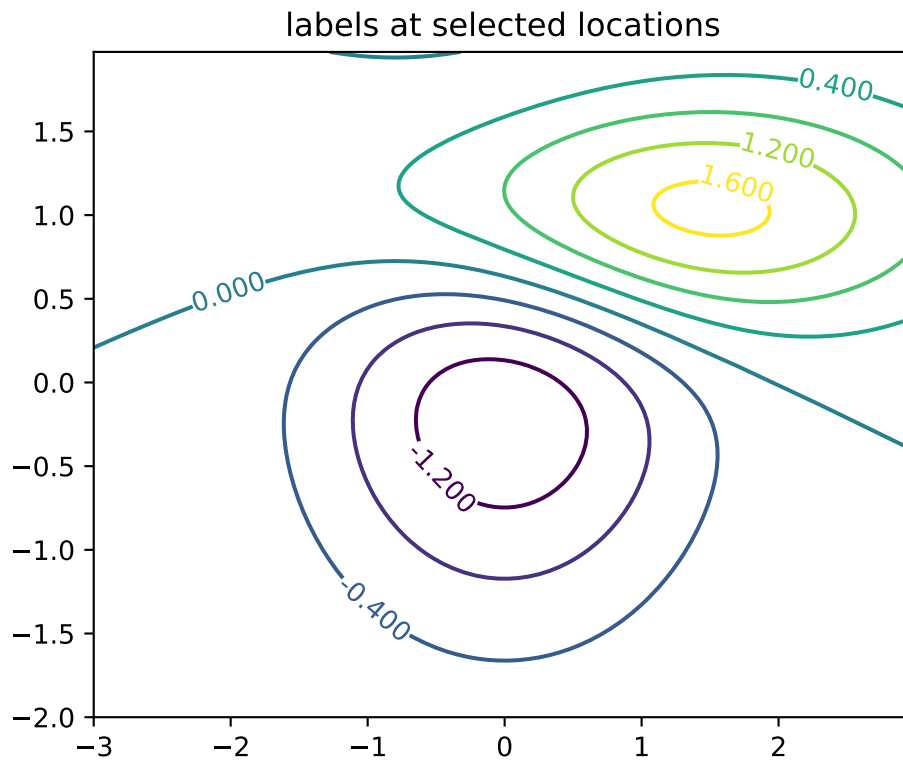

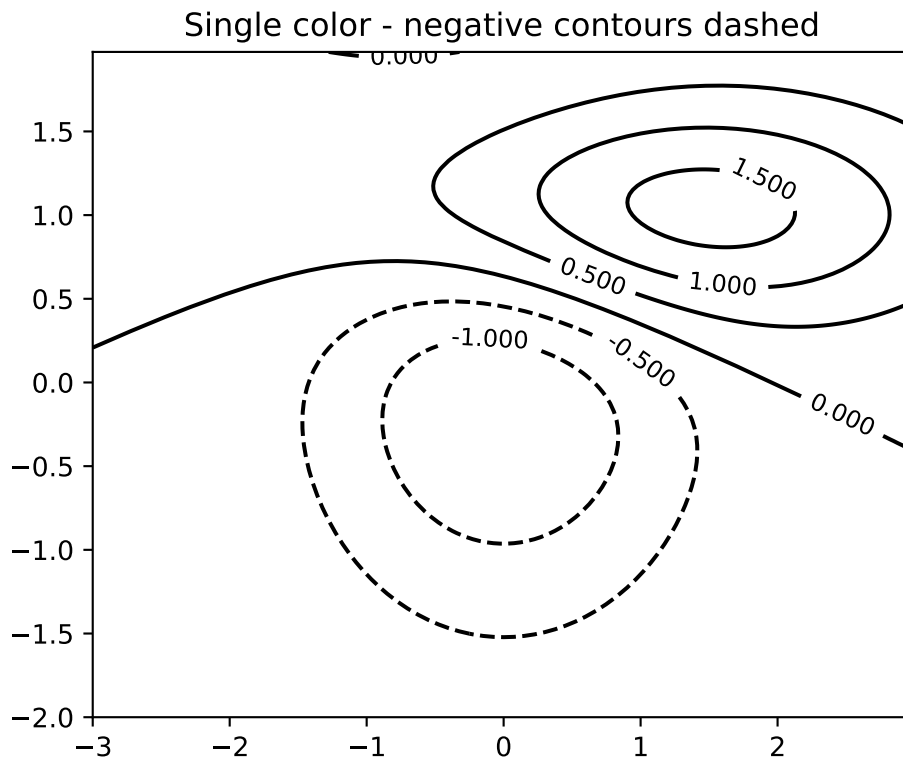

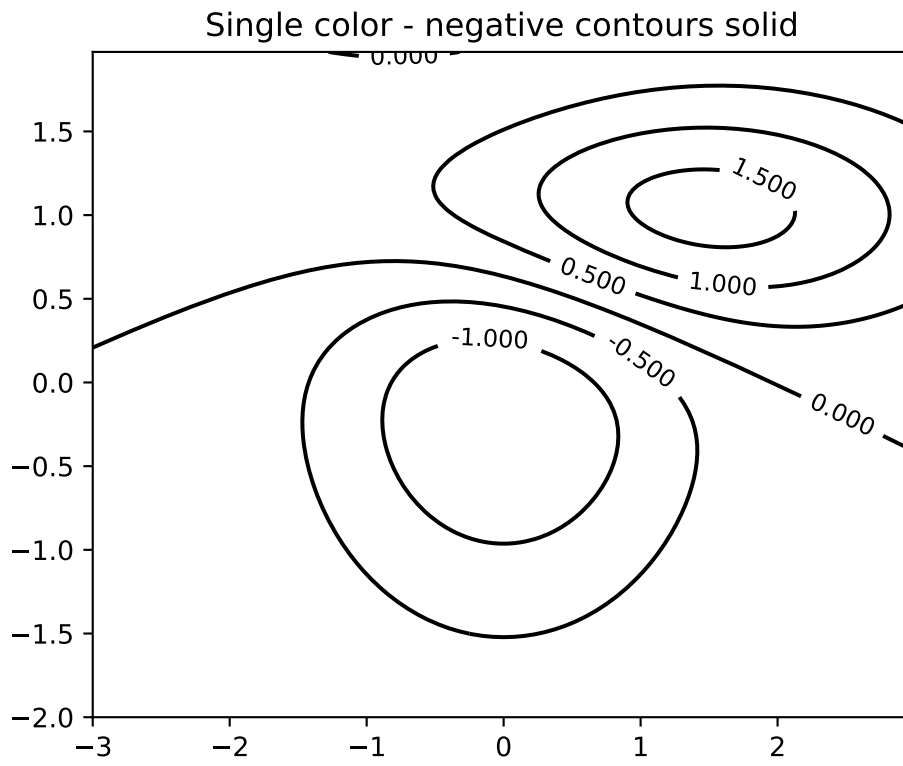

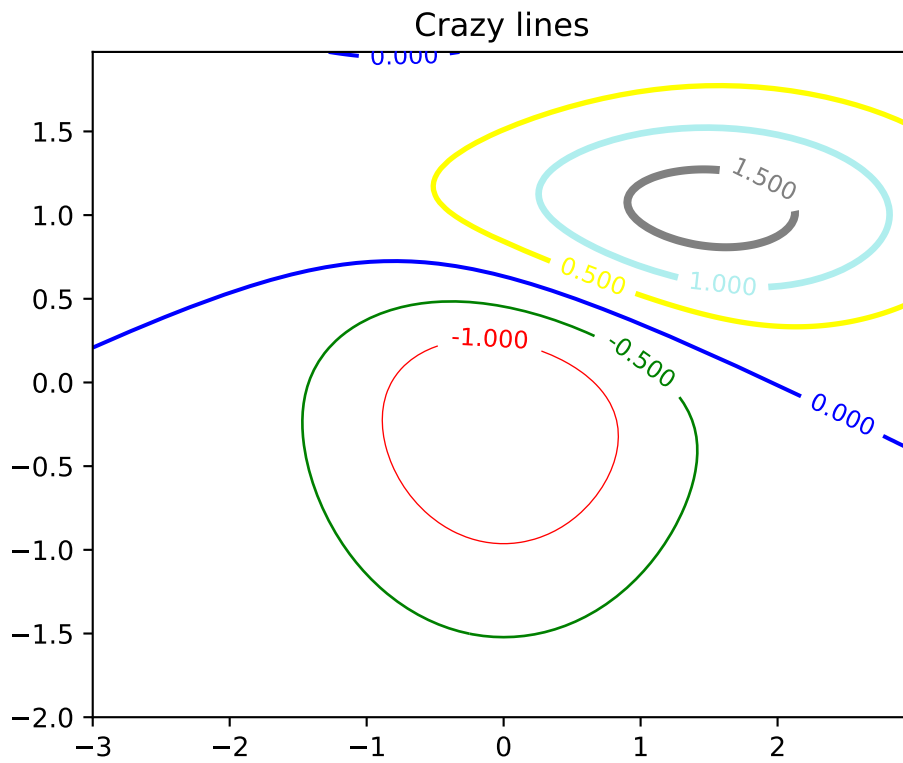

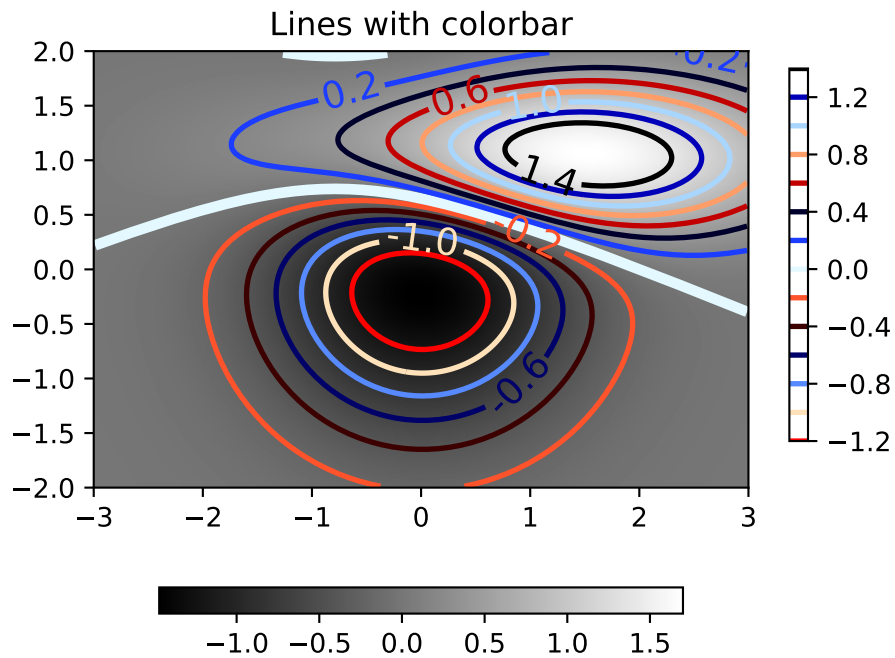

`matplotlib.pyplot.clf()`

Clear the current figure.

`matplotlib.pyplot.clim(vmin=None, vmax=None)`

Set the color limits of the current image.

To apply `clim` to all axes images do:

```
clim(0, 0.5)
```

If either `vmin` or `vmax` is `None`, the image min/max respectively will be used for color scaling.

If you want to set the `clim` of multiple images, use, for example:

```
for im in gca().get_images():
    im.set_clim(0, 0.05)
```

`matplotlib.pyplot.close(*args)`

Close a figure window.

`close()` by itself closes the current figure

`close(h)` where `h` is a `Figure` instance, closes that figure

`close(num)` closes figure number `num`

`close(name)` where `name` is a string, closes figure with that label

`close('all')` closes all the figure windows

`matplotlib.pyplot.cohere(x, y, NFFT=256, Fs=2, Fc=0, detrend=<function detrend_none>, window=<function window_hanning>, noverlap=0, pad_to=None, sides='default', scale_by_freq=None, hold=None, data=None, **kwargs)`

Plot the coherence between x and y .

Plot the coherence between x and y . Coherence is the normalized cross spectral density:

$$C_{xy} = \frac{|P_{xy}|^2}{P_{xx}P_{yy}} \quad (45.1)$$

Parameters Fs : scalar

The sampling frequency (samples per time unit). It is used to calculate the Fourier frequencies, `freqs`, in cycles per time unit. The default value is 2.

window : callable or ndarray

A function or a vector of length `NFFT`. To create window vectors see `window_hanning()`, `window_none()`, `numpy.blackman()`, `numpy.hamming()`, `numpy.bartlett()`, `scipy.signal()`, `scipy.signal.get_window()`, etc. The default is `window_hanning()`. If a function is passed as the argument, it must take a data segment as an argument and return the windowed version of the segment.

sides : ['default' | 'onesided' | 'twosided']

Specifies which sides of the spectrum to return. Default gives the default behavior, which returns one-sided for real data and both for complex data. 'onesided' forces the return of a one-sided spectrum, while 'twosided' forces two-sided.

pad_to : integer

The number of points to which the data segment is padded when performing the FFT. This can be different from `NFFT`, which specifies the number of data points used. While not increasing the actual resolution of the spectrum (the minimum distance between resolvable peaks), this can give more points in the plot, allowing for more detail. This corresponds to the n parameter in the call to `fft()`. The default is `None`, which sets `pad_to` equal to `NFFT`

NFFT : integer

The number of data points used in each block for the FFT. A power 2 is most efficient. The default value is 256. This should *NOT* be used to get zero padding, or the scaling of the result will be incorrect. Use `pad_to` for this instead.

detrend : { 'default', 'constant', 'mean', 'linear', 'none' } or callable

The function applied to each segment before `fft`-ing, designed to remove the mean or linear trend. Unlike in MATLAB, where the `detrend` parameter is a vector, in matplotlib it is a function. The `pylab` module defines

`detrend_none()`, `detrend_mean()`, and `detrend_linear()`, but you can use a custom function as well. You can also use a string to choose one of the functions. 'default', 'constant', and 'mean' call `detrend_mean()`. 'linear' calls `detrend_linear()`. 'none' calls `detrend_none()`.

scale_by_freq : boolean, optional

Specifies whether the resulting density values should be scaled by the scaling frequency, which gives density in units of Hz^{-1} . This allows for integration over the returned frequency values. The default is True for MATLAB compatibility.

noverlap : integer

The number of points of overlap between blocks. The default value is 0 (no overlap).

Fc : integer

The center frequency of x (defaults to 0), which offsets the x extents of the plot to reflect the frequency range used when a signal is acquired and then filtered and downsampled to baseband.

****kwargs** :

Keyword arguments control the *Line2D* properties of the coherence plot:

Property	Description
<i>agg_filter</i>	unknown
<i>alpha</i>	float (0.0 transparent through 1.0 opaque)
<i>animated</i>	[True False]
<i>antialiased</i> or <i>aa</i>	[True False]
<i>axes</i>	an <i>Axes</i> instance
<i>clip_box</i>	a <i>matplotlib.transforms.Bbox</i> instance
<i>clip_on</i>	[True False]
<i>clip_path</i>	[(<i>Path</i> , <i>Transform</i>) <i>Patch</i> None]
<i>color</i> or <i>c</i>	any matplotlib color
<i>contains</i>	a callable function
<i>dash_capstyle</i>	['butt' 'round' 'projecting']
<i>dash_joinstyle</i>	['miter' 'round' 'bevel']
<i>dashes</i>	sequence of on/off ink in points
<i>drawstyle</i>	['default' 'steps' 'steps-pre' 'steps-mid' 'steps-post']
<i>figure</i>	a <i>matplotlib.figure.Figure</i> instance
<i>fillstyle</i>	['full' 'left' 'right' 'bottom' 'top' 'none']
<i>gid</i>	an id string
<i>label</i>	string or anything printable with '%s' conversion.
<i>linestyle</i> or <i>ls</i>	['solid' 'dashed', 'dashdot', 'dotted' (offset, on-off-dash-seq) '- ' '-- ' '-. ' '']
<i>linewidth</i> or <i>lw</i>	float value in points
<i>marker</i>	<i>A valid marker style</i>

Table 45.10 – continued from previous page

Property	Description
<i>markeredgecolor</i> or <i>mec</i>	any matplotlib color
<i>markeredgewidth</i> or <i>mew</i>	float value in points
<i>markerfacecolor</i> or <i>mfc</i>	any matplotlib color
<i>markerfacecoloralt</i> or <i>mfcalt</i>	any matplotlib color
<i>markersize</i> or <i>ms</i>	float
<i>markevery</i>	[None int length-2 tuple of int slice list/array of int float length-2 tuple of float]
<i>path_effects</i>	unknown
<i>picker</i>	float distance in points or callable pick function <code>fn(artist, event)</code>
<i>pickradius</i>	float distance in points
<i>rasterized</i>	[True False None]
<i>sketch_params</i>	unknown
<i>snap</i>	unknown
<i>solid_capstyle</i>	['butt' 'round' 'projecting']
<i>solid_joinstyle</i>	['miter' 'round' 'bevel']
<i>transform</i>	a <i>matplotlib.transforms.Transform</i> instance
<i>url</i>	a url string
<i>visible</i>	[True False]
<i>xdata</i>	1D array
<i>ydata</i>	1D array
<i>zorder</i>	any number

Returns The return value is a tuple (C_{xy}, f) , where f are the frequencies of the coherence vector.
 kwargs are applied to the lines.

References

Bendat & Piersol – Random Data: Analysis and Measurement Procedures, John Wiley & Sons (1986)

Examples

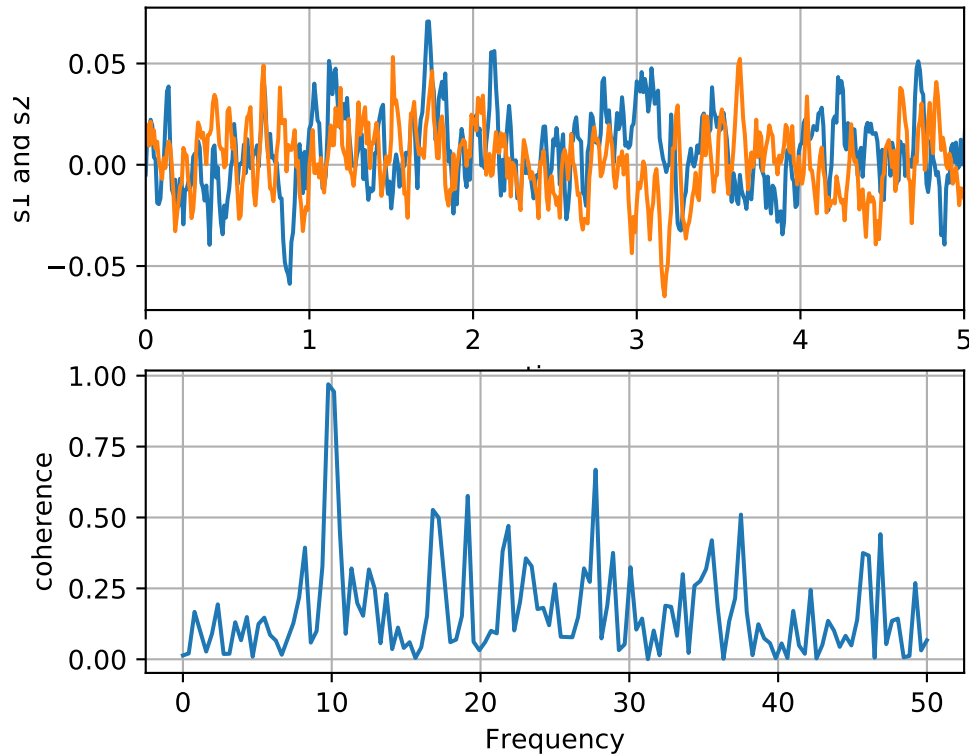

Note: In addition to the above described arguments, this function can take a **data** keyword argument. If such a **data** argument is given, the following arguments are replaced by **data[<arg>]**:

- All arguments with the following names: 'x', 'y'.
-

`matplotlib.pyplot.colorbar(mappable=None, cax=None, ax=None, **kw)`

Add a colorbar to a plot.

Function signatures for the *pyplot* interface; all but the first are also method signatures for the *colorbar()* method:

```
colorbar(**kwargs)
colorbar(mappable, **kwargs)
colorbar(mappable, cax=cax, **kwargs)
colorbar(mappable, ax=ax, **kwargs)
```

arguments:

mappable the Image, ContourSet, etc. to which the colorbar applies; this argument is mandatory for the *colorbar()* method but optional for the *colorbar()* function, which sets the default to the current image.

keyword arguments:

cax None | axes object into which the colorbar will be drawn

ax None | parent axes object(s) from which space for a new colorbar axes will be stolen. If a list of axes is given they will all be resized to make room for the colorbar axes.

use_gridspec False | If *cax* is None, a new *cax* is created as an instance of Axes. If *ax* is an instance of Subplot and *use_gridspec* is True, *cax* is created as an instance of Subplot using the *grid_spec* module.

Additional keyword arguments are of two kinds:

axes properties:

Property	Description
<i>orientation</i>	vertical or horizontal
<i>fraction</i>	0.15; fraction of original axes to use for colorbar
<i>pad</i>	0.05 if vertical, 0.15 if horizontal; fraction of original axes between colorbar and new image axes
<i>shrink</i>	1.0; fraction by which to shrink the colorbar
<i>aspect</i>	20; ratio of long to short dimensions
<i>anchor</i>	(0.0, 0.5) if vertical; (0.5, 1.0) if horizontal; the anchor point of the colorbar axes
<i>panchor</i>	(1.0, 0.5) if vertical; (0.5, 0.0) if horizontal; the anchor point of the colorbar parent axes. If False, the parent axes' anchor will be unchanged

colorbar properties:

Property	Description
<i>extend</i>	['neither' 'both' 'min' 'max'] If not 'neither', make pointed end(s) for out-of-range values. These are set for a given colormap using the colormap <code>set_under</code> and <code>set_over</code> methods.
<i>extendfrac</i>	[<i>None</i> 'auto' length lengths] If set to <i>None</i> , both the minimum and maximum triangular colorbar extensions will have a length of 5% of the interior colorbar length (this is the default setting). If set to 'auto', makes the triangular colorbar extensions the same lengths as the interior boxes (when <i>spacing</i> is set to 'uniform') or the same lengths as the respective adjacent interior boxes (when <i>spacing</i> is set to 'proportional'). If a scalar, indicates the length of both the minimum and maximum triangular colorbar extensions as a fraction of the interior colorbar length. A two-element sequence of fractions may also be given, indicating the lengths of the minimum and maximum colorbar extensions respectively as a fraction of the interior colorbar length.
<i>extendedirect</i>	[<i>False</i> <i>True</i>] If <i>False</i> the minimum and maximum colorbar extensions will be triangular (the default). If <i>True</i> the extensions will be rectangular.
<i>spacing</i>	['uniform' 'proportional'] Uniform spacing gives each discrete color the same space; proportional makes the space proportional to the data interval.
<i>ticks</i>	[<i>None</i> list of ticks Locator object] If <i>None</i> , ticks are determined automatically from the input.
<i>format</i>	[<i>None</i> format string Formatter object] If <i>None</i> , the <code>ScalarFormatter</code> is used. If a format string is given, e.g., '%.3f', that is used. An alternative <code>Formatter</code> object may be given instead.
<i>drawedges</i>	[<i>False</i> <i>True</i>] If true, draw lines at color boundaries.

The following will probably be useful only in the context of indexed colors (that is, when the mappable has `norm=NoNorm()`), or other unusual circumstances.

Property	Description
<i>boundaries</i>	<i>None</i> or a sequence
<i>values</i>	<i>None</i> or a sequence which must be of length 1 less than the sequence of <i>boundaries</i> . For each region delimited by adjacent entries in <i>boundaries</i> , the color mapped to the corresponding value in <i>values</i> will be used.

If *mappable* is a `ContourSet`, its *extend* kwarg is included automatically.

Note that the *shrink* kwarg provides a simple way to keep a vertical colorbar, for example, from being taller than the axes of the mappable to which the colorbar is attached; but it is a manual method requiring some trial and error. If the colorbar is too tall (or a horizontal colorbar is too wide) use a smaller value of *shrink*.

For more precise control, you can manually specify the positions of the axes objects in which the

mappable and the colorbar are drawn. In this case, do not use any of the axes properties kwargs.

It is known that some vector graphics viewer (svg and pdf) renders white gaps between segments of the colorbar. This is due to bugs in the viewers not matplotlib. As a workaround the colorbar can be rendered with overlapping segments:

```
cbar = colorbar()  
cbar.solids.set_edgecolor("face")  
draw()
```

However this has negative consequences in other circumstances. Particularly with semi transparent images ($\alpha < 1$) and colorbar extensions and is not enabled by default see (issue #1188).

returns: *Colorbar* instance; see also its base class, *ColorbarBase*. Call the *set_label()* method to label the colorbar.

matplotlib.pyplot.colors()

This is a do-nothing function to provide you with help on how matplotlib handles colors.

Commands which take color arguments can use several formats to specify the colors. For the basic built-in colors, you can use a single letter

Alias	Color
'b'	blue
'g'	green
'r'	red
'c'	cyan
'm'	magenta
'y'	yellow
'k'	black
'w'	white

For a greater range of colors, you have two options. You can specify the color using an html hex string, as in:

```
color = '#eeefff'
```

or you can pass an R,G,B tuple, where each of R,G,B are in the range [0,1].

You can also use any legal html name for a color, for example:

```
color = 'red'  
color = 'burlywood'  
color = 'chartreuse'
```

The example below creates a subplot with a dark slate gray background:

```
subplot(111, facecolor=(0.1843, 0.3098, 0.3098))
```

Here is an example that creates a pale turquoise title:

```
title('Is this the best color?', color='#afeeee')
```

`matplotlib.pyplot.connect(s, func)`

Connect event with string *s* to *func*. The signature of *func* is:

```
def func(event)
```

where event is a `matplotlib.backend_bases.Event`. The following events are recognized

- 'button_press_event'
- 'button_release_event'
- 'draw_event'
- 'key_press_event'
- 'key_release_event'
- 'motion_notify_event'
- 'pick_event'
- 'resize_event'
- 'scroll_event'
- 'figure_enter_event',
- 'figure_leave_event',
- 'axes_enter_event',
- 'axes_leave_event'
- 'close_event'

For the location events (button and key press/release), if the mouse is over the axes, the variable `event.inaxes` will be set to the `Axes` the event occurs is over, and additionally, the variables `event.xdata` and `event.ydata` will be defined. This is the mouse location in data coords. See `KeyEvent` and `MouseEvent` for more info.

Return value is a connection id that can be used with `mpl_disconnect()`.

Example usage:

```
def on_press(event):
    print('you pressed', event.button, event.xdata, event.ydata)

cid = canvas.mpl_connect('button_press_event', on_press)
```

`matplotlib.pyplot.contour(*args, **kwargs)`

Plot contours.

`contour()` and `contourf()` draw contour lines and filled contours, respectively. Except as noted, function signatures and return values are the same for both versions.

`contourf()` differs from the MATLAB version in that it does not draw the polygon edges. To draw edges, add line contours with calls to `contour()`.

Call signatures:

```
contour(Z)
```

make a contour plot of an array *Z*. The level values are chosen automatically.

```
contour(X, Y, Z)
```

X, *Y* specify the (x, y) coordinates of the surface

```
contour(Z, N)
contour(X, Y, Z, N)
```

contour up to *N* automatically-chosen levels.

```
contour(Z, V)
contour(X, Y, Z, V)
```

draw contour lines at the values specified in sequence *V*, which must be in increasing order.

```
contourf(..., V)
```

fill the $\text{len}(V) - 1$ regions between the values in *V*, which must be in increasing order.

```
contour(Z, **kwargs)
```

Use keyword args to control colors, linewidth, origin, cmap ... see below for more details.

X and *Y* must both be 2-D with the same shape as *Z*, or they must both be 1-D such that $\text{len}(X)$ is the number of columns in *Z* and $\text{len}(Y)$ is the number of rows in *Z*.

C = `contour(...)` returns a `QuadContourSet` object.

Optional keyword arguments:

corner_mask: [*True* | *False* | 'legacy'] Enable/disable corner masking, which only has an effect if *Z* is a masked array. If *False*, any quad touching a masked point is masked out. If *True*, only the triangular corners of quads nearest those points are always masked out, other triangular corners comprising three unmasked points are contoured as usual. If 'legacy', the old contouring algorithm is used, which is equivalent to *False* and is deprecated, only remaining whilst the new algorithm is tested fully.

If not specified, the default is taken from `rcParams['contour.corner_mask']`, which is *True* unless it has been modified.

colors: [*None* | string | (mpl_colors)] If *None*, the colormap specified by `cmap` will be used.

If a string, like 'r' or 'red', all levels will be plotted in this color.

If a tuple of matplotlib color args (string, float, rgb, etc), different levels will be plotted in different colors in the order specified.

alpha: float The alpha blending value

cmap: [*None* | **Colormap**] A cm *Colormap* instance or *None*. If *cmap* is *None* and *colors* is *None*, a default Colormap is used.

norm: [*None* | **Normalize**] A `matplotlib.colors.Normalize` instance for scaling data values to colors. If *norm* is *None* and *colors* is *None*, the default linear scaling is used.

vmin, vmax: [*None* | **scalar**] If not *None*, either or both of these values will be supplied to the `matplotlib.colors.Normalize` instance, overriding the default color scaling based on *levels*.

levels: [**level0**, **level1**, ..., **leveln**] A list of floating point numbers indicating the level curves to draw, in increasing order; e.g., to draw just the zero contour pass `levels=[0]`

origin: [*None* | **'upper'** | **'lower'** | **'image'**] If *None*, the first value of *Z* will correspond to the lower left corner, location (0,0). If **'image'**, the rc value for `image.origin` will be used.

This keyword is not active if *X* and *Y* are specified in the call to `contour`.

extent: [*None* | (*x0*,*x1*,*y0*,*y1*)]

If *origin* is not *None*, then *extent* is interpreted as in `matplotlib.pyplot.imshow()`: it gives the outer pixel boundaries. In this case, the position of `Z[0,0]` is the center of the pixel, not a corner. If *origin* is *None*, then (*x0*, *y0*) is the position of `Z[0,0]`, and (*x1*, *y1*) is the position of `Z[-1,-1]`.

This keyword is not active if *X* and *Y* are specified in the call to `contour`.

locator: [*None* | **ticker.Locator subclass**] If *locator* is *None*, the default `MaxNLocator` is used. The locator is used to determine the contour levels if they are not given explicitly via the *V* argument.

extend: [**'neither'** | **'both'** | **'min'** | **'max'**] Unless this is **'neither'**, contour levels are automatically added to one or both ends of the range so that all data are included. These added ranges are then mapped to the special colormap values which default to the ends of the colormap range, but can be set via `matplotlib.colors.Colormap.set_under()` and `matplotlib.colors.Colormap.set_over()` methods.

xunits, yunits: [*None* | **registered units**] Override axis units by specifying an instance of a `matplotlib.units.ConversionInterface`.

antialiased: [**True** | **False**] enable antialiasing, overriding the defaults. For filled contours, the default is *True*. For line contours, it is taken from `rcParams['lines.antialiased']`.

nchunk: [**0** | **integer**] If 0, no subdivision of the domain. Specify a positive integer to divide the domain into subdomains of *nchunk* by *nchunk* quads. Chunking reduces the maximum length of polygons generated by the contouring algorithm which reduces the rendering workload passed on to the backend and also requires slightly less RAM. It can however introduce rendering artifacts at chunk boundaries depending on the backend, the *antialiased* flag and value of *alpha*.

contour-only keyword arguments:

linewidths: [*None* | **number** | **tuple of numbers**] If *linewidths* is *None*, the default width in `lines.linewidth` in `matplotlibrc` is used.

If a number, all levels will be plotted with this linewidth.

If a tuple, different levels will be plotted with different linewidths in the order specified.

linestyles: [*None* | **'solid'** | **'dashed'** | **'dashdot'** | **'dotted'**] If *linestyles* is *None*, the default is **'solid'** unless the lines are monochrome. In that case, negative contours will take their linestyle from the `matplotlibrc` `contour.negative_linestyle` setting.

linestyles can also be an iterable of the above strings specifying a set of linestyles to be used. If this iterable is shorter than the number of contour levels it will be repeated as necessary.

contourf-only keyword arguments:

hatches: A list of cross hatch patterns to use on the filled areas. If *None*, no hatching will be added to the contour. Hatching is supported in the PostScript, PDF, SVG and Agg backends only.

Note: `contourf` fills intervals that are closed at the top; that is, for boundaries $z1$ and $z2$, the filled region is:

$$z1 < z \leq z2$$

There is one exception: if the lowest boundary coincides with the minimum value of the z array, then that minimum value will be included in the lowest interval.

Examples:

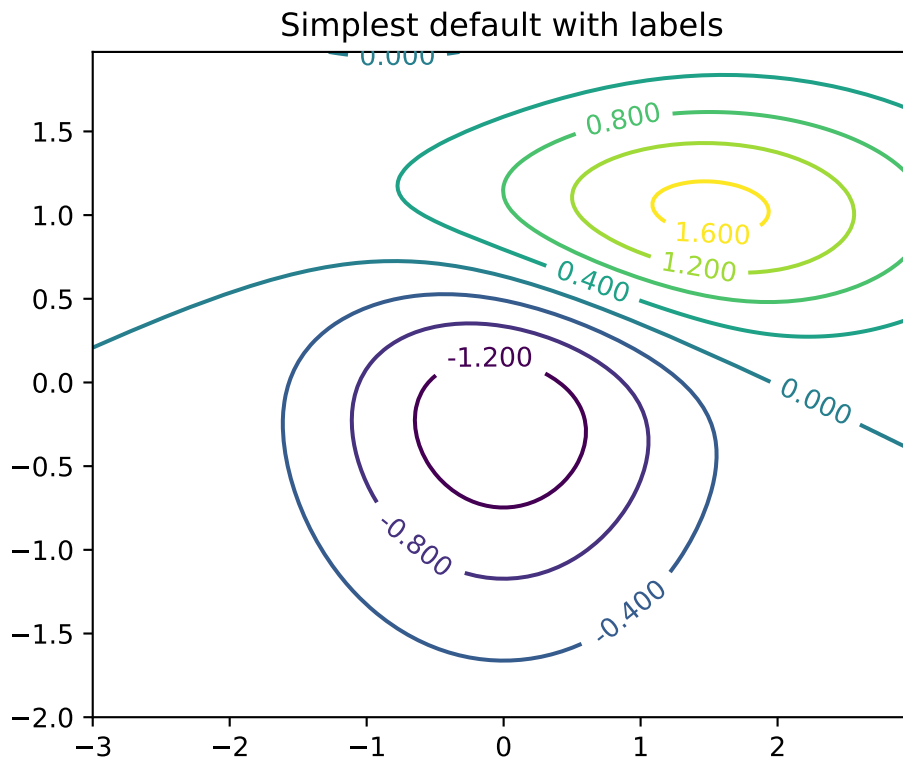

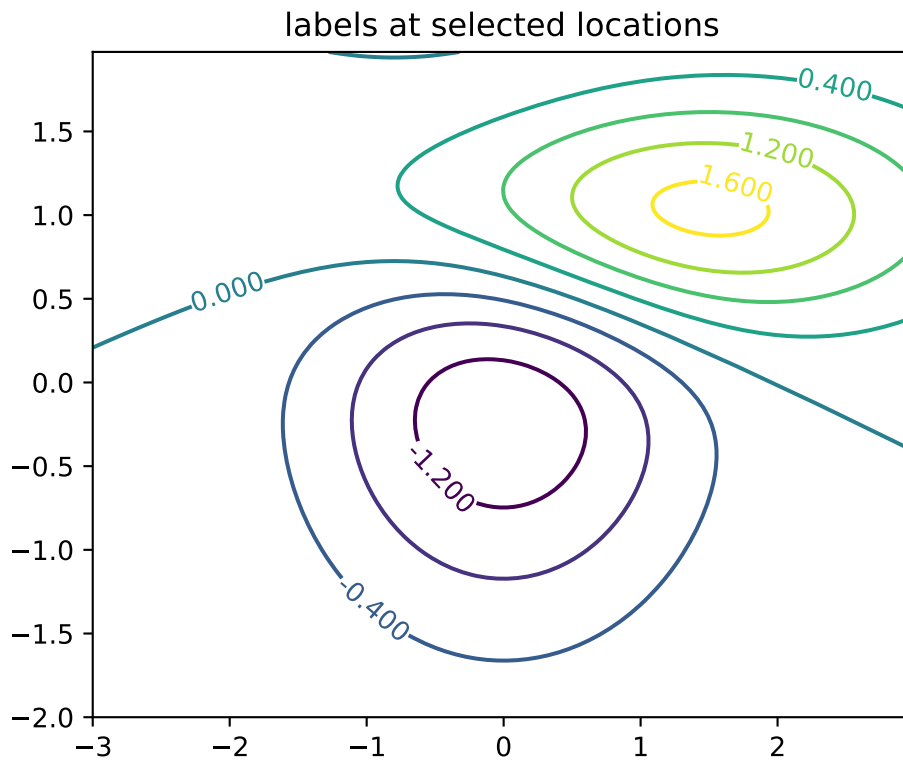

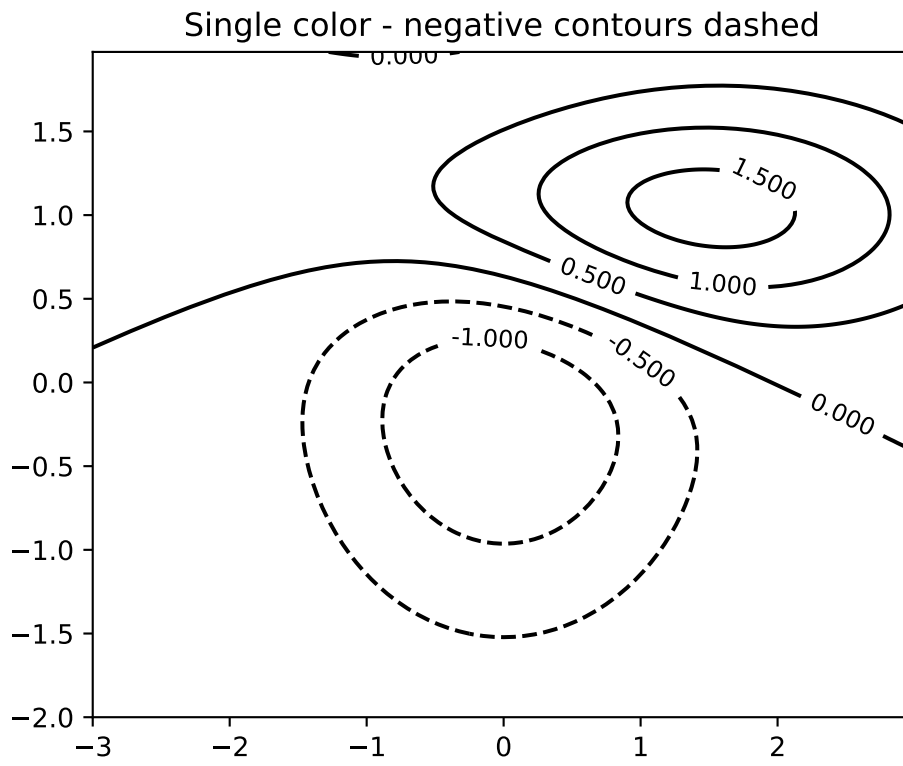

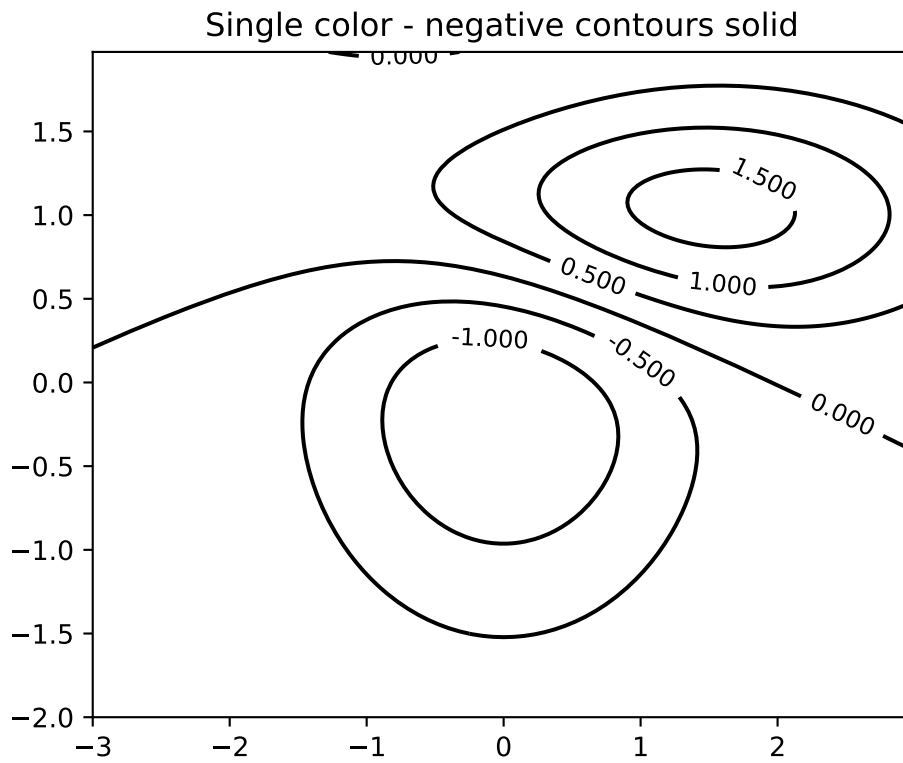

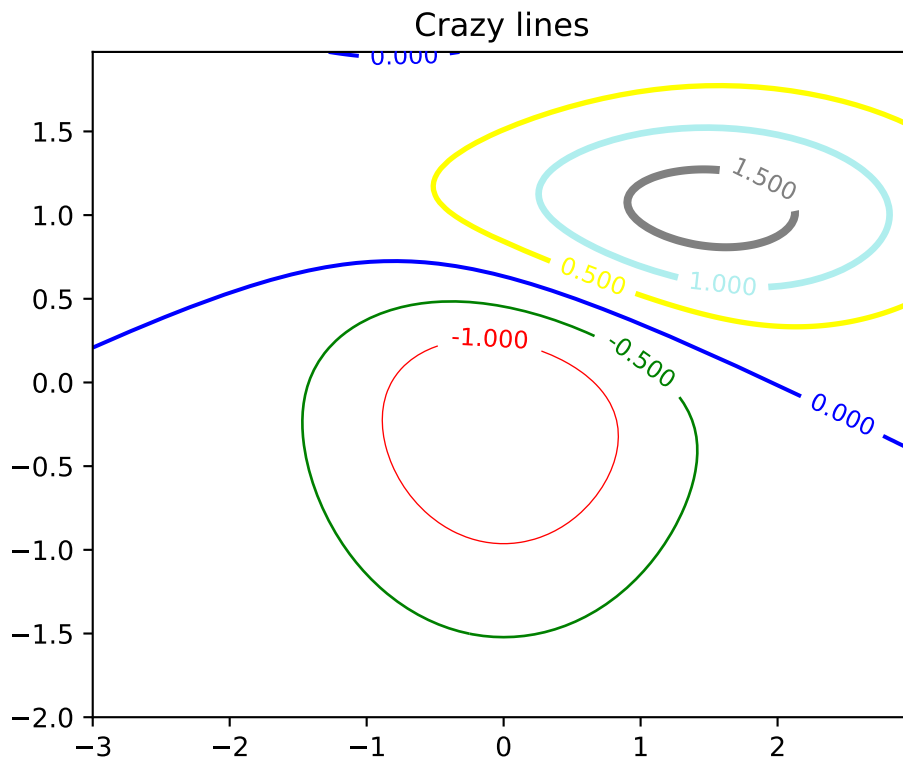

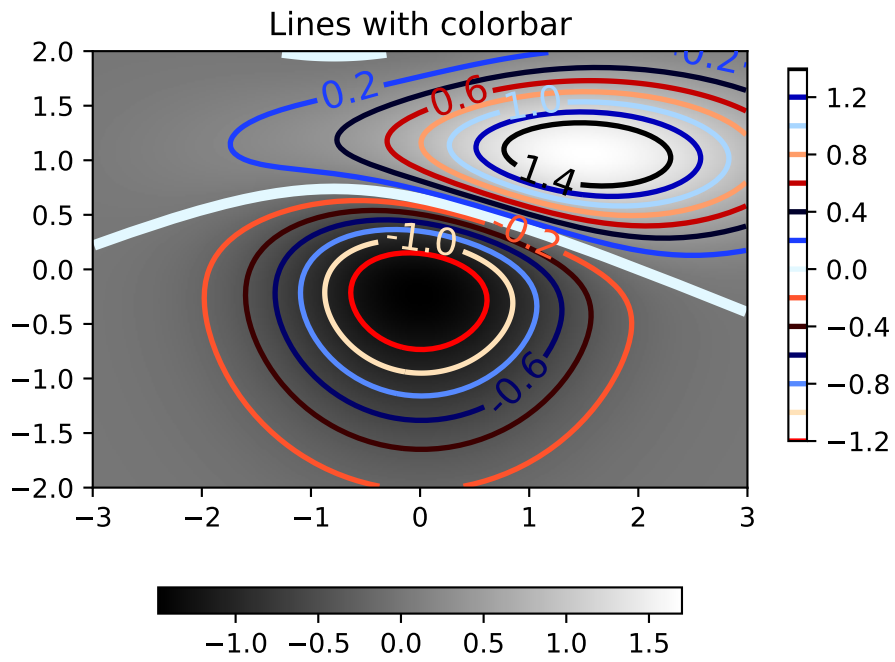

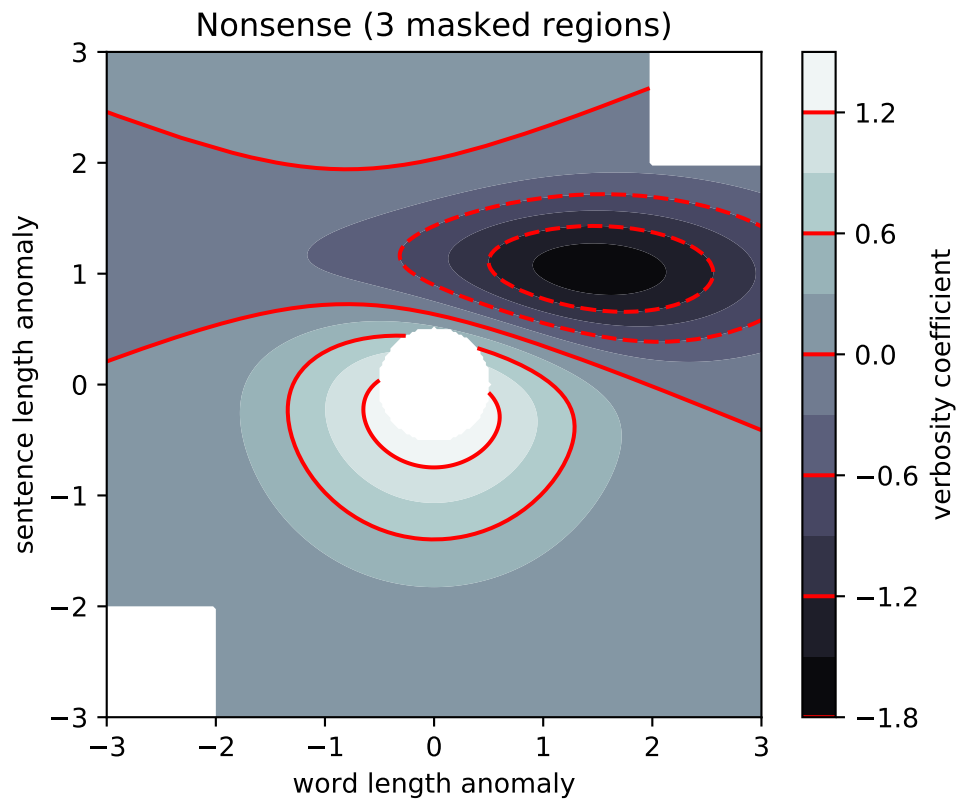

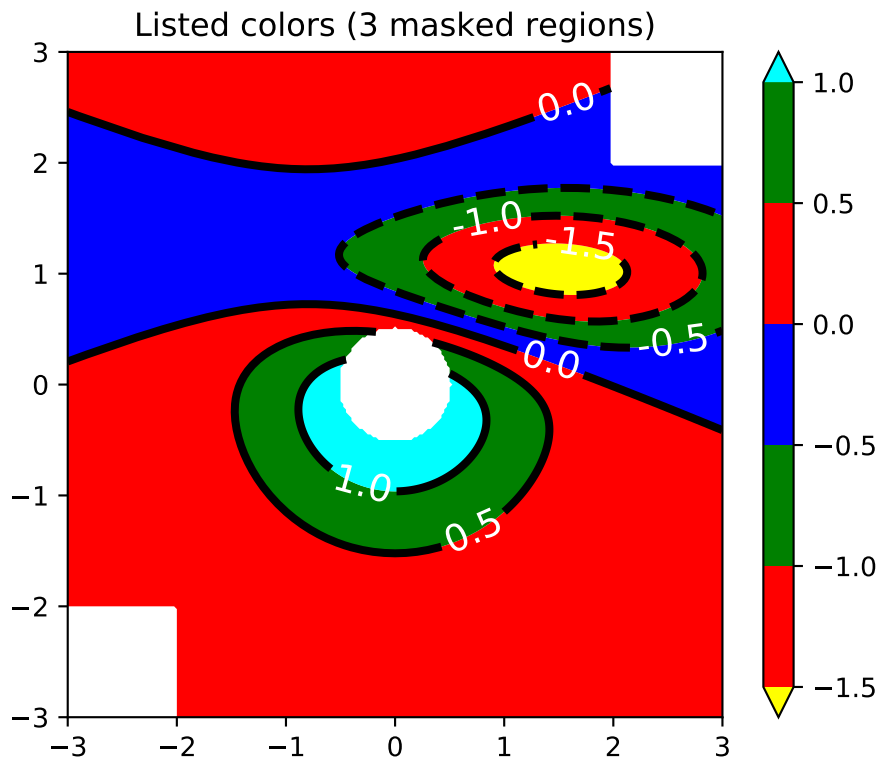

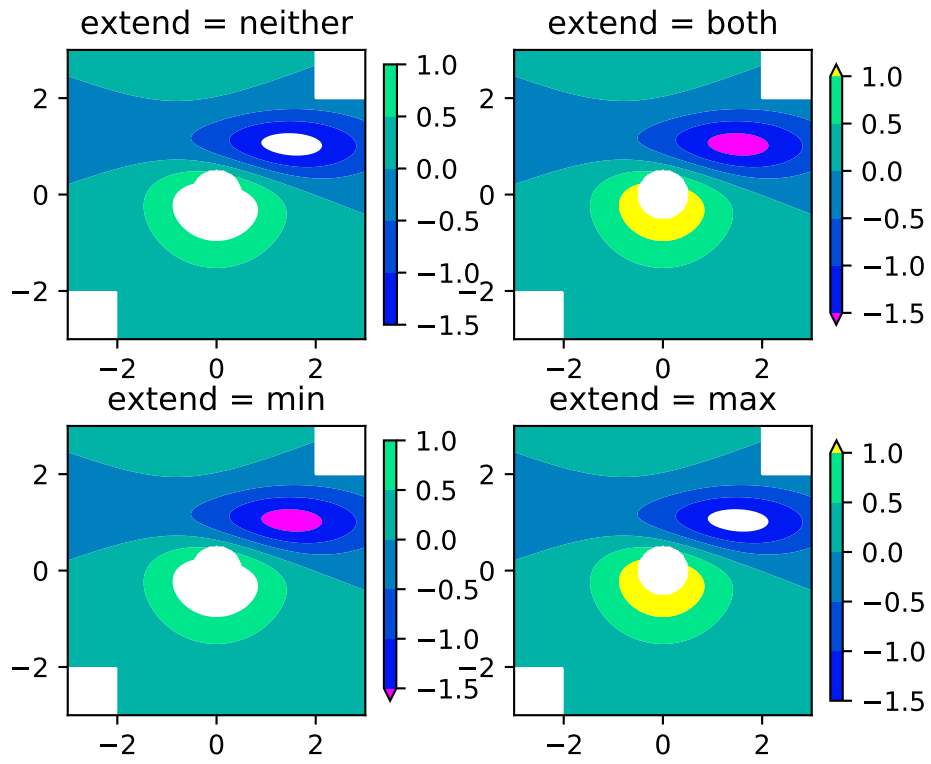

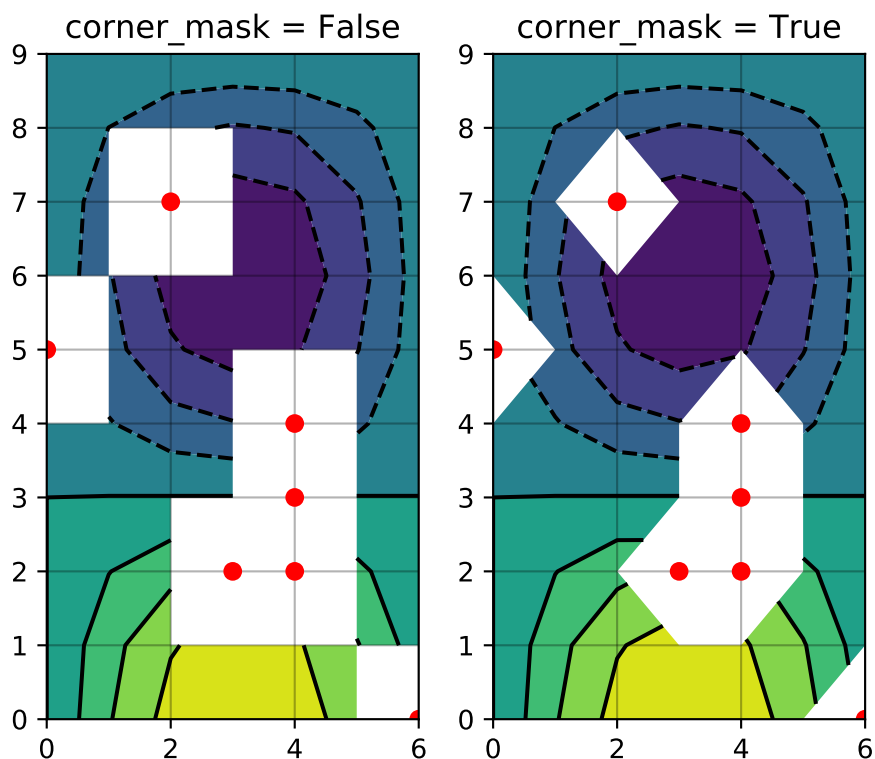

`matplotlib.pyplot.contourf(*args, **kwargs)`

Plot contours.

`contour()` and `contourf()` draw contour lines and filled contours, respectively. Except as noted, function signatures and return values are the same for both versions.

`contourf()` differs from the MATLAB version in that it does not draw the polygon edges. To draw edges, add line contours with calls to `contour()`.

Call signatures:

```
contour(Z)
```

make a contour plot of an array `Z`. The level values are chosen automatically.

```
contour(X, Y, Z)
```

`X`, `Y` specify the (x, y) coordinates of the surface

```
contour(Z, N)
contour(X, Y, Z, N)
```

contour up to `N` automatically-chosen levels.

```
contour(Z, V)
contour(X, Y, Z, V)
```

draw contour lines at the values specified in sequence V , which must be in increasing order.

```
contourf(..., V)
```

fill the $\text{len}(V) - 1$ regions between the values in V , which must be in increasing order.

```
contour(Z, **kwargs)
```

Use keyword args to control colors, linewidth, origin, cmap ... see below for more details.

X and Y must both be 2-D with the same shape as Z , or they must both be 1-D such that $\text{len}(X)$ is the number of columns in Z and $\text{len}(Y)$ is the number of rows in Z .

$C = \text{contour}(\dots)$ returns a `QuadContourSet` object.

Optional keyword arguments:

corner_mask: [*True* | *False* | 'legacy'] Enable/disable corner masking, which only has an effect if Z is a masked array. If *False*, any quad touching a masked point is masked out. If *True*, only the triangular corners of quads nearest those points are always masked out, other triangular corners comprising three unmasked points are contoured as usual. If 'legacy', the old contouring algorithm is used, which is equivalent to *False* and is deprecated, only remaining whilst the new algorithm is tested fully.

If not specified, the default is taken from `rcParams['contour.corner_mask']`, which is *True* unless it has been modified.

colors: [*None* | string | (mpl_colors)] If *None*, the colormap specified by `cmap` will be used.

If a string, like 'r' or 'red', all levels will be plotted in this color.

If a tuple of matplotlib color args (string, float, rgb, etc), different levels will be plotted in different colors in the order specified.

alpha: float The alpha blending value

cmap: [*None* | Colormap] A `cm.Colormap` instance or *None*. If `cmap` is *None* and `colors` is *None*, a default `Colormap` is used.

norm: [*None* | Normalize] A `matplotlib.colors.Normalize` instance for scaling data values to colors. If `norm` is *None* and `colors` is *None*, the default linear scaling is used.

vmin, vmax: [*None* | scalar] If not *None*, either or both of these values will be supplied to the `matplotlib.colors.Normalize` instance, overriding the default color scaling based on `levels`.

levels: [level0, level1, ..., leveln] A list of floating point numbers indicating the level curves to draw, in increasing order; e.g., to draw just the zero contour pass `levels=[0]`

origin: [*None* | 'upper' | 'lower' | 'image'] If *None*, the first value of Z will correspond to the lower left corner, location (0,0). If 'image', the `rc` value for `image.origin` will be used.

This keyword is not active if X and Y are specified in the call to `contour`.

extent: [*None* | (x_0, x_1, y_0, y_1)]

If *origin* is not *None*, then *extent* is interpreted as in `matplotlib.pyplot.imshow()`: it gives the outer pixel boundaries. In this case, the position of $Z[0,0]$ is the center of the pixel, not a corner. If *origin* is *None*, then (x_0, y_0) is the position of $Z[0,0]$, and (x_1, y_1) is the position of $Z[-1,-1]$.

This keyword is not active if X and Y are specified in the call to `contour`.

locator: [*None* | `ticker.Locator` subclass] If *locator* is *None*, the default `MaxNLocator` is used. The locator is used to determine the contour levels if they are not given explicitly via the V argument.

extend: ['neither' | 'both' | 'min' | 'max'] Unless this is 'neither', contour levels are automatically added to one or both ends of the range so that all data are included. These added ranges are then mapped to the special colormap values which default to the ends of the colormap range, but can be set via `matplotlib.colors.Colormap.set_under()` and `matplotlib.colors.Colormap.set_over()` methods.

xunits, yunits: [*None* | registered units] Override axis units by specifying an instance of a `matplotlib.units.ConversionInterface`.

antialiased: [*True* | *False*] enable antialiasing, overriding the defaults. For filled contours, the default is *True*. For line contours, it is taken from `rcParams['lines.antialiased']`.

nchunk: [0 | integer] If 0, no subdivision of the domain. Specify a positive integer to divide the domain into subdomains of $nchunk$ by $nchunk$ quads. Chunking reduces the maximum length of polygons generated by the contouring algorithm which reduces the rendering workload passed on to the backend and also requires slightly less RAM. It can however introduce rendering artifacts at chunk boundaries depending on the backend, the *antialiased* flag and value of *alpha*.

contour-only keyword arguments:

linewidths: [*None* | number | tuple of numbers] If *linewidths* is *None*, the default width in `lines.linewidth` in `matplotlibrc` is used.

If a number, all levels will be plotted with this linewidth.

If a tuple, different levels will be plotted with different linewidths in the order specified.

linestyles: [*None* | 'solid' | 'dashed' | 'dashdot' | 'dotted'] If *linestyles* is *None*, the default is 'solid' unless the lines are monochrome. In that case, negative contours will take their linestyle from the `matplotlibrc` `contour.negative_linestyle` setting.

linestyles can also be an iterable of the above strings specifying a set of linestyles to be used. If this iterable is shorter than the number of contour levels it will be repeated as necessary.

contourf-only keyword arguments:

hatches: A list of cross hatch patterns to use on the filled areas. If None, no hatching will be added to the contour. Hatching is supported in the PostScript, PDF, SVG and Agg backends only.

Note: contourf fills intervals that are closed at the top; that is, for boundaries $z1$ and $z2$, the filled region is:

$$z1 < z \leq z2$$

There is one exception: if the lowest boundary coincides with the minimum value of the z array, then that minimum value will be included in the lowest interval.

Examples:

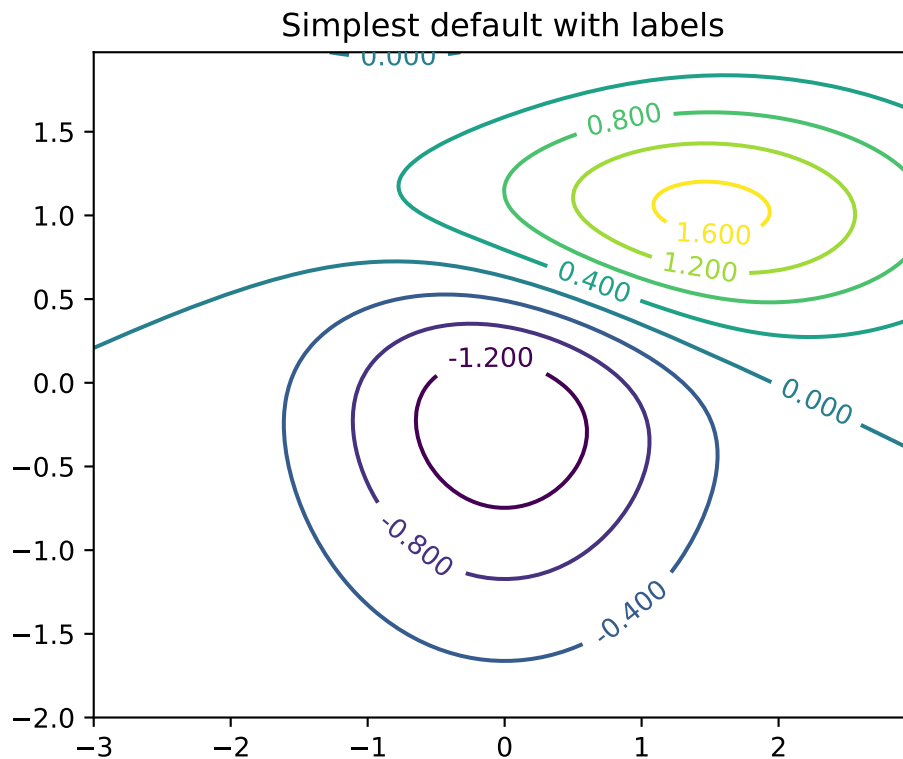

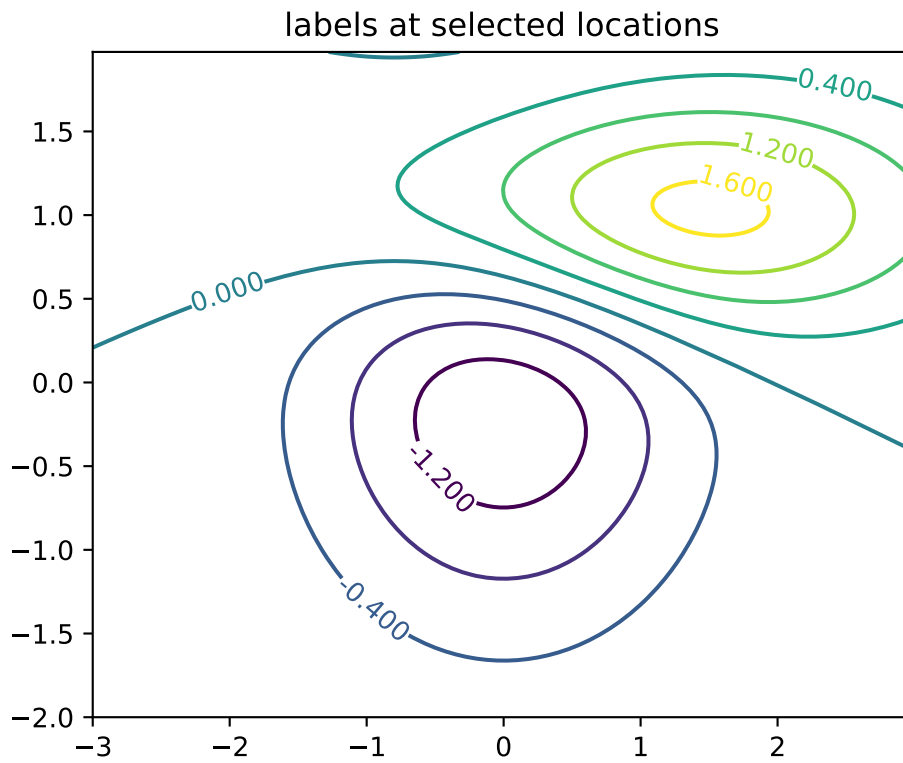

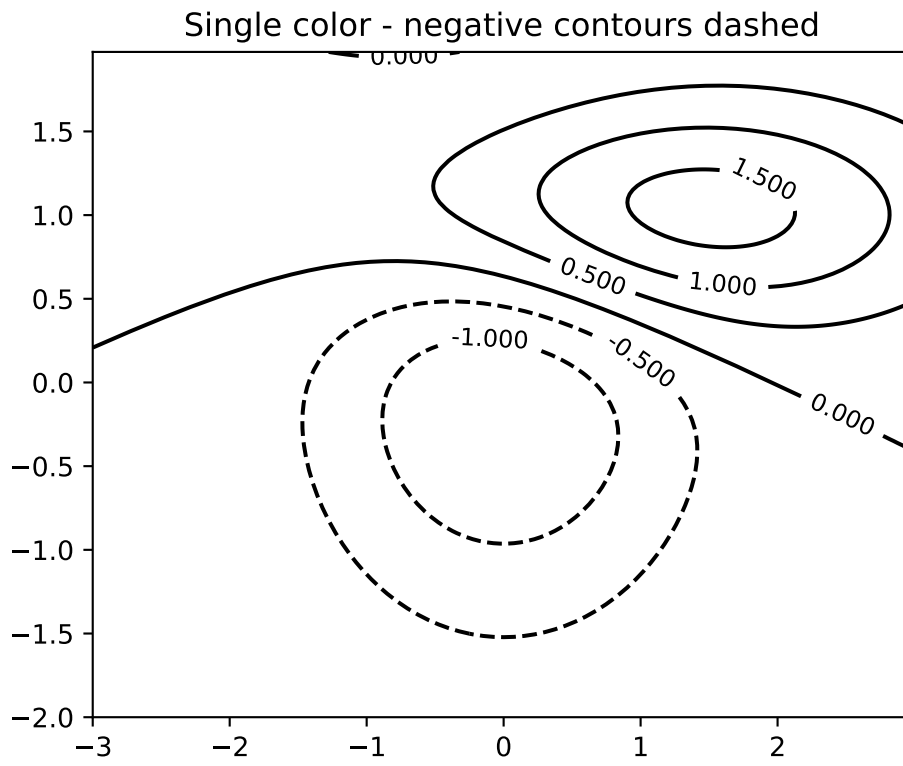

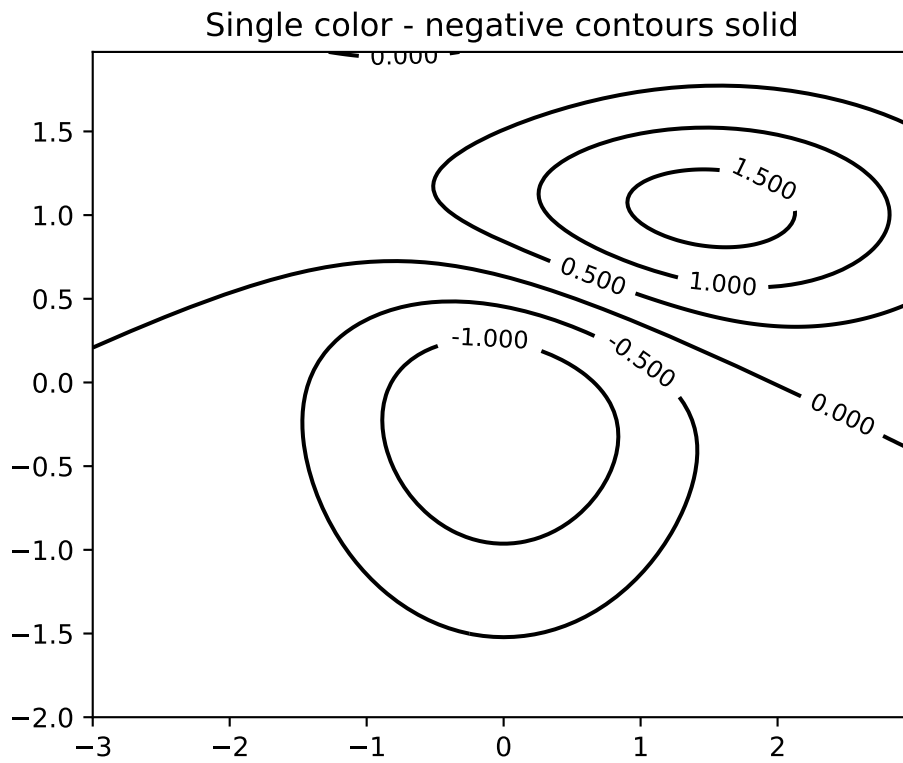

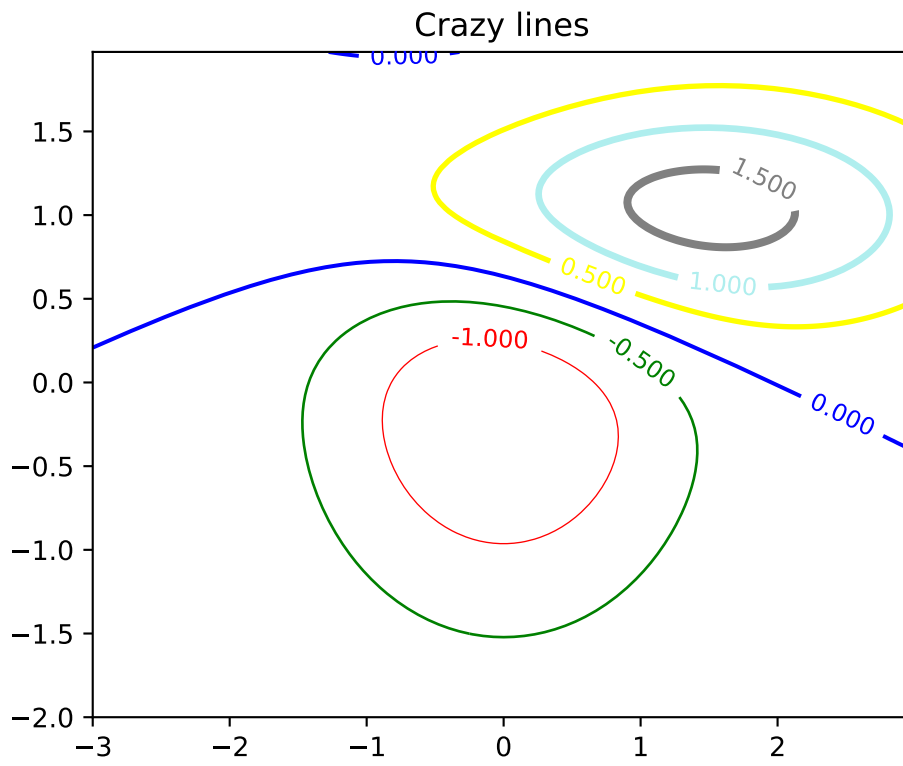

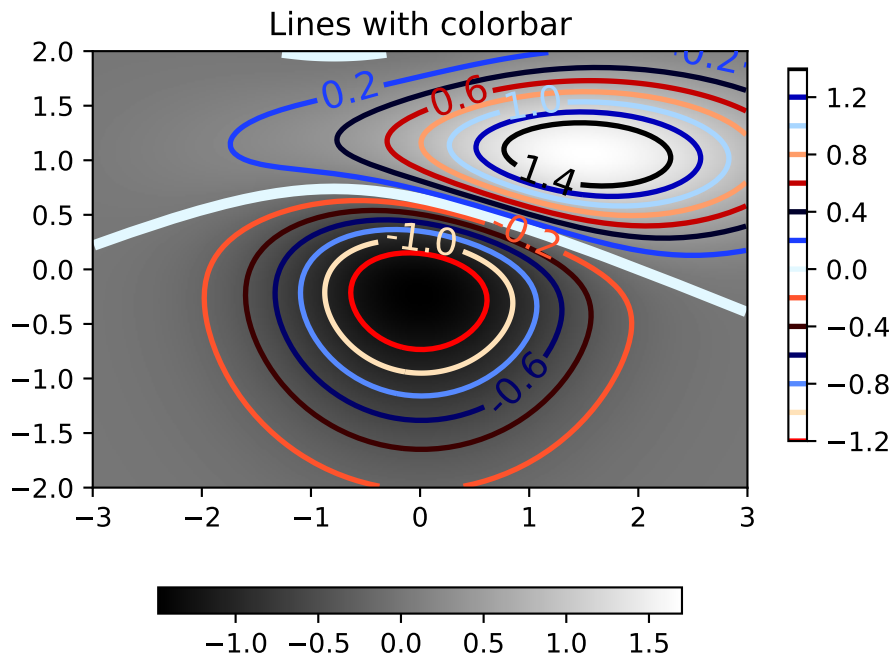

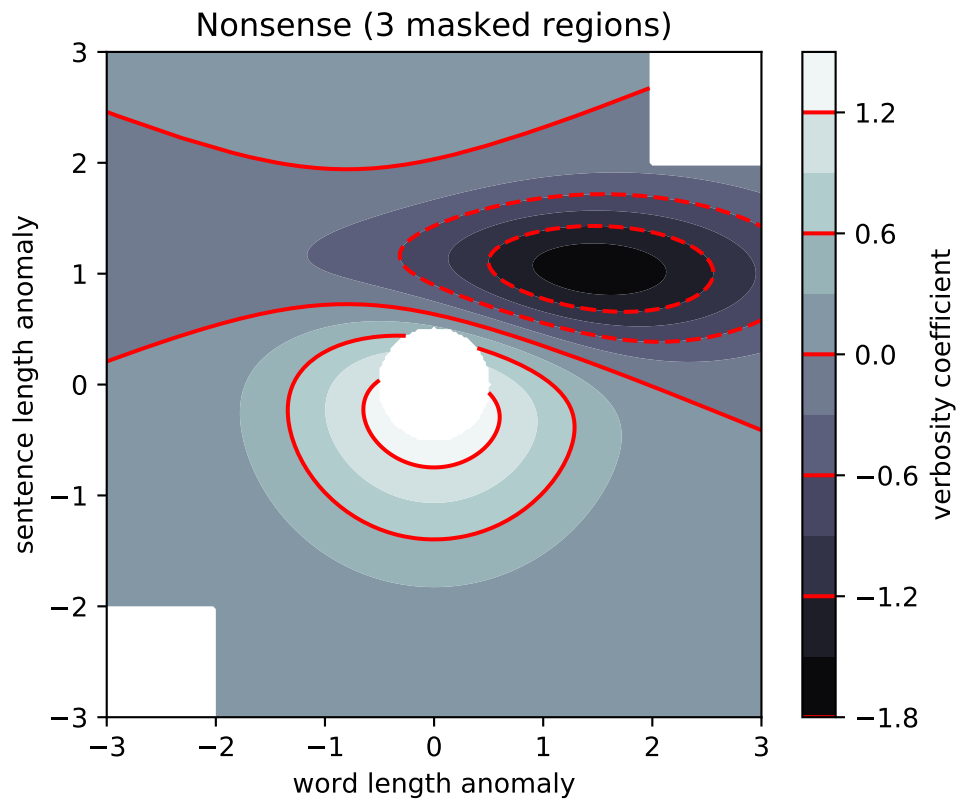

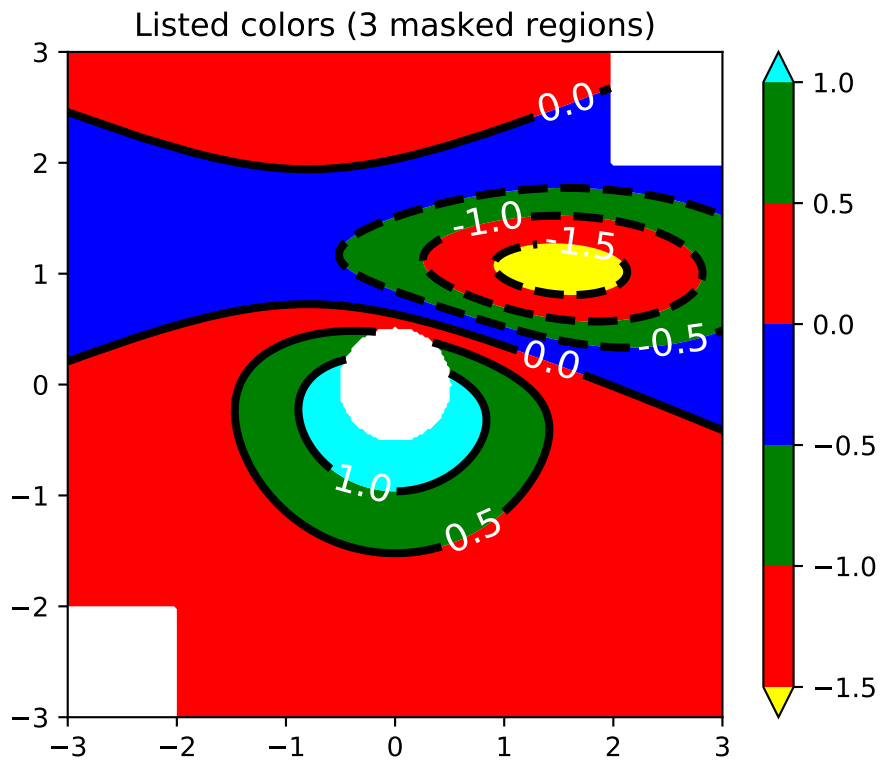

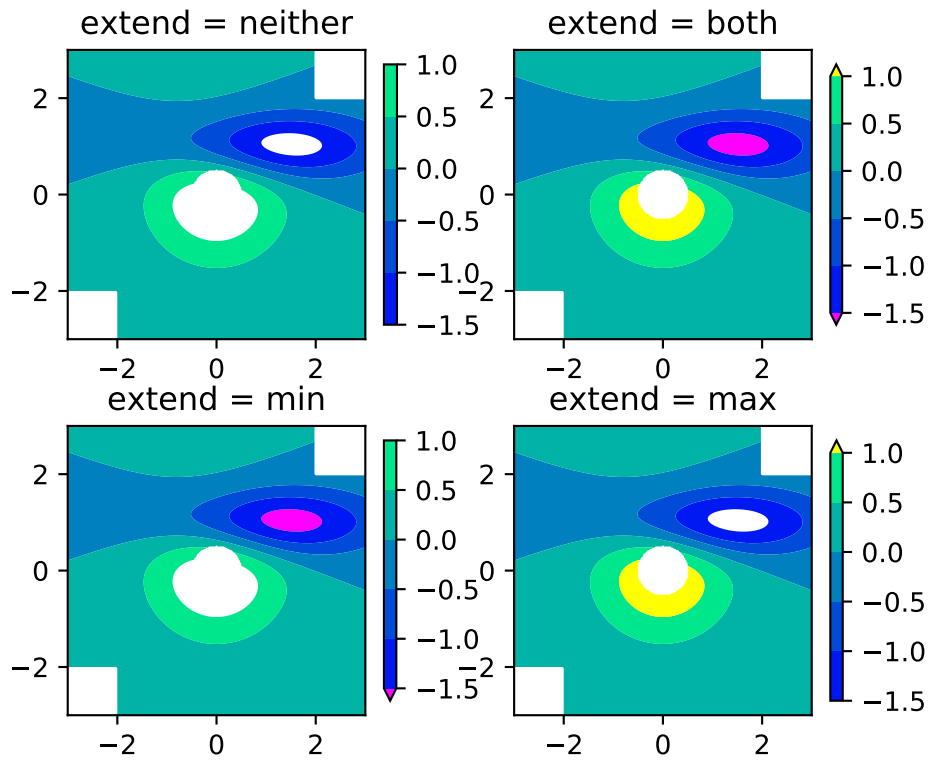

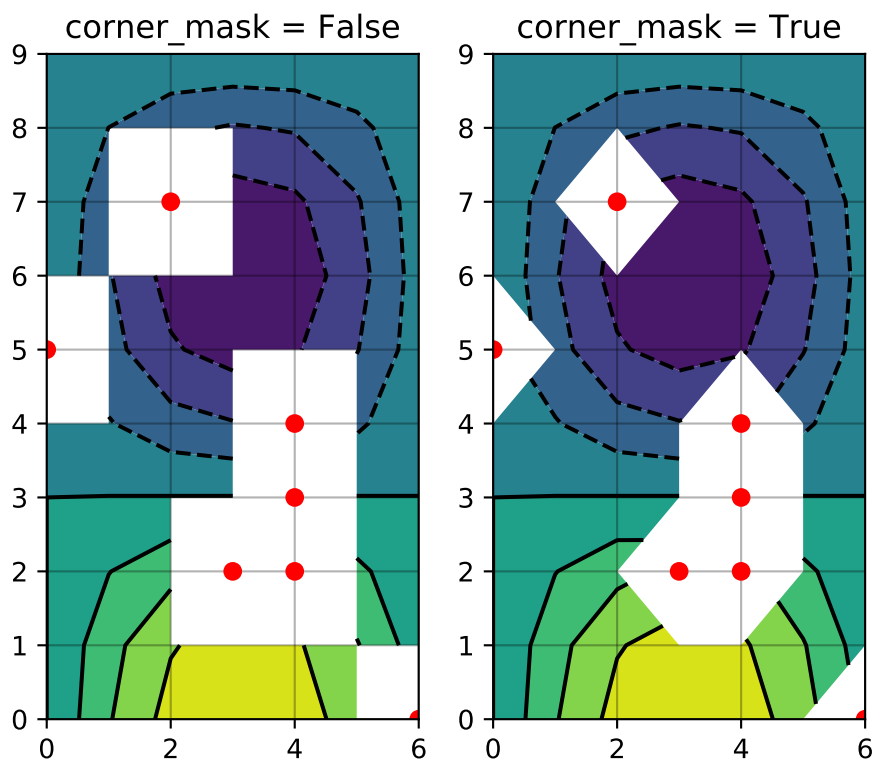

`matplotlib.pyplot.cool()`

set the default colormap to cool and apply to current image if any. See `help(colormaps)` for more information

`matplotlib.pyplot.copper()`

set the default colormap to copper and apply to current image if any. See `help(colormaps)` for more information

`matplotlib.pyplot.csd(x, y, NFFT=None, Fs=None, Fc=None, detrend=None, window=None, noverlap=None, pad_to=None, sides=None, scale_by_freq=None, return_line=None, hold=None, data=None, **kwargs)`

Plot the cross-spectral density.

Call signature:

```
csd(x, y, NFFT=256, Fs=2, Fc=0, detrend=mlab.detrend_none,
    window=mlab.window_hanning, noverlap=0, pad_to=None,
    sides='default', scale_by_freq=None, return_line=None, **kwargs)
```

The cross spectral density P_{xy} by Welch's average periodogram method. The vectors x and y are divided into $NFFT$ length segments. Each segment is detrended by function `detrend` and windowed by function `window`. `nooverlap` gives the length of the overlap between segments. The product of the direct FFTs of x and y are averaged over each segment to compute P_{xy} , with a scaling to correct for power loss due to windowing.

If `len(x) < NFFT` or `len(y) < NFFT`, they will be zero padded to $NFFT$.

Parameters x, y : 1-D arrays or sequences

Arrays or sequences containing the data

Fs : scalar

The sampling frequency (samples per time unit). It is used to calculate the Fourier frequencies, `freqs`, in cycles per time unit. The default value is 2.

window : callable or ndarray

A function or a vector of length $NFFT$. To create window vectors see `window_hanning()`, `window_none()`, `numpy.blackman()`, `numpy.hamming()`, `numpy.bartlett()`, `scipy.signal()`, `scipy.signal.get_window()`, etc. The default is `window_hanning()`. If a function is passed as the argument, it must take a data segment as an argument and return the windowed version of the segment.

sides : ['default' | 'onesided' | 'twosided']

Specifies which sides of the spectrum to return. Default gives the default behavior, which returns one-sided for real data and both for complex data. 'onesided' forces the return of a one-sided spectrum, while 'twosided' forces two-sided.

pad_to : integer

The number of points to which the data segment is padded when performing the FFT. This can be different from $NFFT$, which specifies the number of data points used. While not increasing the actual resolution of the spectrum (the minimum distance between resolvable peaks), this can give more points in the plot, allowing for more detail. This corresponds to the n parameter in the call to `fft()`. The default is `None`, which sets `pad_to` equal to $NFFT$

NFFT : integer

The number of data points used in each block for the FFT. A power 2 is most efficient. The default value is 256. This should *NOT* be used to get zero padding, or the scaling of the result will be incorrect. Use `pad_to` for this instead.

detrend : { 'default', 'constant', 'mean', 'linear', 'none' } or callable

The function applied to each segment before `fft`-ing, designed to remove the mean or linear trend. Unlike in MATLAB, where the `detrend` parameter is a vector, in matplotlib it is a function. The `pylab` module defines `detrend_none()`, `detrend_mean()`, and `detrend_linear()`, but you can use a custom function as well. You can also use a string to choose one of the functions. 'default', 'constant', and 'mean' call `detrend_mean()`. 'linear' calls `detrend_linear()`. 'none' calls `detrend_none()`.

scale_by_freq : boolean, optional

Specifies whether the resulting density values should be scaled by the scaling frequency, which gives density in units of Hz^{-1} . This allows for integra-

tion over the returned frequency values. The default is True for MATLAB compatibility.

noverlap : integer

The number of points of overlap between segments. The default value is 0 (no overlap).

Fc : integer

The center frequency of x (defaults to 0), which offsets the x extents of the plot to reflect the frequency range used when a signal is acquired and then filtered and downsampled to baseband.

return_line : bool

Whether to include the line object plotted in the returned values. Default is False.

****kwargs** :

Keyword arguments control the *Line2D* properties:

Property	Description
<i>agg_filter</i>	unknown
<i>alpha</i>	float (0.0 transparent through 1.0 opaque)
<i>animated</i>	[True False]
<i>antialiased</i> or <i>aa</i>	[True False]
<i>axes</i>	an <i>Axes</i> instance
<i>clip_box</i>	a <i>matplotlib.transforms.Bbox</i> instance
<i>clip_on</i>	[True False]
<i>clip_path</i>	[(<i>Path</i> , <i>Transform</i>) <i>Patch</i> None]
<i>color</i> or <i>c</i>	any matplotlib color
<i>contains</i>	a callable function
<i>dash_capstyle</i>	['butt' 'round' 'projecting']
<i>dash_joinstyle</i>	['miter' 'round' 'bevel']
<i>dashes</i>	sequence of on/off ink in points
<i>drawstyle</i>	['default' 'steps' 'steps-pre' 'steps-mid' 'steps-post']
<i>figure</i>	a <i>matplotlib.figure.Figure</i> instance
<i>fillstyle</i>	['full' 'left' 'right' 'bottom' 'top' 'none']
<i>gid</i>	an id string
<i>label</i>	string or anything printable with '%s' conversion.
<i>linestyle</i> or <i>ls</i>	['solid' 'dashed', 'dashdot', 'dotted' (offset, on-off-dash-seq) '-.' '-.-' '-.-.-' '-.-.-.-']
<i>linewidth</i> or <i>lw</i>	float value in points
<i>marker</i>	<i>A valid marker style</i>
<i>markeredgecolor</i> or <i>mec</i>	any matplotlib color
<i>markeredgewidth</i> or <i>mew</i>	float value in points
<i>markerfacecolor</i> or <i>mfc</i>	any matplotlib color
<i>markerfacecoloralt</i> or <i>mfcalt</i>	any matplotlib color
<i>markersize</i> or <i>ms</i>	float

Table 45.11 – continued from previous page

Property	Description
<i>markevery</i>	[None int length-2 tuple of int slice list/array of int float length-2 tuple of float]
<i>path_effects</i>	unknown
<i>picker</i>	float distance in points or callable pick function <code>fn(artist, event)</code>
<i>pickradius</i>	float distance in points
<i>rasterized</i>	[True False None]
<i>sketch_params</i>	unknown
<i>snap</i>	unknown
<i>solid_capstyle</i>	['butt' 'round' 'projecting']
<i>solid_joinstyle</i>	['miter' 'round' 'bevel']
<i>transform</i>	a <code>matplotlib.transforms.Transform</code> instance
<i>url</i>	a url string
<i>visible</i>	[True False]
<i>xdata</i>	1D array
<i>ydata</i>	1D array
<i>zorder</i>	any number

Returns Pxy : 1-D array

The values for the cross spectrum $P_{\{xy\}}$ before scaling (complex valued)

freqs : 1-D array

The frequencies corresponding to the elements in P_{xy}

line : a `Line2D` instance

The line created by this function. Only returned if `return_line` is True.

See also:

`psd()` `psd()` is the equivalent to setting `y=x`.

In addition to the above described arguments, this function can take a **data** keyword argument. If such a **data** argument is given, the following arguments are replaced by `data[<arg>]`: * All arguments with the following names: 'x', 'y'.

Notes

For plotting, the power is plotted as $10 \log_{10}(P_{xy})$ for decibels, though $P_{\{xy\}}$ itself is returned.

References

Bendat & Piersol – Random Data: Analysis and Measurement Procedures, John Wiley & Sons (1986)

Examples

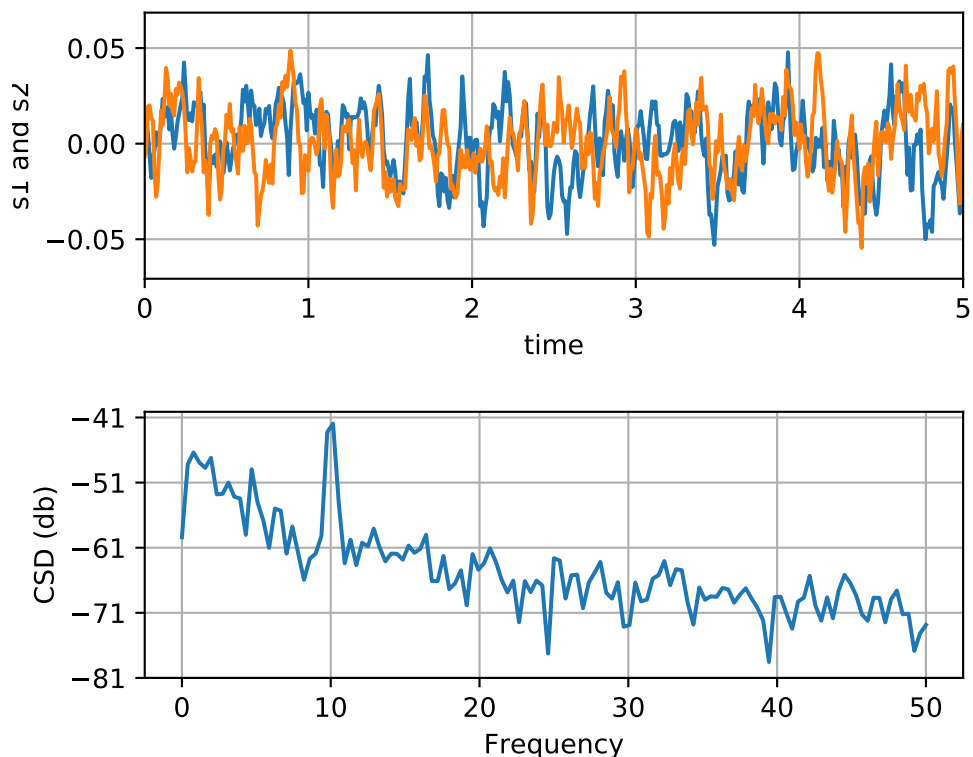

`matplotlib.pyplot.delaxes(*args)`

Remove an axes from the current figure. If *ax* doesn't exist, an error will be raised.

`delaxes()`: delete the current axes

`matplotlib.pyplot.disconnect(cid)`

Disconnect callback id *cid*

Example usage:

```
cid = canvas.mpl_connect('button_press_event', on_press)
#...later
canvas.mpl_disconnect(cid)
```

`matplotlib.pyplot.draw()`

Redraw the current figure.

This is used to update a figure that has been altered, but not automatically re-drawn. If interactive mode is on (`ion()`), this should be only rarely needed, but there may be ways to modify the state of a figure without marking it as stale. Please report these cases as bugs.

A more object-oriented alternative, given any *Figure* instance, *fig*, that was created using a *pyplot* function, is:

```
fig.canvas.draw_idle()
```

```
matplotlib.pyplot.errorbar(x, y, yerr=None, xerr=None, fmt='', ecolor=None,
                           linewidth=None, capsize=None, barsabove=False,
                           lolims=False, uplims=False, xlolims=False, xuplims=False, er-
                           rorevery=1, capthick=None, hold=None, data=None, **kwargs)
```

Plot an errorbar graph.

Plot x versus y with error deltas in yerr and xerr. Vertical errorbars are plotted if yerr is not None. Horizontal errorbars are plotted if xerr is not None.

x, y, xerr, and yerr can all be scalars, which plots a single error bar at x, y.

Parameters x : scalar or array-like

y : scalar or array-like

xerr/yerr : scalar or array-like, shape(N,) or shape(2,N), optional

If a scalar number, len(N) array-like object, or a N-element array-like object, errorbars are drawn at +/-value relative to the data. Default is None.

If a sequence of shape 2xN, errorbars are drawn at -row1 and +row2 relative to the data.

fmt : plot format string, optional, default: None

The plot format symbol. If fmt is 'none' (case-insensitive), only the errorbars are plotted. This is used for adding errorbars to a bar plot, for example. Default is '', an empty plot format string; properties are then identical to the defaults for `plot()`.

ecolor : mpl color, optional, default: None

A matplotlib color arg which gives the color the errorbar lines; if None, use the color of the line connecting the markers.

linewidth : scalar, optional, default: None

The linewidth of the errorbar lines. If None, use the linewidth.

capsize : scalar, optional, default: None

The length of the error bar caps in points; if None, it will take the value from `errorbar.capsize rcParam`.

capthick : scalar, optional, default: None

An alias kwarg to `markeredgewidth` (a.k.a. - mew). This setting is a more sensible name for the property that controls the thickness of the error bar cap in points. For backwards compatibility, if mew or `markeredgewidth` are given, then they will over-ride `capthick`. This may change in future releases.

barsabove : bool, optional, default: False

if True, will plot the errorbars above the plot symbols. Default is below.

lolims / uplims / xlolims / xuplims : bool, optional, default:None

These arguments can be used to indicate that a value gives only upper/lower limits. In that case a caret symbol is used to indicate this. lims-arguments may be of the same type as *xerr* and *yerr*. To use limits with inverted axes, `set_xlim()` or `set_ylim()` must be called before `errorbar()`.

errorevery : positive integer, optional, default:1

subsamples the errorbars. e.g., if `errorevery=5`, errorbars for every 5-th data-point will be plotted. The data plot itself still shows all data points.

Returns plotline : *Line2D* instance

x, y plot markers and/or line

caplines : list of *Line2D* instances

error bar cap

barlinecols : list of *LineCollection*

horizontal and vertical error ranges.

Other Parameters kwargs : All other keyword arguments are passed on to the plot

command for the markers. For example, this code makes big red squares with thick green edges:

```
x,y,yerr = rand(3,10)
errorbar(x, y, yerr, marker='s', mfc='red',
         mec='green', ms=20, mew=4)
```

where `mfc`, `mec`, `ms` and `mew` are aliases for the longer property names, `markerfacecolor`, `markeredgecolor`, `markersize` and `markerredgewidth`.

valid kwargs for the marker properties are

Property	Description
<i>agg_filter</i>	unknown
<i>alpha</i>	float (0.0 transparent through 1.0 opaque)
<i>animated</i>	[True False]
<i>antialiased</i> or <i>aa</i>	[True False]
<i>axes</i>	an <i>Axes</i> instance
<i>clip_box</i>	a <code>matplotlib.transforms.Bbox</code> instance
<i>clip_on</i>	[True False]
<i>clip_path</i>	[(<i>Path</i> , <i>Transform</i>) <i>Patch</i> None]
<i>color</i> or <i>c</i>	any matplotlib color
<i>contains</i>	a callable function
<i>dash_capstyle</i>	['butt' 'round' 'projecting']
<i>dash_joinstyle</i>	['miter' 'round' 'bevel']
<i>dashes</i>	sequence of on/off ink in points
<i>drawstyle</i>	['default' 'steps' 'steps-pre' 'steps-mid' 'steps-post']

Table 45.12 – continued from previous page

Property	Description
<i>figure</i>	a <i>matplotlib.figure.Figure</i> instance
<i>fillstyle</i>	['full' 'left' 'right' 'bottom' 'top' 'none']
<i>gid</i>	an id string
<i>label</i>	string or anything printable with '%s' conversion.
<i>linestyle</i> or <i>ls</i>	['solid' 'dashed', 'dashdot', 'dotted' (offset, on-off-dash-seq) '-' '--' '-.' ' ']
<i>linewidth</i> or <i>lw</i>	float value in points
<i>marker</i>	<i>A valid marker style</i>
<i>markeredgecolor</i> or <i>mec</i>	any matplotlib color
<i>markeredgewidth</i> or <i>mew</i>	float value in points
<i>markerfacecolor</i> or <i>mfc</i>	any matplotlib color
<i>markerfacecoloralt</i> or <i>mfcalt</i>	any matplotlib color
<i>markersize</i> or <i>ms</i>	float
<i>markevery</i>	[None int length-2 tuple of int slice list/array of int float length-2 tuple of float]
<i>path_effects</i>	unknown
<i>picker</i>	float distance in points or callable pick function <code>fn(artist, event)</code>
<i>pickradius</i>	float distance in points
<i>rasterized</i>	[True False None]
<i>sketch_params</i>	unknown
<i>snap</i>	unknown
<i>solid_capstyle</i>	['butt' 'round' 'projecting']
<i>solid_joinstyle</i>	['miter' 'round' 'bevel']
<i>transform</i>	a <i>matplotlib.transforms.Transform</i> instance
<i>url</i>	a url string
<i>visible</i>	[True False]
<i>xdata</i>	1D array
<i>ydata</i>	1D array
<i>zorder</i>	any number

Examples

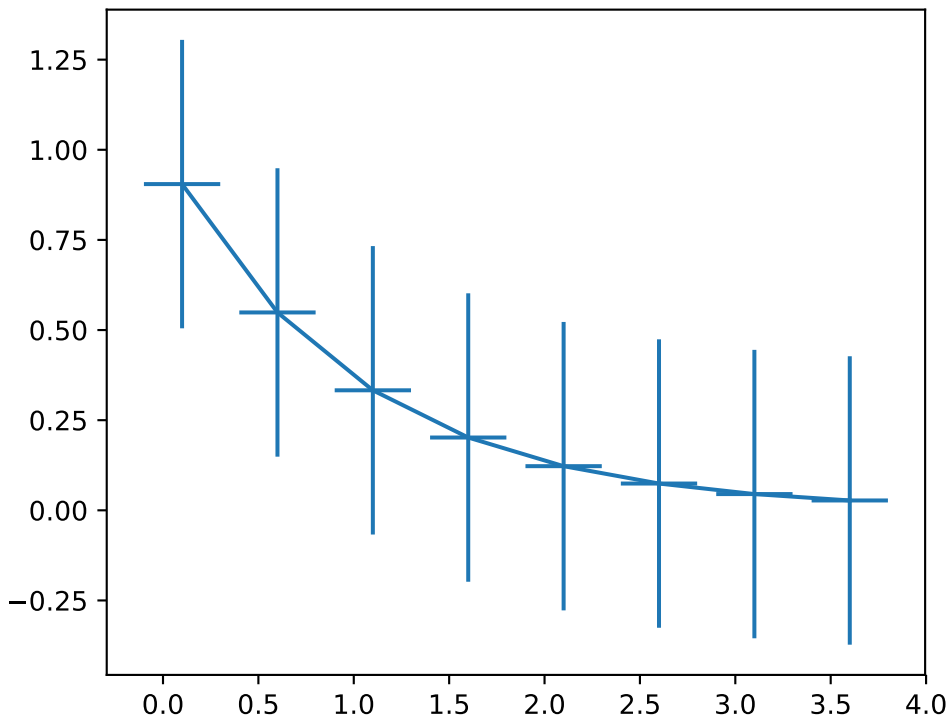

Note: In addition to the above described arguments, this function can take a **data** keyword argument. If such a **data** argument is given, the following arguments are replaced by **data[<arg>]**:

- All arguments with the following names: 'x', 'xerr', 'y', 'yerr'.
-

```
matplotlib.pyplot.eventplot(positions, orientation='horizontal', lineoffsets=1,
                             line-lengths=1, linewidths=None, colors=None, linestyle='solid',
                             hold=None, data=None, **kwargs)
```

Plot identical parallel lines at specific positions.

Plot parallel lines at the given positions. positions should be a 1D or 2D array-like object, with each row corresponding to a row or column of lines.

This type of plot is commonly used in neuroscience for representing neural events, where it is commonly called a spike raster, dot raster, or raster plot.

However, it is useful in any situation where you wish to show the timing or position of multiple sets of discrete events, such as the arrival times of people to a business on each day of the month or the date of hurricanes each year of the last century.

orientation [['horizontal' | 'vertical']] 'horizontal' : the lines will be vertical and arranged in rows
 'vertical' : lines will be horizontal and arranged in columns

lineoffsets : A float or array-like containing floats.

linelengths : A float or array-like containing floats.

linewidths : A float or array-like containing floats.

colors must be a sequence of RGBA tuples (e.g., arbitrary color strings, etc, not allowed) or a list of such sequences

linestyles : ['solid' | 'dashed' | 'dashdot' | 'dotted'] or an array of these values

For linelengths, linewidths, colors, and linestyles, if only a single value is given, that value is applied to all lines. If an array-like is given, it must have the same length as positions, and each value will be applied to the corresponding row or column in positions.

Returns a list of *matplotlib.collections.EventCollection* objects that were added.

kwargs are *LineCollection* properties:

Property	Description
<i>agg_filter</i>	unknown
<i>alpha</i>	float or None
<i>animated</i>	[True False]
<i>antialiased</i> or <i>antialiaseds</i>	Boolean or sequence of booleans
<i>array</i>	unknown
<i>axes</i>	an <i>Axes</i> instance
<i>clim</i>	a length 2 sequence of floats
<i>clip_box</i>	a <i>matplotlib.transforms.Bbox</i> instance
<i>clip_on</i>	[True False]
<i>clip_path</i>	[(<i>Path</i> , <i>Transform</i>) <i>Patch</i> None]
<i>cmap</i>	a colormap or registered colormap name
<i>color</i>	matplotlib color arg or sequence of rgba tuples
<i>contains</i>	a callable function
<i>edgecolor</i> or <i>edgecolors</i>	matplotlib color spec or sequence of specs
<i>facecolor</i> or <i>facecolors</i>	matplotlib color spec or sequence of specs
<i>figure</i>	a <i>matplotlib.figure.Figure</i> instance
<i>gid</i>	an id string
<i>hatch</i>	['/' '\' ' ' '-' '+' 'x' 'o' 'O' '.' '*']
<i>label</i>	string or anything printable with '%s' conversion.
<i>linestyle</i> or <i>dashes</i> or <i>linestyles</i>	['solid' 'dashed', 'dashdot', 'dotted' (offset, on-off-dash-seq) '-' '--' '-.']
<i>linewidth</i> or <i>linewidths</i> or <i>lw</i>	float or sequence of floats
<i>norm</i>	unknown
<i>offset_position</i>	unknown
<i>offsets</i>	float or sequence of floats
<i>path_effects</i>	unknown
<i>paths</i>	unknown
<i>picker</i>	[None float boolean callable]
<i>pickradius</i>	unknown
<i>rasterized</i>	[True False None]

Table 45.13 – continued from previous page

Property	Description
<i>segments</i>	unknown
<i>sketch_params</i>	unknown
<i>snap</i>	unknown
<i>transform</i>	<i>Transform</i> instance
<i>url</i>	a url string
<i>urls</i>	unknown
<i>verts</i>	unknown
<i>visible</i>	[True False]
<i>zorder</i>	any number

Example:

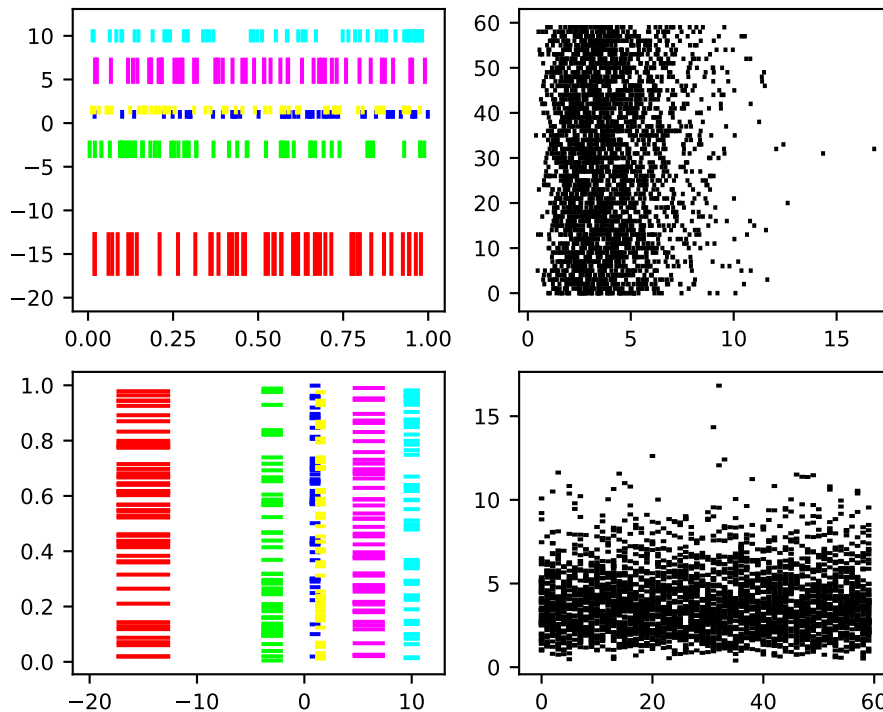

Note: In addition to the above described arguments, this function can take a **data** keyword argument. If such a **data** argument is given, the following arguments are replaced by **data[<arg>]**:

- All arguments with the following names: ‘colors’, ‘linelengths’, ‘lineoffsets’, ‘linestyles’, ‘linewidths’, ‘positions’.

`matplotlib.pyplot.figimage(*args, **kwargs)`

Adds a non-resampled image to the figure.

call signatures:

```
figimage(X, **kwargs)
```

adds a non-resampled array *X* to the figure.

```
figimage(X, xo, yo)
```

with pixel offsets *xo*, *yo*,

X must be a float array:

- If *X* is MxN, assume luminance (grayscale)
- If *X* is MxNx3, assume RGB
- If *X* is MxNx4, assume RGBA

Optional keyword arguments:

Key-word	Description
re-size	a boolean, True or False. If “True”, then re-size the Figure to match the given image size.
xo or yo	An integer, the <i>x</i> and <i>y</i> image offset in pixels
cmap	a <code>matplotlib.colors.Colormap</code> instance, e.g., <code>cm.jet</code> . If <i>None</i> , default to the rc <code>image.cmap</code> value
norm	a <code>matplotlib.colors.Normalize</code> instance. The default is <code>normalization()</code> . This scales luminance -> 0-1
vmin vmax	used to scale a luminance image to 0-1. If either is <i>None</i> , the min and max of the luminance values will be used. Note if you pass a <code>norm</code> instance, the settings for <i>vmin</i> and <i>vmax</i> will be ignored.
alpha	the alpha blending value, default is <i>None</i>
origin	[‘upper’ ‘lower’] Indicates where the [0,0] index of the array is in the upper left or lower left corner of the axes. Defaults to the rc <code>image.origin</code> value

`figimage` complements the axes image (`imshow()`) which will be resampled to fit the current axes. If you want a resampled image to fill the entire figure, you can define an `Axes` with extent `[0,0,1,1]`.

An `matplotlib.image.FigureImage` instance is returned.

Additional kwargs are Artist kwargs passed on to *FigureImage*

`matplotlib.pyplot.figlegend(handles, labels, loc, **kwargs)`

Place a legend in the figure.

labels a sequence of strings

handles a sequence of *Line2D* or *Patch* instances

loc can be a string or an integer specifying the legend location

A `matplotlib.legend.Legend` instance is returned.

Example:

```
figlegend( (line1, line2, line3),
           ('label1', 'label2', 'label3'),
           'upper right' )
```

See also:

`legend()`

`matplotlib.pyplot.fignum_exists(num)`

`matplotlib.pyplot.figtext(*args, **kwargs)`

Add text to figure.

Call signature:

```
text(x, y, s, fontdict=None, **kwargs)
```

Add text to figure at location x, y (relative 0-1 coords). See `text()` for the meaning of the other arguments.

kwargs control the `Text` properties:

Property	Description
<code>agg_filter</code>	unknown
<code>alpha</code>	float (0.0 transparent through 1.0 opaque)
<code>animated</code>	[True False]
<code>axes</code>	an <code>Axes</code> instance
<code>backgroundcolor</code>	any matplotlib color
<code>bbox</code>	FancyBboxPatch prop dict
<code>clip_box</code>	a <code>matplotlib.transforms.Bbox</code> instance
<code>clip_on</code>	[True False]
<code>clip_path</code>	[(<code>Path, Transform</code>) <code>Patch</code> None]
<code>color</code>	any matplotlib color
<code>contains</code>	a callable function
<code>family</code> or <code>fontfamily</code> or <code>fontname</code> or <code>name</code>	[FONTNAME 'serif' 'sans-serif' 'cursive' 'fantasy' 'monospace']
<code>figure</code>	a <code>matplotlib.figure.Figure</code> instance
<code>fontproperties</code> or <code>font_properties</code>	a <code>matplotlib.font_manager.FontProperties</code> instance
<code>gid</code>	an id string
<code>horizontalalignment</code> or <code>ha</code>	['center' 'right' 'left']
<code>label</code>	string or anything printable with '%s' conversion.
<code>linespacing</code>	float (multiple of font size)
<code>multialignment</code>	['left' 'right' 'center']
<code>path_effects</code>	unknown
<code>picker</code>	[None float boolean callable]
<code>position</code>	(x,y)
<code>rasterized</code>	[True False None]
<code>rotation</code>	[angle in degrees 'vertical' 'horizontal']
<code>rotation_mode</code>	unknown
<code>size</code> or <code>fontsize</code>	[size in points 'xx-small' 'x-small' 'small' 'medium' 'large' 'x-large']
<code>sketch_params</code>	unknown
<code>snap</code>	unknown
<code>stretch</code> or <code>fontstretch</code>	[a numeric value in range 0-1000 'ultra-condensed' 'extra-condensed' 'c
<code>style</code> or <code>fontstyle</code>	['normal' 'italic' 'oblique']
<code>text</code>	string or anything printable with '%s' conversion.
<code>transform</code>	<code>Transform</code> instance
<code>url</code>	a url string
<code>usetex</code>	unknown
<code>variant</code> or <code>fontvariant</code>	['normal' 'small-caps']
<code>verticalalignment</code> or <code>ma</code> or <code>va</code>	['center' 'top' 'bottom' 'baseline']

Property	Description
<i>visible</i>	[True False]
<i>weight</i> or fontweight	[a numeric value in range 0-1000 ‘ultralight’ ‘light’ ‘normal’ ‘regular’ ‘bold’ ‘extra-bold’]
<i>wrap</i>	unknown
<i>x</i>	float
<i>y</i>	float
<i>zorder</i>	any number

`matplotlib.pyplot.figure(num=None, figsize=None, dpi=None, facecolor=None, edgecolor=None, frameon=True, FigureClass=<class ‘matplotlib.figure.Figure’>, **kwargs)`

Creates a new figure.

Parameters num : integer or string, optional, default: none

If not provided, a new figure will be created, and the figure number will be incremented. The figure objects holds this number in a `number` attribute. If num is provided, and a figure with this id already exists, make it active, and returns a reference to it. If this figure does not exists, create it and returns it. If num is a string, the window title will be set to this figure’s `num`.

figsize : tuple of integers, optional, default: None

width, height in inches. If not provided, defaults to `rc figure.figsize`.

dpi : integer, optional, default: None

resolution of the figure. If not provided, defaults to `rc figure.dpi`.

facecolor :

the background color. If not provided, defaults to `rc figure.facecolor`

edgecolor :

the border color. If not provided, defaults to `rc figure.edgecolor`

Returns figure : Figure

The Figure instance returned will also be passed to `new_figure_manager` in the backends, which allows to hook custom Figure classes into the pylab interface. Additional kwargs will be passed to the figure init function.

Notes

If you are creating many figures, make sure you explicitly call “close” on the figures you are not using, because this will enable pylab to properly clean up the memory.

`rcParams` defines the default values, which can be modified in the `matplotlibrc` file

`matplotlib.pyplot.fill(*args, **kwargs)`

Plot filled polygons.

Parameters args : a variable length argument

It allowing for multiple x, y pairs with an optional color format string; see [plot\(\)](#) for details on the argument parsing. For example, each of the following is legal:

```
ax.fill(x, y)
ax.fill(x, y, "b")
ax.fill(x, y, "b", x, y, "r")
```

An arbitrary number of $x, y, color$ groups can be specified:: `ax.fill(x1, y1, 'g', x2, y2, 'r')`

Returns a list of *Patch*

Other Parameters kwargs : *Polygon* properties

Notes

The same color strings that [plot\(\)](#) supports are supported by the fill format string.

If you would like to fill below a curve, e.g., shade a region between 0 and y along x , use [fill_between\(\)](#)

Examples

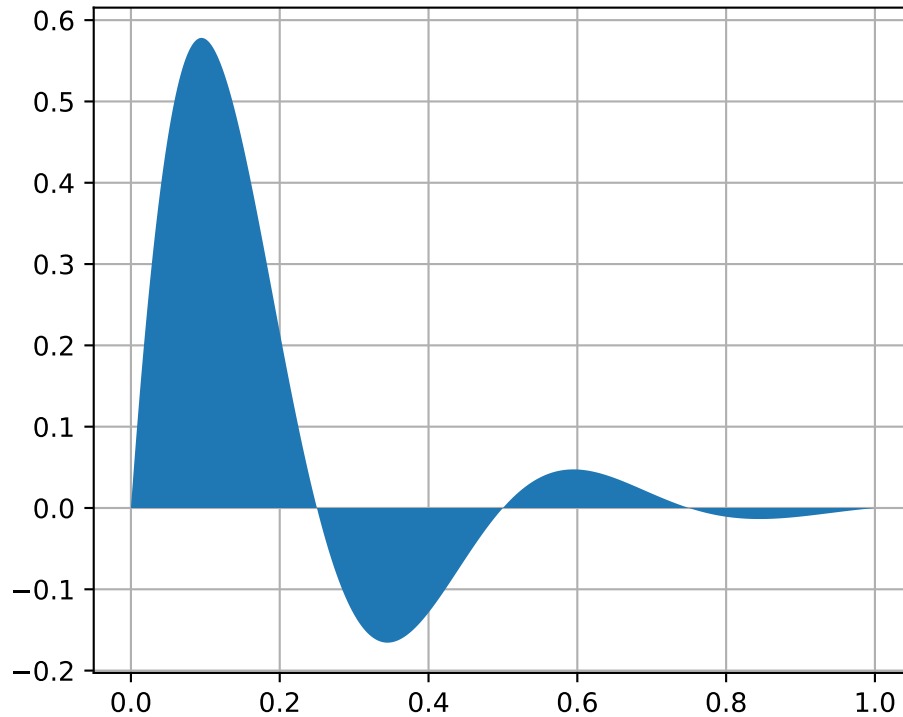

Note: In addition to the above described arguments, this function can take a **data** keyword argument. If such a **data** argument is given, the following arguments are replaced by **data[<arg>]**:

- All arguments with the following names: 'x', 'y'.
-

`matplotlib.pyplot.fill_between(x, y1, y2=0, where=None, interpolate=False, step=None, hold=None, data=None, **kwargs)`

Make filled polygons between two curves.

Create a *PolyCollection* filling the regions between *y1* and *y2* where `where==True`

Parameters *x* : array

An N-length array of the x data

y1 : array

An N-length array (or scalar) of the y data

y2 : array

An N-length array (or scalar) of the y data

where : array, optional

If `None`, default to fill between everywhere. If not `None`, it is an N-length numpy boolean array and the fill will only happen over the regions where `where==True`.

interpolate : bool, optional

If `True`, interpolate between the two lines to find the precise point of intersection. Otherwise, the start and end points of the filled region will only occur on explicit values in the `x` array.

step : { 'pre', 'post', 'mid' }, optional

If not `None`, fill with step logic.

See also:

In addition to the above described arguments, this function can take a **data** keyword argument. If such a **data** argument is given, the following arguments are replaced by **data[<arg>]**: * All arguments with the following names: 'where', 'x', 'y1', 'y2'.

Notes

Additional Keyword args passed on to the *PolyCollection*.

kwargs control the *Polygon* properties:

Property	Description
<i>agg_filter</i>	unknown
<i>alpha</i>	float or None
<i>animated</i>	[True False]
<i>antialiased</i> or <i>antialiaseds</i>	Boolean or sequence of booleans
<i>array</i>	unknown
<i>axes</i>	an <i>Axes</i> instance
<i>clim</i>	a length 2 sequence of floats
<i>clip_box</i>	a <i>matplotlib.transforms.Bbox</i> instance
<i>clip_on</i>	[True False]
<i>clip_path</i>	[(<i>Path</i> , <i>Transform</i>) <i>Patch</i> None]
<i>cmap</i>	a colormap or registered colormap name
<i>color</i>	matplotlib color arg or sequence of rgba tuples
<i>contains</i>	a callable function
<i>edgecolor</i> or <i>edgecolors</i>	matplotlib color spec or sequence of specs
<i>facecolor</i> or <i>facecolors</i>	matplotlib color spec or sequence of specs
<i>figure</i>	a <i>matplotlib.figure.Figure</i> instance
<i>gid</i>	an id string
<i>hatch</i>	['/' '\' ' ' '-' '+' 'x' 'o' 'O' '.' '*']
<i>label</i>	string or anything printable with '%s' conversion.
<i>linestyle</i> or <i>dashes</i> or <i>linestyles</i>	['solid' 'dashed', 'dashdot', 'dotted' (offset, on-off-dash-seq) '-' '--' '-.']
<i>linewidth</i> or <i>linewidths</i> or <i>lw</i>	float or sequence of floats

Table 45.15 – continued from previous page

Property	Description
<i>norm</i>	unknown
<i>offset_position</i>	unknown
<i>offsets</i>	float or sequence of floats
<i>path_effects</i>	unknown
<i>picker</i>	[None float boolean callable]
<i>pickradius</i>	unknown
<i>rasterized</i>	[True False None]
<i>sketch_params</i>	unknown
<i>snap</i>	unknown
<i>transform</i>	<i>Transform</i> instance
<i>url</i>	a url string
<i>urls</i>	unknown
<i>visible</i>	[True False]
<i>zorder</i>	any number

Examples

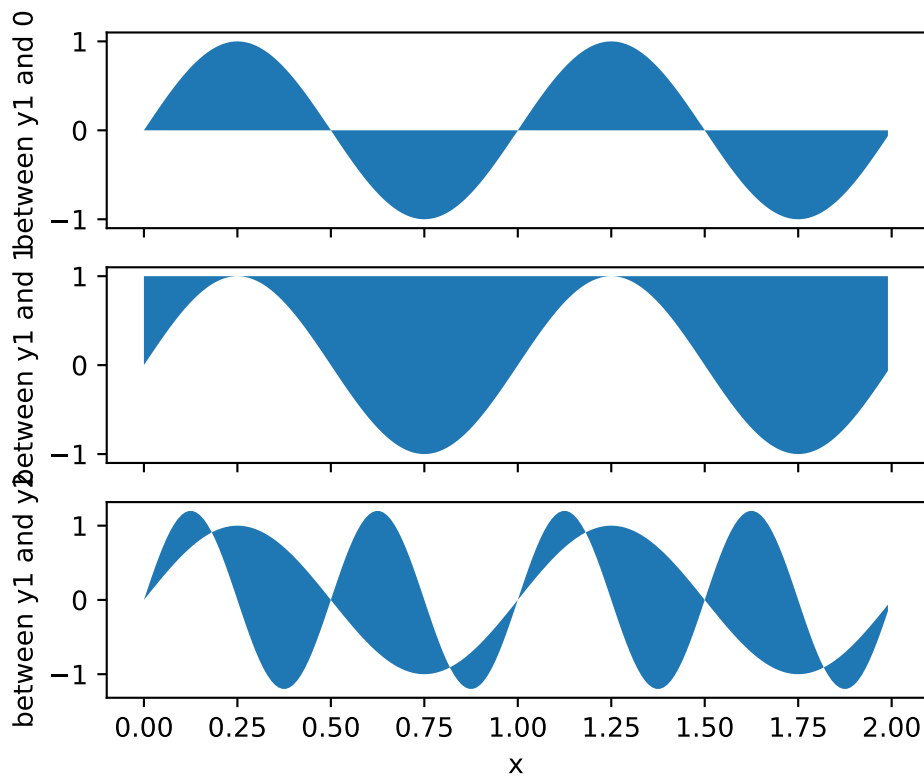

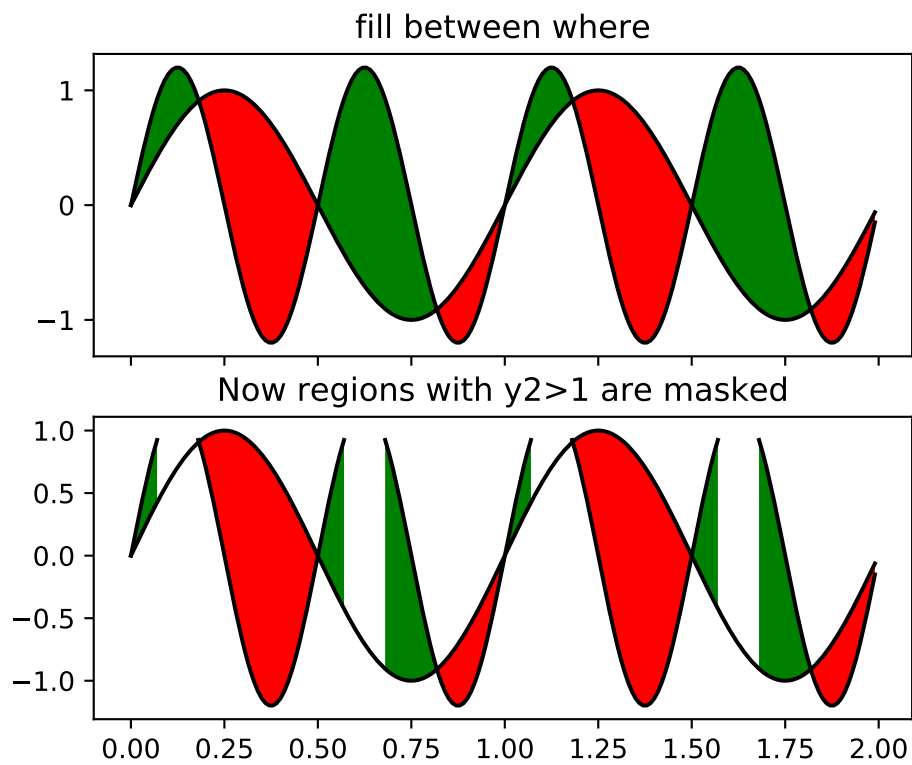

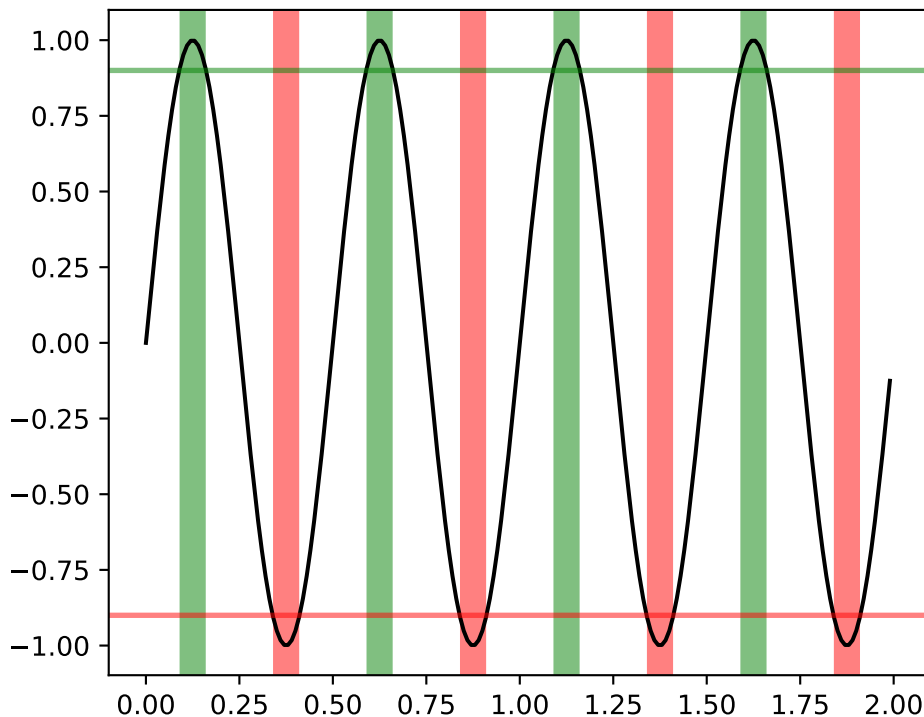

`matplotlib.pyplot.fill_betweenx`(*y*, *x1*, *x2*=0, *where*=None, *step*=None, *hold*=None, *data*=None, ***kwargs*)

Make filled polygons between two horizontal curves.

Create a *PolyCollection* filling the regions between *x1* and *x2* where *where*==True

Parameters *y* : array

An N-length array of the y data

x1 : array

An N-length array (or scalar) of the x data

x2 : array, optional

An N-length array (or scalar) of the x data

where : array, optional

If *None*, default to fill between everywhere. If not *None*, it is a N length numpy boolean array and the fill will only happen over the regions where *where*==True

step : {'pre', 'post', 'mid'}, optional

If not *None*, fill with step logic.

See also:

In addition to the above described arguments, this function can take a **data** keyword argument. If such a **data** argument is given, the following arguments are replaced by **data[<arg>]**: * All arguments with the following names: ‘where’, ‘x1’, ‘x2’, ‘y’.

Notes

keyword args passed on to the *PolyCollection*

kwargs control the *Polygon* properties:

Property	Description
<i>agg_filter</i>	unknown
<i>alpha</i>	float or None
<i>animated</i>	[True False]
<i>antialiased</i> or <i>antialiaseds</i>	Boolean or sequence of booleans
<i>array</i>	unknown
<i>axes</i>	an <i>Axes</i> instance
<i>clim</i>	a length 2 sequence of floats
<i>clip_box</i>	a <i>matplotlib.transforms.Bbox</i> instance
<i>clip_on</i>	[True False]
<i>clip_path</i>	[(<i>Path</i> , <i>Transform</i>) <i>Patch</i> None]
<i>cmap</i>	a colormap or registered colormap name
<i>color</i>	matplotlib color arg or sequence of rgba tuples
<i>contains</i>	a callable function
<i>edgecolor</i> or <i>edgecolors</i>	matplotlib color spec or sequence of specs
<i>facecolor</i> or <i>facecolors</i>	matplotlib color spec or sequence of specs
<i>figure</i>	a <i>matplotlib.figure.Figure</i> instance
<i>gid</i>	an id string
<i>hatch</i>	['/' '\' ' ' '-' '+' 'x' 'o' 'O' '.' '*']
<i>label</i>	string or anything printable with ‘%s’ conversion.
<i>linestyle</i> or <i>dashes</i> or <i>linestyles</i>	[‘solid’ ‘dashed’, ‘dashdot’, ‘dotted’ (offset, on-off-dash-seq) ‘-’ ‘--’ ‘-.’]
<i>linewidth</i> or <i>linewidths</i> or <i>lw</i>	float or sequence of floats
<i>norm</i>	unknown
<i>offset_position</i>	unknown
<i>offsets</i>	float or sequence of floats
<i>path_effects</i>	unknown
<i>picker</i>	[None float boolean callable]
<i>pickradius</i>	unknown
<i>rasterized</i>	[True False None]
<i>sketch_params</i>	unknown
<i>snap</i>	unknown
<i>transform</i>	<i>Transform</i> instance
<i>url</i>	a url string
<i>urls</i>	unknown
<i>visible</i>	[True False]

Table 45.16 – continued from previous page

Property	Description
<i>zorder</i>	any number

Examples

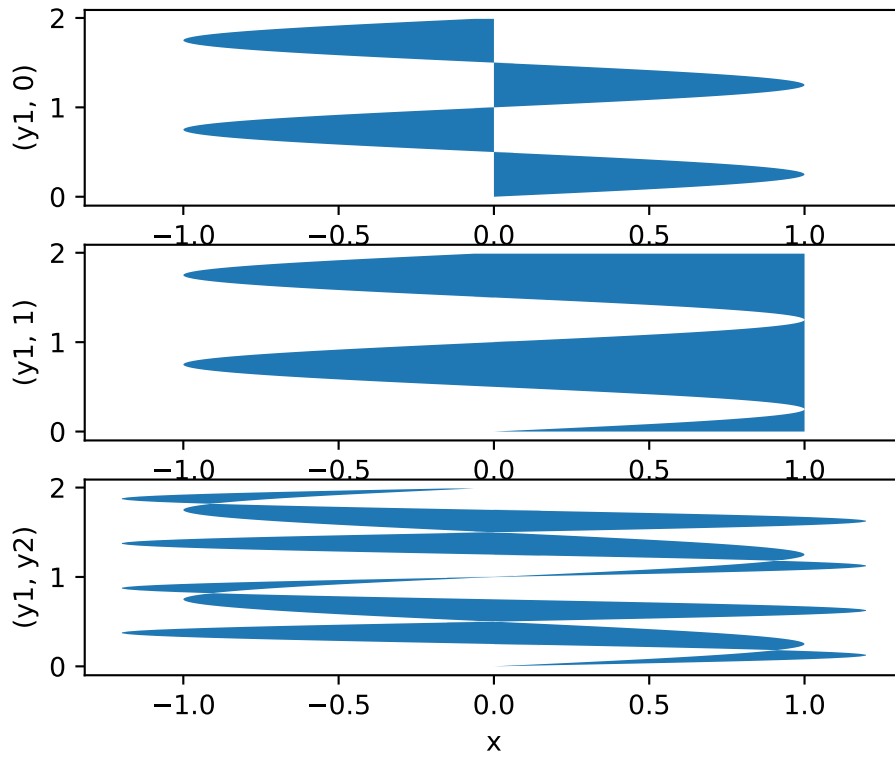

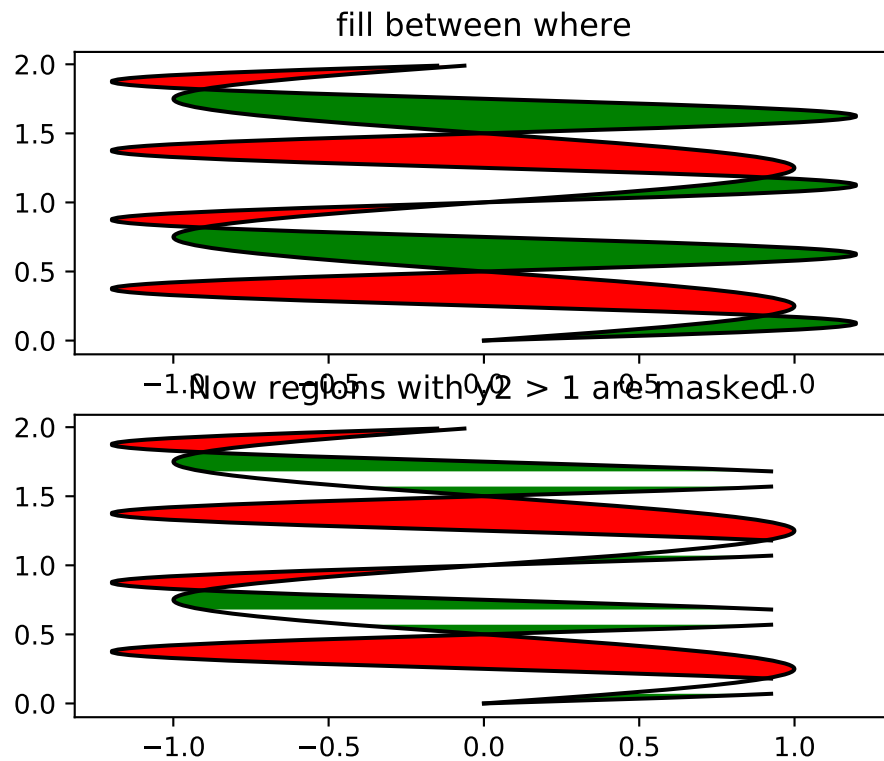

`matplotlib.pyplot.findobj` (*o=None, match=None, include_self=True*)

Find artist objects.

Recursively find all *Artist* instances contained in self.

match can be

- None: return all objects contained in artist.
- function with signature `boolean = match(artist)` used to filter matches
- class instance: e.g., `Line2D`. Only return artists of class type.

If *include_self* is True (default), include self in the list to be checked for a match.

`matplotlib.pyplot.flag`()

set the default colormap to flag and apply to current image if any. See `help(colormaps)` for more information

`matplotlib.pyplot.gca` (**kwargs)

Get the current *Axes* instance on the current figure matching the given keyword args, or create one.

See also:

[*matplotlib.figure.Figure.gca*](#) The figure's gca method.

Examples

To get the current polar axes on the current figure:

```
plt.gca(projection='polar')
```

If the current axes doesn't exist, or isn't a polar one, the appropriate axes will be created and then returned.

`matplotlib.pyplot.gcf()`

Get a reference to the current figure.

`matplotlib.pyplot.gci()`

Get the current colorable artist. Specifically, returns the current *ScalarMappable* instance (image or patch collection), or *None* if no images or patch collections have been defined. The commands *imshow()* and *figimage()* create *Image* instances, and the commands *pcolor()* and *scatter()* create *Collection* instances. The current image is an attribute of the current axes, or the nearest earlier axes in the current figure that contains an image.

`matplotlib.pyplot.get_current_fig_manager()`

`matplotlib.pyplot.get_figlabels()`

Return a list of existing figure labels.

`matplotlib.pyplot.get_fignums()`

Return a list of existing figure numbers.

`matplotlib.pyplot.get_plot_commands()`

Get a sorted list of all of the plotting commands.

`matplotlib.pyplot.ginput(*args, **kwargs)`

Blocking call to interact with the figure.

This will wait for *n* clicks from the user and return a list of the coordinates of each click.

If *timeout* is zero or negative, does not timeout.

If *n* is zero or negative, accumulate clicks until a middle click (or potentially both mouse buttons at once) terminates the input.

Right clicking cancels last input.

The buttons used for the various actions (adding points, removing points, terminating the inputs) can be overridden via the arguments *mouse_add*, *mouse_pop* and *mouse_stop*, that give the associated mouse button: 1 for left, 2 for middle, 3 for right.

The keyboard can also be used to select points in case your mouse does not have one or more of the buttons. The delete and backspace keys act like right clicking (i.e., remove last point), the enter key terminates input and any other key (not already used by the window manager) selects a point.

`matplotlib.pyplot.gray()`

set the default colormap to gray and apply to current image if any. See `help(colormaps)` for more information

`matplotlib.pyplot.grid(b=None, which='major', axis='both', **kwargs)`

Turn the axes grids on or off.

Set the axes grids on or off; *b* is a boolean. (For MATLAB compatibility, *b* may also be a string, 'on' or 'off'.)

If *b* is *None* and `len(kwargs)==0`, toggle the grid state. If *kwargs* are supplied, it is assumed that you want a grid and *b* is thus set to *True*.

which can be 'major' (default), 'minor', or 'both' to control whether major tick grids, minor tick grids, or both are affected.

axis can be 'both' (default), 'x', or 'y' to control which set of gridlines are drawn.

kwargs are used to set the grid line properties, e.g.,:

```
ax.grid(color='r', linestyle='-', linewidth=2)
```

Valid *Line2D* kwargs are

Property	Description
<i>agg_filter</i>	unknown
<i>alpha</i>	float (0.0 transparent through 1.0 opaque)
<i>animated</i>	[True False]
<i>antialiased</i> or <i>aa</i>	[True False]
<i>axes</i>	an <i>Axes</i> instance
<i>clip_box</i>	a <i>matplotlib.transforms.Bbox</i> instance
<i>clip_on</i>	[True False]
<i>clip_path</i>	[(<i>Path</i> , <i>Transform</i>) <i>Patch</i> None]
<i>color</i> or <i>c</i>	any matplotlib color
<i>contains</i>	a callable function
<i>dash_capstyle</i>	['butt' 'round' 'projecting']
<i>dash_joinstyle</i>	['miter' 'round' 'bevel']
<i>dashes</i>	sequence of on/off ink in points
<i>drawstyle</i>	['default' 'steps' 'steps-pre' 'steps-mid' 'steps-post']
<i>figure</i>	a <i>matplotlib.figure.Figure</i> instance
<i>fillstyle</i>	['full' 'left' 'right' 'bottom' 'top' 'none']
<i>gid</i>	an id string
<i>label</i>	string or anything printable with '%s' conversion.
<i>linestyle</i> or <i>ls</i>	['solid' 'dashed', 'dashdot', 'dotted' (offset, on-off-dash-seq) '- ' '--' '- .' '']
<i>linewidth</i> or <i>lw</i>	float value in points
<i>marker</i>	<i>A valid marker style</i>
<i>markeredgecolor</i> or <i>mec</i>	any matplotlib color
<i>markeredgewidth</i> or <i>mew</i>	float value in points
<i>markerfacecolor</i> or <i>mfc</i>	any matplotlib color
<i>markerfacecoloralt</i> or <i>mfcalt</i>	any matplotlib color
<i>markersize</i> or <i>ms</i>	float
<i>markevery</i>	[None int length-2 tuple of int slice list/array of int float length-2 tuple of float]
<i>path_effects</i>	unknown

Table 45.17 – continued from previous page

Property	Description
<code>picker</code>	float distance in points or callable pick function <code>fn(artist, event)</code>
<code>pickradius</code>	float distance in points
<code>rasterized</code>	[True False None]
<code>sketch_params</code>	unknown
<code>snap</code>	unknown
<code>solid_capstyle</code>	['butt' 'round' 'projecting']
<code>solid_joinstyle</code>	['miter' 'round' 'bevel']
<code>transform</code>	a <code>matplotlib.transforms.Transform</code> instance
<code>url</code>	a url string
<code>visible</code>	[True False]
<code>xdata</code>	1D array
<code>ydata</code>	1D array
<code>zorder</code>	any number

`matplotlib.pyplot.hexbin(x, y, C=None, gridsize=100, bins=None, xscale='linear', yscale='linear', extent=None, cmap=None, norm=None, vmin=None, vmax=None, alpha=None, linewidths=None, edgecolors='none', reduce_C_function=<function mean>, mincnt=None, marginals=False, hold=None, data=None, **kwargs)`

Make a hexagonal binning plot.

Make a hexagonal binning plot of x versus y , where x, y are 1-D sequences of the same length, N . If C is *None* (the default), this is a histogram of the number of occurrences of the observations at $(x[i], y[i])$.

If C is specified, it specifies values at the coordinate $(x[i], y[i])$. These values are accumulated for each hexagonal bin and then reduced according to `reduce_C_function`, which defaults to numpy's mean function (`np.mean`). (If C is specified, it must also be a 1-D sequence of the same length as x and y .)

Parameters x, y : array or masked array

C : array or masked array, optional, default is *None*

gridsize : int or (int, int), optional, default is 100

The number of hexagons in the x -direction, default is 100. The corresponding number of hexagons in the y -direction is chosen such that the hexagons are approximately regular. Alternatively, `gridsize` can be a tuple with two elements specifying the number of hexagons in the x -direction and the y -direction.

bins : {'log'} or int or sequence, optional, default is *None*

If *None*, no binning is applied; the color of each hexagon directly corresponds to its count value.

If 'log', use a logarithmic scale for the color map. Internally, $\log_{10}(i + 1)$ is used to determine the hexagon color.

If an integer, divide the counts in the specified number of bins, and color the hexagons accordingly.

If a sequence of values, the values of the lower bound of the bins to be used.

xscale : { 'linear', 'log' }, optional, default is 'linear'

Use a linear or log10 scale on the horizontal axis.

yscale : { 'linear', 'log' }, optional, default is 'linear'

Use a linear or log10 scale on the vertical axis.

mincnt : int > 0, optional, default is *None*

If not *None*, only display cells with more than *mincnt* number of points in the cell

marginals : bool, optional, default is *False*

if *marginals* is *True*, plot the marginal density as colormapped rectangles along the bottom of the x-axis and left of the y-axis

extent : scalar, optional, default is *None*

The limits of the bins. The default assigns the limits based on *gridsize*, *x*, *y*, *xscale* and *yscale*.

If *xscale* or *yscale* is set to 'log', the limits are expected to be the exponent for a power of 10. E.g. for x-limits of 1 and 50 in 'linear' scale and y-limits of 10 and 1000 in 'log' scale, enter (1, 50, 1, 3).

Order of scalars is (left, right, bottom, top).

Returns object

a *PolyCollection* instance; use *get_array()* on this *PolyCollection* to get the counts in each hexagon.

If *marginals* is *True*, horizontal bar and vertical bar (both *PolyCollections*) will be attached to the return collection as attributes *hbar* and *vbar*.

Other Parameters **cmap** : object, optional, default is *None*

a *matplotlib.colors.Colormap* instance. If *None*, defaults to rc *image.cmap*.

norm : object, optional, default is *None*

matplotlib.colors.Normalize instance is used to scale luminance data to 0,1.

vmin, vmax : scalar, optional, default is *None*

vmin and *vmax* are used in conjunction with *norm* to normalize luminance data. If *None*, the min and max of the color array *C* are used. Note if you pass a norm instance your settings for *vmin* and *vmax* will be ignored.

alpha : scalar between 0 and 1, optional, default is *None*

the alpha value for the patches

linewidths : scalar, optional, default is *None*

If *None*, defaults to 1.0.

edgecolors : { 'none' } or mpl color, optional, default is 'none'

If 'none', draws the edges in the same color as the fill color. This is the default, as it avoids unsightly unpainted pixels between the hexagons.

If *None*, draws outlines in the default color.

If a matplotlib color arg, draws outlines in the specified color.

Notes

The standard descriptions of all the *Collection* parameters:

Property	Description
<i>agg_filter</i>	unknown
<i>alpha</i>	float or None
<i>animated</i>	[True False]
<i>antialiased</i> or <i>antialiaseds</i>	Boolean or sequence of booleans
<i>array</i>	unknown
<i>axes</i>	an <i>Axes</i> instance
<i>clim</i>	a length 2 sequence of floats
<i>clip_box</i>	a <i>matplotlib.transforms.Bbox</i> instance
<i>clip_on</i>	[True False]
<i>clip_path</i>	[(<i>Path</i> , <i>Transform</i>) <i>Patch</i> None]
<i>cmap</i>	a colormap or registered colormap name
<i>color</i>	matplotlib color arg or sequence of rgba tuples
<i>contains</i>	a callable function
<i>edgecolor</i> or <i>edgecolors</i>	matplotlib color spec or sequence of specs
<i>facecolor</i> or <i>facecolors</i>	matplotlib color spec or sequence of specs
<i>figure</i>	a <i>matplotlib.figure.Figure</i> instance
<i>gid</i>	an id string
<i>hatch</i>	['/' '\' ' ' '-' '+' 'x' 'o' 'O' '.' '*']
<i>label</i>	string or anything printable with '%s' conversion.
<i>linestyle</i> or <i>dashes</i> or <i>linestyles</i>	['solid' 'dashed', 'dashdot', 'dotted' (offset, on-off-dash-seq) '-' '--' '-.']
<i>linewidth</i> or <i>linewidths</i> or <i>lw</i>	float or sequence of floats
<i>norm</i>	unknown
<i>offset_position</i>	unknown
<i>offsets</i>	float or sequence of floats
<i>path_effects</i>	unknown
<i>picker</i>	[None float boolean callable]
<i>pickradius</i>	unknown
<i>rasterized</i>	[True False None]
<i>sketch_params</i>	unknown
<i>snap</i>	unknown
<i>transform</i>	<i>Transform</i> instance

Table 45.18 – continued from previous page

Property	Description
<code>url</code>	a url string
<code>urls</code>	unknown
<code>visible</code>	[True False]
<code>zorder</code>	any number

Note: In addition to the above described arguments, this function can take a **data** keyword argument. If such a **data** argument is given, the following arguments are replaced by **data[<arg>]**:

- All arguments with the following names: ‘x’, ‘y’.

Examples

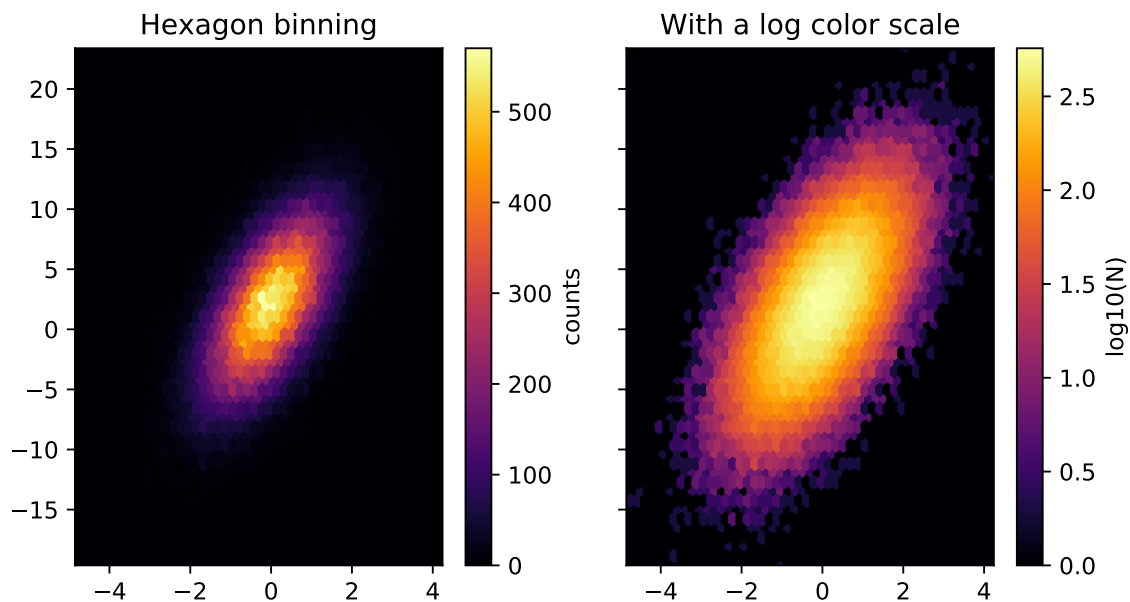

`matplotlib.pyplot.hist(x, bins=None, range=None, normed=False, weights=None, cumulative=False, bottom=None, histtype='bar', align='mid', orientation='vertical', rwidth=None, log=False, color=None, label=None, stacked=False, hold=None, data=None, **kwargs)`

Plot a histogram.

Compute and draw the histogram of x . The return value is a tuple $(n, bins, patches)$ or $([n0, n1, \dots], bins, [patches0, patches1, \dots])$ if the input contains multiple data.

Multiple data can be provided via x as a list of datasets of potentially different length $([x0, x1, \dots])$, or as a 2-D ndarray in which each column is a dataset. Note that the ndarray form is transposed relative

to the list form.

Masked arrays are not supported at present.

Parameters x : (n,) array or sequence of (n,) arrays

Input values, this takes either a single array or a sequence of arrays which are not required to be of the same length

bins : integer or array_like or 'auto', optional

If an integer is given, $\text{bins} + 1$ bin edges are returned, consistently with `numpy.histogram()` for numpy version ≥ 1.3 .

Unequally spaced bins are supported if `bins` is a sequence.

If Numpy 1.11 is installed, may also be 'auto'.

Default is taken from the rcParam `hist.bins`.

range : tuple or None, optional

The lower and upper range of the bins. Lower and upper outliers are ignored. If not provided, `range` is `(x.min(), x.max())`. Range has no effect if `bins` is a sequence.

If `bins` is a sequence or `range` is specified, autoscaling is based on the specified bin range instead of the range of `x`.

Default is None

normed : boolean, optional

If `True`, the first element of the return tuple will be the counts normalized to form a probability density, i.e., $n/(\text{len}(x) \cdot \text{dbin})$, i.e., the integral of the histogram will sum to 1. If `stacked` is also `True`, the sum of the histograms is normalized to 1.

Default is `False`

weights : (n,) array_like or None, optional

An array of weights, of the same shape as `x`. Each value in `x` only contributes its associated weight towards the bin count (instead of 1). If `normed` is `True`, the weights are normalized, so that the integral of the density over the range remains 1.

Default is None

cumulative : boolean, optional

If `True`, then a histogram is computed where each bin gives the counts in that bin plus all bins for smaller values. The last bin gives the total number of datapoints. If `normed` is also `True` then the histogram is normalized such that the last bin equals 1. If `cumulative` evaluates to less than 0 (e.g., -1), the direction of accumulation is reversed. In this case, if `normed` is also `True`, then the histogram is normalized such that the first bin equals 1.

Default is `False`

bottom : array_like, scalar, or None

Location of the bottom baseline of each bin. If a scalar, the base line for each bin is shifted by the same amount. If an array, each bin is shifted independently and the length of bottom must match the number of bins. If None, defaults to 0.

Default is None

histtype : { 'bar', 'barstacked', 'step', 'stepfilled' }, optional

The type of histogram to draw.

- 'bar' is a traditional bar-type histogram. If multiple data are given the bars are aranged side by side.
- 'barstacked' is a bar-type histogram where multiple data are stacked on top of each other.
- 'step' generates a lineplot that is by default unfilled.
- 'stepfilled' generates a lineplot that is by default filled.

Default is 'bar'

align : { 'left', 'mid', 'right' }, optional

Controls how the histogram is plotted.

- 'left': bars are centered on the left bin edges.
- 'mid': bars are centered between the bin edges.
- 'right': bars are centered on the right bin edges.

Default is 'mid'

orientation : { 'horizontal', 'vertical' }, optional

If 'horizontal', *barh* will be used for bar-type histograms and the *bottom* kwarg will be the left edges.

rwidth : scalar or None, optional

The relative width of the bars as a fraction of the bin width. If None, automatically compute the width.

Ignored if `histtype` is 'step' or 'stepfilled'.

Default is None

log : boolean, optional

If True, the histogram axis will be set to a log scale. If log is True and x is a 1D array, empty bins will be filtered out and only the non-empty (`n`, `bins`, `patches`) will be returned.

Default is `False`

color : color or array_like of colors or None, optional

Color spec or sequence of color specs, one per dataset. Default (None) uses the standard line color sequence.

Default is None

label : string or None, optional

String, or sequence of strings to match multiple datasets. Bar charts yield multiple patches per dataset, but only the first gets the label, so that the legend command will work as expected.

default is None

stacked : boolean, optional

If True, multiple data are stacked on top of each other. If False multiple data are arranged side by side if histtype is 'bar' or on top of each other if histtype is 'step'.

Default is False

Returns **n** : array or list of arrays

The values of the histogram bins. See **normed** and **weights** for a description of the possible semantics. If input **x** is an array, then this is an array of length **nbins**. If input is a sequence of arrays [data1, data2, ...], then this is a list of arrays with the values of the histograms for each of the arrays in the same order.

bins : array

The edges of the bins. Length nbins + 1 (nbins left edges and right edge of last bin). Always a single array even when multiple data sets are passed in.

patches : list or list of lists

Silent list of individual patches used to create the histogram or list of such list if multiple input datasets.

Other Parameters **kwargs** : *Patch* properties

See also:

hist2d 2D histograms

Notes

Until numpy release 1.5, the underlying numpy histogram function was incorrect with `normed=True` if bin sizes were unequal. MPL inherited that error. It is now corrected within MPL when using earlier numpy versions.

Examples

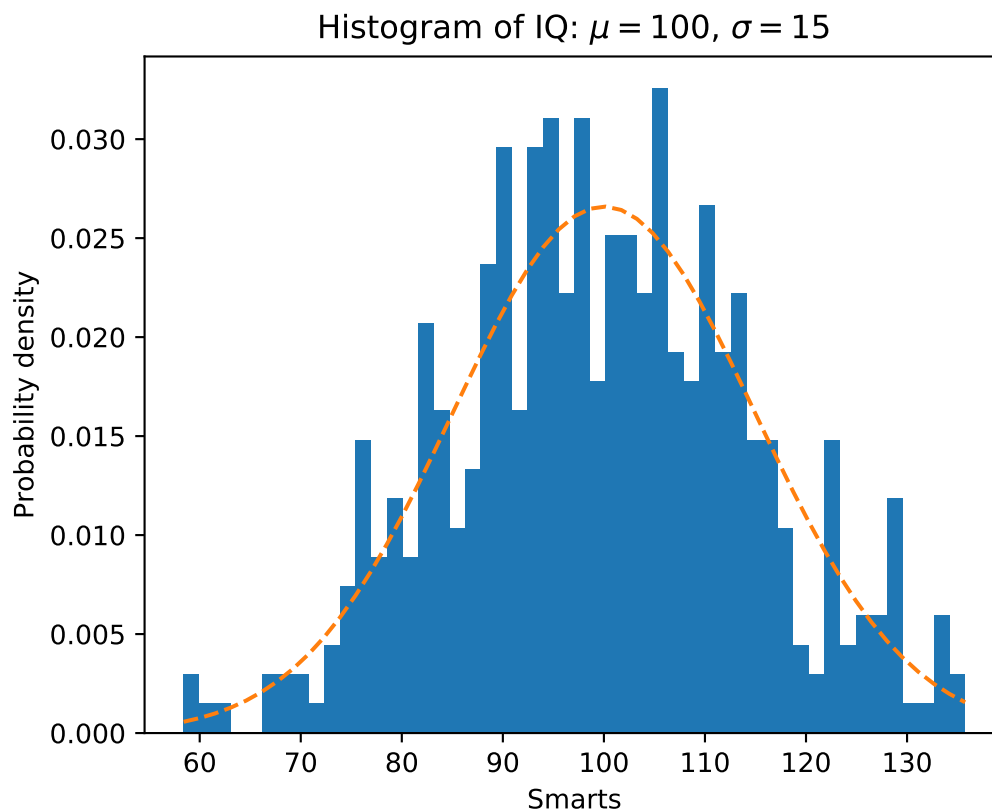

Note: In addition to the above described arguments, this function can take a **data** keyword argument. If such a **data** argument is given, the following arguments are replaced by **data[<arg>]**:

- All arguments with the following names: 'weights', 'x'.
-

`matplotlib.pyplot.hist2d(x, y, bins=10, range=None, normed=False, weights=None, cmin=None, cmax=None, hold=None, data=None, **kwargs)`

Make a 2D histogram plot.

Parameters x, y: `array_like, shape (n,)`

Input values

bins: `[None | int | [int, int] | array_like | [array, array]]`

The bin specification:

- If `int`, the number of bins for the two dimensions (`nx=ny=bins`).
- If `[int, int]`, the number of bins in each dimension (`nx, ny = bins`).
- If `array_like`, the bin edges for the two dimensions (`x_edges=y_edges=bins`).

- If [array, array], the bin edges in each dimension (x_edges, y_edges = bins).

The default value is 10.

range : array_like shape(2, 2), optional, default: None

The leftmost and rightmost edges of the bins along each dimension (if not specified explicitly in the bins parameters): [[xmin, xmax], [ymin, ymax]]. All values outside of this range will be considered outliers and not tallied in the histogram.

normed : boolean, optional, default: False

Normalize histogram.

weights : array_like, shape (n,), optional, default: None

An array of values w_i weighing each sample (x_i, y_i) .

cmin : scalar, optional, default: None

All bins that has count less than cmin will not be displayed and these count values in the return value count histogram will also be set to nan upon return

cmax : scalar, optional, default: None

All bins that has count more than cmax will not be displayed (set to none before passing to imshow) and these count values in the return value count histogram will also be set to nan upon return

Returns The return value is (counts, xedges, yedges, Image).

Other Parameters cmap : {Colormap, string}, optional

A *matplotlib.colors.Colormap* instance. If not set, use rc settings.

norm : Normalize, optional

A *matplotlib.colors.Normalize* instance is used to scale luminance data to [0, 1]. If not set, defaults to `Normalize()`.

vmin/vmax : {None, scalar}, optional

Arguments passed to the `Normalize` instance.

alpha : 0 <= scalar <= 1 or None, optional

The alpha blending value.

See also:

hist 1D histogram

Notes

Rendering the histogram with a logarithmic color scale is accomplished by passing a `colors.LogNorm` instance to the `norm` keyword argument. Likewise, power-law normalization (similar in effect to gamma correction) can be accomplished with `colors.PowerNorm`.

Examples

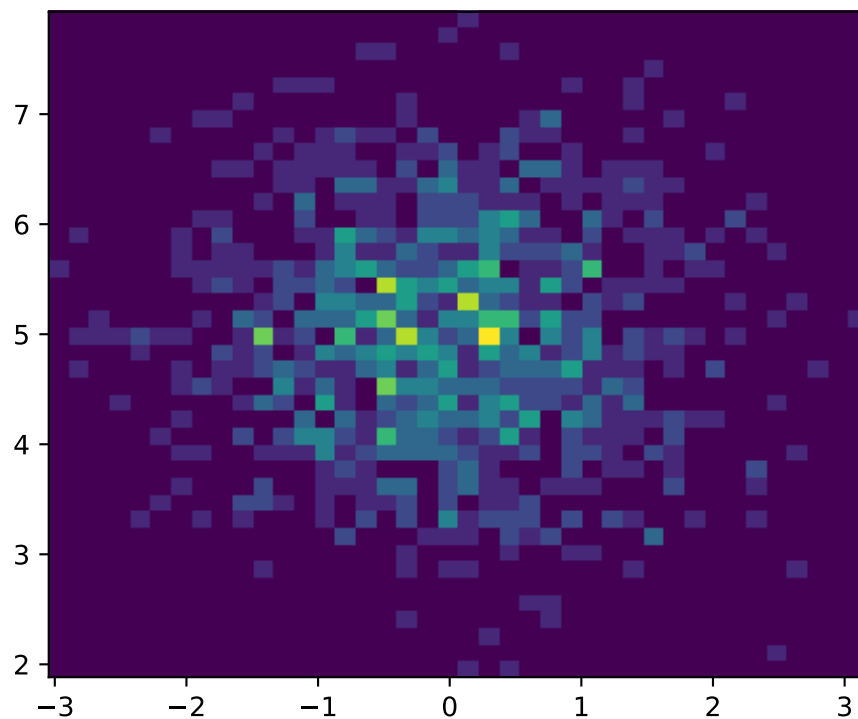

Note: In addition to the above described arguments, this function can take a **data** keyword argument. If such a **data** argument is given, the following arguments are replaced by **data[<arg>]**:

- All arguments with the following names: 'weights', 'x', 'y'.
-

`matplotlib.pyplot.hlines`(*y*, *xmin*, *xmax*, *colors*='k', *linestyles*='solid', *label*='', *hold*=None, *data*=None, ***kwargs*)

Plot horizontal lines at each *y* from *xmin* to *xmax*.

Parameters *y* : scalar or sequence of scalar

y-indexes where to plot the lines.

xmin, **xmax** : scalar or 1D array_like

Respective beginning and end of each line. If scalars are provided, all lines will have same length.

colors : array_like of colors, optional, default: 'k'

linestyles : ['solid' | 'dashed' | 'dashdot' | 'dotted'], optional

label : string, optional, default: ''

Returns lines : *LineCollection*

Other Parameters kwargs : *LineCollection* properties.

See also:

[vlines](#) vertical lines

Examples

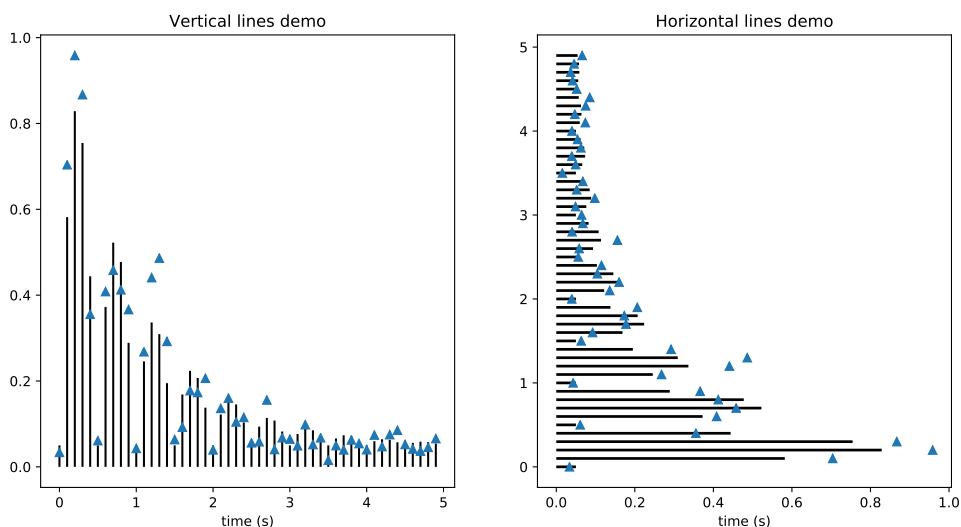

Note: In addition to the above described arguments, this function can take a **data** keyword argument. If such a **data** argument is given, the following arguments are replaced by **data[<arg>]**:

- All arguments with the following names: 'xmax', 'xmin', 'y'.
-

`matplotlib.pyplot.hold`(*b=None*)

Deprecated since version 2.0: `pyplot.hold` is deprecated. Future behavior will be consistent with the long-time default: plot commands add elements without first clearing the Axes and/or Figure.

Set the hold state. If *b* is None (default), toggle the hold state, else set the hold state to boolean value *b*:

```
hold()      # toggle hold
hold(True)  # hold is on
hold(False) # hold is off
```

When *hold* is *True*, subsequent plot commands will add elements to the current axes. When *hold* is *False*, the current axes and figure will be cleared on the next plot command.

`matplotlib.pyplot.hot()`

set the default colormap to hot and apply to current image if any. See `help(colormaps)` for more information

`matplotlib.pyplot.hsv()`

set the default colormap to hsv and apply to current image if any. See `help(colormaps)` for more information

`matplotlib.pyplot.imread(*args, **kwargs)`

Read an image from a file into an array.

fname may be a string path, a valid URL, or a Python file-like object. If using a file object, it must be opened in binary mode.

If *format* is provided, will try to read file of that type, otherwise the format is deduced from the filename. If nothing can be deduced, PNG is tried.

Return value is a `numpy.array`. For grayscale images, the return array is $M \times N$. For RGB images, the return value is $M \times N \times 3$. For RGBA images the return value is $M \times N \times 4$.

matplotlib can only read PNGs natively, but if `PIL` is installed, it will use it to load the image and return an array (if possible) which can be used with `imshow()`. Note, URL strings may not be compatible with PIL. Check the PIL documentation for more information.

`matplotlib.pyplot.imsave(*args, **kwargs)`

Save an array as in image file.

The output formats available depend on the backend being used.

Arguments:

fname: A string containing a path to a filename, or a Python file-like object. If *format* is *None* and *fname* is a string, the output format is deduced from the extension of the filename.

arr: An $M \times N$ (luminance), $M \times N \times 3$ (RGB) or $M \times N \times 4$ (RGBA) array.

Keyword arguments:

vmin/vmax: [**None** | **scalar**] *vmin* and *vmax* set the color scaling for the image by fixing the values that map to the colormap color limits. If either *vmin* or *vmax* is *None*, that limit is determined from the *arr* min/max value.

cmap: *cmap* is a `colors.Colormap` instance, e.g., `cm.jet`. If *None*, default to the rc image.cmap value.

format: One of the file extensions supported by the active backend. Most backends support `png`, `pdf`, `ps`, `eps` and `svg`.

origin ['upper' | 'lower'] Indicates where the [0,0] index of the array is in the upper left or lower left corner of the axes. Defaults to the `rc image.origin` value.

dpi The DPI to store in the metadata of the file. This does not affect the resolution of the output image.

`matplotlib.pyplot.imshow(X, cmap=None, norm=None, aspect=None, interpolation=None, alpha=None, vmin=None, vmax=None, origin=None, extent=None, shape=None, filternorm=1, filterrad=4.0, imlim=None, resample=None, url=None, hold=None, data=None, **kwargs)`

Display an image on the axes.

Parameters X : array_like, shape (n, m) or (n, m, 3) or (n, m, 4)

Display the image in **X** to current axes. **X** may be an array or a PIL image. If **X** is an array, it can have the following shapes and types:

- $M \times N$ – values to be mapped (float or int)
- $M \times N \times 3$ – RGB (float or uint8)
- $M \times N \times 4$ – RGBA (float or uint8)

The value for each component of $M \times N \times 3$ and $M \times N \times 4$ float arrays should be in the range 0.0 to 1.0. $M \times N$ arrays are mapped to colors based on the `norm` (mapping scalar to scalar) and the `cmap` (mapping the normed scalar to a color).

cmap : *Colormap*, optional, default: None

If None, default to `rc image.cmap` value. `cmap` is ignored if **X** is 3-D, directly specifying RGB(A) values.

aspect : ['auto' | 'equal' | scalar], optional, default: None

If 'auto', changes the image aspect ratio to match that of the axes.

If 'equal', and `extent` is None, changes the axes aspect ratio to match that of the image. If `extent` is not None, the axes aspect ratio is changed to match that of the extent.

If None, default to `rc image.aspect` value.

interpolation : string, optional, default: None

Acceptable values are 'none', 'nearest', 'bilinear', 'bicubic', 'spline16', 'spline36', 'hanning', 'hamming', 'hermite', 'kaiser', 'quadric', 'catrom', 'gaussian', 'bessel', 'mitchell', 'sinc', 'lanczos'

If `interpolation` is None, default to `rc image.interpolation`. See also the `filternorm` and `filterrad` parameters. If `interpolation` is 'none', then no interpolation is performed on the Agg, ps and pdf backends. Other backends will fall back to 'nearest'.

norm : *Normalize*, optional, default: None

A *Normalize* instance is used to scale a 2-D float *X* input to the (0, 1) range for input to the *cmap*. If *norm* is *None*, use the default `func:normalize`. If *norm* is an instance of *NoNorm*, *X* must be an array of integers that index directly into the lookup table of the *cmap*.

vmin, vmax : scalar, optional, default: *None*

vmin and *vmax* are used in conjunction with *norm* to normalize luminance data. Note if you pass a *norm* instance, your settings for *vmin* and *vmax* will be ignored.

alpha : scalar, optional, default: *None*

The alpha blending value, between 0 (transparent) and 1 (opaque)

origin : ['upper' | 'lower'], optional, default: *None*

Place the [0,0] index of the array in the upper left or lower left corner of the axes. If *None*, default to `rc image.origin`.

extent : scalars (left, right, bottom, top), optional, default: *None*

The location, in data-coordinates, of the lower-left and upper-right corners. If *None*, the image is positioned such that the pixel centers fall on zero-based (row, column) indices.

shape : scalars (columns, rows), optional, default: *None*

For raw buffer images

filternorm : scalar, optional, default: 1

A parameter for the antigrain image resize filter. From the antigrain documentation, if *filternorm* = 1, the filter normalizes integer values and corrects the rounding errors. It doesn't do anything with the source floating point values, it corrects only integers according to the rule of 1.0 which means that any sum of pixel weights must be equal to 1.0. So, the filter function must produce a graph of the proper shape.

filterrad : scalar, optional, default: 4.0

The filter radius for filters that have a radius parameter, i.e. when interpolation is one of: 'sinc', 'lanczos' or 'blackman'

Returns image : *AxesImage*

Other Parameters kwargs : *Artist* properties.

See also:

imshow Plot a matrix or an array as an image.

Notes

Unless *extent* is used, pixel centers will be located at integer coordinates. In other words: the origin will coincide with the center of pixel (0, 0).

Examples

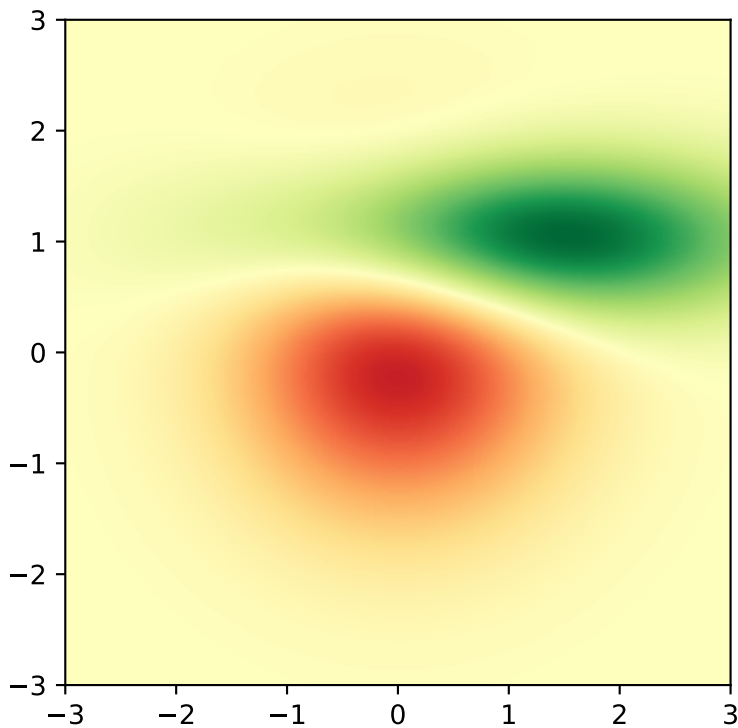

Note: In addition to the above described arguments, this function can take a **data** keyword argument. If such a **data** argument is given, the following arguments are replaced by **data[<arg>]**:

- All positional and all keyword arguments.
-

`matplotlib.pyplot.inferno()`

set the default colormap to inferno and apply to current image if any. See `help(colormaps)` for more information

`matplotlib.pyplot.install_repl_displayhook()`

Install a repl display hook so that any stale figure are automatically redrawn when control is returned to the repl.

This works with IPython terminals and kernels, as well as vanilla python shells.

`matplotlib.pyplot.ioff()`
Turn interactive mode off.

`matplotlib.pyplot.ion()`
Turn interactive mode on.

`matplotlib.pyplot.ishold()`
Deprecated since version 2.0: `pyplot.hold` is deprecated. Future behavior will be consistent with the long-time default: plot commands add elements without first clearing the Axes and/or Figure.
Return the hold status of the current axes.

`matplotlib.pyplot.isinteractive()`
Return status of interactive mode.

`matplotlib.pyplot.jet()`
set the default colormap to jet and apply to current image if any. See `help(colormaps)` for more information

`matplotlib.pyplot.legend(*args, **kwargs)`
Places a legend on the axes.

To make a legend for lines which already exist on the axes (via `plot` for instance), simply call this function with an iterable of strings, one for each legend item. For example:

```
ax.plot([1, 2, 3])
ax.legend(['A simple line'])
```

However, in order to keep the “label” and the legend element instance together, it is preferable to specify the label either at artist creation, or by calling the `set_label()` method on the artist:

```
line, = ax.plot([1, 2, 3], label='Inline label')
# Overwrite the label by calling the method.
line.set_label('Label via method')
ax.legend()
```

Specific lines can be excluded from the automatic legend element selection by defining a label starting with an underscore. This is default for all artists, so calling `legend()` without any arguments and without setting the labels manually will result in no legend being drawn.

For full control of which artists have a legend entry, it is possible to pass an iterable of legend artists followed by an iterable of legend labels respectively:

```
legend((line1, line2, line3), ('label1', 'label2', 'label3'))
```

Parameters loc : int or string or pair of floats, default: ‘upper right’

The location of the legend. Possible codes are:

Location String	Location Code
'best'	0
'upper right'	1
'upper left'	2
'lower left'	3
'lower right'	4
'right'	5
'center left'	6
'center right'	7
'lower center'	8
'upper center'	9
'center'	10

Alternatively can be a 2-tuple giving x , y of the lower-left corner of the legend in axes coordinates (in which case `bbox_to_anchor` will be ignored).

bbox_to_anchor : *matplotlib.transforms.BboxBase* instance or tuple of floats

Specify any arbitrary location for the legend in `bbox_transform` coordinates (default Axes coordinates).

For example, to put the legend's upper right hand corner in the center of the axes the following keywords can be used:

```
loc='upper right', bbox_to_anchor=(0.5, 0.5)
```

ncol : integer

The number of columns that the legend has. Default is 1.

prop : None or *matplotlib.font_manager.FontProperties* or dict

The font properties of the legend. If None (default), the current *matplotlib.rcParams* will be used.

fontsize : int or float or {'xx-small', 'x-small', 'small', 'medium', 'large', 'x-large', 'xx-large'}

Controls the font size of the legend. If the value is numeric the size will be the absolute font size in points. String values are relative to the current default font size. This argument is only used if `prop` is not specified.

numpoints : None or int

The number of marker points in the legend when creating a legend entry for a line/*matplotlib.lines.Line2D*. Default is None which will take the value from the legend.`numpoints rcParam`.

scatterpoints : None or int

The number of marker points in the legend when creating a legend entry for a scatter plot/ *matplotlib.collections.PathCollection*. Default is None which will take the value from the legend.`scatterpoints rcParam`.

scatteryoffsets : iterable of floats

The vertical offset (relative to the font size) for the markers created for a scatter plot legend entry. 0.0 is at the base the legend text, and 1.0 is at the top. To draw all markers at the same height, set to [0.5]. Default [0.375, 0.5, 0.3125].

markerscale : None or int or float

The relative size of legend markers compared with the originally drawn ones. Default is None which will take the value from the `legend.markerscale rcParam`.

markerfirst : bool

if *True*, legend marker is placed to the left of the legend label if *False*, legend marker is placed to the right of the legend label

frameon : None or bool

Control whether the legend should be drawn on a patch (frame). Default is None which will take the value from the `legend.frameon rcParam`.

fancybox : None or bool

Control whether round edges should be enabled around the `FancyBboxPatch` which makes up the legend's background. Default is None which will take the value from the `legend.fancybox rcParam`.

shadow : None or bool

Control whether to draw a shadow behind the legend. Default is None which will take the value from the `legend.shadow rcParam`.

framealpha : None or float

Control the alpha transparency of the legend's background. Default is None which will take the value from the `legend.framealpha rcParam`.

facecolor : None or "inherit" or a color spec

Control the legend's background color. Default is None which will take the value from the `legend.facecolor rcParam`. If "inherit", it will take the `axes.facecolor rcParam`.

edgecolor : None or "inherit" or a color spec

Control the legend's background patch edge color. Default is None which will take the value from the `legend.edgecolor rcParam`. If "inherit", it will take the `axes.edgecolor rcParam`.

mode : {"expand", None}

If mode is set to "expand" the legend will be horizontally expanded to fill the axes area (or `bbox_to_anchor` if defines the legend's size).

bbox_transform : None or `matplotlib.transforms.Transform`

The transform for the bounding box (`bbox_to_anchor`). For a value of None (default) the Axes' `transAxes` transform will be used.

title : str or None

The legend's title. Default is no title (None).

borderpad : float or None

The fractional whitespace inside the legend border. Measured in font-size units. Default is None which will take the value from the `legend.borderpad` *rcParam*.

labelspacing : float or None

The vertical space between the legend entries. Measured in font-size units. Default is None which will take the value from the `legend.labelspacing` *rcParam*.

handlelength : float or None

The length of the legend handles. Measured in font-size units. Default is None which will take the value from the `legend.handlelength` *rcParam*.

handletextpad : float or None

The pad between the legend handle and text. Measured in font-size units. Default is None which will take the value from the `legend.handletextpad` *rcParam*.

borderaxespad : float or None

The pad between the axes and legend border. Measured in font-size units. Default is None which will take the value from the `legend.borderaxespad` *rcParam*.

columnspacing : float or None

The spacing between columns. Measured in font-size units. Default is None which will take the value from the `legend.columnspacing` *rcParam*.

handler_map : dict or None

The custom dictionary mapping instances or types to a legend handler. This `handler_map` updates the default handler map found at `matplotlib.legend.Legend.get_legend_handler_map()`.

Notes

Not all kinds of artist are supported by the legend command. See *Legend guide* for details.

Examples

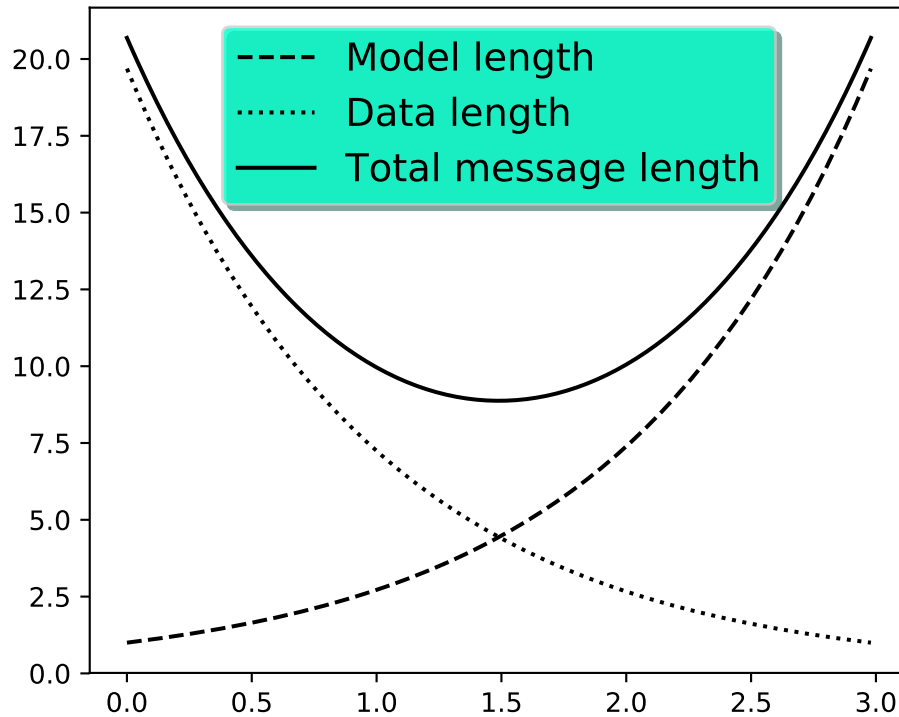

`matplotlib.pyplot.locator_params(axis='both', tight=None, **kwargs)`

Control behavior of tick locators.

Keyword arguments:

axis ['x' | 'y' | 'both'] Axis on which to operate; default is 'both'.

tight [True | False | None] Parameter passed to `autoscale_view()`. Default is None, for no change.

Remaining keyword arguments are passed directly to the `set_params()` method.

Typically one might want to reduce the maximum number of ticks and use tight bounds when plotting small subplots, for example:

```
ax.locator_params(tight=True, nbins=4)
```

Because the locator is involved in autoscaling, `autoscale_view()` is called automatically after the parameters are changed.

This presently works only for the `MaxNLocator` used by default on linear axes, but it may be generalized.

`matplotlib.pyplot.loglog(*args, **kwargs)`

Make a plot with log scaling on both the *x* and *y* axis.

`loglog()` supports all the keyword arguments of `plot()` and `matplotlib.axes.Axes.set_xscale()` / `matplotlib.axes.Axes.set_yscale()`.

Notable keyword arguments:

`basex/basey`: scalar > 1 Base of the x/y logarithm

`subsx/subsy`: [*None* | **sequence]** The location of the minor x/y ticks; *None* defaults to autosubs, which depend on the number of decades in the plot; see `matplotlib.axes.Axes.set_xscale()` / `matplotlib.axes.Axes.set_yscale()` for details

`nonposx/nonposy`: ['mask' | 'clip'] Non-positive values in x or y can be masked as invalid, or clipped to a very small positive number

The remaining valid kwargs are *Line2D* properties:

Property	Description
<code>agg_filter</code>	unknown
<code>alpha</code>	float (0.0 transparent through 1.0 opaque)
<code>animated</code>	[True False]
<code>antialiased</code> or <code>aa</code>	[True False]
<code>axes</code>	an <i>Axes</i> instance
<code>clip_box</code>	a <code>matplotlib.transforms.Bbox</code> instance
<code>clip_on</code>	[True False]
<code>clip_path</code>	[(<i>Path</i> , <i>Transform</i>) <i>Patch</i> None]
<code>color</code> or <code>c</code>	any matplotlib color
<code>contains</code>	a callable function
<code>dash_capstyle</code>	['butt' 'round' 'projecting']
<code>dash_joinstyle</code>	['miter' 'round' 'bevel']
<code>dashes</code>	sequence of on/off ink in points
<code>drawstyle</code>	['default' 'steps' 'steps-pre' 'steps-mid' 'steps-post']
<code>figure</code>	a <code>matplotlib.figure.Figure</code> instance
<code>fillstyle</code>	['full' 'left' 'right' 'bottom' 'top' 'none']
<code>gid</code>	an id string
<code>label</code>	string or anything printable with '%s' conversion.
<code>linestyle</code> or <code>ls</code>	['solid' 'dashed', 'dashdot', 'dotted' (offset, on-off-dash-seq) '-' '--' '-.' '']
<code>linewidth</code> or <code>lw</code>	float value in points
<code>marker</code>	<i>A valid marker style</i>
<code>markeredgecolor</code> or <code>mec</code>	any matplotlib color
<code>markeredgewidth</code> or <code>mew</code>	float value in points
<code>markerfacecolor</code> or <code>mfc</code>	any matplotlib color
<code>markerfacecoloralt</code> or <code>mfcalt</code>	any matplotlib color
<code>markersize</code> or <code>ms</code>	float
<code>markevery</code>	[None int length-2 tuple of int slice list/array of int float length-2 tuple of float]
<code>path_effects</code>	unknown
<code>picker</code>	float distance in points or callable pick function <code>fn(artist, event)</code>
<code>pickradius</code>	float distance in points
<code>rasterized</code>	[True False None]

Table 45.19 – continued from previous page

Property	Description
<code>sketch_params</code>	unknown
<code>snap</code>	unknown
<code>solid_capstyle</code>	['butt' 'round' 'projecting']
<code>solid_joinstyle</code>	['miter' 'round' 'bevel']
<code>transform</code>	a <code>matplotlib.transforms.Transform</code> instance
<code>url</code>	a url string
<code>visible</code>	[True False]
<code>xdata</code>	1D array
<code>ydata</code>	1D array
<code>zorder</code>	any number

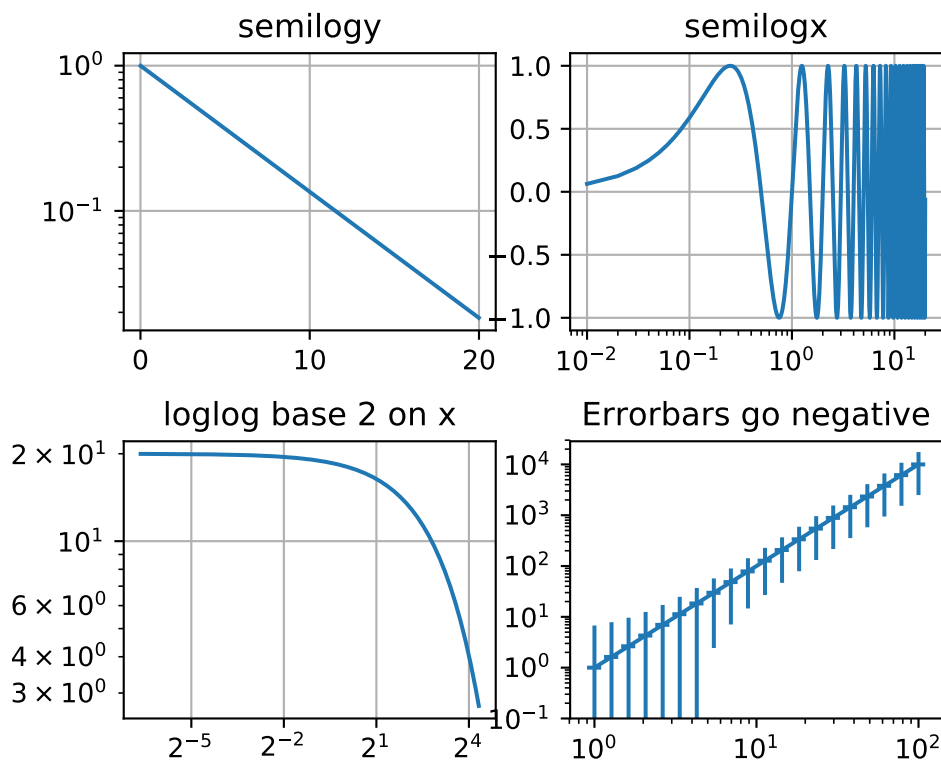
Example:

`matplotlib.pyplot.magma()`

set the default colormap to magma and apply to current image if any. See `help(colormaps)` for more information

`matplotlib.pyplot.magnitude_spectrum(x, Fs=None, Fc=None, window=None, pad_to=None, sides=None, scale=None, hold=None, data=None, **kwargs)`

Plot the magnitude spectrum.

Call signature:

```
magnitude_spectrum(x, Fs=2, Fc=0, window=mlab.window_hanning,  
                  pad_to=None, sides='default', **kwargs)
```

Compute the magnitude spectrum of x . Data is padded to a length of pad_to and the windowing function $window$ is applied to the signal.

Parameters x : 1-D array or sequence

Array or sequence containing the data

Fs : scalar

The sampling frequency (samples per time unit). It is used to calculate the Fourier frequencies, f_{reqs} , in cycles per time unit. The default value is 2.

window : callable or ndarray

A function or a vector of length $NFFT$. To create window vectors see `window_hanning()`, `window_none()`, `numpy.blackman()`, `numpy.hamming()`, `numpy.bartlett()`, `scipy.signal()`, `scipy.signal.get_window()`, etc. The default is `window_hanning()`. If a function is passed as the argument, it must take a data segment as an argument and return the windowed version of the segment.

sides : ['default' | 'onesided' | 'twosided']

Specifies which sides of the spectrum to return. Default gives the default behavior, which returns one-sided for real data and both for complex data. 'onesided' forces the return of a one-sided spectrum, while 'twosided' forces two-sided.

pad_to : integer

The number of points to which the data segment is padded when performing the FFT. While not increasing the actual resolution of the spectrum (the minimum distance between resolvable peaks), this can give more points in the plot, allowing for more detail. This corresponds to the n parameter in the call to `fft()`. The default is `None`, which sets pad_to equal to the length of the input signal (i.e. no padding).

scale : ['default' | 'linear' | 'dB']

The scaling of the values in the $spec$. 'linear' is no scaling. 'dB' returns the values in dB scale. When $mode$ is 'density', this is dB power ($10 * \log_{10}$). Otherwise this is dB amplitude ($20 * \log_{10}$). 'default' is 'linear'.

Fc : integer

The center frequency of x (defaults to 0), which offsets the x extents of the plot to reflect the frequency range used when a signal is acquired and then filtered and downsampled to baseband.

****kwargs :**

Keyword arguments control the *Line2D* properties:

Property	Description
<i>agg_filter</i>	unknown
<i>alpha</i>	float (0.0 transparent through 1.0 opaque)
<i>animated</i>	[True False]
<i>antialiased</i> or <i>aa</i>	[True False]
<i>axes</i>	an <i>Axes</i> instance
<i>clip_box</i>	a <i>matplotlib.transforms.Bbox</i> instance
<i>clip_on</i>	[True False]
<i>clip_path</i>	[(<i>Path</i> , <i>Transform</i>) <i>Patch</i> None]
<i>color</i> or <i>c</i>	any matplotlib color
<i>contains</i>	a callable function
<i>dash_capstyle</i>	['butt' 'round' 'projecting']
<i>dash_joinstyle</i>	['miter' 'round' 'bevel']
<i>dashes</i>	sequence of on/off ink in points
<i>drawstyle</i>	['default' 'steps' 'steps-pre' 'steps-mid' 'steps-post']
<i>figure</i>	a <i>matplotlib.figure.Figure</i> instance
<i>fillstyle</i>	['full' 'left' 'right' 'bottom' 'top' 'none']
<i>gid</i>	an id string
<i>label</i>	string or anything printable with '%s' conversion.
<i>linestyle</i> or <i>ls</i>	['solid' 'dashed', 'dashdot', 'dotted' (offset, on-off-dash-seq) '-' '--' '-.' ' ']
<i>linewidth</i> or <i>lw</i>	float value in points
<i>marker</i>	<i>A valid marker style</i>
<i>markeredgecolor</i> or <i>mec</i>	any matplotlib color
<i>markeredgewidth</i> or <i>mew</i>	float value in points
<i>markerfacecolor</i> or <i>mfc</i>	any matplotlib color
<i>markerfacecoloralt</i> or <i>mfcalt</i>	any matplotlib color
<i>markersize</i> or <i>ms</i>	float
<i>markevery</i>	[None int length-2 tuple of int slice list/array of int float length-2 tuple of float]
<i>path_effects</i>	unknown
<i>picker</i>	float distance in points or callable pick function <code>fn(artist, event)</code>
<i>pickradius</i>	float distance in points
<i>rasterized</i>	[True False None]
<i>sketch_params</i>	unknown
<i>snap</i>	unknown
<i>solid_capstyle</i>	['butt' 'round' 'projecting']
<i>solid_joinstyle</i>	['miter' 'round' 'bevel']
<i>transform</i>	a <i>matplotlib.transforms.Transform</i> instance
<i>url</i>	a url string
<i>visible</i>	[True False]
<i>xdata</i>	1D array
<i>ydata</i>	1D array
<i>zorder</i>	any number

Returns spectrum : 1-D array

The values for the magnitude spectrum before scaling (real valued)

freqs : 1-D array

The frequencies corresponding to the elements in *spectrum*

line : a *Line2D* instance

The line created by this function

See also:

psd() *psd()* plots the power spectral density.‘.

angle_spectrum() *angle_spectrum()* plots the angles of the corresponding frequencies.

phase_spectrum() *phase_spectrum()* plots the phase (unwrapped angle) of the corresponding frequencies.

specgram() *specgram()* can plot the magnitude spectrum of segments within the signal in a colormap.

In addition to the above described arguments, this function can take a **data** keyword argument. If such a **data** argument is given, the following arguments are replaced by **data[<arg>]**: * All arguments with the following names: ‘x’.

Examples

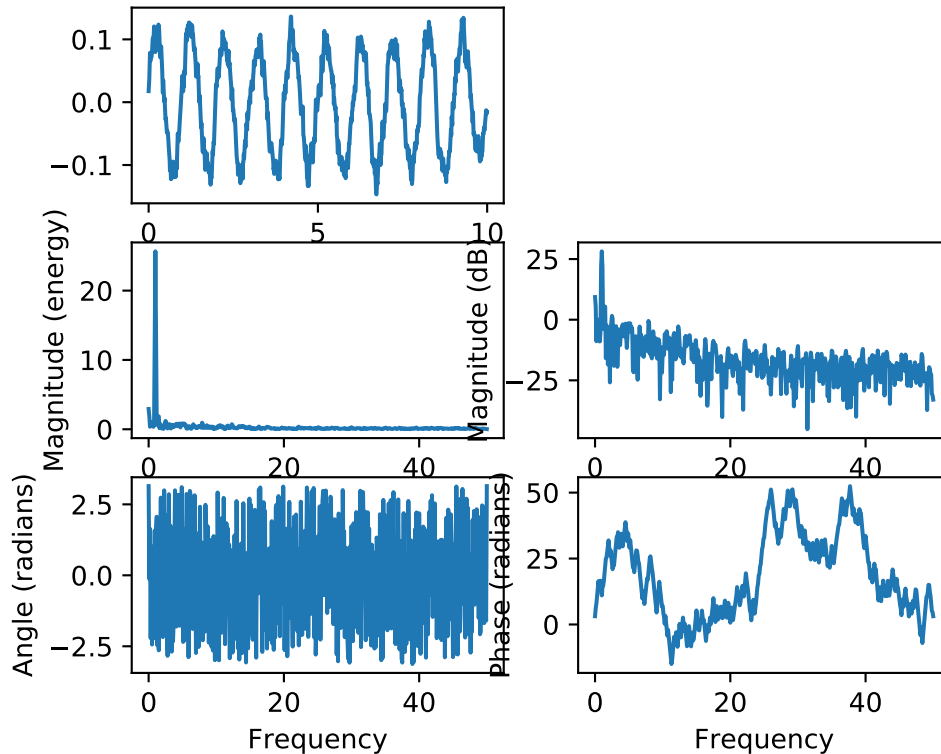

`matplotlib.pyplot.margins(*args, **kw)`

Set or retrieve autoscaling margins.

signatures:

```
margins()
```

returns `xmargin`, `ymargin`

```
margins(margin)
```

```
margins(xmargin, ymargin)
```

```
margins(x=xmargin, y=ymargin)
```

```
margins(..., tight=False)
```

All three forms above set the `xmargin` and `ymargin` parameters. All keyword parameters are optional. A single argument specifies both `xmargin` and `ymargin`. The `tight` parameter is passed to `autoscale_view()`, which is executed after a margin is changed; the default here is `True`, on the assumption that when margins are specified, no additional padding to match tick marks is usually desired. Setting `tight` to `None` will preserve the previous setting.

Specifying any margin changes only the autoscaling; for example, if *xmargin* is not `None`, then *xmargin* times the X data interval will be added to each end of that interval before it is used in autoscaling.

`matplotlib.pyplot.matshow(A, fignum=None, **kw)`

Display an array as a matrix in a new figure window.

The origin is set at the upper left hand corner and rows (first dimension of the array) are displayed horizontally. The aspect ratio of the figure window is that of the array, unless this would make an excessively short or narrow figure.

Tick labels for the xaxis are placed on top.

With the exception of *fignum*, keyword arguments are passed to `imshow()`. You may set the *origin* kwarg to “lower” if you want the first row in the array to be at the bottom instead of the top.

fignum: [`None` | `integer` | `False`] By default, `matshow()` creates a new figure window with automatic numbering. If *fignum* is given as an integer, the created figure will use this figure number. Because of how `matshow()` tries to set the figure aspect ratio to be the one of the array, if you provide the number of an already existing figure, strange things may happen.

If *fignum* is `False` or 0, a new figure window will **NOT** be created.

`matplotlib.pyplot.minorticks_off()`

Remove minor ticks from the current plot.

`matplotlib.pyplot.minorticks_on()`

Display minor ticks on the current plot.

Displaying minor ticks reduces performance; turn them off using `minorticks_off()` if drawing speed is a problem.

`matplotlib.pyplot.nipy_spectral()`

set the default colormap to `nipy_spectral` and apply to current image if any. See `help(colormaps)` for more information

`matplotlib.pyplot.over(func, *args, **kwargs)`

Deprecated since version 2.0: `pyplot.hold` is deprecated. Future behavior will be consistent with the long-time default: plot commands add elements without first clearing the Axes and/or Figure.

Call a function with `hold(True)`.

Calls:

`func(*args, **kwargs)`

with `hold(True)` and then restores the hold state.

`matplotlib.pyplot.pause(interval)`

Pause for *interval* seconds.

If there is an active figure it will be updated and displayed, and the GUI event loop will run during the pause.

If there is no active figure, or if a non-interactive backend is in use, this executes `time.sleep(interval)`.

This can be used for crude animation. For more complex animation, see [matplotlib.animation](#).

This function is experimental; its behavior may be changed or extended in a future release.

`matplotlib.pyplot.pcolor(*args, **kwargs)`

Create a pseudocolor plot of a 2-D array.

Note: `pcolor` can be very slow for large arrays; consider using the similar but much faster `pcolormesh()` instead.

Call signatures:

```
pcolor(C, **kwargs)
pcolor(X, Y, C, **kwargs)
```

`C` is the array of color values.

`X` and `Y`, if given, specify the (x, y) coordinates of the colored quadrilaterals; the quadrilateral for `C[i,j]` has corners at:

```
(X[i, j], Y[i, j]),
(X[i, j+1], Y[i, j+1]),
(X[i+1, j], Y[i+1, j]),
(X[i+1, j+1], Y[i+1, j+1]).
```

Ideally the dimensions of `X` and `Y` should be one greater than those of `C`; if the dimensions are the same, then the last row and column of `C` will be ignored.

Note that the column index corresponds to the x -coordinate, and the row index corresponds to y ; for details, see the *Grid Orientation* section below.

If either or both of `X` and `Y` are 1-D arrays or column vectors, they will be expanded as needed into the appropriate 2-D arrays, making a rectangular grid.

`X`, `Y` and `C` may be masked arrays. If either `C[i, j]`, or one of the vertices surrounding `C[i,j]` (`X` or `Y` at `[i, j]`, `[i+1, j]`, `[i, j+1]`, `[i+1, j+1]`) is masked, nothing is plotted.

Keyword arguments:

`cmap`: [*None* | **Colormap**] A `matplotlib.colors.Colormap` instance. If *None*, use rc settings.

`norm`: [*None* | **Normalize**] An `matplotlib.colors.Normalize` instance is used to scale luminance data to 0,1. If *None*, defaults to `normalize()`.

`vmin/vmax`: [*None* | **scalar**] `vmin` and `vmax` are used in conjunction with `norm` to normalize luminance data. If either is *None*, it is autoscaled to the respective min or max of the color array `C`. If not *None*, `vmin` or `vmax` passed in here override any pre-existing values supplied in the `norm` instance.

`shading`: [**'flat'** | **'faceted'**] If **'faceted'**, a black grid is drawn around each rectangle; if **'flat'**, edges are not drawn. Default is **'flat'**, contrary to MATLAB.

This kwarg is deprecated; please use **'edgecolors' instead:**

- `shading='flat'` – `edgecolors='none'`

•shading='faceted' – edgecolors='k'

edgecolors: [*None* | 'none' | color | color sequence] If *None*, the rc setting is used by default.

If 'none', edges will not be visible.

An mpl color or sequence of colors will set the edge color

alpha: 0 <= scalar <= 1 or *None* the alpha blending value

snap: bool Whether to snap the mesh to pixel boundaries.

Return value is a `matplotlib.collections.Collection` instance. The grid orientation follows the MATLAB convention: an array *C* with shape (*nrows*, *ncolumns*) is plotted with the column number as *X* and the row number as *Y*, increasing up; hence it is plotted the way the array would be printed, except that the *Y* axis is reversed. That is, *C* is taken as *C**(**y*, *x*).

Similarly for `meshgrid()`:

```
x = np.arange(5)
y = np.arange(3)
X, Y = np.meshgrid(x, y)
```

is equivalent to:

```
X = array([[0, 1, 2, 3, 4],
          [0, 1, 2, 3, 4],
          [0, 1, 2, 3, 4]])
Y = array([[0, 0, 0, 0, 0],
          [1, 1, 1, 1, 1],
          [2, 2, 2, 2, 2]])
```

so if you have:

```
C = rand(len(x), len(y))
```

then you need to transpose *C*:

```
pcolor(X, Y, C.T)
```

or:

```
pcolor(C.T)
```

MATLAB `pcolor()` always discards the last row and column of *C*, but matplotlib displays the last row and column if *X* and *Y* are not specified, or if *X* and *Y* have one more row and column than *C*.

kwargs can be used to control the `PolyCollection` properties:

Property	Description
<code>agg_filter</code>	unknown

Table 45.21 – continued from previous page

Property	Description
<i>alpha</i>	float or None
<i>animated</i>	[True False]
<i>antialiased</i> or <i>antialiaseds</i>	Boolean or sequence of booleans
<i>array</i>	unknown
<i>axes</i>	an <i>Axes</i> instance
<i>clim</i>	a length 2 sequence of floats
<i>clip_box</i>	a <i>matplotlib.transforms.Bbox</i> instance
<i>clip_on</i>	[True False]
<i>clip_path</i>	[(<i>Path</i> , <i>Transform</i>) <i>Patch</i> None]
<i>cmap</i>	a colormap or registered colormap name
<i>color</i>	matplotlib color arg or sequence of rgba tuples
<i>contains</i>	a callable function
<i>edgecolor</i> or <i>edgecolors</i>	matplotlib color spec or sequence of specs
<i>facecolor</i> or <i>facecolors</i>	matplotlib color spec or sequence of specs
<i>figure</i>	a <i>matplotlib.figure.Figure</i> instance
<i>gid</i>	an id string
<i>hatch</i>	['/' '\' ' ' '-' '+' 'x' 'o' 'O' '.' '*']
<i>label</i>	string or anything printable with '%s' conversion.
<i>linestyle</i> or <i>dashes</i> or <i>linestyles</i>	['solid' 'dashed', 'dashdot', 'dotted' (offset, on-off-dash-seq) '-' '--' '-.' '']
<i>linewidth</i> or <i>linewidths</i> or <i>lw</i>	float or sequence of floats
<i>norm</i>	unknown
<i>offset_position</i>	unknown
<i>offsets</i>	float or sequence of floats
<i>path_effects</i>	unknown
<i>picker</i>	[None float boolean callable]
<i>pickradius</i>	unknown
<i>rasterized</i>	[True False None]
<i>sketch_params</i>	unknown
<i>snap</i>	unknown
<i>transform</i>	<i>Transform</i> instance
<i>url</i>	a url string
<i>urls</i>	unknown
<i>visible</i>	[True False]
<i>zorder</i>	any number

Note: The default *antialiaseds* is False if the default *edgecolors*= "none"* is used. This eliminates artificial lines at patch boundaries, and works regardless of the value of *alpha*. If **edgecolors* is not "none", then the default *antialiaseds* is taken from `rcParams['patch.antialiased']`, which defaults to *True*. Stroking the edges may be preferred if *alpha* is 1, but will cause artifacts otherwise.

See also:

pcolormesh() For an explanation of the differences between *pcolor* and *pcolormesh*.

Note: In addition to the above described arguments, this function can take a **data** keyword argument. If such a **data** argument is given, the following arguments are replaced by **data[<arg>]**:

- All positional and all keyword arguments.
-

`matplotlib.pyplot.pcolormesh(*args, **kwargs)`

Plot a quadrilateral mesh.

Call signatures:

```
pcolormesh(C)
pcolormesh(X, Y, C)
pcolormesh(C, **kwargs)
```

Create a pseudocolor plot of a 2-D array.

pcolormesh is similar to *pcolor()*, but uses a different mechanism and returns a different object; *pcolor* returns a *PolyCollection* but *pcolormesh* returns a *QuadMesh*. It is much faster, so it is almost always preferred for large arrays.

C may be a masked array, but *X* and *Y* may not. Masked array support is implemented via *cmap* and *norm*; in contrast, *pcolor()* simply does not draw quadrilaterals with masked colors or vertices.

Keyword arguments:

cmap: [*None* | **Colormap**] A *matplotlib.colors.Colormap* instance. If *None*, use rc settings.

norm: [*None* | **Normalize**] A *matplotlib.colors.Normalize* instance is used to scale luminance data to 0,1. If *None*, defaults to *normalize()*.

vmin/vmax: [*None* | **scalar**] *vmin* and *vmax* are used in conjunction with *norm* to normalize luminance data. If either is *None*, it is autoscaled to the respective min or max of the color array *C*. If not *None*, *vmin* or *vmax* passed in here override any pre-existing values supplied in the *norm* instance.

shading: [**'flat'** | **'gouraud'**] **'flat'** indicates a solid color for each quad. When **'gouraud'**, each quad will be Gouraud shaded. When gouraud shading, *edgecolors* is ignored.

edgecolors: [*None* | **'None'** | **'face'** | **color** |
color sequence]

If *None*, the rc setting is used by default.

If **'None'**, edges will not be visible.

If **'face'**, edges will have the same color as the faces.

An mpl color or sequence of colors will set the edge color

alpha: 0 <= **scalar** <= 1 or *None* the alpha blending value

Return value is a `matplotlib.collections.QuadMesh` object.

kwargs can be used to control the `matplotlib.collections.QuadMesh` properties:

Property	Description
<code>agg_filter</code>	unknown
<code>alpha</code>	float or None
<code>animated</code>	[True False]
<code>antialiased</code> or <code>antialiaseds</code>	Boolean or sequence of booleans
<code>array</code>	unknown
<code>axes</code>	an <code>Axes</code> instance
<code>clim</code>	a length 2 sequence of floats
<code>clip_box</code>	a <code>matplotlib.transforms.Bbox</code> instance
<code>clip_on</code>	[True False]
<code>clip_path</code>	[(<code>Path</code> , <code>Transform</code>) <code>Patch</code> None]
<code>cmap</code>	a colormap or registered colormap name
<code>color</code>	matplotlib color arg or sequence of rgba tuples
<code>contains</code>	a callable function
<code>edgecolor</code> or <code>edgecolors</code>	matplotlib color spec or sequence of specs
<code>facecolor</code> or <code>facecolors</code>	matplotlib color spec or sequence of specs
<code>figure</code>	a <code>matplotlib.figure.Figure</code> instance
<code>gid</code>	an id string
<code>hatch</code>	['/' '\' ' ' '-' '+' 'x' 'o' 'O' '.' '*']
<code>label</code>	string or anything printable with '%s' conversion.
<code>linestyle</code> or <code>dashes</code> or <code>linestyles</code>	['solid' 'dashed', 'dashdot', 'dotted' (offset, on-off-dash-seq) '-' '--' '-.' ...]
<code>linewidth</code> or <code>linewidths</code> or <code>lw</code>	float or sequence of floats
<code>norm</code>	unknown
<code>offset_position</code>	unknown
<code>offsets</code>	float or sequence of floats
<code>path_effects</code>	unknown
<code>picker</code>	[None float boolean callable]
<code>pickradius</code>	unknown
<code>rasterized</code>	[True False None]
<code>sketch_params</code>	unknown
<code>snap</code>	unknown
<code>transform</code>	<code>Transform</code> instance
<code>url</code>	a url string
<code>urls</code>	unknown
<code>visible</code>	[True False]
<code>zorder</code>	any number

See also:

`pcolor()` For an explanation of the grid orientation (*Grid Orientation*) and the expansion of 1-D *X* and/or *Y* to 2-D arrays.

Note: In addition to the above described arguments, this function can take a **data** keyword argument. If such a **data** argument is given, the following arguments are replaced by **data[<arg>]**:

- All positional and all keyword arguments.
-

`matplotlib.pyplot.phase_spectrum(x, Fs=None, Fc=None, window=None, pad_to=None, sides=None, hold=None, data=None, **kwargs)`

Plot the phase spectrum.

Call signature:

```
phase_spectrum(x, Fs=2, Fc=0, window=mlab.window_hanning,
               pad_to=None, sides='default', **kwargs)
```

Compute the phase spectrum (unwrapped angle spectrum) of x . Data is padded to a length of pad_to and the windowing function $window$ is applied to the signal.

Parameters x : 1-D array or sequence

Array or sequence containing the data

Fs : scalar

The sampling frequency (samples per time unit). It is used to calculate the Fourier frequencies, $freqs$, in cycles per time unit. The default value is 2.

window : callable or ndarray

A function or a vector of length $NFFT$. To create window vectors see `window_hanning()`, `window_none()`, `numpy.blackman()`, `numpy.hamming()`, `numpy.bartlett()`, `scipy.signal()`, `scipy.signal.get_window()`, etc. The default is `window_hanning()`. If a function is passed as the argument, it must take a data segment as an argument and return the windowed version of the segment.

sides : ['default' | 'onesided' | 'twosided']

Specifies which sides of the spectrum to return. Default gives the default behavior, which returns one-sided for real data and both for complex data. 'onesided' forces the return of a one-sided spectrum, while 'twosided' forces two-sided.

pad_to : integer

The number of points to which the data segment is padded when performing the FFT. While not increasing the actual resolution of the spectrum (the minimum distance between resolvable peaks), this can give more points in the plot, allowing for more detail. This corresponds to the n parameter in the call to `fft()`. The default is `None`, which sets pad_to equal to the length of the input signal (i.e. no padding).

Fc : integer

The center frequency of x (defaults to 0), which offsets the x extents of the plot to reflect the frequency range used when a signal is acquired and then filtered and downsampled to baseband.

****kwargs :**

Keyword arguments control the *Line2D* properties:

Property	Description
<i>agg_filter</i>	unknown
<i>alpha</i>	float (0.0 transparent through 1.0 opaque)
<i>animated</i>	[True False]
<i>antialiased</i> or <i>aa</i>	[True False]
<i>axes</i>	an <i>Axes</i> instance
<i>clip_box</i>	a <i>matplotlib.transforms.Bbox</i> instance
<i>clip_on</i>	[True False]
<i>clip_path</i>	[(<i>Path</i> , <i>Transform</i>) <i>Patch</i> None]
<i>color</i> or <i>c</i>	any matplotlib color
<i>contains</i>	a callable function
<i>dash_capstyle</i>	['butt' 'round' 'projecting']
<i>dash_joinstyle</i>	['miter' 'round' 'bevel']
<i>dashes</i>	sequence of on/off ink in points
<i>drawstyle</i>	['default' 'steps' 'steps-pre' 'steps-mid' 'steps-post']
<i>figure</i>	a <i>matplotlib.figure.Figure</i> instance
<i>fillstyle</i>	['full' 'left' 'right' 'bottom' 'top' 'none']
<i>gid</i>	an id string
<i>label</i>	string or anything printable with '%s' conversion.
<i>linestyle</i> or <i>ls</i>	['solid' 'dashed', 'dashdot', 'dotted' (offset, on-off-dash-seq) '-' '--' '-.' ' ']
<i>linewidth</i> or <i>lw</i>	float value in points
<i>marker</i>	<i>A valid marker style</i>
<i>markeredgecolor</i> or <i>mec</i>	any matplotlib color
<i>markeredgewidth</i> or <i>mew</i>	float value in points
<i>markerfacecolor</i> or <i>mfc</i>	any matplotlib color
<i>markerfacecoloralt</i> or <i>mfcalt</i>	any matplotlib color
<i>markersize</i> or <i>ms</i>	float
<i>markevery</i>	[None int length-2 tuple of int slice list/array of int float length-2 tuple of float]
<i>path_effects</i>	unknown
<i>picker</i>	float distance in points or callable pick function <code>fn(artist, event)</code>
<i>pickradius</i>	float distance in points
<i>rasterized</i>	[True False None]
<i>sketch_params</i>	unknown
<i>snap</i>	unknown
<i>solid_capstyle</i>	['butt' 'round' 'projecting']
<i>solid_joinstyle</i>	['miter' 'round' 'bevel']
<i>transform</i>	a <i>matplotlib.transforms.Transform</i> instance
<i>url</i>	a url string
<i>visible</i>	[True False]

Table 45.23 – continued from previous page

Property	Description
<i>xdata</i>	1D array
<i>ydata</i>	1D array
<i>zorder</i>	any number

Returns spectrum : 1-D array

The values for the phase spectrum in radians (real valued)

freqs : 1-D array

The frequencies corresponding to the elements in *spectrum*

line : a *Line2D* instance

The line created by this function

See also:

magnitude_spectrum() *magnitude_spectrum()* plots the magnitudes of the corresponding frequencies.

angle_spectrum() *angle_spectrum()* plots the wrapped version of this function.

specgram() *specgram()* can plot the phase spectrum of segments within the signal in a colormap.

In addition to the above described arguments, this function can take a **data** keyword argument. If such a **data** argument is given, the following arguments are replaced by **data[<arg>]**: * All arguments with the following names: 'x'.

Examples

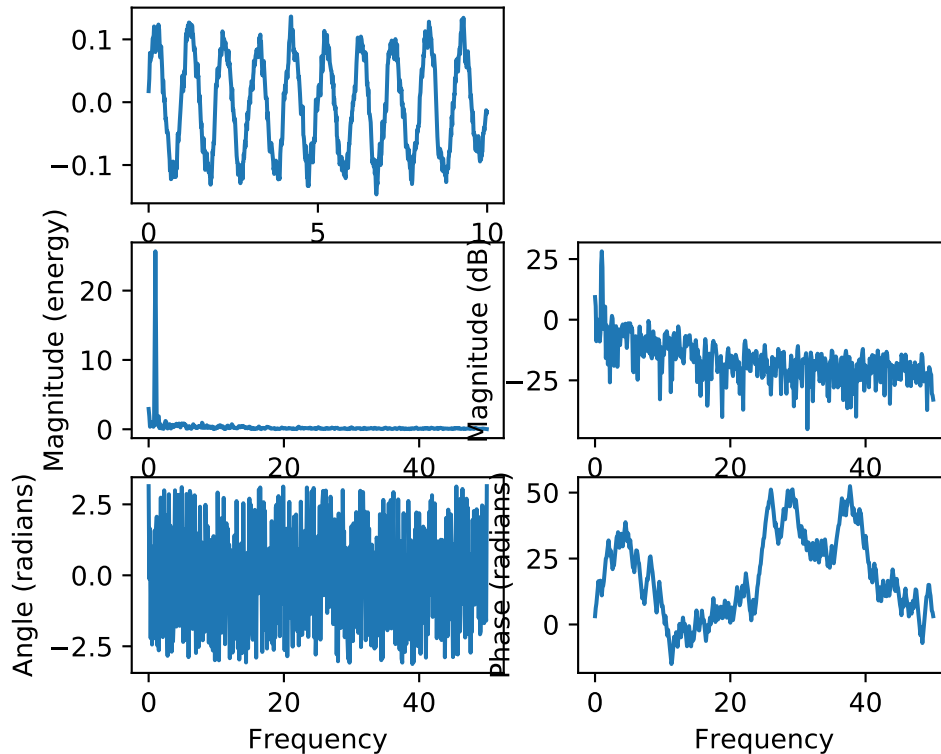

`matplotlib.pyplot.pie(x, explode=None, labels=None, colors=None, autopct=None, pctdistance=0.6, shadow=False, labeldistance=1.1, startangle=None, radius=None, counterclock=True, wedgeprops=None, textprops=None, center=(0, 0), frame=False, hold=None, data=None)`

Plot a pie chart.

Make a pie chart of array x . The fractional area of each wedge is given by $x/\text{sum}(x)$. If $\text{sum}(x) \leq 1$, then the values of x give the fractional area directly and the array will not be normalized. The wedges are plotted counterclockwise, by default starting from the x -axis.

Parameters x : array-like

The input array used to make the pie chart.

explode : array-like, optional, default: None

If not *None*, is a $\text{len}(x)$ array which specifies the fraction of the radius with which to offset each wedge.

labels : list, optional, default: None

A sequence of strings providing the labels for each wedge

colors : array-like, optional, default: None

A sequence of matplotlib color args through which the pie chart will cycle. If *None*, will use the colors in the currently active cycle.

autopct : *None* (default), string, or function, optional

If not *None*, is a string or function used to label the wedges with their numeric value. The label will be placed inside the wedge. If it is a format string, the label will be `fmt%pct`. If it is a function, it will be called.

pctdistance : float, optional, default: 0.6

The ratio between the center of each pie slice and the start of the text generated by *autopct*. Ignored if *autopct* is *None*.

shadow : bool, optional, default: False

Draw a shadow beneath the pie.

labeldistance : float, optional, default: 1.1

The radial distance at which the pie labels are drawn

startangle : float, optional, default: *None*

If not *None*, rotates the start of the pie chart by *angle* degrees counterclockwise from the x-axis.

radius : float, optional, default: *None*

The radius of the pie, if *radius* is *None* it will be set to 1.

counterclock : bool, optional, default: True

Specify fractions direction, clockwise or counterclockwise.

wedgeprops : dict, optional, default: *None*

Dict of arguments passed to the wedge objects making the pie. For example, you can pass in `wedgeprops = {'linewidth': 3}` to set the width of the wedge border lines equal to 3. For more details, look at the doc/arguments of the wedge object. By default `clip_on=False`.

textprops : dict, optional, default: *None*

Dict of arguments to pass to the text objects.

center : list of float, optional, default: (0, 0)

Center position of the chart. Takes value (0, 0) or is a sequence of 2 scalars.

frame : bool, optional, default: False

Plot axes frame with the chart if true.

Returns patches : list

A sequence of `matplotlib.patches.Wedge` instances

texts : list

A is a list of the label `matplotlib.text.Text` instances.

autotexts : list

A is a list of *Text* instances for the numeric labels. Is returned only if parameter *autopct* is not *None*.

Notes

The pie chart will probably look best if the figure and axes are square, or the Axes aspect is equal.

Examples

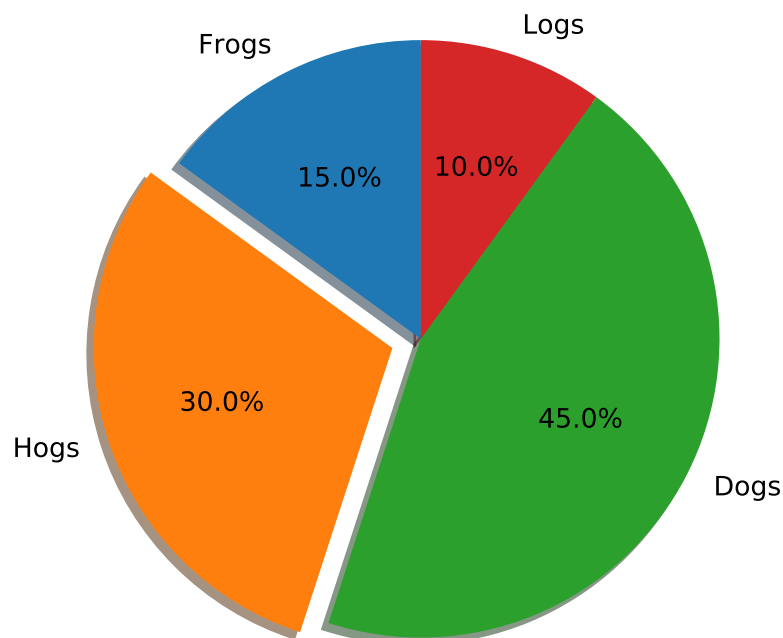

Note: In addition to the above described arguments, this function can take a **data** keyword argument. If such a **data** argument is given, the following arguments are replaced by **data[<arg>]**:

- All arguments with the following names: 'colors', 'explode', 'labels', 'x'.
-

`matplotlib.pyplot.pink()`

set the default colormap to pink and apply to current image if any. See `help(colormaps)` for more information

`matplotlib.pyplot.plasma()`

set the default colormap to plasma and apply to current image if any. See `help(colormaps)` for more information

`matplotlib.pyplot.plot(*args, **kwargs)`

Plot lines and/or markers to the *Axes*. *args* is a variable length argument, allowing for multiple *x*, *y* pairs with an optional format string. For example, each of the following is legal:

```
plot(x, y)           # plot x and y using default line style and color
plot(x, y, 'bo')     # plot x and y using blue circle markers
plot(y)             # plot y using x as index array 0..N-1
plot(y, 'r+')       # ditto, but with red plusses
```

If *x* and/or *y* is 2-dimensional, then the corresponding columns will be plotted.

If used with labeled data, make sure that the color spec is not included as an element in data, as otherwise the last case `plot("v", "r", data={"v":..., "r":...})` can be interpreted as the first case which would do `plot(v, r)` using the default line style and color.

If not used with labeled data (i.e., without a data argument), an arbitrary number of *x*, *y*, *fmt* groups can be specified, as in:

```
a.plot(x1, y1, 'g^', x2, y2, 'g-')
```

Return value is a list of lines that were added.

By default, each line is assigned a different style specified by a 'style cycle'. To change this behavior, you can edit the `axes.prop_cycle` rcParam.

The following format string characters are accepted to control the line style or marker:

character	description
' - '	solid line style
' -- '	dashed line style
' - . '	dash-dot line style
' : '	dotted line style
' . '	point marker
' , '	pixel marker
' o '	circle marker
' v '	triangle_down marker
' ^ '	triangle_up marker
' < '	triangle_left marker
' > '	triangle_right marker
' 1 '	tri_down marker
' 2 '	tri_up marker
' 3 '	tri_left marker
' 4 '	tri_right marker
' s '	square marker
' p '	pentagon marker
' * '	star marker
' h '	hexagon1 marker
' H '	hexagon2 marker
' + '	plus marker
' x '	x marker
' D '	diamond marker
' d '	thin_diamond marker
' '	vline marker
' _ '	hline marker

The following color abbreviations are supported:

character	color
' b '	blue
' g '	green
' r '	red
' c '	cyan
' m '	magenta
' y '	yellow
' k '	black
' w '	white

In addition, you can specify colors in many weird and wonderful ways, including full names ('green'), hex strings ('#008000'), RGB or RGBA tuples ((0, 1, 0, 1)) or grayscale intensities as a string ('0.8'). Of these, the string specifications can be used in place of a `fmt` group, but the tuple forms can be used only as `kwargs`.

Line styles and colors are combined in a single format string, as in 'bo' for blue circles.

The `kwargs` can be used to set line properties (any property that has a `set_*` method). You can use this to set a line label (for auto legends), linewidth, antialiasing, marker face color, etc. Here is an

example:

```
plot([1,2,3], [1,2,3], 'go-', label='line 1', linewidth=2)
plot([1,2,3], [1,4,9], 'rs', label='line 2')
axis([0, 4, 0, 10])
legend()
```

If you make multiple lines with one plot command, the kwargs apply to all those lines, e.g.:

```
plot(x1, y1, x2, y2, antialiased=False)
```

Neither line will be antialiased.

You do not need to use format strings, which are just abbreviations. All of the line properties can be controlled by keyword arguments. For example, you can set the color, marker, linestyle, and markercolor with:

```
plot(x, y, color='green', linestyle='dashed', marker='o',
     markerfacecolor='blue', markersize=12).
```

See [Line2D](#) for details.

The kwargs are [Line2D](#) properties:

Property	Description
<i>agg_filter</i>	unknown
<i>alpha</i>	float (0.0 transparent through 1.0 opaque)
<i>animated</i>	[True False]
<i>antialiased</i> or <i>aa</i>	[True False]
<i>axes</i>	an <i>Axes</i> instance
<i>clip_box</i>	a <i>matplotlib.transforms.Bbox</i> instance
<i>clip_on</i>	[True False]
<i>clip_path</i>	[(<i>Path</i> , <i>Transform</i>) <i>Patch</i> None]
<i>color</i> or <i>c</i>	any matplotlib color
<i>contains</i>	a callable function
<i>dash_capstyle</i>	['butt' 'round' 'projecting']
<i>dash_joinstyle</i>	['miter' 'round' 'bevel']
<i>dashes</i>	sequence of on/off ink in points
<i>drawstyle</i>	['default' 'steps' 'steps-pre' 'steps-mid' 'steps-post']
<i>figure</i>	a <i>matplotlib.figure.Figure</i> instance
<i>fillstyle</i>	['full' 'left' 'right' 'bottom' 'top' 'none']
<i>gid</i>	an id string
<i>label</i>	string or anything printable with '%s' conversion.
<i>linestyle</i> or <i>ls</i>	['solid' 'dashed', 'dashdot', 'dotted' (offset, on-off-dash-seq) '-' '--' '-.' ' ']
<i>linewidth</i> or <i>lw</i>	float value in points
<i>marker</i>	<i>A valid marker style</i>
<i>markeredgecolor</i> or <i>mec</i>	any matplotlib color
<i>markeredgewidth</i> or <i>mew</i>	float value in points

Table 45.24 – continued from previous page

Property	Description
<code>markerfacecolor</code> or <code>mfc</code>	any matplotlib color
<code>markerfacecoloralt</code> or <code>mfcalt</code>	any matplotlib color
<code>markersize</code> or <code>ms</code>	float
<code>markevery</code>	[None int length-2 tuple of int slice list/array of int float length-2 tuple of float]
<code>path_effects</code>	unknown
<code>picker</code>	float distance in points or callable pick function <code>fn(artist, event)</code>
<code>pickradius</code>	float distance in points
<code>rasterized</code>	[True False None]
<code>sketch_params</code>	unknown
<code>snap</code>	unknown
<code>solid_capstyle</code>	['butt' 'round' 'projecting']
<code>solid_joinstyle</code>	['miter' 'round' 'bevel']
<code>transform</code>	a <code>matplotlib.transforms.Transform</code> instance
<code>url</code>	a url string
<code>visible</code>	[True False]
<code>xdata</code>	1D array
<code>ydata</code>	1D array
<code>zorder</code>	any number

kwargs `scalex` and `scaley`, if defined, are passed on to `autoscale_view()` to determine whether the *x* and *y* axes are autoscaled; the default is `True`.

Note: In addition to the above described arguments, this function can take a **data** keyword argument. If such a **data** argument is given, the following arguments are replaced by **data[<arg>]**:

- All arguments with the following names: 'x', 'y'.

`matplotlib.pyplot.plot_date(x, y, fmt='o', tz=None, xdate=True, ydate=False, hold=None, data=None, **kwargs)`

A plot with data that contains dates.

Similar to the `plot()` command, except the *x* or *y* (or both) data is considered to be dates, and the axis is labeled accordingly.

x and/or *y* can be a sequence of dates represented as float days since 0001-01-01 UTC.

Note if you are using custom date tickers and formatters, it may be necessary to set the formatters/locators after the call to `meth:plot_date` since `meth:plot_date` will set the default tick locator to class:`matplotlib.dates.AutoDateLocator` (if the tick locator is not already set to a class:`matplotlib.dates.DateLocator` instance) and the default tick formatter to class:`matplotlib.dates.AutoDateFormatter` (if the tick formatter is not already set to a class:`matplotlib.dates.DateFormatter` instance).

Parameters `fmt` : string

The plot format string.

tz : [*None* | timezone string | *tzinfo* instance]

The time zone to use in labeling dates. If *None*, defaults to rc value.

xdate : boolean

If *True*, the *x*-axis will be labeled with dates.

ydate : boolean

If *True*, the *y*-axis will be labeled with dates.

Returns lines

Other Parameters kwargs : *matplotlib.lines.Line2D*

properties :

Property	Description
<i>agg_filter</i>	unknown
<i>alpha</i>	float (0.0 transparent through 1.0 opaque)
<i>animated</i>	[True False]
<i>antialiased</i> or <i>aa</i>	[True False]
<i>axes</i>	an <i>Axes</i> instance
<i>clip_box</i>	a <i>matplotlib.transforms.Bbox</i> instance
<i>clip_on</i>	[True False]
<i>clip_path</i>	[(<i>Path</i> , <i>Transform</i>) <i>Patch</i> None]
<i>color</i> or <i>c</i>	any matplotlib color
<i>contains</i>	a callable function
<i>dash_capstyle</i>	['butt' 'round' 'projecting']
<i>dash_joinstyle</i>	['miter' 'round' 'bevel']
<i>dashes</i>	sequence of on/off ink in points
<i>drawstyle</i>	['default' 'steps' 'steps-pre' 'steps-mid' 'steps-post']
<i>figure</i>	a <i>matplotlib.figure.Figure</i> instance
<i>fillstyle</i>	['full' 'left' 'right' 'bottom' 'top' 'none']
<i>gid</i>	an id string
<i>label</i>	string or anything printable with '%s' conversion.
<i>linestyle</i> or <i>ls</i>	['solid' 'dashed', 'dashdot', 'dotted' (offset, on-off-dash-seq) '- ' '-- ' '-. ' ' ']
<i>linewidth</i> or <i>lw</i>	float value in points
<i>marker</i>	<i>A valid marker style</i>
<i>markeredgecolor</i> or <i>mec</i>	any matplotlib color
<i>markeredgewidth</i> or <i>mew</i>	float value in points
<i>markerfacecolor</i> or <i>mfc</i>	any matplotlib color
<i>markerfacecoloralt</i> or <i>mfcalt</i>	any matplotlib color
<i>markersize</i> or <i>ms</i>	float
<i>markevery</i>	[None int length-2 tuple of int slice list/array of int float length-2 tuple of float]
<i>path_effects</i>	unknown
<i>picker</i>	float distance in points or callable pick function <i>fn(artist, event)</i>

Table 45.25 – continued from previous page

Property	Description
<i>pickradius</i>	float distance in points
<i>rasterized</i>	[True False None]
<i>sketch_params</i>	unknown
<i>snap</i>	unknown
<i>solid_capstyle</i>	['butt' 'round' 'projecting']
<i>solid_joinstyle</i>	['miter' 'round' 'bevel']
<i>transform</i>	a <i>matplotlib.transforms.Transform</i> instance
<i>url</i>	a url string
<i>visible</i>	[True False]
<i>xdata</i>	1D array
<i>ydata</i>	1D array
<i>zorder</i>	any number

.. note::

In addition to the above described arguments, this function can take a **data** keyword argument. If such a **data** argument is given, the following arguments are replaced by **data[<arg>]**:

- All arguments with the following names: 'x', 'y'.

See also:

matplotlib.dates helper functions on dates

matplotlib.dates.date2num how to convert dates to num

matplotlib.dates.num2date how to convert num to dates

matplotlib.dates.drange how floating point dates

`matplotlib.pyplot.plotfile`(*fname*, *cols*=(0,), *plotfuncs*=None, *comments*='#', *skiprows*=0, *checkrows*=5, *delimiter*=', ', *names*=None, *subplots*=True, *newfig*=True, ***kwargs*)

Plot the data in in a file.

cols is a sequence of column identifiers to plot. An identifier is either an int or a string. If it is an int, it indicates the column number. If it is a string, it indicates the column header. `matplotlib` will make column headers lower case, replace spaces with underscores, and remove all illegal characters; so 'Adj Close*' will have name 'adj_close'.

- If `len(cols) == 1`, only that column will be plotted on the y axis.
- If `len(cols) > 1`, the first element will be an identifier for data for the x axis and the remaining elements will be the column indexes for multiple subplots if *subplots* is *True* (the default), or for lines in a single subplot if *subplots* is *False*.

plotfuncs, if not *None*, is a dictionary mapping identifier to an *Axes* plotting function as a string. Default is 'plot', other choices are 'semilogy', 'fill', 'bar', etc. You must use the same type of identifier in the *cols* vector as you use in the *plotfuncs* dictionary, e.g., integer column numbers in both or column names in both. If *subplots* is *False*, then including any function such as 'semilogy' that changes the axis scaling will set the scaling for all columns.

comments, *skiprows*, *checkrows*, *delimiter*, and *names* are all passed on to `matplotlib.pyplot.csv2rec()` to load the data into a record array.

If *newfig* is *True*, the plot always will be made in a new figure; if *False*, it will be made in the current figure if one exists, else in a new figure.

kwargs are passed on to plotting functions.

Example usage:

```
# plot the 2nd and 4th column against the 1st in two subplots
plotfile(fname, (0,1,3))

# plot using column names; specify an alternate plot type for volume
plotfile(fname, ('date', 'volume', 'adj_close'),
          plotfuncs={'volume': 'semilogy'})
```

Note: `plotfile` is intended as a convenience for quickly plotting data from flat files; it is not intended as an alternative interface to general plotting with `pyplot` or `matplotlib`.

`matplotlib.pyplot.polar(*args, **kwargs)`

Make a polar plot.

call signature:

```
polar(theta, r, **kwargs)
```

Multiple *theta*, *r* arguments are supported, with format strings, as in `plot()`.

`matplotlib.pyplot.primism()`

set the default colormap to prism and apply to current image if any. See `help(colormaps)` for more information

`matplotlib.pyplot.psd(x, NFFT=None, Fs=None, Fc=None, detrend=None, window=None, noverlap=None, pad_to=None, sides=None, scale_by_freq=None, return_line=None, hold=None, data=None, **kwargs)`

Plot the power spectral density.

Call signature:

```
psd(x, NFFT=256, Fs=2, Fc=0, detrend=mlab.detrend_none,
    window=mlab.window_hanning, noverlap=0, pad_to=None,
    sides='default', scale_by_freq=None, return_line=None, **kwargs)
```

The power spectral density P_{xx} by Welch's average periodogram method. The vector x is divided into $NFFT$ length segments. Each segment is detrended by function *detrend* and windowed by function *window*. *noverlap* gives the length of the overlap between segments. The $|fft(i)|^2$ of each segment i are averaged to compute P_{xx} , with a scaling to correct for power loss due to windowing.

If $\text{len}(x) < NFFT$, it will be zero padded to $NFFT$.

Parameters x : 1-D array or sequence

Array or sequence containing the data

Fs : scalar

The sampling frequency (samples per time unit). It is used to calculate the Fourier frequencies, `freqs`, in cycles per time unit. The default value is 2.

window : callable or ndarray

A function or a vector of length $NFFT$. To create window vectors see `window_hanning()`, `window_none()`, `numpy.blackman()`, `numpy.hamming()`, `numpy.bartlett()`, `scipy.signal()`, `scipy.signal.get_window()`, etc. The default is `window_hanning()`. If a function is passed as the argument, it must take a data segment as an argument and return the windowed version of the segment.

sides : ['default' | 'onesided' | 'twosided']

Specifies which sides of the spectrum to return. Default gives the default behavior, which returns one-sided for real data and both for complex data. 'onesided' forces the return of a one-sided spectrum, while 'twosided' forces two-sided.

pad_to : integer

The number of points to which the data segment is padded when performing the FFT. This can be different from $NFFT$, which specifies the number of data points used. While not increasing the actual resolution of the spectrum (the minimum distance between resolvable peaks), this can give more points in the plot, allowing for more detail. This corresponds to the n parameter in the call to `fft()`. The default is `None`, which sets `pad_to` equal to $NFFT$

NFFT : integer

The number of data points used in each block for the FFT. A power 2 is most efficient. The default value is 256. This should *NOT* be used to get zero padding, or the scaling of the result will be incorrect. Use `pad_to` for this instead.

detrend : { 'default', 'constant', 'mean', 'linear', 'none' } or callable

The function applied to each segment before `fft`-ing, designed to remove the mean or linear trend. Unlike in MATLAB, where the `detrend` parameter is a vector, in matplotlib it is a function. The `pylab` module defines `detrend_none()`, `detrend_mean()`, and `detrend_linear()`, but you can use a custom function as well. You can also use a string to choose one of the functions. 'default', 'constant', and 'mean' call `detrend_mean()`. 'linear' calls `detrend_linear()`. 'none' calls `detrend_none()`.

scale_by_freq : boolean, optional

Specifies whether the resulting density values should be scaled by the scaling frequency, which gives density in units of Hz⁻¹. This allows for integration over the returned frequency values. The default is True for MATLAB compatibility.

noverlap : integer

The number of points of overlap between segments. The default value is 0 (no overlap).

Fc : integer

The center frequency of x (defaults to 0), which offsets the x extents of the plot to reflect the frequency range used when a signal is acquired and then filtered and downsampled to baseband.

return_line : bool

Whether to include the line object plotted in the returned values. Default is False.

****kwargs** :

Keyword arguments control the *Line2D* properties:

Property	Description
<i>agg_filter</i>	unknown
<i>alpha</i>	float (0.0 transparent through 1.0 opaque)
<i>animated</i>	[True False]
<i>antialiased</i> or <i>aa</i>	[True False]
<i>axes</i>	an <i>Axes</i> instance
<i>clip_box</i>	a <i>matplotlib.transforms.Bbox</i> instance
<i>clip_on</i>	[True False]
<i>clip_path</i>	[(<i>Path</i> , <i>Transform</i>) <i>Patch</i> None]
<i>color</i> or <i>c</i>	any matplotlib color
<i>contains</i>	a callable function
<i>dash_capstyle</i>	['butt' 'round' 'projecting']
<i>dash_joinstyle</i>	['miter' 'round' 'bevel']
<i>dashes</i>	sequence of on/off ink in points
<i>drawstyle</i>	['default' 'steps' 'steps-pre' 'steps-mid' 'steps-post']
<i>figure</i>	a <i>matplotlib.figure.Figure</i> instance
<i>fillstyle</i>	['full' 'left' 'right' 'bottom' 'top' 'none']
<i>gid</i>	an id string
<i>label</i>	string or anything printable with '%s' conversion.
<i>linestyle</i> or <i>ls</i>	['solid' 'dashed', 'dashdot', 'dotted' (offset, on-off-dash-seq) '-' '--' '-.' ' ']
<i>linewidth</i> or <i>lw</i>	float value in points
<i>marker</i>	<i>A valid marker style</i>
<i>markeredgecolor</i> or <i>mec</i>	any matplotlib color
<i>markeredgewidth</i> or <i>mew</i>	float value in points
<i>markerfacecolor</i> or <i>mfc</i>	any matplotlib color

Table 45.26 – continued from previous page

Property	Description
<i>markerfacecoloralt</i> or <i>mfcalt</i>	any matplotlib color
<i>markersize</i> or <i>ms</i>	float
<i>markevery</i>	[None int length-2 tuple of int slice list/array of int float length-2 tuple of float]
<i>path_effects</i>	unknown
<i>picker</i>	float distance in points or callable pick function <code>fn(artist, event)</code>
<i>pickradius</i>	float distance in points
<i>rasterized</i>	[True False None]
<i>sketch_params</i>	unknown
<i>snap</i>	unknown
<i>solid_capstyle</i>	['butt' 'round' 'projecting']
<i>solid_joinstyle</i>	['miter' 'round' 'bevel']
<i>transform</i>	a <code>matplotlib.transforms.Transform</code> instance
<i>url</i>	a url string
<i>visible</i>	[True False]
<i>xdata</i>	1D array
<i>ydata</i>	1D array
<i>zorder</i>	any number

Returns P_{xx} : 1-D array

The values for the power spectrum $P_{\{xx\}}$ before scaling (real valued)

freqs : 1-D array

The frequencies corresponding to the elements in P_{xx}

line : a `Line2D` instance

The line created by this function. Only returned if `return_line` is True.

See also:

`specgram()` `specgram()` differs in the default overlap; in not returning the mean of the segment periodograms; in returning the times of the segments; and in plotting a colormap instead of a line.

`magnitude_spectrum()` `magnitude_spectrum()` plots the magnitude spectrum.

`csd()` `csd()` plots the spectral density between two signals.

In addition to the above described arguments, this function can take a **data** keyword argument. If such a **data** argument is given, the following arguments are replaced by **data[<arg>]**: * All arguments with the following names: 'x'.

Notes

For plotting, the power is plotted as $10 \log_{10}(P_{xx})$ for decibels, though P_{xx} itself is returned.

References

Bendat & Piersol – Random Data: Analysis and Measurement Procedures, John Wiley & Sons (1986)

Examples

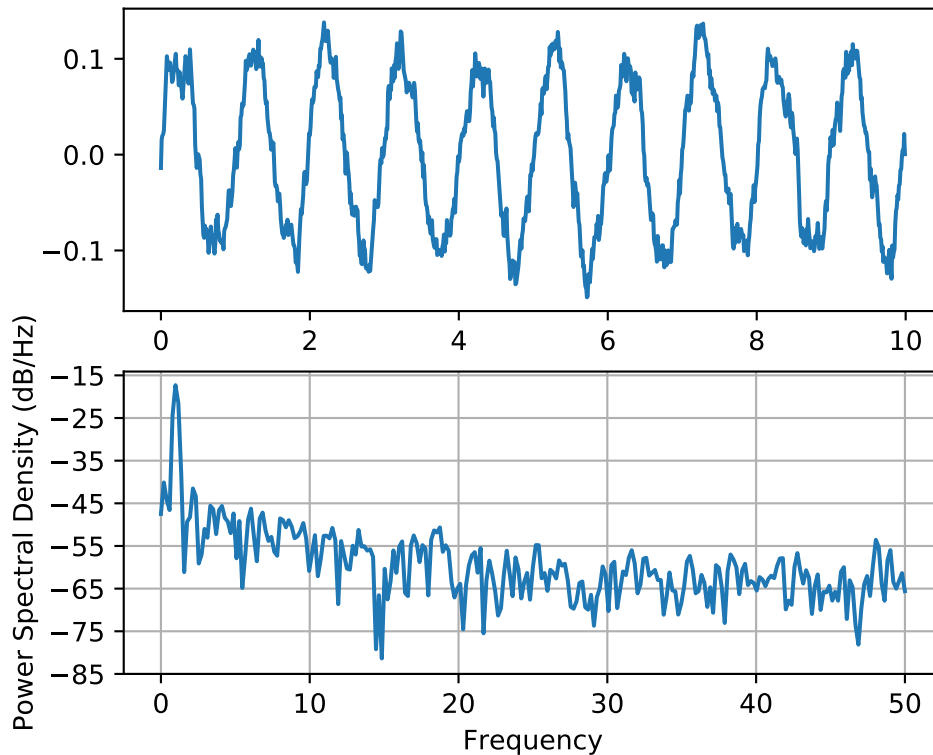

`matplotlib.pyplot.quiver(*args, **kw)`

Plot a 2-D field of arrows.

Call signatures:

```
quiver(U, V, **kw)
quiver(U, V, C, **kw)
quiver(X, Y, U, V, **kw)
quiver(X, Y, U, V, C, **kw)
```

U and V are the arrow data, X and Y set the location of the arrows, and C sets the color of the arrows. These arguments may be 1-D or 2-D arrays or sequences.

If X and Y are absent, they will be generated as a uniform grid. If U and V are 2-D arrays and X and Y are 1-D, and if $\text{len}(X)$ and $\text{len}(Y)$ match the column and row dimensions of U , then X and Y will be expanded with `numpy.meshgrid()`.

The default settings auto-scales the length of the arrows to a reasonable size. To change this behavior see the *scale* and *scale_units* kwargs.

The defaults give a slightly swept-back arrow; to make the head a triangle, make *headaxislength* the same as *headlength*. To make the arrow more pointed, reduce *headwidth* or increase *headlength* and *headaxislength*. To make the head smaller relative to the shaft, scale down all the head parameters. You will probably do best to leave *minshaft* alone.

linewidths and *edgecolors* can be used to customize the arrow outlines.

Parameters X : 1D or 2D array, sequence, optional

The x coordinates of the arrow locations

Y : 1D or 2D array, sequence, optional

The y coordinates of the arrow locations

U : 1D or 2D array or masked array, sequence

The x components of the arrow vectors

V : 1D or 2D array or masked array, sequence

The y components of the arrow vectors

C : 1D or 2D array, sequence, optional

The arrow colors

units : ['width' | 'height' | 'dots' | 'inches' | 'x' | 'y' | 'xy']

The arrow dimensions (except for *length*) are measured in multiples of this unit.

'width' or 'height': the width or height of the axis

'dots' or 'inches': pixels or inches, based on the figure dpi

'x', 'y', or 'xy': respectively X, Y, or $\sqrt{X^2 + Y^2}$ in data units

The arrows scale differently depending on the units. For 'x' or 'y', the arrows get larger as one zooms in; for other units, the arrow size is independent of the zoom state. For 'width' or 'height', the arrow size increases with the width and height of the axes, respectively, when the window is resized; for 'dots' or 'inches', resizing does not change the arrows.

angles : ['uv' | 'xy'], array, optional

Method for determining the angle of the arrows. Default is 'uv'.

'uv': the arrow axis aspect ratio is 1 so that if $U == V$ the orientation of the arrow on the plot is 45 degrees counter-clockwise from the horizontal axis (positive to the right).

'xy': arrows point from (x,y) to (x+u, y+v). Use this for plotting a gradient field, for example.

Alternatively, arbitrary angles may be specified as an array of values in degrees, counter-clockwise from the horizontal axis.

Note: inverting a data axis will correspondingly invert the arrows only with `angles='xy'`.

scale : None, float, optional

Number of data units per arrow length unit, e.g., m/s per plot width; a smaller scale parameter makes the arrow longer. Default is *None*.

If *None*, a simple autoscaling algorithm is used, based on the average vector length and the number of vectors. The arrow length unit is given by the `scale_units` parameter

scale_units : ['width' | 'height' | 'dots' | 'inches' | 'x' | 'y' | 'xy'], None, optional

If the `scale` kwarg is *None*, the arrow length unit. Default is *None*.

e.g. `scale_units` is 'inches', `scale` is 2.0, and $(u, v) = (1, 0)$, then the vector will be 0.5 inches long.

If `scale_units` is 'width'/'height', then the vector will be half the width/height of the axes.

If `scale_units` is 'x' then the vector will be 0.5 x-axis units. To plot vectors in the x-y plane, with `u` and `v` having the same units as `x` and `y`, use `angles='xy'`, `scale_units='xy'`, `scale=1`.

width : scalar, optional

Shaft width in arrow units; default depends on choice of units, above, and number of vectors; a typical starting value is about 0.005 times the width of the plot.

headwidth : scalar, optional

Head width as multiple of shaft width, default is 3

headlength : scalar, optional

Head length as multiple of shaft width, default is 5

headaxislength : scalar, optional

Head length at shaft intersection, default is 4.5

minshaft : scalar, optional

Length below which arrow scales, in units of head length. Do not set this to less than 1, or small arrows will look terrible! Default is 1

minlength : scalar, optional

Minimum length as a multiple of shaft width; if an arrow length is less than this, plot a dot (hexagon) of this diameter instead. Default is 1.

pivot : ['tail' | 'mid' | 'middle' | 'tip'], optional

The part of the arrow that is at the grid point; the arrow rotates about this point, hence the name *pivot*.

color : [color | color sequence], optional

This is a synonym for the *PolyCollection* `facecolor` kwarg. If *C* has been set, *color* has no effect.

See also:

quiverkey Add a key to a quiver plot

Notes

Additional *PolyCollection* keyword arguments:

Property	Description
<i>agg_filter</i>	unknown
<i>alpha</i>	float or None
<i>animated</i>	[True False]
<i>antialiased</i> or <i>antialiaseds</i>	Boolean or sequence of booleans
<i>array</i>	unknown
<i>axes</i>	an <i>Axes</i> instance
<i>clim</i>	a length 2 sequence of floats
<i>clip_box</i>	a <i>matplotlib.transforms.Bbox</i> instance
<i>clip_on</i>	[True False]
<i>clip_path</i>	[(<i>Path</i> , <i>Transform</i>) <i>Patch</i> None]
<i>cmap</i>	a colormap or registered colormap name
<i>color</i>	matplotlib color arg or sequence of rgba tuples
<i>contains</i>	a callable function
<i>edgecolor</i> or <i>edgecolors</i>	matplotlib color spec or sequence of specs
<i>facecolor</i> or <i>facecolors</i>	matplotlib color spec or sequence of specs
<i>figure</i>	a <i>matplotlib.figure.Figure</i> instance
<i>gid</i>	an id string
<i>hatch</i>	['/' '\' ' ' '-' '+' 'x' 'o' 'O' '.' '*']
<i>label</i>	string or anything printable with '%s' conversion.
<i>linestyle</i> or <i>dashes</i> or <i>linestyles</i>	['solid' 'dashed', 'dashdot', 'dotted' (offset, on-off-dash-seq) '-' '--' '-. ']
<i>linewidth</i> or <i>linewidths</i> or <i>lw</i>	float or sequence of floats
<i>norm</i>	unknown
<i>offset_position</i>	unknown
<i>offsets</i>	float or sequence of floats
<i>path_effects</i>	unknown
<i>picker</i>	[None float boolean callable]
<i>pickradius</i>	unknown
<i>rasterized</i>	[True False None]
<i>sketch_params</i>	unknown

Table 45.27 – continued from previous page

Property	Description
<i>snap</i>	unknown
<i>transform</i>	<i>Transform</i> instance
<i>url</i>	a url string
<i>urls</i>	unknown
<i>visible</i>	[True False]
<i>zorder</i>	any number

Examples

→ Quiver key, length = 10

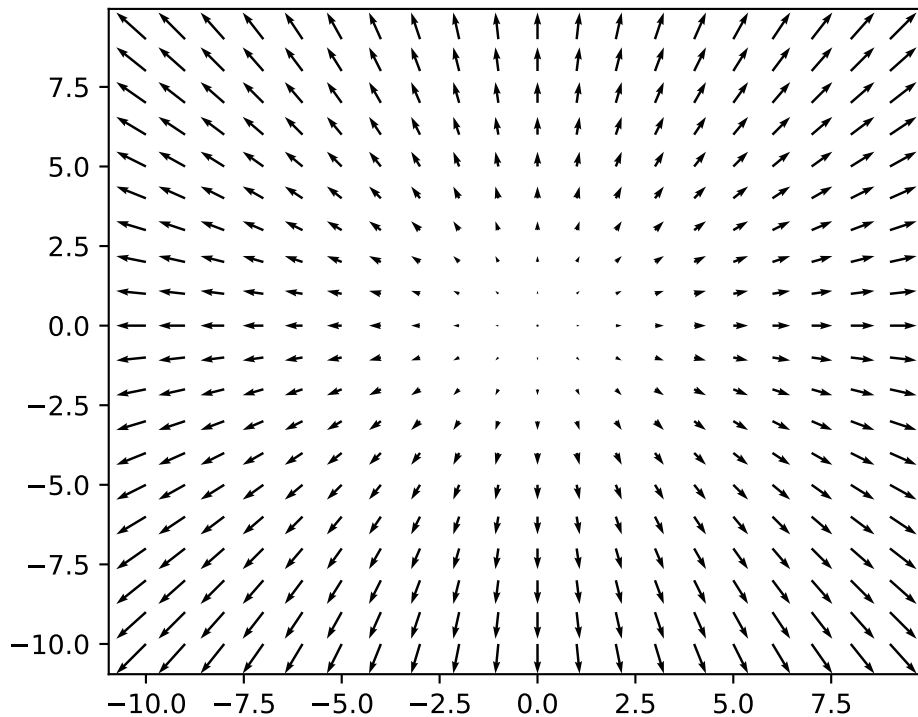

`matplotlib.pyplot.quiverkey(*args, **kw)`

Add a key to a quiver plot.

Call signature:

```
quiverkey(Q, X, Y, U, label, **kw)
```

Arguments:

Q: The Quiver instance returned by a call to `quiver`.

X, Y: The location of the key; additional explanation follows.

U: The length of the key

label: A string with the length and units of the key

Keyword arguments:

coordinates = ['axes' | 'figure' | 'data' | 'inches'] Coordinate system and units for X, Y: 'axes' and 'figure' are normalized coordinate systems with 0,0 in the lower left and 1,1 in the upper right; 'data' are the axes data coordinates (used for the locations of the vectors in the quiver plot itself); 'inches' is position in the figure in inches, with 0,0 at the lower left corner.

color: overrides face and edge colors from *Q*.

labelpos = ['N' | 'S' | 'E' | 'W'] Position the label above, below, to the right, to the left of the arrow, respectively.

labelsep: Distance in inches between the arrow and the label. Default is 0.1

labelcolor: defaults to default *Text* color.

fontproperties: A dictionary with keyword arguments accepted by the *FontProperties* initializer: *family, style, variant, size, weight*

Any additional keyword arguments are used to override vector properties taken from *Q*.

The positioning of the key depends on X, Y, *coordinates*, and *labelpos*. If *labelpos* is 'N' or 'S', X, Y give the position of the middle of the key arrow. If *labelpos* is 'E', X, Y positions the head, and if *labelpos* is 'W', X, Y positions the tail; in either of these two cases, X, Y is somewhere in the middle of the arrow+label key object.

`matplotlib.pyplot.rc(*args, **kwargs)`

Set the current rc params. Group is the grouping for the rc, e.g., for `lines.linewidth` the group is `lines`, for `axes.facecolor`, the group is `axes`, and so on. Group may also be a list or tuple of group names, e.g., (`x tick, y tick`). *kwargs* is a dictionary attribute name/value pairs, e.g.,:

```
rc('lines', linewidth=2, color='r')
```

sets the current rc params and is equivalent to:

```
rcParams['lines.linewidth'] = 2
rcParams['lines.color'] = 'r'
```

The following aliases are available to save typing for interactive users:

Alias	Property
'lw'	'linewidth'
'ls'	'linestyle'
'c'	'color'
'fc'	'facecolor'
'ec'	'edgecolor'
'mew'	'markeredgewidth'
'aa'	'antialiased'

Thus you could abbreviate the above rc command as:

```
rc('lines', lw=2, c='r')
```

Note you can use python's kwargs dictionary facility to store dictionaries of default parameters. e.g., you can customize the font rc as follows:

```
font = {'family' : 'monospace',
        'weight' : 'bold',
        'size'   : 'larger'}

rc('font', **font) # pass in the font dict as kwargs
```

This enables you to easily switch between several configurations. Use `matplotlib.style.use('default')` or `rcdefaults()` to restore the default rc params after changes.

`matplotlib.pyplot.rc_context(rc=None, fname=None)`

Return a context manager for managing rc settings.

This allows one to do:

```
with mpl.rc_context(fname='screen.rc'):
    plt.plot(x, a)
    with mpl.rc_context(fname='print.rc'):
        plt.plot(x, b)
    plt.plot(x, c)
```

The 'a' vs 'x' and 'c' vs 'x' plots would have settings from 'screen.rc', while the 'b' vs 'x' plot would have settings from 'print.rc'.

A dictionary can also be passed to the context manager:

```
with mpl.rc_context(rc={'text.usetex': True}, fname='screen.rc'):
    plt.plot(x, a)
```

The 'rc' dictionary takes precedence over the settings loaded from 'fname'. Passing a dictionary only is also valid.

`matplotlib.pyplot.rcdefaults()`

Restore the rc params from Matplotlib's internal defaults.

See also:

rc_file_defaults Restore the rc params from the rc file originally loaded by Matplotlib.

matplotlib.style.use Use a specific style file. Call `style.use('default')` to restore the default style.

`matplotlib.pyplot.rgrids(*args, **kwargs)`

Get or set the radial gridlines on a polar plot.

call signatures:

```
lines, labels = rgrids()
lines, labels = rgrids(radii, labels=None, angle=22.5, **kwargs)
```

When called with no arguments, `rgrid()` simply returns the tuple *(lines, labels)*, where *lines* is an array of radial gridlines (*Line2D* instances) and *labels* is an array of tick labels (*Text* instances). When called with arguments, the labels will appear at the specified radial distances and angles.

labels, if not *None*, is a `len(radii)` list of strings of the labels to use at each angle.

If *labels* is *None*, the `rformatter` will be used

Examples:

```
# set the locations of the radial gridlines and labels
lines, labels = rgrids( (0.25, 0.5, 1.0) )

# set the locations and labels of the radial gridlines and labels
lines, labels = rgrids( (0.25, 0.5, 1.0), ('Tom', 'Dick', 'Harry' )
```

`matplotlib.pyplot.savefig(*args, **kwargs)`

Save the current figure.

Call signature:

```
savefig(fname, dpi=None, facecolor='w', edgecolor='w',
        orientation='portrait', papertype=None, format=None,
        transparent=False, bbox_inches=None, pad_inches=0.1,
        frameon=None)
```

The output formats available depend on the backend being used.

Arguments:

fname: A string containing a path to a filename, or a Python file-like object, or possibly some backend-dependent object such as *PdfPages*.

If *format* is *None* and *fname* is a string, the output format is deduced from the extension of the filename. If the filename has no extension, the value of the `rc` parameter `savefig.format` is used.

If *fname* is not a string, remember to specify *format* to ensure that the correct backend is used.

Keyword arguments:

dpi: [*None* | **scalar** > 0 | **'figure'**] The resolution in dots per inch. If *None* it will default to the value `savefig.dpi` in the `matplotlibrc` file. If **'figure'** it will set the dpi to be the value of the figure.

facecolor, edgecolor: the colors of the figure rectangle

orientation: [**'landscape'** | **'portrait'**] not supported on all backends; currently only on postscript output

paper**type**: One of ‘letter’, ‘legal’, ‘executive’, ‘ledger’, ‘a0’ through ‘a10’, ‘b0’ through ‘b10’. Only supported for postscript output.

format: One of the file extensions supported by the active backend. Most backends support png, pdf, ps, eps and svg.

transparent: If *True*, the axes patches will all be transparent; the figure patch will also be transparent unless *facecolor* and/or *edgecolor* are specified via *kwargs*. This is useful, for example, for displaying a plot on top of a colored background on a web page. The transparency of these patches will be restored to their original values upon exit of this function.

frameon: If *True*, the figure patch will be colored, if *False*, the figure background will be transparent. If not provided, the rcParam ‘savefig.frameon’ will be used.

bbox_inches: Bbox in inches. Only the given portion of the figure is saved. If ‘tight’, try to figure out the tight bbox of the figure.

pad_inches: Amount of padding around the figure when *bbox_inches* is ‘tight’.

bbox_extra_artists: A list of extra artists that will be considered when the tight bbox is calculated.

`matplotlib.pyplot.sca(ax)`

Set the current Axes instance to *ax*.

The current Figure is updated to the parent of *ax*.

`matplotlib.pyplot.scatter(x, y, s=None, c=None, marker=None, cmap=None, norm=None, vmin=None, vmax=None, alpha=None, linewidths=None, verts=None, edgecolors=None, hold=None, data=None, **kwargs)`

Make a scatter plot of *x* vs *y*

Marker size is scaled by *s* and marker color is mapped to *c*

Parameters *x, y* : array_like, shape (n,)

Input data

s : scalar or array_like, shape (n,), optional

size in points². Default is `rcParams['lines.markersize'] ** 2`.

c : color, sequence, or sequence of color, optional, default: ‘b’

c can be a single color format string, or a sequence of color specifications of length *N*, or a sequence of *N* numbers to be mapped to colors using the *cmap* and *norm* specified via *kwargs* (see below). Note that *c* should not be a single numeric RGB or RGBA sequence because that is indistinguishable from an array of values to be colormapped. *c* can be a 2-D array in which the rows are RGB or RGBA, however, including the case of a single row to specify the same color for all points.

marker : *MarkerStyle*, optional, default: ‘o’

See [markers](#) for more information on the different styles of markers scatter supports. `marker` can be either an instance of the class or the text shorthand for a particular marker.

cmap : [Colormap](#), optional, default: None

A [Colormap](#) instance or registered name. `cmap` is only used if `c` is an array of floats. If None, defaults to `rc.image.cmap`.

norm : [Normalize](#), optional, default: None

A [Normalize](#) instance is used to scale luminance data to 0, 1. `norm` is only used if `c` is an array of floats. If None, use the default `normalize()`.

vmin, vmax : scalar, optional, default: None

`vmin` and `vmax` are used in conjunction with `norm` to normalize luminance data. If either are None, the min and max of the color array is used. Note if you pass a `norm` instance, your settings for `vmin` and `vmax` will be ignored.

alpha : scalar, optional, default: None

The alpha blending value, between 0 (transparent) and 1 (opaque)

linewidths : scalar or array_like, optional, default: None

If None, defaults to `(lines.linewidth,)`.

verts : sequence of (x, y), optional

If `marker` is None, these vertices will be used to construct the marker. The center of the marker is located at (0,0) in normalized units. The overall marker is rescaled by `s`.

edgecolors : color or sequence of color, optional, default: None

If None, defaults to 'face'

If 'face', the edge color will always be the same as the face color.

If it is 'none', the patch boundary will not be drawn.

For non-filled markers, the `edgecolors` kwarg is ignored and forced to 'face' internally.

Returns paths : [PathCollection](#)

Other Parameters kwargs : [Collection](#) properties

See also:

[plot](#) to plot scatter plots when markers are identical in size and color

Notes

- The [plot](#) function will be faster for scatterplots where markers don't vary in size or color.

- Any or all of `x`, `y`, `s`, and `c` may be masked arrays, in which case all masks will be combined and only unmasked points will be plotted.

Fundamentally, scatter works with 1-D arrays; `x`, `y`, `s`, and `c` may be input as 2-D arrays, but within scatter they will be flattened. The exception is `c`, which will be flattened only if its size matches the size of `x` and `y`.

Examples

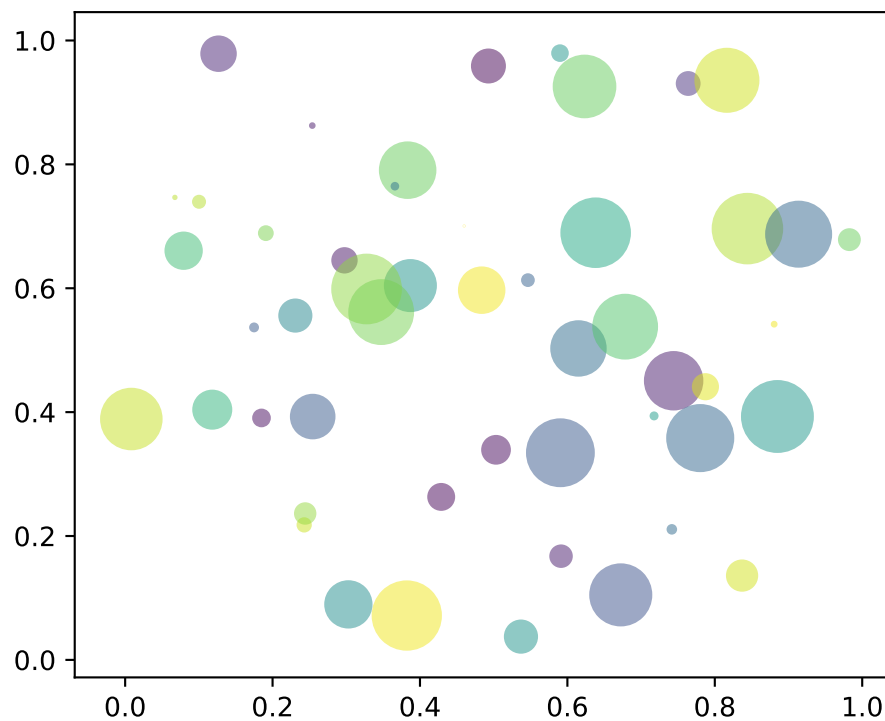

Note: In addition to the above described arguments, this function can take a **data** keyword argument. If such a **data** argument is given, the following arguments are replaced by **data[<arg>]**:

- All arguments with the following names: 'c', 'color', 'edgecolors', 'facecolor', 'facecolors', 'linewidths', 's', 'x', 'y'.

`matplotlib.pyplot.sci(im)`

Set the current image. This image will be the target of colormap commands like `jet()`, `hot()` or `clim()`. The current image is an attribute of the current axes.

`matplotlib.pyplot.semilogx(*args, **kwargs)`

Make a plot with log scaling on the `x` axis.

Parameters `basex` : float, optional

Base of the x logarithm. The scalar should be larger than 1.

subsx : array_like, optional

The location of the minor x ticks; *None* defaults to `autosubs`, which depend on the number of decades in the plot; see `set_xscale()` for details.

nonposx : string, optional, { 'mask', 'clip' }

Non-positive values in x can be masked as invalid, or clipped to a very small positive number.

Returns `plot`

Log-scaled plot on the x axis.

Other Parameters :class:'~matplotlib.lines.Line2D' properties:

Property	Description
<code>agg_filter</code>	unknown
<code>alpha</code>	float (0.0 transparent through 1.0 opaque)
<code>animated</code>	[True False]
<code>antialiased</code> or <code>aa</code>	[True False]
<code>axes</code>	an <code>Axes</code> instance
<code>clip_box</code>	a <code>matplotlib.transforms.Bbox</code> instance
<code>clip_on</code>	[True False]
<code>clip_path</code>	[(<code>Path</code> , <code>Transform</code>) <code>Patch</code> None]
<code>color</code> or <code>c</code>	any matplotlib color
<code>contains</code>	a callable function
<code>dash_capstyle</code>	['butt' 'round' 'projecting']
<code>dash_joinstyle</code>	['miter' 'round' 'bevel']
<code>dashes</code>	sequence of on/off ink in points
<code>drawstyle</code>	['default' 'steps' 'steps-pre' 'steps-mid' 'steps-post']
<code>figure</code>	a <code>matplotlib.figure.Figure</code> instance
<code>fillstyle</code>	['full' 'left' 'right' 'bottom' 'top' 'none']
<code>gid</code>	an id string
<code>label</code>	string or anything printable with '%s' conversion.
<code>linestyle</code> or <code>ls</code>	['solid' 'dashed', 'dashdot', 'dotted' (offset, on-off-dash-seq) '-' '--' '-.' ' ']
<code>linewidth</code> or <code>lw</code>	float value in points
<code>marker</code>	<i>A valid marker style</i>
<code>markeredgecolor</code> or <code>mec</code>	any matplotlib color
<code>markeredgewidth</code> or <code>mew</code>	float value in points
<code>markerfacecolor</code> or <code>mfc</code>	any matplotlib color
<code>markerfacecoloralt</code> or <code>mfcalt</code>	any matplotlib color
<code>markersize</code> or <code>ms</code>	float
<code>markevery</code>	[None int length-2 tuple of int slice list/array of int float length-2 tuple of float]
<code>path_effects</code>	unknown
<code>picker</code>	float distance in points or callable pick function <code>fn(artist, event)</code>

Table 45.28 – continued from previous page

Property	Description
<i>pickradius</i>	float distance in points
<i>rasterized</i>	[True False None]
<i>sketch_params</i>	unknown
<i>snap</i>	unknown
<i>solid_capstyle</i>	['butt' 'round' 'projecting']
<i>solid_joinstyle</i>	['miter' 'round' 'bevel']
<i>transform</i>	a <i>matplotlib.transforms.Transform</i> instance
<i>url</i>	a url string
<i>visible</i>	[True False]
<i>xdata</i>	1D array
<i>ydata</i>	1D array
<i>zorder</i>	any number

See also:

loglog For example code and figure.

Notes

This function supports all the keyword arguments of *plot()* and *matplotlib.axes.Axes.set_xscale()*.

`matplotlib.pyplot.semilogy(*args, **kwargs)`

Make a plot with log scaling on the y axis.

Parameters *basey* : scalar > 1

Base of the y logarithm.

subsy [None or iterable] The location of the minor yticks. None defaults to autosubs, which depend on the number of decades in the plot. See *set_yscale()* for details.

nonposy [{'mask' | 'clip'} str] Non-positive values in y can be masked as invalid, or clipped to a very small positive number.

Returns *Line2D*

Line instance of the plot.

Other Parameters *kwargs* : *Line2D* properties,

plot and *matplotlib.axes.Axes.set_yscale* arguments.

=====
=====

Property Description

```

=====
=====

:meth:'agg_filter <matplotlib.artist.Artist.set_agg_filter>' unknown

:meth:'alpha <matplotlib.artist.Artist.set_alpha>' float (0.0 transparent through
1.0 opaque)

:meth:'animated <matplotlib.artist.Artist.set_animated>' [True | False]

:meth:'antialiased <matplotlib.lines.Line2D.set_antialiased>' or aa [True |
False]

:meth:'axes <matplotlib.artist.Artist.set_axes>' an
:class:'~matplotlib.axes.Axes' instance

:meth:'clip_box <matplotlib.artist.Artist.set_clip_box>' a
:class:'matplotlib.transforms.Bbox' instance

:meth:'clip_on <matplotlib.artist.Artist.set_clip_on>' [True | False]

:meth:'clip_path <matplotlib.artist.Artist.set_clip_path>' [
(:class:'~matplotlib.path.Path', :class:'~matplotlib.transforms.Transform') |
:class:'~matplotlib.patches.Patch' | None ]

:meth:'color <matplotlib.lines.Line2D.set_color>' or c any matplotlib color

:meth:'contains <matplotlib.artist.Artist.set_contains>' a callable function

:meth:'dash_capstyle <matplotlib.lines.Line2D.set_dash_capstyle>' ['butt' |
'round' | 'projecting']

:meth:'dash_joinstyle <matplotlib.lines.Line2D.set_dash_joinstyle>' ['miter' |
'round' | 'bevel']

:meth:'dashes <matplotlib.lines.Line2D.set_dashes>' sequence of on/off ink in
points

:meth:'drawstyle <matplotlib.lines.Line2D.set_drawstyle>' ['default' | 'steps' |
'steps-pre' | 'steps-mid' | 'steps-post']

:meth:'figure <matplotlib.artist.Artist.set_figure>' a
:class:'matplotlib.figure.Figure' instance

:meth:'fillstyle <matplotlib.lines.Line2D.set_fillstyle>' ['full' | 'left' | 'right' |
'bottom' | 'top' | 'none']

:meth:'gid <matplotlib.artist.Artist.set_gid>' an id string

:meth:'label <matplotlib.artist.Artist.set_label>' string or anything printable
with '%s' conversion.

:meth:'linestyle <matplotlib.lines.Line2D.set_linestyle>' or ls ['solid' | 'dashed',
'dashdot', 'dotted' | (offset, on-off-dash-seq) | "'-'", "'--'", "'-.'", "':.'",
"'None'", "' '", "' '", "' '"]

```

```

:meth:'linewidth <matplotlib.lines.Line2D.set_linewidth>' or lw float value in
points
:meth:'marker <matplotlib.lines.Line2D.set_marker>' :mod:'A valid marker
style <matplotlib.markers>'
:meth:'markeredgecolor <matplotlib.lines.Line2D.set_markeredgecolor>' or
mec any matplotlib color
:meth:'markeredgewidth <matplotlib.lines.Line2D.set_markeredgewidth>' or
mew float value in points
:meth:'markerfacecolor <matplotlib.lines.Line2D.set_markerfacecolor>' or mfc
any matplotlib color
:meth:'markerfacecoloralt <matplotlib.lines.Line2D.set_markerfacecoloralt>'
or mfcalt any matplotlib color
:meth:'markersize <matplotlib.lines.Line2D.set_markersize>' or ms float
:meth:'markevery <matplotlib.lines.Line2D.set_markevery>' [None | int |
length-2 tuple of int | slice | list/array of int | float | length-2 tuple of float]
:meth:'path_effects <matplotlib.artist.Artist.set_path_effects>' unknown
:meth:'picker <matplotlib.lines.Line2D.set_picker>' float distance in points or
callable pick function "fn(artist, event)"
:meth:'pickradius <matplotlib.lines.Line2D.set_pickradius>' float distance in
points
:meth:'rasterized <matplotlib.artist.Artist.set_rasterized>' [True | False | None]
:meth:'sketch_params <matplotlib.artist.Artist.set_sketch_params>' unknown
:meth:'snap <matplotlib.artist.Artist.set_snap>' unknown
:meth:'solid_capstyle <matplotlib.lines.Line2D.set_solid_capstyle>' ['butt' |
'round' | 'projecting']
:meth:'solid_joinstyle <matplotlib.lines.Line2D.set_solid_joinstyle>' ['miter' |
'round' | 'bevel']
:meth:'transform <matplotlib.lines.Line2D.set_transform>' a
:class:'matplotlib.transforms.Transform' instance
:meth:'url <matplotlib.artist.Artist.set_url>' a url string
:meth:'visible <matplotlib.artist.Artist.set_visible>' [True | False]
:meth:'xdata <matplotlib.lines.Line2D.set_xdata>' 1D array
:meth:'ydata <matplotlib.lines.Line2D.set_ydata>' 1D array
:meth:'zorder <matplotlib.artist.Artist.set_zorder>' any number

```

```

=====
=====

```

See also:

[`loglog\(\)`](#) For example code and figure.

`matplotlib.pyplot.set_cmap(cmap)`

Set the default colormap. Applies to the current image if any. See `help(colormaps)` for more information.

`cmap` must be a `Colormap` instance, or the name of a registered colormap.

See `matplotlib.cm.register_cmap()` and `matplotlib.cm.get_cmap()`.

`matplotlib.pyplot.setp(*args, **kwargs)`

Set a property on an artist object.

matplotlib supports the use of `setp()` (“set property”) and `getp()` to set and get object properties, as well as to do introspection on the object. For example, to set the linestyle of a line to be dashed, you can do:

```
>>> line, = plot([1,2,3])
>>> setp(line, linestyle='--')
```

If you want to know the valid types of arguments, you can provide the name of the property you want to set without a value:

```
>>> setp(line, 'linestyle')
linestyle: [ '-' | '--' | '-.' | ':' | 'steps' | 'None' ]
```

If you want to see all the properties that can be set, and their possible values, you can do:

```
>>> setp(line)
... long output listing omitted
```

`setp()` operates on a single instance or a list of instances. If you are in query mode introspecting the possible values, only the first instance in the sequence is used. When actually setting values, all the instances will be set. e.g., suppose you have a list of two lines, the following will make both lines thicker and red:

```
>>> x = arange(0,1.0,0.01)
>>> y1 = sin(2*pi*x)
>>> y2 = sin(4*pi*x)
>>> lines = plot(x, y1, x, y2)
>>> setp(lines, linewidth=2, color='r')
```

`setp()` works with the MATLAB style string/value pairs or with python kwargs. For example, the following are equivalent:

```
>>> setp(lines, 'linewidth', 2, 'color', 'r') # MATLAB style
>>> setp(lines, linewidth=2, color='r')     # python style
```

`matplotlib.pyplot.show(*args, **kw)`

Display a figure. When running in ipython with its pylab mode, display all figures and return to the ipython prompt.

In non-interactive mode, display all figures and block until the figures have been closed; in interactive mode it has no effect unless figures were created prior to a change from non-interactive to interactive mode (not recommended). In that case it displays the figures but does not block.

A single experimental keyword argument, *block*, may be set to True or False to override the blocking behavior described above.

```
matplotlib.pyplot.specgram(x, NFFT=None, Fs=None, Fc=None, detrend=None, win-
                             dow=None, noverlap=None, cmap=None, xextent=None,
                             pad_to=None, sides=None, scale_by_freq=None, mode=None,
                             scale=None, vmin=None, vmax=None, hold=None, data=None,
                             **kwargs)
```

Plot a spectrogram.

Call signature:

```
specgram(x, NFFT=256, Fs=2, Fc=0, detrend=mlab.detrend_none,
          window=mlab.window_hanning, noverlap=128,
          cmap=None, xextent=None, pad_to=None, sides='default',
          scale_by_freq=None, mode='default', scale='default',
          **kwargs)
```

Compute and plot a spectrogram of data in *x*. Data are split into *NFFT* length segments and the spectrum of each section is computed. The windowing function *window* is applied to each segment, and the amount of overlap of each segment is specified with *noverlap*. The spectrogram is plotted as a colormap (using *imshow*).

Parameters x : 1-D array or sequence

Array or sequence containing the data.

Fs : scalar

The sampling frequency (samples per time unit). It is used to calculate the Fourier frequencies, *freqs*, in cycles per time unit. The default value is 2.

window : callable or ndarray

A function or a vector of length *NFFT*. To create window vectors see *window_hanning()*, *window_none()*, *numpy.blackman()*, *numpy.hamming()*, *numpy.bartlett()*, *scipy.signal()*, *scipy.signal.get_window()*, etc. The default is *window_hanning()*. If a function is passed as the argument, it must take a data segment as an argument and return the windowed version of the segment.

sides : ['default' | 'onesided' | 'twosided']

Specifies which sides of the spectrum to return. Default gives the default behavior, which returns one-sided for real data and both for complex data. 'onesided' forces the return of a one-sided spectrum, while 'twosided' forces two-sided.

pad_to : integer

The number of points to which the data segment is padded when performing the FFT. This can be different from *NFFT*, which specifies the number of data points used. While not increasing the actual resolution of the spectrum (the minimum distance between resolvable peaks), this can give more points in the plot, allowing for more detail. This corresponds to the *n* parameter in the call to `fft()`. The default is `None`, which sets *pad_to* equal to *NFFT*

NFFT : integer

The number of data points used in each block for the FFT. A power 2 is most efficient. The default value is 256. This should *NOT* be used to get zero padding, or the scaling of the result will be incorrect. Use *pad_to* for this instead.

detrend : { 'default', 'constant', 'mean', 'linear', 'none' } or callable

The function applied to each segment before fit-ting, designed to remove the mean or linear trend. Unlike in MATLAB, where the *detrend* parameter is a vector, in matplotlib is it a function. The `pylab` module defines `detrend_none()`, `detrend_mean()`, and `detrend_linear()`, but you can use a custom function as well. You can also use a string to choose one of the functions. 'default', 'constant', and 'mean' call `detrend_mean()`. 'linear' calls `detrend_linear()`. 'none' calls `detrend_none()`.

scale_by_freq : boolean, optional

Specifies whether the resulting density values should be scaled by the scaling frequency, which gives density in units of Hz^{-1} . This allows for integration over the returned frequency values. The default is `True` for MATLAB compatibility.

mode : ['default' | 'psd' | 'magnitude' | 'angle' | 'phase']

What sort of spectrum to use. Default is 'psd', which takes the power spectral density. 'complex' returns the complex-valued frequency spectrum. 'magnitude' returns the magnitude spectrum. 'angle' returns the phase spectrum without unwrapping. 'phase' returns the phase spectrum with unwrapping.

noverlap : integer

The number of points of overlap between blocks. The default value is 128.

scale : ['default' | 'linear' | 'dB']

The scaling of the values in the *spec*. 'linear' is no scaling. 'dB' returns the values in dB scale. When *mode* is 'psd', this is dB power ($10 * \log_{10}$). Otherwise this is dB amplitude ($20 * \log_{10}$). 'default' is 'dB' if *mode* is 'psd' or 'magnitude' and 'linear' otherwise. This must be 'linear' if *mode* is 'angle' or 'phase'.

Fc : integer

The center frequency of *x* (defaults to 0), which offsets the x extents of the plot to reflect the frequency range used when a signal is acquired and then filtered and downsampled to baseband.

cmap :

A `matplotlib.colors.Colormap` instance; if `None`, use default determined by `rc`

xextent : [None | (xmin, xmax)]

The image extent along the x-axis. The default sets `xmin` to the left border of the first bin (`spectrum` column) and `xmax` to the right border of the last bin. Note that for `noverlap>0` the width of the bins is smaller than those of the segments.

****kwargs :**

Additional kwargs are passed on to `imshow` which makes the spectrogram image

Returns spectrum : 2-D array

Columns are the periodograms of successive segments.

freqs : 1-D array

The frequencies corresponding to the rows in `spectrum`.

t : 1-D array

The times corresponding to midpoints of segments (i.e., the columns in `spectrum`).

im : instance of class `AxesImage`

The image created by `imshow` containing the spectrogram

See also:

`psd()` `psd()` differs in the default overlap; in returning the mean of the segment periodograms; in not returning times; and in generating a line plot instead of colormap.

`magnitude_spectrum()` A single spectrum, similar to having a single segment when `mode` is 'magnitude'. Plots a line instead of a colormap.

`angle_spectrum()` A single spectrum, similar to having a single segment when `mode` is 'angle'. Plots a line instead of a colormap.

`phase_spectrum()` A single spectrum, similar to having a single segment when `mode` is 'phase'. Plots a line instead of a colormap.

In addition to the above described arguments, this function can take a **data** keyword argument. If such a **data** argument is given, the following arguments are replaced by **data[<arg>]**: * All arguments with the following names: 'x'.

Notes

`detrend` and `scale_by_freq` only apply when `mode` is set to 'psd'

Examples

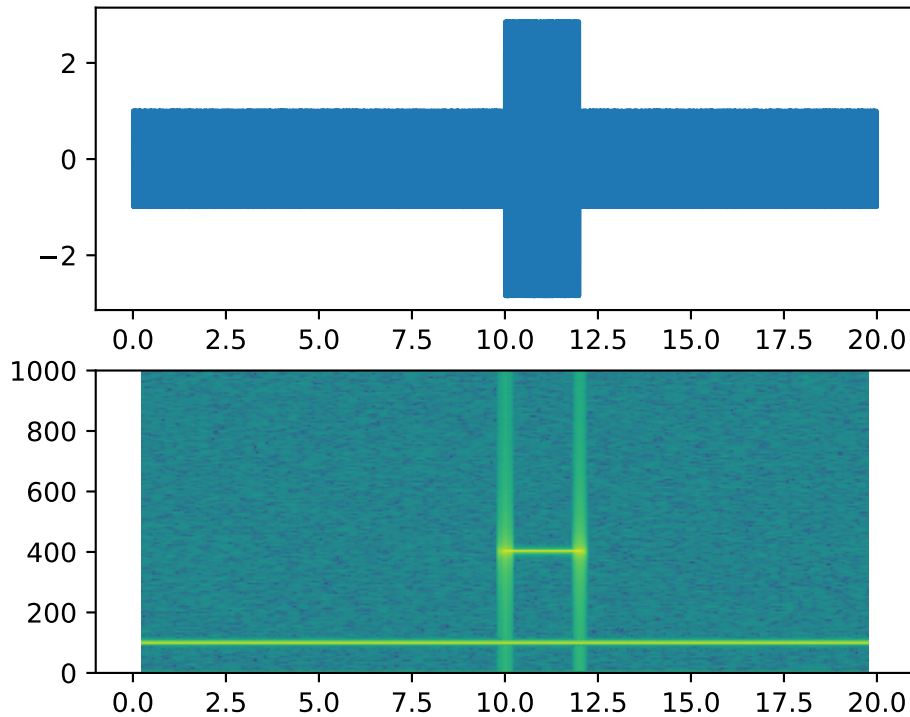

`matplotlib.pyplot.spectral()`

set the default colormap to spectral and apply to current image if any. See `help(colormaps)` for more information

`matplotlib.pyplot.spring()`

set the default colormap to spring and apply to current image if any. See `help(colormaps)` for more information

`matplotlib.pyplot.spy(Z, precision=0, marker=None, markersize=None, aspect='equal', **kwargs)`

Plot the sparsity pattern on a 2-D array.

`spy(Z)` plots the sparsity pattern of the 2-D array `Z`.

Parameters `Z` : sparse array (n, m)

The array to be plotted.

precision : float, optional, default: 0

If `precision` is 0, any non-zero value will be plotted; else, values of $|Z| > precision$ will be plotted.

For `scipy.sparse.spmatrix` instances, there is a special case: if `precision` is 'present', any value present in the array will be plotted, even if it is

identically zero.

origin : [”upper”, “lower”], optional, default: “upper”

Place the [0,0] index of the array in the upper left or lower left corner of the axes.

aspect : [’auto’ | ’equal’ | scalar], optional, default: “equal”

If ‘equal’, and `extent` is `None`, changes the axes aspect ratio to match that of the image. If `extent` is not `None`, the axes aspect ratio is changed to match that of the extent.

If ‘auto’, changes the image aspect ratio to match that of the axes.

If `None`, default to `rc image.aspect` value.

Two plotting styles are available: image or marker. Both are available for full arrays, but only the marker style works for `:class:’scipy.sparse.spmatrix’` instances.

If `*marker*` and `*markersize*` are `*None*`, an image will be returned and any remaining kwargs are passed to

`:func:’~matplotlib.pyplot.imshow’`; else, a

`:class:’~matplotlib.lines.Line2D’` object will be returned with the value of `marker` determining the marker type, and any remaining kwargs passed to the

`:meth:’~matplotlib.axes.Axes.plot’` method.

If `*marker*` and `*markersize*` are `*None*`, useful kwargs include:

`*cmap*`

`*alpha*`

See also:

[*imshow*](#) for image options.

[*plot*](#) for plotting options

`matplotlib.pyplot.stackplot(x, *args, **kwargs)`

Draws a stacked area plot.

`x` : 1d array of dimension `N`

`y` [2d array of dimension `MxN`, OR any number 1d arrays each of dimension] `1xN`. The data is assumed to be unstacked. Each of the following calls is legal:

```
stackplot(x, y) # where y is MxN
stackplot(x, y1, y2, y3, y4) # where y1, y2, y3, y4, are all 1xNm
```

Keyword arguments:

baseline [['zero', 'sym', 'wiggle', 'weighted_wiggle']] Method used to calculate the baseline. 'zero' is just a simple stacked plot. 'sym' is symmetric around zero and is sometimes called ThemeRiver. 'wiggle' minimizes the sum of the squared slopes. 'weighted_wiggle' does the same but weights to account for size of each layer. It is also called Streamgraph-layout. More details can be found at <http://leebyron.com/streamgraph/>.

labels : A list or tuple of labels to assign to each data series.

colors [A list or tuple of colors. These will be cycled through and] used to colour the stacked areas. All other keyword arguments are passed to `fill_between()`

Returns *r* : A list of *PolyCollection*, one for each element in the stacked area plot.

`matplotlib.pyplot.stem(*args, **kwargs)`

Create a stem plot.

Call signatures:

```
stem(y, linefmt='b-', markerfmt='bo', basefmt='r-')
stem(x, y, linefmt='b-', markerfmt='bo', basefmt='r-')
```

A stem plot plots vertical lines (using *linefmt*) at each *x* location from the baseline to *y*, and places a marker there using *markerfmt*. A horizontal line at 0 is plotted using *basefmt*.

If no *x* values are provided, the default is (0, 1, ..., len(y) - 1)

Return value is a tuple (*markerline*, *stemlines*, *baseline*).

See also:

This [document](#) for details.

Example:

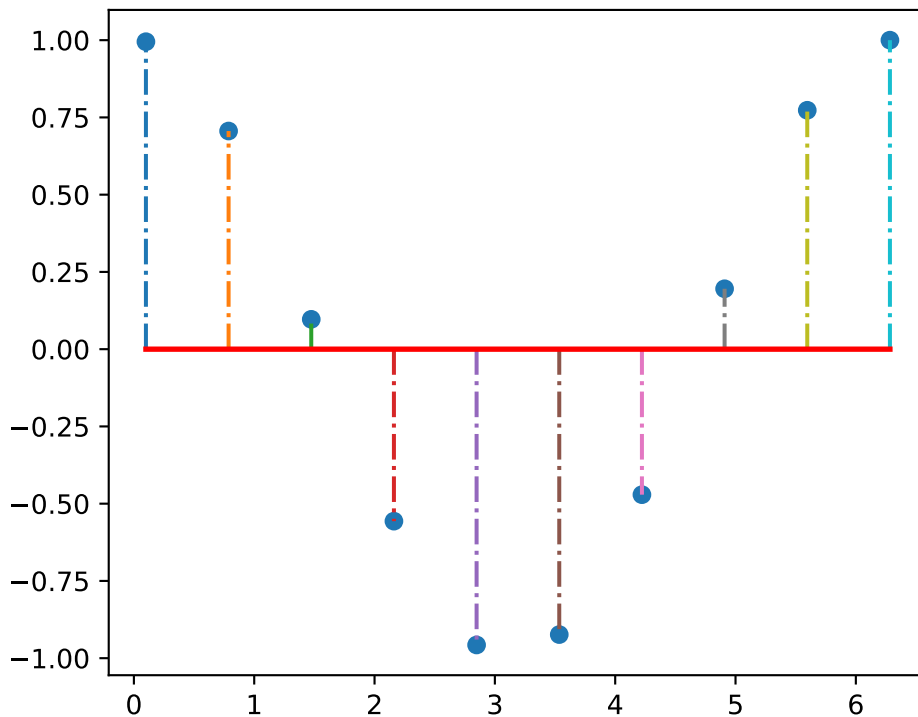

Note: In addition to the above described arguments, this function can take a **data** keyword argument. If such a **data** argument is given, the following arguments are replaced by **data[<arg>]**:

- All positional and all keyword arguments.
-

`matplotlib.pyplot.step(x, y, *args, **kwargs)`

Make a step plot.

Parameters `x` : array_like

1-D sequence, and it is assumed, but not checked, that it is uniformly increasing.

`y` : array_like

1-D sequence, and it is assumed, but not checked, that it is uniformly increasing.

Returns list

List of lines that were added.

Other Parameters `where` : ['pre' | 'post' | 'mid']

If 'pre' (the default), the interval from `x[i]` to `x[i+1]` has level `y[i+1]`.

If 'post', that interval has level $y[i]$.

If 'mid', the jumps in y occur half-way between the x -values.

Notes

Additional parameters are the same as those for `plot()`.

Note: In addition to the above described arguments, this function can take a **data** keyword argument. If such a **data** argument is given, the following arguments are replaced by **data[<arg>]**:

- All arguments with the following names: 'x', 'y'.
-

```
matplotlib.pyplot.streamplot(x, y, u, v, density=1, linewidth=None, color=None,
                               cmap=None, norm=None, arrowsize=1, arrowstyle='->',
                               minlength=0.1, transform=None, zorder=None,
                               start_points=None, hold=None, data=None)
```

Draws streamlines of a vector flow.

x, y [1d arrays] an *evenly spaced* grid.

u, v [2d arrays] x and y-velocities. Number of rows should match length of y, and the number of columns should match x.

density [float or 2-tuple] Controls the closeness of streamlines. When `density = 1`, the domain is divided into a 30x30 grid—*density* linearly scales this grid. Each cell in the grid can have, at most, one traversing streamline. For different densities in each direction, use `[density_x, density_y]`.

linewidth [numeric or 2d array] vary linewidth when given a 2d array with the same shape as velocities.

color [matplotlib color code, or 2d array] Streamline color. When given an array with the same shape as velocities, *color* values are converted to colors using *cmap*.

cmap [*Colormap*] Colormap used to plot streamlines and arrows. Only necessary when using an array input for *color*.

norm [*Normalize*] Normalize object used to scale luminance data to 0, 1. If None, stretch (min, max) to (0, 1). Only necessary when *color* is an array.

arrowsize [float] Factor scale arrow size.

arrowstyle [str] Arrow style specification. See [FancyArrowPatch](#).

minlength [float] Minimum length of streamline in axes coordinates.

start_points: **Nx2 array** Coordinates of starting points for the streamlines. In data coordinates, the same as the x and y arrays.

zorder [int] any number

Returns:

stream_container [StreamplotSet] Container object with attributes

- lines: *matplotlib.collections.LineCollection* of streamlines
- arrows: collection of *matplotlib.patches.FancyArrowPatch* objects representing arrows half-way along stream lines.

This container will probably change in the future to allow changes to the colormap, alpha, etc. for both lines and arrows, but these changes should be backward compatible.

`matplotlib.pyplot.subplot(*args, **kwargs)`

Return a subplot axes positioned by the given grid definition.

Typical call signature:

```
subplot(nrows, ncols, plot_number)
```

Where *nrows* and *ncols* are used to notionally split the figure into *nrows* * *ncols* sub-axes, and *plot_number* is used to identify the particular subplot that this function is to create within the notional grid. *plot_number* starts at 1, increments across rows first and has a maximum of *nrows* * *ncols*.

In the case when *nrows*, *ncols* and *plot_number* are all less than 10, a convenience exists, such that the a 3 digit number can be given instead, where the hundreds represent *nrows*, the tens represent *ncols* and the units represent *plot_number*. For instance:

```
subplot(211)
```

produces a subaxes in a figure which represents the top plot (i.e. the first) in a 2 row by 1 column notional grid (no grid actually exists, but conceptually this is how the returned subplot has been positioned).

Note: Creating a subplot will delete any pre-existing subplot that overlaps with it beyond sharing a boundary:

```
import matplotlib.pyplot as plt
# plot a line, implicitly creating a subplot(111)
plt.plot([1,2,3])
# now create a subplot which represents the top plot of a grid
# with 2 rows and 1 column. Since this subplot will overlap the
# first, the plot (and its axes) previously created, will be removed
plt.subplot(211)
plt.plot(range(12))
plt.subplot(212, facecolor='y') # creates 2nd subplot with yellow background
```

If you do not want this behavior, use the `add_subplot()` method or the `axes()` function instead.

Keyword arguments:

facecolor: The background color of the subplot, which can be any valid color specifier. See *matplotlib.colors* for more information.

polar: A boolean flag indicating whether the subplot plot should be a polar projection. Defaults to *False*.

projection: A string giving the name of a custom projection to be used for the subplot. This projection must have been previously registered. See [matplotlib.projections](#).

See also:

[axes\(\)](#) For additional information on [axes\(\)](#) and [subplot\(\)](#) keyword arguments.

[examples/pie_and_polar_charts/polar_scatter_demo.py](#) For an example

Example:

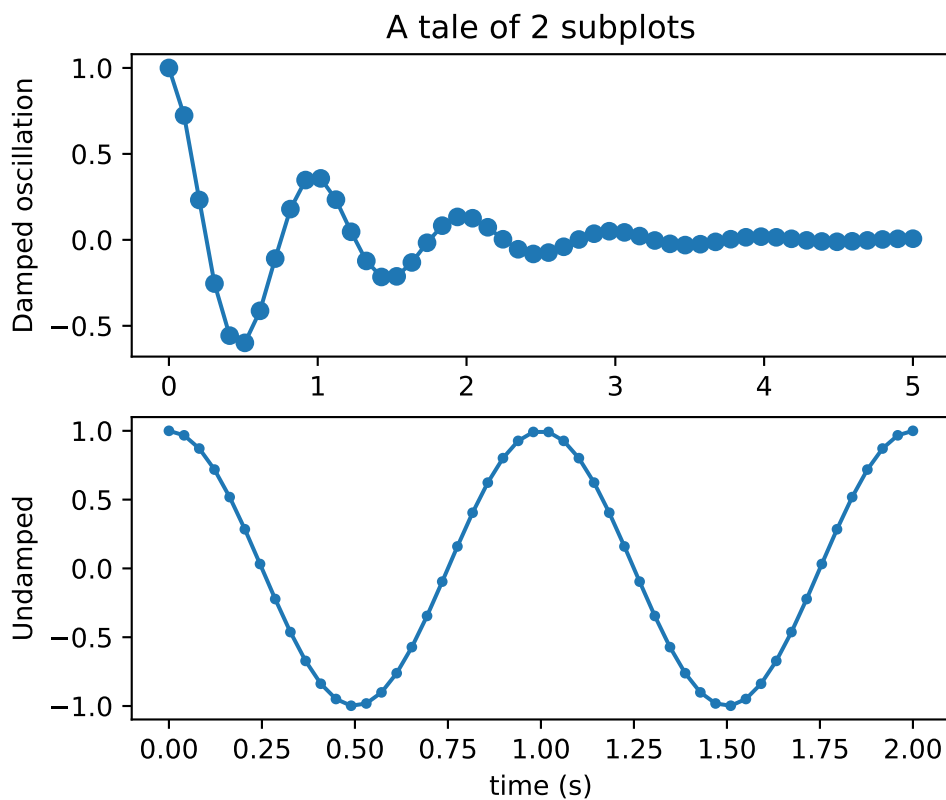

`matplotlib.pyplot.subplot2grid(shape, loc, rowspan=1, colspan=1, **kwargs)`

Create a subplot in a grid. The grid is specified by *shape*, at location of *loc*, spanning *rowspan*, *colspan* cells in each direction. The index for *loc* is 0-based.

```
subplot2grid(shape, loc, rowspan=1, colspan=1)
```

is identical to

```
gridspec=GridSpec(shape[0], shape[1])
subplotspec=gridspec.new_subplotspec(loc, rowspan, colspan)
subplot(subplotspec)
```

`matplotlib.pyplot.subplot_tool(targetfig=None)`

Launch a subplot tool window for a figure.

A `matplotlib.widgets.SubplotTool` instance is returned.

`matplotlib.pyplot.subplots(nrows=1, ncols=1, sharex=False, sharey=False, squeeze=True, subplot_kw=None, gridspec_kw=None, **fig_kw)`

Create a figure and a set of subplots

This utility wrapper makes it convenient to create common layouts of subplots, including the enclosing figure object, in a single call.

Parameters `nrows, ncols` : int, optional, default: 1

Number of rows/columns of the subplot grid.

sharex, sharey : bool or {'none', 'all', 'row', 'col'}, default: False

Controls sharing of properties among x (`sharex`) or y (`sharey`) axes:

- True or 'all': x- or y-axis will be shared among all subplots.
- False or 'none': each subplot x- or y-axis will be independent.
- 'row': each subplot row will share an x- or y-axis.
- 'col': each subplot column will share an x- or y-axis.

When subplots have a shared x-axis along a column, only the x tick labels of the bottom subplot are visible. Similarly, when subplots have a shared y-axis along a row, only the y tick labels of the first column subplot are visible.

squeeze : bool, optional, default: True

- If True, extra dimensions are squeezed out from the returned Axes object:
 - if only one subplot is constructed (`nrows=ncols=1`), the resulting single Axes object is returned as a scalar.
 - for `Nx1` or `1xN` subplots, the returned object is a 1D numpy object array of Axes objects are returned as numpy 1D arrays.
 - for `NxM`, subplots with `N>1` and `M>1` are returned as a 2D arrays.
- If False, no squeezing at all is done: the returned Axes object is always a 2D array containing Axes instances, even if it ends up being `1x1`.

subplot_kw : dict, optional

Dict with keywords passed to the `add_subplot()` call used to create each subplot.

gridspec_kw : dict, optional

Dict with keywords passed to the `GridSpec` constructor used to create the grid the subplots are placed on.

****fig_kw** :

All additional keyword arguments are passed to the `figure()` call.

Returns `fig` : `matplotlib.figure.Figure` object

`ax` : Axes object or array of Axes objects.

`ax` can be either a single `matplotlib.axes.Axes` object or an array of Axes objects if more than one subplot was created. The dimensions of the resulting array can be controlled with the `squeeze` keyword, see above.

See also:

`figure`, `subplot`

Examples

First create some toy data:

```
>>> x = np.linspace(0, 2*np.pi, 400)
>>> y = np.sin(x**2)
```

Creates just a figure and only one subplot

```
>>> fig, ax = plt.subplots()
>>> ax.plot(x, y)
>>> ax.set_title('Simple plot')
```

Creates two subplots and unpacks the output array immediately

```
>>> f, (ax1, ax2) = plt.subplots(1, 2, sharey=True)
>>> ax1.plot(x, y)
>>> ax1.set_title('Sharing Y axis')
>>> ax2.scatter(x, y)
```

Creates four polar axes, and accesses them through the returned array

```
>>> fig, axes = plt.subplots(2, 2, subplot_kw=dict(polar=True))
>>> axes[0, 0].plot(x, y)
>>> axes[1, 1].scatter(x, y)
```

Share a X axis with each column of subplots

```
>>> plt.subplots(2, 2, sharex='col')
```

Share a Y axis with each row of subplots

```
>>> plt.subplots(2, 2, sharey='row')
```

Share both X and Y axes with all subplots

```
>>> plt.subplots(2, 2, sharex='all', sharey='all')
```

Note that this is the same as

```
>>> plt.subplots(2, 2, sharex=True, sharey=True)
```

matplotlib.pyplot.**subplots_adjust**(*args, **kwargs)

Tune the subplot layout.

call signature:

```
subplots_adjust(left=None, bottom=None, right=None, top=None,
                wspace=None, hspace=None)
```

The parameter meanings (and suggested defaults) are:

```
left = 0.125 # the left side of the subplots of the figure
right = 0.9 # the right side of the subplots of the figure
bottom = 0.1 # the bottom of the subplots of the figure
top = 0.9 # the top of the subplots of the figure
wspace = 0.2 # the amount of width reserved for blank space between subplots,
             # expressed as a fraction of the average axis width
hspace = 0.2 # the amount of height reserved for white space between subplots,
             # expressed as a fraction of the average axis height
```

The actual defaults are controlled by the rc file

matplotlib.pyplot.**summer**()

set the default colormap to summer and apply to current image if any. See help(colormaps) for more information

matplotlib.pyplot.**suptitle**(*args, **kwargs)

Add a centered title to the figure.

kwargs are *matplotlib.text.Text* properties. Using figure coordinates, the defaults are:

x [0.5] The x location of the text in figure coords

y [0.98] The y location of the text in figure coords

horizontalalignment ['center'] The horizontal alignment of the text

verticalalignment ['top'] The vertical alignment of the text

If the `fontproperties` keyword argument is given then the rcParams defaults for `fontsize` (`figure.titlesize`) and `fontweight` (`figure.titleweight`) will be ignored in favour of the `FontProperties` defaults.

A *matplotlib.text.Text* instance is returned.

Example:

```
fig.suptitle('this is the figure title', fontsize=12)
```

matplotlib.pyplot.**switch_backend**(newbackend)

Switch the default backend. This feature is **experimental**, and is only expected to work switching to an image backend. e.g., if you have a bunch of PostScript scripts that you want to run from an interactive ipython session, you may want to switch to the PS backend before running them to avoid

having a bunch of GUI windows popup. If you try to interactively switch from one GUI backend to another, you will explode.

Calling this command will close all open windows.

`matplotlib.pyplot.table(**kwargs)`

Add a table to the current axes.

Call signature:

```
table(cellText=None, cellColours=None,
      cellLoc='right', colWidths=None,
      rowLabels=None, rowColours=None, rowLoc='left',
      colLabels=None, colColours=None, colLoc='center',
      loc='bottom', bbox=None):
```

Returns a `matplotlib.table.Table` instance. Either `cellText` or `cellColours` must be provided. For finer grained control over tables, use the `Table` class and add it to the axes with `add_table()`.

Thanks to John Gill for providing the class and table.

`kwargs` control the `Table` properties:

Property	Description
<code>agg_filter</code>	unknown
<code>alpha</code>	float (0.0 transparent through 1.0 opaque)
<code>animated</code>	[True False]
<code>axes</code>	an <i>Axes</i> instance
<code>clip_box</code>	a <code>matplotlib.transforms.Bbox</code> instance
<code>clip_on</code>	[True False]
<code>clip_path</code>	[(<i>Path</i> , <i>Transform</i>) <i>Patch</i> None]
<code>contains</code>	a callable function
<code>figure</code>	a <code>matplotlib.figure.Figure</code> instance
<code>fontsize</code>	a float in points
<code>gid</code>	an id string
<code>label</code>	string or anything printable with ‘%s’ conversion.
<code>path_effects</code>	unknown
<code>picker</code>	[None float boolean callable]
<code>rasterized</code>	[True False None]
<code>sketch_params</code>	unknown
<code>snap</code>	unknown
<code>transform</code>	<i>Transform</i> instance
<code>url</code>	a url string
<code>visible</code>	[True False]
<code>zorder</code>	any number

`matplotlib.pyplot.text(x, y, s, fontdict=None, withdash=False, **kwargs)`

Add text to the axes.

Add text in string `s` to axis at location `x, y`, data coordinates.

Parameters *x, y* : scalars

data coordinates

s : string

text

fontdict : dictionary, optional, default: None

A dictionary to override the default text properties. If fontdict is None, the defaults are determined by your rc parameters.

withdash : boolean, optional, default: False

Creates a *TextWithDash* instance instead of a *Text* instance.

Other Parameters *kwargs* : *Text* properties.

Other miscellaneous text parameters.

Examples

Individual keyword arguments can be used to override any given parameter:

```
>>> text(x, y, s, fontsize=12)
```

The default transform specifies that text is in data coords, alternatively, you can specify text in axis coords (0,0 is lower-left and 1,1 is upper-right). The example below places text in the center of the axes:

```
>>> text(0.5, 0.5, 'matplotlib', horizontalalignment='center',
...      verticalalignment='center',
...      transform=ax.transAxes)
```

You can put a rectangular box around the text instance (e.g., to set a background color) by using the keyword `bbox`. `bbox` is a dictionary of *Rectangle* properties. For example:

```
>>> text(x, y, s, bbox=dict(facecolor='red', alpha=0.5))
```

`matplotlib.pyplot.thetagrids(*args, **kwargs)`

Get or set the theta locations of the gridlines in a polar plot.

If no arguments are passed, return a tuple (*lines, labels*) where *lines* is an array of radial gridlines (*Line2D* instances) and *labels* is an array of tick labels (*Text* instances):

```
lines, labels = thetagrids()
```

Otherwise the syntax is:

```
lines, labels = thetagrids(angles, labels=None, fmt='%d', frac = 1.1)
```

set the angles at which to place the theta grids (these gridlines are equal along the theta dimension).

angles is in degrees.

labels, if not *None*, is a `len(angles)` list of strings of the labels to use at each angle.

If *labels* is *None*, the labels will be `fmt%angle`.

frac is the fraction of the polar axes radius at which to place the label (1 is the edge). e.g., 1.05 is outside the axes and 0.95 is inside the axes.

Return value is a list of tuples (*lines*, *labels*):

- *lines* are *Line2D* instances
- *labels* are *Text* instances.

Note that on input, the *labels* argument is a list of strings, and on output it is a list of *Text* instances.

Examples:

```
# set the locations of the radial gridlines and labels
lines, labels = thetagrids( range(45,360,90) )

# set the locations and labels of the radial gridlines and labels
lines, labels = thetagrids( range(45,360,90), ('NE', 'NW', 'SW', 'SE') )
```

`matplotlib.pyplot.tick_params`(*axis*='both', ***kwargs*)

Change the appearance of ticks and tick labels.

Parameters axis : {'x', 'y', 'both'}, optional

Which axis to apply the parameters to.

Other Parameters axis : {'x', 'y', 'both'}

Axis on which to operate; default is 'both'.

reset : bool

If *True*, set all parameters to defaults before processing other keyword arguments. Default is *False*.

which : {'major', 'minor', 'both'}

Default is 'major'; apply arguments to *which* ticks.

direction : {'in', 'out', 'inout'}

Puts ticks inside the axes, outside the axes, or both.

length : float

Tick length in points.

width : float

Tick width in points.

color : color

Tick color; accepts any mpl color spec.

pad : float

Distance in points between tick and label.

labelsize : float or str

Tick label font size in points or as a string (e.g., 'large').

labelcolor : color

Tick label color; mpl color spec.

colors : color

Changes the tick color and the label color to the same value: mpl color spec.

zorder : float

Tick and label zorder.

bottom, top, left, right : bool or {'on', 'off'}

controls whether to draw the respective ticks.

labelbottom, labeltop, labelleft, labelright : bool or {'on', 'off'}

controls whether to draw the respective tick labels.

Examples

Usage

```
ax.tick_params(direction='out', length=6, width=2, colors='r')
```

This will make all major ticks be red, pointing out of the box, and with dimensions 6 points by 2 points. Tick labels will also be red.

`matplotlib.pyplot.ticklabel_format(**kwargs)`

Change the *ScalarFormatter* used by default for linear axes.

Optional keyword arguments:

Key-word	Description
<i>style</i>	['sci' (or 'scientific') 'plain'] plain turns off scientific notation
<i>scilimits</i>	(m, n), pair of integers; if <i>style</i> is 'sci', scientific notation will be used for numbers outside the range 10^m :sup: to 10^n :sup:. Use (0,0) to include all numbers.
<i>use-Offset</i>	[True False offset]; if True, the offset will be calculated as needed; if False, no offset will be used; if a numeric offset is specified, it will be used.
<i>axis</i>	['x' 'y' 'both']
<i>use-Locale</i>	If True, format the number according to the current locale. This affects things such as the character used for the decimal separator. If False, use C-style (English) formatting. The default setting is controlled by the axes.formatter.use_locale rparam.

Only the major ticks are affected. If the method is called when the *ScalarFormatter* is not the *Formatter* being used, an *AttributeError* will be raised.

`matplotlib.pyplot.tight_layout(pad=1.08, h_pad=None, w_pad=None, rect=None)`

Automatically adjust subplot parameters to give specified padding.

Parameters:

pad [float] padding between the figure edge and the edges of subplots, as a fraction of the font-size.

h_pad, w_pad [float] padding (height/width) between edges of adjacent subplots. Defaults to `pad_inches`.

rect [if rect is given, it is interpreted as a rectangle] (left, bottom, right, top) in the normalized figure coordinate that the whole subplots area (including labels) will fit into. Default is (0, 0, 1, 1).

`matplotlib.pyplot.title(s, *args, **kwargs)`

Set a title of the current axes.

Set one of the three available axes titles. The available titles are positioned above the axes in the center, flush with the left edge, and flush with the right edge.

See also:

See `text()` for adding text to the current axes

Parameters label : str

Text to use for the title

fontdict : dict

A dictionary controlling the appearance of the title text, the default `fontdict` is:

```
{'fontsize': rcParams['axes.titlesize'], 'fontweight' : rc-
Params['axes.titleweight'], 'verticalalignment': 'baseline', 'hori-
zontalalignment': loc}
```

loc : {'center', 'left', 'right'}, str, optional

Which title to set, defaults to 'center'

Returns text : *Text*

The matplotlib text instance representing the title

Other Parameters kwargs : text properties

Other keyword arguments are text properties, see *Text* for a list of valid text properties.

`matplotlib.pyplot.tricontour(*args, **kwargs)`

Draw contours on an unstructured triangular grid. *tricontour()* and *tricontourf()* draw contour lines and filled contours, respectively. Except as noted, function signatures and return values are the same for both versions.

The triangulation can be specified in one of two ways; either:

```
tricontour(triangulation, ...)
```

where triangulation is a *matplotlib.tri.Triangulation* object, or

```
tricontour(x, y, ...)
tricontour(x, y, triangles, ...)
tricontour(x, y, triangles=triangles, ...)
tricontour(x, y, mask=mask, ...)
tricontour(x, y, triangles, mask=mask, ...)
```

in which case a Triangulation object will be created. See *Triangulation* for an explanation of these possibilities.

The remaining arguments may be:

```
tricontour(..., Z)
```

where *Z* is the array of values to contour, one per point in the triangulation. The level values are chosen automatically.

```
tricontour(..., Z, N)
```

contour *N* automatically-chosen levels.

```
tricontour(..., Z, V)
```

draw contour lines at the values specified in sequence *V*, which must be in increasing order.

```
tricontourf(..., Z, V)
```

fill the $(\text{len}(V)-1)$ regions between the values in *V*, which must be in increasing order.

```
tricontour(Z, **kwargs)
```

Use keyword args to control colors, linewidth, origin, cmap ... see below for more details.

`C = tricontour(...)` returns a `TriContourSet` object.

Optional keyword arguments:

colors: [*None* | **string** | (**mpl_colors**)] If *None*, the colormap specified by `cmap` will be used.

If a string, like 'r' or 'red', all levels will be plotted in this color.

If a tuple of matplotlib color args (string, float, rgb, etc), different levels will be plotted in different colors in the order specified.

alpha: **float** The alpha blending value

cmap: [*None* | **Colormap**] A cm [Colormap](#) instance or *None*. If `cmap` is *None* and `colors` is *None*, a default `Colormap` is used.

norm: [*None* | **Normalize**] A [matplotlib.colors.Normalize](#) instance for scaling data values to colors. If `norm` is *None* and `colors` is *None*, the default linear scaling is used.

levels [**level0**, **level1**, ..., **leveln**] A list of floating point numbers indicating the level curves to draw, in increasing order; e.g., to draw just the zero contour pass `levels=[0]`

origin: [*None* | 'upper' | 'lower' | 'image'] If *None*, the first value of `Z` will correspond to the lower left corner, location (0,0). If 'image', the rc value for `image.origin` will be used.

This keyword is not active if `X` and `Y` are specified in the call to `contour`.

extent: [*None* | (`x0,x1,y0,y1`)]

If `origin` is not *None*, then `extent` is interpreted as in [matplotlib.pyplot.imshow\(\)](#): it gives the outer pixel boundaries. In this case, the position of `Z[0,0]` is the center of the pixel, not a corner. If `origin` is *None*, then (`x0`, `y0`) is the position of `Z[0,0]`, and (`x1`, `y1`) is the position of `Z[-1,-1]`.

This keyword is not active if `X` and `Y` are specified in the call to `contour`.

locator: [*None* | **ticker.Locator subclass**] If `locator` is *None*, the default [MaxNLocator](#) is used. The locator is used to determine the contour levels if they are not given explicitly via the `V` argument.

extend: ['neither' | 'both' | 'min' | 'max'] Unless this is 'neither', contour levels are automatically added to one or both ends of the range so that all data are included. These added ranges are then mapped to the special colormap values which default to the ends of the colormap range, but can be set via [matplotlib.colors.Colormap.set_under\(\)](#) and [matplotlib.colors.Colormap.set_over\(\)](#) methods.

xunits, yunits: [*None* | **registered units**] Override axis units by specifying an instance of a [matplotlib.units.ConversionInterface](#).

tricontour-only keyword arguments:

linewidths: [*None* | **number** | **tuple of numbers**] If `linewidths` is *None*, the default width in `lines.linewidth` in `matplotlibrc` is used.

If a number, all levels will be plotted with this linewidth.

If a tuple, different levels will be plotted with different linewidths in the order specified

linestyles: [*None* | **'solid'** | **'dashed'** | **'dashdot'** | **'dotted'**] If *linestyles* is *None*, the **'solid'** is used.

linestyles can also be an iterable of the above strings specifying a set of linestyles to be used. If this iterable is shorter than the number of contour levels it will be repeated as necessary.

If contour is using a monochrome colormap and the contour level is less than 0, then the linestyle specified in `contour.negative_linestyle` in `matplotlibrc` will be used.

tricontourf-only keyword arguments:

antialiased: [*True* | *False*] enable antialiasing

Note: tricontourf fills intervals that are closed at the top; that is, for boundaries $z1$ and $z2$, the filled region is:

$z1 < z \leq z2$

There is one exception: if the lowest boundary coincides with the minimum value of the z array, then that minimum value will be included in the lowest interval.

Examples:

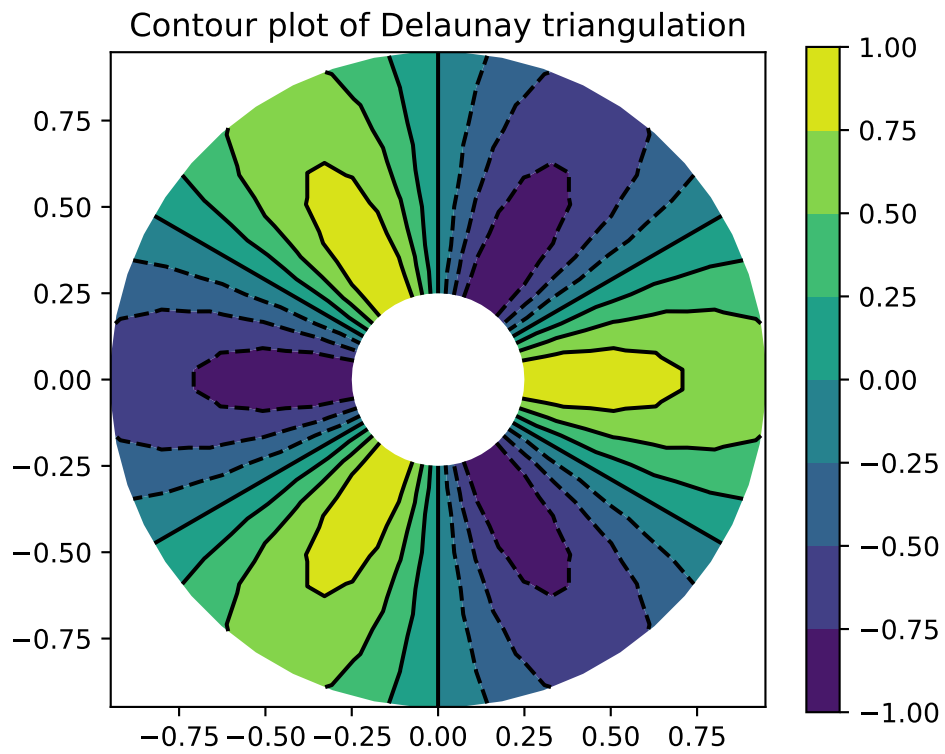

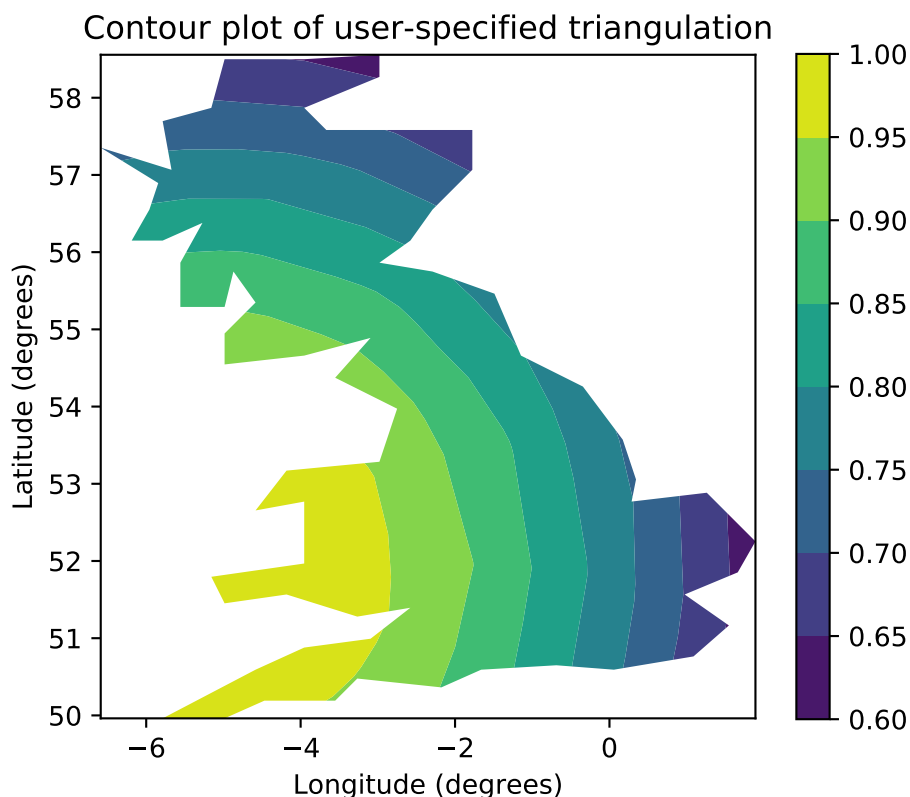

`matplotlib.pyplot.tricontourf(*args, **kwargs)`

Draw contours on an unstructured triangular grid. `tricontour()` and `tricontourf()` draw contour lines and filled contours, respectively. Except as noted, function signatures and return values are the same for both versions.

The triangulation can be specified in one of two ways; either:

```
tricontour(triangulation, ...)
```

where `triangulation` is a `matplotlib.tri.Triangulation` object, or

```
tricontour(x, y, ...)
tricontour(x, y, triangles, ...)
tricontour(x, y, triangles=triangles, ...)
tricontour(x, y, mask=mask, ...)
tricontour(x, y, triangles, mask=mask, ...)
```

in which case a `Triangulation` object will be created. See [Triangulation](#) for an explanation of these possibilities.

The remaining arguments may be:

```
tricontour(..., Z)
```

where `Z` is the array of values to contour, one per point in the triangulation. The level values are chosen automatically.

```
tricontour(..., Z, N)
```

contour N automatically-chosen levels.

```
tricontour(..., Z, V)
```

draw contour lines at the values specified in sequence V , which must be in increasing order.

```
tricontourf(..., Z, V)
```

fill the $(\text{len}(V)-1)$ regions between the values in V , which must be in increasing order.

```
tricontour(Z, **kwargs)
```

Use keyword args to control colors, linewidth, origin, cmap ... see below for more details.

$C = \text{tricontour}(\dots)$ returns a `TriContourSet` object.

Optional keyword arguments:

colors: [*None* | **string** | (**mpl_colors**)] If *None*, the colormap specified by `cmap` will be used.

If a string, like 'r' or 'red', all levels will be plotted in this color.

If a tuple of matplotlib color args (string, float, rgb, etc), different levels will be plotted in different colors in the order specified.

alpha: **float** The alpha blending value

cmap: [*None* | **Colormap**] A cm [Colormap](#) instance or *None*. If `cmap` is *None* and `colors` is *None*, a default Colormap is used.

norm: [*None* | **Normalize**] A [matplotlib.colors.Normalize](#) instance for scaling data values to colors. If `norm` is *None* and `colors` is *None*, the default linear scaling is used.

levels [**level0**, **level1**, ..., **leveln**] A list of floating point numbers indicating the level curves to draw, in increasing order; e.g., to draw just the zero contour pass `levels=[0]`

origin: [*None* | 'upper' | 'lower' | 'image'] If *None*, the first value of Z will correspond to the lower left corner, location (0,0). If 'image', the rc value for `image.origin` will be used.

This keyword is not active if X and Y are specified in the call to contour.

extent: [*None* | ($x0,x1,y0,y1$)]

If `origin` is not *None*, then `extent` is interpreted as in [matplotlib.pyplot.imshow\(\)](#): it gives the outer pixel boundaries. In this case, the position of $Z[0,0]$ is the center of the pixel, not a corner. If `origin` is *None*, then $(x0, y0)$ is the position of $Z[0,0]$, and $(x1, y1)$ is the position of $Z[-1,-1]$.

This keyword is not active if X and Y are specified in the call to contour.

locator: [*None* | `ticker.Locator` subclass] If *locator* is *None*, the default `MaxNLocator` is used. The locator is used to determine the contour levels if they are not given explicitly via the *V* argument.

extend: [`'neither'` | `'both'` | `'min'` | `'max'`] Unless this is `'neither'`, contour levels are automatically added to one or both ends of the range so that all data are included. These added ranges are then mapped to the special colormap values which default to the ends of the colormap range, but can be set via `matplotlib.colors.Colormap.set_under()` and `matplotlib.colors.Colormap.set_over()` methods.

xunits, yunits: [*None* | registered units] Override axis units by specifying an instance of a `matplotlib.units.ConversionInterface`.

tricontour-only keyword arguments:

linewidths: [*None* | number | tuple of numbers] If *linewidths* is *None*, the default width in `lines.linewidth` in `matplotlibrc` is used.

If a number, all levels will be plotted with this linewidth.

If a tuple, different levels will be plotted with different linewidths in the order specified

linestyles: [*None* | `'solid'` | `'dashed'` | `'dashdot'` | `'dotted'`] If *linestyles* is *None*, the `'solid'` is used.

linestyles can also be an iterable of the above strings specifying a set of linestyles to be used. If this iterable is shorter than the number of contour levels it will be repeated as necessary.

If `contour` is using a monochrome colormap and the contour level is less than 0, then the linestyle specified in `contour.negative_linestyle` in `matplotlibrc` will be used.

tricontourf-only keyword arguments:

antialiased: [*True* | *False*] enable antialiasing

Note: `tricontourf` fills intervals that are closed at the top; that is, for boundaries $z1$ and $z2$, the filled region is:

$$z1 < z \leq z2$$

There is one exception: if the lowest boundary coincides with the minimum value of the z array, then that minimum value will be included in the lowest interval.

Examples:

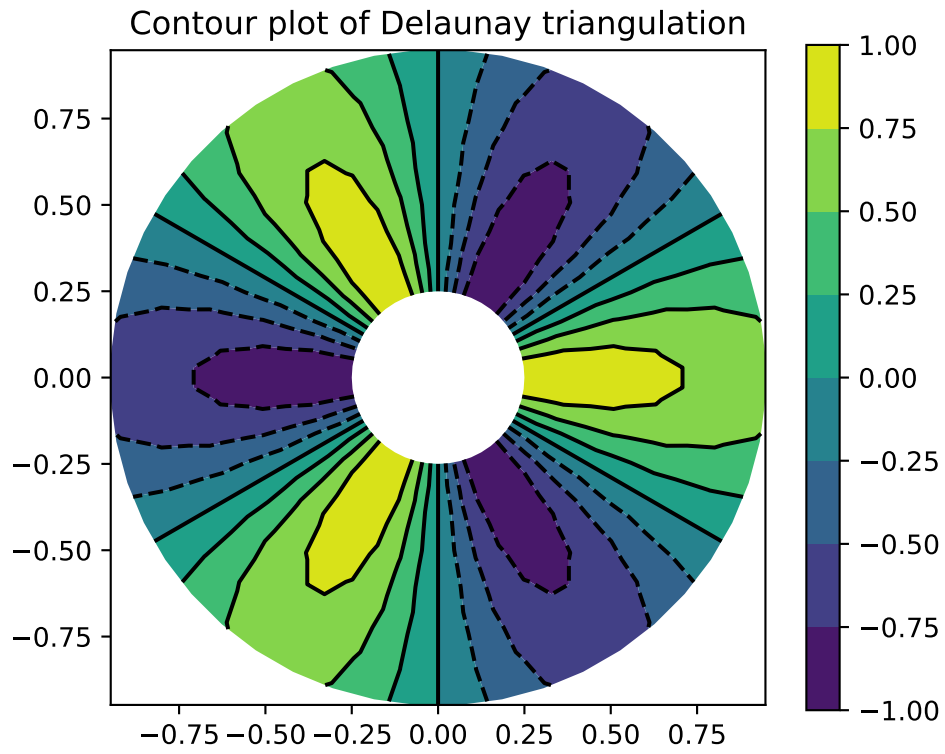

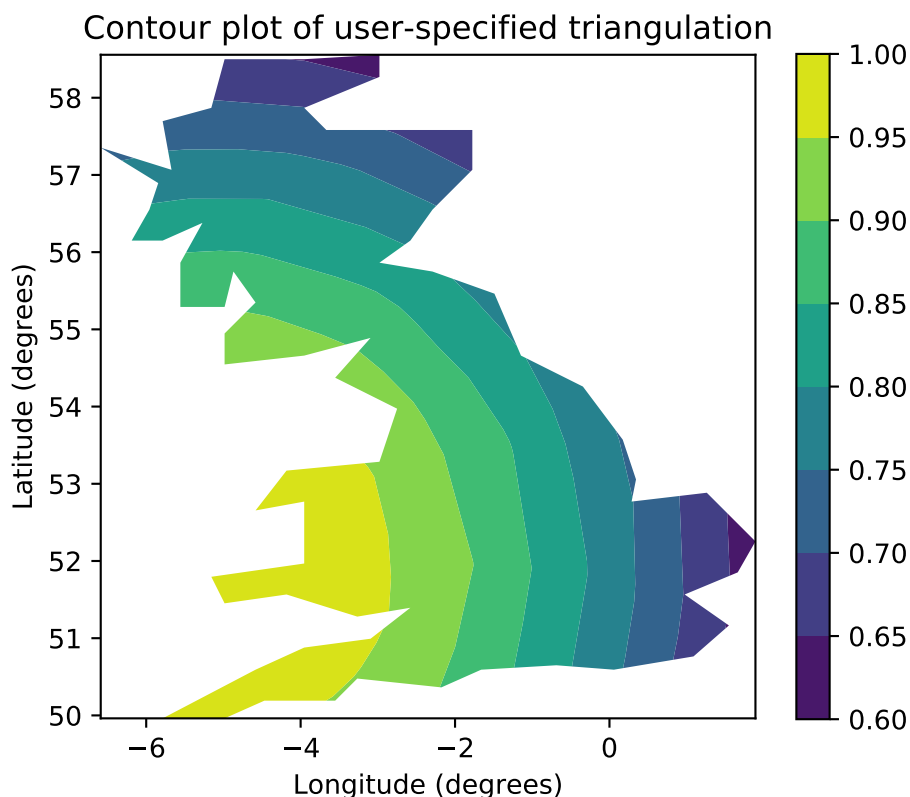

`matplotlib.pyplot.tripcolor(*args, **kwargs)`

Create a pseudocolor plot of an unstructured triangular grid.

The triangulation can be specified in one of two ways; either:

```
tripcolor(triangulation, ...)
```

where `triangulation` is a `matplotlib.tri.Triangulation` object, or

```
tripcolor(x, y, ...)
tripcolor(x, y, triangles, ...)
tripcolor(x, y, triangles=triangles, ...)
tripcolor(x, y, mask=mask, ...)
tripcolor(x, y, triangles, mask=mask, ...)
```

in which case a `Triangulation` object will be created. See [Triangulation](#) for a explanation of these possibilities.

The next argument must be `C`, the array of color values, either one per point in the triangulation if color values are defined at points, or one per triangle in the triangulation if color values are defined at triangles. If there are the same number of points and triangles in the triangulation it is assumed that color values are defined at points; to force the use of color values at triangles use the kwarg `facecolors*=C` instead of just `*C`.

`shading` may be ‘flat’ (the default) or ‘gouraud’. If `shading` is ‘flat’ and `C` values are defined at points, the color values used for each triangle are from the mean `C` of the triangle’s three points. If `shading`

is 'gouraud' then color values must be defined at points.

The remaining kwargs are the same as for `pcolor()`.

Example:

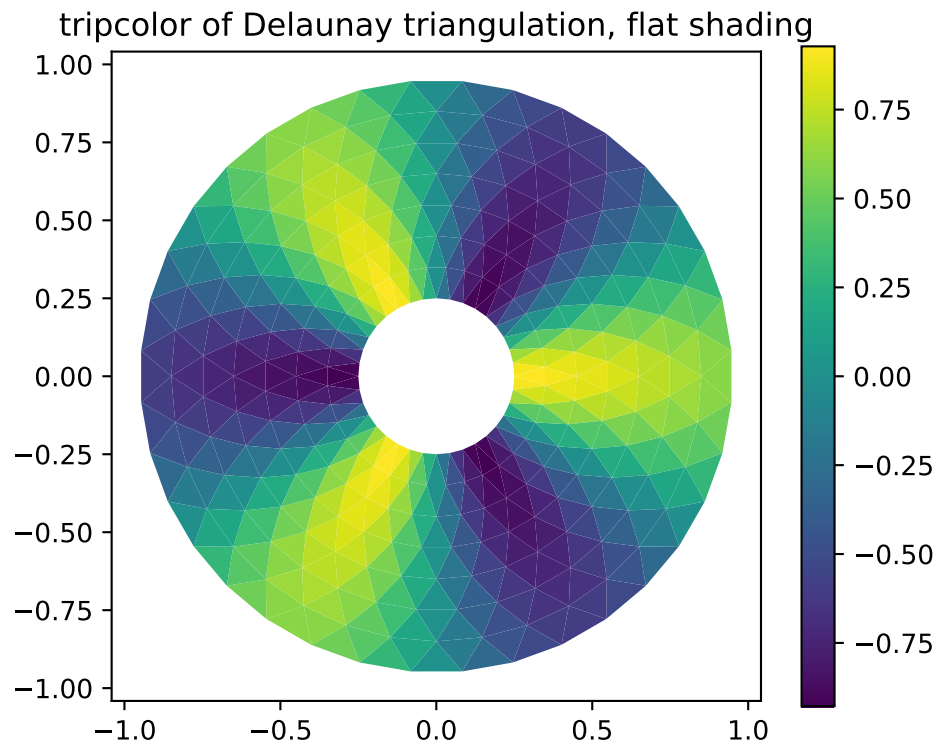

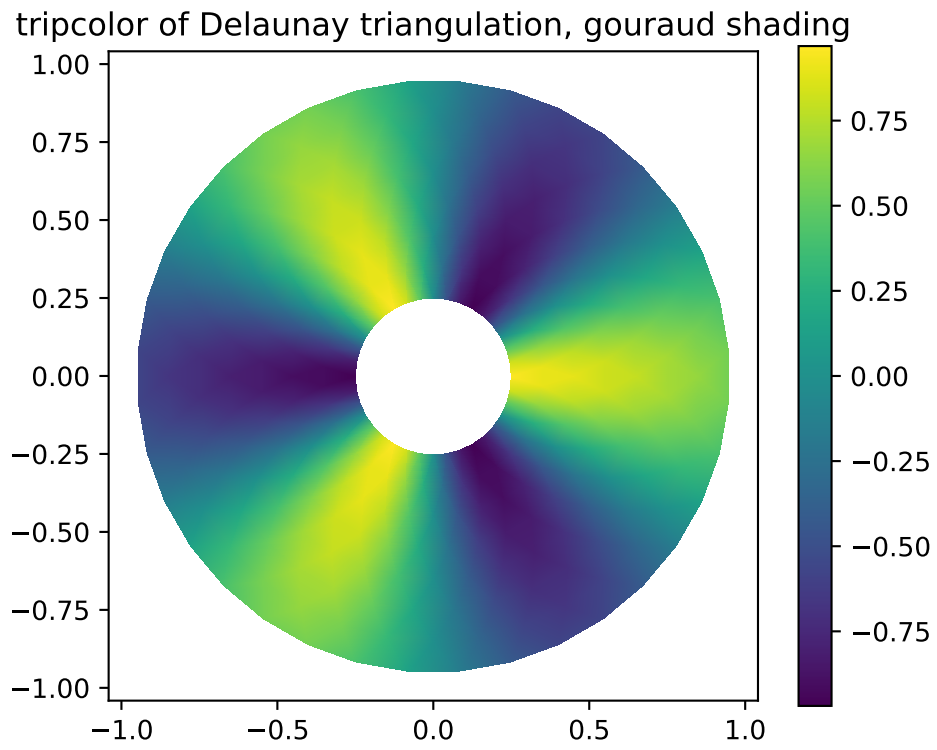

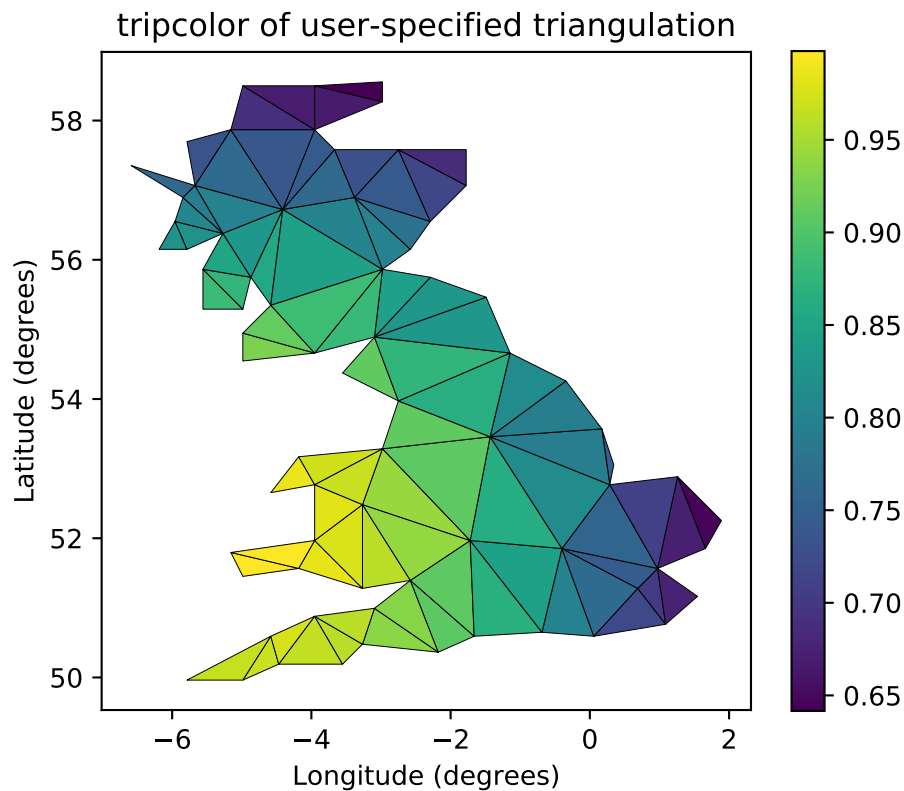

`matplotlib.pyplot.triplot(*args, **kwargs)`

Draw a unstructured triangular grid as lines and/or markers.

The triangulation to plot can be specified in one of two ways; either:

```
triplot(triangulation, ...)
```

where `triangulation` is a `matplotlib.tri.Triangulation` object, or

```
triplot(x, y, ...)
triplot(x, y, triangles, ...)
triplot(x, y, triangles=triangles, ...)
triplot(x, y, mask=mask, ...)
triplot(x, y, triangles, mask=mask, ...)
```

in which case a `Triangulation` object will be created. See [Triangulation](#) for an explanation of these possibilities.

The remaining args and kwargs are the same as for `plot()`.

Return a list of 2 `Line2D` containing respectively:

- the lines plotted for triangles edges
- the markers plotted for triangles nodes

Example:

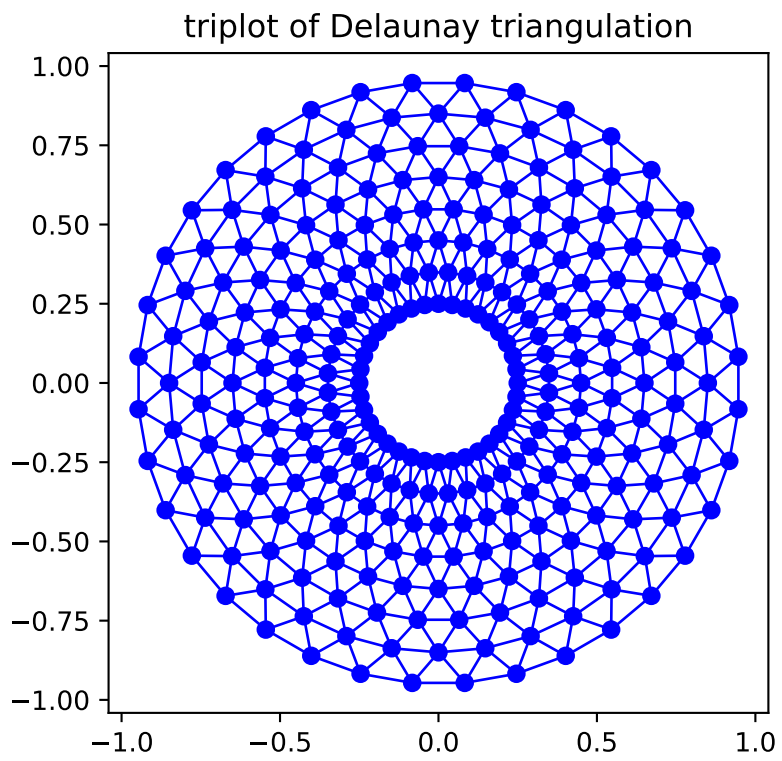

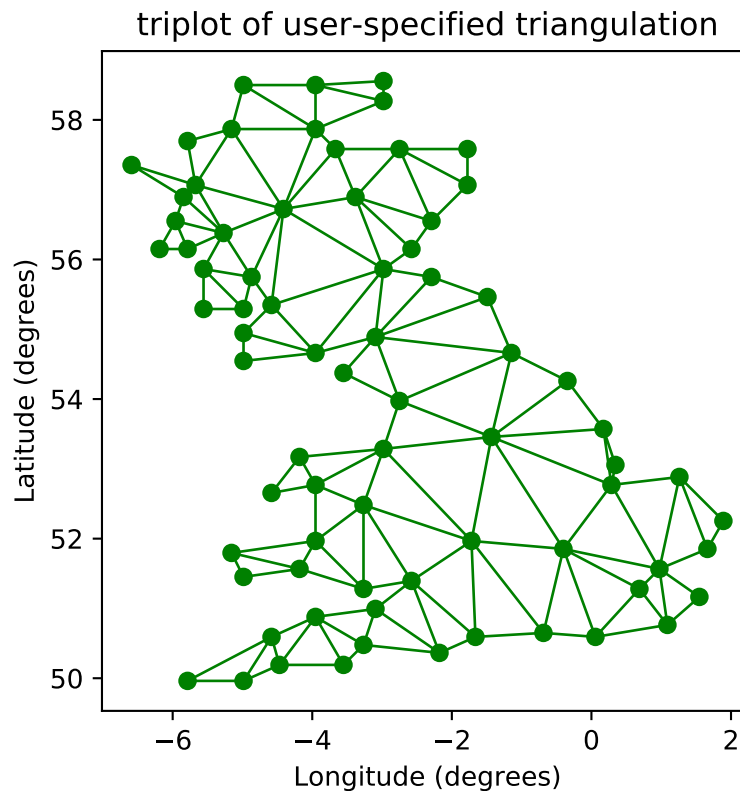

`matplotlib.pyplot.twinx`(*ax=None*)

Make a second axes that shares the *x*-axis. The new axes will overlay *ax* (or the current axes if *ax* is *None*). The ticks for *ax2* will be placed on the right, and the *ax2* instance is returned.

See also:

`examples/api_examples/two_scales.py` For an example

`matplotlib.pyplot.twinx`(*ax=None*)

Make a second axes that shares the *y*-axis. The new axis will overlay *ax* (or the current axes if *ax* is *None*). The ticks for *ax2* will be placed on the top, and the *ax2* instance is returned.

`matplotlib.pyplot.uninstall_repl_displayhook`()

Uninstalls the matplotlib display hook.

`matplotlib.pyplot.violinplot`(*dataset*, *positions=None*, *vert=True*, *widths=0.5*, *showmeans=False*, *showextrema=True*, *showmedians=False*, *points=100*, *bw_method=None*, *hold=None*, *data=None*)

Make a violin plot.

Make a violin plot for each column of *dataset* or each vector in sequence *dataset*. Each filled area extends to represent the entire data range, with optional lines at the mean, the median, the minimum, and the maximum.

Parameters *dataset* : Array or a sequence of vectors.

The input data.

positions : array-like, default = [1, 2, ..., n]

Sets the positions of the violins. The ticks and limits are automatically set to match the positions.

vert : bool, default = True.

If true, creates a vertical violin plot. Otherwise, creates a horizontal violin plot.

widths : array-like, default = 0.5

Either a scalar or a vector that sets the maximal width of each violin. The default is 0.5, which uses about half of the available horizontal space.

showmeans : bool, default = False

If True, will toggle rendering of the means.

showextrema : bool, default = True

If True, will toggle rendering of the extrema.

showmedians : bool, default = False

If True, will toggle rendering of the medians.

points : scalar, default = 100

Defines the number of points to evaluate each of the gaussian kernel density estimations at.

bw_method : str, scalar or callable, optional

The method used to calculate the estimator bandwidth. This can be 'scott', 'silverman', a scalar constant or a callable. If a scalar, this will be used directly as `kde.factor`. If a callable, it should take a `GaussianKDE` instance as its only parameter and return a scalar. If None (default), 'scott' is used.

Returns result : dict

A dictionary mapping each component of the violinplot to a list of the corresponding collection instances created. The dictionary has the following keys:

- **bodies**: A list of the `matplotlib.collections.PolyCollection` instances containing the filled area of each violin.
- **cmeans**: A `matplotlib.collections.LineCollection` instance created to identify the mean values of each of the violin's distribution.
- **cmmins**: A `matplotlib.collections.LineCollection` instance created to identify the bottom of each violin's distribution.
- **cmaxes**: A `matplotlib.collections.LineCollection` instance created to identify the top of each violin's distribution.

- **cbars**: A `matplotlib.collections.LineCollection` instance created to identify the centers of each violin's distribution.
- **cmedians**: A `matplotlib.collections.LineCollection` instance created to identify the median values of each of the violin's distribution.

Note: In addition to the above described arguments, this function can take a **data** keyword argument. If such a **data** argument is given, the following arguments are replaced by **data[<arg>]**:

- All arguments with the following names: 'dataset'.
-

`matplotlib.pyplot.viridis()`

set the default colormap to viridis and apply to current image if any. See `help(colormaps)` for more information

`matplotlib.pyplot.vlines(x, ymin, ymax, colors='k', linestyle='solid', label='', hold=None, data=None, **kwargs)`

Plot vertical lines.

Plot vertical lines at each `x` from `ymin` to `ymax`.

Parameters `x` : scalar or 1D array_like

x-indexes where to plot the lines.

ymin, ymax : scalar or 1D array_like

Respective beginning and end of each line. If scalars are provided, all lines will have same length.

colors : array_like of colors, optional, default: 'k'

linestyle : ['solid' | 'dashed' | 'dashdot' | 'dotted'], optional

label : string, optional, default: ''

Returns `lines` : `LineCollection`

Other Parameters `kwargs` : `LineCollection` properties.

See also:

[hlines](#) horizontal lines

Examples

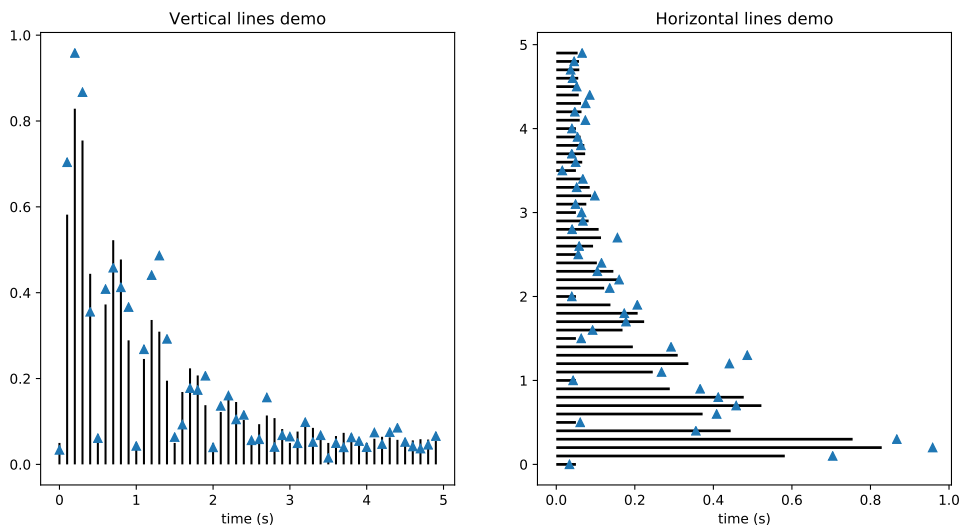

Note: In addition to the above described arguments, this function can take a **data** keyword argument. If such a **data** argument is given, the following arguments are replaced by **data[<arg>]**:

- All arguments with the following names: 'colors', 'x', 'ymax', 'ymin'.
-

`matplotlib.pyplot.waitforbuttonpress(*args, **kwargs)`

Blocking call to interact with the figure.

This will return True if a key was pressed, False if a mouse button was pressed and None if *timeout* was reached without either being pressed.

If *timeout* is negative, does not timeout.

`matplotlib.pyplot.winter()`

set the default colormap to winter and apply to current image if any. See `help(colormaps)` for more information

`matplotlib.pyplot.xcorr(x, y, normed=True, detrend=<function detrend_none>, usev-`
`lines=True, maxlags=10, hold=None, data=None, **kwargs)`

Plot the cross correlation between *x* and *y*.

The correlation with lag *k* is defined as $\sum_n x[n+k] * \text{conj}(y[n])$.

Parameters x : sequence of scalars of length *n*

y : sequence of scalars of length *n*

hold : boolean, optional, *deprecated*, default: True

detrend : callable, optional, default: `mlab.detrend_none`

x is detrended by the `detrend` callable. Default is no normalization.

normed : boolean, optional, default: True

if True, input vectors are normalised to unit length.

usevlines : boolean, optional, default: True

if True, Axes.vlines is used to plot the vertical lines from the origin to the acorr. Otherwise, Axes.plot is used.

maxlags : integer, optional, default: 10

number of lags to show. If None, will return all $2 * \text{len}(x) - 1$ lags.

Returns (lags, c, line, b) : where:

- lags are a length $2 * \text{maxlags} + 1$ lag vector.
- c is the $2 * \text{maxlags} + 1$ auto correlation vector
- line is a *Line2D* instance returned by *plot*.
- b is the x-axis (none, if plot is used).

Other Parameters linestyle : *Line2D* prop, optional, default: None

Only used if usevlines is False.

marker : string, optional, default: 'o'

Notes

The cross correlation is performed with `numpy.correlate()` with `mode = 2`.

Note: In addition to the above described arguments, this function can take a **data** keyword argument. If such a **data** argument is given, the following arguments are replaced by **data[<arg>]**:

- All arguments with the following names: 'x', 'y'.
-

`matplotlib.pyplot.xkcd(scale=1, length=100, randomness=2)`

Turns on *xkcd* sketch-style drawing mode. This will only have effect on things drawn after this function is called.

For best results, the “Humor Sans” font should be installed: it is not included with matplotlib.

Parameters scale : float, optional

The amplitude of the wiggle perpendicular to the source line.

length : float, optional

The length of the wiggle along the line.

randomness : float, optional

The scale factor by which the length is shrunken or expanded.

Notes

This function works by a number of rcParams, so it will probably override others you have set before.

If you want the effects of this function to be temporary, it can be used as a context manager, for example:

```
with plt.xkcd():
    # This figure will be in XKCD-style
    fig1 = plt.figure()
    # ...

# This figure will be in regular style
fig2 = plt.figure()
```

matplotlib.pyplot.**xlabel**(*s*, *args, **kwargs)

Set the *x* axis label of the current axis.

Default override is:

```
override = {
    'fontsize'           : 'small',
    'verticalalignment'  : 'top',
    'horizontalalignment': 'center'
}
```

See also:

text() For information on how override and the optional args work

matplotlib.pyplot.**xlim**(*args, **kwargs)

Get or set the *x* limits of the current axes.

```
xmin, xmax = xlim() # return the current xlim
xlim( (xmin, xmax) ) # set the xlim to xmin, xmax
xlim( xmin, xmax ) # set the xlim to xmin, xmax
```

If you do not specify args, you can pass the xmin and xmax as kwargs, e.g.:

```
xlim(xmax=3) # adjust the max leaving min unchanged
xlim(xmin=1) # adjust the min leaving max unchanged
```

Setting limits turns autoscaling off for the *x*-axis.

The new axis limits are returned as a length 2 tuple.

matplotlib.pyplot.**xscale**(*args, **kwargs)

Set the scaling of the *x*-axis.

call signature:

```
xscale(scale, **kwargs)
```

The available scales are: 'linear' | 'log' | 'logit' | 'symlog'

Different keywords may be accepted, depending on the scale:

'linear'

'log'

basex/basey: The base of the logarithm

nonposx/nonposy: ['mask' | 'clip'] non-positive values in x or y can be masked as invalid, or clipped to a very small positive number

subsx/subsy: Where to place the subticks between each major tick. Should be a sequence of integers. For example, in a log10 scale: [2, 3, 4, 5, 6, 7, 8, 9]

will place 8 logarithmically spaced minor ticks between each major tick.

'logit'

nonpos: ['mask' | 'clip'] values beyond]0, 1[can be masked as invalid, or clipped to a number very close to 0 or 1

'symlog'

basex/basey: The base of the logarithm

linthreshx/linthreshy: The range $(-x, x)$ within which the plot is linear (to avoid having the plot go to infinity around zero).

subsx/subsy: Where to place the subticks between each major tick. Should be a sequence of integers. For example, in a log10 scale: [2, 3, 4, 5, 6, 7, 8, 9]

will place 8 logarithmically spaced minor ticks between each major tick.

linscalex/linscaley: This allows the linear range $(-linthresh$ to $linthresh)$ to be stretched relative to the logarithmic range. Its value is the number of decades to use for each half of the linear range. For example, when `linscale == 1.0` (the default), the space used for the positive and negative halves of the linear range will be equal to one decade in the logarithmic range.

`matplotlib.pyplot.xticks(*args, **kwargs)`

Get or set the x -limits of the current tick locations and labels.

```
# return locs, labels where locs is an array of tick locations and
# labels is an array of tick labels.
locs, labels = xticks()

# set the locations of the xticks
xticks( arange(6) )

# set the locations and labels of the xticks
xticks( arange(5), ('Tom', 'Dick', 'Harry', 'Sally', 'Sue') )
```

The keyword args, if any, are *Text* properties. For example, to rotate long labels:

```
xticks( arange(12), calendar.month_name[1:13], rotation=17 )
```

`matplotlib.pyplot.ylabel(s, *args, **kwargs)`

Set the y axis label of the current axis.

Defaults override is:

```
override = {
    'fontsize'      : 'small',
    'verticalalignment' : 'center',
    'horizontalalignment' : 'right',
    'rotation'='vertical' : }
```

See also:

`text()` For information on how override and the optional args work.

`matplotlib.pyplot.ylim(*args, **kwargs)`

Get or set the y-limits of the current axes.

```
ymin, ymax = ylim() # return the current ylim
ylim( (ymin, ymax) ) # set the ylim to ymin, ymax
ylim( ymin, ymax ) # set the ylim to ymin, ymax
```

If you do not specify args, you can pass the *ymin* and *ymax* as kwargs, e.g.:

```
ylim(ymax=3) # adjust the max leaving min unchanged
ylim(ymin=1) # adjust the min leaving max unchanged
```

Setting limits turns autoscaling off for the y-axis.

The new axis limits are returned as a length 2 tuple.

`matplotlib.pyplot.yscale(*args, **kwargs)`

Set the scaling of the y-axis.

call signature:

```
yscale(scale, **kwargs)
```

The available scales are: 'linear' | 'log' | 'logit' | 'symlog'

Different keywords may be accepted, depending on the scale:

'linear'

'log'

basex/basey: The base of the logarithm

nonposx/nonposy: ['mask' | 'clip'] non-positive values in *x* or *y* can be masked as invalid, or clipped to a very small positive number

subsx/subsy: Where to place the subticks between each major tick. Should be a sequence of integers. For example, in a log10 scale: [2, 3, 4, 5, 6, 7, 8, 9]

will place 8 logarithmically spaced minor ticks between each major tick.

‘logit’

nonpos: [‘mask’ | ‘clip’] values beyond]0, 1[can be masked as invalid, or clipped to a number very close to 0 or 1

‘symlog’

basex/basey: The base of the logarithm

linthreshx/linthreshy: The range $(-x, x)$ within which the plot is linear (to avoid having the plot go to infinity around zero).

subsx/subsy: Where to place the subticks between each major tick. Should be a sequence of integers. For example, in a log10 scale: [2, 3, 4, 5, 6, 7, 8, 9]

will place 8 logarithmically spaced minor ticks between each major tick.

linscalex/linscaley: This allows the linear range $(-linthresh$ to $linthresh)$ to be stretched relative to the logarithmic range. Its value is the number of decades to use for each half of the linear range. For example, when `linscale == 1.0` (the default), the space used for the positive and negative halves of the linear range will be equal to one decade in the logarithmic range.

`matplotlib.pyplot.yticks(*args, **kwargs)`

Get or set the y-limits of the current tick locations and labels.

```
# return locs, labels where locs is an array of tick locations and
# labels is an array of tick labels.
locs, labels = yticks()

# set the locations of the yticks
yticks( arange(6) )

# set the locations and labels of the yticks
yticks( arange(5), ('Tom', 'Dick', 'Harry', 'Sally', 'Sue') )
```

The keyword args, if any, are *Text* properties. For example, to rotate long labels:

```
yticks( arange(12), calendar.month_name[1:13], rotation=45 )
```

46.1 matplotlib.rcsetup

The rcsetup module contains the default values and the validation code for customization using matplotlib's rc settings.

Each rc setting is assigned a default value and a function used to validate any attempted changes to that setting. The default values and validation functions are defined in the rcsetup module, and are used to construct the rcParams global object which stores the settings and is referenced throughout matplotlib.

These default values should be consistent with the default matplotlibrc file that actually reflects the values given here. Any additions or deletions to the parameter set listed here should also be visited to the matplotlibrc.template in matplotlib's root source directory.

class matplotlib.rcsetup.**ValidateInStrings**(*key, valid, ignorecase=False*)

Bases: object

valid is a list of legal strings

class matplotlib.rcsetup.**ValidateInterval**(*vmin, vmax, closedmin=True, closedmax=True*)

Bases: object

Value must be in interval

matplotlib.rcsetup.**cycler**(*args, **kwargs)

Creates a cycler.Cycler object much like cycler.cycler(), but includes input validation.

cycler(arg) cycler(label, itr) cycler(label1=itr1[, label2=itr2[, ...]])

Form 1 simply copies a given Cycler object.

Form 2 creates a Cycler from a label and an iterable.

Form 3 composes a Cycler as an inner product of the pairs of keyword arguments. In other words, all of the iterables are cycled simultaneously, as if through zip().

Parameters arg : Cycler

Copy constructor for Cycler.

label : name

The property key. Must be a valid `Artist` property. For example, ‘color’ or ‘linestyle’. Aliases are allowed, such as ‘c’ for ‘color’ and ‘lw’ for ‘linewidth’.

itr : iterable

Finite-length iterable of the property values. These values are validated and will raise a `ValueError` if invalid.

Returns cycler : `Cycler`

New `cycler.Cycler` for the given properties

`matplotlib.rcsetup.deprecate_axes_colorcycle(value)`

`matplotlib.rcsetup.deprecate_axes_hold(value)`

`matplotlib.rcsetup.deprecate_savefig_extension(value)`

`matplotlib.rcsetup.deprecate_svg_embed_char_paths(value)`

`matplotlib.rcsetup.deprecate_svg_image_noscale(value)`

`matplotlib.rcsetup.update_savefig_format(value)`

`matplotlib.rcsetup.validate_animation_writer_path(p)`

`matplotlib.rcsetup.validate_any(s)`

`matplotlib.rcsetup.validate_anylist(s)`

`matplotlib.rcsetup.validate_aspect(s)`

`matplotlib.rcsetup.validate_axisbelow(s)`

`matplotlib.rcsetup.validate_backend(s)`

`matplotlib.rcsetup.validate_bbox(s)`

`matplotlib.rcsetup.validate_bool(b)`

Convert `b` to a boolean or raise

`matplotlib.rcsetup.validate_bool_maybe_none(b)`

Convert `b` to a boolean or raise

`matplotlib.rcsetup.validate_capstylelist(s)`

`matplotlib.rcsetup.validate_color(s)`

return a valid color arg

`matplotlib.rcsetup.validate_color_for_prop_cycle(s)`

`matplotlib.rcsetup.validate_color_or_auto(s)`

`matplotlib.rcsetup.validate_color_or_inherit(s)`

return a valid color arg

`matplotlib.rcsetup.validate_colorlist(s)`

return a list of colorspecs

`matplotlib.rcsetup.validate_corner_mask(s)`

`matplotlib.rcsetup.validate_cycler(s)`

return a Cycler object from a string repr or the object itself

`matplotlib.rcsetup.validate_dashlist(s)`

`matplotlib.rcsetup.validate_dpi(s)`

confirm *s* is string 'figure' or convert *s* to float or raise

`matplotlib.rcsetup.validate_fillstylelist(s)`

`matplotlib.rcsetup.validate_float(s)`

convert *s* to float or raise

`matplotlib.rcsetup.validate_float_or_None(s)`

convert *s* to float, None or raise

`matplotlib.rcsetup.validate_floatlist(s)`

convert *s* to float or raise

`matplotlib.rcsetup.validate_font_properties(s)`

`matplotlib.rcsetup.validate_fontsize(s)`

`matplotlib.rcsetup.validate_fontsizelist(s)`

`matplotlib.rcsetup.validate_fonttype(s)`

confirm that this is a Postscript or PDF font type that we know how to convert to

`matplotlib.rcsetup.validate_hatch(s)`

Validate a hatch pattern. A hatch pattern string can have any sequence of the following characters: \ / | - + * . x o 0.

`matplotlib.rcsetup.validate_hatchlist(s)`

Validate a hatch pattern. A hatch pattern string can have any sequence of the following characters: \ / | - + * . x o 0.

`matplotlib.rcsetup.validate_hinting(s)`

`matplotlib.rcsetup.validate_hist_bins(s)`

`matplotlib.rcsetup.validate_int(s)`

convert s to int or raise

`matplotlib.rcsetup.validate_int_or_None(s)`

if not None, tries to validate as an int

`matplotlib.rcsetup.validate_joinstylelist(s)`

`matplotlib.rcsetup.validate_maskedarray(v)`

`matplotlib.rcsetup.validate_negative_linestyle_legacy(s)`

`class matplotlib.rcsetup.validate_nseq_float(n=None, allow_none=False)`

Bases: object

`class matplotlib.rcsetup.validate_nseq_int(n=None)`

Bases: object

`matplotlib.rcsetup.validate_path_exists(s)`

If s is a path, return s, else False

`matplotlib.rcsetup.validate_ps_distiller(s)`

`matplotlib.rcsetup.validate_sketch(s)`

`matplotlib.rcsetup.validate_string_or_None(s)`

convert s to string or raise

`matplotlib.rcsetup.validate_stringlist(s)`

return a list

`matplotlib.rcsetup.validate_tkpythoninspect(s)`

`matplotlib.rcsetup.validate_toolbar(s)`

`matplotlib.rcsetup.validate_whiskers(s)`

47.1 matplotlib.sankey

Module for creating Sankey diagrams using matplotlib

class matplotlib.sankey.**Sankey**(*ax=None, scale=1.0, unit='', format='%G', gap=0.25, radius=0.1, shoulder=0.03, offset=0.15, head_angle=100, margin=0.4, tolerance=1e-06, **kwargs*)

Bases: object

Sankey diagram in matplotlib

Sankey diagrams are a specific type of flow diagram, in which the width of the arrows is shown proportionally to the flow quantity. They are typically used to visualize energy or material or cost transfers between processes. [Wikipedia \(6/1/2011\)](#)

Create a new Sankey instance.

Optional keyword arguments:

Field	Description
<i>ax</i>	axes onto which the data should be plotted If <i>ax</i> isn't provided, new axes will be created.
<i>scale</i>	scaling factor for the flows <i>scale</i> sizes the width of the paths in order to maintain proper layout. The same scale is applied to all subdiagrams. The value should be chosen such that the product of the scale and the sum of the inputs is approximately 1.0 (and the product of the scale and the sum of the outputs is approximately -1.0).
<i>unit</i>	string representing the physical unit associated with the flow quantities If <i>unit</i> is None, then none of the quantities are labeled.
<i>format</i>	a Python number formatting string to be used in labeling the flow as a quantity (i.e., a number times a unit, where the unit is given)
<i>gap</i>	space between paths that break in/break away to/from the top or bottom
<i>radius</i>	inner radius of the vertical paths
<i>shoulder</i>	size of the shoulders of output arrows
<i>offset</i>	text offset (from the dip or tip of the arrow)
<i>head_angle</i>	angle of the arrow heads (and negative of the angle of the tails) [deg]
<i>margin</i>	minimum space between Sankey outlines and the edge of the plot area
<i>tolerance</i>	acceptable maximum of the magnitude of the sum of flows The magnitude of the sum of connected flows cannot be greater than <i>tolerance</i> .

The optional arguments listed above are applied to all subdiagrams so that there is consistent alignment and formatting.

If *Sankey* is instantiated with any keyword arguments other than those explicitly listed above (****kwargs**), they will be passed to *add()*, which will create the first subdiagram.

In order to draw a complex Sankey diagram, create an instance of *Sankey* by calling it without any **kwargs**:

```
sankey = Sankey()
```

Then add simple Sankey sub-diagrams:

```
sankey.add() # 1
sankey.add() # 2
#...
sankey.add() # n
```

Finally, create the full diagram:

```
sankey.finish()
```

Or, instead, simply daisy-chain those calls:

```
Sankey().add().add... .add().finish()
```

See also:

`add()` `finish()`

Examples:

The default settings produce a diagram like this.

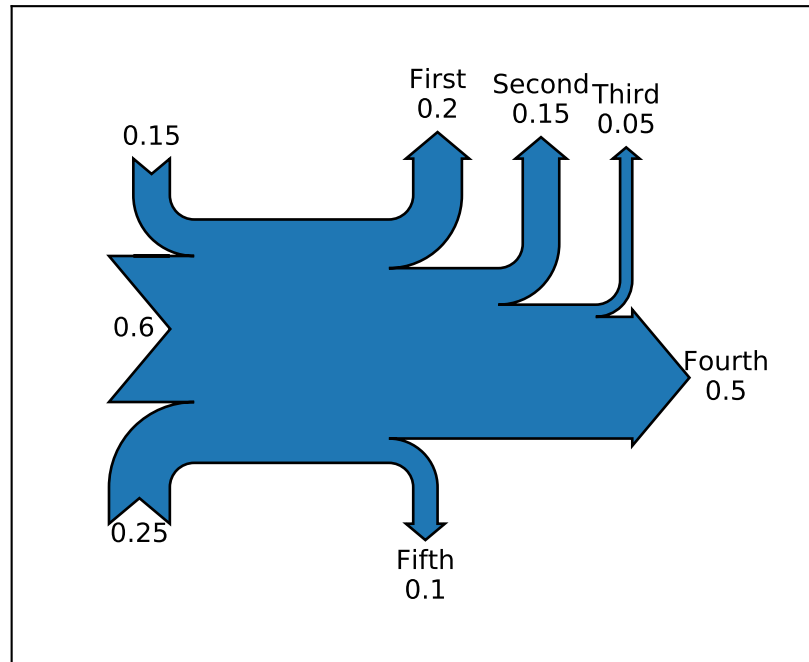

Flow Diagram of a Widget

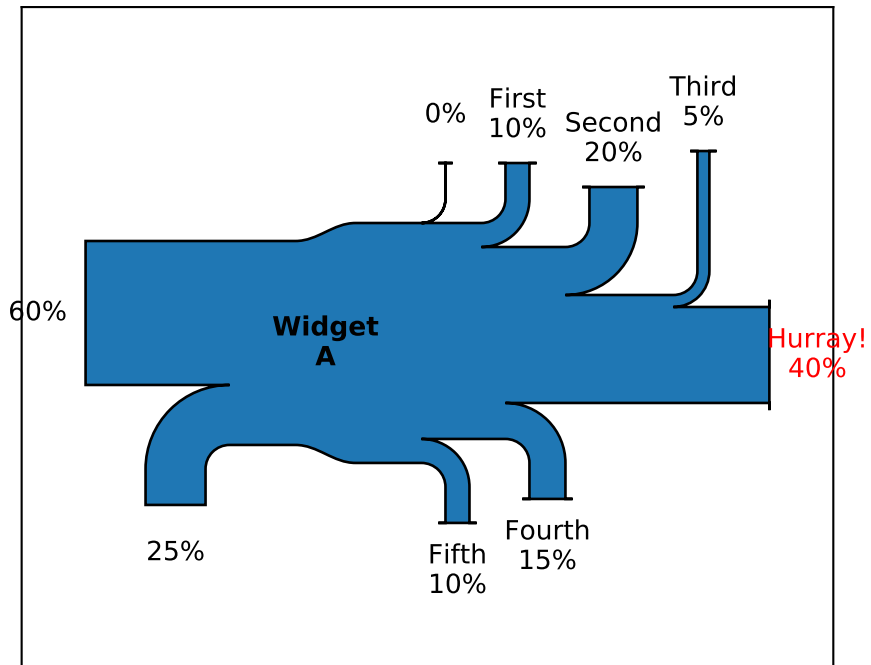

Two Systems

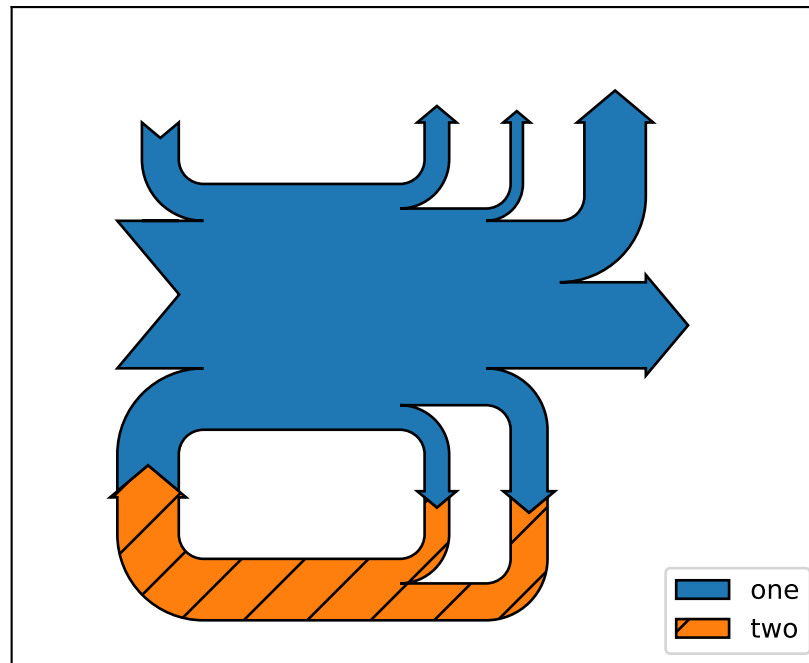

add(*patchlabel='', flows=None, orientations=None, labels='', trunklength=1.0, pathlengths=0.25, prior=None, connect=(0, 0), rotation=0, **kwargs*)
Add a simple Sankey diagram with flows at the same hierarchical level.

Return value is the instance of *Sankey*.

Optional keyword arguments:

Key-word	Description
<i>patch-label</i>	label to be placed at the center of the diagram Note: <i>label</i> (not <i>patchlabel</i>) will be passed to the patch through **kwargs and can be used to create an entry in the legend.
<i>flows</i>	array of flow values By convention, inputs are positive and outputs are negative.
<i>orientations</i>	list of orientations of the paths Valid values are 1 (from/to the top), 0 (from/to the left or right), or -1 (from/to the bottom). If <i>orientations</i> == 0, inputs will break in from the left and outputs will break away to the right.
<i>labels</i>	list of specifications of the labels for the flows Each value may be <i>None</i> (no labels), '' (just label the quantities), or a labeling string. If a single value is provided, it will be applied to all flows. If an entry is a non-empty string, then the quantity for the corresponding flow will be shown below the string. However, if the <i>unit</i> of the main diagram is <i>None</i> , then quantities are never shown, regardless of the value of this argument.
<i>trunk-length</i>	length between the bases of the input and output groups
<i>path-lengths</i>	list of lengths of the arrows before break-in or after break-away If a single value is given, then it will be applied to the first (inside) paths on the top and bottom, and the length of all other arrows will be justified accordingly. The <i>pathlengths</i> are not applied to the horizontal inputs and outputs.
<i>prior</i>	index of the prior diagram to which this diagram should be connected
<i>connect</i>	a (prior, this) tuple indexing the flow of the prior diagram and the flow of this diagram which should be connected If this is the first diagram or <i>prior</i> is <i>None</i> , <i>connect</i> will be ignored.
<i>rotation</i>	angle of rotation of the diagram [deg] <i>rotation</i> is ignored if this diagram is connected to an existing one (using <i>prior</i> and <i>connect</i>). The interpretation of the <i>orientations</i> argument will be rotated accordingly (e.g., if <i>rotation</i> == 90, an <i>orientations</i> entry of 1 means to/from the left).

Valid kwargs are `matplotlib.patches.PathPatch()` arguments:

Property	Description
<i>agg_filter</i>	unknown
<i>alpha</i>	float or <i>None</i>
<i>animated</i>	[True False]
<i>antialiased</i> or <i>aa</i>	[True False] or <i>None</i> for default
<i>axes</i>	an <i>Axes</i> instance
<i>capstyle</i>	['butt' 'round' 'projecting']
<i>clip_box</i>	a <code>matplotlib.transforms.Bbox</code> instance
<i>clip_on</i>	[True False]
<i>clip_path</i>	[(<i>Path</i> , <i>Transform</i>) <i>Patch</i> <i>None</i>]
<i>color</i>	matplotlib color spec
<i>contains</i>	a callable function
<i>edgecolor</i> or <i>ec</i>	mpl color spec, <i>None</i> , 'none', or 'auto'

Continued on

Table 47.1 – continued from previous page

Property	Description
<i>facecolor</i> or <i>fc</i>	mpl color spec, or None for default, or 'none' for no color
<i>figure</i>	a <i>matplotlib.figure.Figure</i> instance
<i>fill</i>	[True False]
<i>gid</i>	an id string
<i>hatch</i>	['/' '\' ' ' '-' '+' 'x' 'o' 'O' '.' '*']
<i>joinstyle</i>	['miter' 'round' 'bevel']
<i>label</i>	string or anything printable with '%s' conversion.
<i>linestyle</i> or <i>ls</i>	['solid' 'dashed', 'dashdot', 'dotted' (offset, on-off-dash-seq) '-' '--' '-.' ':' 'None']
<i>linewidth</i> or <i>lw</i>	float or None for default
<i>path_effects</i>	unknown
<i>picker</i>	[None float boolean callable]
<i>rasterized</i>	[True False None]
<i>sketch_params</i>	unknown
<i>snap</i>	unknown
<i>transform</i>	<i>Transform</i> instance
<i>url</i>	a url string
<i>visible</i>	[True False]
<i>zorder</i>	any number

As examples, `fill=False` and `label='A legend entry'`. By default, `facecolor='#bfd1d4'` (light blue) and `linewidth=0.5`.

The indexing parameters (*prior* and *connect*) are zero-based.

The flows are placed along the top of the diagram from the inside out in order of their index within the *flows* list or array. They are placed along the sides of the diagram from the top down and along the bottom from the outside in.

If the sum of the inputs and outputs is nonzero, the discrepancy will appear as a cubic Bezier curve along the top and bottom edges of the trunk.

See also:

finish()

finish()

Adjust the axes and return a list of information about the Sankey subdiagram(s).

Return value is a list of subdiagrams represented with the following fields:

Field	Description
<i>patch</i>	Sankey outline (an instance of <code>PathPatch</code>)
<i>flows</i>	values of the flows (positive for input, negative for output)
<i>angles</i>	list of angles of the arrows [deg/90] For example, if the diagram has not been rotated, an input to the top side will have an angle of 3 (DOWN), and an output from the top side will have an angle of 1 (UP). If a flow has been skipped (because its magnitude is less than <i>tolerance</i>), then its angle will be <i>None</i> .
<i>tips</i>	array in which each row is an [x, y] pair indicating the positions of the tips (or “dips”) of the flow paths If the magnitude of a flow is less the <i>tolerance</i> for the instance of <code>Sankey</code> , the flow is skipped and its tip will be at the center of the diagram.
<i>text</i>	<code>Text</code> instance for the label of the diagram
<i>texts</i>	list of <code>Text</code> instances for the labels of flows

See also:`add()`

48.1 matplotlib.scale

class matplotlib.scale.**InvertedLog10Transform**(*shorthand_name=None*)

Bases: *matplotlib.scale.InvertedLogTransformBase*

Creates a new TransformNode.

shorthand_name - a string representing the “name” of this transform. The name carries no significance other than to improve the readability of `str(transform)` when `DEBUG=True`.

base = 10.0

inverted()

class matplotlib.scale.**InvertedLog2Transform**(*shorthand_name=None*)

Bases: *matplotlib.scale.InvertedLogTransformBase*

Creates a new TransformNode.

shorthand_name - a string representing the “name” of this transform. The name carries no significance other than to improve the readability of `str(transform)` when `DEBUG=True`.

base = 2.0

inverted()

class matplotlib.scale.**InvertedLogTransform**(*base*)

Bases: *matplotlib.scale.InvertedLogTransformBase*

inverted()

class matplotlib.scale.**InvertedLogTransformBase**(*shorthand_name=None*)

Bases: *matplotlib.transforms.Transform*

Creates a new TransformNode.

shorthand_name - a string representing the “name” of this transform. The name carries no significance other than to improve the readability of `str(transform)` when `DEBUG=True`.

has_inverse = True

input_dims = 1

is_separable = True

output_dims = 1

transform_non_affine(*a*)

class `matplotlib.scale.InvertedNaturalLogTransform`(*shorthand_name=None*)

Bases: `matplotlib.scale.InvertedLogTransformBase`

Creates a new `TransformNode`.

shorthand_name - a string representing the “name” of this transform. The name carries no significance other than to improve the readability of `str(transform)` when `DEBUG=True`.

base = 2.718281828459045

inverted()

class `matplotlib.scale.InvertedSymmetricalLogTransform`(*base, linthresh, linscale*)

Bases: `matplotlib.transforms.Transform`

has_inverse = True

input_dims = 1

inverted()

is_separable = True

output_dims = 1

transform_non_affine(*a*)

class `matplotlib.scale.LinearScale`(*axis, **kwargs*)

Bases: `matplotlib.scale.ScaleBase`

The default linear scale.

get_transform()

The transform for linear scaling is just the *IdentityTransform*.

name = 'linear'

set_default_locators_and_formatters(*axis*)

Set the locators and formatters to reasonable defaults for linear scaling.

class matplotlib.scale.Log10Transform(*nonpos*)

Bases: *matplotlib.scale.LogTransformBase*

base = 10.0

inverted()

class matplotlib.scale.Log2Transform(*nonpos*)

Bases: *matplotlib.scale.LogTransformBase*

base = 2.0

inverted()

class matplotlib.scale.LogScale(*axis*, *kwargs*)**

Bases: *matplotlib.scale.ScaleBase*

A standard logarithmic scale. Care is taken so non-positive values are not plotted.

For computational efficiency (to push as much as possible to Numpy C code in the common cases), this scale provides different transforms depending on the base of the logarithm:

- base 10 (*Log10Transform*)
- base 2 (*Log2Transform*)
- base e (*NaturalLogTransform*)
- arbitrary base (*LogTransform*)

basex/basey: The base of the logarithm

nonposx/nonposy: ['mask' | 'clip'] non-positive values in *x* or *y* can be masked as invalid, or clipped to a very small positive number

subsx/subsy: Where to place the subticks between each major tick. Should be a sequence of integers. For example, in a log10 scale: [2, 3, 4, 5, 6, 7, 8, 9]

will place 8 logarithmically spaced minor ticks between each major tick.

class InvertedLog10Transform(*shorthand_name=None*)

Bases: *matplotlib.scale.InvertedLogTransformBase*

Creates a new TransformNode.

shorthand_name - a string representing the “name” of this transform. The name carries no significance other than to improve the readability of `str(transform)` when `DEBUG=True`.

base = 10.0

inverted()

class InvertedLog2Transform(*shorthand_name=None*)
Bases: *matplotlib.scale.InvertedLogTransformBase*

Creates a new TransformNode.

shorthand_name - a string representing the “name” of this transform. The name carries no significance other than to improve the readability of `str(transform)` when `DEBUG=True`.

base = 2.0

inverted()

class InvertedLogTransform(*base*)
Bases: *matplotlib.scale.InvertedLogTransformBase*

inverted()

class InvertedNaturalLogTransform(*shorthand_name=None*)
Bases: *matplotlib.scale.InvertedLogTransformBase*

Creates a new TransformNode.

shorthand_name - a string representing the “name” of this transform. The name carries no significance other than to improve the readability of `str(transform)` when `DEBUG=True`.

base = 2.718281828459045

inverted()

class Log10Transform(*nonpos*)
Bases: *matplotlib.scale.LogTransformBase*

base = 10.0

inverted()

class Log2Transform(*nonpos*)
Bases: *matplotlib.scale.LogTransformBase*

base = 2.0

inverted()

class LogTransform(*base, nonpos*)

Bases: *matplotlib.scale.LogTransformBase*

inverted()

class LogTransformBase(*nonpos*)

Bases: *matplotlib.transforms.Transform*

has_inverse = True

input_dims = 1

is_separable = True

output_dims = 1

transform_non_affine(*a*)

class NaturalLogTransform(*nonpos*)

Bases: *matplotlib.scale.LogTransformBase*

base = 2.718281828459045

inverted()

get_transform()

Return a *Transform* instance appropriate for the given logarithm base.

limit_range_for_scale(*vmin, vmax, minpos*)

Limit the domain to positive values.

name = 'log'

set_default_locators_and_formatters(*axis*)

Set the locators and formatters to specialized versions for log scaling.

class matplotlib.scale.LogTransform(*base, nonpos*)

Bases: *matplotlib.scale.LogTransformBase*

inverted()

class matplotlib.scale.**LogTransformBase**(*nonpos*)

Bases: *matplotlib.transforms.Transform*

has_inverse = True

input_dims = 1

is_separable = True

output_dims = 1

transform_non_affine(*a*)

class matplotlib.scale.**LogisticTransform**(*nonpos='mask'*)

Bases: *matplotlib.transforms.Transform*

has_inverse = True

input_dims = 1

inverted()

is_separable = True

output_dims = 1

transform_non_affine(*a*)

logistic transform (base 10)

class matplotlib.scale.**LogitScale**(*axis, nonpos='mask'*)

Bases: *matplotlib.scale.ScaleBase*

Logit scale for data between zero and one, both excluded.

This scale is similar to a log scale close to zero and to one, and almost linear around 0.5. It maps the interval]0, 1[onto]-infty, +infty[.

nonpos: [**'mask'** | **'clip'**] values beyond]0, 1[can be masked as invalid, or clipped to a number very close to 0 or 1

get_transform()

Return a *LogitTransform* instance.

limit_range_for_scale(*vmin, vmax, minpos*)

Limit the domain to values between 0 and 1 (excluded).

`name = 'logit'`

`set_default_locators_and_formatters(axis)`

`class matplotlib.scale.LogitTransform(nonpos)`

Bases: `matplotlib.transforms.Transform`

`has_inverse = True`

`input_dims = 1`

`inverted()`

`is_separable = True`

`output_dims = 1`

`transform_non_affine(a)`

logit transform (base 10), masked or clipped

`class matplotlib.scale.NaturalLogTransform(nonpos)`

Bases: `matplotlib.scale.LogTransformBase`

`base = 2.718281828459045`

`inverted()`

`class matplotlib.scale.ScaleBase`

Bases: `object`

The base class for all scales.

Scales are separable transformations, working on a single dimension.

Any subclasses will want to override:

- `name`
- `get_transform()`
- `set_default_locators_and_formatters()`

And optionally:

- `limit_range_for_scale()`

`get_transform()`

Return the `Transform` object associated with this scale.

limit_range_for_scale(*vmin*, *vmax*, *minpos*)

Returns the range *vmin*, *vmax*, possibly limited to the domain supported by this scale.

***minpos* should be the minimum positive value in the data.** This is used by log scales to determine a minimum value.

set_default_locators_and_formatters(*axis*)

Set the *Locator* and *Formatter* objects on the given axis to match this scale.

class matplotlib.scale.SymmetricalLogScale(*axis*, ***kwargs*)

Bases: [matplotlib.scale.ScaleBase](#)

The symmetrical logarithmic scale is logarithmic in both the positive and negative directions from the origin.

Since the values close to zero tend toward infinity, there is a need to have a range around zero that is linear. The parameter *linthresh* allows the user to specify the size of this range (*-linthresh*, *linthresh*).

basex/basey: The base of the logarithm

linthreshx/linthreshy: The range (*-x*, *x*) within which the plot is linear (to avoid having the plot go to infinity around zero).

subsx/subsy: Where to place the subticks between each major tick. Should be a sequence of integers. For example, in a log10 scale: [2, 3, 4, 5, 6, 7, 8, 9]

will place 8 logarithmically spaced minor ticks between each major tick.

linscalex/linscaley: This allows the linear range (*-linthresh* to *linthresh*) to be stretched relative to the logarithmic range. Its value is the number of decades to use for each half of the linear range. For example, when *linscale* == 1.0 (the default), the space used for the positive and negative halves of the linear range will be equal to one decade in the logarithmic range.

class InvertedSymmetricalLogTransform(*base*, *linthresh*, *linscale*)

Bases: [matplotlib.transforms.Transform](#)

has_inverse = True

input_dims = 1

inverted()

is_separable = True

output_dims = 1

transform_non_affine(*a*)

class SymmetricalLogTransform(*base*, *linthresh*, *linscale*)

Bases: [matplotlib.transforms.Transform](#)

has_inverse = True

input_dims = 1

inverted()

is_separable = True

output_dims = 1

transform_non_affine(*a*)

get_transform()

Return a *SymmetricalLogTransform* instance.

name = 'symlog'

set_default_locators_and_formatters(*axis*)

Set the locators and formatters to specialized versions for symmetrical log scaling.

class matplotlib.scale.SymmetricalLogTransform(*base, linthresh, linscale*)

Bases: *matplotlib.transforms.Transform*

has_inverse = True

input_dims = 1

inverted()

is_separable = True

output_dims = 1

transform_non_affine(*a*)

matplotlib.scale.get_scale_docs()

Helper function for generating docstrings related to scales.

matplotlib.scale.get_scale_names()

matplotlib.scale.register_scale(*scale_class*)

Register a new kind of scale.

scale_class must be a subclass of *ScaleBase*.

`matplotlib.scale.scale_factory(scale, axis, **kwargs)`

Return a scale class by name.

ACCEPTS: [linear | log | logit | symlog]

49.1 matplotlib.spines

class `matplotlib.spines.Spine`(*axes, spine_type, path, **kwargs*)

Bases: `matplotlib.patches.Patch`

an axis spine – the line noting the data area boundaries

Spines are the lines connecting the axis tick marks and noting the boundaries of the data area. They can be placed at arbitrary positions. See function: `set_position` for more information.

The default position is ('outward', 0).

Spines are subclasses of class: `Patch`, and inherit much of their behavior.

Spines draw a line or a circle, depending if function: `set_patch_line` or function: `set_patch_circle` has been called. Line-like is the default.

- *axes* : the Axes instance containing the spine
- *spine_type* : a string specifying the spine type
- *path* : the path instance used to draw the spine

Valid kwargs are:

Property	Description
<code>agg_filter</code>	unknown
<code>alpha</code>	float or None
<code>animated</code>	[True False]
<code>antialiased</code> or <code>aa</code>	[True False] or None for default
<code>axes</code>	an <code>Axes</code> instance
<code>capstyle</code>	['butt' 'round' 'projecting']
<code>clip_box</code>	a <code>matplotlib.transforms.Bbox</code> instance
<code>clip_on</code>	[True False]
<code>clip_path</code>	[(<code>Path</code> , <code>Transform</code>) <code>Patch</code> None]
<code>color</code>	matplotlib color spec
<code>contains</code>	a callable function
<code>edgecolor</code> or <code>ec</code>	mpl color spec, None, 'none', or 'auto'

Continued on

Table 49.1 – continued from previous page

Property	Description
<i>facecolor</i> or <i>fc</i>	mpl color spec, or None for default, or ‘none’ for no color
<i>figure</i>	a <i>matplotlib.figure.Figure</i> instance
<i>fill</i>	[True False]
<i>gid</i>	an id string
<i>hatch</i>	[‘/’ ‘\’ ‘ ’ ‘-’ ‘+’ ‘x’ ‘o’ ‘O’ ‘.’ ‘*’]
<i>joinstyle</i>	[‘miter’ ‘round’ ‘bevel’]
<i>label</i>	string or anything printable with ‘%s’ conversion.
<i>linestyle</i> or <i>ls</i>	[‘solid’ ‘dashed’, ‘dashdot’, ‘dotted’ (offset, on-off-dash-seq) ‘-’ ‘--’ ‘-.’ ‘:’ ‘None’]
<i>linewidth</i> or <i>lw</i>	float or None for default
<i>path_effects</i>	unknown
<i>picker</i>	[None float boolean callable]
<i>rasterized</i>	[True False None]
<i>sketch_params</i>	unknown
<i>snap</i>	unknown
<i>transform</i>	<i>Transform</i> instance
<i>url</i>	a url string
<i>visible</i>	[True False]
<i>zorder</i>	any number

classmethod `circular_spine`(*axes*, *center*, *radius*, ****kwargs**)
 (staticmethod) Returns a circular *Spine*.

cla()
 Clear the current spine

draw(*artist*, *renderer*, **args*, ****kwargs**)

get_bounds()
 Get the bounds of the spine.

get_patch_transform()

get_path()

get_position()
 get the spine position

get_smart_bounds()
 get whether the spine has smart bounds

get_spine_transform()
 get the spine transform

is_frame_like()
 return True if directly on axes frame

This is useful for determining if a spine is the edge of an old style MPL plot. If so, this function will return True.

classmethod `linear_spine`(*axes, spine_type, **kwargs*)
(staticmethod) Returns a linear *Spine*.

register_axis(*axis*)
register an axis

An axis should be registered with its corresponding spine from the Axes instance. This allows the spine to clear any axis properties when needed.

set_bounds(*low, high*)
Set the bounds of the spine.

set_color(*c*)
Set the edgecolor.

ACCEPTS: matplotlib color arg or sequence of rgba tuples

See also:

set_facecolor(), **set_edgecolor()** For setting the edge or face color individually.

set_patch_circle(*center, radius*)
set the spine to be circular

set_patch_line()
set the spine to be linear

set_position(*position*)
set the position of the spine

Spine position is specified by a 2 tuple of (position type, amount). The position types are:

- ‘outward’ : place the spine out from the data area by the specified number of points. (Negative values specify placing the spine inward.)
- ‘axes’ : place the spine at the specified Axes coordinate (from 0.0-1.0).
- ‘data’ : place the spine at the specified data coordinate.

Additionally, shorthand notations define a special positions:

- ‘center’ -> (‘axes’, 0.5)
- ‘zero’ -> (‘data’, 0.0)

set_smart_bounds(*value*)
set the spine and associated axis to have smart bounds

50.1 matplotlib.style

`matplotlib.style.context`(*style*, *after_reset=False*)

Context manager for using style settings temporarily.

Parameters *style* : str, dict, or list

A style specification. Valid options are:

str	The name of a style or a path/URL to a style file. For a list of available style names, see <code>style.available</code> .
dict	Dictionary with valid key/value pairs for <code>matplotlib.rcParams</code> .
list	A list of style specifiers (str or dict) applied from first to last in the list.

after_reset : bool

If True, apply style after resetting settings to their defaults; otherwise, apply style on top of the current settings.

`matplotlib.style.reload_library`()

Reload style library.

`matplotlib.style.use`(*style*)

Use matplotlib style settings from a style specification.

The style name of ‘default’ is reserved for reverting back to the default style settings.

Parameters *style* : str, dict, or list

A style specification. Valid options are:

str	The name of a style or a path/URL to a style file. For a list of available style names, see <code>style.available</code> .
dict	Dictionary with valid key/value pairs for <code>matplotlib.rcParams</code> .
list	A list of style specifiers (str or dict) applied from first to last in the list.

`matplotlib.style.library`

Dictionary of available styles

`matplotlib.style.available`

List of available styles

51.1 matplotlib.text

Classes for including text in a figure.

```
class matplotlib.text.Annotation(s, xy, xytext=None, xycoords='data', textcoords=None, ar-  
rowprops=None, annotation_clip=None, **kwargs)
```

Bases: `matplotlib.text.Text`, `matplotlib.text._AnnotationBase`

Annotate the point `xy` with text `s`.

Additional kwargs are passed to `Text`.

Parameters `s` : str

The text of the annotation

`xy` : iterable

Length 2 sequence specifying the (x,y) point to annotate

`xytext` : iterable, optional

Length 2 sequence specifying the (x,y) to place the text at. If None, defaults to `xy`.

`xycoords` : str, Artist, Transform, callable or tuple, optional

The coordinate system that `xy` is given in.

For a str the allowed values are:

Property	Description
'figure points'	points from the lower left of the figure
'figure pixels'	pixels from the lower left of the figure
'figure fraction'	fraction of figure from lower left
'axes points'	points from lower left corner of axes
'axes pixels'	pixels from lower left corner of axes
'axes fraction'	fraction of axes from lower left
'data'	use the coordinate system of the object being annotated (default)
'polar'	(θ, r) if not native 'data' coordinates

If a *Artist* object is passed in the units are fraction if it's bounding box.

If a *Transform* object is passed in use that to transform *xy* to screen coordinates

If a callable it must take a *RendererBase* object as input and return a *Transform* or *Bbox* object

If a tuple must be length 2 tuple of str, *Artist*, *Transform* or callable objects. The first transform is used for the *x* coordinate and the second for *y*.

See *Advanced Annotation* for more details.

Defaults to 'data'

textcoords : str, *Artist*, *Transform*, callable or tuple, optional

The coordinate system that *xytext* is given, which may be different than the coordinate system used for *xy*.

All *xycoords* values are valid as well as the following strings:

Property	Description
'offset points'	offset (in points) from the <i>xy</i> value
'offset pixels'	offset (in pixels) from the <i>xy</i> value

defaults to the input of *xycoords*

arrowprops : dict, optional

If not None, properties used to draw a *FancyArrowPatch* arrow between *xy* and *xytext*.

If *arrowprops* does not contain the key 'arrowstyle' the allowed keys are:

Key	Description
width	the width of the arrow in points
headwidth	the width of the base of the arrow head in points
headlength	the length of the arrow head in points
shrink	fraction of total length to 'shrink' from both ends
?	any key to <code>matplotlib.patches.FancyArrowPatch</code>

If the `arrowprops` contains the key 'arrowstyle' the above keys are forbidden. The allowed values of 'arrowstyle' are:

Name	Attrs
'-'	None
'->'	head_length=0.4,head_width=0.2
'-['	widthB=1.0,lengthB=0.2,angleB=None
' -'	widthA=1.0,widthB=1.0
'- >'	head_length=0.4,head_width=0.2
'<-'	head_length=0.4,head_width=0.2
'<->'	head_length=0.4,head_width=0.2
'< -'	head_length=0.4,head_width=0.2
'< ->'	head_length=0.4,head_width=0.2
'fancy'	head_length=0.4,head_width=0.4,tail_width=0.4
'simple'	head_length=0.5,head_width=0.5,tail_width=0.2
'wedge'	tail_width=0.3,shrink_factor=0.5

Valid keys for `FancyArrowPatch` are:

Key	Description
arrowstyle	the arrow style
connectionstyle	the connection style
relpos	default is (0.5, 0.5)
patchA	default is bounding box of the text
patchB	default is None
shrinkA	default is 2 points
shrinkB	default is 2 points
mutation_scale	default is text size (in points)
mutation_aspect	default is 1.
?	any key for <code>matplotlib.patches.PathPatch</code>

Defaults to None

annotation_clip : bool, optional

Controls the visibility of the annotation when it goes outside the axes area.

If True, the annotation will only be drawn when the `xy` is inside the axes. If False, the annotation will always be drawn regardless of its position.

The default is None, which behave as True only if `xycoords` is "data".

Returns Annotation

anncoords

contains(*event*)

draw(*artist, renderer, *args, **kwargs*)

Draw the *Annotation* object to the given *renderer*.

get_window_extent(*renderer=None*)

Return a *Bbox* object bounding the text and arrow annotation, in display units.

renderer defaults to the `_renderer` attribute of the text object. This is not assigned until the first execution of `draw()`, so you must use this kwarg if you want to call `get_window_extent()` prior to the first `draw()`. For getting web page regions, it is simpler to call the method after saving the figure. The *dpi* used defaults to `self.figure.dpi`; the *renderer dpi* is irrelevant.

set_figure(*fig*)

update_positions(*renderer*)

“Update the pixel positions of the annotated point and the text.

xyann

class matplotlib.text.**OffsetFrom**(*artist, ref_coord, unit='points'*)

Bases: object

Callable helper class for working with *Annotation*

Parameters *artist* : Artist, BboxBase, or Transform

The object to compute the offset from.

ref_coord : length 2 sequence

If *artist* is an Artist or BboxBase, this values is the location to of the offset origin in fractions of the *artist* bounding box.

If *artist* is a transform, the offset origin is the transform applied to this value.

unit : { 'points', 'pixels' }

The screen units to use (pixels or points) for the offset input.

get_unit()

The unit for input to the transform used by `__call__`

set_unit(*unit*)

The unit for input to the transform used by `__call__`

Parameters *unit* : { 'points', 'pixels' }

class matplotlib.text.**Text**(*x=0, y=0, text='', color=None, verticalalignment='baseline', horizontalalignment='left', multialignment=None, font-properties=None, rotation=None, linespacing=None, rotation_mode=None, usetex=None, wrap=False, **kwargs*)

Bases: *matplotlib.artist.Artist*

Handle storing and drawing of text in window or data coordinates.

Create a *Text* instance at x, y with string *text*.

Valid kwargs are

Property	Description
<i>agg_filter</i>	unknown
<i>alpha</i>	float (0.0 transparent through 1.0 opaque)
<i>animated</i>	[True False]
<i>axes</i>	an <i>Axes</i> instance
<i>backgroundcolor</i>	any matplotlib color
<i>bbox</i>	FancyBboxPatch prop dict
<i>clip_box</i>	a <i>matplotlib.transforms.Bbox</i> instance
<i>clip_on</i>	[True False]
<i>clip_path</i>	[(<i>Path</i> , <i>Transform</i>) <i>Patch</i> None]
<i>color</i>	any matplotlib color
<i>contains</i>	a callable function
<i>family</i> or fontfamily or fontname or name	[FONTNAME 'serif' 'sans-serif' 'cursive' 'fantasy' 'monospace']
<i>figure</i>	a <i>matplotlib.figure.Figure</i> instance
<i>fontproperties</i> or font_properties	a <i>matplotlib.font_manager.FontProperties</i> instance
<i>gid</i>	an id string
<i>horizontalalignment</i> or ha	['center' 'right' 'left']
<i>label</i>	string or anything printable with '%s' conversion.
<i>linespacing</i>	float (multiple of font size)
<i>multialignment</i>	['left' 'right' 'center']
<i>path_effects</i>	unknown
<i>picker</i>	[None float boolean callable]
<i>position</i>	(x,y)
<i>rasterized</i>	[True False None]
<i>rotation</i>	[angle in degrees 'vertical' 'horizontal']
<i>rotation_mode</i>	unknown
<i>size</i> or fontsize	[size in points 'xx-small' 'x-small' 'small' 'medium' 'large' 'x-large']
<i>sketch_params</i>	unknown
<i>snap</i>	unknown
<i>stretch</i> or fontstretch	[a numeric value in range 0-1000 'ultra-condensed' 'extra-condensed' 'c
<i>style</i> or fontstyle	['normal' 'italic' 'oblique']
<i>text</i>	string or anything printable with '%s' conversion.
<i>transform</i>	<i>Transform</i> instance
<i>url</i>	a url string
<i>usetex</i>	unknown
<i>variant</i> or fontvariant	['normal' 'small-caps']
<i>verticalalignment</i> or ma or va	['center' 'top' 'bottom' 'baseline']
<i>visible</i>	[True False]
<i>weight</i> or fontweight	[a numeric value in range 0-1000 'ultralight' 'light' 'normal' 'regular']
<i>wrap</i>	unknown

Property	Description
<i>x</i>	float
<i>y</i>	float
<i>zorder</i>	any number

contains(*mouseevent*)

Test whether the mouse event occurred in the patch.

In the case of text, a hit is true anywhere in the axis-aligned bounding-box containing the text.

Returns True or False.

draw(*artist*, *renderer*, **args*, ***kwargs*)

Draws the *Text* object to the given *renderer*.

get_bbox_patch()

Return the bbox Patch object. Returns None if the FancyBboxPatch is not made.

get_color()

Return the color of the text

get_family()

Return the list of font families used for font lookup

get_font_properties()

alias for `get_fontproperties`

get_fontfamily()

alias for `get_family`

get_fontname()

alias for `get_name`

get_fontproperties()

Return the `FontProperties` object

get_fontsize()

alias for `get_size`

get_fontstretch()

alias for `get_stretch`

get_fontstyle()

alias for `get_style`

get_fontvariant()

alias for `get_variant`

get_fontweight()

alias for `get_weight`

get_ha()

alias for `get_horizontalalignment`

get_horizontalalignment()

Return the horizontal alignment as string. Will be one of 'left', 'center' or 'right'.

get_name()

Return the font name as string

get_position()

Return the position of the text as a tuple (x, y)

get_prop_tup(renderer=None)

Return a hashable tuple of properties.

Not intended to be human readable, but useful for backends who want to cache derived information about text (e.g., layouts) and need to know if the text has changed.

get_rotation()

return the text angle as float in degrees

get_rotation_mode()

get text rotation mode

get_size()

Return the font size as integer

get_stretch()

Get the font stretch as a string or number

get_style()

Return the font style as string

get_text()

Get the text as string

get_unitless_position()

Return the unitless position of the text as a tuple (x, y)

get_usetex()

Return whether this *Text* object will render using TeX.

If the user has not manually set this value, it will default to the value of `rcParams['text.usetex']`

get_va()

alias for `getverticalalignment()`

get_variant()

Return the font variant as a string

get_verticalalignment()

Return the vertical alignment as string. Will be one of 'top', 'center', 'bottom' or 'baseline'.

get_weight()

Get the font weight as string or number

get_window_extent(renderer=None, dpi=None)

Return a *Bbox* object bounding the text, in display units.

In addition to being used internally, this is useful for specifying clickable regions in a png file on a web page.

renderer defaults to the `_renderer` attribute of the text object. This is not assigned until the first execution of `draw()`, so you must use this kwarg if you want to call `get_window_extent()` prior to the first `draw()`. For getting web page regions, it is simpler to call the method after saving the figure.

dpi defaults to `self.figure.dpi`; the *renderer dpi* is irrelevant. For the web application, if `figure.dpi` is not the value used when saving the figure, then the value that was used must be specified as the *dpi* argument.

get_wrap()

Returns the wrapping state for the text.

static is_math_text(*s*, *usetex=None*)

Returns a cleaned string and a boolean flag. The flag indicates if the given string *s* contains any mathtext, determined by counting unescaped dollar signs. If no mathtext is present, the cleaned string has its dollar signs unescaped. If *usetex* is on, the flag always has the value “TeX”.

set_backgroundcolor(*color*)

Set the background color of the text by updating the `bbox`.

See also:

[`set_bbox\(\)`](#) To change the position of the bounding box.

ACCEPTS: any matplotlib color

set_bbox(*rectprops*)

Draw a bounding box around `self`. *rectprops* are any settable properties for a `FancyBboxPatch`, e.g., `facecolor='red'`, `alpha=0.5`.

```
t.set_bbox(dict(facecolor='red', alpha=0.5))
```

The default `boxstyle` is ‘square’. The mutation scale of the `FancyBboxPatch` is set to the `fontsize`.

ACCEPTS: `FancyBboxPatch` prop dict

set_clip_box(*clipbox*)

Set the artist’s clip *Bbox*.

ACCEPTS: a `matplotlib.transforms.Bbox` instance

set_clip_on(*b*)

Set whether artist uses clipping.

When `False` artists will be visible out side of the axes which can lead to unexpected results.

ACCEPTS: [True | False]

set_clip_path(*path*, *transform=None*)

Set the artist’s clip path, which may be:

- a *Patch* (or subclass) instance

- a *Path* instance, in which case an optional *Transform* instance may be provided, which will be applied to the path before using it for clipping.
- *None*, to remove the clipping path

For efficiency, if the path happens to be an axis-aligned rectangle, this method will set the clipping box to the corresponding rectangle and set the clipping path to *None*.

ACCEPTS: [(*Path*, *Transform*) | *Patch* | *None*]

set_color(*color*)

Set the foreground color of the text

ACCEPTS: any matplotlib color

set_family(*fontname*)

Set the font family. May be either a single string, or a list of strings in decreasing priority. Each string may be either a real font name or a generic font class name. If the latter, the specific font names will be looked up in the `matplotlibrc` file.

ACCEPTS: [FONTNAME | 'serif' | 'sans-serif' | 'cursive' | 'fantasy' | 'monospace']

set_font_properties(*fp*)

alias for `set_fontproperties`

set_fontname(*fontname*)

alias for `set_family`

set_fontproperties(*fp*)

Set the font properties that control the text. *fp* must be a `matplotlib.font_manager.FontProperties` object.

ACCEPTS: a `matplotlib.font_manager.FontProperties` instance

set_fontsize(*fontsize*)

alias for `set_size`

set_fontstretch(*stretch*)

alias for `set_stretch`

set_fontstyle(*fontstyle*)

alias for `set_style`

set_fontvariant(*variant*)

alias for `set_variant`

set_fontweight(*weight*)

alias for `set_weight`

set_ha(*align*)

alias for `set_horizontalalignment`

set_horizontalalignment(*align*)

Set the horizontal alignment to one of

ACCEPTS: ['center' | 'right' | 'left']

set_linespacing(*spacing*)

Set the line spacing as a multiple of the font size. Default is 1.2.

ACCEPTS: float (multiple of font size)

set_ma(*align*)

alias for set_verticalalignment

set_multialignment(*align*)

Set the alignment for multiple lines layout. The layout of the bounding box of all the lines is determined by the horizontalalignment and verticalalignment properties, but the multiline text within that box can be

ACCEPTS: ['left' | 'right' | 'center']

set_name(*fontname*)

alias for set_family

set_position(*xy*)

Set the (x, y) position of the text

ACCEPTS: (x,y)

set_rotation(*s*)

Set the rotation of the text

ACCEPTS: [angle in degrees | 'vertical' | 'horizontal']

set_rotation_mode(*m*)

set text rotation mode. If "anchor", the un-rotated text will first be aligned according to their *ha* and *va*, and then will be rotated with the alignment reference point as a origin. If None (default), the text will be rotated first then will be aligned.

set_size(*fontsize*)

Set the font size. May be either a size string, relative to the default font size, or an absolute font size in points.

ACCEPTS: [size in points | 'xx-small' | 'x-small' | 'small' | 'medium' | 'large' | 'x-large' | 'xx-large']

set_stretch(*stretch*)

Set the font stretch (horizontal condensation or expansion).

ACCEPTS: [a numeric value in range 0-1000 | 'ultra-condensed' | 'extra-condensed' | 'condensed' | 'semi-condensed' | 'normal' | 'semi-expanded' | 'expanded' | 'extra-expanded' | 'ultra-expanded']

set_style(*fontstyle*)

Set the font style.

ACCEPTS: ['normal' | 'italic' | 'oblique']

set_text(*s*)

Set the text string *s*

It may contain newlines (\n) or math in LaTeX syntax.

ACCEPTS: string or anything printable with ‘%s’ conversion.

set_usetex(*usetex*)

Set this *Text* object to render using TeX (or not).

If None is given, the option will be reset to use the value of `rcParams['text.usetex']`

set_va(*align*)

alias for `set_verticalalignment`

set_variant(*variant*)

Set the font variant, either ‘normal’ or ‘small-caps’.

ACCEPTS: [‘normal’ | ‘small-caps’]

set_verticalalignment(*align*)

Set the vertical alignment

ACCEPTS: [‘center’ | ‘top’ | ‘bottom’ | ‘baseline’]

set_weight(*weight*)

Set the font weight.

ACCEPTS: [a numeric value in range 0-1000 | ‘ultralight’ | ‘light’ | ‘normal’ | ‘regular’ | ‘book’ | ‘medium’ | ‘roman’ | ‘semibold’ | ‘demibold’ | ‘demi’ | ‘bold’ | ‘heavy’ | ‘extra bold’ | ‘black’]

set_wrap(*wrap*)

Sets the wrapping state for the text.

set_x(*x*)

Set the *x* position of the text

ACCEPTS: float

set_y(*y*)

Set the *y* position of the text

ACCEPTS: float

update(*kwargs*)

Update properties from a dictionary.

update_bbox_position_size(*renderer*)

Update the location and the size of the bbox. This method should be used when the position and size of the bbox needs to be updated before actually drawing the bbox.

update_from(*other*)

Copy properties from other to self

zorder = 3

```
class matplotlib.text.TextWithDash(x=0, y=0, text='', color=None, verticalalign='center', horizontalalignment='center', multialignment=None, fontproperties=None, rotation=None, linespacing=None, dashlength=0.0, dashdirection=0, dashrotation=None, dashpad=3, dashpush=0)
```

Bases: `matplotlib.text.Text`

This is basically a `Text` with a dash (drawn with a `Line2D`) before/after it. It is intended to be a drop-in replacement for `Text`, and should behave identically to it when `dashlength = 0.0`.

The dash always comes between the point specified by `set_position()` and the text. When a dash exists, the text alignment arguments (`horizontalalignment`, `verticalalignment`) are ignored.

`dashlength` is the length of the dash in canvas units. (default = 0.0).

`dashdirection` is one of 0 or 1, where 0 draws the dash after the text and 1 before. (default = 0).

`dashrotation` specifies the rotation of the dash, and should generally stay `None`. In this case `get_dashrotation()` returns `get_rotation()`. (i.e., the dash takes its rotation from the text's rotation). Because the text center is projected onto the dash, major deviations in the rotation cause what may be considered visually unappealing results. (default = `None`)

`dashpad` is a padding length to add (or subtract) space between the text and the dash, in canvas units. (default = 3)

`dashpush` “pushes” the dash and text away from the point specified by `set_position()` by the amount in canvas units. (default = 0)

Note: The alignment of the two objects is based on the bounding box of the `Text`, as obtained by `get_window_extent()`. This, in turn, appears to depend on the font metrics as given by the rendering backend. Hence the quality of the “centering” of the label text with respect to the dash varies depending on the backend used.

Note: I'm not sure that I got the `get_window_extent()` right, or whether that's sufficient for providing the object bounding box.

draw(*renderer*)

Draw the `TextWithDash` object to the given *renderer*.

get_dashdirection()

Get the direction dash. 1 is before the text and 0 is after.

get_dashlength()

Get the length of the dash.

get_dashpad()

Get the extra spacing between the dash and the text, in canvas units.

get_dashpush()

Get the extra spacing between the dash and the specified text position, in canvas units.

get_dashrotation()

Get the rotation of the dash in degrees.

get_figure()

return the figure instance the artist belongs to

get_position()

Return the position of the text as a tuple (x, y)

get_prop_tup(renderer=None)

Return a hashable tuple of properties.

Not intended to be human readable, but useful for backends who want to cache derived information about text (e.g., layouts) and need to know if the text has changed.

get_unitless_position()

Return the unitless position of the text as a tuple (x, y)

get_window_extent(renderer=None)

Return a *Bbox* object bounding the text, in display units.

In addition to being used internally, this is useful for specifying clickable regions in a png file on a web page.

renderer defaults to the *_renderer* attribute of the text object. This is not assigned until the first execution of *draw()*, so you must use this kwarg if you want to call *get_window_extent()* prior to the first *draw()*. For getting web page regions, it is simpler to call the method after saving the figure.

set_dashdirection(dd)

Set the direction of the dash following the text. 1 is before the text and 0 is after. The default is 0, which is what you'd want for the typical case of ticks below and on the left of the figure.

ACCEPTS: int (1 is before, 0 is after)

set_dashlength(dl)

Set the length of the dash.

ACCEPTS: float (canvas units)

set_dashpad(dp)

Set the “pad” of the TextWithDash, which is the extra spacing between the dash and the text, in canvas units.

ACCEPTS: float (canvas units)

set_dashpush(dp)

Set the “push” of the TextWithDash, which is the extra spacing between the beginning of the dash and the specified position.

ACCEPTS: float (canvas units)

set_dashrotation(dr)

Set the rotation of the dash, in degrees

ACCEPTS: float (degrees)

set_figure(*fig*)

Set the figure instance the artist belong to.

ACCEPTS: a *matplotlib.figure.Figure* instance

set_position(*xy*)

Set the (*x*, *y*) position of the *TextWithDash*.

ACCEPTS: (*x*, *y*)

set_transform(*t*)

Set the *matplotlib.transforms.Transform* instance used by this artist.

ACCEPTS: a *matplotlib.transforms.Transform* instance

set_x(*x*)

Set the *x* position of the *TextWithDash*.

ACCEPTS: float

set_y(*y*)

Set the *y* position of the *TextWithDash*.

ACCEPTS: float

update_coords(*renderer*)

Computes the actual *x*, *y* coordinates for text based on the input *x*, *y* and the *dashlength*. Since the rotation is with respect to the actual canvas's coordinates we need to map back and forth.

`matplotlib.text.get_rotation`(*rotation*)

Return the text angle as float. The returned angle is between 0 and 360 deg.

rotation may be 'horizontal', 'vertical', or a numeric value in degrees.

52.1 matplotlib.ticker

52.1.1 Tick locating and formatting

This module contains classes to support completely configurable tick locating and formatting. Although the locators know nothing about major or minor ticks, they are used by the `Axis` class to support major and minor tick locating and formatting. Generic tick locators and formatters are provided, as well as domain specific custom ones.

Default Formatter

The default formatter identifies when the x-data being plotted is a small range on top of a large offset. To reduce the chances that the ticklabels overlap the ticks are labeled as deltas from a fixed offset. For example:

```
ax.plot(np.arange(2000, 2010), range(10))
```

will have tick of 0-9 with an offset of +2e3. If this is not desired turn off the use of the offset on the default formatter:

```
ax.get_xaxis().get_major_formatter().set_useOffset(False)
```

set the rcParam `axes.formatter.useoffset=False` to turn it off globally, or set a different formatter.

Tick locating

The `Locator` class is the base class for all tick locators. The locators handle autoscaling of the view limits based on the data limits, and the choosing of tick locations. A useful semi-automatic tick locator is `MultipleLocator`. You initialize this with a base, e.g., 10, and it picks axis limits and ticks that are multiples of your base.

The `Locator` subclasses defined here are

`NullLocator` No ticks

`FixedLocator` Tick locations are fixed

IndexLocator locator for index plots (e.g., where $x = \text{range}(\text{len}(y))$)

LinearLocator evenly spaced ticks from min to max

LogLocator logarithmically ticks from min to max

SymmetricalLogLocator locator for use with with the symlog norm, works like the *LogLocator* for the part outside of the threshold and add 0 if inside the limits

MultipleLocator

ticks and range are a multiple of base; either integer or float

OldAutoLocator choose a *MultipleLocator* and dynamically reassign it for intelligent ticking during navigation

MaxNLocator finds up to a max number of ticks at nice locations

AutoLocator *MaxNLocator* with simple defaults. This is the default tick locator for most plotting.

AutoMinorLocator locator for minor ticks when the axis is linear and the major ticks are uniformly spaced. It subdivides the major tick interval into a specified number of minor intervals, defaulting to 4 or 5 depending on the major interval.

LogitLocator Locator for logit scaling.

There are a number of locators specialized for date locations - see the dates module

You can define your own locator by deriving from *Locator*. You must override the `__call__` method, which returns a sequence of locations, and you will probably want to override the `autoscale` method to set the view limits from the data limits.

If you want to override the default locator, use one of the above or a custom locator and pass it to the x or y axis instance. The relevant methods are:

```
ax.xaxis.set_major_locator( xmajorLocator )
ax.xaxis.set_minor_locator( xminorLocator )
ax.yaxis.set_major_locator( ymajorLocator )
ax.yaxis.set_minor_locator( yminorLocator )
```

The default minor locator is the *NullLocator*, e.g., no minor ticks on by default.

Tick formatting

Tick formatting is controlled by classes derived from *Formatter*. The formatter operates on a single tick value and returns a string to the axis.

NullFormatter No labels on the ticks

IndexFormatter Set the strings from a list of labels

FixedFormatter Set the strings manually for the labels

FuncFormatter User defined function sets the labels

StrMethodFormatter Use string format method

FormatStrFormatter Use an old-style sprintf format string

ScalarFormatter Default formatter for scalars: autopick the format string

LogFormatter Formatter for log axes

LogFormatterExponent Format values for log axis using `exponent = log_base(value)`.

LogFormatterMathtext Format values for log axis using `exponent = log_base(value)` using Math text.

LogFormatterSciNotation Format values for log axis using scientific notation.

LogitFormatter Probability formatter.

You can derive your own formatter from the `Formatter` base class by simply overriding the `__call__` method. The formatter class has access to the axis view and data limits.

To control the major and minor tick label formats, use one of the following methods:

```
ax.xaxis.set_major_formatter( xmajorFormatter )
ax.xaxis.set_minor_formatter( xminorFormatter )
ax.yaxis.set_major_formatter( ymajorFormatter )
ax.yaxis.set_minor_formatter( yminorFormatter )
```

See [*pylab_examples example code: major_minor_demol.py*](#) for an example of setting major and minor ticks. See the [*matplotlib.dates*](#) module for more information and examples of using date locators and formatters.

class matplotlib.ticker.TickHelper

Bases: `object`

axis = None

create_dummy_axis(kwargs)**

set_axis(axis)

set_bounds(vmin, vmax)

set_data_interval(vmin, vmax)

set_view_interval(vmin, vmax)

class matplotlib.ticker.Formatter

Bases: [*matplotlib.ticker.TickHelper*](#)

Create a string based on a tick value and location.

fix_minus(*s*)

Some classes may want to replace a hyphen for minus with the proper unicode symbol (U+2212) for typographical correctness. The default is to not replace it.

Note, if you use this method, e.g., in `format_data()` or call, you probably don't want to use it for `format_data_short()` since the toolbar uses this for interactive coord reporting and I doubt we can expect GUIs across platforms will handle the unicode correctly. So for now the classes that override `fix_minus()` should have an explicit `format_data_short()` method

format_data(*value*)

Returns the full string representation of the value with the position unspecified.

format_data_short(*value*)

Return a short string version of the tick value.

Defaults to the position-independent long value.

get_offset()**locs** = []**set_locs**(*locs*)**class** matplotlib.ticker.**FixedFormatter**(*seq*)

Bases: `matplotlib.ticker.Formatter`

Return fixed strings for tick labels based only on position, not value.

Set the sequence of strings that will be used for labels.

get_offset()**set_offset_string**(*ofs*)**class** matplotlib.ticker.**NullFormatter**

Bases: `matplotlib.ticker.Formatter`

Always return the empty string.

class matplotlib.ticker.**FuncFormatter**(*func*)

Bases: `matplotlib.ticker.Formatter`

Use a user-defined function for formatting.

The function should take in two inputs (a tick value *x* and a position *pos*), and return a string containing the corresponding tick label.

class matplotlib.ticker.**FormatStrFormatter**(*fmt*)

Bases: `matplotlib.ticker.Formatter`

Use an old-style ('%' operator) format string to format the tick.

The format string should have a single variable format (%) in it. It will be applied to the value (not the position) of the tick.

class matplotlib.ticker.StrMethodFormatter(*fmt*)

Bases: [matplotlib.ticker.Formatter](#)

Use a new-style format string (as used by `str.format()`) to format the tick.

The field used for the value must be labeled `x` and the field used for the position must be labeled `pos`.

class matplotlib.ticker.ScalarFormatter(*useOffset=None*, *useMathText=None*, *useLocale=None*)

Bases: [matplotlib.ticker.Formatter](#)

Format tick values as a number.

Tick value is interpreted as a plain old number. If `useOffset==True` and the data range is much smaller than the data average, then an offset will be determined such that the tick labels are meaningful. Scientific notation is used for data $< 10^{-n}$ or data $\geq 10^m$, where `n` and `m` are the power limits set using `set_powerlimits((n,m))`. The defaults for these are controlled by the `axes.formatter.limits` rc parameter.

fix_minus(*s*)

Replace hyphens with a unicode minus.

format_data(*value*)

Return a formatted string representation of a number.

format_data_short(*value*)

Return a short formatted string representation of a number.

get_offset()

Return scientific notation, plus offset.

get_useLocale()

get_useOffset()

pprint_val(*x*)

set_locs(*locs*)

Set the locations of the ticks.

set_powerlimits(*lims*)

Sets size thresholds for scientific notation.

`lims` is a two-element sequence containing the powers of 10 that determine the switchover threshold. Numbers below $10^{lims[0]}$ and above $10^{lims[1]}$ will be displayed in scientific notation.

For example, `formatter.set_powerlimits((-3, 4))` sets the pre-2007 default in which scientific notation is used for numbers less than $1e-3$ or greater than $1e4$.

See also:

Method `set_scientific()`

set_scientific(*b*)

Turn scientific notation on or off.

See also:

Method `set_powerlimits()`

set_useLocale(*val*)

set_useOffset(*val*)

useLocale

useOffset

class matplotlib.ticker.**LogFormatter**(*base=10.0*, *labelOnlyBase=False*, *mi-*
nor_thresholds=None, *linthresh=None*)

Bases: `matplotlib.ticker.Formatter`

Base class for formatting ticks on a log or symlog scale.

It may be instantiated directly, or subclassed.

Parameters **base** : float, optional, default: 10.

Base of the logarithm used in all calculations.

labelOnlyBase : bool, optional, default: False

If True, label ticks only at integer powers of base. This is normally True for major ticks and False for minor ticks.

minor_thresholds : (subset, all), optional, default: (1, 0.4)

If labelOnlyBase is False, these two numbers control the labeling of ticks that are not at integer powers of base; normally these are the minor ticks. The controlling parameter is the log of the axis data range. In the typical case where base is 10 it is the number of decades spanned by the axis, so we can call it 'numdec'. If numdec <= all, all minor ticks will be labeled. If all < numdec <= subset, then only a subset of minor ticks will be labeled, so as to avoid crowding. If numdec > subset then no minor ticks will be labeled.

linthresh : None or float, optional, default: None

If a symmetric log scale is in use, its linthresh parameter must be supplied here.

Notes

The `set_locs` method must be called to enable the subsetting logic controlled by the `minor_thresholds` parameter.

In some cases such as the colorbar, there is no distinction between major and minor ticks; the tick locations might be set manually, or by a locator that puts ticks at integer powers of base and at intermediate locations. For this situation, disable the `minor_thresholds` logic by using `minor_thresholds=(np.inf, np.inf)`, so that all ticks will be labeled.

To disable labeling of minor ticks when ‘labelOnlyBase’ is False, use `minor_thresholds=(0, 0)`. This is the default for the “classic” style.

Examples

To label a subset of minor ticks when the view limits span up to 2 decades, and all of the ticks when zoomed in to 0.5 decades or less, use `minor_thresholds=(2, 0.5)`.

To label all minor ticks when the view limits span up to 1.5 decades, use `minor_thresholds=(1.5, 1.5)`.

base(*base*)

change the *base* for labeling.

Warning: Should always match the base used for *LogLocator*

format_data(*value*)

format_data_short(*value*)

Return a short formatted string representation of a number.

label_minor(*labelOnlyBase*)

Switch minor tick labeling on or off.

Parameters labelOnlyBase : bool

If True, label ticks only at integer powers of base.

pprint_val(*x, d*)

set_locs(*locs=None*)

Use axis view limits to control which ticks are labeled.

The `locs` parameter is ignored in the present algorithm.

class matplotlib.ticker.LogFormatterExponent(*base=10.0, labelOnlyBase=False, minor_thresholds=None, linthresh=None*)

Bases: `matplotlib.ticker.LogFormatter`

Format values for log axis using `exponent = log_base(value)`.

class matplotlib.ticker.**LogFormatterMathText**(*base=10.0, labelOnlyBase=False, minor_thresholds=None, linthresh=None*)

Bases: [matplotlib.ticker.LogFormatter](#)

Format values for log axis using `exponent = log_base(value)`.

class matplotlib.ticker.**Locator**

Bases: [matplotlib.ticker.TickHelper](#)

Determine the tick locations;

Note, you should not use the same locator between different [Axis](#) because the locator stores references to the Axis data and view limits

MAXTICKS = 1000

autoscale()

autoscale the view limits

pan(*numsteps*)

Pan numticks (can be positive or negative)

raise_if_exceeds(*locs*)

raise a RuntimeError if Locator attempts to create more than MAXTICKS locs

refresh()

refresh internal information based on current lim

set_params(***kwargs*)

Do nothing, and raise a warning. Any locator class not supporting the `set_params()` function will call this.

tick_values(*vmin, vmax*)

Return the values of the located ticks given **vmin** and **vmax**.

Note: To get tick locations with the `vmin` and `vmax` values defined automatically for the associated `axis` simply call the `Locator` instance:

```
>>> print((type(loc)))
<type 'Locator'>
>>> print((loc()))
[1, 2, 3, 4]
```

view_limits(*vmin, vmax*)

select a scale for the range from `vmin` to `vmax`

Normally this method is overridden by subclasses to change locator behaviour.

zoom(*direction*)

Zoom in/out on axis; if `direction` is `>0` zoom in, else zoom out

class matplotlib.ticker.**IndexLocator**(*base, offset*)

Bases: [matplotlib.ticker.Locator](#)

Place a tick on every multiple of some base number of points plotted, e.g., on every 5th point. It is assumed that you are doing index plotting; i.e., the axis is 0, len(data). This is mainly useful for x ticks.

place ticks on the i-th data points where $(i - \text{offset}) \% \text{base} == 0$

set_params(*base=None, offset=None*)
Set parameters within this locator

tick_values(*vmin, vmax*)

class matplotlib.ticker.FixedLocator(*locs, nbins=None*)

Bases: *matplotlib.ticker.Locator*

Tick locations are fixed. If nbins is not None, the array of possible positions will be subsampled to keep the number of ticks $\leq \text{nbins} + 1$. The subsampling will be done so as to include the smallest absolute value; for example, if zero is included in the array of possibilities, then it is guaranteed to be one of the chosen ticks.

set_params(*nbins=None*)
Set parameters within this locator.

tick_values(*vmin, vmax*)
” Return the locations of the ticks.

Note: Because the values are fixed, vmin and vmax are not used in this method.

class matplotlib.ticker.NullLocator

Bases: *matplotlib.ticker.Locator*

No ticks

tick_values(*vmin, vmax*)
” Return the locations of the ticks.

Note: Because the values are Null, vmin and vmax are not used in this method.

class matplotlib.ticker.LinearLocator(*numticks=None, presets=None*)

Bases: *matplotlib.ticker.Locator*

Determine the tick locations

The first time this function is called it will try to set the number of ticks to make a nice tick partitioning. Thereafter the number of ticks will be fixed so that interactive navigation will be nice

Use presets to set locs based on lom. A dict mapping vmin, vmax->locs

set_params(*numticks=None, presets=None*)
Set parameters within this locator.

tick_values(*vmin, vmax*)

view_limits(*vmin*, *vmax*)

Try to choose the view limits intelligently

class matplotlib.ticker.**LogLocator**(*base=10.0*, *subs=(1.0,)*, *numdecs=4*, *numticks=None*)

Bases: *matplotlib.ticker.Locator*

Determine the tick locations for log axes

Place ticks on the locations : $\text{subs}[j] * \text{base}^{**i}$

Parameters *subs* : None, string, or sequence of float, optional, default (1.0,)

 Gives the multiples of integer powers of the base at which to place ticks. The default places ticks only at integer powers of the base. The permitted string values are 'auto' and 'all', both of which use an algorithm based on the axis view limits to determine whether and how to put ticks between integer powers of the base. With 'auto', ticks are placed only between integer powers; with 'all', the integer powers are included. A value of None is equivalent to 'auto'.

base(*base*)

set the base of the log scaling (major tick every base^{**i} , *i* integer)

nonsingular(*vmin*, *vmax*)

set_params(*base=None*, *subs=None*, *numdecs=None*, *numticks=None*)

Set parameters within this locator.

subs(*subs*)

set the minor ticks for the log scaling every $\text{base}^{**i} * \text{subs}[j]$

tick_values(*vmin*, *vmax*)

view_limits(*vmin*, *vmax*)

Try to choose the view limits intelligently

class matplotlib.ticker.**AutoLocator**

Bases: *matplotlib.ticker.MaxNLocator*

class matplotlib.ticker.**MultipleLocator**(*base=1.0*)

Bases: *matplotlib.ticker.Locator*

Set a tick on every integer that is multiple of base in the view interval

set_params(*base*)

Set parameters within this locator.

tick_values(*vmin*, *vmax*)

view_limits(*dmin*, *dmax*)

Set the view limits to the nearest multiples of base that contain the data

class matplotlib.ticker.**MaxNLocator**(**args*, ***kwargs*)

Bases: *matplotlib.ticker.Locator*

Select no more than N intervals at nice locations.

Keyword args:

nbins Maximum number of intervals; one less than max number of ticks. If the string 'auto', the number of bins will be automatically determined based on the length of the axis.

steps Sequence of nice numbers starting with 1 and ending with 10; e.g., [1, 2, 4, 5, 10]

integer If True, ticks will take only integer values, provided at least `min_n_ticks` integers are found within the view limits.

symmetric If True, autoscaling will result in a range symmetric about zero.

prune ['lower' | 'upper' | 'both' | None] Remove edge ticks – useful for stacked or ganged plots where the upper tick of one axes overlaps with the lower tick of the axes above it, primarily when `rcParams['axes.autolimit_mode']` is 'round_numbers'. If `prune=='lower'`, the smallest tick will be removed. If `prune=='upper'`, the largest tick will be removed. If `prune=='both'`, the largest and smallest ticks will be removed. If `prune==None`, no ticks will be removed.

min_n_ticks Relax `nbins` and `integer` constraints if necessary to obtain this minimum number of ticks.

bin_boundaries(*vmin*, *vmax*)

Deprecated since version 2.0: The `bin_boundaries` function was deprecated in version 2.0.

default_params = {'nbins': 10, 'steps': None, 'integer': False, 'symmetric': False, 'prune': None, 'min_n_ticks': 10}

set_params(***kwargs*)

Set parameters within this locator.

tick_values(*vmin*, *vmax*)

view_limits(*dmin*, *dmax*)

class `matplotlib.ticker.AutoMinorLocator`(*n=None*)

Bases: `matplotlib.ticker.Locator`

Dynamically find minor tick positions based on the positions of major ticks. Assumes the scale is linear and major ticks are evenly spaced.

n is the number of subdivisions of the interval between major ticks; e.g., *n*=2 will place a single minor tick midway between major ticks.

If *n* is omitted or None, it will be set to 5 or 4.

tick_values(*vmin*, *vmax*)

class `matplotlib.ticker.SymmetricalLogLocator`(*transform=None*, *subs=None*,

linthresh=None, *base=None*)

Bases: `matplotlib.ticker.Locator`

Determine the tick locations for symmetric log axes

place ticks on the location= $\text{base}^{**i} \cdot \text{subs}[j]$

set_params(*subs=None, numticks=None*)

Set parameters within this locator.

tick_values(*vmin, vmax*)

view_limits(*vmin, vmax*)

Try to choose the view limits intelligently

TIGHT_LAYOUT

53.1 `matplotlib.tight_layout`

This module provides routines to adjust subplot params so that subplots are nicely fit in the figure. In doing so, only axis labels, tick labels, axes titles and offsetboxes that are anchored to axes are currently considered.

Internally, it assumes that the margins (`left_margin`, etc.) which are differences between `ax.get_tightbbox` and `ax.bbox` are independent of axes position. This may fail if `Axes.adjustable` is `datalim`. Also, This will fail for some cases (for example, left or right margin is affected by `xlabel`).

```
matplotlib.tight_layout.auto_adjust_subplotpars(fig, renderer, nrows_ncols,  
                                                num1num2_list, subplot_list,  
                                                ax_bbox_list=None, pad=1.08,  
                                                h_pad=None, w_pad=None,  
                                                rect=None)
```

Return a dictionary of subplot parameters so that spacing between subplots are adjusted. Note that this function ignore geometry information of subplot itself, but uses what is given by `nrows_ncols` and `num1num2_list` parameteres. Also, the results could be incorrect if some subplots have `adjustable=datalim`.

Parameters:

`nrows_ncols` number of rows and number of columns of the grid.

`num1num2_list` list of numbers specifying the area occupied by the subplot

`subplot_list` list of subplots that will be used to calculate optimal subplot_params.

`pad` [float] padding between the figure edge and the edges of subplots, as a fraction of the font-size.

`h_pad, w_pad` [float]

padding (height/width) between edges of adjacent subplots. Defaults to `pad_inches`.

`rect` [left, bottom, right, top] in normalized (0, 1) figure coordinates.

```
matplotlib.tight_layout.get_renderer(fig)
```

```
matplotlib.tight_layout.get_subplotspec_list(axes_list, grid_spec=None)
```

Return a list of subplotspec from the given list of axes. For an instance of axes that does not support subplotspec, `None` is inserted in the list.

If `grid_spec` is given, `None` is inserted for those not from the given `grid_spec`.

`matplotlib.tight_layout.get_tight_layout_figure`(*fig*, *axes_list*, *subplotspec_list*, *renderer*, *pad*=1.08, *h_pad*=None, *w_pad*=None, *rect*=None)

Return subplot parameters for tight-laid-out-figure with specified padding.

Parameters:

fig : figure instance

axes_list : a list of axes

subplotspec_list [a list of `subplotspec` associated with each] axes in *axes_list*

renderer : renderer instance

pad [float] padding between the figure edge and the edges of subplots, as a fraction of the font-size.

h_pad, *w_pad* [float] padding (height/width) between edges of adjacent subplots. Defaults to `pad_inches`.

rect [if `rect` is given, it is interpreted as a rectangle] (left, bottom, right, top) in the normalized figure coordinate that the whole subplots area (including labels) will fit into. Default is (0, 0, 1, 1).

WORKING WITH TRANSFORMATIONS

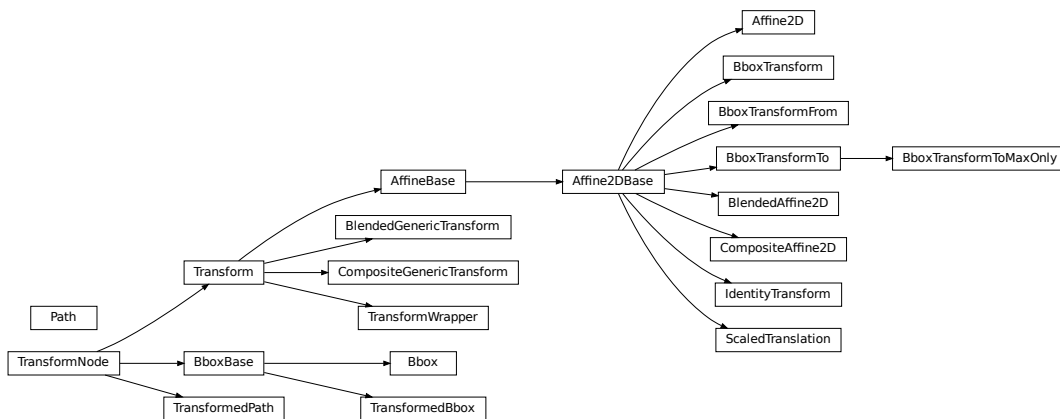

54.1 matplotlib.transforms

matplotlib includes a framework for arbitrary geometric transformations that is used to determine the final position of all elements drawn on the canvas.

Transforms are composed into trees of *TransformNode* objects whose actual value depends on their children. When the contents of children change, their parents are automatically invalidated. The next time an invalidated transform is accessed, it is recomputed to reflect those changes. This invalidation/caching approach prevents unnecessary recomputations of transforms, and contributes to better interactive performance.

For example, here is a graph of the transform tree used to plot data to the graph:

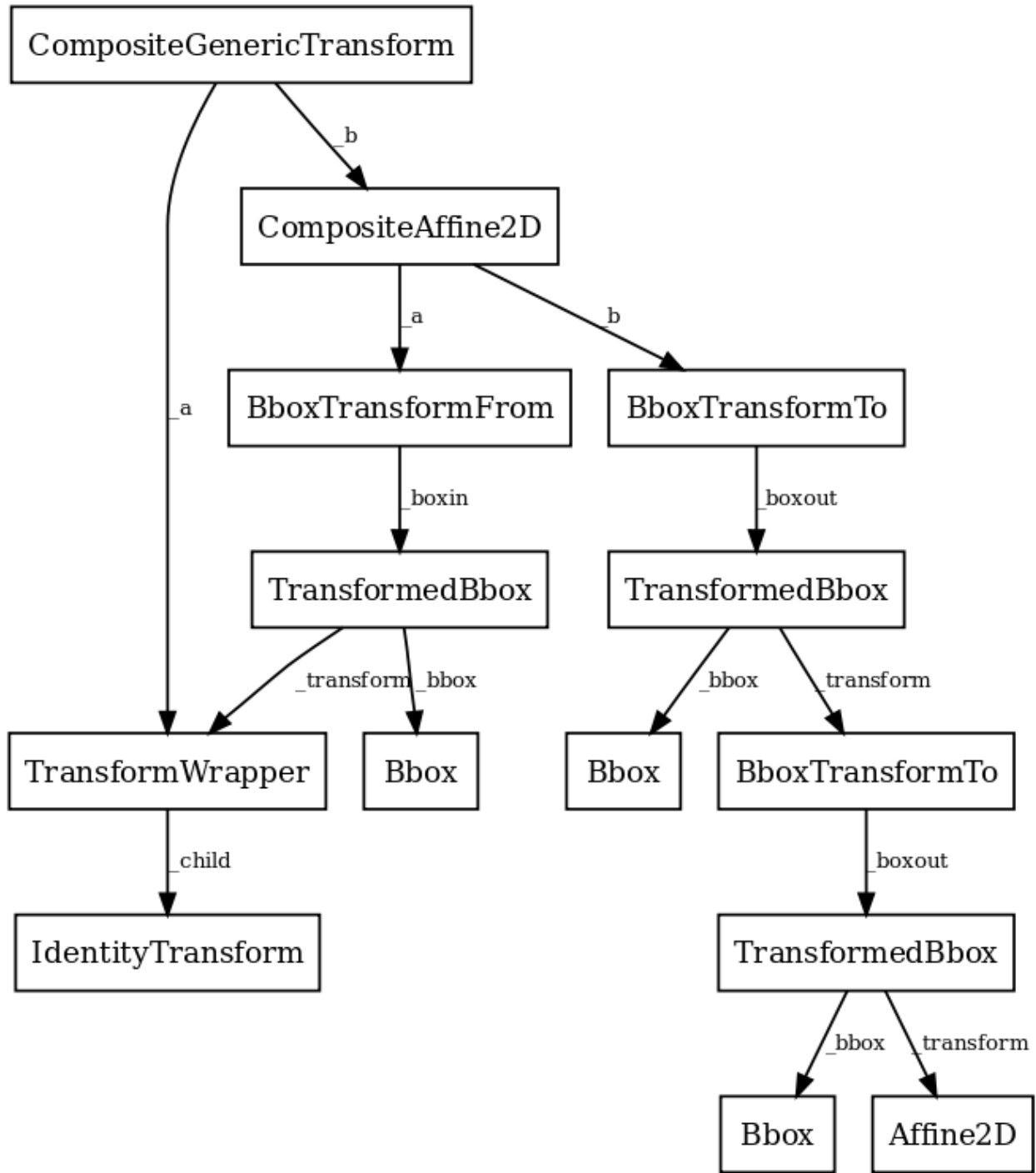

The framework can be used for both affine and non-affine transformations. However, for speed, we want use the backend renderers to perform affine transformations whenever possible. Therefore, it is possible to perform just the affine or non-affine part of a transformation on a set of data. The affine is always assumed to occur after the non-affine. For any transform:

```
full transform == non-affine part + affine part
```

The backends are not expected to handle non-affine transformations themselves.

class matplotlib.transforms.**TransformNode**(*shorthand_name=None*)

Bases: object

TransformNode is the base class for anything that participates in the transform tree and needs to invalidate its parents or be invalidated. This includes classes that are not really transforms, such as bounding boxes, since some transforms depend on bounding boxes to compute their values.

Creates a new *TransformNode*.

shorthand_name - a string representing the “name” of this transform. The name carries no significance other than to improve the readability of `str(transform)` when `DEBUG=True`.

frozen()

Returns a frozen copy of this transform node. The frozen copy will not update when its children change. Useful for storing a previously known state of a transform where `copy.deepcopy()` might normally be used.

invalidate()

Invalidate this *TransformNode* and triggers an invalidation of its ancestors. Should be called any time the transform changes.

pass_through = False

If `pass_through` is `True`, all ancestors will always be invalidated, even if ‘self’ is already invalid.

set_children(*children)

Set the children of the transform, to let the invalidation system know which transforms can invalidate this transform. Should be called from the constructor of any transforms that depend on other transforms.

class matplotlib.transforms.**BboxBase**(*shorthand_name=None*)

Bases: *matplotlib.transforms.TransformNode*

This is the base class of all bounding boxes, and provides read-only access to its data. A mutable bounding box is provided by the *Bbox* class.

The canonical representation is as two points, with no restrictions on their ordering. Convenience properties are provided to get the left, bottom, right and top edges and width and height, but these are not stored explicitly.

Creates a new *TransformNode*.

shorthand_name - a string representing the “name” of this transform. The name carries no significance other than to improve the readability of `str(transform)` when `DEBUG=True`.

anchored(c, container=None)

Return a copy of the *Bbox*, shifted to position *c* within a container.

c: may be either:

- a sequence (*cx*, *cy*) where *cx* and *cy* range from 0 to 1, where 0 is left or bottom and 1 is right or top
- a string: - ‘C’ for centered - ‘S’ for bottom-center - ‘SE’ for bottom-left - ‘E’ for left - etc.

Optional argument *container* is the box within which the *Bbox* is positioned; it defaults to the initial *Bbox*.

bounds

(property) Returns $(x_0, y_0, width, height)$.

contains (x, y)

Returns *True* if (x, y) is a coordinate inside the bounding box or on its edge.

containsx (x)

Returns *True* if x is between or equal to x_0 and x_1 .

containsy (y)

Returns *True* if y is between or equal to y_0 and y_1 .

corners $()$

Return an array of points which are the four corners of this rectangle. For example, if this *Bbox* is defined by the points (a, b) and (c, d) , *corners()* returns (a, b) , (a, d) , (c, b) and (c, d) .

count_contains $(vertices)$

Count the number of vertices contained in the *Bbox*.

vertices is a Nx2 Numpy array.

count_overlaps $(bboxes)$

Count the number of bounding boxes that overlap this one.

bboxes is a sequence of *BboxBase* objects

expanded (sw, sh)

Return a new *Bbox* which is this *Bbox* expanded around its center by the given factors *sw* and *sh*.

extents

(property) Returns (x_0, y_0, x_1, y_1) .

frozen $()$

TransformNode is the base class for anything that participates in the transform tree and needs to invalidate its parents or be invalidated. This includes classes that are not really transforms, such as bounding boxes, since some transforms depend on bounding boxes to compute their values.

fully_contains (x, y)

Returns *True* if (x, y) is a coordinate inside the bounding box, but not on its edge.

fully_containsx (x)

Returns *True* if x is between but not equal to x_0 and x_1 .

fully_containsy (y)

Returns *True* if y is between but not equal to y_0 and y_1 .

fully_overlaps $(other)$

Returns *True* if this bounding box overlaps with the given bounding box *other*, but not on its edge alone.

height

(property) The height of the bounding box. It may be negative if $y_1 < y_0$.

static intersection(*bbox1*, *bbox2*)

Return the intersection of the two bboxes or None if they do not intersect.

Implements the algorithm described at:

<http://www.tekpool.com/node/2687>

intervalx

(property) *intervalx* is the pair of *x* coordinates that define the bounding box. It is not guaranteed to be sorted from left to right.

intervaly

(property) *intervaly* is the pair of *y* coordinates that define the bounding box. It is not guaranteed to be sorted from bottom to top.

inverse_transformed(*transform*)

Return a new *Bbox* object, statically transformed by the inverse of the given transform.

is_unit()

Returns True if the *Bbox* is the unit bounding box from (0, 0) to (1, 1).

max

(property) *max* is the top-right corner of the bounding box.

min

(property) *min* is the bottom-left corner of the bounding box.

overlaps(*other*)

Returns True if this bounding box overlaps with the given bounding box *other*.

p0

(property) *p0* is the first pair of (*x*, *y*) coordinates that define the bounding box. It is not guaranteed to be the bottom-left corner. For that, use *min*.

p1

(property) *p1* is the second pair of (*x*, *y*) coordinates that define the bounding box. It is not guaranteed to be the top-right corner. For that, use *max*.

padded(*p*)

Return a new *Bbox* that is padded on all four sides by the given value.

rotated(*radians*)

Return a new bounding box that bounds a rotated version of this bounding box by the given radians. The new bounding box is still aligned with the axes, of course.

shrunk(*mx*, *my*)

Return a copy of the *Bbox*, shrunk by the factor *mx* in the *x* direction and the factor *my* in the *y* direction. The lower left corner of the box remains unchanged. Normally *mx* and *my* will be less than 1, but this is not enforced.

shrunk_to_aspect(*box_aspect*, *container=None*, *fig_aspect=1.0*)

Return a copy of the *Bbox*, shrunk so that it is as large as it can be while having the desired aspect ratio, *box_aspect*. If the box coordinates are relative—that is, fractions of a larger box such as a figure—then the physical aspect ratio of that figure is specified with *fig_aspect*, so that *box_aspect* can also be given as a ratio of the absolute dimensions, not the relative dimensions.

size

(property) The width and height of the bounding box. May be negative, in the same way as *width* and *height*.

splitx(*args)

e.g., `bbox.splitx(f1, f2, ...)`

Returns a list of new *Bbox* objects formed by splitting the original one with vertical lines at fractional positions *f1*, *f2*, ...

splity(*args)

e.g., `bbox.splity(f1, f2, ...)`

Returns a list of new *Bbox* objects formed by splitting the original one with horizontal lines at fractional positions *f1*, *f2*, ...

transformed(transform)

Return a new *Bbox* object, statically transformed by the given transform.

translated(tx, ty)

Return a copy of the *Bbox*, statically translated by *tx* and *ty*.

static union(bboxes)

Return a *Bbox* that contains all of the given bboxes.

width

(property) The width of the bounding box. It may be negative if $x1 < x0$.

x0

(property) *x0* is the first of the pair of *x* coordinates that define the bounding box. *x0* is not guaranteed to be less than *x1*. If you require that, use *xmin*.

x1

(property) *x1* is the second of the pair of *x* coordinates that define the bounding box. *x1* is not guaranteed to be greater than *x0*. If you require that, use *xmax*.

xmax

(property) *xmax* is the right edge of the bounding box.

xmin

(property) *xmin* is the left edge of the bounding box.

y0

(property) *y0* is the first of the pair of *y* coordinates that define the bounding box. *y0* is not guaranteed to be less than *y1*. If you require that, use *ymin*.

y1

(property) *y1* is the second of the pair of *y* coordinates that define the bounding box. *y1* is not guaranteed to be greater than *y0*. If you require that, use *ymax*.

ymax

(property) *ymax* is the top edge of the bounding box.

ymin

(property) *ymin* is the bottom edge of the bounding box.

class `matplotlib.transforms.Bbox`(*points*, ***kwargs*)

Bases: `matplotlib.transforms.BboxBase`

A mutable bounding box.

points: a 2x2 numpy array of the form `[[x0, y0], [x1, y1]]`

If you need to create a `Bbox` object from another form of data, consider the static methods `unit()`, `from_bounds()` and `from_extents()`.

static `from_bounds`(*x0*, *y0*, *width*, *height*)

(staticmethod) Create a new `Bbox` from *x0*, *y0*, *width* and *height*.

width and *height* may be negative.

static `from_extents`(**args*)

(staticmethod) Create a new `Bbox` from *left*, *bottom*, *right* and *top*.

The y-axis increases upwards.

get_points()

Get the points of the bounding box directly as a numpy array of the form: `[[x0, y0], [x1, y1]]`.

ignore(*value*)

Set whether the existing bounds of the box should be ignored by subsequent calls to `update_from_data_xy()`.

value:

- When True, subsequent calls to `update_from_data_xy()` will ignore the existing bounds of the `Bbox`.
- When False, subsequent calls to `update_from_data_xy()` will include the existing bounds of the `Bbox`.

mutated()

return whether the bbox has changed since init

mutatedx()

return whether the x-limits have changed since init

mutatedy()

return whether the y-limits have changed since init

static `null`()

(staticmethod) Create a new null `Bbox` from (inf, inf) to (-inf, -inf).

set(*other*)

Set this bounding box from the “frozen” bounds of another `Bbox`.

set_points(*points*)

Set the points of the bounding box directly from a numpy array of the form: `[[x0, y0], [x1, y1]]`. No error checking is performed, as this method is mainly for internal use.

static `unit`()

(staticmethod) Create a new unit `Bbox` from (0, 0) to (1, 1).

update_from_data(*x*, *y*, *ignore=None*)

Deprecated since version 2.0: The `update_from_data` function was deprecated in version 2.0. Use `update_from_data_xy` instead.

Update the bounds of the *Bbox* based on the passed in data. After updating, the bounds will have positive *width* and *height*; *x0* and *y0* will be the minimal values.

x: a numpy array of *x*-values

y: a numpy array of *y*-values

ignore:

- when True, ignore the existing bounds of the *Bbox*.
- when False, include the existing bounds of the *Bbox*.
- when None, use the last value passed to `ignore()`.

update_from_data_xy(*xy*, *ignore=None*, *updatex=True*, *updatey=True*)

Update the bounds of the *Bbox* based on the passed in data. After updating, the bounds will have positive *width* and *height*; *x0* and *y0* will be the minimal values.

xy: a numpy array of 2D points

ignore:

- when True, ignore the existing bounds of the *Bbox*.
- when False, include the existing bounds of the *Bbox*.
- when None, use the last value passed to `ignore()`.

updatex: when True, update the x values

updatey: when True, update the y values

update_from_path(*path*, *ignore=None*, *updatex=True*, *updatey=True*)

Update the bounds of the *Bbox* based on the passed in data. After updating, the bounds will have positive *width* and *height*; *x0* and *y0* will be the minimal values.

path: a *Path* instance

ignore:

- when True, ignore the existing bounds of the *Bbox*.
- when False, include the existing bounds of the *Bbox*.
- when None, use the last value passed to `ignore()`.

updatex: when True, update the x values

updatey: when True, update the y values

class `matplotlib.transforms.TransformBbox`(*bbox*, *transform*, ***kwargs*)

Bases: `matplotlib.transforms.BboxBase`

A *Bbox* that is automatically transformed by a given transform. When either the child bounding box or transform changes, the bounds of this *bbox* will update accordingly.

bbox: a child *Bbox*

transform: a 2D *Transform*

get_points()

Get the points of the bounding box directly as a numpy array of the form: `[[x0, y0], [x1, y1]]`.

class `matplotlib.transforms.Transform`(*shorthand_name=None*)

Bases: `matplotlib.transforms.TransformNode`

The base class of all *TransformNode* instances that actually perform a transformation.

All non-affine transformations should be subclasses of this class. New affine transformations should be subclasses of *Affine2D*.

Subclasses of this class should override the following members (at minimum):

- *input_dims*
- *output_dims*
- *transform()*
- *is_separable*
- *has_inverse*
- *inverted()* (if *has_inverse* is True)

If the transform needs to do something non-standard with `matplotlib.path.Path` objects, such as adding curves where there were once line segments, it should override:

- *transform_path()*

Creates a new *TransformNode*.

shorthand_name - a string representing the “name” of this transform. The name carries no significance other than to improve the readability of `str(transform)` when `DEBUG=True`.

contains_branch(*other*)

Return whether the given transform is a sub-tree of this transform.

This routine uses transform equality to identify sub-trees, therefore in many situations it is object id which will be used.

For the case where the given transform represents the whole of this transform, returns True.

contains_branch_seperately(*other_transform*)

Returns whether the given branch is a sub-tree of this transform on each seperate dimension.

A common use for this method is to identify if a transform is a blended transform containing an axes’ data transform. e.g.:

```
x_isdata, y_isdata = trans.contains_branch_seperately(ax.transData)
```

depth

Returns the number of transforms which have been chained together to form this Transform instance.

Note: For the special case of a Composite transform, the maximum depth of the two is returned.

get_affine()

Get the affine part of this transform.

get_matrix()

Get the Affine transformation array for the affine part of this transform.

has_inverse = False

True if this transform has a corresponding inverse transform.

input_dims = None

The number of input dimensions of this transform. Must be overridden (with integers) in the subclass.

inverted()

Return the corresponding inverse transformation.

The return value of this method should be treated as temporary. An update to *self* does not cause a corresponding update to its inverted copy.

```
x === self.inverted().transform(self.transform(x))
```

is_separable = False

True if this transform is separable in the x- and y- dimensions.

output_dims = None

The number of output dimensions of this transform. Must be overridden (with integers) in the subclass.

transform(values)

Performs the transformation on the given array of values.

Accepts a numpy array of shape (N x *input_dims*) and returns a numpy array of shape (N x *output_dims*).

Alternatively, accepts a numpy array of length *input_dims* and returns a numpy array of length *output_dims*.

transform_affine(values)

Performs only the affine part of this transformation on the given array of values.

`transform(values)` is always equivalent to `transform_affine(transform_non_affine(values))`.

In non-affine transformations, this is generally a no-op. In affine transformations, this is equivalent to `transform(values)`.

Accepts a numpy array of shape (N x *input_dims*) and returns a numpy array of shape (N x *output_dims*).

Alternatively, accepts a numpy array of length *input_dims* and returns a numpy array of length *output_dims*.

transform_angles(angles, pts, radians=False, pushoff=1e-05)

Performs transformation on a set of angles anchored at specific locations.

The *angles* must be a column vector (i.e., numpy array).

The *pts* must be a two-column numpy array of x,y positions (angle transforms currently only work in 2D). This array must have the same number of rows as *angles*.

radians indicates whether or not input angles are given in radians (True) or degrees (False; the default).

pushoff is the distance to move away from *pts* for determining transformed angles (see discussion of method below).

The transformed angles are returned in an array with the same size as *angles*.

The generic version of this method uses a very generic algorithm that transforms *pts*, as well as locations very close to *pts*, to find the angle in the transformed system.

transform_bbox(*bbox*)

Transform the given bounding box.

Note, for smarter transforms including caching (a common requirement for matplotlib figures), see [TransformedBbox](#).

transform_non_affine(*values*)

Performs only the non-affine part of the transformation.

`transform(values)` is always equivalent to `transform_affine(transform_non_affine(values))`.

In non-affine transformations, this is generally equivalent to `transform(values)`. In affine transformations, this is always a no-op.

Accepts a numpy array of shape (N x *input_dims*) and returns a numpy array of shape (N x *output_dims*).

Alternatively, accepts a numpy array of length *input_dims* and returns a numpy array of length *output_dims*.

transform_path(*path*)

Returns a transformed path.

path: a [Path](#) instance.

In some cases, this transform may insert curves into the path that began as line segments.

transform_path_affine(*path*)

Returns a path, transformed only by the affine part of this transform.

path: a [Path](#) instance.

`transform_path(path)` is equivalent to `transform_path_affine(transform_path_non_affine(values))`.

transform_path_non_affine(*path*)

Returns a path, transformed only by the non-affine part of this transform.

path: a [Path](#) instance.

`transform_path(path)` is equivalent to `transform_path_affine(transform_path_non_affine(values))`.

transform_point(*point*)

A convenience function that returns the transformed copy of a single point.

The point is given as a sequence of length *input_dims*. The transformed point is returned as a sequence of length *output_dims*.

class matplotlib.transforms.TransformWrapper(*child*)

Bases: *matplotlib.transforms.Transform*

A helper class that holds a single child transform and acts equivalently to it.

This is useful if a node of the transform tree must be replaced at run time with a transform of a different type. This class allows that replacement to correctly trigger invalidation.

Note that *TransformWrapper* instances must have the same input and output dimensions during their entire lifetime, so the child transform may only be replaced with another child transform of the same dimensions.

child: A class:*Transform* instance. This child may later be replaced with *set()*.

frozen()

Returns a frozen copy of this transform node. The frozen copy will not update when its children change. Useful for storing a previously known state of a transform where *copy.deepcopy()* might normally be used.

set(*child*)

Replace the current child of this transform with another one.

The new child must have the same number of input and output dimensions as the current child.

class matplotlib.transforms.AffineBase(**args*, ***kwargs*)

Bases: *matplotlib.transforms.Transform*

The base class of all affine transformations of any number of dimensions.

get_affine()

Get the affine part of this transform.

transform(*values*)

Performs the transformation on the given array of values.

Accepts a numpy array of shape (N x *input_dims*) and returns a numpy array of shape (N x *output_dims*).

Alternatively, accepts a numpy array of length *input_dims* and returns a numpy array of length *output_dims*.

transform_affine(*values*)

Performs only the affine part of this transformation on the given array of values.

transform(values) is always equivalent to *transform_affine(transform_non_affine(values))*.

In non-affine transformations, this is generally a no-op. In affine transformations, this is equivalent to *transform(values)*.

Accepts a numpy array of shape (N x *input_dims*) and returns a numpy array of shape (N x *output_dims*).

Alternatively, accepts a numpy array of length `input_dims` and returns a numpy array of length `output_dims`.

transform_non_affine(*points*)

Performs only the non-affine part of the transformation.

`transform(values)` is always equivalent to `transform_affine(transform_non_affine(values))`.

In non-affine transformations, this is generally equivalent to `transform(values)`. In affine transformations, this is always a no-op.

Accepts a numpy array of shape (N x `input_dims`) and returns a numpy array of shape (N x `output_dims`).

Alternatively, accepts a numpy array of length `input_dims` and returns a numpy array of length `output_dims`.

transform_path(*path*)

Returns a transformed path.

path: a [Path](#) instance.

In some cases, this transform may insert curves into the path that began as line segments.

transform_path_affine(*path*)

Returns a path, transformed only by the affine part of this transform.

path: a [Path](#) instance.

`transform_path(path)` is equivalent to `transform_path_affine(transform_path_non_affine(values))`.

transform_path_non_affine(*path*)

Returns a path, transformed only by the non-affine part of this transform.

path: a [Path](#) instance.

`transform_path(path)` is equivalent to `transform_path_affine(transform_path_non_affine(values))`.

class `matplotlib.transforms.Affine2DBase`(*args, **kwargs)

Bases: [matplotlib.transforms.AffineBase](#)

The base class of all 2D affine transformations.

2D affine transformations are performed using a 3x3 numpy array:

```
a c e
b d f
0 0 1
```

This class provides the read-only interface. For a mutable 2D affine transformation, use [Affine2D](#).

Subclasses of this class will generally only need to override a constructor and `get_matrix()` that generates a custom 3x3 matrix.

frozen()

Returns a frozen copy of this transform node. The frozen copy will not update when its children change. Useful for storing a previously known state of a transform where `copy.deepcopy()` might normally be used.

inverted()

Return the corresponding inverse transformation.

The return value of this method should be treated as temporary. An update to *self* does not cause a corresponding update to its inverted copy.

```
x === self.inverted().transform(self.transform(x))
```

static matrix_from_values(*a, b, c, d, e, f*)

(staticmethod) Create a new transformation matrix as a 3x3 numpy array of the form:

```
a c e
b d f
0 0 1
```

to_values()

Return the values of the matrix as a sequence (a,b,c,d,e,f)

transform_affine(*points*)

Performs only the affine part of this transformation on the given array of values.

`transform(values)` is always equivalent to `transform_affine(transform_non_affine(values))`.

In non-affine transformations, this is generally a no-op. In affine transformations, this is equivalent to `transform(values)`.

Accepts a numpy array of shape (N x `input_dims`) and returns a numpy array of shape (N x `output_dims`).

Alternatively, accepts a numpy array of length `input_dims` and returns a numpy array of length `output_dims`.

transform_point(*point*)

A convenience function that returns the transformed copy of a single point.

The point is given as a sequence of length `input_dims`. The transformed point is returned as a sequence of length `output_dims`.

class matplotlib.transforms.Affine2D(*matrix=None, **kwargs*)

Bases: `matplotlib.transforms.Affine2DBase`

A mutable 2D affine transformation.

Initialize an Affine transform from a 3x3 numpy float array:

```
a c e
b d f
0 0 1
```

If *matrix* is None, initialize with the identity transform.

clear()

Reset the underlying matrix to the identity transform.

static from_values(*a, b, c, d, e, f*)

(staticmethod) Create a new Affine2D instance from the given values:

```
a c e
b d f
0 0 1
```

get_matrix()

Get the underlying transformation matrix as a 3x3 numpy array:

```
a c e
b d f
0 0 1
```

static identity()

(staticmethod) Return a new *Affine2D* object that is the identity transform.

Unless this transform will be mutated later on, consider using the faster *IdentityTransform* class instead.

rotate(theta)

Add a rotation (in radians) to this transform in place.

Returns *self*, so this method can easily be chained with more calls to *rotate()*, *rotate_deg()*, *translate()* and *scale()*.

rotate_around(x, y, theta)

Add a rotation (in radians) around the point (x, y) in place.

Returns *self*, so this method can easily be chained with more calls to *rotate()*, *rotate_deg()*, *translate()* and *scale()*.

rotate_deg(degrees)

Add a rotation (in degrees) to this transform in place.

Returns *self*, so this method can easily be chained with more calls to *rotate()*, *rotate_deg()*, *translate()* and *scale()*.

rotate_deg_around(x, y, degrees)

Add a rotation (in degrees) around the point (x, y) in place.

Returns *self*, so this method can easily be chained with more calls to *rotate()*, *rotate_deg()*, *translate()* and *scale()*.

scale(sx, sy=None)

Adds a scale in place.

If *sy* is None, the same scale is applied in both the *x*- and *y*-directions.

Returns *self*, so this method can easily be chained with more calls to *rotate()*, *rotate_deg()*, *translate()* and *scale()*.

set(other)

Set this transformation from the frozen copy of another *Affine2DBase* object.

set_matrix(*mtx*)

Set the underlying transformation matrix from a 3x3 numpy array:

```
a c e
b d f
0 0 1
```

skew(*xShear*, *yShear*)

Adds a skew in place.

xShear and *yShear* are the shear angles along the *x*- and *y*-axes, respectively, in radians.

Returns *self*, so this method can easily be chained with more calls to `rotate()`, `rotate_deg()`, `translate()` and `scale()`.

skew_deg(*xShear*, *yShear*)

Adds a skew in place.

xShear and *yShear* are the shear angles along the *x*- and *y*-axes, respectively, in degrees.

Returns *self*, so this method can easily be chained with more calls to `rotate()`, `rotate_deg()`, `translate()` and `scale()`.

translate(*tx*, *ty*)

Adds a translation in place.

Returns *self*, so this method can easily be chained with more calls to `rotate()`, `rotate_deg()`, `translate()` and `scale()`.

class matplotlib.transforms.IdentityTransform(*args, **kwargs)

Bases: `matplotlib.transforms.Affine2DBase`

A special class that does one thing, the identity transform, in a fast way.

frozen()

Returns a frozen copy of this transform node. The frozen copy will not update when its children change. Useful for storing a previously known state of a transform where `copy.deepcopy()` might normally be used.

get_affine()

Return the corresponding inverse transformation.

The return value of this method should be treated as temporary. An update to *self* does not cause a corresponding update to its inverted copy.

```
x === self.inverted().transform(self.transform(x))
```

get_matrix()

Get the Affine transformation array for the affine part of this transform.

inverted()

Return the corresponding inverse transformation.

The return value of this method should be treated as temporary. An update to *self* does not cause a corresponding update to its inverted copy.

```
x === self.inverted().transform(self.transform(x))
```

transform(*points*)

Performs only the non-affine part of the transformation.

`transform(values)` is always equivalent to `transform_affine(transform_non_affine(values))`.

In non-affine transformations, this is generally equivalent to `transform(values)`. In affine transformations, this is always a no-op.

Accepts a numpy array of shape (N x `input_dims`) and returns a numpy array of shape (N x `output_dims`).

Alternatively, accepts a numpy array of length `input_dims` and returns a numpy array of length `output_dims`.

transform_affine(*points*)

Performs only the non-affine part of the transformation.

`transform(values)` is always equivalent to `transform_affine(transform_non_affine(values))`.

In non-affine transformations, this is generally equivalent to `transform(values)`. In affine transformations, this is always a no-op.

Accepts a numpy array of shape (N x `input_dims`) and returns a numpy array of shape (N x `output_dims`).

Alternatively, accepts a numpy array of length `input_dims` and returns a numpy array of length `output_dims`.

transform_non_affine(*points*)

Performs only the non-affine part of the transformation.

`transform(values)` is always equivalent to `transform_affine(transform_non_affine(values))`.

In non-affine transformations, this is generally equivalent to `transform(values)`. In affine transformations, this is always a no-op.

Accepts a numpy array of shape (N x `input_dims`) and returns a numpy array of shape (N x `output_dims`).

Alternatively, accepts a numpy array of length `input_dims` and returns a numpy array of length `output_dims`.

transform_path(*path*)

Returns a path, transformed only by the non-affine part of this transform.

path: a [Path](#) instance.

`transform_path(path)` is equivalent to `transform_path_affine(transform_path_non_affine(values))`.

transform_path_affine(*path*)

Returns a path, transformed only by the non-affine part of this transform.

path: a [Path](#) instance.

`transform_path(path)` is equivalent to `transform_path_affine(transform_path_non_affine(values))`.

transform_path_non_affine(*path*)

Returns a path, transformed only by the non-affine part of this transform.

path: a *Path* instance.

`transform_path(path)` is equivalent to `transform_path_affine(transform_path_non_affine(values))`.

class `matplotlib.transforms.BlendedGenericTransform`(*x_transform*, *y_transform*,
***kwargs*)

Bases: `matplotlib.transforms.Transform`

A “blended” transform uses one transform for the *x*-direction, and another transform for the *y*-direction.

This “generic” version can handle any given child transform in the *x*- and *y*-directions.

Create a new “blended” transform using *x_transform* to transform the *x*-axis and *y_transform* to transform the *y*-axis.

You will generally not call this constructor directly but use the `blended_transform_factory()` function instead, which can determine automatically which kind of blended transform to create.

frozen()

Returns a frozen copy of this transform node. The frozen copy will not update when its children change. Useful for storing a previously known state of a transform where `copy.deepcopy()` might normally be used.

get_affine()

Get the affine part of this transform.

inverted()

Return the corresponding inverse transformation.

The return value of this method should be treated as temporary. An update to *self* does not cause a corresponding update to its inverted copy.

```
x === self.inverted().transform(self.transform(x))
```

transform_non_affine(*points*)

Performs only the non-affine part of the transformation.

`transform(values)` is always equivalent to `transform_affine(transform_non_affine(values))`.

In non-affine transformations, this is generally equivalent to `transform(values)`. In affine transformations, this is always a no-op.

Accepts a numpy array of shape (N x *input_dims*) and returns a numpy array of shape (N x *output_dims*).

Alternatively, accepts a numpy array of length *input_dims* and returns a numpy array of length *output_dims*.

class `matplotlib.transforms.BlendedAffine2D`(*x_transform*, *y_transform*, ***kwargs*)

Bases: `matplotlib.transforms.Affine2DBase`

A “blended” transform uses one transform for the *x*-direction, and another transform for the *y*-direction.

This version is an optimization for the case where both child transforms are of type *Affine2DBase*.

Create a new “blended” transform using *x_transform* to transform the *x*-axis and *y_transform* to transform the *y*-axis.

Both *x_transform* and *y_transform* must be 2D affine transforms.

You will generally not call this constructor directly but use the *blended_transform_factory()* function instead, which can determine automatically which kind of blended transform to create.

get_matrix()

Get the Affine transformation array for the affine part of this transform.

`matplotlib.transforms.blended_transform_factory(x_transform, y_transform)`

Create a new “blended” transform using *x_transform* to transform the *x*-axis and *y_transform* to transform the *y*-axis.

A faster version of the blended transform is returned for the case where both child transforms are affine.

class `matplotlib.transforms.CompositeGenericTransform(a, b, **kwargs)`

Bases: *matplotlib.transforms.Transform*

A composite transform formed by applying transform *a* then transform *b*.

This “generic” version can handle any two arbitrary transformations.

Create a new composite transform that is the result of applying transform *a* then transform *b*.

You will generally not call this constructor directly but use the *composite_transform_factory()* function instead, which can automatically choose the best kind of composite transform instance to create.

frozen()

Returns a frozen copy of this transform node. The frozen copy will not update when its children change. Useful for storing a previously known state of a transform where `copy.deepcopy()` might normally be used.

get_affine()

Get the affine part of this transform.

inverted()

Return the corresponding inverse transformation.

The return value of this method should be treated as temporary. An update to *self* does not cause a corresponding update to its inverted copy.

```
x === self.inverted().transform(self.transform(x))
```

transform_affine(points)

Performs only the affine part of this transformation on the given array of values.

`transform(values)` is always equivalent to `transform_affine(transform_non_affine(values))`.

In non-affine transformations, this is generally a no-op. In affine transformations, this is equivalent to `transform(values)`.

Accepts a numpy array of shape (N x input_dims) and returns a numpy array of shape (N x output_dims).

Alternatively, accepts a numpy array of length input_dims and returns a numpy array of length output_dims.

transform_non_affine(*points*)

Performs only the non-affine part of the transformation.

`transform(values)` is always equivalent to `transform_affine(transform_non_affine(values))`.

In non-affine transformations, this is generally equivalent to `transform(values)`. In affine transformations, this is always a no-op.

Accepts a numpy array of shape (N x input_dims) and returns a numpy array of shape (N x output_dims).

Alternatively, accepts a numpy array of length input_dims and returns a numpy array of length output_dims.

transform_path_non_affine(*path*)

Returns a path, transformed only by the non-affine part of this transform.

path: a *Path* instance.

`transform_path(path)` is equivalent to `transform_path_affine(transform_path_non_affine(values))`.

class matplotlib.transforms.CompositeAffine2D(*a*, *b*, ***kwargs*)

Bases: *matplotlib.transforms.Affine2DBase*

A composite transform formed by applying transform *a* then transform *b*.

This version is an optimization that handles the case where both *a* and *b* are 2D affines.

Create a new composite transform that is the result of applying transform *a* then transform *b*.

Both *a* and *b* must be instances of *Affine2DBase*.

You will generally not call this constructor directly but use the *composite_transform_factory()* function instead, which can automatically choose the best kind of composite transform instance to create.

get_matrix()

Get the Affine transformation array for the affine part of this transform.

matplotlib.transforms.composite_transform_factory(*a*, *b*)

Create a new composite transform that is the result of applying transform *a* then transform *b*.

Shortcut versions of the blended transform are provided for the case where both child transforms are affine, or one or the other is the identity transform.

Composite transforms may also be created using the '+' operator, e.g.:

$c = a + b$

class matplotlib.transforms.BboxTransform(*boxin*, *boxout*, ***kwargs*)

Bases: *matplotlib.transforms.Affine2DBase*

BboxTransform linearly transforms points from one *Bbox* to another *Bbox*.

Create a new *BboxTransform* that linearly transforms points from *boxin* to *boxout*.

get_matrix()

Get the Affine transformation array for the affine part of this transform.

class matplotlib.transforms.BboxTransformTo(*boxout*, ****kwargs**)

Bases: *matplotlib.transforms.Affine2DBase*

BboxTransformTo is a transformation that linearly transforms points from the unit bounding box to a given *Bbox*.

Create a new *BboxTransformTo* that linearly transforms points from the unit bounding box to *boxout*.

get_matrix()

Get the Affine transformation array for the affine part of this transform.

class matplotlib.transforms.BboxTransformFrom(*boxin*, ****kwargs**)

Bases: *matplotlib.transforms.Affine2DBase*

BboxTransformFrom linearly transforms points from a given *Bbox* to the unit bounding box.

get_matrix()

Get the Affine transformation array for the affine part of this transform.

class matplotlib.transforms.ScaledTranslation(*xt*, *yt*, *scale_trans*, ****kwargs**)

Bases: *matplotlib.transforms.Affine2DBase*

A transformation that translates by *xt* and *yt*, after *xt* and *yt* have been transformed by the given transform *scale_trans*.

get_matrix()

Get the Affine transformation array for the affine part of this transform.

class matplotlib.transforms.TransformedPath(*path*, *transform*)

Bases: *matplotlib.transforms.TransformNode*

A *TransformedPath* caches a non-affine transformed copy of the *Path*. This cached copy is automatically updated when the non-affine part of the transform changes.

Note: Paths are considered immutable by this class. Any update to the path's vertices/codes will not trigger a transform recomputation.

Create a new *TransformedPath* from the given *Path* and *Transform*.

get_fully_transformed_path()

Return a fully-transformed copy of the child path.

get_transformed_path_and_affine()

Return a copy of the child path, with the non-affine part of the transform already applied, along with the affine part of the path necessary to complete the transformation.

get_transformed_points_and_affine()

Return a copy of the child path, with the non-affine part of the transform already applied, along with the affine part of the path necessary to complete the transformation. Unlike `get_transformed_path_and_affine()`, no interpolation will be performed.

`matplotlib.transforms.nonsingular(vmin, vmax, expander=0.001, tiny=1e-15, increasing=True)`

Modify the endpoints of a range as needed to avoid singularities.

vmin, *vmax* the initial endpoints.

tiny threshold for the ratio of the interval to the maximum absolute value of its endpoints. If the interval is smaller than this, it will be expanded. This value should be around 1e-15 or larger; otherwise the interval will be approaching the double precision resolution limit.

expander fractional amount by which *vmin* and *vmax* are expanded if the original interval is too small, based on *tiny*.

increasing: [**True** | **False**] If True (default), swap *vmin*, *vmax* if *vmin* > *vmax*

Returns *vmin*, *vmax*, expanded and/or swapped if necessary.

If either input is inf or NaN, or if both inputs are 0 or very close to zero, it returns *-expander*, *expander*.

TRIANGULAR GRIDS

55.1 matplotlib.tri

Unstructured triangular grid functions.

class matplotlib.tri.Triangulation(*x*, *y*, *triangles=None*, *mask=None*)

An unstructured triangular grid consisting of *npoints* points and *ntri* triangles. The triangles can either be specified by the user or automatically generated using a Delaunay triangulation.

Parameters *x*, *y* : array_like of shape (*npoints*)

Coordinates of grid points.

triangles : integer array_like of shape (*ntri*, 3), optional

For each triangle, the indices of the three points that make up the triangle, ordered in an anticlockwise manner. If not specified, the Delaunay triangulation is calculated.

mask : boolean array_like of shape (*ntri*), optional

Which triangles are masked out.

Notes

For a Triangulation to be valid it must not have duplicate points, triangles formed from colinear points, or overlapping triangles.

Attributes

<i>edges</i>	
<i>neighbors</i>	
<i>is_delaunay</i> (bool)	Whether the Triangulation is a calculated Delaunay triangulation (where <i>triangles</i> was not specified) or not.

calculate_plane_coefficients(*z*)

Calculate plane equation coefficients for all unmasked triangles from the point (*x*,*y*) coordinates and specified *z*-array of shape (*npoints*). Returned array has shape (*npoints*,3) and allows

z-value at (x,y) position in triangle tri to be calculated using $z = \text{array}[\text{tri},0]*x + \text{array}[\text{tri},1]*y + \text{array}[\text{tri},2]$.

edges

Return integer array of shape (nedges,2) containing all edges of non-masked triangles.

Each edge is the start point index and end point index. Each edge (start,end and end,start) appears only once.

static get_from_args_and_kwargs(*args, **kwargs)

Return a Triangulation object from the args and kwargs, and the remaining args and kwargs with the consumed values removed.

There are two alternatives: either the first argument is a Triangulation object, in which case it is returned, or the args and kwargs are sufficient to create a new Triangulation to return. In the latter case, see Triangulation.__init__ for the possible args and kwargs.

get_masked_triangles()

Return an array of triangles that are not masked.

get_trifinder()

Return the default `matplotlib.tri.TriFinder` of this triangulation, creating it if necessary. This allows the same TriFinder object to be easily shared.

neighbors

Return integer array of shape (ntri,3) containing neighbor triangles.

For each triangle, the indices of the three triangles that share the same edges, or -1 if there is no such neighboring triangle. `neighbors[i,j]` is the triangle that is the neighbor to the edge from point index `triangles[i,j]` to point index `triangles[i,(j+1)%3]`.

set_mask(mask)

Set or clear the mask array. This is either None, or a boolean array of shape (ntri).

class matplotlib.tri.TriFinder(triangulation)

Abstract base class for classes used to find the triangles of a Triangulation in which (x,y) points lie.

Rather than instantiate an object of a class derived from TriFinder, it is usually better to use the function `matplotlib.tri.Triangulation.get_trifinder()`.

Derived classes implement `__call__(x,y)` where x,y are array_like point coordinates of the same shape.

class matplotlib.tri.TrapezoidMapTriFinder(triangulation)

Bases: `matplotlib.tri.trifinder.TriFinder`

TriFinder class implemented using the trapezoid map algorithm from the book “Computational Geometry, Algorithms and Applications”, second edition, by M. de Berg, M. van Kreveld, M. Overmars and O. Schwarzkopf.

The triangulation must be valid, i.e. it must not have duplicate points, triangles formed from colinear points, or overlapping triangles. The algorithm has some tolerance to triangles formed from colinear points, but this should not be relied upon.

__call__(x, y)

Return an array containing the indices of the triangles in which the specified x,y points lie, or -1 for points that do not lie within a triangle.

x, y are array_like x and y coordinates of the same shape and any number of dimensions.

Returns integer array with the same shape and x and y .

class matplotlib.tri.TriInterpolator(*triangulation, z, trifinder=None*)

Abstract base class for classes used to perform interpolation on triangular grids.

Derived classes implement the following methods:

- `__call__(x, y)` , where x, y are array_like point coordinates of the same shape, and that returns a masked array of the same shape containing the interpolated z -values.
- `gradient(x, y)` , where x, y are array_like point coordinates of the same shape, and that returns a list of 2 masked arrays of the same shape containing the 2 derivatives of the interpolator (derivatives of interpolated z values with respect to x and y).

class matplotlib.tri.LinearTriInterpolator(*triangulation, z, trifinder=None*)

Bases: matplotlib.tri.triinterpolate.TriInterpolator

A LinearTriInterpolator performs linear interpolation on a triangular grid.

Each triangle is represented by a plane so that an interpolated value at point (x,y) lies on the plane of the triangle containing (x,y) . Interpolated values are therefore continuous across the triangulation, but their first derivatives are discontinuous at edges between triangles.

Parameters triangulation : *Triangulation* object

The triangulation to interpolate over.

z : array_like of shape (npoints,)

Array of values, defined at grid points, to interpolate between.

trifinder : *TriFinder* object, optional

If this is not specified, the Triangulation's default TriFinder will be used by calling `matplotlib.tri.Triangulation.get_trifinder()`.

Methods

<code>__call__(x, y)</code>	(Returns interpolated values at x,y points)
<code>gradient(x, y)</code>	(Returns interpolated derivatives at x,y points)

__call__(x, y)

Returns a masked array containing interpolated values at the specified x,y points.

Parameters x, y : array-like

x and y coordinates of the same shape and any number of dimensions.

Returns z : np.ma.array

Masked array of the same shape as x and y ; values corresponding to (x, y) points outside of the triangulation are masked out.

gradient(x, y)

Returns a list of 2 masked arrays containing interpolated derivatives at the specified x,y points.

Parameters x, y : array-like

x and y coordinates of the same shape and any number of dimensions.

Returns $dzdx, dzdy$: np.ma.array

2 masked arrays of the same shape as x and y ; values corresponding to (x,y) points outside of the triangulation are masked out. The first returned array contains the values of $\frac{\partial z}{\partial x}$ and the second those of $\frac{\partial z}{\partial y}$.

class matplotlib.tri.CubicTriInterpolator(*triangulation, z, kind='min_E', trifinder=None, dz=None*)

Bases: matplotlib.tri.triinterpolate.TriInterpolator

A CubicTriInterpolator performs cubic interpolation on triangular grids.

In one-dimension - on a segment - a cubic interpolating function is defined by the values of the function and its derivative at both ends. This is almost the same in 2-d inside a triangle, except that the values of the function and its 2 derivatives have to be defined at each triangle node.

The CubicTriInterpolator takes the value of the function at each node - provided by the user - and internally computes the value of the derivatives, resulting in a smooth interpolation. (As a special feature, the user can also impose the value of the derivatives at each node, but this is not supposed to be the common usage.)

Parameters *triangulation* : *Triangulation* object

The triangulation to interpolate over.

z : array_like of shape (npoints,)

Array of values, defined at grid points, to interpolate between.

kind : { 'min_E', 'geom', 'user' }, optional

Choice of the smoothing algorithm, in order to compute the interpolant derivatives (defaults to 'min_E'):

- if 'min_E': (default) The derivatives at each node is computed to minimize a bending energy.
- if 'geom': The derivatives at each node is computed as a weighted average of relevant triangle normals. To be used for speed optimization (large grids).
- if 'user': The user provides the argument *dz*, no computation is hence needed.

trifinder : *TriFinder* object, optional

If not specified, the Triangulation's default TriFinder will be used by calling `matplotlib.tri.Triangulation.get_trifinder()`.

dz : tuple of array_likes (*dzdx, dzdy*), optional

Used only if *kind* = 'user'. In this case *dz* must be provided as (*dzdx, dzdy*) where *dzdx, dzdy* are arrays of the same shape as *z* and are the interpolant first derivatives at the *triangulation* points.

Notes

This note is a bit technical and details the way a *CubicTriInterpolator* computes a cubic interpolation.

The interpolation is based on a Clough-Tocher subdivision scheme of the *triangulation* mesh (to make it clearer, each triangle of the grid will be divided in 3 child-triangles, and on each child triangle the interpolated function is a cubic polynomial of the 2 coordinates). This technique originates from FEM (Finite Element Method) analysis; the element used is a reduced Hsieh-Clough-Tocher (HCT) element. Its shape functions are described in [R1]. The assembled function is guaranteed to be C1-smooth, i.e. it is continuous and its first derivatives are also continuous (this is easy to show inside the triangles but is also true when crossing the edges).

In the default case (*kind* = 'min_E'), the interpolant minimizes a curvature energy on the functional space generated by the HCT element shape functions - with imposed values but arbitrary derivatives at each node. The minimized functional is the integral of the so-called total curvature (implementation based on an algorithm from [R2] - PCG sparse solver):

$$E(z) = \frac{1}{2} \int_{\Omega} \left(\left(\frac{\partial^2 z}{\partial x^2} \right)^2 + \left(\frac{\partial^2 z}{\partial y^2} \right)^2 + 2 \left(\frac{\partial^2 z}{\partial y \partial x} \right)^2 \right) dx dy \quad (55.1)$$

If the case *kind* = 'geom' is chosen by the user, a simple geometric approximation is used (weighted average of the triangle normal vectors), which could improve speed on very large grids.

References

[R1], [R2]

Methods

<code>__call__</code> (x, y)	(Returns interpolated values at x,y points)
<code>gradient</code> (x, y)	(Returns interpolated derivatives at x,y points)

`__call__` (x, y)

Returns a masked array containing interpolated values at the specified x,y points.

Parameters *x, y* : array-like

x and *y* coordinates of the same shape and any number of dimensions.

Returns *z* : np.ma.array

Masked array of the same shape as *x* and *y* ; values corresponding to (*x, y*) points outside of the triangulation are masked out.

`gradient` (*x, y*)

Returns a list of 2 masked arrays containing interpolated derivatives at the specified x,y points.

Parameters *x, y* : array-like

x and y coordinates of the same shape and any number of dimensions.

Returns $dzdx, dzdy$: `np.ma.array`

2 masked arrays of the same shape as x and y ; values corresponding to (x,y) points outside of the triangulation are masked out. The first returned array contains the values of $\frac{\partial z}{\partial x}$ and the second those of $\frac{\partial z}{\partial y}$.

Examples

An example of effective application is shown below (plot of the direction of the vector field derivated from a known potential field):

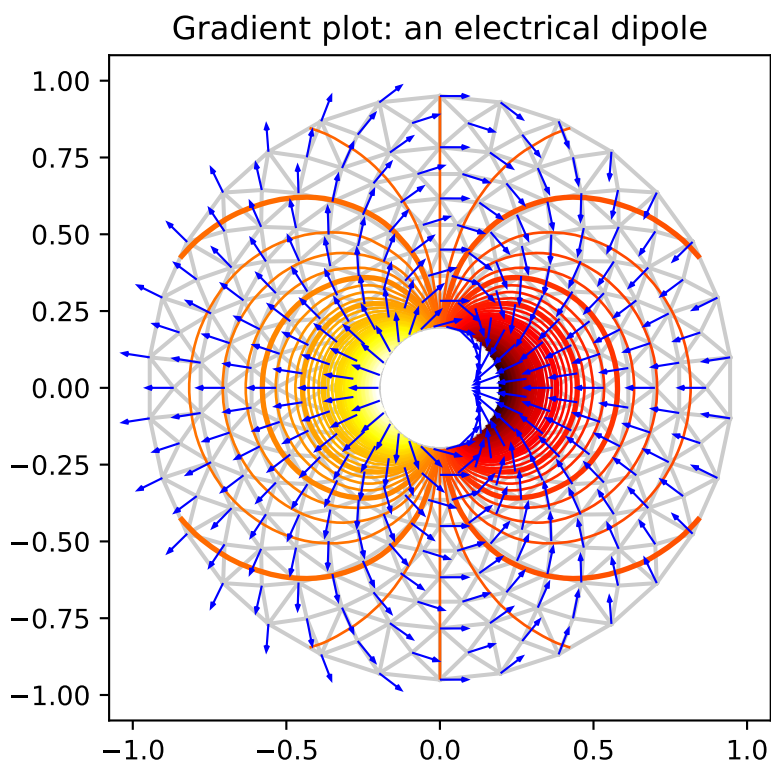

`class matplotlib.tri.TriRefiner(triangulation)`

Abstract base class for classes implementing mesh refinement.

A `TriRefiner` encapsulates a `Triangulation` object and provides tools for mesh refinement and interpolation.

Derived classes must implements:

- `refine_triangulation(return_tri_index=False, **kwargs)` , where the optional keyword arguments `kwargs` are defined in each `TriRefiner` concrete implementation, and which returns :

–a refined triangulation

–optionally (depending on *return_tri_index*), for each point of the refined triangulation: the index of the initial triangulation triangle to which it belongs.

• `refine_field(z, triinterpolator=None, **kwargs)`, where:

–*z* array of field values (to refine) defined at the base triangulation nodes

–*triinterpolator* is a *TriInterpolator* (optional)

–the other optional keyword arguments *kwargs* are defined in each *TriRefiner* concrete implementation

and which returns (as a tuple) a refined triangular mesh and the interpolated values of the field at the refined triangulation nodes.

class `matplotlib.tri.UniformTriRefiner`(*triangulation*)

Bases: `matplotlib.tri.trirefine.TriRefiner`

Uniform mesh refinement by recursive subdivisions.

Parameters *triangulation* : *Triangulation*

The encapsulated triangulation (to be refined)

refine_field(*z, triinterpolator=None, subdiv=3*)

Refines a field defined on the encapsulated triangulation.

Returns *refi_tri* (refined triangulation), *refi_z* (interpolated values of the field at the node of the refined triangulation).

Parameters *z* : 1d-array-like of length *n_points*

Values of the field to refine, defined at the nodes of the encapsulated triangulation. (*n_points* is the number of points in the initial triangulation)

triinterpolator : *TriInterpolator*, optional

Interpolator used for field interpolation. If not specified, a *CubicTriInterpolator* will be used.

subdiv : integer, optional

Recursion level for the subdivision. Defaults to 3. Each triangle will be divided into $4^{**subdiv}$ child triangles.

Returns *refi_tri* : *Triangulation* object

The returned refined triangulation

refi_z : 1d array of length: *refi_tri* node count.

The returned interpolated field (at *refi_tri* nodes)

Examples

The main application of this method is to plot high-quality iso-contours on a coarse triangular grid (e.g., triangulation built from relatively sparse test data):

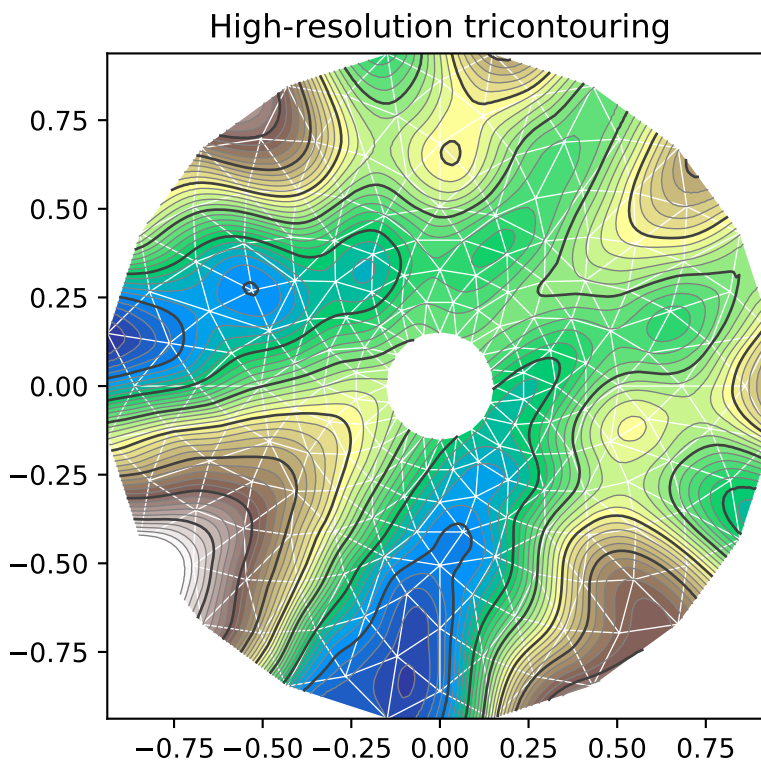

refine_triangulation(*return_tri_index=False, subdiv=3*)

Computes an uniformly refined triangulation *refi_triangulation* of the encapsulated triangulation.

This function refines the encapsulated triangulation by splitting each father triangle into 4 child sub-triangles built on the edges midside nodes, recursively (level of recursion *subdiv*). In the end, each triangle is hence divided into $4^{**}subdiv$ child triangles. The default value for *subdiv* is 3 resulting in 64 refined subtriangles for each triangle of the initial triangulation.

Parameters *return_tri_index* : boolean, optional

Boolean indicating whether an index table indicating the father triangle index of each point will be returned. Default value False.

subdiv : integer, optional

Recursion level for the subdivision. Defaults value 3. Each triangle will be divided into $4^{**}subdiv$ child triangles.

Returns *refi_triangulation* : *Triangulation*

The returned refined triangulation

found_index : array-like of integers

Index of the initial triangulation containing triangle, for each point of *refi_triangulation*. Returned only if *return_tri_index* is set to True.

class matplotlib.tri.TriAnalyzer(*triangulation*)

Define basic tools for triangular mesh analysis and improvement.

A TriAnalyzer encapsulates a *Triangulation* object and provides basic tools for mesh analysis and mesh improvement.

Parameters *triangulation* : *Triangulation* object

The encapsulated triangulation to analyze.

Attributes

<i>scale_factors</i>

circle_ratios(*rescale=True*)

Returns a measure of the triangulation triangles flatness.

The ratio of the incircle radius over the circumcircle radius is a widely used indicator of a triangle flatness. It is always ≤ 0.5 and $= 0.5$ only for equilateral triangles. Circle ratios below 0.01 denote very flat triangles.

To avoid unduly low values due to a difference of scale between the 2 axis, the triangular mesh can first be rescaled to fit inside a unit square with *scale_factors* (Only if *rescale* is True, which is its default value).

Parameters *rescale* : boolean, optional

If True, a rescaling will be internally performed (based on *scale_factors*, so that the (unmasked) triangles fit exactly inside a unit square mesh. Default is True.

Returns *circle_ratios* : masked array

Ratio of the incircle radius over the circumcircle radius, for each 'rescaled' triangle of the encapsulated triangulation. Values corresponding to masked triangles are masked out.

get_flat_tri_mask(*min_circle_ratio=0.01, rescale=True*)

Eliminates excessively flat border triangles from the triangulation.

Returns a mask *new_mask* which allows to clean the encapsulated triangulation from its border-located flat triangles (according to their *circle_ratios()*). This mask is meant to be subsequently applied to the triangulation using *matplotlib.tri.Triangulation.set_mask()*. *new_mask* is an extension of the initial triangulation mask in the sense that an initially masked triangle will remain masked.

The *new_mask* array is computed recursively ; at each step flat triangles are removed only if they share a side with the current mesh border. Thus no new holes in the triangulated domain will be created.

Parameters `min_circle_ratio` : float, optional

Border triangles with incircle/circumcircle radii ratio r/R will be removed if $r/R < min_circle_ratio$. Default value: 0.01

rescale : boolean, optional

If True, a rescaling will first be internally performed (based on `scale_factors`), so that the (unmasked) triangles fit exactly inside a unit square mesh. This rescaling accounts for the difference of scale which might exist between the 2 axis. Default (and recommended) value is True.

Returns `new_mask` : array-like of booleans

Mask to apply to encapsulated triangulation. All the initially masked triangles remain masked in the `new_mask`.

Notes

The rationale behind this function is that a Delaunay triangulation - of an unstructured set of points - sometimes contains almost flat triangles at its border, leading to artifacts in plots (especially for high-resolution contouring). Masked with computed `new_mask`, the encapsulated triangulation would contain no more unmasked border triangles with a circle ratio below `min_circle_ratio`, thus improving the mesh quality for subsequent plots or interpolation.

Examples

Please refer to the following illustrating example:

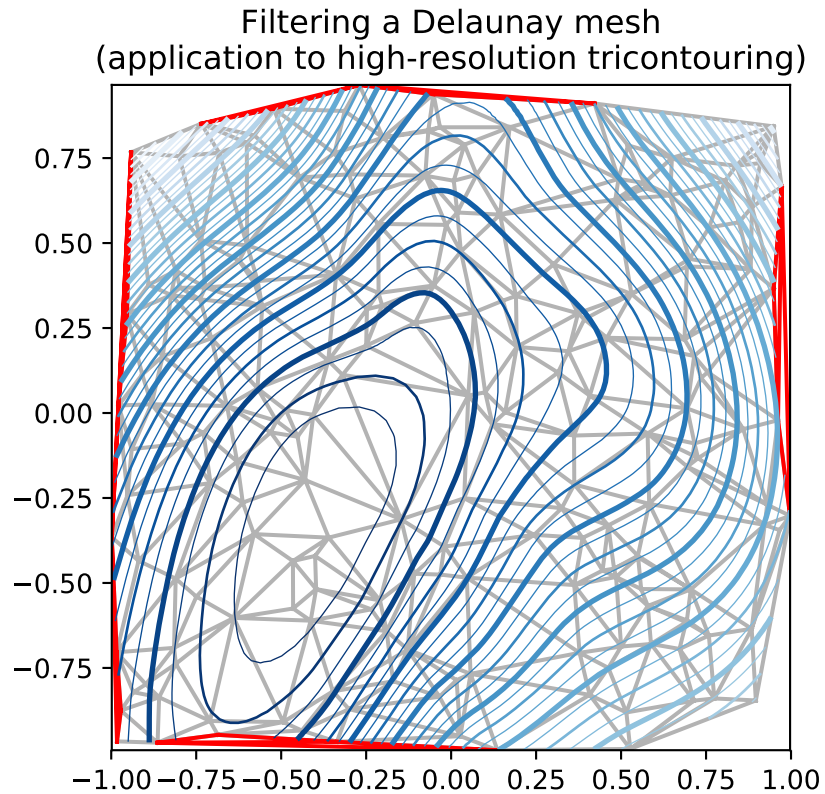
**scale_factors**

Factors to rescale the triangulation into a unit square.

Returns k , tuple of 2 scale factors.

Returns k : tuple of 2 floats (k_x, k_y)

Tuple of floats that would rescale the triangulation : `[triangulation.x * k_x , triangulation.y * k_y]` fits exactly inside a unit square.

56.1 matplotlib.type1font

This module contains a class representing a Type 1 font.

This version reads pfa and pfb files and splits them for embedding in pdf files. It also supports SlantFont and ExtendFont transformations, similarly to pdfTeX and friends. There is no support yet for subsetting.

Usage:

```
>>> font = Type1Font(filename)
>>> clear_part, encrypted_part, finale = font.parts
>>> slanted_font = font.transform({'slant': 0.167})
>>> extended_font = font.transform({'extend': 1.2})
```

Sources:

- Adobe Technical Note #5040, Supporting Downloadable PostScript Language Fonts.
- Adobe Type 1 Font Format, Adobe Systems Incorporated, third printing, v1.1, 1993. ISBN 0-201-57044-0.

class matplotlib.type1font.Type1Font(*input*)

Bases: object

A class representing a Type-1 font, for use by backends.

parts

A 3-tuple of the cleartext part, the encrypted part, and the finale of zeros.

prop

A dictionary of font properties.

Initialize a Type-1 font. *input* can be either the file name of a pfb file or a 3-tuple of already-decoded Type-1 font parts.

parts

prop

transform(*effects*)

Transform the font by slanting or extending. *effects* should be a dict where `effects['slant']` is the tangent of the angle that the font is to be slanted to the right (so negative values slant to the left) and `effects['extend']` is the multiplier by which the font is to be extended (so values less than 1.0 condense). Returns a new *Type1Font* object.

`matplotlib.type1font.ord(x)`

57.1 matplotlib.units

The classes here provide support for using custom classes with matplotlib, e.g., those that do not expose the array interface but know how to convert themselves to arrays. It also supports classes with units and units conversion. Use cases include converters for custom objects, e.g., a list of datetime objects, as well as for objects that are unit aware. We don't assume any particular units implementation, rather a units implementation must provide a ConversionInterface, and the register with the Registry converter dictionary. For example, here is a complete implementation which supports plotting with native datetime objects:

```
import matplotlib.units as units
import matplotlib.dates as dates
import matplotlib.ticker as ticker
import datetime

class DateConverter(units.ConversionInterface):

    @staticmethod
    def convert(value, unit, axis):
        'convert value to a scalar or array'
        return dates.date2num(value)

    @staticmethod
    def axisinfo(unit, axis):
        'return major and minor tick locators and formatters'
        if unit != 'date': return None
        majloc = dates.AutoDateLocator()
        majfmt = dates.AutoDateFormatter(majloc)
        return AxisInfo(majloc=majloc,
                        majfmt=majfmt,
                        label='date')

    @staticmethod
    def default_units(x, axis):
        'return the default unit for x or None'
        return 'date'

# finally we register our object type with a converter
units.registry[datetime.date] = DateConverter()
```

class matplotlib.units.**AxisInfo**(*majloc=None, minloc=None, majfmt=None, minfmt=None, label=None, default_limits=None*)

Bases: object

information to support default axis labeling and tick labeling, and default limits

majloc and minloc: TickLocators for the major and minor ticks majfmt and minfmt: TickFormatters for the major and minor ticks label: the default axis label default_limits: the default min, max of the axis if no data is present If any of the above are None, the axis will simply use the default

class matplotlib.units.**ConversionInterface**

Bases: object

The minimal interface for a converter to take custom instances (or sequences) and convert them to values mpl can use

static axisinfo(*unit, axis*)

return an units.AxisInfo instance for axis with the specified units

static convert(*obj, unit, axis*)

convert obj using unit for the specified axis. If obj is a sequence, return the converted sequence. The output must be a sequence of scalars that can be used by the numpy array layer

static default_units(*x, axis*)

return the default unit for x or None for the given axis

static is_numlike(*x*)

The matplotlib datalim, autoscaling, locators etc work with scalars which are the units converted to floats given the current unit. The converter may be passed these floats, or arrays of them, even when units are set. Derived conversion interfaces may opt to pass plain-ol unitless numbers through the conversion interface and this is a helper function for them.

class matplotlib.units.**Registry**

Bases: dict

register types with conversion interface

get_converter(*x*)

get the converter interface instance for x, or None

58.1 matplotlib.widgets

58.1.1 GUI neutral widgets

Widgets that are designed to work for any of the GUI backends. All of these widgets require you to predefine a `matplotlib.axes.Axes` instance and pass that as the first arg. matplotlib doesn't try to be too smart with respect to layout – you will have to figure out how wide and tall you want your Axes to be to accommodate your widget.

class `matplotlib.widgets.AxesWidget(ax)`

Bases: `matplotlib.widgets.Widget`

Widget that is connected to a single `Axes`.

To guarantee that the widget remains responsive and not garbage-collected, a reference to the object should be maintained by the user.

This is necessary because the callback registry maintains only weak-refs to the functions, which are member functions of the widget. If there are no references to the widget object it may be garbage collected which will disconnect the callbacks.

Attributes:

ax [`Axes`] The parent axes for the widget

canvas [`FigureCanvasBase` subclass] The parent figure canvas for the widget.

active [bool] If False, the widget does not respond to events.

connect_event(event, callback)

Connect callback with an event.

This should be used in lieu of `figure.canvas.mpl_connect` since this function stores callback ids for later clean up.

disconnect_events()

Disconnect all events created by this widget.

class `matplotlib.widgets.Button(ax, label, image=None, color='0.85', hovercolor='0.95')`

Bases: `matplotlib.widgets.AxesWidget`

A GUI neutral button.

For the button to remain responsive you must keep a reference to it.

The following attributes are accessible

ax The *matplotlib.axes.Axes* the button renders into.

label A *matplotlib.text.Text* instance.

color The color of the button when not hovering.

hovercolor The color of the button when hovering.

Call *on_clicked()* to connect to the button

Parameters *ax* : *matplotlib.axes.Axes*

The *matplotlib.axes.Axes* instance the button will be placed into.

label : str

The button text. Accepts string.

image : array, mpl image, Pillow Image

The image to place in the button, if not *None*. Can be any legal arg to *imshow* (numpy array, matplotlib Image instance, or Pillow Image).

color : color

The color of the button when not activated

hovercolor : color

The color of the button when the mouse is over it

disconnect(*cid*)

remove the observer with connection id *cid*

on_clicked(*func*)

When the button is clicked, call this *func* with event.

A connection id is returned. It can be used to disconnect the button from its callback.

class *matplotlib.widgets.CheckButtons*(*ax, labels, actives*)

Bases: *matplotlib.widgets.AxesWidget*

A GUI neutral radio button.

For the check buttons to remain responsive you must keep a reference to this object.

The following attributes are exposed

ax The *matplotlib.axes.Axes* instance the buttons are located in

labels List of *matplotlib.text.Text* instances

lines List of (line1, line2) tuples for the x's in the check boxes. These lines exist for each box, but have *set_visible(False)* when its box is not checked.

rectangles List of *matplotlib.patches.Rectangle* instances

Connect to the CheckButtons with the `on_clicked()` method

Add check buttons to `matplotlib.axes.Axes` instance `ax`

labels A len(buttons) list of labels as strings

actives

A len(buttons) list of booleans indicating whether the button is active

disconnect(`cid`)

remove the observer with connection id `cid`

on_clicked(`func`)

When the button is clicked, call `func` with button label

A connection id is returned which can be used to disconnect

set_active(`index`)

Directly (de)activate a check button by index.

index is an index into the original label list that this object was constructed with. Raises `ValueError` if `index` is invalid.

Callbacks will be triggered if `eventson` is `True`.

class `matplotlib.widgets.Cursor`(`ax`, `horizOn=True`, `vertOn=True`, `useblit=False`, `**lineprops`)

Bases: `matplotlib.widgets.AxesWidget`

A horizontal and vertical line that spans the axes and moves with the pointer. You can turn off the `hline` or `vline` respectively with the following attributes:

horizOn Controls the visibility of the horizontal line

vertOn Controls the visibility of the horizontal line

and the visibility of the cursor itself with the `visible` attribute.

For the cursor to remain responsive you must keep a reference to it.

Add a cursor to `ax`. If `useblit=True`, use the backend- dependent blitting features for faster updates (GTKAgg only for now). `lineprops` is a dictionary of line properties.

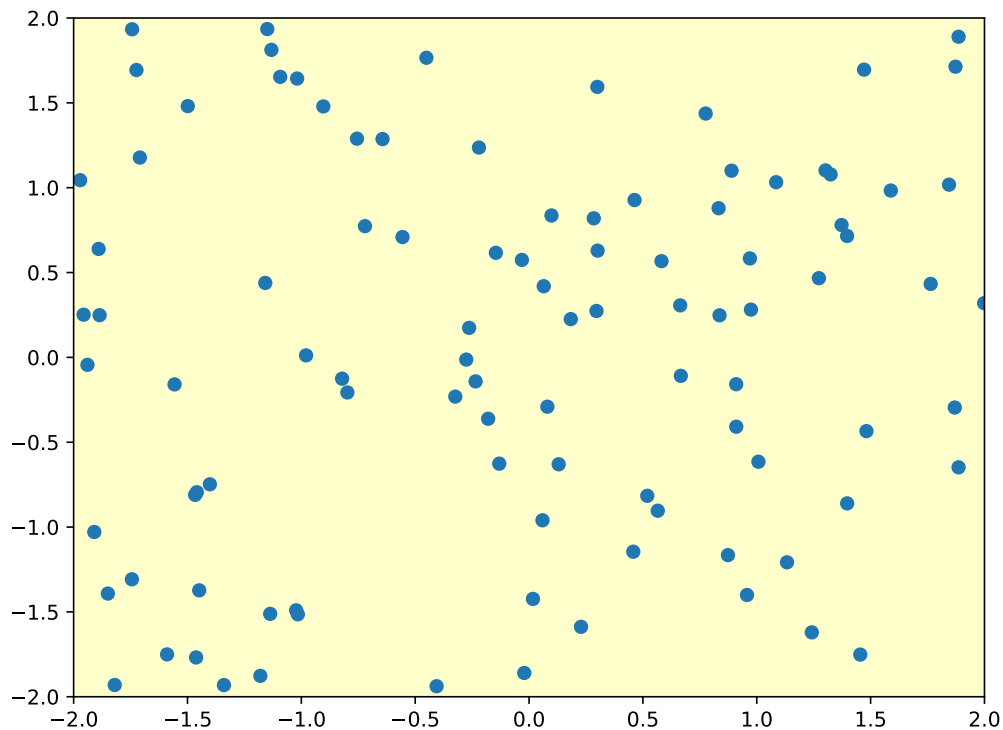

clear(*event*)
clear the cursor

onmove(*event*)
on mouse motion draw the cursor if visible

class matplotlib.widgets.**EllipseSelector**(*ax, onselect, drawtype='box', minspanx=None, minspany=None, useblit=False, lineprops=None, rectprops=None, spancoords='data', button=None, maxdist=10, marker_props=None, interactive=False, state_modifier_keys=None*)

Bases: *matplotlib.widgets.RectangleSelector*

Select an elliptical region of an axes.

For the cursor to remain responsive you must keep a reference to it.

Example usage:

```
from matplotlib.widgets import EllipseSelector
from pylab import *

def onselect(eclick, erelease):
    'eclick and erelease are matplotlib events at press and release'
    print(' startposition : (%f, %f)' % (eclick.xdata, eclick.ydata))
```



```

print(' endposition   : (%f, %f)' % (erelease.xdata, erelease.ydata))
print(' used button   : ', eclick.button)

def toggle_selector(event):
    print(' Key pressed.')
    if event.key in ['Q', 'q'] and toggle_selector.ES.active:
        print(' EllipseSelector deactivated.')
        toggle_selector.RS.set_active(False)
    if event.key in ['A', 'a'] and not toggle_selector.ES.active:
        print(' EllipseSelector activated.')
        toggle_selector.ES.set_active(True)

x = arange(100)/(99.0)
y = sin(x)
fig = figure
ax = subplot(111)
ax.plot(x,y)

toggle_selector.ES = EllipseSelector(ax, onselect, drawtype='line')
connect('key_press_event', toggle_selector)
show()

```

Create a selector in *ax*. When a selection is made, clear the span and call `onselect` with:

```
onselect(pos_1, pos_2)
```

and clear the drawn box/line. The `pos_1` and `pos_2` are arrays of length 2 containing the x- and y-coordinate.

If `minspanx` is not `None` then events smaller than `minspanx` in x direction are ignored (it's the same for y).

The rectangle is drawn with `rectprops`; default:

```
rectprops = dict(facecolor='red', edgecolor = 'black',
                 alpha=0.2, fill=True)
```

The line is drawn with `lineprops`; default:

```
lineprops = dict(color='black', linestyle='-',
                 linewidth = 2, alpha=0.5)
```

Use `drawtype` if you want the mouse to draw a line, a box or nothing between click and actual position by setting

```
drawtype = 'line', drawtype='box' or drawtype = 'none'.
```

`spancoords` is one of 'data' or 'pixels'. If 'data', `minspanx` and `minspany` will be interpreted in the same coordinates as the x and y axis. If 'pixels', they are in pixels.

`button` is a list of integers indicating which mouse buttons should be used for rectangle selection. You can also specify a single integer if only a single button is desired. Default is `None`, which does not limit which button can be used.

Note, typically: 1 = left mouse button 2 = center mouse button (scroll wheel) 3 = right mouse button
interactive will draw a set of handles and allow you interact with the widget after it is drawn.

state_modifier_keys are keyboard modifiers that affect the behavior of the widget.

The defaults are: dict(move=' ', clear='escape', square='shift', center='ctrl')

Keyboard modifiers, which: 'move': Move the existing shape. 'clear': Clear the current shape. 'square': Makes the shape square. 'center': Make the initial point the center of the shape. 'square' and 'center' can be combined.

draw_shape(*extents*)

class matplotlib.widgets.**Lasso**(*ax, xy, callback=None, useblit=True*)

Bases: *matplotlib.widgets.AxesWidget*

Selection curve of an arbitrary shape.

The selected path can be used in conjunction with *contains_point()* to select data points from an image.

Unlike *LassoSelector*, this must be initialized with a starting point *xy*, and the *Lasso* events are destroyed upon release.

Parameters:

ax [*Axes*] The parent axes for the widget.

xy [array] Coordinates of the start of the lasso.

callback [function] Whenever the lasso is released, the *callback* function is called and passed the vertices of the selected path.

onmove(*event*)

onrelease(*event*)

class matplotlib.widgets.**LassoSelector**(*ax, onselect=None, useblit=True, lineprops=None, button=None*)

Bases: *matplotlib.widgets._SelectorWidget*

Selection curve of an arbitrary shape.

For the selector to remain responsive you must keep a reference to it.

The selected path can be used in conjunction with *contains_point()* to select data points from an image.

In contrast to *Lasso*, *LassoSelector* is written with an interface similar to *RectangleSelector* and *SpanSelector* and will continue to interact with the axes until disconnected.

Parameters:

ax [*Axes*] The parent axes for the widget.

onselect [function] Whenever the lasso is released, the onselect function is called and passed the vertices of the selected path.

Example usage:

```

ax = subplot(111)
ax.plot(x,y)

def onselect(verts):
    print(verts)
lasso = LassoSelector(ax, onselect)

*button* is a list of integers indicating which mouse buttons should
be used for rectangle selection. You can also specify a single
integer if only a single button is desired. Default is *None*,
which does not limit which button can be used.

Note, typically:
1 = left mouse button
2 = center mouse button (scroll wheel)
3 = right mouse button

```

onpress(*event*)

onrelease(*event*)

class matplotlib.widgets.**LockDraw**

Bases: object

Some widgets, like the cursor, draw onto the canvas, and this is not desirable under all circumstances, like when the toolbar is in zoom-to-rect mode and drawing a rectangle. The module level “lock” allows someone to grab the lock and prevent other widgets from drawing. Use `matplotlib.widgets.lock(someobj)` to prevent other widgets from drawing while you’re interacting with the canvas.

available(*o*)

drawing is available to *o*

isowner(*o*)

Return True if *o* owns this lock

locked()

Return True if the lock is currently held by an owner

release(*o*)

release the lock

class matplotlib.widgets.**MultiCursor**(*canvas, axes, useblit=True, horizOn=False, vertOn=True, **lineprops*)

Bases: `matplotlib.widgets.Widget`

Provide a vertical (default) and/or horizontal line cursor shared between multiple axes.

For the cursor to remain responsive you must keep a reference to it.

Example usage:

```

from matplotlib.widgets import MultiCursor
from pylab import figure, show, np

t = np.arange(0.0, 2.0, 0.01)
s1 = np.sin(2*np.pi*t)
s2 = np.sin(4*np.pi*t)
fig = figure()
ax1 = fig.add_subplot(211)
ax1.plot(t, s1)

ax2 = fig.add_subplot(212, sharex=ax1)
ax2.plot(t, s2)

multi = MultiCursor(fig.canvas, (ax1, ax2), color='r', lw=1,
                    horizOn=False, vertOn=True)
show()

```

clear(*event*)
clear the cursor

connect()
connect events

disconnect()
disconnect events

onmove(*event*)

class `matplotlib.widgets.RadioButtons`(*ax*, *labels*, *active=0*, *activecolor='blue'*)

Bases: `matplotlib.widgets.AxesWidget`

A GUI neutral radio button.

For the buttons to remain responsive you must keep a reference to this object.

The following attributes are exposed:

ax The `matplotlib.axes.Axes` instance the buttons are in

activecolor The color of the button when clicked

labels A list of `matplotlib.text.Text` instances

circles A list of `matplotlib.patches.Circle` instances

value_selected A string listing the current value selected

Connect to the RadioButtons with the `on_clicked()` method

Add radio buttons to `matplotlib.axes.Axes` instance *ax*

labels A len(buttons) list of labels as strings

active The index into labels for the button that is active

activecolor The color of the button when clicked

disconnect(*cid*)

remove the observer with connection id *cid*

on_clicked(*func*)

When the button is clicked, call *func* with button label

A connection id is returned which can be used to disconnect

set_active(*index*)

Trigger which radio button to make active.

index is an index into the original label list that this object was constructed with. Raise `ValueError` if the index is invalid.

Callbacks will be triggered if `eventson` is `True`.

```
class matplotlib.widgets.RectangleSelector(ax,          onselect,          drawtype='box',
                                          minspanx=None,      minspany=None,
                                          useblit=False,    lineprops=None,  rect-
                                          props=None,      spancoords='data',  but-
                                          ton=None, maxdist=10, marker_props=None,
                                          interactive=False, state_modifier_keys=None)
```

Bases: `matplotlib.widgets._SelectorWidget`

Select a rectangular region of an axes.

For the cursor to remain responsive you must keep a reference to it.

Example usage:

```
from matplotlib.widgets import RectangleSelector
from pylab import *

def onselect(eclick, erelease):
    'eclick and erelease are matplotlib events at press and release'
    print(' startposition : (%f, %f)' % (eclick.xdata, eclick.ydata))
    print(' endposition   : (%f, %f)' % (erelease.xdata, erelease.ydata))
    print(' used button   : ', eclick.button)

def toggle_selector(event):
    print(' Key pressed. ')
    if event.key in ['Q', 'q'] and toggle_selector.RS.active:
        print(' RectangleSelector deactivated. ')
        toggle_selector.RS.set_active(False)
    if event.key in ['A', 'a'] and not toggle_selector.RS.active:
        print(' RectangleSelector activated. ')
        toggle_selector.RS.set_active(True)

x = arange(100)/(99.0)
y = sin(x)
fig = figure
ax = subplot(111)
ax.plot(x,y)
```

```
toggle_selector.RS = RectangleSelector(ax, onselect, drawtype='line')
connect('key_press_event', toggle_selector)
show()
```

Create a selector in *ax*. When a selection is made, clear the span and call *onselect* with:

```
onselect(pos_1, pos_2)
```

and clear the drawn box/line. The *pos_1* and *pos_2* are arrays of length 2 containing the x- and y-coordinate.

If *minspanx* is not *None* then events smaller than *minspanx* in x direction are ignored (it's the same for y).

The rectangle is drawn with *rectprops*; default:

```
rectprops = dict(facecolor='red', edgecolor = 'black',
                 alpha=0.2, fill=True)
```

The line is drawn with *lineprops*; default:

```
lineprops = dict(color='black', linestyle='-',
                 linewidth = 2, alpha=0.5)
```

Use *drawtype* if you want the mouse to draw a line, a box or nothing between click and actual position by setting

```
drawtype = 'line', drawtype='box' or drawtype = 'none'.
```

spancoords is one of 'data' or 'pixels'. If 'data', *minspanx* and *minspany* will be interpreted in the same coordinates as the x and y axis. If 'pixels', they are in pixels.

button is a list of integers indicating which mouse buttons should be used for rectangle selection. You can also specify a single integer if only a single button is desired. Default is *None*, which does not limit which button can be used.

Note, typically: 1 = left mouse button 2 = center mouse button (scroll wheel) 3 = right mouse button
interactive will draw a set of handles and allow you interact with the widget after it is drawn.

state_modifier_keys are keyboard modifiers that affect the behavior of the widget.

The defaults are: dict(move=' ', clear='escape', square='shift', center='ctrl')

Keyboard modifiers, which: 'move': Move the existing shape. 'clear': Clear the current shape. 'square': Makes the shape square. 'center': Make the initial point the center of the shape. 'square' and 'center' can be combined.

center

Center of rectangle

corners

Corners of rectangle from lower left, moving clockwise.

draw_shape(*extents*)

edge_centers

Midpoint of rectangle edges from left, moving clockwise.

extents

Return (xmin, xmax, ymin, ymax).

geometry

class `matplotlib.widgets.Slider`(*ax*, *label*, *valmin*, *valmax*, *valinit*=0.5, *valfmt*='%1.2f', *closedmin*=True, *closedmax*=True, *slidermin*=None, *slidermax*=None, *dragging*=True, ***kwargs*)

Bases: `matplotlib.widgets.AxesWidget`

A slider representing a floating point range.

For the slider to remain responsive you must maintain a reference to it.

The following attributes are defined *ax* : the slider `matplotlib.axes.Axes` instance

val : the current slider value

vline [a `matplotlib.lines.Line2D` instance] representing the initial value of the slider

poly [A `matplotlib.patches.Polygon` instance] which is the slider knob

valfmt : the format string for formatting the slider text

label [a `matplotlib.text.Text` instance] for the slider label

closedmin : whether the slider is closed on the minimum

closedmax : whether the slider is closed on the maximum

slidermin [another slider - if not *None*, this slider must be] greater than *slidermin*

slidermax [another slider - if not *None*, this slider must be] less than *slidermax*

dragging : allow for mouse dragging on slider

Call `on_changed()` to connect to the slider event

Create a slider from *valmin* to *valmax* in axes *ax*.

Additional kwargs are passed on to `self.poly` which is the `matplotlib.patches.Rectangle` that draws the slider knob. See the `matplotlib.patches.Rectangle` documentation for valid property names (e.g., *facecolor*, *edgecolor*, *alpha*, ...).

Parameters *ax* : Axes

The Axes to put the slider in

label : str

Slider label

valmin : float

The minimum value of the slider

valmax : float

The maximum value of the slider

valinit : float

The slider initial position

label : str

The slider label

valfmt : str

Used to format the slider value, fprint format string

closedmin : bool

Indicate whether the slider interval is closed on the bottom

closedmax : bool

Indicate whether the slider interval is closed on the top

slidermin : Slider or None

Do not allow the current slider to have a value less than `slidermin`

slidermax : Slider or None

Do not allow the current slider to have a value greater than `slidermax`

dragging : bool

if the slider can be dragged by the mouse

disconnect(*cid*)

remove the observer with connection id *cid*

on_changed(*func*)

When the slider value is changed, call *func* with the new slider position

A connection id is returned which can be used to disconnect

reset()

reset the slider to the initial value if needed

set_val(*val*)

```
class matplotlib.widgets.SpanSelector(ax, onselect, direction, minspan=None,
                                     useblit=False, rectprops=None, on-
                                     move_callback=None, span_stays=False, but-
                                     ton=None)
```

Bases: `matplotlib.widgets._SelectorWidget`

Visually select a min/max range on a single axis and call a function with those values.

To guarantee that the selector remains responsive, keep a reference to it.

In order to turn off the SpanSelector, set `span_selector.active=False`. To turn it back on, set `span_selector.active=True`.

Parameters `ax` : `matplotlib.axes.Axes` object

onselect : func(min, max), min/max are floats

direction : “horizontal” or “vertical”

The axis along which to draw the span selector

minspan : float, default is None

If selection is less than *minspan*, do not call *onselect*

useblit : bool, default is False

If True, use the backend-dependent blitting features for faster canvas updates.
Only available for GTKAgg right now.

rectprops : dict, default is None

Dictionary of `matplotlib.patches.Patch` properties

onmove_callback : func(min, max), min/max are floats, default is None

Called on mouse move while the span is being selected

span_stays : bool, default is False

If True, the span stays visible after the mouse is released

button : int or list of ints

Determines which mouse buttons activate the span selector 1 = left
mouse button

2 = center mouse button (scroll wheel)

3 = right mouse button

Examples

```
>>> import matplotlib.pyplot as plt
>>> import matplotlib.widgets as mwidgets
>>> fig, ax = plt.subplots()
>>> ax.plot([1, 2, 3], [10, 50, 100])
>>> def onselect(vmin, vmax):
>>>     print(vmin, vmax)
>>> rectprops = dict(facecolor='blue', alpha=0.5)
>>> span = mwidgets.SpanSelector(ax, onselect, 'horizontal',
>>>                               rectprops=rectprops)
>>> fig.show()
```

See also: *widgets example code: span_selector.py*

ignore(*event*)
return *True* if *event* should be ignored

new_axes(*ax*)
Set SpanSelector to operate on a new Axes

class matplotlib.widgets.**SubplotTool**(*targetfig, toolfig*)
Bases: *matplotlib.widgets.Widget*

A tool to adjust the subplot params of a *matplotlib.figure.Figure*.

targetfig The figure instance to adjust.

toolfig The figure instance to embed the subplot tool into. If *None*, a default figure will be created. If you are using this from the GUI

funcbottom(*val*)

funcspace(*val*)

funcleft(*val*)

funcright(*val*)

functop(*val*)

funcwspace(*val*)

class matplotlib.widgets.**ToolHandles**(*ax, x, y, marker='o', marker_props=None, use-blit=True*)

Bases: *object*

Control handles for canvas tools.

Parameters *ax* : *matplotlib.axes.Axes*

Matplotlib axes where tool handles are displayed.

x, y : 1D arrays

Coordinates of control handles.

marker : str

Shape of marker used to display handle. See *matplotlib.pyplot.plot*.

marker_props : dict

Additional marker properties. See *matplotlib.lines.Line2D*.

closest(*x, y*)
Return index and pixel distance to closest index.

set_animated(*val*)

set_data(*pts*, *y=None*)

Set x and y positions of handles

set_visible(*val*)

x

y

class matplotlib.widgets.**Widget**

Bases: object

Abstract base class for GUI neutral widgets

active

Is the widget active?

drawon = True

eventson = True

get_active()

Get whether the widget is active.

ignore(*event*)

Return True if event should be ignored.

This method (or a version of it) should be called at the beginning of any event callback.

set_active(*active*)

Set whether the widget is active.

Part III

The Matplotlib FAQ

INSTALLATION

Contents

- *Installation*
 - *Report a compilation problem*
 - *matplotlib compiled fine, but nothing shows up when I use it*
 - *How to completely remove matplotlib*
 - * *Source install*
 - *How to Install*
 - * *Source install from git*
 - *Linux Notes*
 - *OS-X Notes*
 - * *Which python for OS X?*
 - * *Installing OSX binary wheels*
 - *Python.org Python*
 - *Macports*
 - *Homebrew*
 - *Pip problems*
 - * *Installing via OSX mpkg installer package*
 - * *Checking your installation*
 - *Windows Notes*

59.1 Report a compilation problem

See *Getting help*.

59.2 matplotlib compiled fine, but nothing shows up when I use it

The first thing to try is a *clean install* and see if that helps. If not, the best way to test your install is by running a script, rather than working interactively from a python shell or an integrated development environment such as **IDLE** which add additional complexities. Open up a UNIX shell or a DOS command prompt and cd into a directory containing a minimal example in a file. Something like `simple_plot.py` for example:

```
import matplotlib.pyplot as plt
fig, ax = plt.subplots()
ax.plot([1,2,3])
plt.show()
```

and run it with:

```
python simple_plot.py --verbose-helpful
```

This will give you additional information about which backends matplotlib is loading, version information, and more. At this point you might want to make sure you understand matplotlib's *configuration* process, governed by the `matplotlibrc` configuration file which contains instructions within and the concept of the matplotlib backend.

If you are still having trouble, see *Getting help*.

59.3 How to completely remove matplotlib

Occasionally, problems with matplotlib can be solved with a clean installation of the package.

The process for removing an installation of matplotlib depends on how matplotlib was originally installed on your system. Follow the steps below that goes with your original installation method to cleanly remove matplotlib from your system.

59.3.1 Source install

Unfortunately:

```
python setup.py clean
```

does not properly clean the build directory, and does nothing to the install directory. To cleanly rebuild:

1. Delete the caches from your *.matplotlib configuration directory*.
2. Delete the build directory in the source tree.
3. Delete any matplotlib directories or eggs from your *installation directory*.

59.4 How to Install

59.4.1 Source install from git

Clone the main source using one of:

```
git clone git@github.com:matplotlib/matplotlib.git
```

or:

```
git clone git://github.com/matplotlib/matplotlib.git
```

and build and install as usual with:

```
> cd matplotlib
> python setup.py install
```

Note: If you are on debian/ubuntu, you can get all the dependencies required to build matplotlib with:

```
sudo apt-get build-dep python-matplotlib
```

If you are on Fedora/RedHat, you can get all the dependencies required to build matplotlib by first installing `yum-builddep` and then running:

```
su -c "yum-builddep python-matplotlib"
```

This does not build matplotlib, but it does get all of the build dependencies, which will make building from source easier.

If you want to be able to follow the development branch as it changes just replace the last step with (make sure you have **setuptools** installed):

```
> python setup.py develop
```

This creates links in the right places and installs the command line script to the appropriate places.

Note: Mac OSX users please see the *Building on OSX* guide.

Windows users please see the *Building on Windows* guide.

Then, if you want to update your matplotlib at any time, just do:

```
> git pull
```

When you run `git pull`, if the output shows that only Python files have been updated, you are all set. If C files have changed, you need to run the `python setup.py develop` command again to compile them.

There is more information on *using git* in the developer docs.

59.5 Linux Notes

Because most Linux distributions use some sort of package manager, we do not provide a pre-built binary for the Linux platform. Instead, we recommend that you use the “Add Software” method for your system to install matplotlib. This will guarantee that everything that is needed for matplotlib will be installed as well.

If, for some reason, you can not use the package manager, Linux usually comes with at least a basic build system. Follow the *instructions* found above for how to build and install matplotlib.

59.6 OS-X Notes

59.6.1 Which python for OS X?

Apple ships OS X with its own Python, in `/usr/bin/python`, and its own copy of matplotlib. Unfortunately, the way Apple currently installs its own copies of numpy, scipy and matplotlib means that these packages are difficult to upgrade (see [system python packages](#)). For that reason we strongly suggest that you install a fresh version of Python and use that as the basis for installing libraries such as numpy and matplotlib. One convenient way to install matplotlib with other useful Python software is to use one of the excellent Python scientific software collections that are now available:

- [Anaconda](#) from [Continuum Analytics](#)
- [Canopy](#) from [Enthought](#)

These collections include Python itself and a wide range of libraries; if you need a library that is not available from the collection, you can install it yourself using standard methods such as *pip*. Continuum and Enthought offer their own installation support for these collections; see the [Ananconda](#) and [Canopy](#) web pages for more information.

Other options for a fresh Python install are the standard installer from [python.org](#), or installing Python using a general OSX package management system such as [homebrew](#) or [macports](#). Power users on OSX will likely want one of homebrew or macports on their system to install open source software packages, but it is perfectly possible to use these systems with another source for your Python binary, such as [Anaconda](#), [Canopy](#) or [Python.org Python](#).

59.6.2 Installing OSX binary wheels

If you are using recent Python from <https://www.python.org>, [Macports](#) or [Homebrew](#), then you can use the standard *pip* installer to install matplotlib binaries in the form of wheels.

Python.org Python

Install *pip* following the [standard pip install instructions](#). For the impatient, open a new `Terminal.app` window and:

```
curl -O https://bootstrap.pypa.io/get-pip.py
```

Then (Python 2.7):

```
python get-pip.py
```

or (Python 3):

```
python3 get-pip.py
```

You can now install matplotlib and all its dependencies with:

```
pip install matplotlib
```

Macports

For Python 2.7:

```
sudo port install py27-pip  
sudo pip-2.7 install matplotlib
```

For Python 3.4:

```
sudo port install py34-pip  
sudo pip-3.4 install matplotlib
```

Homebrew

For Python 2.7:

```
pip2 install matplotlib
```

For Python 3.4:

```
pip3 install matplotlib
```

You might also want to install IPython; we recommend you install IPython with the IPython notebook option, like this:

- Python.org Python: `pip install ipython[notebook]`
- Macports `sudo pip-2.7 install ipython[notebook]` or `sudo pip-3.4 install ipython[notebook]`
- Homebrew `pip2 install ipython[notebook]` or `pip3 install ipython[notebook]`

Pip problems

If you get errors with pip trying to run a compiler like `gcc` or `clang`, then the first thing to try is to [install xcode](#) and retry the install. If that does not work, then check [Getting help](#).

59.6.3 Installing via OSX mpkg installer package

matplotlib also has a disk image (.dmg) installer, which contains a typical Installer.app package to install matplotlib. You should use binary wheels instead of the disk image installer if you can, because:

- wheels work with Python.org Python, homebrew and macports, the disk image installer only works with Python.org Python.
- The disk image installer doesn't check for recent versions of packages that matplotlib depends on, and unconditionally installs the versions of dependencies contained in the disk image installer. This can overwrite packages that you have already installed, which might cause problems for other packages, if you have a pre-existing Python.org setup on your computer.

If you still want to use the disk image installer, read on.

Note: Before installing via the disk image installer, be sure that all of the packages were compiled for the same version of python. Often, the download site for NumPy and matplotlib will display a supposed 'current' version of the package, but you may need to choose a different package from the full list that was built for your combination of python and OSX.

The disk image installer will have a .dmg extension, and will have a name like matplotlib-1.4.0-py2.7-macosx10.6.dmg. The name of the installer depends on the versions of python and matplotlib it was built for, and the version of OSX that the matching Python.org installer was built for. For example, if the matching Python.org Python installer was built for OSX 10.6 or greater, the dmg file will end in -macosx10.6.dmg. You need to download this disk image file, open the disk image file by double clicking, and find the new matplotlib disk image icon on your desktop. Double click on that icon to show the contents of the image. Then double-click on the .mpkg icon, which will have a name like matplotlib-1.4.0-py2.7-macosx10.6.mpkg, it will run the Installer.app, prompt you for a password if you need system-wide installation privileges, and install to a directory like /Library/Frameworks/Python.framework/Versions/2.7/lib/python2.7/site-packages (exact path depends on your Python version).

59.6.4 Checking your installation

The new version of matplotlib should now be on your Python "path". Check this with one of these commands at the Terminal.app command line:

```
python2.7 -c 'import matplotlib; print matplotlib.__version__, matplotlib.__file__'
```

(Python 2.7) or:

```
python3.4 -c 'import matplotlib; print(matplotlib.__version__, matplotlib.__file__)'
```

(Python 3.4). You should see something like this:

```
1.4.0 /Library/Frameworks/Python.framework/Versions/2.7/lib/python2.7/site-packages/  
↳matplotlib/__init__.pyc
```

where 1.4.0 is the matplotlib version you just installed, and the path following depends on whether you are using Python.org Python, Homebrew or Macports. If you see another version, or you get an error like this:

```
Traceback (most recent call last):  
  File "<string>", line 1, in <module>  
ImportError: No module named matplotlib
```

then check that the Python binary is the one you expected by doing one of these commands in Terminal.app:

```
which python2.7
```

or:

```
which python3.4
```

If you get the result `/usr/bin/python2.7`, then you are getting the Python installed with OSX, which is probably not what you want. Try closing and restarting Terminal.app before running the check again. If that doesn't fix the problem, depending on which Python you wanted to use, consider reinstalling Python.org Python, or check your homebrew or macports setup. Remember that the disk image installer only works for Python.org Python, and will not get picked up by other Pythons. If all these fail, please let us know: see [Getting help](#).

59.7 Windows Notes

See [Windows](#).

Contents

- *Usage*
 - *General Concepts*
 - *Parts of a Figure*
 - * **Figure**
 - * **Axes**
 - * **Axis**
 - * **Artist**
 - *Types of inputs to plotting functions*
 - *Matplotlib, pyplot and pylab: how are they related?*
 - *Coding Styles*
 - *What is a backend?*
 - *WX backends*
 - *GTK and Cairo*
 - *How do I select PyQt4 or PySide?*
 - *What is interactive mode?*
 - * *Interactive example*
 - * *Non-interactive example*
 - * *Summary*

60.1 General Concepts

`matplotlib` has an extensive codebase that can be daunting to many new users. However, most of `matplotlib` can be understood with a fairly simple conceptual framework and knowledge of a few important points.

Plotting requires action on a range of levels, from the most general (e.g., ‘contour this 2-D array’) to the most specific (e.g., ‘color this screen pixel red’). The purpose of a plotting package is to assist you in visualizing your data as easily as possible, with all the necessary control – that is, by using relatively high-level commands most of the time, and still have the ability to use the low-level commands when needed.

Therefore, everything in `matplotlib` is organized in a hierarchy. At the top of the hierarchy is the `matplotlib` “state-machine environment” which is provided by the `matplotlib.pyplot` module. At this level, simple functions are used to add plot elements (lines, images, text, etc.) to the current axes in the current figure.

Note: `Pyplot`’s state-machine environment behaves similarly to `MATLAB` and should be most familiar to users with `MATLAB` experience.

The next level down in the hierarchy is the first level of the object-oriented interface, in which `pyplot` is used only for a few functions such as figure creation, and the user explicitly creates and keeps track of the figure and axes objects. At this level, the user uses `pyplot` to create figures, and through those figures, one or more axes objects can be created. These axes objects are then used for most plotting actions.

For even more control – which is essential for things like embedding `matplotlib` plots in GUI applications – the `pyplot` level may be dropped completely, leaving a purely object-oriented approach.

60.2 Parts of a Figure

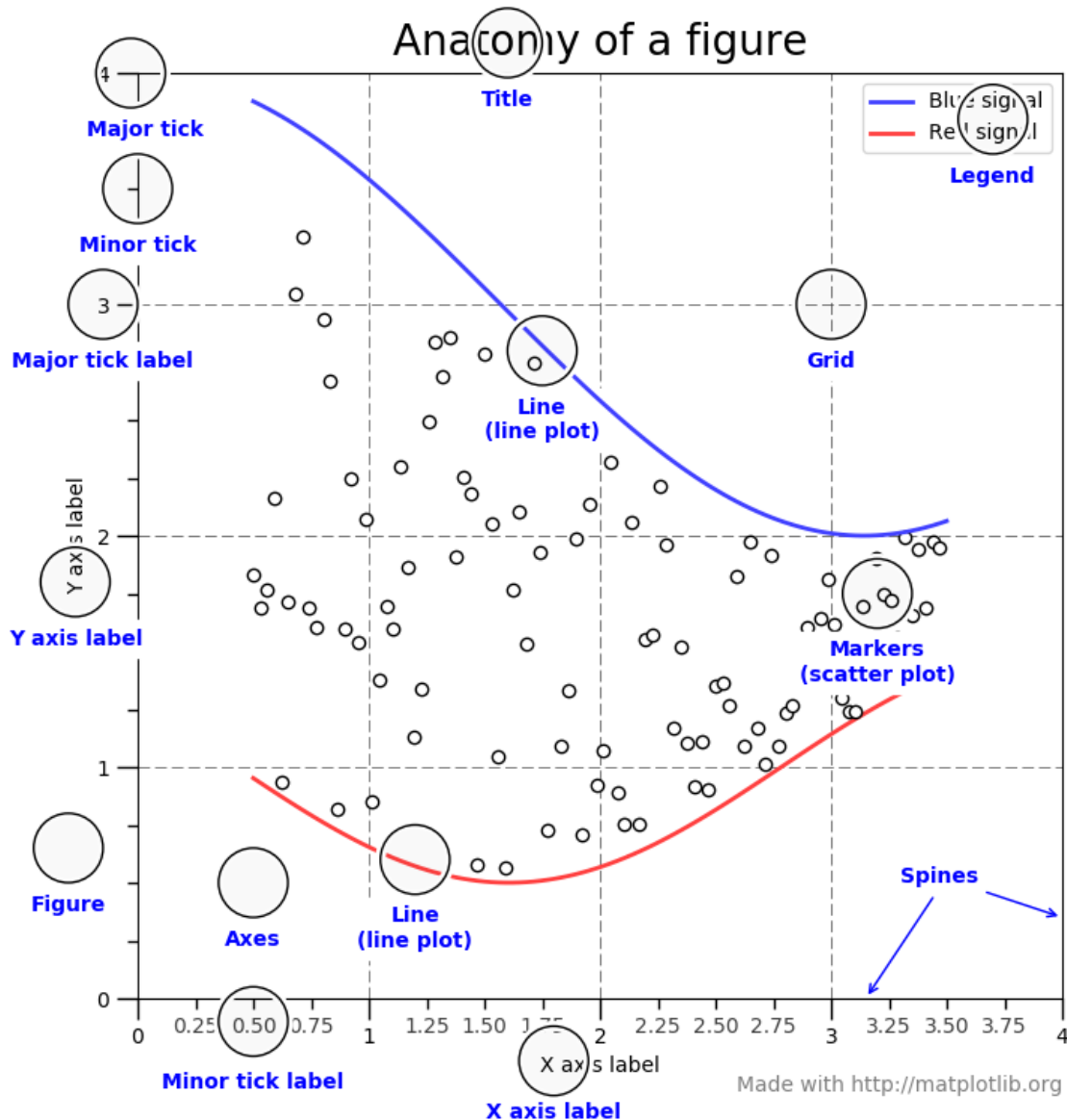

60.2.1 Figure

The **whole** figure. The figure keeps track of all the child *Axes*, a smattering of ‘special’ artists (titles, figure legends, etc), and the **canvas**. (Don’t worry too much about the canvas, it is crucial as it is the object that actually does the drawing to get you your plot, but as the user it is more-or-less invisible to you). A figure can have any number of *Axes*, but to be useful should have at least one.

The easiest way to create a new figure is with `pyplot`:

```
fig = plt.figure() # an empty figure with no axes
fig, ax_lst = plt.subplots(2, 2) # a figure with a 2x2 grid of Axes
```

60.2.2 Axes

This is what you think of as ‘a plot’, it is the region of the image with the data space (marked as the inner blue box). A given figure can contain many Axes, but a given *Axes* object can only be in one *Figure*. The Axes contains two (or three in the case of 3D) *Axis* objects (be aware of the difference between *Axes* and *Axis*) which take care of the data limits (the data limits can also be controlled via set via the *set_xlim()* and *set_ylim()* Axes methods). Each Axes has a title (set via *set_title()*), an x-label (set via *set_xlabel()*), and a y-label set via *set_ylabel()*.

The Axes class and it’s member functions are the primary entry point to working with the OO interface.

60.2.3 Axis

These are the number-line-like objects (circled in green). They take care of setting the graph limits and generating the ticks (the marks on the axis) and ticklabels (strings labeling the ticks). The location of the ticks is determined by a *Locator* object and the ticklabel strings are formatted by a *Formatter*. The combination of the correct Locator and Formatter gives very fine control over the tick locations and labels.

60.2.4 Artist

Basically everything you can see on the figure is an artist (even the Figure, Axes, and Axis objects). This includes Text objects, Line2D objects, collection objects, Patch objects ... (you get the idea). When the figure is rendered, all of the artists are drawn to the **canvas**. Most Artists are tied to an Axes; such an Artist cannot be shared by multiple Axes, or moved from one to another.

60.3 Types of inputs to plotting functions

All of plotting functions expect `np.array` or `np.ma.masked_array` as input. Classes that are ‘array-like’ such as pandas data objects and `np.matrix` may or may not work as intended. It is best to convert these to `np.array` objects prior to plotting.

For example, to convert a `pandas.DataFrame`

```
a = pandas.DataFrame(np.random.rand(4,5), columns = list('abcde'))
a_asndarray = a.values
```

and to convert a `np.matrix`

```
b = np.matrix([[1,2],[3,4]])
b_asarray = np.asarray(b)
```

60.4 Matplotlib, pyplot and pylab: how are they related?

Matplotlib is the whole package; `matplotlib.pyplot` is a module in matplotlib; and `pylab` is a module that gets installed alongside matplotlib.

Pyplot provides the state-machine interface to the underlying object-oriented plotting library. The state-machine implicitly and automatically creates figures and axes to achieve the desired plot. For example:

```
import matplotlib.pyplot as plt
import numpy as np

x = np.linspace(0, 2, 100)

plt.plot(x, x, label='linear')
plt.plot(x, x**2, label='quadratic')
plt.plot(x, x**3, label='cubic')

plt.xlabel('x label')
plt.ylabel('y label')

plt.title("Simple Plot")

plt.legend()

plt.show()
```

The first call to `plt.plot` will automatically create the necessary figure and axes to achieve the desired plot. Subsequent calls to `plt.plot` re-use the current axes and each add another line. Setting the title, legend, and axis labels also automatically use the current axes and set the title, create the legend, and label the axis respectively.

`pylab` is a convenience module that bulk imports `matplotlib.pyplot` (for plotting) and `numpy` (for mathematics and working with arrays) in a single name space. Although many examples use `pylab`, it is no longer recommended.

For non-interactive plotting it is suggested to use `pyplot` to create the figures and then the OO interface for plotting.

60.5 Coding Styles

When viewing this documentation and examples, you will find different coding styles and usage patterns. These styles are perfectly valid and have their pros and cons. Just about all of the examples can be converted into another style and achieve the same results. The only caveat is to avoid mixing the coding styles for your own code.

Note: Developers for matplotlib have to follow a specific style and guidelines. See *The Matplotlib Developers' Guide*.

Of the different styles, there are two that are officially supported. Therefore, these are the preferred ways to use matplotlib.

For the pyplot style, the imports at the top of your scripts will typically be:

```
import matplotlib.pyplot as plt
import numpy as np
```

Then one calls, for example, `np.arange`, `np.zeros`, `np.pi`, `plt.figure`, `plt.plot`, `plt.show`, etc. Use the pyplot interface for creating figures, and then use the object methods for the rest:

```
import matplotlib.pyplot as plt
import numpy as np
x = np.arange(0, 10, 0.2)
y = np.sin(x)
fig = plt.figure()
ax = fig.add_subplot(111)
ax.plot(x, y)
plt.show()
```

So, why all the extra typing instead of the MATLAB-style (which relies on global state and a flat namespace)? For very simple things like this example, the only advantage is academic: the wordier styles are more explicit, more clear as to where things come from and what is going on. For more complicated applications, this explicitness and clarity becomes increasingly valuable, and the richer and more complete object-oriented interface will likely make the program easier to write and maintain.

Typically one finds oneself making the same plots over and over again, but with different data sets, which leads to needing to write specialized functions to do the plotting. The recommended function signature is something like:

```
def my_plotter(ax, data1, data2, param_dict):
    """
    A helper function to make a graph

    Parameters
    -----
    ax : Axes
        The axes to draw to

    data1 : array
        The x data

    data2 : array
        The y data

    param_dict : dict
        Dictionary of kwargs to pass to ax.plot

    Returns
    -----
    out : list
        list of artists added
    """
```

```

out = ax.plot(data1, data2, **param_dict)
return out

```

which you would then use as:

```

fig, ax = plt.subplots(1, 1)
my_plotter(ax, data1, data2, {'marker':'x'})

```

or if you wanted to have 2 sub-plots:

```

fig, (ax1, ax2) = plt.subplots(1, 2)
my_plotter(ax1, data1, data2, {'marker':'x'})
my_plotter(ax2, data3, data4, {'marker':'o'})

```

Again, for these simple examples this style seems like overkill, however once the graphs get slightly more complex it pays off.

60.6 What is a backend?

A lot of documentation on the website and in the mailing lists refers to the “backend” and many new users are confused by this term. matplotlib targets many different use cases and output formats. Some people use matplotlib interactively from the python shell and have plotting windows pop up when they type commands. Some people embed matplotlib into graphical user interfaces like wxpython or pygtk to build rich applications. Others use matplotlib in batch scripts to generate postscript images from some numerical simulations, and still others in web application servers to dynamically serve up graphs.

To support all of these use cases, matplotlib can target different outputs, and each of these capabilities is called a backend; the “frontend” is the user facing code, i.e., the plotting code, whereas the “backend” does all the hard work behind-the-scenes to make the figure. There are two types of backends: user interface backends (for use in pygtk, wxpython, tkinter, qt4, or macosx; also referred to as “interactive backends”) and hardcopy backends to make image files (PNG, SVG, PDF, PS; also referred to as “non-interactive backends”).

There are four ways to configure your backend. If they conflict each other, the method mentioned last in the following list will be used, e.g. calling `use()` will override the setting in your `matplotlibrc`.

1. The backend parameter in your `matplotlibrc` file (see [Customizing matplotlib](#)):

```

backend : WXAgg # use wxpython with antigrain (agg) rendering

```

2. Setting the `MPLBACKEND` environment variable, either for your current shell or for a single script:

```

> export MPLBACKEND="module://my_backend"
> python simple_plot.py

> MPLBACKEND="module://my_backend" python simple_plot.py

```

Setting this environment variable will override the backend parameter in *any* `matplotlibrc`, even if there is a `matplotlibrc` in your current working directory. Therefore setting `MPLBACKEND` globally, e.g. in your `.bashrc` or `.profile`, is discouraged as it might lead to counter-intuitive behavior.

3. To set the backend for a single script, you can alternatively use the `-d` command line argument:

```
> python script.py -dbackend
```

This method is **deprecated** as the `-d` argument might conflict with scripts which parse command line arguments (see issue #1986). You should use `MPLBACKEND` instead.

4. If your script depends on a specific backend you can use the `use()` function:

```
import matplotlib
matplotlib.use('PS') # generate postscript output by default
```

If you use the `use()` function, this must be done before importing `matplotlib.pyplot`. Calling `use()` after `pyplot` has been imported will have no effect. Using `use()` will require changes in your code if users want to use a different backend. Therefore, you should avoid explicitly calling `use()` unless absolutely necessary.

Note: Backend name specifications are not case-sensitive; e.g., ‘GTKAgg’ and ‘gtkagg’ are equivalent.

With a typical installation of matplotlib, such as from a binary installer or a linux distribution package, a good default backend will already be set, allowing both interactive work and plotting from scripts, with output to the screen and/or to a file, so at least initially you will not need to use any of the methods given above.

If, however, you want to write graphical user interfaces, or a web application server (*Matplotlib in a web application server*), or need a better understanding of what is going on, read on. To make things a little more customizable for graphical user interfaces, matplotlib separates the concept of the renderer (the thing that actually does the drawing) from the canvas (the place where the drawing goes). The canonical renderer for user interfaces is Agg which uses the *Anti-Grain Geometry* C++ library to make a raster (pixel) image of the figure. All of the user interfaces except `macosx` can be used with agg rendering, e.g., `WXAgg`, `GTKAgg`, `QT4Agg`, `QT5Agg`, `TkAgg`. In addition, some of the user interfaces support other rendering engines. For example, with `GTK`, you can also select `GDK` rendering (backend `GTK` deprecated in 2.0) or `Cairo` rendering (backend `GTKCairo`).

For the rendering engines, one can also distinguish between *vector* or *raster* renderers. Vector graphics languages issue drawing commands like “draw a line from this point to this point” and hence are scale free, and raster backends generate a pixel representation of the line whose accuracy depends on a DPI setting.

Here is a summary of the matplotlib renderers (there is an eponymous backed for each; these are *non-interactive backends*, capable of writing to a file):

Renderer	Filetypes	Description
<i>AGG</i>	<i>png</i>	<i>raster graphics</i> – high quality images using the Anti-Grain Geometry engine
PS	<i>ps eps</i>	<i>vector graphics</i> – Postscript output
PDF	<i>pdf</i>	<i>vector graphics</i> – Portable Document Format
SVG	<i>svg</i>	<i>vector graphics</i> – Scalable Vector Graphics
<i>Cairo</i>	<i>png ps pdf svg</i> ...	<i>vector graphics</i> – Cairo graphics
<i>GDK</i>	<i>png jpg tiff ...</i>	<i>raster graphics</i> – the Gimp Drawing Kit Deprecated in 2.0

And here are the user interfaces and renderer combinations supported; these are *interactive backends*, capable of displaying to the screen and of using appropriate renderers from the table above to write to a file:

Back-end	Description
GTK-Agg	Agg rendering to a <i>GTK 2.x</i> canvas (requires PyGTK and pycairo or cairocffi ; Python2 only)
GTK3Agg	Agg rendering to a <i>GTK 3.x</i> canvas (requires PyGObject and pycairo or cairocffi)
GTK	GDK rendering to a <i>GTK 2.x</i> canvas (not recommended and deprecated in 2.0) (requires PyGTK and pycairo or cairocffi ; Python2 only)
GTK-Cairo	Cairo rendering to a <i>GTK 2.x</i> canvas (requires PyGTK and pycairo or cairocffi ; Python2 only)
GTK3Cairo	Cairo rendering to a <i>GTK 3.x</i> canvas (requires PyGObject and pycairo or cairocffi)
WX-Agg	Agg rendering to to a <i>wxWidgets</i> canvas (requires wxPython)
WX	Native <i>wxWidgets</i> drawing to a <i>wxWidgets</i> Canvas (not recommended and deprecated in 2.0) (requires wxPython)
TkAgg	Agg rendering to a <i>Tk</i> canvas (requires TkInter)
Qt4Agg	Agg rendering to a <i>Qt4</i> canvas (requires PyQt4 or pyside)
Qt5Agg	Agg rendering in a <i>Qt5</i> canvas (requires PyQt5)
macosx	Cocoa rendering in OSX windows (presently lacks blocking <code>show()</code> behavior when matplotlib is in non-interactive mode)

60.7 WX backends

At present the release version of [wxPython](#) (also known as [wxPython classic](#)) does not support python3. A work in progress redesigned version known as [wxPython-Phoenix](#) does support python3. Matplotlib should work with both versions.

60.8 GTK and Cairo

Both GTK2 and GTK3 have implicit dependencies on [PyCairo](#) regardless of the specific Matplotlib backend used. Unfortunately the latest release of [PyCairo](#) for Python3 does not implement the Python wrappers needed for the GTK3Agg backend. [Cairocffi](#) can be used as a replacement which implements the correct wrapper.

60.9 How do I select PyQt4 or PySide?

You can choose either PyQt4 or PySide when using the `qt4` backend by setting the appropriate value for `backend.qt4` in your `matplotlibrc` file. The default value is PyQt4.

The setting in your `matplotlibrc` file can be overridden by setting the `QT_API` environment variable to either `pyqt` or `pyside` to use PyQt4 or PySide, respectively.

Since the default value for the bindings to be used is PyQt4, `matplotlib` first tries to import it, if the import fails, it tries to import PySide.

60.10 What is interactive mode?

Use of an interactive backend (see *What is a backend?*) permits—but does not by itself require or ensure—plotting to the screen. Whether and when plotting to the screen occurs, and whether a script or shell session continues after a plot is drawn on the screen, depends on the functions and methods that are called, and on a state variable that determines whether `matplotlib` is in “interactive mode”. The default Boolean value is set by the `matplotlibrc` file, and may be customized like any other configuration parameter (see *Customizing matplotlib*). It may also be set via `matplotlib.interactive()`, and its value may be queried via `matplotlib.is_interactive()`. Turning interactive mode on and off in the middle of a stream of plotting commands, whether in a script or in a shell, is rarely needed and potentially confusing, so in the following we will assume all plotting is done with interactive mode either on or off.

Note: Major changes related to interactivity, and in particular the role and behavior of `show()`, were made in the transition to `matplotlib` version 1.0, and bugs were fixed in 1.0.1. Here we describe the version 1.0.1 behavior for the primary interactive backends, with the partial exception of *macosx*.

Interactive mode may also be turned on via `matplotlib.pyplot.ion()`, and turned off via `matplotlib.pyplot.ioff()`.

Note: Interactive mode works with suitable backends in `ipython` and in the ordinary python shell, but it does *not* work in the IDLE IDE. If the default backend does not support interactivity, an interactive backend can be explicitly activated using any of the methods discussed in *What is a backend?*.

60.10.1 Interactive example

From an ordinary python prompt, or after invoking `ipython` with no options, try this:

```
import matplotlib.pyplot as plt
plt.ion()
plt.plot([1.6, 2.7])
```

Assuming you are running version 1.0.1 or higher, and you have an interactive backend installed and selected by default, you should see a plot, and your terminal prompt should also be active; you can type additional

commands such as:

```
plt.title("interactive test")
plt.xlabel("index")
```

and you will see the plot being updated after each line. This is because you are in interactive mode *and* you are using pyplot functions. Now try an alternative method of modifying the plot. Get a reference to the `Axes` instance, and call a method of that instance:

```
ax = plt.gca()
ax.plot([3.1, 2.2])
```

Nothing changed, because the Axes methods do not include an automatic call to `draw_if_interactive()`; that call is added by the pyplot functions. If you are using methods, then when you want to update the plot on the screen, you need to call `draw()`:

```
plt.draw()
```

Now you should see the new line added to the plot.

60.10.2 Non-interactive example

Start a fresh session as in the previous example, but now turn interactive mode off:

```
import matplotlib.pyplot as plt
plt.ioff()
plt.plot([1.6, 2.7])
```

Nothing happened—or at least nothing has shown up on the screen (unless you are using `macosx` backend, which is anomalous). To make the plot appear, you need to do this:

```
plt.show()
```

Now you see the plot, but your terminal command line is unresponsive; the `show()` command *blocks* the input of additional commands until you manually kill the plot window.

What good is this—being forced to use a blocking function? Suppose you need a script that plots the contents of a file to the screen. You want to look at that plot, and then end the script. Without some blocking command such as `show()`, the script would flash up the plot and then end immediately, leaving nothing on the screen.

In addition, non-interactive mode delays all drawing until `show()` is called; this is more efficient than re-drawing the plot each time a line in the script adds a new feature.

Prior to version 1.0, `show()` generally could not be called more than once in a single script (although sometimes one could get away with it); for version 1.0.1 and above, this restriction is lifted, so one can write a script like this:

```
import numpy as np
import matplotlib.pyplot as plt
plt.ioff()
```

```
for i in range(3):  
    plt.plot(np.random.rand(10))  
    plt.show()
```

which makes three plots, one at a time.

60.10.3 Summary

In interactive mode, pyplot functions automatically draw to the screen.

When plotting interactively, if using object method calls in addition to pyplot functions, then call `draw()` whenever you want to refresh the plot.

Use non-interactive mode in scripts in which you want to generate one or more figures and display them before ending or generating a new set of figures. In that case, use `show()` to display the figure(s) and to block execution until you have manually destroyed them.

Contents

- *How-To*
 - *Plotting: howto*
 - * *Plot `numpy.datetime64` values*
 - * *Find all objects in a figure of a certain type*
 - * *How to prevent ticklabels from having an offset*
 - * *Save transparent figures*
 - * *Save multiple plots to one pdf file*
 - * *Move the edge of an axes to make room for tick labels*
 - * *Automatically make room for tick labels*
 - * *Configure the tick linewidths*
 - * *Align my ylabels across multiple subplots*
 - * *Skip dates where there is no data*
 - * *Control the depth of plot elements*
 - * *Make the aspect ratio for plots equal*
 - * *Multiple y-axis scales*
 - * *Generate images without having a window appear*
 - * *Use `show()`*
 - * *Interpreting box plots and violin plots*
 - *Contributing: howto*
 - * *Request a new feature*
 - * *Reporting a bug or submitting a patch*
 - * *Contribute to Matplotlib documentation*

- *Matplotlib in a web application server*
 - * *Matplotlib with apache*
 - * *Matplotlib with django*
 - * *Matplotlib with zope*
 - * *Clickable images for HTML*
- *Search examples*
- *Cite Matplotlib*

61.1 Plotting: howto

61.1.1 Plot `numpy.datetime64` values

For Matplotlib to plot dates (or any scalar with units) a converter to float needs to be registered with the `matplotlib.units` module. The current best converters for `datetime64` values are in `pandas`. Simply importing `pandas`

```
import pandas as pd
```

should be sufficient as `pandas` will try to install the converters on import. If that does not work, or you need to reset `munits.registry` you can explicitly install the `pandas` converters by

```
from pandas.tseries import converter as pdtc
pdtc.register()
```

If you only want to use the `pandas` converter for `datetime64` values

```
from pandas.tseries import converter as pdtc
import matplotlib.units as munits
import numpy as np

munits.registry[np.datetime64] = pdtc.DatetimeConverter()
```

61.1.2 Find all objects in a figure of a certain type

Every Matplotlib artist (see *Artist tutorial*) has a method called `findobj()` that can be used to recursively search the artist for any artists it may contain that meet some criteria (e.g., match all `Line2D` instances or match some arbitrary filter function). For example, the following snippet finds every object in the figure which has a `set_color` property and makes the object blue:

```
def myfunc(x):
    return hasattr(x, 'set_color')
```

```
for o in fig.findobj(myfunc):
    o.set_color('blue')
```

You can also filter on class instances:

```
import matplotlib.text as text
for o in fig.findobj(text.Text):
    o.set_fontstyle('italic')
```

61.1.3 How to prevent ticklabels from having an offset

The default formatter will use an offset to reduce the length of the ticklabels. To turn this feature off on a per-axis basis:

```
ax.get_xaxis().get_major_formatter().set_useOffset(False)
```

set the rcParam `axes.formatter.useoffset`, or use a different formatter. See [ticker](#) for details.

61.1.4 Save transparent figures

The `savefig()` command has a keyword argument `transparent` which, if ‘True’, will make the figure and axes backgrounds transparent when saving, but will not affect the displayed image on the screen.

If you need finer grained control, e.g., you do not want full transparency or you want to affect the screen displayed version as well, you can set the alpha properties directly. The figure has a `Rectangle` instance called `patch` and the axes has a `Rectangle` instance called `patch`. You can set any property on them directly (`facecolor`, `edgecolor`, `linewidth`, `linestyle`, `alpha`). e.g.:

```
fig = plt.figure()
fig.patch.set_alpha(0.5)
ax = fig.add_subplot(111)
ax.patch.set_alpha(0.5)
```

If you need *all* the figure elements to be transparent, there is currently no global alpha setting, but you can set the alpha channel on individual elements, e.g.:

```
ax.plot(x, y, alpha=0.5)
ax.set_xlabel('volts', alpha=0.5)
```

61.1.5 Save multiple plots to one pdf file

Many image file formats can only have one image per file, but some formats support multi-page files. Currently only the pdf backend has support for this. To make a multi-page pdf file, first initialize the file:

```
from matplotlib.backends.backend_pdf import PdfPages
pp = PdfPages('multipage.pdf')
```

You can give the *PdfPages* object to *savefig()*, but you have to specify the format:

```
plt.savefig(pp, format='pdf')
```

An easier way is to call *PdfPages.savefig()*:

```
pp.savefig()
```

Finally, the multipage pdf object has to be closed:

```
pp.close()
```

61.1.6 Move the edge of an axes to make room for tick labels

For subplots, you can control the default spacing on the left, right, bottom, and top as well as the horizontal and vertical spacing between multiple rows and columns using the *matplotlib.figure.Figure.subplots_adjust()* method (in pyplot it is *subplots_adjust()*). For example, to move the bottom of the subplots up to make room for some rotated x tick labels:

```
fig = plt.figure()
fig.subplots_adjust(bottom=0.2)
ax = fig.add_subplot(111)
```

You can control the defaults for these parameters in your *matplotlibrc* file; see *Customizing matplotlib*. For example, to make the above setting permanent, you would set:

```
figure.subplot.bottom : 0.2 # the bottom of the subplots of the figure
```

The other parameters you can configure are, with their defaults

left = 0.125 the left side of the subplots of the figure

right = 0.9 the right side of the subplots of the figure

bottom = 0.1 the bottom of the subplots of the figure

top = 0.9 the top of the subplots of the figure

wspace = 0.2 the amount of width reserved for blank space between subplots, expressed as a fraction of the average axis width

hspace = 0.2 the amount of height reserved for white space between subplots, expressed as a fraction of the average axis height

If you want additional control, you can create an *Axes* using the *axes()* command (or equivalently the figure *add_axes()* method), which allows you to specify the location explicitly:

```
ax = fig.add_axes([left, bottom, width, height])
```

where all values are in fractional (0 to 1) coordinates. See *pylab_examples example code: axes_demo.py* for an example of placing axes manually.

61.1.7 Automatically make room for tick labels

Note: This is now easier to handle than ever before. Calling `tight_layout()` can fix many common layout issues. See the *Tight Layout guide*.

The information below is kept here in case it is useful for other purposes.

In most use cases, it is enough to simply change the subplots adjust parameters as described in *Move the edge of an axes to make room for tick labels*. But in some cases, you don't know ahead of time what your tick labels will be, or how large they will be (data and labels outside your control may be being fed into your graphing application), and you may need to automatically adjust your subplot parameters based on the size of the tick labels. Any `Text` instance can report its extent in window coordinates (a negative x coordinate is outside the window), but there is a rub.

The `RendererBase` instance, which is used to calculate the text size, is not known until the figure is drawn (`draw()`). After the window is drawn and the text instance knows its renderer, you can call `get_window_extent()`. One way to solve this chicken and egg problem is to wait until the figure is draw by connecting (`mpl_connect()`) to the “on_draw” signal (`DrawEvent`) and get the window extent there, and then do something with it, e.g., move the left of the canvas over; see *Event handling and picking*.

Here is an example that gets a bounding box in relative figure coordinates (0..1) of each of the labels and uses it to move the left of the subplots over so that the tick labels fit in the figure

```
import matplotlib.pyplot as plt
import matplotlib.transforms as mtransforms
fig = plt.figure()
ax = fig.add_subplot(111)
ax.plot(range(10))
ax.set_yticks((2,5,7))
labels = ax.set_yticklabels(('really, really, really', 'long', 'labels'))

def on_draw(event):
    bboxes = []
    for label in labels:
        bbox = label.get_window_extent()
        # the figure transform goes from relative coords->pixels and we
        # want the inverse of that
        bboxi = bbox.inverse_transformed(fig.transFigure)
        bboxes.append(bboxi)

    # this is the bbox that bounds all the bboxes, again in relative
    # figure coords
    bbox = mtransforms.Bbox.union(bboxes)
    if fig.subplotpars.left < bbox.width:
        # we need to move it over
        fig.subplots_adjust(left=1.1*bbox.width) # pad a little
        fig.canvas.draw()
    return False

fig.canvas.mpl_connect('draw_event', on_draw)
```

```
plt.show()
```

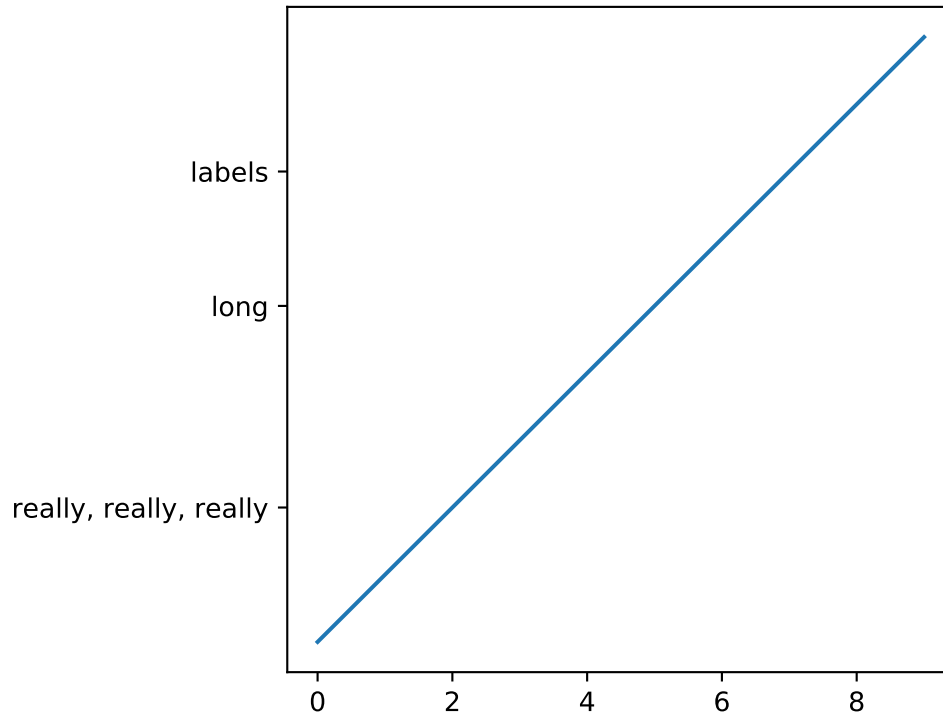

61.1.8 Configure the tick linewidths

In Matplotlib, the ticks are *markers*. All *Line2D* objects support a line (solid, dashed, etc) and a marker (circle, square, tick). The tick linewidth is controlled by the “`markeredgewidth`” property:

```
import matplotlib.pyplot as plt
fig = plt.figure()
ax = fig.add_subplot(111)
ax.plot(range(10))

for line in ax.get_xticklines() + ax.get_yticklines():
    line.set_markersize(10)

plt.show()
```

The other properties that control the tick marker, and all markers, are `markerfacecolor`, `markeredgewidth`, `markeredgewidth`, `markersize`. For more information on configuring ticks, see *Axis containers* and *Tick containers*.

61.1.9 Align my ylabels across multiple subplots

If you have multiple subplots over one another, and the y data have different scales, you can often get ylabels that do not align vertically across the multiple subplots, which can be unattractive. By default, Matplotlib positions the x location of the ylabel so that it does not overlap any of the y ticks. You can override this default behavior by specifying the coordinates of the label. The example below shows the default behavior in the left subplots, and the manual setting in the right subplots.

```
import numpy as np
import matplotlib.pyplot as plt

box = dict(facecolor='yellow', pad=5, alpha=0.2)

fig = plt.figure()
fig.subplots_adjust(left=0.2, wspace=0.6)

# Fixing random state for reproducibility
np.random.seed(19680801)

ax1 = fig.add_subplot(221)
ax1.plot(2000*np.random.rand(10))
ax1.set_title('ylabels not aligned')
ax1.set_ylabel('misaligned 1', bbox=box)
ax1.set_ylim(0, 2000)
ax3 = fig.add_subplot(223)
ax3.set_ylabel('misaligned 2',bbox=box)
ax3.plot(np.random.rand(10))

labelx = -0.3 # axes coords

ax2 = fig.add_subplot(222)
ax2.set_title('ylabels aligned')
ax2.plot(2000*np.random.rand(10))
ax2.set_ylabel('aligned 1', bbox=box)
ax2.yaxis.set_label_coords(labelx, 0.5)
ax2.set_ylim(0, 2000)

ax4 = fig.add_subplot(224)
ax4.plot(np.random.rand(10))
ax4.set_ylabel('aligned 2', bbox=box)
ax4.yaxis.set_label_coords(labelx, 0.5)

plt.show()
```

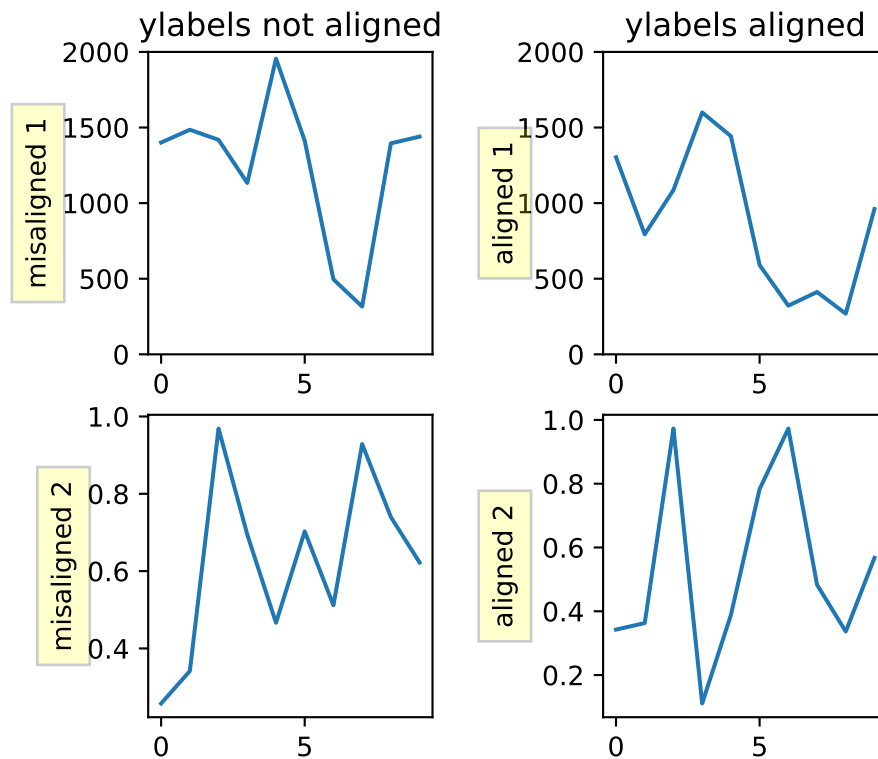

61.1.10 Skip dates where there is no data

When plotting time series, e.g., financial time series, one often wants to leave out days on which there is no data, e.g., weekends. By passing in dates on the x-axis, you get large horizontal gaps on periods when there is not data. The solution is to pass in some proxy x-data, e.g., evenly sampled indices, and then use a custom formatter to format these as dates. The example below shows how to use an ‘index formatter’ to achieve the desired plot:

```
import numpy as np
import matplotlib.pyplot as plt
import matplotlib.mlab as mlab
import matplotlib.ticker as ticker

r = mlab.csv2rec('../data/aapl.csv')
r.sort()
r = r[-30:] # get the last 30 days

N = len(r)
ind = np.arange(N) # the evenly spaced plot indices

def format_date(x, pos=None):
    thisind = np.clip(int(x+0.5), 0, N-1)
    return r.date[thisind].strftime('%Y-%m-%d')
```

```
fig = plt.figure()
ax = fig.add_subplot(111)
ax.plot(ind, r.adj_close, 'o-')
ax.xaxis.set_major_formatter(ticker.FuncFormatter(format_date))
fig.autofmt_xdate()

plt.show()
```

61.1.11 Control the depth of plot elements

Within an axes, the order that the various lines, markers, text, collections, etc appear is determined by the `set_zorder()` property. The default order is patches, lines, text, with collections of lines and collections of patches appearing at the same level as regular lines and patches, respectively:

```
line, = ax.plot(x, y, zorder=10)
```

You can also use the Axes property `set_axisbelow()` to control whether the grid lines are placed above or below your other plot elements.

61.1.12 Make the aspect ratio for plots equal

The Axes property `set_aspect()` controls the aspect ratio of the axes. You can set it to be 'auto', 'equal', or some ratio which controls the ratio:

```
ax = fig.add_subplot(111, aspect='equal')
```

61.1.13 Multiple y-axis scales

A frequent request is to have two scales for the left and right y-axis, which is possible using `twinx()` (more than two scales are not currently supported, though it is on the wish list). This works pretty well, though there are some quirks when you are trying to interactively pan and zoom, because both scales do not get the signals.

The approach uses `twinx()` (and its sister `twiny()`) to use 2 *different axes*, turning the axes rectangular frame off on the 2nd axes to keep it from obscuring the first, and manually setting the tick locs and labels as desired. You can use separate `matplotlib.ticker` formatters and locators as desired because the two axes are independent.

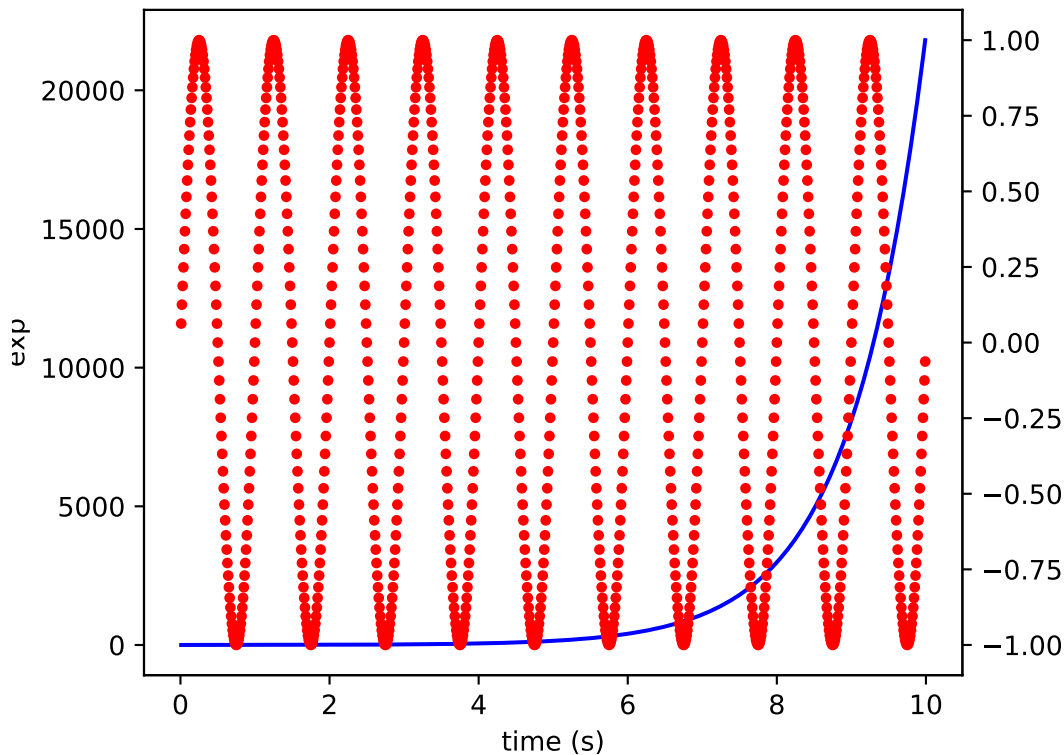

61.1.14 Generate images without having a window appear

The easiest way to do this is use a non-interactive backend (see *What is a backend?*) such as Agg (for PNGs), PDF, SVG or PS. In your figure-generating script, just call the `matplotlib.use()` directive before importing pylab or pyplot:

```
import matplotlib
matplotlib.use('Agg')
import matplotlib.pyplot as plt
plt.plot([1,2,3])
plt.savefig('myfig')
```

See also:

Matplotlib in a web application server for information about running matplotlib inside of a web application.

61.1.15 Use `show()`

When you want to view your plots on your display, the user interface backend will need to start the GUI mainloop. This is what `show()` does. It tells Matplotlib to raise all of the figure windows created so far and start the mainloop. Because this mainloop is blocking by default (i.e., script execution is paused), you should only call this once per script, at the end. Script execution is resumed after the last window is closed.

Therefore, if you are using Matplotlib to generate only images and do not want a user interface window, you do not need to call `show` (see *Generate images without having a window appear* and *What is a backend?*).

Note: Because closing a figure window invokes the destruction of its plotting elements, you should call `savefig()` before calling `show` if you wish to save the figure as well as view it.

New in version v1.0.0: `show` now starts the GUI mainloop only if it isn't already running. Therefore, multiple calls to `show` are now allowed.

Having `show` block further execution of the script or the python interpreter depends on whether Matplotlib is set for interactive mode or not. In non-interactive mode (the default setting), execution is paused until the last figure window is closed. In interactive mode, the execution is not paused, which allows you to create additional figures (but the script won't finish until the last figure window is closed).

Note: Support for interactive/non-interactive mode depends upon the backend. Until version 1.0.0 (and subsequent fixes for 1.0.1), the behavior of the interactive mode was not consistent across backends. As of v1.0.1, only the macosx backend differs from other backends because it does not support non-interactive mode.

Because it is expensive to draw, you typically will not want Matplotlib to redraw a figure many times in a script such as the following:

```
plot([1,2,3])           # draw here ?
xlabel('time')         # and here ?
ylabel('volts')       # and here ?
title('a simple plot') # and here ?
show()
```

However, it is *possible* to force Matplotlib to draw after every command, which might be what you want when working interactively at the python console (see *Using matplotlib in a python shell*), but in a script you want to defer all drawing until the call to `show`. This is especially important for complex figures that take some time to draw. `show()` is designed to tell Matplotlib that you're all done issuing commands and you want to draw the figure now.

Note: `show()` should typically only be called at most once per script and it should be the last line of your script. At that point, the GUI takes control of the interpreter. If you want to force a figure draw, use `draw()` instead.

Many users are frustrated by `show` because they want it to be a blocking call that raises the figure, pauses the script until they close the figure, and then allow the script to continue running until the next figure is created and the next `show` is made. Something like this:

```
# WARNING : illustrating how NOT to use show
for i in range(10):
    # make figure i
    show()
```

This is not what show does and unfortunately, because doing blocking calls across user interfaces can be tricky, is currently unsupported, though we have made significant progress towards supporting blocking events.

New in version v1.0.0: As noted earlier, this restriction has been relaxed to allow multiple calls to `show`. In *most* backends, you can now expect to be able to create new figures and raise them in a subsequent call to `show` after closing the figures from a previous call to `show`.

61.1.16 Interpreting box plots and violin plots

Tukey’s [box plots](#) (Robert McGill, John W. Tukey and Wayne A. Larsen: “The American Statistician” Vol. 32, No. 1, Feb., 1978, pp. 12-16) are statistical plots that provide useful information about the data distribution such as skewness. However, bar plots with error bars are still the common standard in most scientific literature, and thus, the interpretation of box plots can be challenging for the unfamiliar reader. The figure below illustrates the different visual features of a box plot.

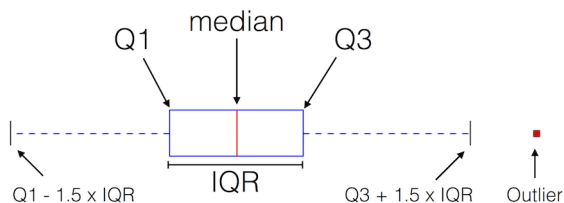

- Q1:** *Quartile 1*, or median of the *left* data subset after dividing the original data set into 2 subsets via the median (25% of the data points fall below this threshold)
- Q3:** *Quartile 3*, median of the *right* data subset (75% of the data points fall below this threshold)
- IQR:** *Interquartile-range*, $Q3 - Q1$
- Outliers:** Data points are considered to be outliers if $value < Q1 - 1.5 \times IQR$ or $value > Q3 + 1.5 \times IQR$

 Sebastian Raschka, 2016
This work is licensed under a Creative Commons Attribution 4.0 International License

[Violin plots](#) are closely related to box plots but add useful information such as the distribution of the sample data (density trace). Violin plots were added in Matplotlib 1.4.

61.2 Contributing: howto

61.2.1 Request a new feature

Is there a feature you wish Matplotlib had? Then ask! The best way to get started is to email the developer [mailing list](#) for discussion. This is an open source project developed primarily in the contributors free time, so there is no guarantee that your feature will be added. The *best* way to get the feature you need added is to contribute it your self.

61.2.2 Reporting a bug or submitting a patch

The development of Matplotlib is organized through [github](#). If you would like to report a bug or submit a patch please use that interface.

To report a bug [create an issue](#) on github (this requires having a github account). Please include a [Short, Self Contained, Correct \(Compilable\), Example](#) demonstrating what the bug is. Including a clear, easy to test example makes it easy for the developers to evaluate the bug. Expect that the bug reports will be a conversation. If you do not want to register with github, please email bug reports to the [mailing list](#).

The easiest way to submit patches to Matplotlib is through pull requests on github. Please see the *The Matplotlib Developers' Guide* for the details.

61.2.3 Contribute to Matplotlib documentation

Matplotlib is a big library, which is used in many ways, and the documentation has only scratched the surface of everything it can do. So far, the place most people have learned all these features are through studying the examples (*Search examples*), which is a recommended and great way to learn, but it would be nice to have more official narrative documentation guiding people through all the dark corners. This is where you come in.

There is a good chance you know more about Matplotlib usage in some areas, the stuff you do every day, than many of the core developers who wrote most of the documentation. Just pulled your hair out compiling Matplotlib for windows? Write a FAQ or a section for the *Installation* page. Are you a digital signal processing wizard? Write a tutorial on the signal analysis plotting functions like `xcorr()`, `psd()` and `specgram()`. Do you use Matplotlib with [django](#) or other popular web application servers? Write a FAQ or tutorial and we'll find a place for it in the *User's Guide*. Bundle Matplotlib in a `py2exe` app? ... I think you get the idea.

Matplotlib is documented using the [sphinx](#) extensions to restructured text ([ReST](#)). sphinx is an extensible python framework for documentation projects which generates HTML and PDF, and is pretty easy to write; you can see the source for this document or any page on this site by clicking on the *Show Source* link at the end of the page in the sidebar.

The sphinx website is a good resource for learning sphinx, but we have put together a cheat-sheet at *Developer's tips for documenting matplotlib* which shows you how to get started, and outlines the Matplotlib conventions and extensions, e.g., for including plots directly from external code in your documents.

Once your documentation contributions are working (and hopefully tested by actually *building* the docs) you can submit them as a patch against git. See *Install git* and *Reporting a bug or submitting a patch*. Looking for something to do? Search for TODO or look at the open issues on github.

61.3 Matplotlib in a web application server

Many users report initial problems trying to use matplotlib in web application servers, because by default Matplotlib ships configured to work with a graphical user interface which may require an X11 connection. Since many barebones application servers do not have X11 enabled, you may get errors if you don't configure Matplotlib for use in these environments. Most importantly, you need to decide what kinds of images you want to generate (PNG, PDF, SVG) and configure the appropriate default backend. For 99% of users,

this will be the Agg backend, which uses the C++ `antigrain` rendering engine to make nice PNGs. The Agg backend is also configured to recognize requests to generate other output formats (PDF, PS, EPS, SVG). The easiest way to configure Matplotlib to use Agg is to call:

```
# do this before importing pylab or pyplot
import matplotlib
matplotlib.use('Agg')
import matplotlib.pyplot as plt
```

For more on configuring your backend, see *What is a backend?*.

Alternatively, you can avoid pylab/pyplot altogether, which will give you a little more control, by calling the API directly as shown in *api example code: agg_oo.py*.

You can either generate hardcopy on the filesystem by calling `savefig`:

```
# do this before importing pylab or pyplot
import matplotlib
matplotlib.use('Agg')
import matplotlib.pyplot as plt
fig = plt.figure()
ax = fig.add_subplot(111)
ax.plot([1,2,3])
fig.savefig('test.png')
```

or by saving to a file handle:

```
import sys
fig.savefig(sys.stdout)
```

Here is an example using `Pillow`. First, the figure is saved to a `BytesIO` object which is then fed to `Pillow` for further processing:

```
from io import BytesIO
from PIL import Image
imgdata = BytesIO()
fig.savefig(imgdata, format='png')
imgdata.seek(0) # rewind the data
im = Image.open(imgdata)
```

61.3.1 Matplotlib with apache

TODO; see *Contribute to Matplotlib documentation*.

61.3.2 Matplotlib with django

TODO; see *Contribute to Matplotlib documentation*.

61.3.3 Matplotlib with zope

TODO; see *Contribute to Matplotlib documentation*.

61.3.4 Clickable images for HTML

Andrew Dalke of [Dalke Scientific](#) has written a nice [article](#) on how to make html click maps with Matplotlib agg PNGs. We would also like to add this functionality to SVG. If you are interested in contributing to these efforts that would be great.

61.4 Search examples

The nearly 300 code *Matplotlib Examples* included with the Matplotlib source distribution are full-text searchable from the search page, but sometimes when you search, you get a lot of results from the *The Matplotlib API* or other documentation that you may not be interested in if you just want to find a complete, free-standing, working piece of example code. To facilitate example searches, we have tagged every code example page with the keyword *codex* for *code example* which shouldn't appear anywhere else on this site except in the FAQ. So if you want to search for an example that uses an ellipse, search for *codex ellipse*.

61.5 Cite Matplotlib

If you want to refer to Matplotlib in a publication, you can use “Matplotlib: A 2D Graphics Environment” by J. D. Hunter In *Computing in Science & Engineering*, Vol. 9, No. 3. (2007), pp. 90-95 (see [this reference page](#)):

```
@article{Hunter:2007,
  Address = {10662 LOS VAQUEROS CIRCLE, PO BOX 3014, LOS ALAMITOS, CA 90720-1314,
  ↪USA},
  Author = {Hunter, John D.},
  Date-Added = {2010-09-23 12:22:10 -0700},
  Date-Modified = {2010-09-23 12:22:10 -0700},
  Isi = {000245668100019},
  Isi-Recid = {155389429},
  Journal = {Computing In Science \& Engineering},
  Month = {May-Jun},
  Number = {3},
  Pages = {90--95},
  Publisher = {IEEE COMPUTER SOC},
  Times-Cited = {21},
  Title = {Matplotlib: A 2D graphics environment},
  Type = {Editorial Material},
  Volume = {9},
  Year = {2007},
  Abstract = {Matplotlib is a 2D graphics package used for Python for application
    development, interactive scripting, and publication-quality image
    generation across user interfaces and operating systems.},
  Bdsk-Url-1 = {http://gateway.isiknowledge.com/gateway/Gateway.cgi?GWVersion=2&
  ↪SrcAuth=Alerting&SrcApp=Alerting&DestApp=WOS&DestLinkType=FullRecord;
  ↪KeyUT=000245668100019}}
```

TROUBLESHOOTING

Contents

- *Troubleshooting*
 - *Obtaining matplotlib version*
 - *matplotlib install location*
 - *matplotlib configuration and cache directory locations*
 - *Getting help*
 - *Problems with recent git versions*

62.1 Obtaining matplotlib version

To find out your matplotlib version number, import it and print the `__version__` attribute:

```
>>> import matplotlib
>>> matplotlib.__version__
'0.98.0'
```

62.2 matplotlib install location

You can find what directory matplotlib is installed in by importing it and printing the `__file__` attribute:

```
>>> import matplotlib
>>> matplotlib.__file__
'/home/jdhunter/dev/lib64/python2.5/site-packages/matplotlib/__init__.pyc'
```

62.3 matplotlib configuration and cache directory locations

Each user has a matplotlib configuration directory which may contain a *matplotlibrc* file. To locate your matplotlib/ configuration directory, use `matplotlib.get_configdir()`:

```
>>> import matplotlib as mpl
>>> mpl.get_configdir()
'/home/darren/.config/matplotlib'
```

On unix-like systems, this directory is generally located in your *HOME* directory under the `.config/` directory.

In addition, users have a cache directory. On unix-like systems, this is separate from the configuration directory by default. To locate your `.cache/` directory, use `matplotlib.get_cachedir()`:

```
>>> import matplotlib as mpl
>>> mpl.get_cachedir()
'/home/darren/.cache/matplotlib'
```

On windows, both the config directory and the cache directory are the same and are in your Documents and Settings or Users directory by default:

```
>>> import matplotlib as mpl
>>> mpl.get_configdir()
'C:\\Documents and Settings\\jdhunter\\.matplotlib'
>>> mpl.get_cachedir()
'C:\\Documents and Settings\\jdhunter\\.matplotlib'
```

If you would like to use a different configuration directory, you can do so by specifying the location in your *MPLCONFIGDIR* environment variable – see *Setting environment variables in Linux and OS-X*. Note that *MPLCONFIGDIR* sets the location of both the configuration directory and the cache directory.

62.4 Getting help

There are a number of good resources for getting help with matplotlib. There is a good chance your question has already been asked:

- The [mailing list archive](#).
- [Github issues](#).
- Stackoverflow questions tagged [matplotlib](#).

If you are unable to find an answer to your question through search, please provide the following information in your e-mail to the [mailing list](#):

- your operating system; (Linux/UNIX users: post the output of `uname -a`)
- matplotlib version:

```
python -c `import matplotlib; print matplotlib.__version__`
```

- where you obtained matplotlib (e.g., your Linux distribution's packages, github, PyPi, or [Anaconda](#) or [Enthought Canopy](#)).
- any customizations to your `matplotlibrc` file (see [Customizing matplotlib](#)).
- if the problem is reproducible, please try to provide a *minimal*, standalone Python script that demonstrates the problem. This is *the* critical step. If you can't post a piece of code that we can run and reproduce your error, the chances of getting help are significantly diminished. Very often, the mere act of trying to minimize your code to the smallest bit that produces the error will help you find a bug in *your* code that is causing the problem.
- you can get very helpful debugging output from matplotlib by running your script with a `verbose-helpful` or `--verbose-debug` flags and posting the verbose output the lists:

```
> python simple_plot.py --verbose-helpful > output.txt
```

If you compiled matplotlib yourself, please also provide

- any changes you have made to `setup.py` or `setuptools.py`
- the output of:

```
rm -rf build
python setup.py build
```

The beginning of the build output contains lots of details about your platform that are useful for the matplotlib developers to diagnose your problem.

- your compiler version – e.g., `gcc --version`

Including this information in your first e-mail to the mailing list will save a lot of time.

You will likely get a faster response writing to the mailing list than filing a bug in the bug tracker. Most developers check the bug tracker only periodically. If your problem has been determined to be a bug and can not be quickly solved, you may be asked to file a bug in the tracker so the issue doesn't get lost.

62.5 Problems with recent git versions

First make sure you have a clean build and install (see [How to completely remove matplotlib](#)), get the latest git update, install it and run a simple test script in debug mode:

```
rm -rf build
rm -rf /path/to/site-packages/matplotlib*
git pull
python setup.py install > build.out
python examples/pylab_examples/simple_plot.py --verbose-debug > run.out
```

and post `build.out` and `run.out` to the [matplotlib-devel](#) mailing list (please do not post git problems to the [users list](#)).

Of course, you will want to clearly describe your problem, what you are expecting and what you are getting, but often a clean build and install will help. See also *Getting help*.

ENVIRONMENT VARIABLES

Contents

- *Environment Variables*
 - *Setting environment variables in Linux and OS-X*
 - * *BASH/KSH*
 - * *CSH/TCSH*
 - *Setting environment variables in windows*

HOME

The user's home directory. On linux, ~ is shorthand for *HOME*.

PATH

The list of directories searched to find executable programs

PYTHONPATH

The list of directories that is added to Python's standard search list when importing packages and modules

MPLCONFIGDIR

This is the directory used to store user customizations to matplotlib, as well as some caches to improve performance. If *MPLCONFIGDIR* is not defined, *HOME/.matplotlib* is used if it is writable. Otherwise, the python standard library `tempfile.gettmpdir()` is used to find a base directory in which the `matplotlib` subdirectory is created.

MPLBACKEND

This optional variable can be set to choose the matplotlib backend. Using the `-d` command line parameter or the `use()` function will override this value. See *What is a backend?*.

63.1 Setting environment variables in Linux and OS-X

To list the current value of *PYTHONPATH*, which may be empty, try:

```
echo $PYTHONPATH
```

The procedure for setting environment variables in depends on what your default shell is. **BASH** seems to be the most common, but **CSH** is also common. You should be able to determine which by running at the command prompt:

```
echo $SHELL
```

63.1.1 BASH/KSH

To create a new environment variable:

```
export PYTHONPATH=~/.Python
```

To prepend to an existing environment variable:

```
export PATH=~/.bin:${PATH}
```

The search order may be important to you, do you want `~/bin` to be searched first or last? To append to an existing environment variable:

```
export PATH=${PATH}:~/bin
```

To make your changes available in the future, add the commands to your `~/ .bashrc` file.

63.1.2 CSH/TCSH

To create a new environment variable:

```
setenv PYTHONPATH ~/.Python
```

To prepend to an existing environment variable:

```
setenv PATH ~/.bin:${PATH}
```

The search order may be important to you, do you want `~/bin` to be searched first or last? To append to an existing environment variable:

```
setenv PATH ${PATH}:~/bin
```

To make your changes available in the future, add the commands to your `~/ .cshrc` file.

63.2 Setting environment variables in windows

Open the **Control Panel** (*Start → Control Panel*), start the **System** program. Click the *Advanced* tab and select the *Environment Variables* button. You can edit or add to the *User Variables*.

WORKING WITH MATPLOTLIB IN VIRTUAL ENVIRONMENTS

Contents

- *Working with Matplotlib in Virtual environments*
 - *Introduction*
 - *GUI Frameworks*

64.1 Introduction

When running `matplotlib` in a [virtual environment](#) you may discover a few issues. `matplotlib` itself has no issue with virtual environments. However, the GUI frameworks that `matplotlib` uses for interactive figures have some issues with virtual environments. Everything below assumes some familiarity with the Matplotlib backends as found in [What is a backend?](#).

If you only use the IPython/Jupyter Notebook's `inline` and `notebook` backends and non interactive backends you should not have any issues and can ignore everything below.

If you are using Matplotlib on OSX you may also want to consider the [OSX framework FAQ](#).

64.2 GUI Frameworks

Interactive Matplotlib relies heavily on the interaction with external GUI frameworks.

Most GUI frameworks are not pip installable. This makes it tricky to install them within a virtual environment. This problem does not exist if you use Conda environments where you can install all Conda supported GUI frameworks directly into the environment. In regular `virtualenv` environment various workarounds exist. Some of these are given here:

- The `TKAgg` backend doesn't require any external dependencies and is normally always available.
- The QT4 framework `PySide` is pip installable.
- `PYQT5` is pip installable on Python 3.5.

Other frameworks are harder to install into a virtual environment. There are at least two possible ways to get access to these in a virtual environment.

One often suggested solution is to use the `--system-site-packages` option to `virtualenv` when creating an environment. This adds all system wide packages to the virtual environment. However, this breaks the isolation between the virtual environment and the system install. Among other issues it results in hard to debug problems with system packages shadowing the environment packages. If you use `virtualenvwrapper` this can be toggled with the `toggleglobalsitepackages` command.

Alternatively, you can manually symlink the GUI frameworks into the environment. I.e. to use `PyQt5`, you should symlink `PyQt5` and `sip` from your system site packages directory into the environment taking care that the environment and the systemwide install use the same python version.

WORKING WITH MATPLOTLIB ON OSX

Contents

- *Working with Matplotlib on OSX*
 - *Introduction*
 - *Short version*
 - * *VirtualEnv*
 - * *Pyenv*
 - * *Conda*
 - *Long version*
 - * *PYTHONHOME Function*
 - *PYTHONHOME and Jupyter*
 - *PYTHONHOME Script*
 - *PythonW Compiler*

65.1 Introduction

On OSX, two different types of Python Builds exist: a regular build and a framework build. In order to interact correctly with OSX through the native GUI frameworks you need a framework build of Python. At the time of writing the `macosx` and `WXAgg` backends require a framework build to function correctly. This can result in issues for a python installation not build as a framework and may also happen in virtual envs and when using (Ana)Conda. From Matplotlib 1.5 onwards the `macosx` backend checks that a framework build is available and fails if a non framework build is found. WX has a similar check build in.

Without this check a partially functional figure is created. Among the issues with it is that it is produced in the background and cannot be put in front of any other window. Several solutions and work arounds exist see below.

65.2 Short version

65.2.1 VirtualEnv

If you are on Python 3, use `venv` instead of `virtualenv`:

```
python -m venv my-virtualenv
source my-virtualenv/bin/activate
```

Otherwise you will need one of the workarounds below.

65.2.2 Pyenv

If you are using `pyenv` and `virtualenv` you can enable your python version to be installed as a framework:

```
PYTHON_CONFIGURE_OPTS="--enable-framework" pyenv install x.x.x
```

65.2.3 Conda

The default python provided in (Ana)Conda is not a framework build. However, the Conda developers have made it easy to install a framework build in both the main environment and in Conda envs. To use this install `python.app conda install python.app` and use `pythonw` rather than `python`

65.3 Long version

Unfortunately `virtualenv` creates a non framework build even if created from a framework build of Python. As documented above you can use `venv` as an alternative on Python 3.

The issue has been reported on the `virtualenv` bug tracker [here](#) and [here](#)

Until this is fixed, one of the following workarounds can be used:

65.3.1 PYTHONHOME Function

The best known work around is to use the non `virtualenv` python along with the `PYTHONHOME` environment variable. This can be done by defining a function in your `.bashrc` using

```
function frameworkpython {
    if [[ ! -z "$VIRTUAL_ENV" ]]; then
        PYTHONHOME=$VIRTUAL_ENV /usr/local/bin/python "$@"
    else
        /usr/local/bin/python "$@"
    fi
}
```

This function can then be used in all of your virtualenvs without having to fix every single one of them.

With this in place you can run `frameworkpython` to get an interactive framework build within the virtualenv. To run a script you can do `frameworkpython test.py` where `test.py` is a script that requires a framework build. To run an interactive IPython session with the framework build within the virtual environment you can do `frameworkpython -m IPython`

PYTHONHOME and Jupyter

This approach can be followed even if using [Jupyter](#) notebooks: you just need to setup a kernel with the suitable PYTHONHOME definition. The `jupyter-virtualenv-osx` script automates the creation of such a kernel.

PYTHONHOME Script

An alternative work around borrowed from the [WX wiki](#), is to use the non virtualenv python along with the PYTHONHOME environment variable. This can be implemented in a script as below. To use this modify PYVER and PATHTOPYTHON and put the script in the virtualenv bin directory i.e. `PATHTOENV/bin/frameworkpython`

```
#!/bin/bash

# what real Python executable to use
PYVER=2.7
PATHTOPYTHON=/usr/local/bin/
PYTHON=${PATHTOPYTHON}python${PYVER}

# find the root of the virtualenv, it should be the parent of the dir this script is in
ENV=`$PYTHON -c "import os; print(os.path.abspath(os.path.join(os.path.dirname(\"$0\"),
↪ '..')))"`

# now run Python with the virtualenv set as Python's HOME
export PYTHONHOME=$ENV
exec $PYTHON "$@"
```

With this in place you can run `frameworkpython` as above but will need to add this script to every virtualenv

PythonW Compiler

In addition `virtualenv-pythonw-osx` provides an alternative workaround which may be used to solve the issue.

Part IV

Matplotlib AxesGrid Toolkit

The matplotlib AxesGrid toolkit is a collection of helper classes to ease displaying multiple images in matplotlib. While the `aspect` parameter in matplotlib adjust the position of the single axes, AxesGrid toolkit provides a framework to adjust the position of multiple axes according to their aspects.

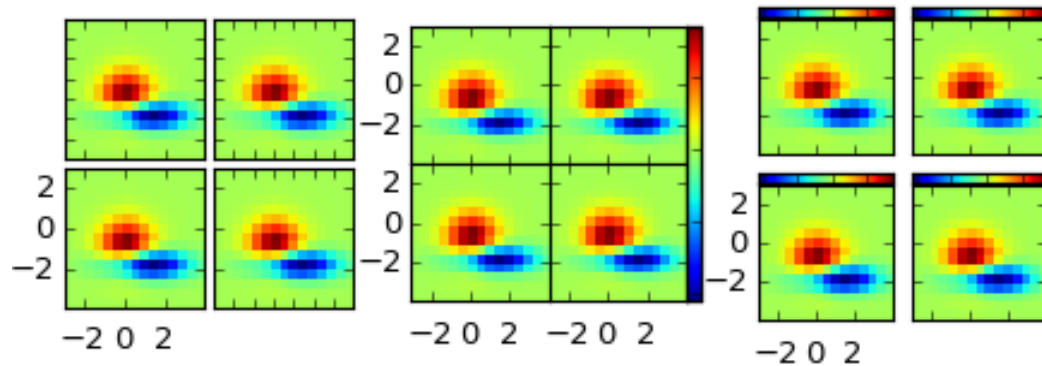

Note: AxesGrid toolkit has been a part of matplotlib since v 0.99. Originally, the toolkit had a single namespace of `axes_grid`. In more recent version (since svn r8226), the toolkit has divided into two separate namespace (`axes_grid1` and `axisartist`). While `axes_grid` namespace is maintained for the backward compatibility, use of `axes_grid1` and `axisartist` is recommended.

Warning: `axes_grid` and `axisartist` (but not `axes_grid1`) uses a custom Axes class (derived from the mpl's original Axes class). As a side effect, some commands (mostly tick-related) do not work. Use `axes_grid1` to avoid this, or see how things are different in `axes_grid` and `axisartist` ([LINK](#) needed)

OVERVIEW OF AXESGRID TOOLKIT

66.1 What is AxesGrid toolkit?

The matplotlib AxesGrid toolkit is a collection of helper classes, mainly to ease displaying (multiple) images in matplotlib.

Note: AxesGrid toolkit has been a part of matplotlib since v 0.99. Originally, the toolkit had a single namespace of *axes_grid*. In more recent version (since svn r8226), the toolkit has divided into two separate namespace (*axes_grid1* and *axisartist*). While *axes_grid* namespace is maintained for the backward compatibility, use of *axes_grid1* and *axisartist* is recommended.

Warning: *axes_grid* and *axisartist* (but not *axes_grid1*) uses a custom Axes class (derived from the mpl's original Axes class). As a side effect, some commands (mostly tick-related) do not work. Use *axes_grid1* to avoid this, or see how things are different in *axes_grid* and *axisartist* ([LINK](#) needed)

AxesGrid toolkit has two namespaces (*axes_grid1* and *axisartist*). *axisartist* contains custom Axes class that is meant to support for curvilinear grids (e.g., the world coordinate system in astronomy). Unlike mpl's original Axes class which uses `Axes.xaxis` and `Axes.yaxis` to draw ticks, ticklines and etc., Axes in *axisartist* uses special artist (`AxisArtist`) which can handle tick, ticklines and etc. for curved coordinate systems.

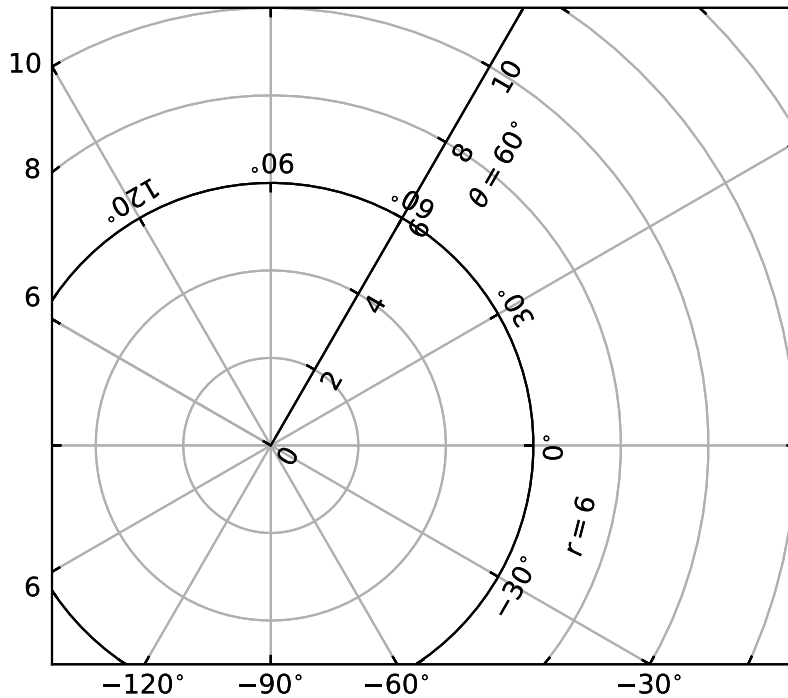

Since it uses a special artists, some mpl commands that work on `Axes.xaxis` and `Axes.yaxis` may not work. See [LINK](#) for more detail.

`axes_grid1` is a collection of helper classes to ease displaying (multiple) images with matplotlib. In matplotlib, the axes location (and size) is specified in the normalized figure coordinates, which may not be ideal for displaying images that needs to have a given aspect ratio. For example, it helps you to have a colorbar whose height always matches that of the image. *ImageGrid*, *RGB Axes* and *AxesDivider* are helper classes that deals with adjusting the location of (multiple) Axes. They provides a framework to adjust the position of multiple axes at the drawing time. *ParasiteAxes* provides `twinx`(or `twiny`)-like features so that you can plot different data (e.g., different y-scale) in a same Axes. *AnchoredArtists* includes custom artists which are placed at some anchored position, like the legend.

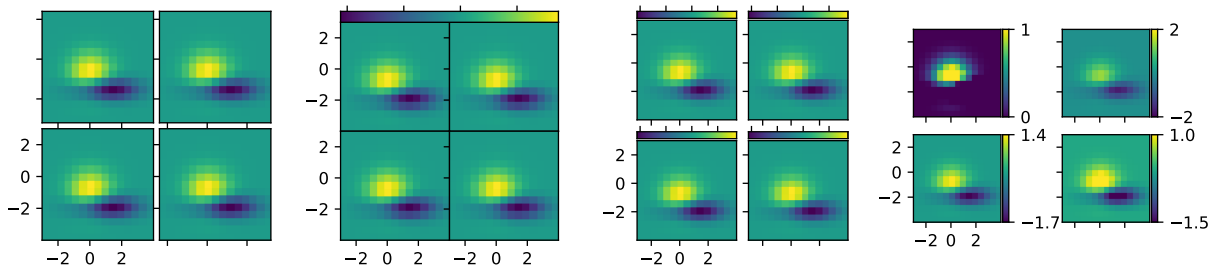

66.2 AXES_GRID1

66.2.1 ImageGrid

A class that creates a grid of Axes. In matplotlib, the axes location (and size) is specified in the normalized figure coordinates. This may not be ideal for images that needs to be displayed with a given aspect ratio. For example, displaying images of a same size with some fixed padding between them cannot be easily done in matplotlib. ImageGrid is used in such case.

```
import matplotlib.pyplot as plt
from mpl_toolkits.axes_grid1 import ImageGrid
import numpy as np

im = np.arange(100)
im.shape = 10, 10

fig = plt.figure(1, (4., 4.))
grid = ImageGrid(fig, 111, # similar to subplot(111)
                 nrows_ncols=(2, 2), # creates 2x2 grid of axes
                 axes_pad=0.1, # pad between axes in inch.
                 )

for i in range(4):
    grid[i].imshow(im) # The AxesGrid object work as a list of axes.

plt.show()
```

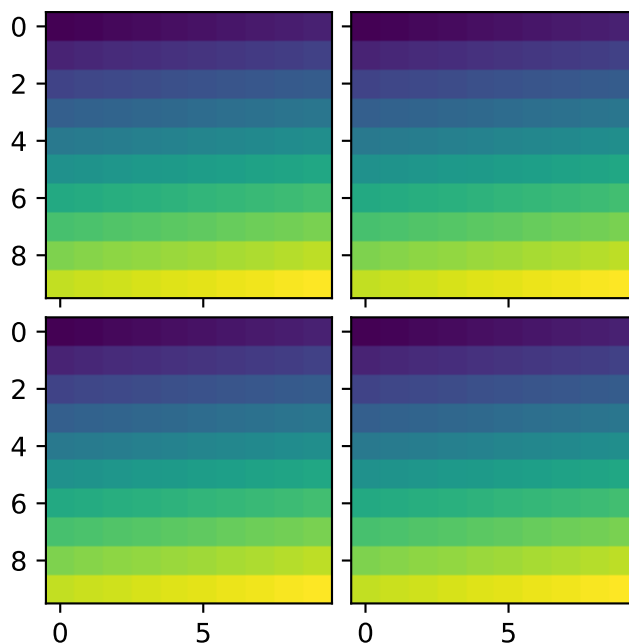

- The position of each axes is determined at the drawing time (see *AxesDivider*), so that the size of the entire grid fits in the given rectangle (like the aspect of axes). Note that in this example, the paddings between axes are fixed even if you changes the figure size.
- axes in the same column has a same axes width (in figure coordinate), and similarly, axes in the same row has a same height. The widths (height) of the axes in the same row (column) are scaled according to their view limits (xlim or ylim).

```
import matplotlib.pyplot as plt
from mpl_toolkits.axes_grid1 import ImageGrid

def get_demo_image():
    import numpy as np
    from matplotlib.cbook import get_sample_data
    f = get_sample_data("axes_grid/bivariate_normal.npy", asfileobj=False)
    z = np.load(f)
    # z is a numpy array of 15x15
    return z, (-3, 4, -4, 3)

F = plt.figure(1, (5.5, 3.5))
grid = ImageGrid(F, 111, # similar to subplot(111)
                 rows_ncols=(1, 3),
                 axes_pad=0.1,
                 add_all=True,
                 label_mode="L",
                 )

Z, extent = get_demo_image() # demo image

im1 = Z
im2 = Z[:, :10]
im3 = Z[:, 10:]
vmin, vmax = Z.min(), Z.max()
for i, im in enumerate([im1, im2, im3]):
    ax = grid[i]
    ax.imshow(im, origin="lower", vmin=vmin,
              vmax=vmax, interpolation="nearest")

plt.draw()
plt.show()
```

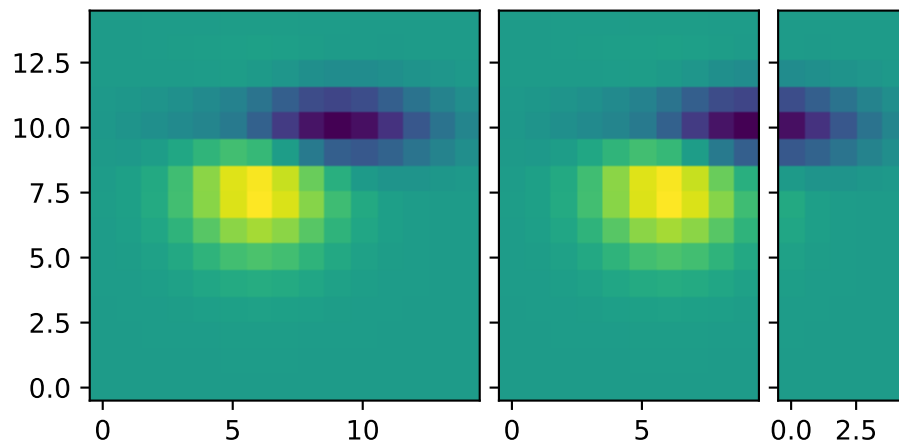

- axis are shared among axes in a same column. Similarly, yaxis are shared among axes in a same row. Therefore, changing axis properties (view limits, tick location, etc. either by plot commands or using your mouse in interactive backends) of one axes will affect all other shared axes.

When initialized, ImageGrid creates given number (*ngrids* or *ncols* * *nrows* if *ngrids* is None) of Axes instances. A sequence-like interface is provided to access the individual Axes instances (e.g., `grid[0]` is the first Axes in the grid. See below for the order of axes).

AxesGrid takes following arguments,

Name	De- fault	Description
<code>fig</code>		
<code>rect</code>		
<code>nrows_ncols</code>		number of rows and cols. e.g., (2,2)
<code>ngrids</code>	None	number of grids. <code>nrows</code> x <code>ncols</code> if None
<code>direction</code>	“row”	increasing direction of axes number. [row column]
<code>axes_pad</code>	0.02	pad between axes in inches
<code>add_all</code>	True	Add axes to figures if True
<code>share_all</code>	False	xaxis & yaxis of all axes are shared if True
<code>aspect</code>	True	aspect of axes
<code>label_mode</code>	“L”	location of tick labels that will be displayed. “1” (only the lower left axes), “L” (left most and bottom most axes), or “all”.
<code>cbar_mode</code>	None	[None single each]
<code>cbar_location</code>	“right”	[right top]
<code>cbar_pad</code>	None	pad between image axes and colorbar axes
<code>cbar_size</code>	“5%”	size of the colorbar
<code>axes_class</code>	None	

rect specifies the location of the grid. You can either specify coordinates of the rectangle to be used (e.g., (0.1, 0.1, 0.8, 0.8) as in the Axes), or the subplot-like position (e.g., "121").

direction means the increasing direction of the axes number.

aspect By default (False), widths and heights of axes in the grid are scaled independently. If True, they are scaled according to their data limits (similar to aspect parameter in mpl).

share_all if True, xaxis and yaxis of all axes are shared.

direction direction of increasing axes number. For "row",

grid[0]	grid[1]
grid[2]	grid[3]

For "column",

grid[0]	grid[2]
grid[1]	grid[3]

You can also create a colorbar (or colorbars). You can have colorbar for each axes (cbar_mode="each"), or you can have a single colorbar for the grid (cbar_mode="single"). The colorbar can be placed on your right, or top. The axes for each colorbar is stored as a *cbar_axes* attribute.

The examples below show what you can do with AxesGrid.

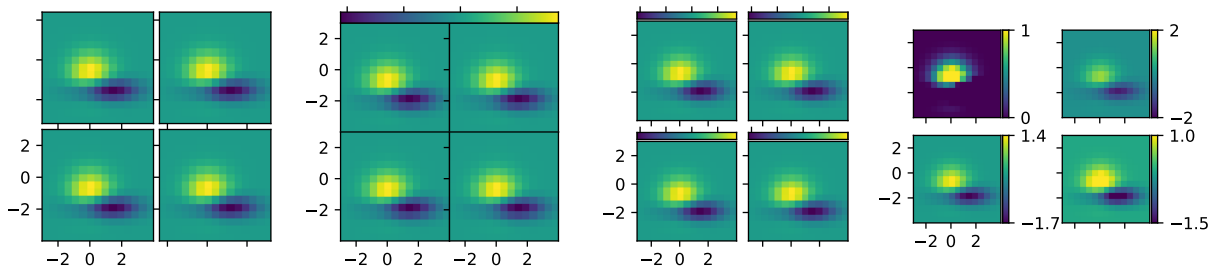

66.2.2 AxesDivider

Behind the scene, the ImageGrid class and the RGBAxes class utilize the AxesDivider class, whose role is to calculate the location of the axes at drawing time. While a more about the AxesDivider is (will be) explained in (yet to be written) AxesDividerGuide, direct use of the AxesDivider class will not be necessary for most users. The axes_divider module provides a helper function `make_axes_locatable`, which can be useful. It takes a existing axes instance and create a divider for it.

```
ax = subplot(1,1,1)
divider = make_axes_locatable(ax)
```

`make_axes_locatable` returns an instance of the AxesLocator class, derived from the Locator. It provides `append_axes` method that creates a new axes on the given side of ("top", "right", "bottom" and "left") of the original axes.

66.2.3 colorbar whose height (or width) in sync with the master axes

```
import matplotlib.pyplot as plt
from mpl_toolkits.axes_grid1 import make_axes_locatable
import numpy as np

ax = plt.subplot(111)
im = ax.imshow(np.arange(100).reshape((10,10)))

# create an axes on the right side of ax. The width of cax will be 5%
# of ax and the padding between cax and ax will be fixed at 0.05 inch.
divider = make_axes_locatable(ax)
cax = divider.append_axes("right", size="5%", pad=0.05)

plt.colorbar(im, cax=cax)
```

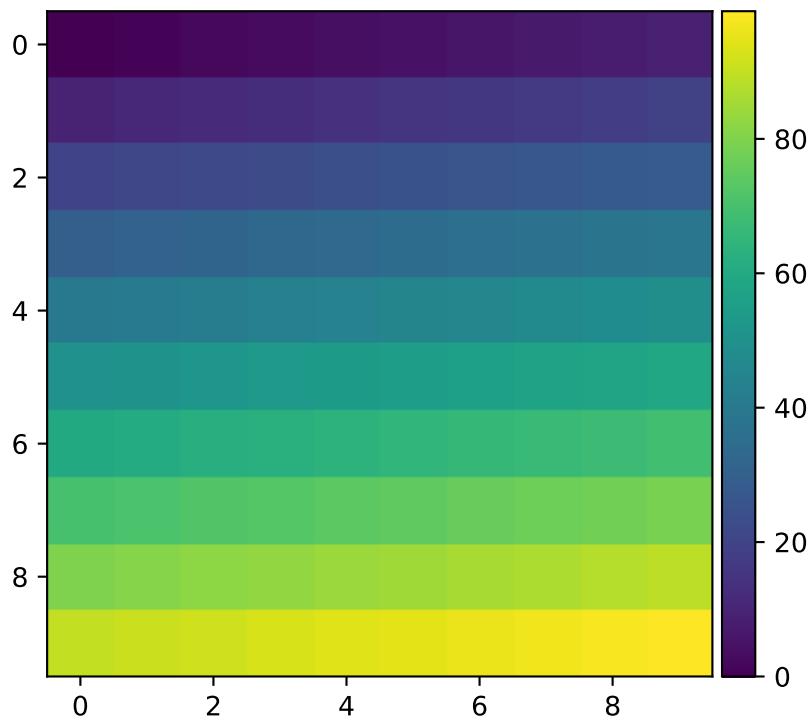

scatter_hist.py with AxesDivider

The “scatter_hist.py” example in mpl can be rewritten using *make_axes_locatable*.

```
axScatter = subplot(111)
axScatter.scatter(x, y)
axScatter.set_aspect(1.)
```

```
# create new axes on the right and on the top of the current axes.
divider = make_axes_locatable(axScatter)
axHistx = divider.append_axes("top", size=1.2, pad=0.1, sharex=axScatter)
axHisty = divider.append_axes("right", size=1.2, pad=0.1, sharey=axScatter)

# the scatter plot:
# histograms
bins = np.arange(-lim, lim + binwidth, binwidth)
axHistx.hist(x, bins=bins)
axHisty.hist(y, bins=bins, orientation='horizontal')
```

See the full source code below.

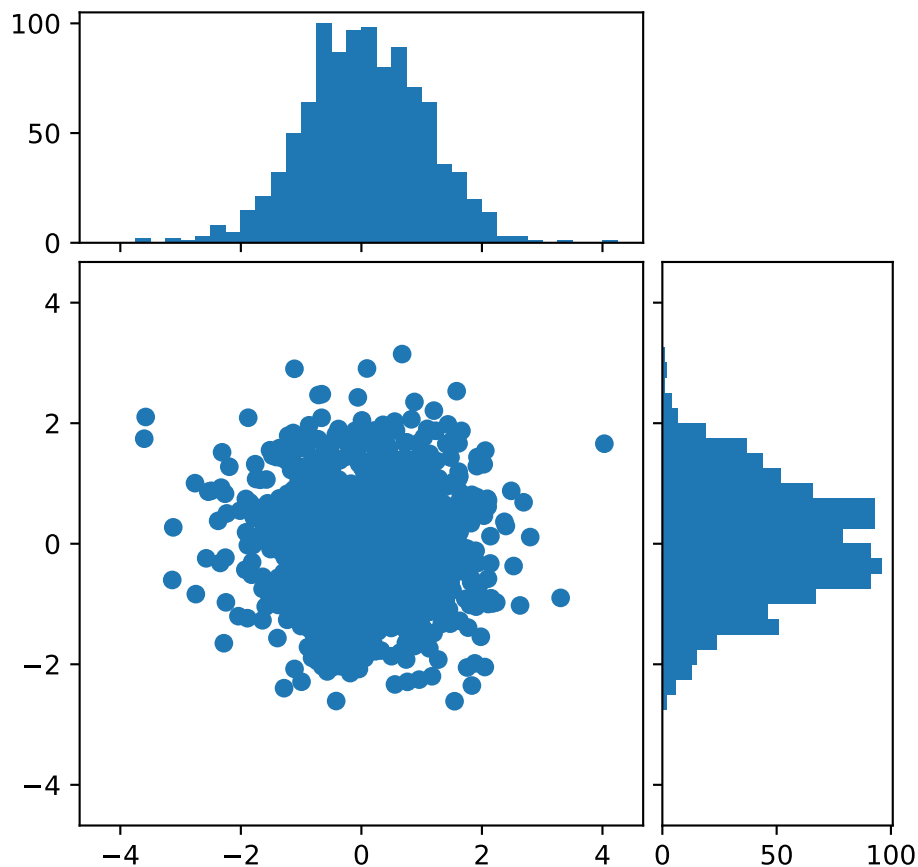

The scatter_hist using the AxesDivider has some advantage over the original scatter_hist.py in mpl. For example, you can set the aspect ratio of the scatter plot, even with the x-axis or y-axis is shared accordingly.

66.2.4 ParasiteAxes

The ParasiteAxes is an axes whose location is identical to its host axes. The location is adjusted in the drawing time, thus it works even if the host change its location (e.g., images).

In most cases, you first create a host axes, which provides a few method that can be used to create parasite axes. They are *twinx*, *twiny* (which are similar to *twinx* and *twiny* in the matplotlib) and *twin*. *twin* takes an arbitrary transformation that maps between the data coordinates of the host axes and the parasite axes. *draw* method of the parasite axes are never called. Instead, host axes collects artists in parasite axes and draw them as if they belong to the host axes, i.e., artists in parasite axes are merged to those of the host axes and then drawn according to their zorder. The host and parasite axes modifies some of the axes behavior. For example, color cycle for plot lines are shared between host and parasites. Also, the legend command in host, creates a legend that includes lines in the parasite axes. To create a host axes, you may use *host_subplot* or *host_axes* command.

Example 1. *twinx*

```
from mpl_toolkits.axes_grid1 import host_subplot
import matplotlib.pyplot as plt

host = host_subplot(111)

par = host.twinx()

host.set_xlabel("Distance")
host.set_ylabel("Density")
par.set_ylabel("Temperature")

p1, = host.plot([0, 1, 2], [0, 1, 2], label="Density")
p2, = par.plot([0, 1, 2], [0, 3, 2], label="Temperature")

leg = plt.legend()

host.yaxis.get_label().set_color(p1.get_color())
leg.texts[0].set_color(p1.get_color())

par.yaxis.get_label().set_color(p2.get_color())
leg.texts[1].set_color(p2.get_color())

plt.show()
```

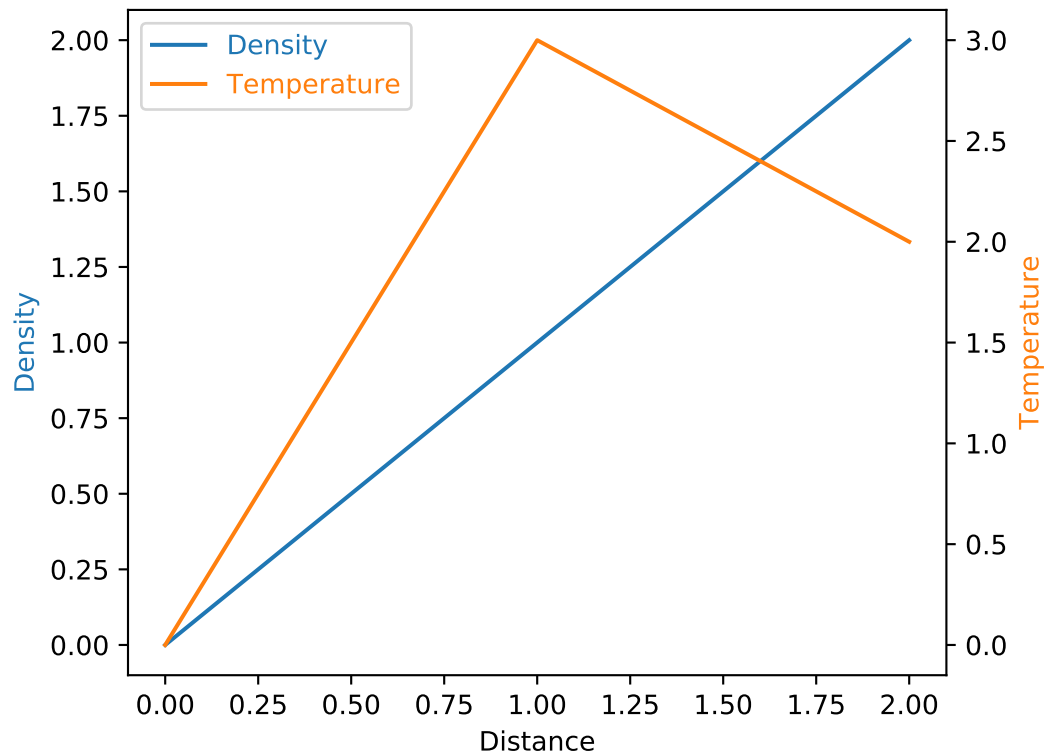

Example 2. twin

`twin` without a transform argument treat the parasite axes to have a same data transform as the host. This can be useful when you want the top(or right)-axis to have different tick-locations, tick-labels, or tick-formatter for bottom(or left)-axis.

```
ax2 = ax.twin() # now, ax2 is responsible for "top" axis and "right" axis
ax2.set_xticks([0., .5*np.pi, np.pi, 1.5*np.pi, 2*np.pi])
ax2.set_xticklabels(["0", r"$\frac{1}{2}\pi$",
                    r"$\pi$", r"$\frac{3}{2}\pi$", r"$2\pi$"])
```

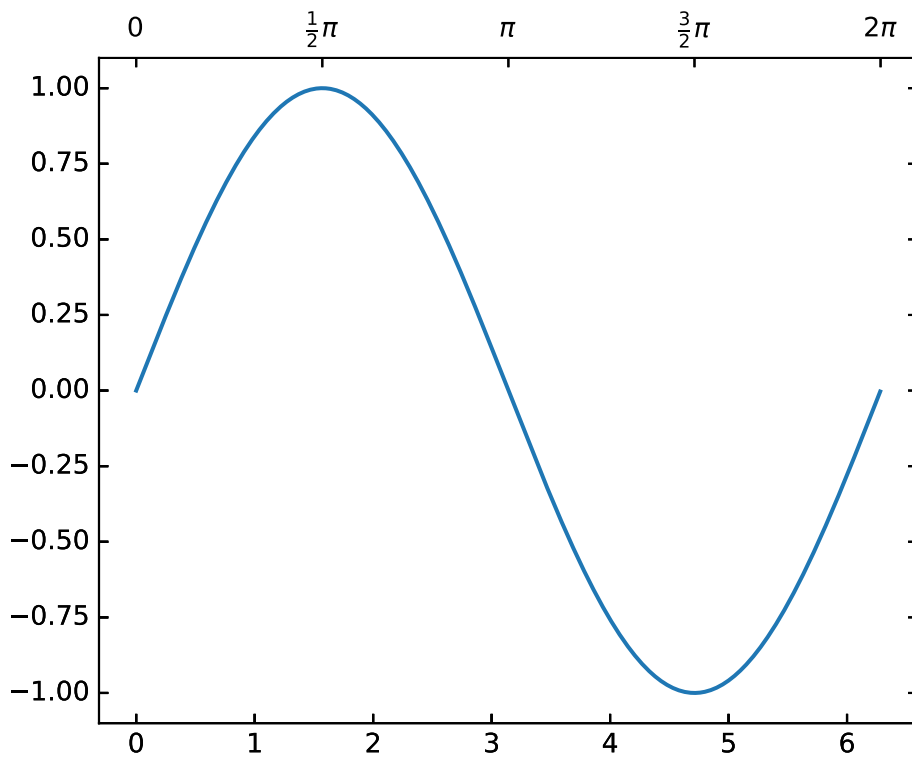

A more sophisticated example using twin. Note that if you change the x-limit in the host axes, the x-limit of the parasite axes will change accordingly.

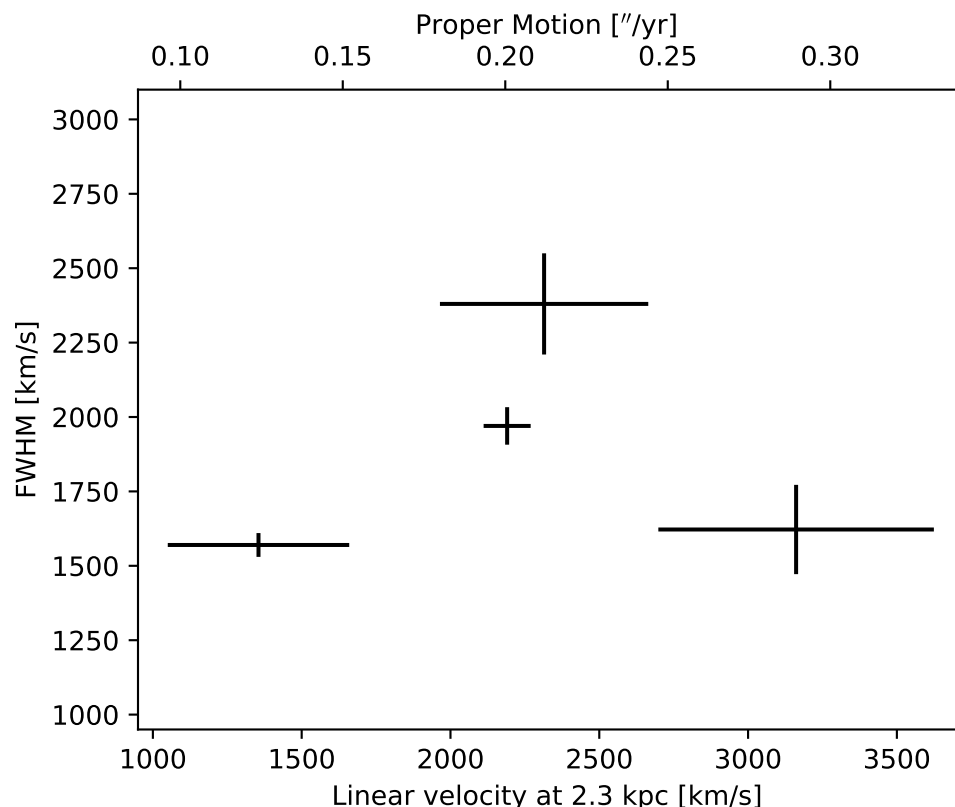

66.2.5 AnchoredArtists

It's a collection of artists whose location is anchored to the (axes) bbox, like the legend. It is derived from *OffsetBox* in mpl, and artist need to be drawn in the canvas coordinate. But, there is a limited support for an arbitrary transform. For example, the ellipse in the example below will have width and height in the data coordinate.

```
import matplotlib.pyplot as plt

def draw_text(ax):
    from matplotlib.offsetbox import AnchoredText
    at = AnchoredText("Figure 1a",
                      loc=2, prop=dict(size=8), frameon=True,
                      )
    at.patch.set_boxstyle("round,pad=0.,rounding_size=0.2")
    ax.add_artist(at)

    at2 = AnchoredText("Figure 1(b)",
                       loc=3, prop=dict(size=8), frameon=True,
                       bbox_to_anchor=(0., 1.),
                       bbox_transform=ax.transAxes
                       )
    at2.patch.set_boxstyle("round,pad=0.,rounding_size=0.2")
```

```

ax.add_artist(at2)

def draw_circle(ax): # circle in the canvas coordinate
    from mpl_toolkits.axes_grid1.anchored_artists import AnchoredDrawingArea
    from matplotlib.patches import Circle
    ada = AnchoredDrawingArea(20, 20, 0, 0,
                              loc=1, pad=0., frameon=False)
    p = Circle((10, 10), 10)
    ada.da.add_artist(p)
    ax.add_artist(ada)

def draw_ellipse(ax):
    from mpl_toolkits.axes_grid1.anchored_artists import AnchoredEllipse
    # draw an ellipse of width=0.1, height=0.15 in the data coordinate
    ae = AnchoredEllipse(ax.transData, width=0.1, height=0.15, angle=0.,
                        loc=3, pad=0.5, borderpad=0.4, frameon=True)

    ax.add_artist(ae)

def draw_sizebar(ax):
    from mpl_toolkits.axes_grid1.anchored_artists import AnchoredSizeBar
    # draw a horizontal bar with length of 0.1 in Data coordinate
    # (ax.transData) with a label underneath.
    asb = AnchoredSizeBar(ax.transData,
                          0.1,
                          r"1${\prime}$",
                          loc=8,
                          pad=0.1, borderpad=0.5, sep=5,
                          frameon=False)

    ax.add_artist(asb)

if 1:
    ax = plt.gca()
    ax.set_aspect(1.)

    draw_text(ax)
    draw_circle(ax)
    draw_ellipse(ax)
    draw_sizebar(ax)

plt.show()

```

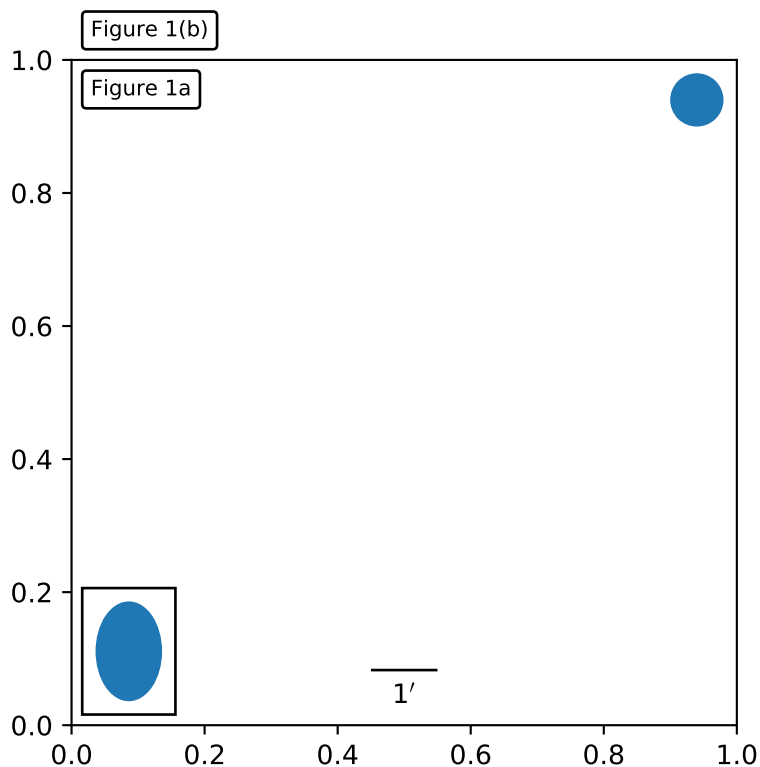

66.2.6 InsetLocator

`mpl_toolkits.axes_grid.inset_locator` provides helper classes and functions to place your (inset) axes at the anchored position of the parent axes, similarly to `AnchoredArtist`.

Using `mpl_toolkits.axes_grid.inset_locator.inset_axes()`, you can have inset axes whose size is either fixed, or a fixed proportion of the parent axes. For example,:

```
inset_axes = inset_axes(parent_axes,
                        width="30%", # width = 30% of parent_bbox
                        height=1., # height : 1 inch
                        loc=3)
```

creates an inset axes whose width is 30% of the parent axes and whose height is fixed at 1 inch.

You may create your inset whose size is determined so that the data scale of the inset axes to be that of the parent axes multiplied by some factor. For example,

```
inset_axes = zoomed_inset_axes(ax,
                               0.5, # zoom = 0.5
                               loc=1)
```

creates an inset axes whose data scale is half of the parent axes. Here is complete examples.

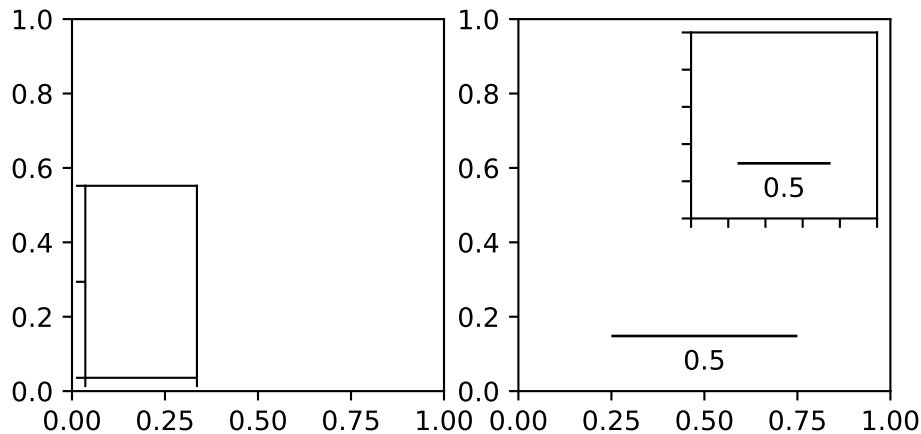

For example, `zoomed_inset_axes()` can be used when you want the inset represents the zoom-up of the small portion in the parent axes. And `mpl_toolkits/axes_grid/inset_locator` provides a helper function `mark_inset()` to mark the location of the area represented by the inset axes.

```
import matplotlib.pyplot as plt

from mpl_toolkits.axes_grid1.inset_locator import zoomed_inset_axes
from mpl_toolkits.axes_grid1.inset_locator import mark_inset

import numpy as np

def get_demo_image():
    from matplotlib.cbook import get_sample_data
    import numpy as np
    f = get_sample_data("axes_grid/bivariate_normal.npy", asfileobj=False)
    z = np.load(f)
    # z is a numpy array of 15x15
    return z, (-3, 4, -4, 3)

fig, ax = plt.subplots(figsize=[5, 4])

# prepare the demo image
Z, extent = get_demo_image()
Z2 = np.zeros([150, 150], dtype="d")
ny, nx = Z.shape
Z2[30:30 + ny, 30:30 + nx] = Z

# extent = [-3, 4, -4, 3]
ax.imshow(Z2, extent=extent, interpolation="nearest",
          origin="lower")

axins = zoomed_inset_axes(ax, 6, loc=1) # zoom = 6
axins.imshow(Z2, extent=extent, interpolation="nearest",
             origin="lower")
```

```

# sub region of the original image
x1, x2, y1, y2 = -1.5, -0.9, -2.5, -1.9
axins.set_xlim(x1, x2)
axins.set_ylim(y1, y2)
# fix the number of ticks on the inset axes
axins.yaxis.get_major_locator().set_params(nbins=7)
axins.xaxis.get_major_locator().set_params(nbins=7)

plt.xticks(visible=False)
plt.yticks(visible=False)

# draw a bbox of the region of the inset axes in the parent axes and
# connecting lines between the bbox and the inset axes area
mark_inset(ax, axins, loc1=2, loc2=4, fc="none", ec="0.5")

plt.draw()
plt.show()

```

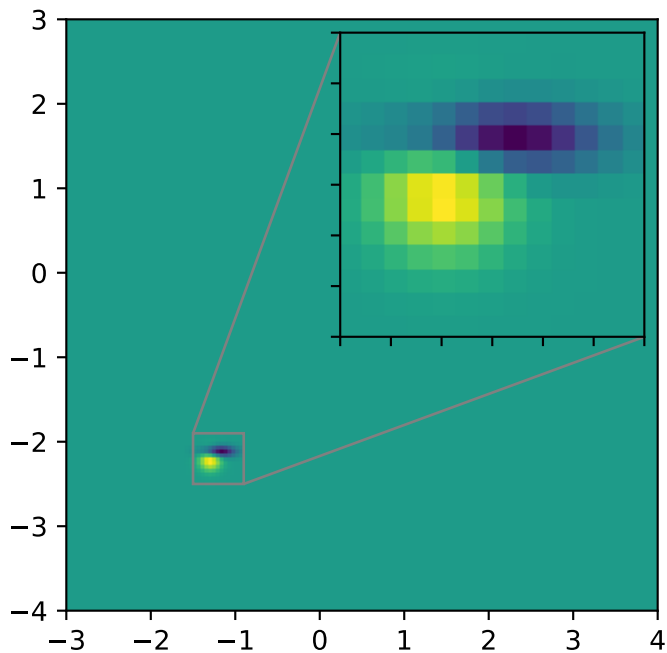

RGB Axes

RGBAxes is a helper class to conveniently show RGB composite images. Like ImageGrid, the location of axes are adjusted so that the area occupied by them fits in a given rectangle. Also, the xaxis and yaxis of each axes are shared.

```

from mpl_toolkits.axes_grid1.axes_rgb import RGBAxes

fig = plt.figure(1)
ax = RGBAxes(fig, [0.1, 0.1, 0.8, 0.8])

r, g, b = get_rgb() # r,g,b are 2-d images
ax.imshow_rgb(r, g, b,
              origin="lower", interpolation="nearest")

```

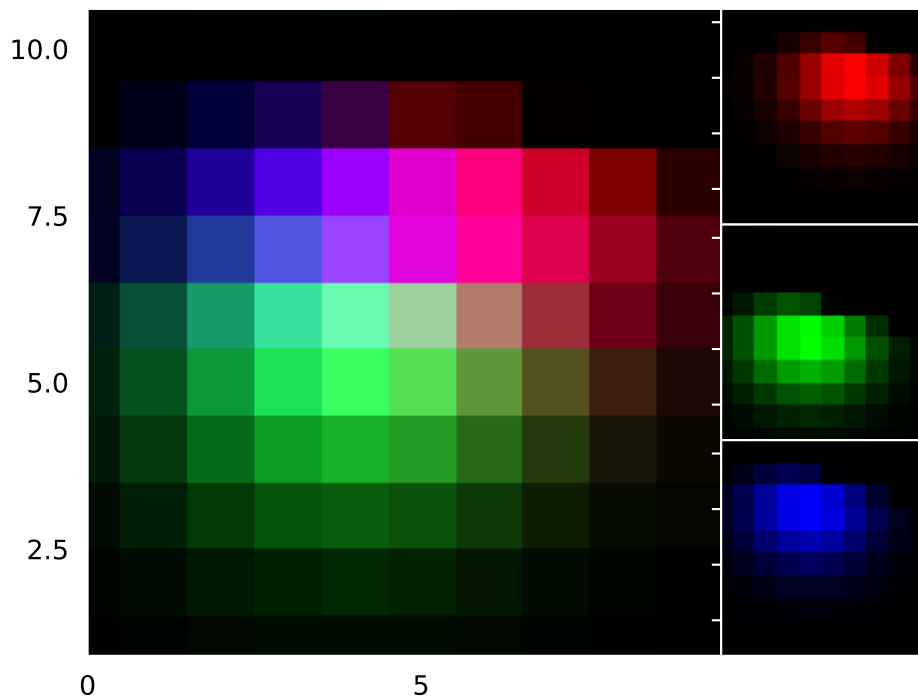

66.3 AXISARTIST

66.3.1 AxisArtist

AxisArtist module provides a custom (and very experimental) Axes class, where each axis (left, right, top and bottom) have a separate artist associated which is responsible to draw axis-line, ticks, ticklabels, label. Also, you can create your own axis, which can pass through a fixed position in the axes coordinate, or a fixed position in the data coordinate (i.e., the axis floats around when viewlimit changes).

The axes class, by default, have its xaxis and yaxis invisible, and has 4 additional artists which are responsible to draw axis in “left”, “right”, “bottom” and “top”. They are accessed as `ax.axis[“left”]`, `ax.axis[“right”]`, and so on, i.e., `ax.axis` is a dictionary that contains artists (note that `ax.axis` is still a callable methods and it behaves as an original Axes.axis method in mpl).

To create an axes,

```
import mpl_toolkits.axisartist as AA
fig = plt.figure(1)
ax = AA.Axes(fig, [0.1, 0.1, 0.8, 0.8])
fig.add_axes(ax)
```

or to create a subplot

```
ax = AA.Subplot(fig, 111)
fig.add_subplot(ax)
```

For example, you can hide the right, and top axis by

```
ax.axis["right"].set_visible(False)
ax.axis["top"].set_visible(False)
```

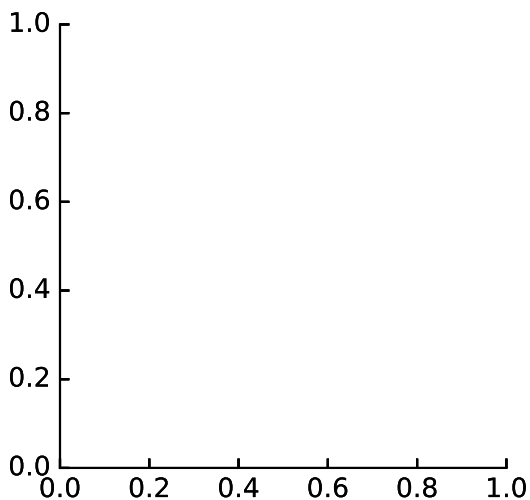

It is also possible to add an extra axis. For example, you may have an horizontal axis at $y=0$ (in data coordinate).

```
ax.axis["y=0"] = ax.new_floating_axis(nth_coord=0, value=0)
```

```
import matplotlib.pyplot as plt
import mpl_toolkits.axisartist as AA

fig = plt.figure(1)
fig.subplots_adjust(right=0.85)
ax = AA.Subplot(fig, 1, 1, 1)
fig.add_subplot(ax)

# make some axis invisible
ax.axis["bottom", "top", "right"].set_visible(False)

# make an new axis along the first axis axis (x-axis) which pass
```

```
# through y=0.
ax.axis["y=0"] = ax.new_floating_axis(nth_coord=0, value=0,
                                     axis_direction="bottom")
ax.axis["y=0"].toggle(all=True)
ax.axis["y=0"].label.set_text("y = 0")

ax.set_ylim(-2, 4)

plt.show()
```

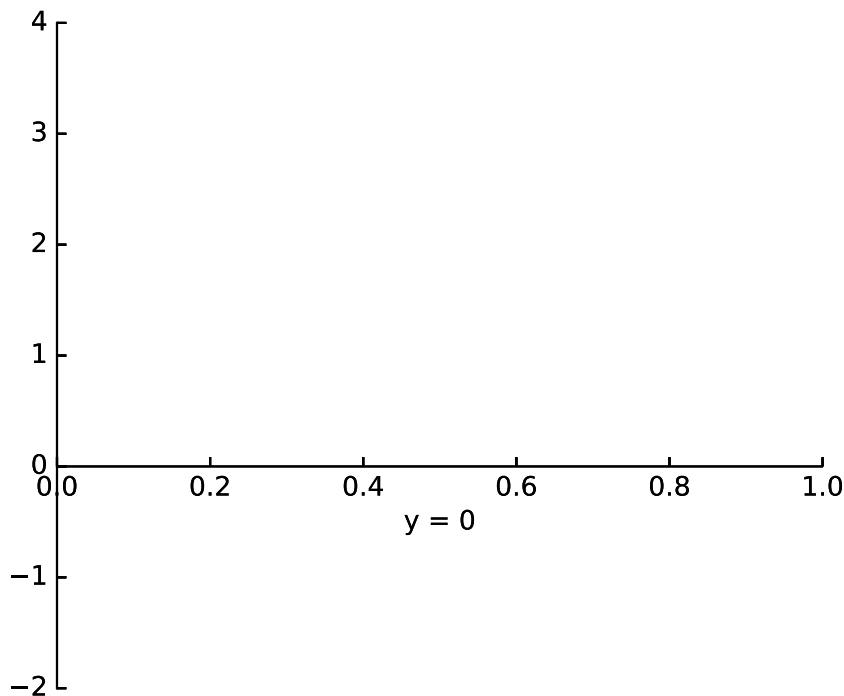

Or a fixed axis with some offset

```
# make new (right-side) yaxis, but wth some offset
ax.axis["right2"] = ax.new_fixed_axis(loc="right",
                                     offset=(20, 0))
```

AxisArtist with ParasiteAxes

Most commands in the `axes_grid1` toolkit can take a `axes_class` keyword argument, and the commands creates an axes of the given class. For example, to create a host subplot with `axisartist.Axes`,

```
import mpl_toolkits.axisartist as AA
from mpl_toolkits.axes_grid1 import host_subplot
```

```
host = host_subplot(111, axes_class=AA.Axes)
```

Here is an example that uses `parasiteAxes`.

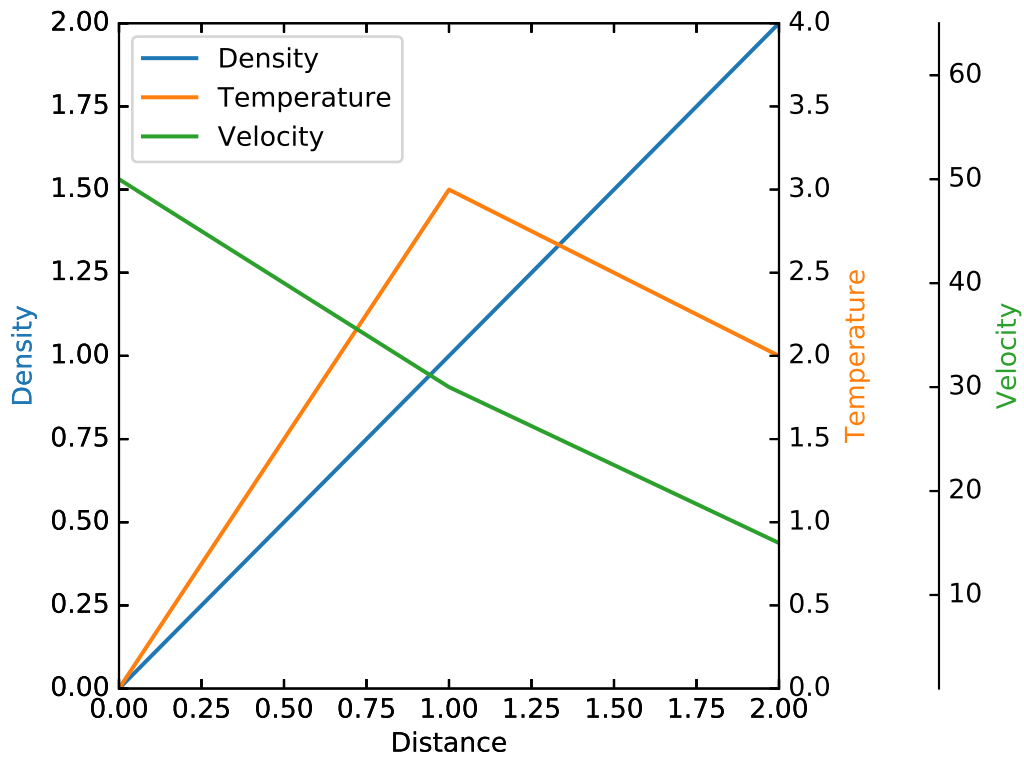

66.3.2 Curvilinear Grid

The motivation behind the `AxisArtist` module is to support curvilinear grid and ticks.

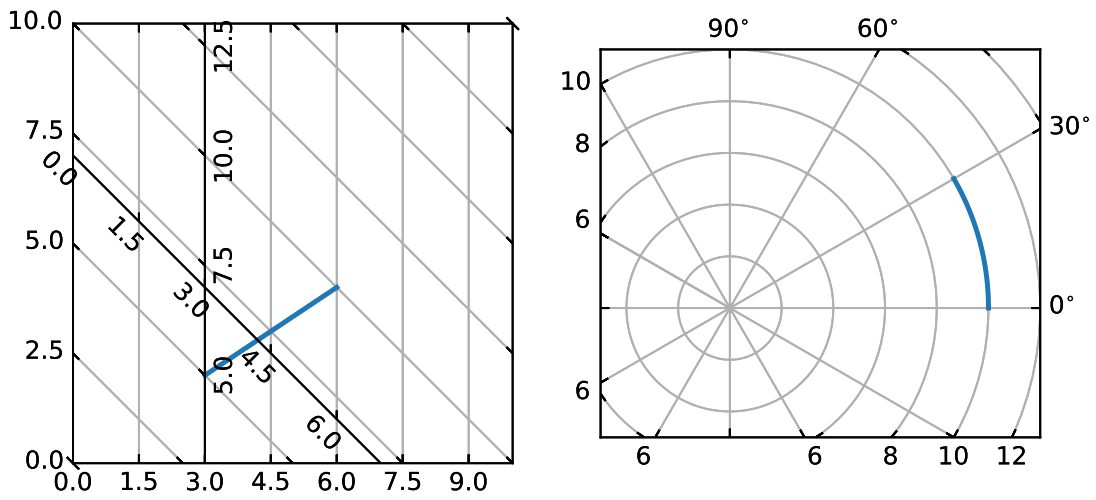

See *AXISARTIST namespace* for more details.

66.3.3 Floating Axes

This also support a Floating Axes whose outer axis are defined as floating axis.

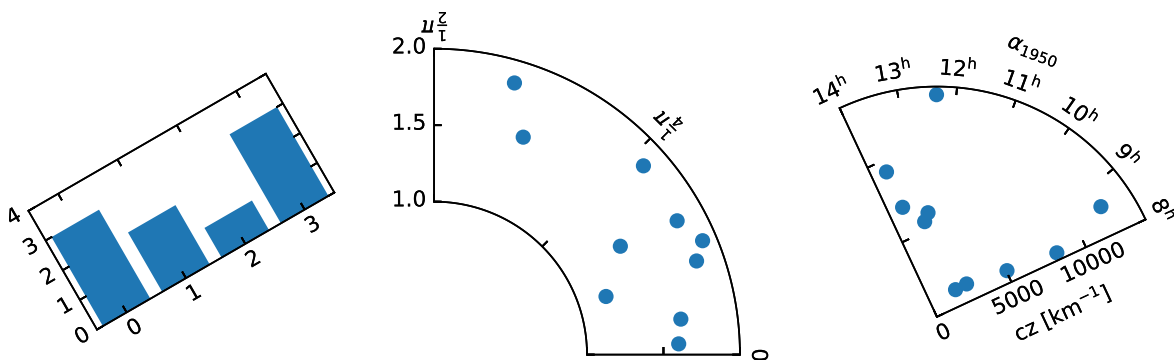

THE MATPLOTLIB AXESGRID TOOLKIT USER'S GUIDE

Release 2.0.2

Date May 10, 2017

67.1 AxesDivider

The `axes_divider` module provide helper classes to adjust the axes positions of set of images in the drawing time.

- `axes_size` provides a classes of units that the size of each axes will be determined. For example, you can specify a fixed size
- `Divider` this is the class that is used calculates the axes position. It divides the given rectangular area into several areas. You initialize the divider by setting the horizontal and vertical list of sizes that the division will be based on. You then use the `new_locator` method, whose return value is a callable object that can be used to set the `axes_locator` of the axes.

You first initialize the divider by specifying its grids, i.e., horizontal and vertical.

for example,:

```
rect = [0.2, 0.2, 0.6, 0.6]
horiz=[h0, h1, h2, h3]
vert=[v0, v1, v2]
divider = Divider(fig, rect, horiz, vert)
```

where, `rect` is a bounds of the box that will be divided and `h0,..h3`, `v0,..v2` need to be an instance of classes in the `axes_size`. They have `get_size` method that returns a tuple of two floats. The first float is the relative size, and the second float is the absolute size. Consider a following grid.

v0			
v1			
h0,v2	h1	h2	h3

- `v0 => 0, 2`
- `v1 => 2, 0`
- `v2 => 3, 0`

The height of the bottom row is always 2 (axes_divider internally assumes that the unit is inch). The first and the second rows with height ratio of 2:3. For example, if the total height of the grid 6, then the first and second row will each occupy $2/(2+3)$ and $3/(2+3)$ of (6-1) inches. The widths of columns (horiz) will be similarly determined. When aspect ratio is set, the total height (or width) will be adjusted accordingly.

The `mpl_toolkits.axes_grid.axes_size` contains several classes that can be used to set the horizontal and vertical configurations. For example, for the vertical configuration above will be:

```
from mpl_toolkits.axes_grid.axes_size import Fixed, Scaled
vert = [Fixed(2), Scaled(2), Scaled(3)]
```

After you set up the divider object, then you create a locator instance which will be given to the axes.:

```
locator = divider.new_locator(nx=0, ny=1)
ax.set_axes_locator(locator)
```

The return value of the `new_locator` method is a instance of the `AxesLocator` class. It is a callable object that returns the location and size of the cell at the first column and the second row. You may create a locator that spans over multiple cells.:

```
locator = divider.new_locator(nx=0, nx=2, ny=1)
```

The above locator, when called, will return the position and size of the cells spanning the first and second column and the first row. You may consider it as [0:2, 1].

See the example,

```
import mpl_toolkits.axes_grid.axes_size as Size
from mpl_toolkits.axes_grid import Divider
import matplotlib.pyplot as plt

fig1 = plt.figure(1, (5.5, 4.))

# the rect parameter will be ignore as we will set axes_locator
rect = (0.1, 0.1, 0.8, 0.8)
ax = [fig1.add_axes(rect, label="%d"%i) for i in range(4)]

horiz = [Size.Scaled(1.5), Size.Fixed(.5), Size.Scaled(1.),
         Size.Scaled(.5)]

vert = [Size.Scaled(1.), Size.Fixed(.5), Size.Scaled(1.5)]

# divide the axes rectangle into grid whose size is specified by horiz * vert
divider = Divider(fig1, rect, horiz, vert, aspect=False)

ax[0].set_axes_locator(divider.new_locator(nx=0, ny=0))
ax[1].set_axes_locator(divider.new_locator(nx=0, ny=2))
ax[2].set_axes_locator(divider.new_locator(nx=2, ny=2))
ax[3].set_axes_locator(divider.new_locator(nx=2, nx1=4, ny=0))

for ax1 in ax:
    plt.setp(ax1.get_xticklabels()+ax1.get_yticklabels(),
             visible=False)
```

```
plt.draw()
plt.show()
```

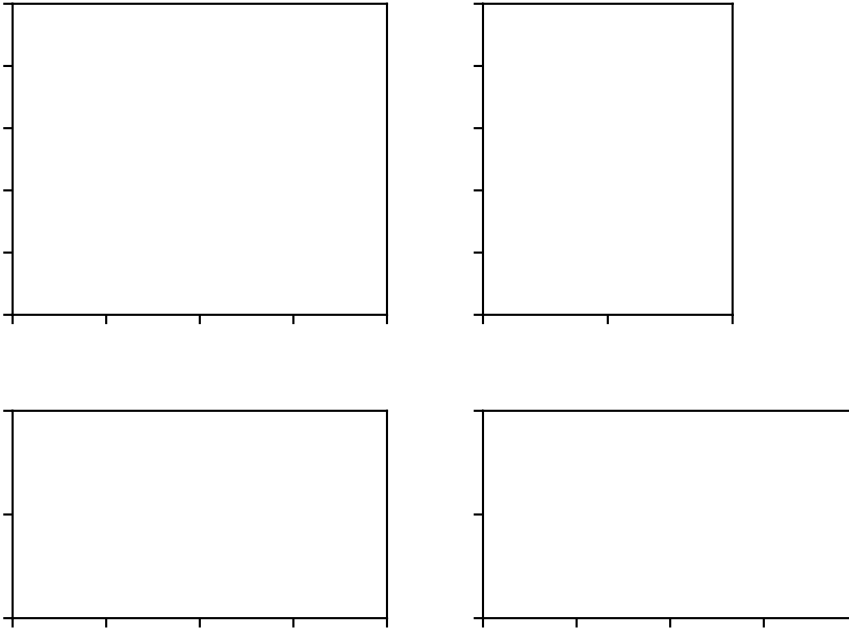

You can adjust the size of the each axes according to their x or y data limits (AxesX and AxesY), similar to the axes aspect parameter.

```
import mpl_toolkits.axes_grid.axes_size as Size
from mpl_toolkits.axes_grid import Divider
import matplotlib.pyplot as plt

fig1 = plt.figure(1, (5.5, 4))

# the rect parameter will be ignore as we will set axes_locator
rect = (0.1, 0.1, 0.8, 0.8)
ax = [fig1.add_axes(rect, label="%d"%i) for i in range(4)]

horiz = [Size.AxesX(ax[0]), Size.Fixed(.5), Size.AxesX(ax[1])]
vert = [Size.AxesY(ax[0]), Size.Fixed(.5), Size.AxesY(ax[2])]

# divide the axes rectangle into grid whose size is specified by horiz * vert
divider = Divider(fig1, rect, horiz, vert, aspect=False)

ax[0].set_axes_locator(divider.new_locator(nx=0, ny=0))
ax[1].set_axes_locator(divider.new_locator(nx=2, ny=0))
```

```
ax[2].set_axes_locator(divider.new_locator(nx=0, ny=2))
ax[3].set_axes_locator(divider.new_locator(nx=2, ny=2))

ax[0].set_xlim(0, 2)
ax[1].set_xlim(0, 1)

ax[0].set_ylim(0, 1)
ax[2].set_ylim(0, 2)

divider.set_aspect(1.)

for ax1 in ax:
    plt.setp(ax1.get_xticklabels()+ax1.get_yticklabels(),
             visible=False)

plt.draw()
plt.show()
```

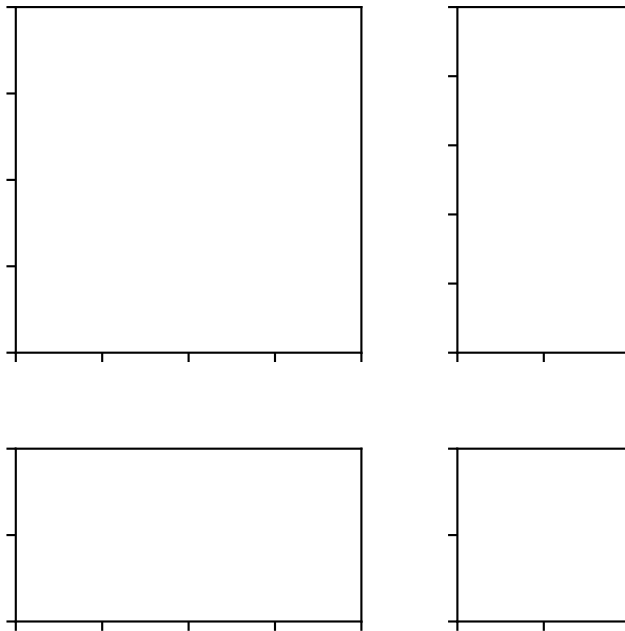

67.2 AXISARTIST namespace

The AxisArtist namespace includes a derived Axes implementation. The biggest difference is that the artists responsible to draw axis line, ticks, ticklabel and axis labels are separated out from the mpl's Axis class, which are much more than artists in the original mpl. This change was strongly motivated to support curvilinear grid. Here are a few things that `mpl_toolkits.axisartist.Axes` is different from original Axes from mpl.

- Axis elements (axis line(spine), ticks, ticklabel and axis labels) are drawn by a `AxisArtist` instance. Unlike `Axis`, left, right, top and bottom axis are drawn by separate artists. And each of them may have different tick location and different tick labels.
- gridlines are drawn by a `Gridlines` instance. The change was motivated that in curvilinear coordinate, a gridline may not cross axis-lines (i.e., no associated ticks). In the original `Axes` class, gridlines are tied to ticks.
- ticklines can be rotated if necessary (i.e, along the gridlines)

In summary, all these changes was to support

- a curvilinear grid.
- a floating axis

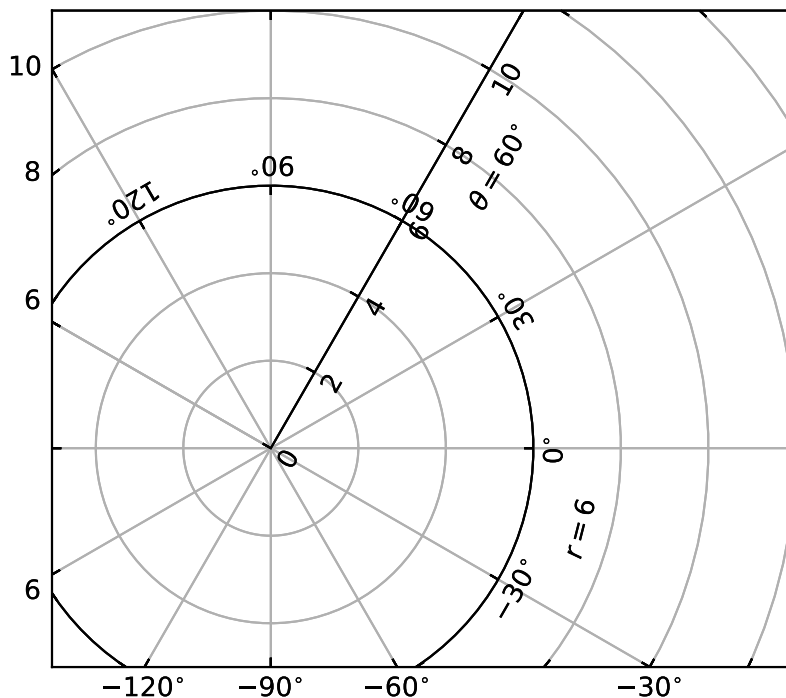

`mpl_toolkits.axisartist.Axes` class defines a `axis` attribute, which is a dictionary of `AxisArtist` instances. By default, the dictionary has 4 `AxisArtist` instances, responsible for drawing of left, right, bottom and top axis.

`axis` and `yaxis` attributes are still available, however they are set to not visible. As separate artists are used for rendering axis, some axis-related method in `mpl` may have no effect. In addition to `AxisArtist` instances, the `mpl_toolkits.axisartist.Axes` will have `gridlines` attribute (`Gridlines`), which obviously draws grid lines.

In both `AxisArtist` and `Gridlines`, the calculation of tick and grid location is delegated to an instance of

GridHelper class. `mpl_toolkits.axisartist.Axes` class uses `GridHelperRectlinear` as a grid helper. The `GridHelperRectlinear` class is a wrapper around the *xaxis* and *yaxis* of mpl's original `Axes`, and it was meant to work as the way how mpl's original axes works. For example, tick location changes using `set_ticks` method and etc. should work as expected. But change in artist properties (e.g., color) will not work in general, although some effort has been made so that some often-change attributes (color, etc.) are respected.

67.2.1 AxisArtist

`AxisArtist` can be considered as a container artist with following attributes which will draw ticks, labels, etc.

- `line`
- `major_ticks`, `major_ticklabels`
- `minor_ticks`, `minor_ticklabels`
- `offsetText`
- `label`

line

Derived from `Line2d` class. Responsible for drawing a spinal(?) line.

major_ticks, minor_ticks

Derived from `Line2d` class. Note that ticks are markers.

major_ticklabels, minor_ticklabels

Derived from `Text`. Note that it is not a list of `Text` artist, but a single artist (similar to a collection).

axislabel

Derived from `Text`.

Default AxisArtists

By default, following for axis artists are defined.:

```
ax.axis["left"], ax.axis["bottom"], ax.axis["right"], ax.axis["top"]
```

The ticklabels and axislabel of the top and the right axis are set to not visible.

For example, if you want to change the color attributes of `major_ticklabels` of the bottom x-axis

```
ax.axis["bottom"].major_ticklabels.set_color("b")
```

Similarly, to make ticklabels invisible

```
ax.axis["bottom"].major_ticklabels.set_visible(False)
```

AxisArtist provides a helper method to control the visibility of ticks, ticklabels, and label. To make ticklabel invisible,

```
ax.axis["bottom"].toggle(ticklabels=False)
```

To make all of ticks, ticklabels, and (axis) label invisible

```
ax.axis["bottom"].toggle(all=False)
```

To turn all off but ticks on

```
ax.axis["bottom"].toggle(all=False, ticks=True)
```

To turn all on but (axis) label off

```
ax.axis["bottom"].toggle(all=True, label=False)
```

ax.axis's `__getitem__` method can take multiple axis names. For example, to turn ticklabels of “top” and “right” axis on,

```
ax.axis["top", "right"].toggle(ticklabels=True)
```

Note that `ax.axis["top", "right"]` returns a simple proxy object that translate above code to something like below.

```
for n in ["top", "right"]:
    ax.axis[n].toggle(ticklabels=True)
```

So, any return values in the for loop are ignored. And you should not use it anything more than a simple method.

Like the list indexing `:` means all items, i.e.,

```
ax.axis[:].major_ticks.set_color("r")
```

changes tick color in all axis.

67.2.2 HowTo

1. Changing tick locations and label.

Same as the original mpl's axes.:

```
ax.set_xticks([1,2,3])
```

2. Changing axis properties like color, etc.

Change the properties of appropriate artists. For example, to change the color of the ticklabels:

```
ax.axis["left"].major_ticklabels.set_color("r")
```

3. To change the attributes of multiple axis:

```
ax.axis["left","bottom"].major_ticklabels.set_color("r")
```

or to change the attributes of all axis:

```
ax.axis[:].major_ticklabels.set_color("r")
```

4. **To change the tick size (length), you need to use** `axis.major_ticks.set_ticksize` method. To change the direction of the ticks (ticks are in opposite direction of ticklabels by default), use `axis.major_ticks.set_tick_out` method.

To change the pad between ticks and ticklabels, use `axis.major_ticklabels.set_pad` method.

To change the pad between ticklabels and axis label, `axis.label.set_pad` method.

67.2.3 Rotation and Alignment of TickLabels

This is also quite different from the original mpl and can be confusing. When you want to rotate the ticklabels, first consider using “`set_axis_direction`” method.

```
ax1.axis["left"].major_ticklabels.set_axis_direction("top")
ax1.axis["right"].label.set_axis_direction("left")
```

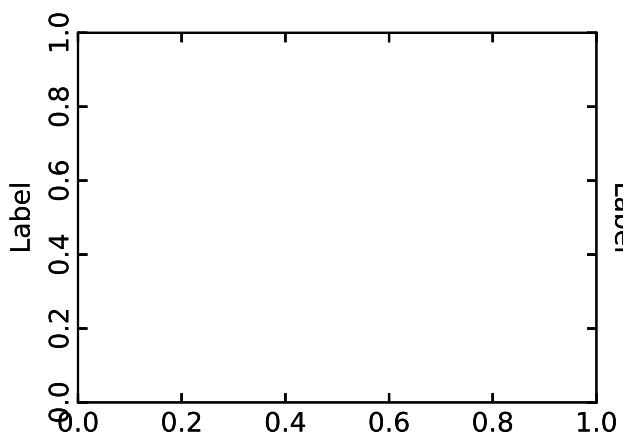

The parameter for `set_axis_direction` is one of [”left”, ”right”, ”bottom”, ”top”].

You must understand some underlying concept of directions.

1. There is a reference direction which is defined as the direction of the axis line with increasing coordinate. For example, the reference direction of the left x-axis is from bottom to top.



The direction, text angle, and alignments of the ticks, ticklabels and axis-label is determined with respect to the reference direction

2. *ticklabel_direction* is either the right-hand side (+) of the reference direction or the left-hand side (-).

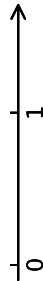

ticklabel direction=+



ticklabel direction=-

3. same for the *label_direction*

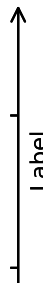

label direction=+

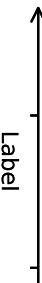

label direction=-

4. ticks are by default drawn toward the opposite direction of the ticklabels.
5. text rotation of ticklabels and label is determined in reference to the *ticklabel_direction* or *label_direction*, respectively. The rotation of ticklabels and label is anchored.

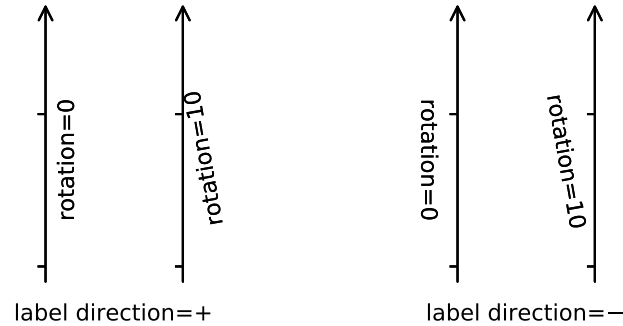

On the other hand, there is a concept of “axis_direction”. This is a default setting of above properties for each, “bottom”, “left”, “top”, and “right” axis.

?	?	left	bottom	right	top
axislabel	direction	‘-‘	‘+’	‘+’	‘-‘
axislabel	rotation	180	0	0	180
axislabel	va	center	top	center	bottom
axislabel	ha	right	center	right	center
ticklabel	direction	‘-‘	‘+’	‘+’	‘-‘
ticklabels	rotation	90	0	-90	180
ticklabel	ha	right	center	right	center
ticklabel	va	center	baseline	center	baseline

And, ‘set_axis_direction(“top”)’ means to adjust the text rotation etc, for settings suitable for “top” axis. The concept of axis direction can be more clear with curved axis.

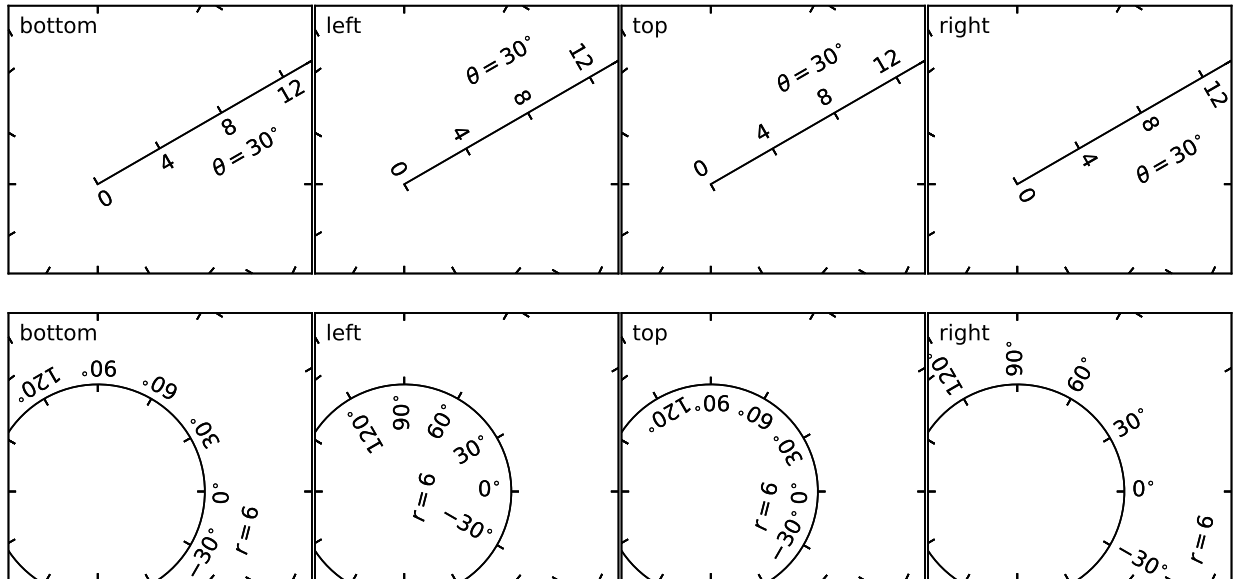

The `axis_direction` can be adjusted in the `AxisArtist` level, or in the level of its child artists, i.e., ticks, ticklabels, and axis-label.

```
ax1.axis["left"].set_axis_direction("top")
```

changes `axis_direction` of all the associated artist with the “left” axis, while

```
ax1.axis["left"].major_ticklabels.set_axis_direction("top")
```

changes the `axis_direction` of only the `major_ticklabels`. Note that `set_axis_direction` in the `AxisArtist` level changes the `ticklabel_direction` and `label_direction`, while changing the `axis_direction` of ticks, ticklabels, and axis-label does not affect them.

If you want to make ticks outward and ticklabels inside the axes, use `invert_ticklabel_direction` method.

```
ax.axis[:].invert_ticklabel_direction()
```

A related method is “`set_tick_out`”. It makes ticks outward (as a matter of fact, it makes ticks toward the opposite direction of the default direction).

```
ax.axis[:].major_ticks.set_tick_out(True)
```

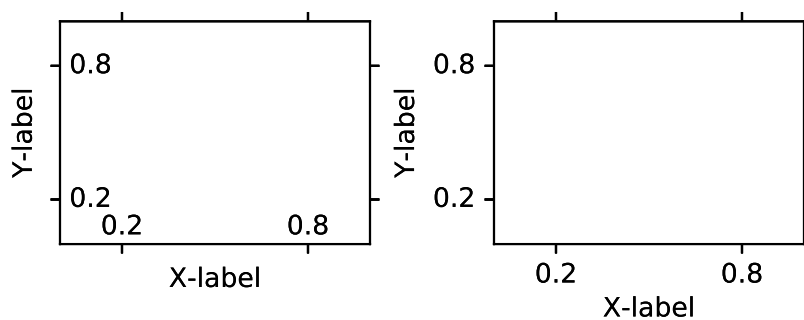

So, in summary,

- **AxisArtist's methods**
 - `set_axis_direction` : “left”, “right”, “bottom”, or “top”
 - `set_ticklabel_direction` : “+” or “-“
 - `set_axislabel_direction` : “+” or “-“
 - `invert_ticklabel_direction`
- **Ticks' methods (major_ticks and minor_ticks)**
 - `set_tick_out` : True or False
 - `set_ticksiz` : size in points
- **TickLabels' methods (major_ticklabels and minor_ticklabels)**
 - `set_axis_direction` : “left”, “right”, “bottom”, or “top”
 - `set_rotation` : angle with respect to the reference direction
 - `set_ha` and `set_va` : see below
- **AxisLabels' methods (label)**
 - `set_axis_direction` : “left”, “right”, “bottom”, or “top”
 - `set_rotation` : angle with respect to the reference direction
 - `set_ha` and `set_va`

Adjusting ticklabels alignment

Alignment of TickLabels are treated specially. See below

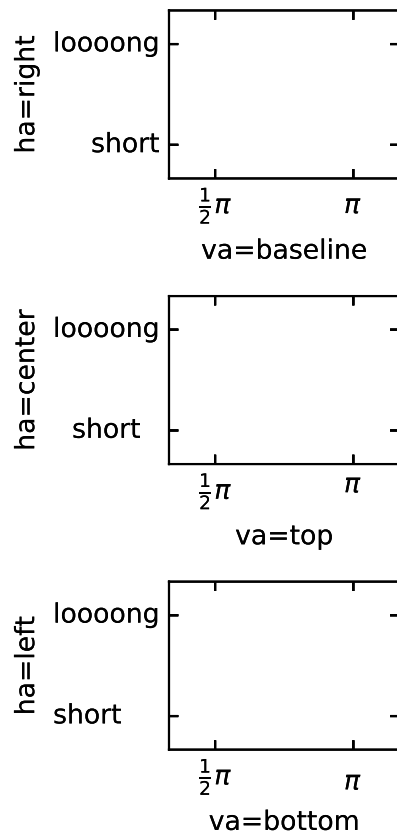

Adjusting pad

To change the pad between ticks and ticklabels

```
ax.axis["left"].major_ticklabels.set_pad(10)
```

Or ticklabels and axis-label

```
ax.axis["left"].label.set_pad(10)
```

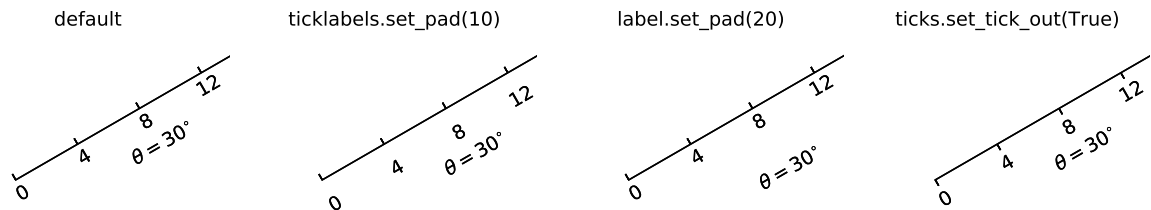

67.2.4 GridHelper

To actually define a curvilinear coordinate, you have to use your own grid helper. A generalised version of grid helper class is supplied and this class should suffice in most of cases. A user may provide two functions which defines a transformation (and its inverse pair) from the curved coordinate to (rectilinear) image coordinate. Note that while ticks and grids are drawn for curved coordinate, the data transform of the axes itself (`ax.transData`) is still rectilinear (image) coordinate.

```

from mpl_toolkits.axisartist.grid_helper_curvilinear \
    import GridHelperCurveLinear
from mpl_toolkits.axisartist import Subplot

# from curved coordinate to rectilinear coordinate.
def tr(x, y):
    x, y = np.asarray(x), np.asarray(y)
    return x, y-x

# from rectilinear coordinate to curved coordinate.
def inv_tr(x,y):
    x, y = np.asarray(x), np.asarray(y)
    return x, y+x

grid_helper = GridHelperCurveLinear((tr, inv_tr))

ax1 = Subplot(fig, 1, 1, 1, grid_helper=grid_helper)

fig.add_subplot(ax1)

```

You may use matplotlib's Transform instance instead (but a inverse transformation must be defined). Often, coordinate range in a curved coordinate system may have a limited range, or may have cycles. In those cases, a more customized version of grid helper is required.

```

import mpl_toolkits.axisartist.angle_helper as angle_helper

# PolarAxes.PolarTransform takes radian. However, we want our coordinate
# system in degree

```

```

tr = Affine2D().scale(np.pi/180., 1.) + PolarAxes.PolarTransform()

# extreme finder : find a range of coordinate.
# 20, 20 : number of sampling points along x, y direction
# The first coordinate (longitude, but theta in polar)
# has a cycle of 360 degree.
# The second coordinate (latitude, but radius in polar) has a minimum of 0
extreme_finder = angle_helper.ExtremeFinderCycle(20, 20,
                                                  lon_cycle = 360,
                                                  lat_cycle = None,
                                                  lon_minmax = None,
                                                  lat_minmax = (0, np.inf),
                                                  )

# Find a grid values appropriate for the coordinate (degree,
# minute, second). The argument is a approximate number of grids.
grid_locator1 = angle_helper.LocatorDMS(12)

# And also uses an appropriate formatter. Note that, the
# acceptable Locator and Formatter class is a bit different than
# that of mpl's, and you cannot directly use mpl's Locator and
# Formatter here (but may be possible in the future).
tick_formatter1 = angle_helper.FormatterDMS()

grid_helper = GridHelperCurveLinear(tr,
                                    extreme_finder=extreme_finder,
                                    grid_locator1=grid_locator1,
                                    tick_formatter1=tick_formatter1
                                    )

```

Again, the *transData* of the axes is still a rectilinear coordinate (image coordinate). You may manually do conversion between two coordinates, or you may use Parasite Axes for convenience.:

```

ax1 = SubplotHost(fig, 1, 2, 2, grid_helper=grid_helper)

# A parasite axes with given transform
ax2 = ParasiteAxesAuxTrans(ax1, tr, "equal")
# note that ax2.transData == tr + ax1.transData
# Anything you draw in ax2 will match the ticks and grids of ax1.
ax1.parasites.append(ax2)

```

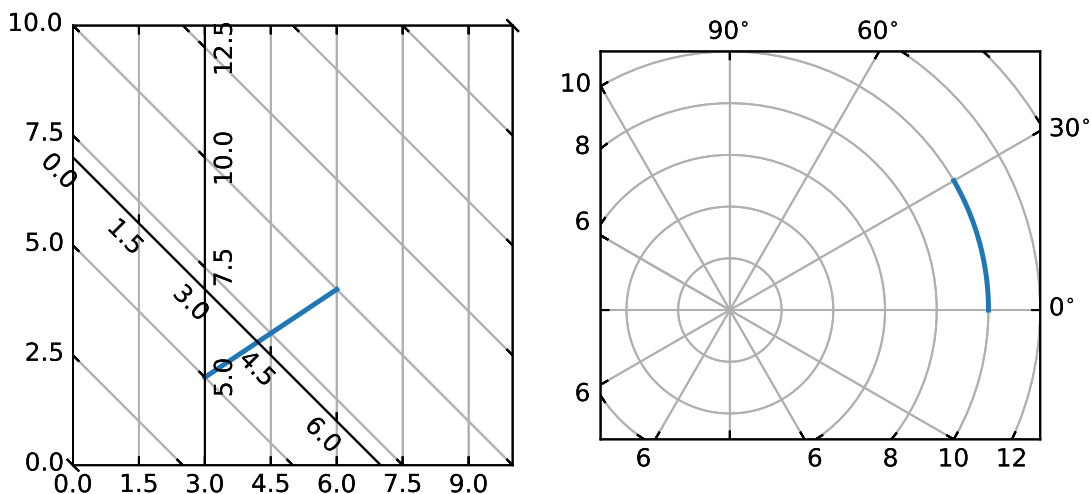

67.2.5 FloatingAxis

A floating axis is an axis one of whose data coordinate is fixed, i.e, its location is not fixed in Axes coordinate but changes as axes data limits changes. A floating axis can be created using `new_floating_axis` method. However, it is your responsibility that the resulting `AxisArtist` is properly added to the axes. A recommended way is to add it as an item of `Axes`'s `axis` attribute.:

```
# floating axis whose first (index starts from 0) coordinate
# (theta) is fixed at 60

ax1.axis["lat"] = axis = ax1.new_floating_axis(0, 60)
axis.label.set_text(r"$\theta = 60^\circ$")
axis.label.set_visible(True)
```

See the first example of this page.

67.2.6 Current Limitations and TODO's

The code need more refinement. Here is a incomplete list of issues and TODO's

- No easy way to support a user customized tick location (for curvilinear grid). A new `Locator` class needs to be created.
- `FloatingAxis` may have coordinate limits, e.g., a floating axis of $x = 0$, but y only spans from 0 to 1.
- The location of `axislabel` of `FloatingAxis` needs to be optionally given as a coordinate value. ex, a floating axis of $x=0$ with label at $y=1$

THE MATPLOTLIB AXESGRID TOOLKIT API

Release 2.0.2

Date May 10, 2017

68.1 `mpl_toolkits.axes_grid.axes_size`

`class mpl_toolkits.axes_grid.axes_size.Fixed(fixed_size)`

Simple fixed size with absolute part = *fixed_size* and relative part = 0

`class mpl_toolkits.axes_grid.axes_size.Scaled(scalable_size)`

Simple scaled(?) size with absolute part = 0 and relative part = *scalable_size*

`class mpl_toolkits.axes_grid.axes_size.AxesX(axes, aspect=1.0, ref_ax=None)`

Scaled size whose relative part corresponds to the data width of the *axes* multiplied by the *aspect*.

`class mpl_toolkits.axes_grid.axes_size.AxesY(axes, aspect=1.0, ref_ax=None)`

Scaled size whose relative part corresponds to the data height of the *axes* multiplied by the *aspect*.

`class mpl_toolkits.axes_grid.axes_size.MaxWidth(artist_list)`

Size whose absolute part is the largest width of the given *artist_list*.

`class mpl_toolkits.axes_grid.axes_size.MaxHeight(artist_list)`

Size whose absolute part is the largest height of the given *artist_list*.

`class mpl_toolkits.axes_grid.axes_size.Fraction(fraction, ref_size)`

An instance whose size is a *fraction* of the *ref_size*.

```
>>> s = Fraction(0.3, AxesX(ax))
```

`class mpl_toolkits.axes_grid.axes_size.Padded(size, pad)`

Return a instance where the absolute part of *size* is increase by the amount of *pad*.

`mpl_toolkits.axes_grid.axes_size.from_any(size, fraction_ref=None)`

Creates Fixed unit when the first argument is a float, or a Fraction unit if that is a string that ends with `%`. The second argument is only meaningful when Fraction unit is created.:

```
>>> a = Size.from_any(1.2) # => Size.Fixed(1.2)
>>> Size.from_any("50%", a) # => Size.Fraction(0.5, a)
```

68.2 `mpl_toolkits.axes_grid.axes_divider`

`class mpl_toolkits.axes_grid.axes_divider.Divider`(*fig, pos, horizontal, vertical, aspect=None, anchor='C'*)

This is the class that is used calculates the axes position. It divides the given rectangular area into several sub-rectangles. You initialize the divider by setting the horizontal and vertical lists of sizes (`mpl_toolkits.axes_grid.axes_size`) that the division will be based on. You then use the `new_locator` method to create a callable object that can be used as the `axes_locator` of the axes.

Parameters `fig` : Figure

pos : tuple of 4 floats

position of the rectangle that will be divided

horizontal : list of `axes_size`

sizes for horizontal division

vertical : list of `axes_size`

sizes for vertical division

aspect : bool

if True, the overall rectangular area is reduced so that the relative part of the horizontal and vertical scales have the same scale.

anchor : { 'C', 'SW', 'S', 'SE', 'E', 'NE', 'N', 'NW', 'W' }

placement of the reduced rectangle when `aspect` is True

add_auto_adjustable_area(*use_axes, pad=0.1, adjust_dirs=None*)

append_size(*position, size*)

get_anchor()

return the anchor

get_aspect()

return aspect

get_horizontal()

return horizontal sizes

get_horizontal_sizes(*renderer*)

get_locator()

get_position()

return the position of the rectangle.

get_position_runtime(*ax, renderer*)

get_vertical()

return vertical sizes

get_vertical_sizes(*renderer*)

get_vsize_hsize()

locate(*nx, ny, nx1=None, ny1=None, axes=None, renderer=None*)

Parameters *nx, nx1* : int

Integers specifying the column-position of the cell. When *nx1* is None, a single *nx*-th column is specified. Otherwise location of columns spanning between *nx* to *nx1* (but excluding *nx1*-th column) is specified.

ny, ny1 : int

Same as *nx* and *nx1*, but for row positions.

axes

renderer

new_locator(*nx, ny, nx1=None, ny1=None*)

Returns a new locator (*mpl_toolkits.axes_grid.axes_divider.AxesLocator*) for specified cell.

Parameters *nx, nx1* : int

Integers specifying the column-position of the cell. When *nx1* is None, a single *nx*-th column is specified. Otherwise location of columns spanning between *nx* to *nx1* (but excluding *nx1*-th column) is specified.

ny, ny1 : int

Same as *nx* and *nx1*, but for row positions.

set_anchor(*anchor*)

Parameters *anchor* : {'C', 'SW', 'S', 'SE', 'E', 'NE', 'N', 'NW', 'W'}

anchor position

value	description
'C'	Center
'SW'	bottom left
'S'	bottom
'SE'	bottom right
'E'	right
'NE'	top right
'N'	top
'NW'	top left
'W'	left

set_aspect(*aspect=False*)

Parameters aspect : bool

set_horizontal(*h*)

Parameters h : list of *axes_size*

sizes for horizontal division

set_locator(*_locator*)

set_position(*pos*)

set the position of the rectangle.

Parameters pos : tuple of 4 floats

position of the rectangle that will be divided

set_vertical(*v*)

Parameters v : list of *axes_size*

sizes for vertical division

class `mpl_toolkits.axes_grid.axes_divider.AxesLocator`(*axes_divider, nx, ny, nx1=None, ny1=None*)

A simple callable object, initialized with AxesDivider class, returns the position and size of the given cell.

Parameters axes_divider : AxesDivider

nx, nx1 : int

Integers specifying the column-position of the cell. When *nx1* is None, a single *nx*-th column is specified. Otherwise location of columns spanning between *nx* to *nx1* (but excluding *nx1*-th column) is specified.

ny, ny1 : int

Same as *nx* and *nx1*, but for row positions.

get_subplotspec()

class `mpl_toolkits.axes_grid.axes_divider.SubplotDivider`(*fig*, **args*, ***kwargs*)

The Divider class whose rectangle area is specified as a subplot geometry.

Parameters *fig* : `matplotlib.figure.Figure`

args : tuple (*numRows*, *numCols*, *plotNum*)

The array of subplots in the figure has dimensions *numRows*, *numCols*, and *plotNum* is the number of the subplot being created. *plotNum* starts at 1 in the upper left corner and increases to the right.

If *numRows* <= *numCols* <= *plotNum* < 10, *args* can be the decimal integer *numRows* * 100 + *numCols* * 10 + *plotNum*.

change_geometry(*numrows*, *numcols*, *num*)

change subplot geometry, e.g., from 1,1,1 to 2,2,3

get_geometry()

get the subplot geometry, e.g., 2,2,3

get_position()

return the bounds of the subplot box

get_subplotspec()

get the SubplotSpec instance

set_subplotspec(*subplotspec*)

set the SubplotSpec instance

update_params()

update the subplot position from `fig.subplotpars`

class `mpl_toolkits.axes_grid.axes_divider.AxesDivider`(*axes*, *xref*=None, *yref*=None)

Divider based on the pre-existing axes.

Parameters *axes* : `Axes`

xref

yref

append_axes(*position*, *size*, *pad*=None, *add_to_figure*=True, ***kwargs*)

create an axes at the given *position* with the same height (or width) of the main axes.

position ["left"|"right"|"bottom"|"top"]

size and *pad* should be `axes_grid.axes_size` compatible.

new_horizontal(*size*, *pad*=None, *pack_start*=False, ***kwargs*)

Add a new axes on the right (or left) side of the main axes.

Parameters *size* : `axes_size` or float or string

A width of the axes. If float or string is given, *from_any* function is used to create the size, with *ref_size* set to `AxesX` instance of the current axes.

pad : *axes_size* or float or string

Pad between the axes. It takes same argument as *size*.

pack_start : bool

If False, the new axes is appended at the end of the list, i.e., it became the right-most axes. If True, it is inserted at the start of the list, and becomes the left-most axes.

kwargs

All extra keywords arguments are passed to the created axes. If *axes_class* is given, the new axes will be created as an instance of the given class. Otherwise, the same class of the main axes will be used.

new_vertical (*size*, *pad=None*, *pack_start=False*, ***kwargs*)

Add a new axes on the top (or bottom) side of the main axes.

Parameters size : *axes_size* or float or string

A height of the axes. If float or string is given, *from_any* function is used to create the size, with *ref_size* set to AxesX instance of the current axes.

pad : *axes_size* or float or string

Pad between the axes. It takes same argument as *size*.

pack_start : bool

If False, the new axes is appended at the end of the list, i.e., it became the right-most axes. If True, it is inserted at the start of the list, and becomes the left-most axes.

kwargs

All extra keywords arguments are passed to the created axes. If *axes_class* is given, the new axes will be created as an instance of the given class. Otherwise, the same class of the main axes will be used.

68.3 mpl_toolkits.axes_grid.axes_grid

```
class mpl_toolkits.axes_grid.axes_grid.Grid(fig, rect, nrows_ncols, ngrids=None, direction='row', axes_pad=0.02, add_all=True,  
                                             share_all=False, share_x=True,  
                                             share_y=True, label_mode='L',  
                                             axes_class=None)
```

Build an Grid instance with a grid *nrows*ncols* Axes in Figure *fig* with *rect=[left, bottom, width, height]* (in Figure coordinates) or the subplot position code (e.g., "121").

Optional keyword arguments:

Key-word	De-fault	Description
direction	“row”	[“row” “column”]
axes_pad	0.02	float pad between axes given in inches or tuple-like of floats, (horizontal padding, vertical padding)
add_all	True	[True False]
share_all	False	[True False]
share_x	True	[True False]
share_y	True	[True False]
label_mode	“L”	[“L” “1” “all”]
axes_class	None	a type object which must be a subclass of Axes

```
class mpl_toolkits.axes_grid.axes_grid.ImageGrid(fig, rect, nrows_ncols,
n grids=None, direction='row',
axes_pad=0.02, add_all=True,
share_all=False, aspect=True, la-
bel_mode='L', cbar_mode=None,
cbar_location='right',
cbar_pad=None, cbar_size='5%',
cbar_set_cax=True,
axes_class=None)
```

Build an ImageGrid instance with a grid `nrows*ncols` [Axes](#) in [Figure](#) `fig` with `rect=[left, bottom, width, height]` (in [Figure](#) coordinates) or the subplot position code (e.g., “121”).

Optional keyword arguments:

Keyword	De-fault	Description
direction	“row”	[“row” “column”]
axes_pad	0.02	float pad between axes given in inches or tuple-like of floats, (horizontal padding, vertical padding)
add_all	True	[True False]
share_all	False	[True False]
aspect	True	[True False]
label_mode	“L”	[“L” “1” “all”]
cbar_mode	None	[“each” “single” “edge”]
cbar_location	“right”	[“left” “right” “bottom” “top”]
cbar_pad	None	
cbar_size	“5%”	
cbar_set_cax	True	[True False]
axes_class	None	a type object which must be a subclass of <code>axes_grid</code> ’s subclass of Axes

`cbar_set_cax` [if True, each axes in the grid has a `cax`] attribute that is bind to associated `cbar_axes`.

68.4 `mpl_toolkits.axes_grid.axis_artist`

`class mpl_toolkits.axes_grid.axis_artist.AxisArtist`(*axes*, *helper*, *offset=None*,
axis_direction='bottom', ***kw*)

An artist which draws axis (a line along which the n-th axes coord is constant) line, ticks, ticklabels, and axis label.

axes : axes *helper* : an AxisArtistHelper instance.

LABELPAD

ZORDER = 2.5

draw(*artist*, *renderer*, **args*, ***kwargs*)

Draw the axis lines, tick lines and labels

get_axisline_style()

return the current axisline style.

get_helper()

Return axis artist helper instance.

get_tightbbox(*renderer*)

get_transform()

invert_ticklabel_direction()

set_axis_direction(*axis_direction*)

Adjust the direction, text angle, text alignment of ticklabels, labels following the matplotlib convention for the rectangle axes.

The *axis_direction* must be one of [left, right, bottom, top].

property	left	bottom	right	top
ticklabels location	“-“	“+”	“+”	“-“
axislabel location	“-“	“+”	“+”	“-“
ticklabels angle	90	0	-90	180
ticklabel va	center	baseline	center	baseline
ticklabel ha	right	center	right	center
axislabel angle	180	0	0	180
axislabel va	center	top	center	bottom
axislabel ha	right	center	right	center

Note that the direction “+” and “-” are relative to the direction of the increasing coordinate. Also, the text angles are actually relative to (90 + angle of the direction to the ticklabel), which gives 0 for bottom axis.

set_axislabel_direction(*label_direction*)

Adjust the direction of the axislabel.

ACCEPTS: ["+" | "-"]

Note that the *label_direction* '+' and '-' are relative to the direction of the increasing coordinate.

set_axisline_style(*axisline_style*=None, ***kw*)

Set the axisline style.

axisline_style can be a string with axisline style name with optional comma-separated attributes. Alternatively, the attrs can be provided as keywords.

set_arrowstyle(">," size=1.5") set_arrowstyle(">", size=1.5)

Old attrs simply are forgotten.

Without argument (or with *arrowstyle*=None), return available styles as a list of strings.

set_label(*s*)

set_ticklabel_direction(*tick_direction*)

Adjust the direction of the ticklabel.

ACCEPTS: ["+" | "-"]

Note that the *label_direction* '+' and '-' are relative to the direction of the increasing coordinate.

toggle(*all*=None, *ticks*=None, *ticklabels*=None, *label*=None)

Toggle visibility of ticks, ticklabels, and (axis) label. To turn all off,

```
axis.toggle(all=False)
```

To turn all off but ticks on

```
axis.toggle(all=False, ticks=True)
```

To turn all on but (axis) label off

```
axis.toggle(all=True, label=False)
```

class `mpl_toolkits.axes_grid.axis_artist.Ticks`(*ticksize*, *tick_out*=False, ***kwargs*)

Ticks are derived from Line2D, and note that ticks themselves are markers. Thus, you should use `set_mec`, `set_mew`, etc.

To change the tick size (length), you need to use `set_ticksize`. To change the direction of the ticks (ticks are in opposite direction of ticklabels by default), use `set_tick_out(False)`.

get_tick_out()

Return True if the tick will be rotated by 180 degree.

get_ticksize()

Return length of the ticks in points.

set_tick_out(*b*)

set True if tick need to be rotated by 180 degree.

set_ticksize(*ticksiz*e)
 set length of the ticks in points.

class `mpl_toolkits.axes_grid.axis_artist.AxisLabel`(**kl*, ***kwarg*s)
 Axis Label. Derived from Text. The position of the text is updated in the fly, so changing text position has no effect. Otherwise, the properties can be changed as a normal Text.

To change the pad between ticklabels and axis label, use `set_pad`.

get_pad()
 return pad in points. See `set_pad` for more details.

set_axis_direction(*d*)
 Adjust the text angle and text alignment of axis label according to the matplotlib convention.

property	left	bottom	right	top
axislabel angle	180	0	0	180
axislabel va	center	top	center	bottom
axislabel ha	right	center	right	center

Note that the text angles are actually relative to (90 + angle of the direction to the ticklabel), which gives 0 for bottom axis.

set_pad(*pad*)
 Set the pad in points. Note that the actual pad will be the sum of the internal pad and the external pad (that are set automatically by the AxisArtist), and it only set the internal pad

class `mpl_toolkits.axes_grid.axis_artist.TickLabels`(***kwarg*s)
 Tick Labels. While derived from Text, this single artist draws all ticklabels. As in AxisLabel, the position of the text is updated in the fly, so changing text position has no effect. Otherwise, the properties can be changed as a normal Text. Unlike the ticklabels of the mainline matplotlib, properties of single ticklabel alone cannot modified.

To change the pad between ticks and ticklabels, use `set_pad`.

get_texts_widhts_heights_descents(*render*er)
 return a list of width, height, descent for ticklabels.

set_axis_direction(*label_direc*tion)
 Adjust the text angle and text alignment of ticklabels according to the matplotlib convention.

The *label_direc*tion must be one of [left, right, bottom, top].

property	left	bottom	right	top
ticklabels angle	90	0	-90	180
ticklabel va	center	baseline	center	baseline
ticklabel ha	right	center	right	center

Note that the text angles are actually relative to (90 + angle of the direction to the ticklabel), which gives 0 for bottom axis.

THE MATPLOTLIB AXES_GRID1 TOOLKIT API

Release 2.0.2

Date May 10, 2017

69.1 `mpl_toolkits.axes_grid1.anchored_artists`

```
class mpl_toolkits.axes_grid1.anchored_artists.AnchoredAuxTransformBox(transform,  
                                                                    loc,  
                                                                    pad=0.4,  
                                                                    border-  
                                                                    pad=0.5,  
                                                                    prop=None,  
                                                                    frameon=True,  
                                                                    **kwargs)
```

Bases: `matplotlib.offsetbox.AnchoredOffsetbox`

An anchored container with transformed coordinates.

Artists added to the `drawing_area` are scaled according to the coordinates of the transformation used. The dimensions of this artist will scale to contain the artists added.

Parameters transform : `matplotlib.transforms.Transform`

The transformation object for the coordinate system in use, i.e., `matplotlib.axes.Axes.transData`.

loc : int

Location of this artist. Valid location codes are:

```
'upper right' : 1,  
'upper left'  : 2,  
'lower left'  : 3,  
'lower right' : 4,  
'right'       : 5,  
'center left' : 6,  
'center right': 7,  
'lower center': 8,
```

```
'upper center' : 9,
'center'       : 10
```

pad : int or float, optional

Padding around the child objects, in fraction of the font size. Defaults to 0.4.

borderpad : int or float, optional

Border padding, in fraction of the font size. Defaults to 0.5.

prop : *matplotlib.font_manager.FontProperties*, optional

Font property used as a reference for paddings.

frameon : bool, optional

If True, draw a box around this artists. Defaults to True.

****kwargs** :

Keyworded arguments to pass to *matplotlib.offsetbox.AnchoredOffsetbox*.

Examples

To display an ellipse in the upper left, with a width of 0.1 and height of 0.4 in data coordinates:

```
>>> box = AnchoredAuxTransformBox(ax.transData, loc=2)
>>> el = Ellipse((0,0), width=0.1, height=0.4, angle=30)
>>> box.drawing_area.add_artist(el)
>>> ax.add_artist(box)
```

Attributes

drawing_area	(<i>matplotlib.offsetbox.AuxTransformBox</i>) A container for artists to display.
--------------	-------------------------------------------------------------------------------------

```
class mpl_toolkits.axes_grid1.anchored_artists.AnchoredDrawingArea(width, height,
                                                                    xdescent, ydescent,
                                                                    loc,
                                                                    pad=0.4, borderpad=0.5,
                                                                    prop=None,
                                                                    frameon=True,
                                                                    **kwargs)
```

Bases: *matplotlib.offsetbox.AnchoredOffsetbox*

An anchored container with a fixed size and fillable DrawingArea.

Artists added to the *drawing_area* will have their coordinates interpreted as pixels. Any transformations set on the artists will be overridden.

Parameters width, height : int or float

width and height of the container, in pixels.

xdescent, ydescent : int or float

descent of the container in the x- and y- direction, in pixels.

loc : int

Location of this artist. Valid location codes are:

```
'upper right' : 1,
'upper left'  : 2,
'lower left'  : 3,
'lower right' : 4,
'right'       : 5,
'center left' : 6,
'center right': 7,
'lower center': 8,
'upper center': 9,
'center'      : 10
```

pad : int or float, optional

Padding around the child objects, in fraction of the font size. Defaults to 0.4.

borderpad : int or float, optional

Border padding, in fraction of the font size. Defaults to 0.5.

prop : *matplotlib.font_manager.FontProperties*, optional

Font property used as a reference for paddings.

frameon : bool, optional

If True, draw a box around this artists. Defaults to True.

****kwargs** :

Keyworded arguments to pass to *matplotlib.offsetbox.AnchoredOffsetbox*.

Examples

To display blue and red circles of different sizes in the upper right of an axes *ax*:

```
>>> ada = AnchoredDrawingArea(20, 20, 0, 0, loc=1, frameon=False)
>>> ada.drawing_area.add_artist(Circle((10, 10), 10, fc="b"))
>>> ada.drawing_area.add_artist(Circle((30, 10), 5, fc="r"))
>>> ax.add_artist(ada)
```

Attributes

drawing_area	(<i>matplotlib.offsetbox.DrawingArea</i>) A container for artists to display.
--------------	---------------------------------------------------------------------------------

```
class mpl_toolkits.axes_grid1.anchored_artists.AnchoredEllipse(transform, width,
                                                                height, angle,
                                                                loc, pad=0.1,
                                                                borderpad=0.1,
                                                                prop=None,
                                                                frameon=True,
                                                                **kwargs)
```

Bases: *matplotlib.offsetbox.AnchoredOffsetbox*

Draw an anchored ellipse of a given size.

Parameters transform : *matplotlib.transforms.Transform*

The transformation object for the coordinate system in use, i.e., `matplotlib.axes.Axes.transData`.

width, height : int or float

Width and height of the ellipse, given in coordinates of *transform*.

angle : int or float

Rotation of the ellipse, in degrees, anti-clockwise.

loc : int

Location of this size bar. Valid location codes are:

```
'upper right' : 1,
'upper left'  : 2,
'lower left'  : 3,
'lower right' : 4,
'right'       : 5,
'center left' : 6,
'center right': 7,
'lower center': 8,
'upper center': 9,
'center'      : 10
```

pad : int or float, optional

Padding around the ellipse, in fraction of the font size. Defaults to 0.1.

borderpad : int or float, optional

Border padding, in fraction of the font size. Defaults to 0.1.

frameon : bool, optional

If True, draw a box around the ellipse. Defaults to True.

prop : *matplotlib.font_manager.FontProperties*, optional

Font property used as a reference for paddings.

****kwargs :**

Keyworded arguments to pass to `matplotlib.offsetbox.AnchoredOffsetbox`.

Attributes

ellipse	(<code>matplotlib.patches.Ellipse</code>) Ellipse patch drawn.
---------	------------------------------------------------------------------

```
class mpl_toolkits.axes_grid1.anchored_artists.AnchoredSizeBar(transform, size,
                                                                label, loc,
                                                                pad=0.1, borderpad=0.1, sep=2,
                                                                frameon=True,
                                                                size_vertical=0,
                                                                color='black', label_top=False, font-
                                                                properties=None,
                                                                **kwargs)
```

Bases: `matplotlib.offsetbox.AnchoredOffsetbox`

Draw a horizontal scale bar with a center-aligned label underneath.

Parameters transform : `matplotlib.transforms.Transform`

The transformation object for the coordinate system in use, i.e., `matplotlib.axes.Axes.transData`.

size : int or float

Horizontal length of the size bar, given in coordinates of *transform*.

label : str

Label to display.

loc : int

Location of this size bar. Valid location codes are:

'upper right'	: 1,
'upper left'	: 2,
'lower left'	: 3,
'lower right'	: 4,
'right'	: 5,
'center left'	: 6,
'center right'	: 7,
'lower center'	: 8,
'upper center'	: 9,
'center'	: 10

pad : int or float, optional

Padding around the label and size bar, in fraction of the font size. Defaults to 0.1.

borderpad : int or float, optional

Border padding, in fraction of the font size. Defaults to 0.1.

sep : int or float, optional

Separation between the label and the size bar, in points. Defaults to 2.

frameon : bool, optional

If True, draw a box around the horizontal bar and label. Defaults to True.

size_vertical : int or float, optional

Vertical length of the size bar, given in coordinates of *transform*. Defaults to 0.

color : str, optional

Color for the size bar and label. Defaults to black.

label_top : bool, optional

If True, the label will be over the size bar. Defaults to False.

fontproperties : *matplotlib.font_manager.FontProperties*, optional

Font properties for the label text.

****kwargs** :

Keyworded arguments to pass to *matplotlib.offsetbox.AnchoredOffsetbox*.

Notes

If *prop* is passed as a keyworded argument, but *fontproperties* is not, then *prop* is assumed to be the intended *fontproperties*. Using both *prop* and *fontproperties* is not supported.

Examples

```
>>> import matplotlib.pyplot as plt
>>> import numpy as np
>>> from mpl_toolkits.axes_grid1.anchored_artists import AnchoredSizeBar
>>> fig, ax = plt.subplots()
>>> ax.imshow(np.random.random((10,10)))
>>> bar = AnchoredSizeBar(ax.transData, 3, '3 data units', 4)
>>> ax.add_artist(bar)
>>> fig.show()
```

Using all the optional parameters

```
>>> import matplotlib.font_manager as fm
>>> fontprops = fm.FontProperties(size=14, family='monospace')
>>> bar = AnchoredSizeBar(ax.transData, 3, '3 units', 4, pad=0.5, sep=5,
↳borderpad=0.5, frameon=False, size_vertical=0.5, color='white',
↳fontproperties=fontprops)
```

Attributes

size_bar	(<i>matplotlib.offsetbox.AuxTransformBox</i>) Container for the size bar.
txt_label	(<i>matplotlib.offsetbox.TextArea</i>) Container for the label of the size bar.

69.2 mpl_toolkits.axes_grid1.inset_locator

A collection of functions and objects for creating or placing inset axes.

```
class mpl_toolkits.axes_grid1.inset_locator.AnchoredLocatorBase(bbox_to_anchor,
                                                                offsetbox, loc,
                                                                borderpad=0.5,
                                                                bbox_transform=None)
```

Bases: *matplotlib.offsetbox.AnchoredOffsetbox*

draw(*renderer*)

```
class mpl_toolkits.axes_grid1.inset_locator.AnchoredSizeLocator(bbox_to_anchor,
                                                                x_size, y_size, loc,
                                                                borderpad=0.5,
                                                                bbox_transform=None)
```

Bases: *mpl_toolkits.axes_grid1.inset_locator.AnchoredLocatorBase*

get_extent(*renderer*)

```
class mpl_toolkits.axes_grid1.inset_locator.AnchoredZoomLocator(parent_axes,
                                                                zoom, loc, borderpad=0.5,
                                                                bbox_to_anchor=None,
                                                                bbox_transform=None)
```

Bases: *mpl_toolkits.axes_grid1.inset_locator.AnchoredLocatorBase*

get_extent(*renderer*)

```
class mpl_toolkits.axes_grid1.inset_locator.BboxConnector(bbox1, bbox2, loc1,
                                                                loc2=None, **kwargs)
```

Bases: *matplotlib.patches.Patch*

Connect two bboxes with a straight line.

Parameters **bbox1**, **bbox2** : *matplotlib.transforms.Bbox*

Bounding boxes to connect.

loc1 : {1, 2, 3, 4}

Corner of *bbbox1* to draw the line. Valid values are:

```
'upper right' : 1,
'upper left'  : 2,
'lower left'  : 3,
'lower right' : 4
```

loc2 : {1, 2, 3, 4}, optional

Corner of *bbbox2* to draw the line. If None, defaults to *loc1*. Valid values are:

```
'upper right' : 1,
'upper left'  : 2,
'lower left'  : 3,
'lower right' : 4
```

****kwargs**

Patch properties for the line drawn. Valid arguments include:

Property	Description
<i>agg_filter</i>	unknown
<i>alpha</i>	float or None
<i>animated</i>	[True False]
<i>antialiased</i> or <i>aa</i>	[True False] or None for default
<i>axes</i>	an <i>Axes</i> instance
<i>capstyle</i>	['butt' 'round' 'projecting']
<i>clip_box</i>	a <i>matplotlib.transforms.Bbox</i> instance
<i>clip_on</i>	[True False]
<i>clip_path</i>	[(<i>Path</i> , <i>Transform</i>) <i>Patch</i> None]
<i>color</i>	matplotlib color spec
<i>contains</i>	a callable function
<i>edgecolor</i> or <i>ec</i>	mpl color spec, None, 'none', or 'auto'
<i>facecolor</i> or <i>fc</i>	mpl color spec, or None for default, or 'none' for no color
<i>figure</i>	a <i>matplotlib.figure.Figure</i> instance
<i>fill</i>	[True False]
<i>gid</i>	an id string
<i>hatch</i>	['/' '\' ' ' '-' '+' 'x' 'o' 'O' '.' '*']
<i>joinstyle</i>	['miter' 'round' 'bevel']
<i>label</i>	string or anything printable with '%s' conversion.
<i>linestyle</i> or <i>ls</i>	['solid' 'dashed', 'dashdot', 'dotted' (offset, on-off-dash-seq) '-' '--' '-.' ':' 'None']
<i>linewidth</i> or <i>lw</i>	float or None for default
<i>path_effects</i>	unknown
<i>picker</i>	[None float boolean callable]
<i>rasterized</i>	[True False None]

Continued on

Table 69.1 – continued from previous page

Property	Description
<code>sketch_params</code>	unknown
<code>snap</code>	unknown
<code>transform</code>	<i>Transform</i> instance
<code>url</code>	a url string
<code>visible</code>	[True False]
<code>zorder</code>	any number

static connect_bbox(*bbox1*, *bbox2*, *loc1*, *loc2=None*)

Helper function to obtain a Path from one bbox to another.

Parameters *bbox1*, *bbox2* : *matplotlib.transforms.Bbox*

Bounding boxes to connect.

loc1 : {1, 2, 3, 4}

Corner of *bbox1* to use. Valid values are:

```
'upper right' : 1,
'upper left'  : 2,
'lower left'  : 3,
'lower right' : 4
```

loc2 : {1, 2, 3, 4}, optional

Corner of *bbox2* to use. If None, defaults to *loc1*. Valid values are:

```
'upper right' : 1,
'upper left'  : 2,
'lower left'  : 3,
'lower right' : 4
```

Returns *path* : *matplotlib.path.Path*

A line segment from the *loc1* corner of *bbox1* to the *loc2* corner of *bbox2*.

static get_bbox_edge_pos(*bbox*, *loc*)

Helper function to obtain the location of a corner of a bbox

Parameters *bbox* : *matplotlib.transforms.Bbox*

loc : {1, 2, 3, 4}

Corner of *bbox*. Valid values are:

```
'upper right' : 1,
'upper left'  : 2,
'lower left'  : 3,
'lower right' : 4
```

Returns *x*, *y* : float

Coordinates of the corner specified by *loc*.

get_path()

Return the path of this patch

class `mpl_toolkits.axes_grid1.inset_locator.BboxConnectorPatch`(*bbox1*, *bbox2*,
loc1a, *loc2a*, *loc1b*,
loc2b, ****kwargs**)

Bases: `mpl_toolkits.axes_grid1.inset_locator.BboxConnector`

Connect two bboxes with a quadrilateral.

The quadrilateral is specified by two lines that start and end at corners of the bboxes. The four sides of the quadrilateral are defined by the two lines given, the line between the two corners specified in *bbox1* and the line between the two corners specified in *bbox2*.

Parameters *bbox1*, *bbox2* : `matplotlib.transforms.Bbox`

Bounding boxes to connect.

loc1a, loc2a : {1, 2, 3, 4}

Corners of *bbox1* and *bbox2* to draw the first line. Valid values are:

```
'upper right' : 1,
'upper left'  : 2,
'lower left'  : 3,
'lower right' : 4
```

loc1b, loc2b : {1, 2, 3, 4}

Corners of *bbox1* and *bbox2* to draw the second line. Valid values are:

```
'upper right' : 1,
'upper left'  : 2,
'lower left'  : 3,
'lower right' : 4
```

****kwargs**

Patch properties for the line drawn:

Property	Description
<i>agg_filter</i>	unknown
<i>alpha</i>	float or None
<i>animated</i>	[True False]
<i>antialiased</i> or <i>aa</i>	[True False] or None for default
<i>axes</i>	an <i>Axes</i> instance
<i>capstyle</i>	['butt' 'round' 'projecting']
<i>clip_box</i>	a <code>matplotlib.transforms.Bbox</code> instance
<i>clip_on</i>	[True False]
<i>clip_path</i>	[(<i>Path</i> , <i>Transform</i>) <i>Patch</i> None]
<i>color</i>	matplotlib color spec
<i>contains</i>	a callable function

Continued on

Table 69.2 – continued from previous page

Property	Description
<i>edgecolor</i> or <i>ec</i>	mpl color spec, None, ‘none’, or ‘auto’
<i>facecolor</i> or <i>fc</i>	mpl color spec, or None for default, or ‘none’ for no color
<i>figure</i>	a <i>matplotlib.figure.Figure</i> instance
<i>fill</i>	[True False]
<i>gid</i>	an id string
<i>hatch</i>	[‘/’ ‘\’ ‘ ’ ‘-’ ‘+’ ‘x’ ‘o’ ‘O’ ‘.’ ‘*’]
<i>joinstyle</i>	[‘miter’ ‘round’ ‘bevel’]
<i>label</i>	string or anything printable with ‘%s’ conversion.
<i>linestyle</i> or <i>ls</i>	[‘solid’ ‘dashed’, ‘dashdot’, ‘dotted’ (offset, on-off-dash-seq) ‘-’ ‘--’ ‘-.’ ‘:’ ‘None’]
<i>linewidth</i> or <i>lw</i>	float or None for default
<i>path_effects</i>	unknown
<i>picker</i>	[None float boolean callable]
<i>rasterized</i>	[True False None]
<i>sketch_params</i>	unknown
<i>snap</i>	unknown
<i>transform</i>	<i>Transform</i> instance
<i>url</i>	a url string
<i>visible</i>	[True False]
<i>zorder</i>	any number

get_path()

Return the path of this patch

class `mpl_toolkits.axes_grid1.inset_locator.BboxPatch`(*bbox*, ****kwargs**)

Bases: *matplotlib.patches.Patch*

Patch showing the shape bounded by a Bbox.

Parameters *bbox* : *matplotlib.transforms.Bbox*

Bbox to use for the extents of this patch.

****kwargs**

Patch properties. Valid arguments include:

Property	Description
<i>agg_filter</i>	unknown
<i>alpha</i>	float or None
<i>animated</i>	[True False]
<i>antialiased</i> or <i>aa</i>	[True False] or None for default
<i>axes</i>	an <i>Axes</i> instance
<i>capstyle</i>	[‘butt’ ‘round’ ‘projecting’]
<i>clip_box</i>	a <i>matplotlib.transforms.Bbox</i> instance
<i>clip_on</i>	[True False]
<i>clip_path</i>	[(<i>Path</i> , <i>Transform</i>) <i>Patch</i> None]

Continued on

Table 69.3 – continued from previous page

Property	Description
<i>color</i>	matplotlib color spec
<i>contains</i>	a callable function
<i>edgecolor</i> or <i>ec</i>	mpl color spec, None, ‘none’, or ‘auto’
<i>facecolor</i> or <i>fc</i>	mpl color spec, or None for default, or ‘none’ for no color
<i>figure</i>	a <i>matplotlib.figure.Figure</i> instance
<i>fill</i>	[True False]
<i>gid</i>	an id string
<i>hatch</i>	[‘/’ ‘\’ ‘ ’ ‘-’ ‘+’ ‘x’ ‘o’ ‘O’ ‘.’ ‘*’]
<i>joinstyle</i>	[‘miter’ ‘round’ ‘bevel’]
<i>label</i>	string or anything printable with ‘%s’ conversion.
<i>linestyle</i> or <i>ls</i>	[‘solid’ ‘dashed’, ‘dashdot’, ‘dotted’ (offset, on-off-dash-seq) ‘-’ ‘--’ ‘-.’ ‘:’ ‘None’]
<i>linewidth</i> or <i>lw</i>	float or None for default
<i>path_effects</i>	unknown
<i>picker</i>	[None float boolean callable]
<i>rasterized</i>	[True False None]
<i>sketch_params</i>	unknown
<i>snap</i>	unknown
<i>transform</i>	<i>Transform</i> instance
<i>url</i>	a url string
<i>visible</i>	[True False]
<i>zorder</i>	any number

get_path()

Return the path of this patch

class `mpl_toolkits.axes_grid1.inset_locator.InsetPosition`(*parent*, *lbwh*)

Bases: `object`

An object for positioning an inset axes.

This is created by specifying the normalized coordinates in the axes, instead of the figure.

Parameters *parent* : `matplotlib.axes.Axes`

Axes to use for normalizing coordinates.

lbwh : iterable of four floats

The left edge, bottom edge, width, and height of the inset axes, in units of the normalized coordinate of the *parent* axes.

See also:

`matplotlib.axes.Axes.set_axes_locator()`

Examples

The following bounds the inset axes to a box with 20% of the parent axes's height and 40% of the width. The size of the axes specified ([0, 0, 1, 1]) ensures that the axes completely fills the bounding box:

```
>>> parent_axes = plt.gca()
>>> ax_ins = plt.axes([0, 0, 1, 1])
>>> ip = InsetPosition(ax, [0.5, 0.1, 0.4, 0.2])
>>> ax_ins.set_axes_locator(ip)
```

```
mpl_toolkits.axes_grid1.inset_locator.inset_axes(parent_axes, width, height,
loc=1, bbox_to_anchor=None,
bbox_transform=None,
axes_class=None,
axes_kwargs=None, borderpad=0.5)
```

Create an inset axes with a given width and height.

Both sizes used can be specified either in inches or percentage of the parent axes.

Parameters `parent_axes` : `matplotlib.axes.Axes`

Axes to place the inset axes.

width, height : float or str

Size of the inset axes to create.

loc : int or string, optional, default to 1

Location to place the inset axes. The valid locations are:

```
'upper right' : 1,
'upper left'  : 2,
'lower left'  : 3,
'lower right' : 4,
'right'       : 5,
'center left' : 6,
'center right': 7,
'lower center': 8,
'upper center': 9,
'center'      : 10
```

bbox_to_anchor : tuple or `matplotlib.transforms.BboxBase`, optional

Bbox that the inset axes will be anchored. Can be a tuple of [left, bottom, width, height], or a tuple of [left, bottom].

bbox_transform : `matplotlib.transforms.Transform`, optional

Transformation for the bbox. if None, `parent_axes.transAxes` is used.

axes_class : `matplotlib.axes.Axes` type, optional

If specified, the inset axes created will be created with this class's constructor.

`axes_kwargs` : dict, optional

Keyworded arguments to pass to the constructor of the inset axes. Valid arguments include:

Property	Description
<code>adjustable</code>	['box' 'datalim' 'box-forced']
<code>agg_filter</code>	unknown
<code>alpha</code>	float (0.0 transparent through 1.0 opaque)
<code>anchor</code>	unknown
<code>animated</code>	[True False]
<code>aspect</code>	unknown
<code>autoscale_on</code>	unknown
<code>autoscalex_on</code>	unknown
<code>autoscaley_on</code>	unknown
<code>axes</code>	an <i>Axes</i> instance
<code>axes_locator</code>	unknown
<code>axisbelow</code>	[<i>True</i> <i>False</i> 'line']
<code>clip_box</code>	a <i>matplotlib.transforms.Bbox</i> instance
<code>clip_on</code>	[True False]
<code>clip_path</code>	[(<i>Path</i> , <i>Transform</i>) <i>Patch</i> None]
<code>color_cycle</code>	unknown
<code>contains</code>	a callable function
<code>facecolor</code>	unknown
<code>fc</code>	unknown
<code>figure</code>	unknown
<code>frame_on</code>	[<i>True</i> <i>False</i>]
<code>gid</code>	an id string
<code>label</code>	string or anything printable with '%s' conversion.
<code>navigate</code>	[<i>True</i> <i>False</i>]
<code>navigate_mode</code>	unknown
<code>path_effects</code>	unknown
<code>picker</code>	[None float boolean callable]
<code>position</code>	unknown
<code>rasterization_zorder</code>	unknown
<code>rasterized</code>	[True False None]
<code>sketch_params</code>	unknown
<code>snap</code>	unknown
<code>title</code>	unknown
<code>transform</code>	<i>Transform</i> instance
<code>url</code>	a url string
<code>visible</code>	[True False]
<code>xbound</code>	unknown
<code>xlabel</code>	unknown
<code>xlim</code>	unknown
<code>xmargin</code>	unknown

Continued on next page

Table 69.4 – continued from previous page

Property	Description
<code>xscale</code>	[‘linear’ ‘log’ ‘logit’ ‘symlog’]
<code>xticklabels</code>	sequence of strings
<code>xticks</code>	sequence of floats
<code>ybound</code>	unknown
<code>ylabel</code>	unknown
<code>ylim</code>	unknown
<code>ymargin</code>	unknown
<code>yscale</code>	[‘linear’ ‘log’ ‘logit’ ‘symlog’]
<code>yticklabels</code>	sequence of strings
<code>yticks</code>	sequence of floats
<code>zorder</code>	any number

borderpad : float, optional

Padding between inset axes and the `bbox_to_anchor`. Defaults to 0.5.

Returns `inset_axes` : `axes_class`

Inset axes object created.

`mpl_toolkits.axes_grid1.inset_locator.mark_inset`(*parent_axes*, *inset_axes*, *loc1*, *loc2*,
***kwargs*)

Draw a box to mark the location of an area represented by an inset axes.

This function draws a box in *parent_axes* at the bounding box of *inset_axes*, and shows a connection with the inset axes by drawing lines at the corners, giving a “zoomed in” effect.

Parameters `parent_axes` : `matplotlib.axes.Axes`

Axes which contains the area of the inset axes.

`inset_axes` : `matplotlib.axes.Axes`

The inset axes.

`loc1`, `loc2` : {1, 2, 3, 4}

Corners to use for connecting the inset axes and the area in the parent axes.

**`kwargs`

Patch properties for the lines and box drawn:

Property	Description
<code>agg_filter</code>	unknown
<code>alpha</code>	float or None
<code>animated</code>	[True False]
<code>antialiased</code> or <code>aa</code>	[True False] or None for default
<code>axes</code>	an <code>Axes</code> instance
<code>capstyle</code>	[‘butt’ ‘round’ ‘projecting’]

Continued on

Table 69.5 – continued from previous page

Property	Description
<i>clip_box</i>	a <i>matplotlib.transforms.Bbox</i> instance
<i>clip_on</i>	[True False]
<i>clip_path</i>	[(<i>Path</i> , <i>Transform</i>) <i>Patch</i> None]
<i>color</i>	matplotlib color spec
<i>contains</i>	a callable function
<i>edgecolor</i> or <i>ec</i>	mpl color spec, None, ‘none’, or ‘auto’
<i>facecolor</i> or <i>fc</i>	mpl color spec, or None for default, or ‘none’ for no color
<i>figure</i>	a <i>matplotlib.figure.Figure</i> instance
<i>fill</i>	[True False]
<i>gid</i>	an id string
<i>hatch</i>	['/' '\' ' ' '-' '+' 'x' 'o' 'O' '.' '*']
<i>joinstyle</i>	['miter' 'round' 'bevel']
<i>label</i>	string or anything printable with ‘%s’ conversion.
<i>linestyle</i> or <i>ls</i>	['solid' 'dashed', 'dashdot', 'dotted' (offset, on-off-dash-seq) '-' '--' '-.' ':' 'None']
<i>linewidth</i> or <i>lw</i>	float or None for default
<i>path_effects</i>	unknown
<i>picker</i>	[None float boolean callable]
<i>rasterized</i>	[True False None]
<i>sketch_params</i>	unknown
<i>snap</i>	unknown
<i>transform</i>	<i>Transform</i> instance
<i>url</i>	a url string
<i>visible</i>	[True False]
<i>zorder</i>	any number

Returns *pp* : *matplotlib.patches.Patch*

The patch drawn to represent the area of the inset axes.

p1, p2 : *matplotlib.patches.Patch*

The patches connecting two corners of the inset axes and its area.

`mpl_toolkits.axes_grid1.inset_locator.zoomed_inset_axes`(*parent_axes*, *zoom*, *loc=1*,
bbox_to_anchor=None,
bbox_transform=None,
axes_class=None,
axes_kwargs=None,
borderpad=0.5)

Create an anchored inset axes by scaling a parent axes.

Parameters *parent_axes* : *matplotlib.axes.Axes*

Axes to place the inset axes.

zoom : float

Scaling factor of the data axes. *zoom* > 1 will enlargen the coordinates (i.e., “zoomed in”), while *zoom* < 1 will shrink the coordinates (i.e., “zoomed

out”).

loc : int or string, optional, default to 1

Location to place the inset axes. The valid locations are:

```
'upper right' : 1,
'upper left'  : 2,
'lower left'  : 3,
'lower right' : 4,
'right'       : 5,
'center left' : 6,
'center right': 7,
'lower center': 8,
'upper center': 9,
'center'      : 10
```

bbox_to_anchor : tuple or *matplotlib.transforms.BboxBase*, optional

Bbox that the inset axes will be anchored. Can be a tuple of [left, bottom, width, height], or a tuple of [left, bottom].

bbox_transform : *matplotlib.transforms.Transform*, optional

Transformation for the bbox. if None, *parent_axes.transAxes* is used.

axes_class : *matplotlib.axes.Axes* type, optional

If specified, the inset axes created will be created with this class’s constructor.

axes_kwargs : dict, optional

Keyworded arguments to pass to the constructor of the inset axes. Valid arguments include:

Property	Description
<code>adjustable</code>	['box' 'datalim' 'box-forced']
<code>agg_filter</code>	unknown
<code>alpha</code>	float (0.0 transparent through 1.0 opaque)
<code>anchor</code>	unknown
<code>animated</code>	[True False]
<code>aspect</code>	unknown
<code>autoscale_on</code>	unknown
<code>autoscalex_on</code>	unknown
<code>autoscaley_on</code>	unknown
<code>axes</code>	an <i>Axes</i> instance
<code>axes_locator</code>	unknown
<code>axisbelow</code>	[True False 'line']
<code>clip_box</code>	a <i>matplotlib.transforms.Bbox</i> instance
<code>clip_on</code>	[True False]
<code>clip_path</code>	[(Path, Transform) Patch None]
<code>color_cycle</code>	unknown

Continued on next page

Table 69.6 – continued from previous page

Property	Description
<i>contains</i>	a callable function
facecolor	unknown
fc	unknown
figure	unknown
frame_on	[<i>True</i> <i>False</i>]
<i>gid</i>	an id string
<i>label</i>	string or anything printable with ‘%s’ conversion.
navigate	[<i>True</i> <i>False</i>]
navigate_mode	unknown
<i>path_effects</i>	unknown
<i>picker</i>	[None float boolean callable]
position	unknown
rasterization_zorder	unknown
<i>rasterized</i>	[<i>True</i> <i>False</i> <i>None</i>]
<i>sketch_params</i>	unknown
<i>snap</i>	unknown
title	unknown
<i>transform</i>	<i>Transform</i> instance
<i>url</i>	a url string
<i>visible</i>	[<i>True</i> <i>False</i>]
xbound	unknown
xlabel	unknown
xlim	unknown
xmargin	unknown
xscale	[‘linear’ ‘log’ ‘logit’ ‘symlog’]
xticklabels	sequence of strings
xticks	sequence of floats
ybound	unknown
ylabel	unknown
ylim	unknown
ymargin	unknown
yscale	[‘linear’ ‘log’ ‘logit’ ‘symlog’]
yticklabels	sequence of strings
yticks	sequence of floats
<i>zorder</i>	any number

borderpad : float, optional

Padding between inset axes and the `bbox_to_anchor`. Defaults to 0.5.

Returns `inset_axes` : `axes_class`

Inset axes object created.

Part V

mplot3d

MATPLOTLIB MPLOTLIB 3D TOOLKIT

The `mplot3d` toolkit adds simple 3D plotting capabilities to `matplotlib` by supplying an axes object that can create a 2D projection of a 3D scene. The resulting graph will have the same look and feel as regular 2D plots.

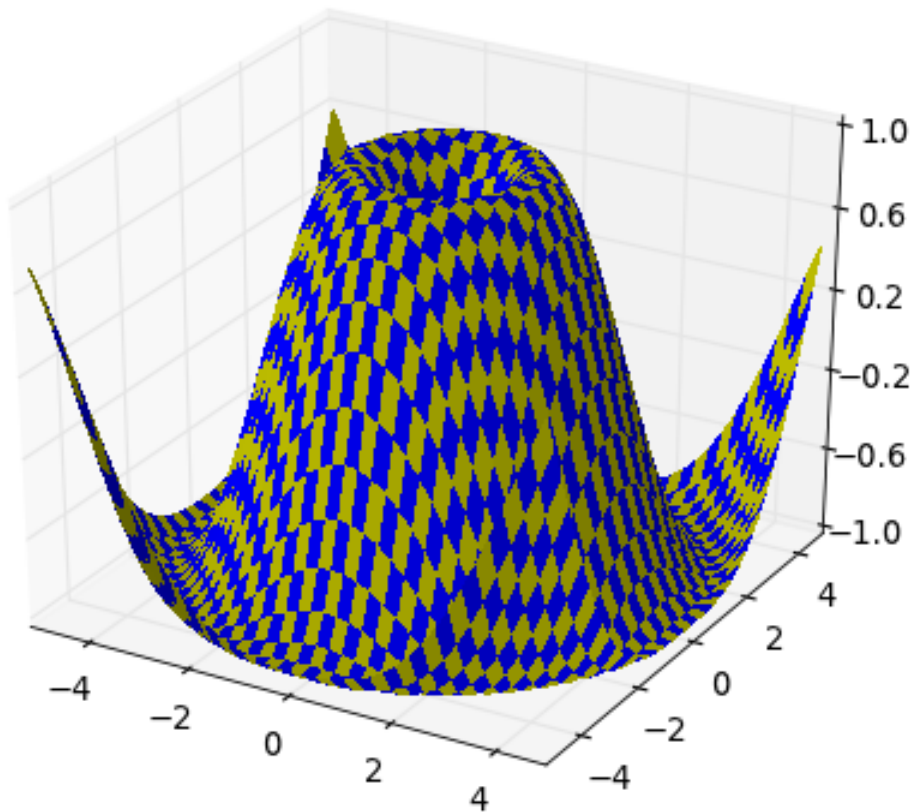

The interactive backends also provide the ability to rotate and zoom the 3D scene. One can rotate the 3D scene by simply clicking-and-dragging the scene. Zooming is done by right-clicking the scene and dragging the mouse up and down. Note that one does not use the zoom button like one would use for regular 2D plots.

70.1 mplot3d tutorial

Contents

- *mplot3d tutorial*
 - *Getting started*
 - *Line plots*
 - *Scatter plots*
 - *Wireframe plots*
 - *Surface plots*
 - *Tri-Surface plots*
 - *Contour plots*
 - *Filled contour plots*
 - *Polygon plots*
 - *Bar plots*
 - *Quiver*
 - *2D plots in 3D*
 - *Text*
 - *Subplotting*

70.1.1 Getting started

An Axes3D object is created just like any other axes using the `projection='3d'` keyword. Create a new `matplotlib.figure.Figure` and add a new axes to it of type Axes3D:

```
import matplotlib.pyplot as plt
from mpl_toolkits.mplot3d import Axes3D
fig = plt.figure()
ax = fig.add_subplot(111, projection='3d')
```

New in version 1.0.0: This approach is the preferred method of creating a 3D axes.

Note: Prior to version 1.0.0, the method of creating a 3D axes was different. For those using older versions of matplotlib, change `ax = fig.add_subplot(111, projection='3d')` to `ax = Axes3D(fig)`.

70.1.2 Line plots

`Axes3D.plot(xs, ys, *args, **kwargs)`

Plot 2D or 3D data.

Argument	Description
<code>xs, ys</code>	x, y coordinates of vertices
<code>zs</code>	z value(s), either one for all points or one for each point.
<code>zdir</code>	Which direction to use as z ('x', 'y' or 'z') when plotting a 2D set.

Other arguments are passed on to `plot()`

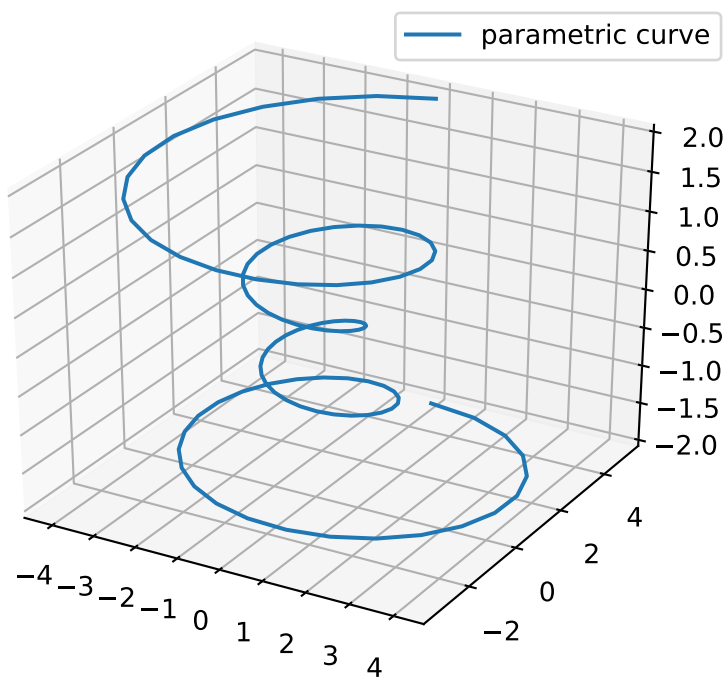

70.1.3 Scatter plots

`Axes3D.scatter(xs, ys, zs=0, zdir='z', s=20, c=None, depthshade=True, *args, **kwargs)`

Create a scatter plot.

Argument	Description
<i>xs, ys</i>	Positions of data points.
<i>zs</i>	Either an array of the same length as <i>xs</i> and <i>ys</i> or a single value to place all points in the same plane. Default is 0.
<i>zdir</i>	Which direction to use as z ('x', 'y' or 'z') when plotting a 2D set.
<i>s</i>	Size in points ² . It is a scalar or an array of the same length as <i>x</i> and <i>y</i> .
<i>c</i>	A color. <i>c</i> can be a single color format string, or a sequence of color specifications of length <i>N</i> , or a sequence of <i>N</i> numbers to be mapped to colors using the <i>cmap</i> and <i>norm</i> specified via kwargs (see below). Note that <i>c</i> should not be a single numeric RGB or RGBA sequence because that is indistinguishable from an array of values to be colormapped. <i>c</i> can be a 2-D array in which the rows are RGB or RGBA, however, including the case of a single row to specify the same color for all points.
<i>depthshade</i>	Whether or not to shade the scatter markers to give the appearance of depth. Default is <i>True</i> .

Keyword arguments are passed on to `scatter()`.

Returns a `Patch3DCollection`

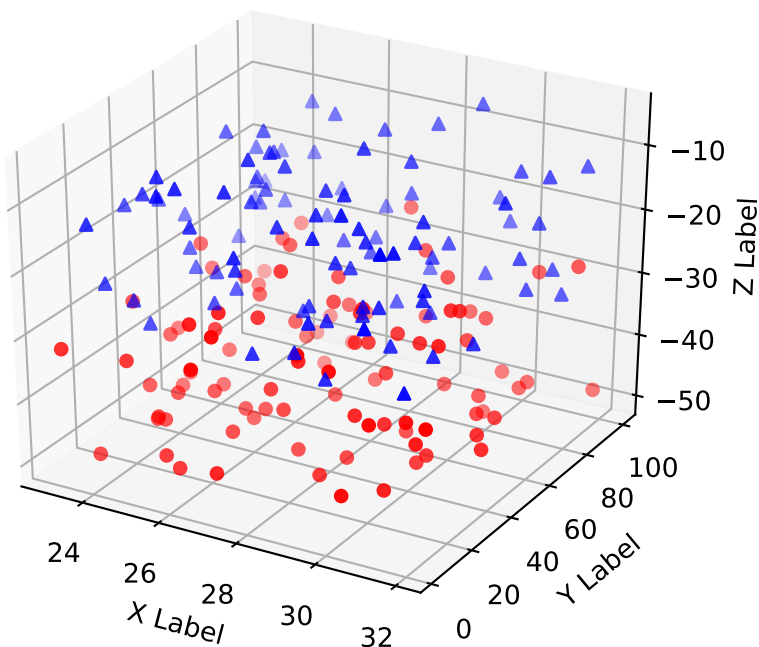

70.1.4 Wireframe plots

`Axes3D.plot_wireframe(X, Y, Z, *args, **kwargs)`

Plot a 3D wireframe.

The `rstride` and `cstride` kwargs set the stride used to sample the input data to generate the graph. If either is 0 the input data is not sampled along this direction producing a 3D line plot rather than a wireframe plot. The stride arguments are only used by default if in the ‘classic’ mode. They are now superseded by `rcount` and `ccount`. Will raise `ValueError` if both stride and count are used.

- ‘ **The `rcount` and `ccount` kwargs supersedes `rstride` and `cstride`** for default sampling method for wireframe plotting. These arguments will determine at most how many evenly spaced samples will be taken from the input data to generate the graph. This is the default sampling method unless using the ‘classic’ style. Will raise `ValueError` if both stride and count are specified. If either is zero, then the input data is not sampled along this direction, producing a 3D line plot rather than a wireframe plot. Added in v2.0.0.

Argument	Description
<code>X, Y,</code>	Data values as 2D arrays
<code>Z</code>	
<code>rstride</code>	Array row stride (step size), defaults to 1
<code>cstride</code>	Array column stride (step size), defaults to 1
<code>rcount</code>	Use at most this many rows, defaults to 50
<code>ccount</code>	Use at most this many columns, defaults to 50

Keyword arguments are passed on to [LineCollection](#).

Returns a [Line3DCollection](#)

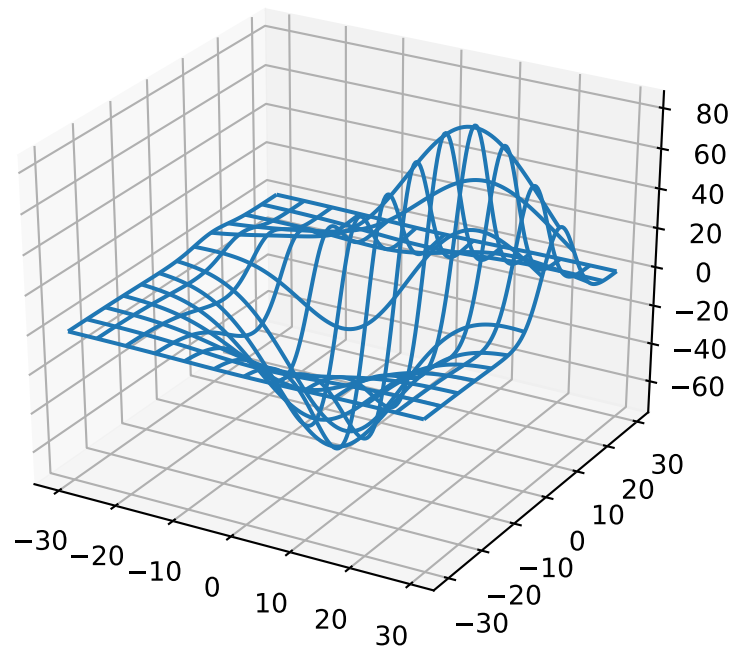

70.1.5 Surface plots

`Axes3D.plot_surface(X, Y, Z, *args, **kwargs)`

Create a surface plot.

By default it will be colored in shades of a solid color, but it also supports color mapping by supplying the *cmap* argument.

The *rstride* and *cstride* kwargs set the stride used to sample the input data to generate the graph. If 1k by 1k arrays are passed in, the default values for the strides will result in a 100x100 grid being plotted. Defaults to 10. Raises a `ValueError` if both stride and count kwargs (see next section) are provided.

The *rcount* and *ccount* kwargs supersedes *rstride* and *cstride* for default sampling method for surface plotting. These arguments will determine at most how many evenly spaced samples will be taken from the input data to generate the graph. This is the default sampling method unless using the 'classic' style. Will raise `ValueError` if both stride and count are specified. Added in v2.0.0.

Argument	Description
<i>X, Y, Z</i>	Data values as 2D arrays
<i>rstride</i>	Array row stride (step size)
<i>cstride</i>	Array column stride (step size)
<i>rcount</i>	Use at most this many rows, defaults to 50
<i>ccount</i>	Use at most this many columns, defaults to 50
<i>color</i>	Color of the surface patches
<i>cmap</i>	A colormap for the surface patches.
<i>facecolors</i>	Face colors for the individual patches
<i>norm</i>	An instance of Normalize to map values to colors
<i>vmin</i>	Minimum value to map
<i>vmax</i>	Maximum value to map
<i>shade</i>	Whether to shade the facecolors

Other arguments are passed on to *Poly3DCollection*

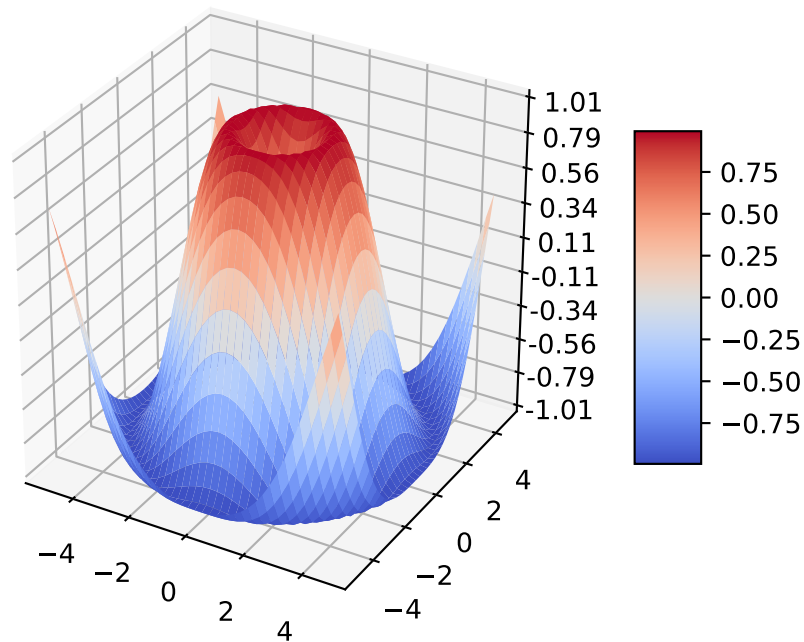

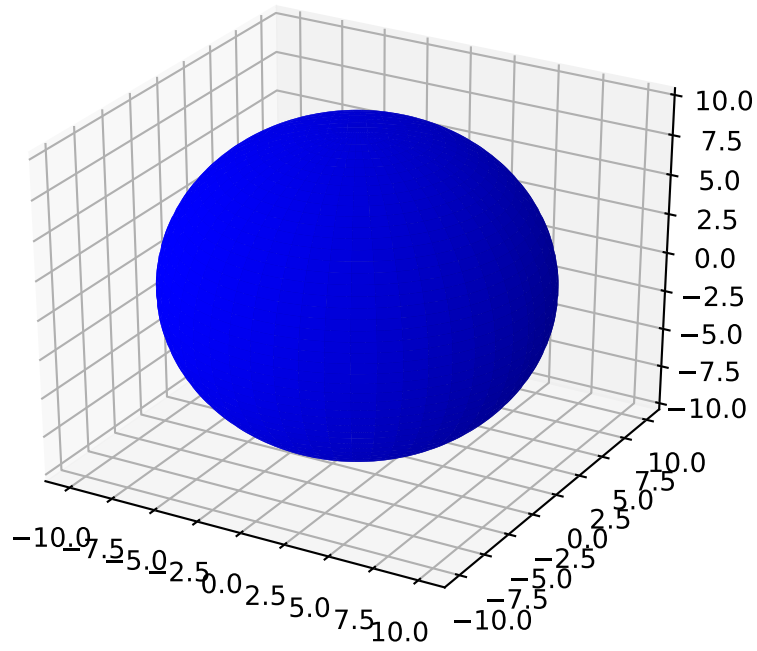

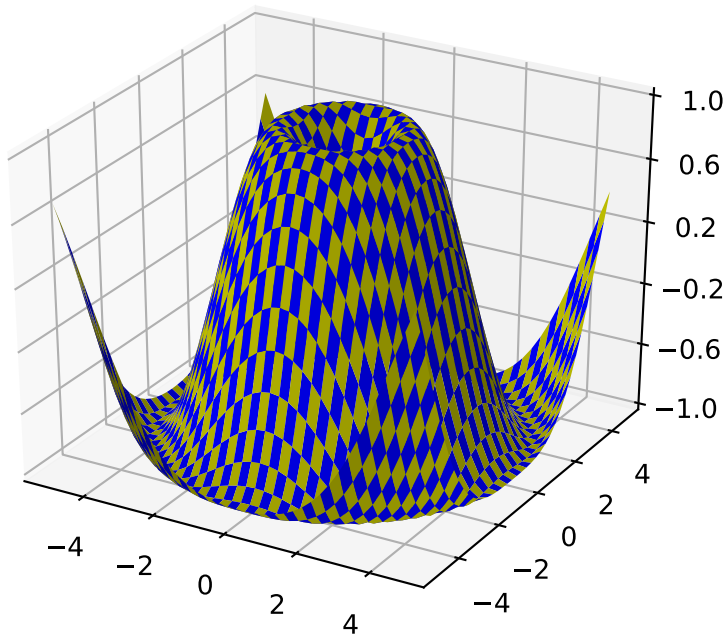

70.1.6 Tri-Surface plots

`Axes3D.plot_trisurf(*args, **kwargs)`

Argument	Description
X, Y, Z	Data values as 1D arrays
<i>color</i>	Color of the surface patches
<i>cmap</i>	A colormap for the surface patches.
<i>norm</i>	An instance of <code>Normalize</code> to map values to colors
<i>vmin</i>	Minimum value to map
<i>vmax</i>	Maximum value to map
<i>shade</i>	Whether to shade the facecolors

The (optional) triangulation can be specified in one of two ways; either:

```
plot_trisurf(triangulation, ...)
```

where `triangulation` is a `Triangulation` object, or:

```
plot_trisurf(X, Y, ...)
plot_trisurf(X, Y, triangles, ...)
plot_trisurf(X, Y, triangles=triangles, ...)
```

in which case a `Triangulation` object will be created. See `Triangulation` for an explanation of these

possibilities.

The remaining arguments are:

```
plot_trisurf(..., Z)
```

where Z is the array of values to contour, one per point in the triangulation.

Other arguments are passed on to *Poly3DCollection*

Examples:

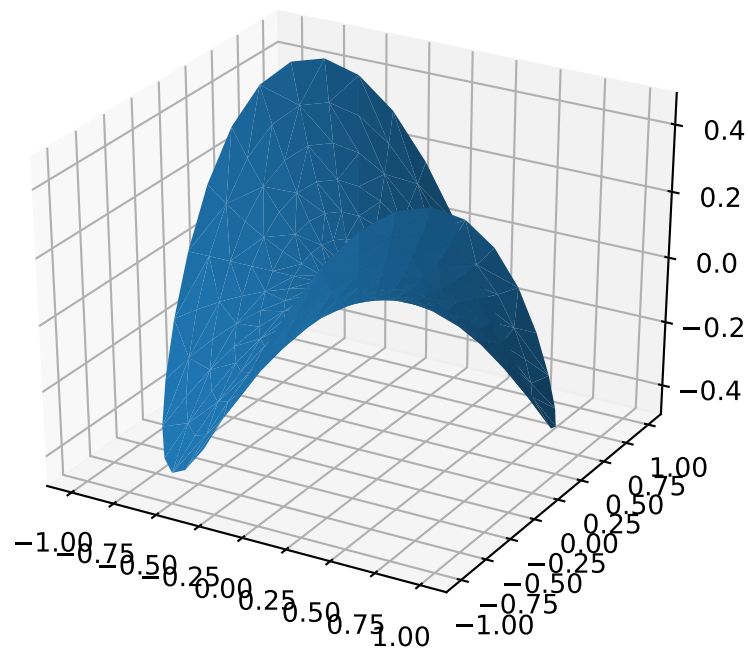

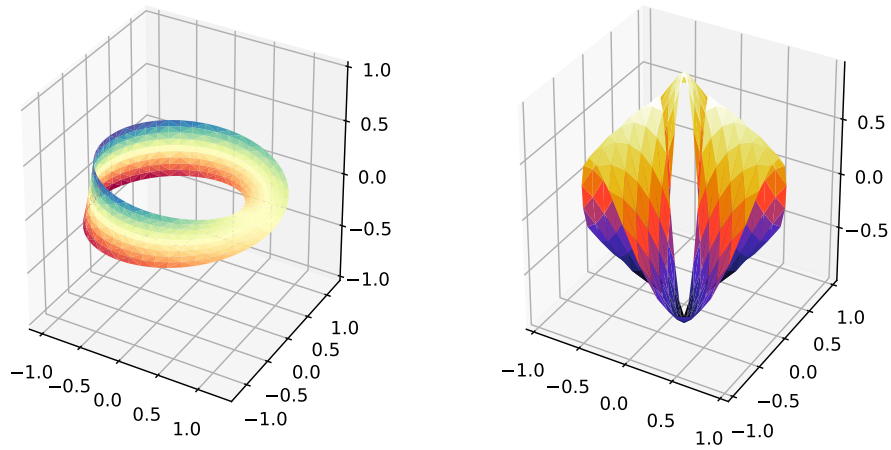

New in version 1.2.0: This plotting function was added for the v1.2.0 release.

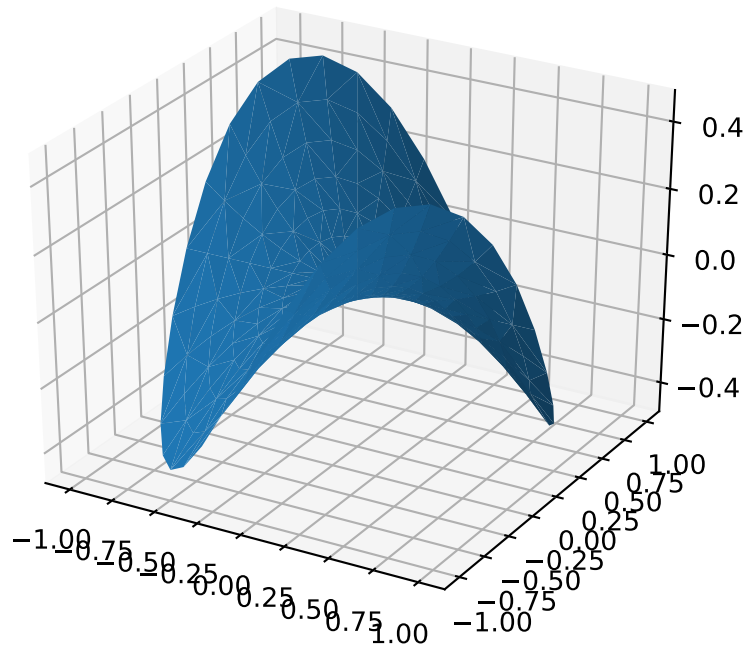

70.1.7 Contour plots

`Axes3D.contour(X, Y, Z, *args, **kwargs)`

Create a 3D contour plot.

Argument	Description
<code>X, Y, Z</code>	Data values as <code>numpy.array</code> s
<code>extend3d</code>	Whether to extend contour in 3D (default: <code>False</code>)
<code>stride</code>	Stride (step size) for extending contour
<code>zdir</code>	The direction to use: <code>x</code> , <code>y</code> or <code>z</code> (default)
<code>offset</code>	If specified plot a projection of the contour lines on this position in plane normal to <code>zdir</code>

The positional and other keyword arguments are passed on to `contour()`

Returns a `contour`

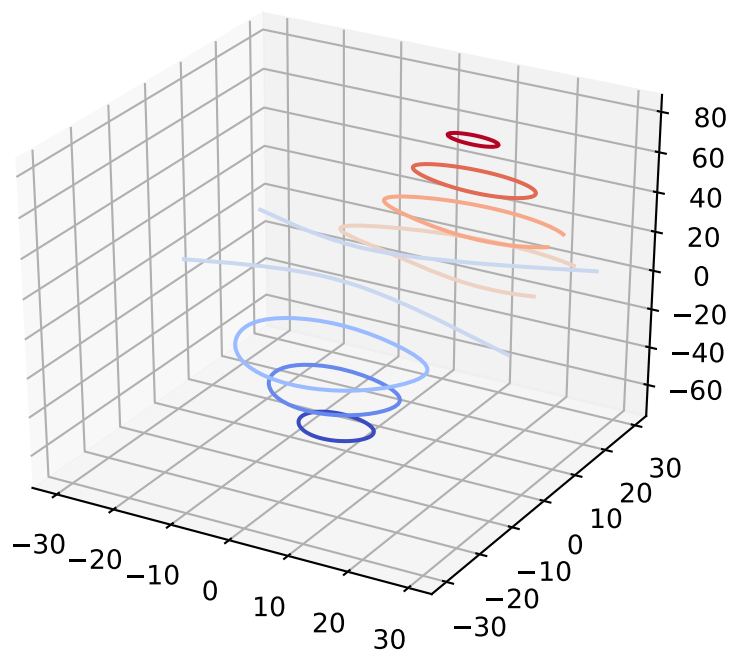

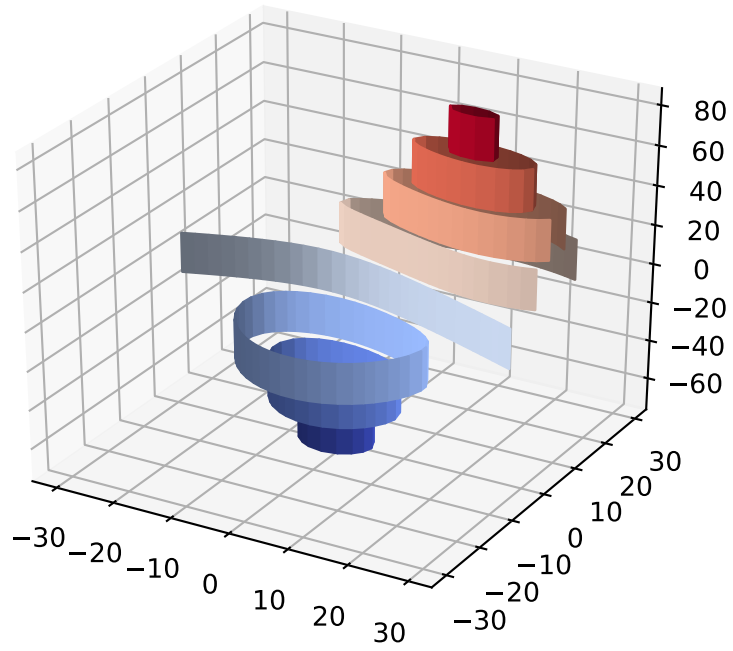

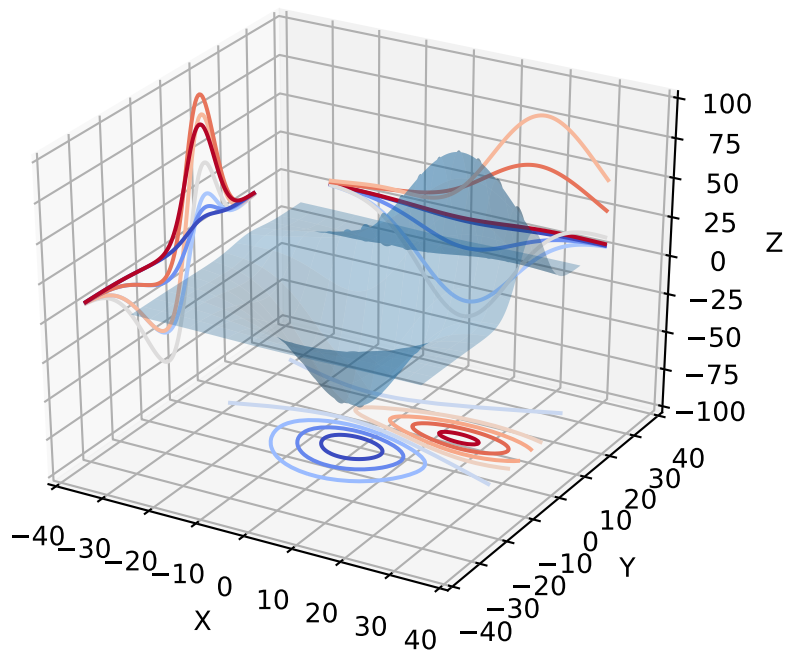

70.1.8 Filled contour plots

`Axes3D.contourf(X, Y, Z, *args, **kwargs)`

Create a 3D contourf plot.

Argument	Description
$X, Y,$	Data values as <code>numpy.array</code> s
Z	
<i>zdir</i>	The direction to use: x, y or z (default)
<i>offset</i>	If specified plot a projection of the filled contour on this position in plane normal to <i>zdir</i>

The positional and keyword arguments are passed on to `contourf()`

Returns a `contourf`

Changed in version 1.1.0: The *zdir* and *offset* kwargs were added.

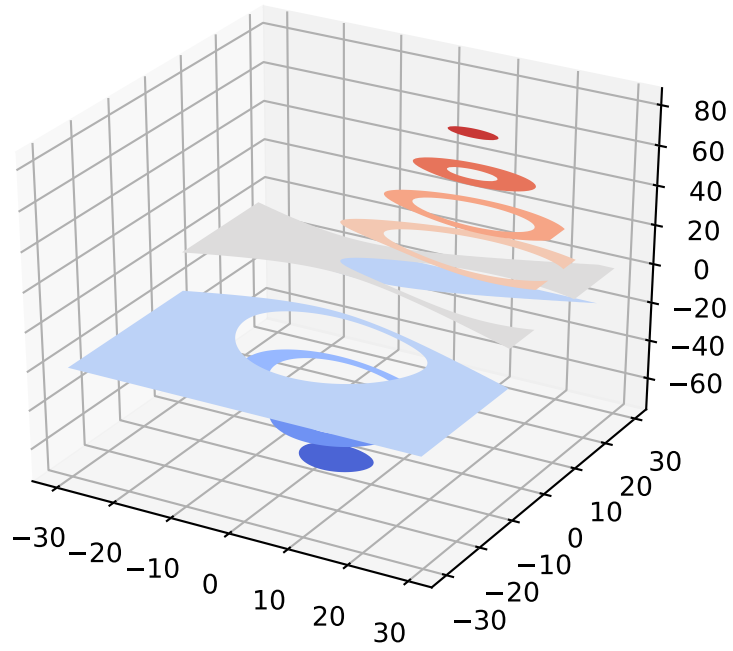

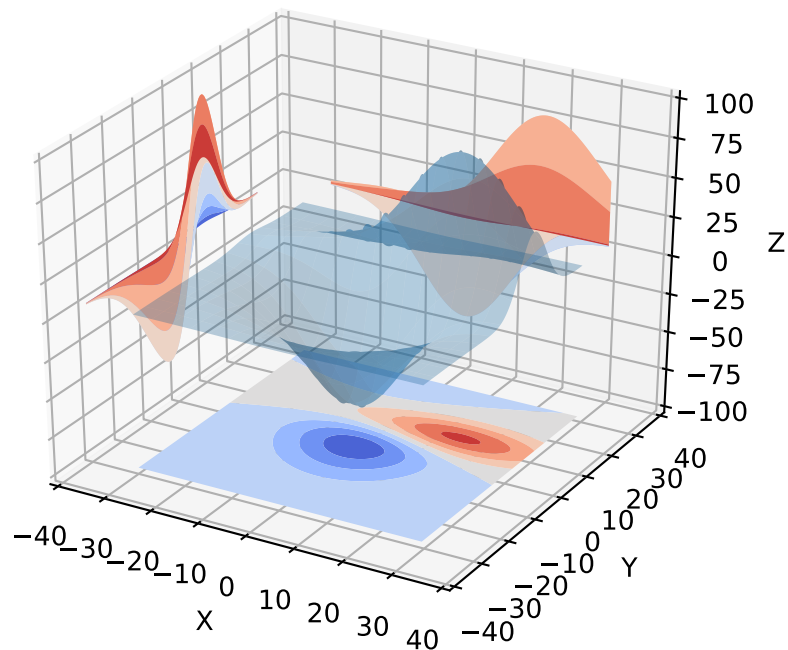

New in version 1.1.0: The feature demoed in the second `contourf3d` example was enabled as a result of a bugfix for version 1.1.0.

70.1.9 Polygon plots

`Axes3D.add_collection3d(col, zs=0, zdir='z')`

Add a 3D collection object to the plot.

2D collection types are converted to a 3D version by modifying the object and adding z coordinate information.

Supported are:

- PolyCollection
- LineColleciton
- PatchCollection

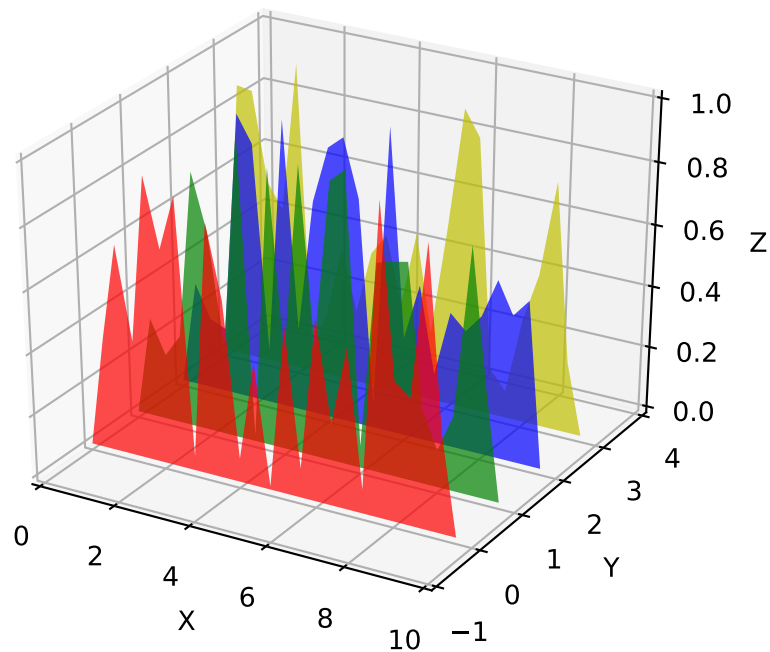

70.1.10 Bar plots

`Axes3D.bar(left, height, zs=0, zdir='z', *args, **kwargs)`

Add 2D bar(s).

Argument	Description
<i>left</i>	The x coordinates of the left sides of the bars.
<i>height</i>	The height of the bars.
<i>zs</i>	Z coordinate of bars, if one value is specified they will all be placed at the same z.
<i>zdir</i>	Which direction to use as z ('x', 'y' or 'z') when plotting a 2D set.

Keyword arguments are passed onto `bar()`.

Returns a `Patch3DCollection`

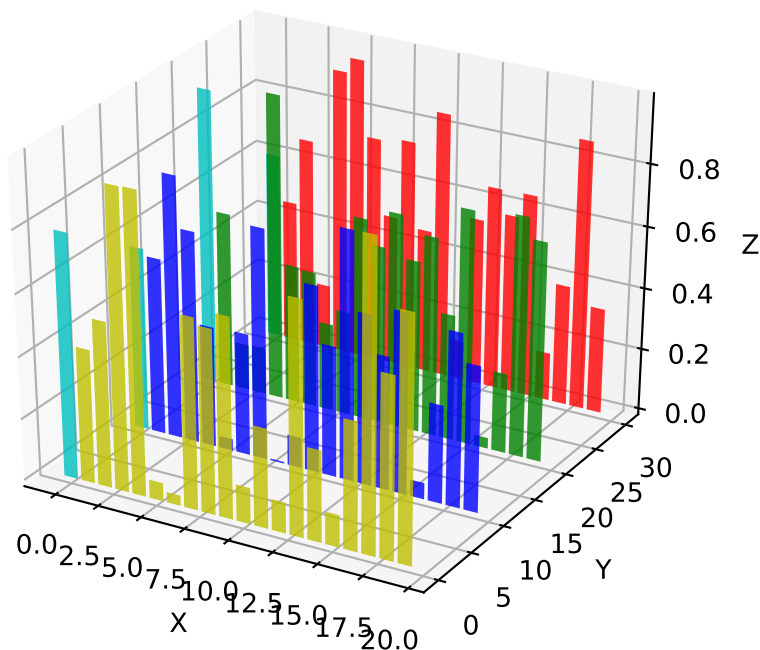

70.1.11 Quiver

`Axes3D.quiver(*args, **kwargs)`

Plot a 3D field of arrows.

call signatures:

```
quiver(X, Y, Z, U, V, W, **kwargs)
```

Arguments:

X, Y, Z: The x, y and z coordinates of the arrow locations (default is tail of arrow; see *pivot* kwarg)

U, V, W: The x, y and z components of the arrow vectors

The arguments could be array-like or scalars, so long as they they can be broadcast together. The arguments can also be masked arrays. If an element in any of argument is masked, then that corresponding quiver element will not be plotted.

Keyword arguments:

length: [**1.0** | **float**] The length of each quiver, default to 1.0, the unit is the same with the axes

arrow_length_ratio: [0.3 | float] The ratio of the arrow head with respect to the quiver, default to 0.3

pivot: ['tail' | 'middle' | 'tip'] The part of the arrow that is at the grid point; the arrow rotates about this point, hence the name *pivot*. Default is 'tail'

normalize: [False | True] When True, all of the arrows will be the same length. This defaults to False, where the arrows will be different lengths depending on the values of u,v,w.

Any additional keyword arguments are delegated to *LineCollection*

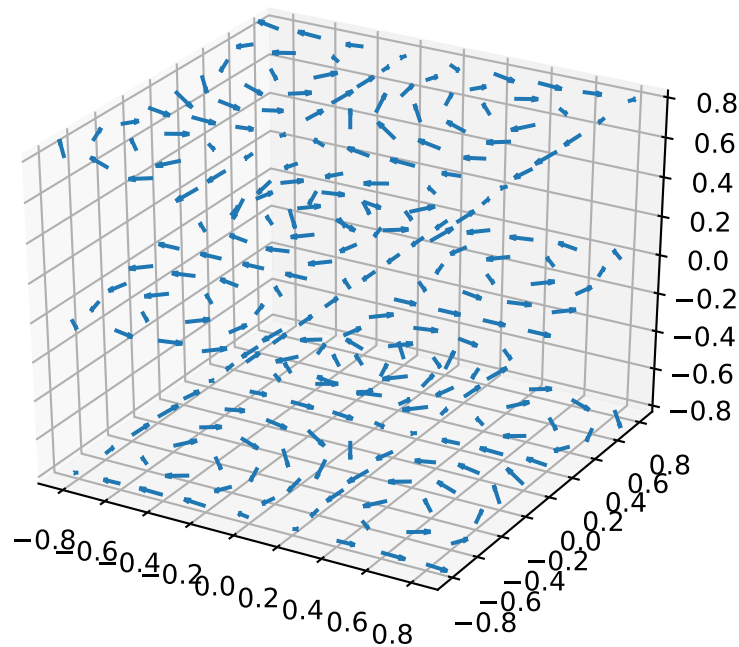

70.1.12 2D plots in 3D

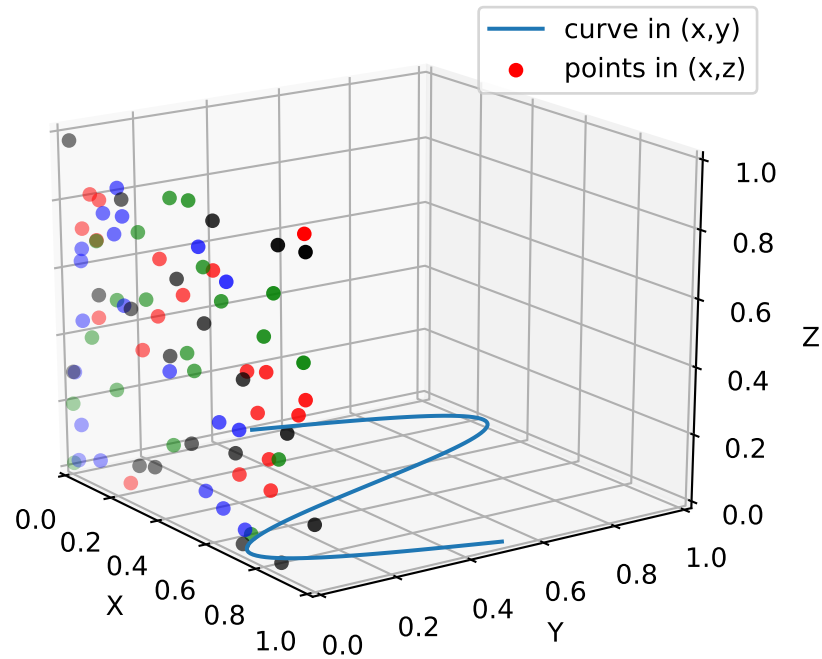

70.1.13 Text

`Axes3D.text(x, y, z, s, zdir=None, **kwargs)`

Add text to the plot. `kwargs` will be passed on to `Axes.text`, except for the `zdir` keyword, which sets the direction to be used as the `z` direction.

2D Text

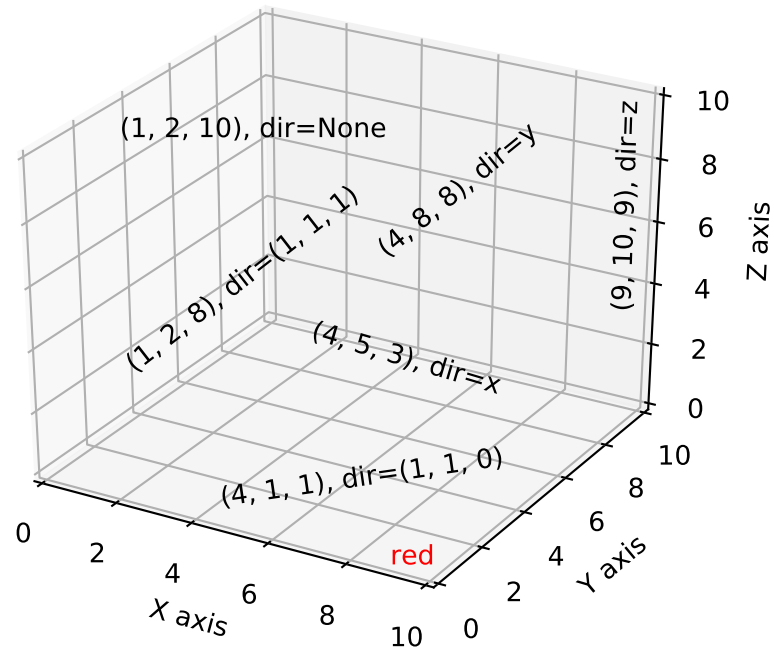

70.1.14 Subplotting

Having multiple 3D plots in a single figure is the same as it is for 2D plots. Also, you can have both 2D and 3D plots in the same figure.

New in version 1.0.0: Subplotting 3D plots was added in v1.0.0. Earlier version can not do this.

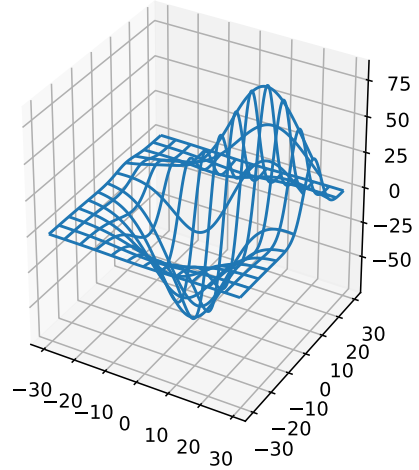
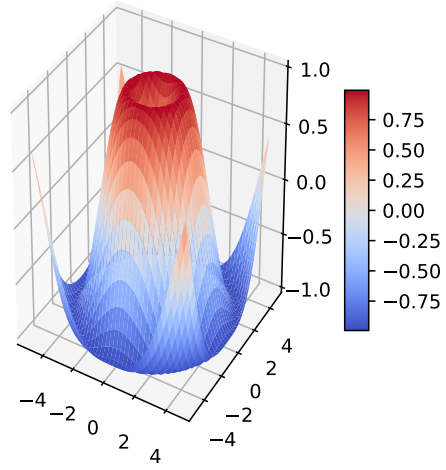

A tale of 2 subplots

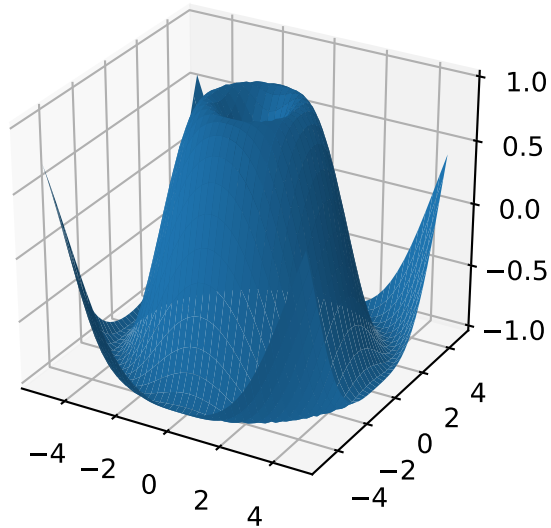
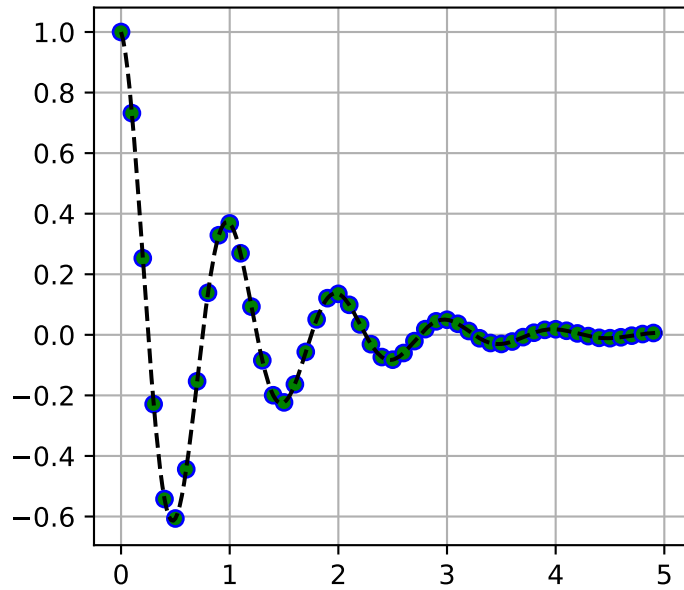

70.2 mplot3d API

Contents

- *mplot3d API*
 - axes3d
 - axis3d
 - art3d
 - proj3d

70.2.1 axes3d

Note: Significant effort went into bringing axes3d to feature-parity with regular axes objects for version 1.1.0. However, more work remains. Please report any functions that do not behave as expected as a bug. In addition, help and patches would be greatly appreciated!

Module containing Axes3D, an object which can plot 3D objects on a 2D matplotlib figure.

class `mpl_toolkits.mplot3d.axes3d.Axes3D`(*fig, rect=None, *args, **kwargs*)

Bases: `matplotlib.axes._axes.Axes`

3D axes object.

add_collection3d(*col, zs=0, zdir='z'*)

Add a 3D collection object to the plot.

2D collection types are converted to a 3D version by modifying the object and adding z coordinate information.

Supported are:

- PolyCollection
- LineColleciton
- PatchCollection

add_contour_set(*cset, extend3d=False, stride=5, zdir='z', offset=None*)

add_contourf_set(*cset, zdir='z', offset=None*)

auto_scale_xyz(*X, Y, Z=None, had_data=None*)

autoscale(*enable=True, axis='both', tight=None*)

Convenience method for simple axis view autoscaling. See `matplotlib.axes.Axes.autoscale()` for full explanation. Note that this function behaves the same, but for all three axes. Therefore, 'z' can be passed for *axis*, and 'both' applies to all three axes.

New in version 1.1.0: This function was added, but not tested. Please report any bugs.

autoscale_view(*tight=None, scalex=True, scaley=True, scalez=True*)

Autoscale the view limits using the data limits. See [matplotlib.axes.Axes.autoscale_view\(\)](#) for documentation. Note that this function applies to the 3D axes, and as such adds the *scalez* to the function arguments.

Changed in version 1.1.0: Function signature was changed to better match the 2D version. *tight* is now explicitly a kwarg and placed first.

Changed in version 1.2.1: This is now fully functional.

bar(*left, height, zs=0, zdir='z', *args, **kwargs*)

Add 2D bar(s).

Argument	Description
<i>left</i>	The x coordinates of the left sides of the bars.
<i>height</i>	The height of the bars.
<i>zs</i>	Z coordinate of bars, if one value is specified they will all be placed at the same z.
<i>zdir</i>	Which direction to use as z ('x', 'y' or 'z') when plotting a 2D set.

Keyword arguments are passed onto [bar\(\)](#).

Returns a [Patch3DCollection](#)

bar3d(*x, y, z, dx, dy, dz, color=None, zsort='average', *args, **kwargs*)

Generate a 3D bar, or multiple bars.

When generating multiple bars, x, y, z have to be arrays. dx, dy, dz can be arrays or scalars.

color can be:

- A single color value, to color all bars the same color.
- An array of colors of length N bars, to color each bar independently.
- An array of colors of length 6, to color the faces of the bars similarly.
- An array of colors of length 6 * N bars, to color each face independently.

When coloring the faces of the boxes specifically, this is the order of the coloring:

- 1.-Z (bottom of box)
- 2.+Z (top of box)
- 3.-Y
- 4.+Y
- 5.-X
- 6.+X

Keyword arguments are passed onto [Poly3DCollection\(\)](#)

can_pan()

Return *True* if this axes supports the pan/zoom button functionality.

3D axes objects do not use the pan/zoom button.

can_zoom()

Return *True* if this axes supports the zoom box button functionality.

3D axes objects do not use the zoom box button.

cla()

Clear axes

clabel(*args, **kwargs)

This function is currently not implemented for 3D axes. Returns *None*.

contour(X, Y, Z, *args, **kwargs)

Create a 3D contour plot.

Argument	Description
X, Y, Z	Data values as numpy.arrays
<i>extend3d</i>	Whether to extend contour in 3D (default: False)
<i>stride</i>	Stride (step size) for extending contour
<i>zdir</i>	The direction to use: x, y or z (default)
<i>offset</i>	If specified plot a projection of the contour lines on this position in plane normal to zdir

The positional and other keyword arguments are passed on to `contour()`

Returns a *contour*

contour3D(X, Y, Z, *args, **kwargs)

Create a 3D contour plot.

Argument	Description
X, Y, Z	Data values as numpy.arrays
<i>extend3d</i>	Whether to extend contour in 3D (default: False)
<i>stride</i>	Stride (step size) for extending contour
<i>zdir</i>	The direction to use: x, y or z (default)
<i>offset</i>	If specified plot a projection of the contour lines on this position in plane normal to zdir

The positional and other keyword arguments are passed on to `contour()`

Returns a *contour*

contourf(X, Y, Z, *args, **kwargs)

Create a 3D contourf plot.

Argument	Description
$X, Y,$	Data values as <code>numpy.array</code> s
Z	
<i>zdir</i>	The direction to use: x, y or z (default)
<i>offset</i>	If specified plot a projection of the filled contour on this position in plane normal to <i>zdir</i>

The positional and keyword arguments are passed on to `contourf()`

Returns a `contourf`

Changed in version 1.1.0: The *zdir* and *offset* kwargs were added.

contourf3D($X, Y, Z, *args, **kwargs$)

Create a 3D contourf plot.

Argument	Description
$X, Y,$	Data values as <code>numpy.array</code> s
Z	
<i>zdir</i>	The direction to use: x, y or z (default)
<i>offset</i>	If specified plot a projection of the filled contour on this position in plane normal to <i>zdir</i>

The positional and keyword arguments are passed on to `contourf()`

Returns a `contourf`

Changed in version 1.1.0: The *zdir* and *offset* kwargs were added.

convert_zunits(z)

For artists in an axes, if the zaxis has units support, convert z using zaxis unit type

New in version 1.2.1.

disable_mouse_rotation()

Disable mouse button callbacks.

draw(*renderer*)

format_coord(xd, yd)

Given the 2D view coordinates attempt to guess a 3D coordinate. Looks for the nearest edge to the point and then assumes that the point is at the same z location as the nearest point on the edge.

format_zdata(z)

Return z string formatted. This function will use the `fmt_zdata` attribute if it is callable, else will fall back on the zaxis major formatter

get_autoscale_on()

Get whether autoscaling is applied for all axes on plot commands

New in version 1.1.0: This function was added, but not tested. Please report any bugs.

get_autoscalez_on()

Get whether autoscaling for the z-axis is applied on plot commands

New in version 1.1.0: This function was added, but not tested. Please report any bugs.

get_axis_position()

get_axisbelow()

Get whether axis below is true or not.

For axes3d objects, this will always be *True*

New in version 1.1.0: This function was added for completeness.

get_children()

get_frame_on()

Get whether the 3D axes panels are drawn

New in version 1.1.0.

get_proj()

Create the projection matrix from the current viewing position.

elev stores the elevation angle in the z plane azimuth stores the azimuth angle in the x,y plane

dist is the distance of the eye viewing point from the object point.

get_w_lims()

Get 3D world limits.

get_xlim()

Get the x-axis range

Returns xlimits : tuple

Returns the current x-axis limits as the tuple (left, right).

Notes

The x-axis may be inverted, in which case the left value will be greater than the right value.

Changed in version 1.1.0: This function now correctly refers to the 3D x-limits

get_xlim3d()

Get the x-axis range

Returns xlimits : tuple

Returns the current x-axis limits as the tuple (left, right).

Notes

The x-axis may be inverted, in which case the `left` value will be greater than the `right` value.

Changed in version 1.1.0: This function now correctly refers to the 3D x-limits

get_ylim()

Get the y-axis range

Returns ylims : tuple

Returns the current y-axis limits as the tuple (`bottom`, `top`).

Notes

The y-axis may be inverted, in which case the `bottom` value will be greater than the `top` value.

Changed in version 1.1.0: This function now correctly refers to the 3D y-limits.

get_ylim3d()

Get the y-axis range

Returns ylims : tuple

Returns the current y-axis limits as the tuple (`bottom`, `top`).

Notes

The y-axis may be inverted, in which case the `bottom` value will be greater than the `top` value.

Changed in version 1.1.0: This function now correctly refers to the 3D y-limits.

get_zbound()

Returns the z-axis numerical bounds where:

<code>lowerBound < upperBound</code>

New in version 1.1.0: This function was added, but not tested. Please report any bugs.

get_zlabel()

Get the z-label text string.

New in version 1.1.0: This function was added, but not tested. Please report any bugs.

get_zlim()

Get 3D z limits.

get_zlim3d()

Get 3D z limits.

get_zmajorticklabels()

Get the ztick labels as a list of Text instances

New in version 1.1.0.

get_zminorticklabels()

Get the ztick labels as a list of Text instances

Note: Minor ticks are not supported. This function was added only for completeness.

New in version 1.1.0.

get_zscale()

get_zticklabels(*minor=False*)

Get ztick labels as a list of Text instances. See `matplotlib.axes.Axes.get_yticklabels()` for more details.

Note: Minor ticks are not supported.

New in version 1.1.0.

get_zticklines()

Get ztick lines as a list of Line2D instances. Note that this function is provided merely for completeness. These lines are re-calculated as the display changes.

New in version 1.1.0.

get_zticks(*minor=False*)

Return the z ticks as a list of locations See `matplotlib.axes.Axes.get_yticks()` for more details.

Note: Minor ticks are not supported.

New in version 1.1.0.

grid(*b=True, **kwargs*)

Set / unset 3D grid.

Note: Currently, this function does not behave the same as `matplotlib.axes.Axes.grid()`, but it is intended to eventually support that behavior.

Changed in version 1.1.0: This function was changed, but not tested. Please report any bugs.

have_units()

Return `True` if units are set on the *x*, *y*, or *z* axes

invert_zaxis()

Invert the *z*-axis.

New in version 1.1.0: This function was added, but not tested. Please report any bugs.

locator_params(*axis='both', tight=None, **kwargs*)

Convenience method for controlling tick locators.

See `matplotlib.axes.Axes.locator_params()` for full documentation. Note that this is for Axes3D objects, therefore, setting *axis* to 'both' will result in the parameters being set for all three axes. Also, *axis* can also take a value of 'z' to apply parameters to the z axis.

New in version 1.1.0: This function was added, but not tested. Please report any bugs.

margins(*args, **kw)

Convenience method to set or retrieve autoscaling margins.

signatures:: margins()

returns xmargin, ymargin, zmargin

```
margins(margin)

margins(xmargin, ymargin, zmargin)

margins(x=xmargin, y=ymargin, z=zmargin)

margins(..., tight=False)
```

All forms above set the xmargin, ymargin and zmargin parameters. All keyword parameters are optional. A single argument specifies xmargin, ymargin and zmargin. The *tight* parameter is passed to `autoscale_view()`, which is executed after a margin is changed; the default here is *True*, on the assumption that when margins are specified, no additional padding to match tick marks is usually desired. Setting *tight* to *None* will preserve the previous setting.

Specifying any margin changes only the autoscaling; for example, if *xmargin* is not *None*, then *xmargin* times the X data interval will be added to each end of that interval before it is used in autoscaling.

New in version 1.1.0: This function was added, but not tested. Please report any bugs.

mouse_init(*rotate_btn=1, zoom_btn=3*)

Initializes mouse button callbacks to enable 3D rotation of the axes. Also optionally sets the mouse buttons for 3D rotation and zooming.

Argument	Description
<i>rotate_btn</i>	The integer or list of integers specifying which mouse button or buttons to use for 3D rotation of the axes. Default = 1.
<i>zoom_btn</i>	The integer or list of integers specifying which mouse button or buttons to use to zoom the 3D axes. Default = 3.

name = '3d'

plot(*xs, ys, *args, **kwargs*)

Plot 2D or 3D data.

Argument	Description
<i>xs, ys</i>	x, y coordinates of vertices
<i>zs</i>	z value(s), either one for all points or one for each point.
<i>zdir</i>	Which direction to use as z ('x', 'y' or 'z') when plotting a 2D set.

Other arguments are passed on to `plot()`

plot3D(*xs, ys, *args, **kwargs*)

Plot 2D or 3D data.

Argument	Description
<i>xs, ys</i>	x, y coordinates of vertices
<i>zs</i>	z value(s), either one for all points or one for each point.
<i>zdir</i>	Which direction to use as z ('x', 'y' or 'z') when plotting a 2D set.

Other arguments are passed on to `plot()`

plot_surface(*X, Y, Z, *args, **kwargs*)

Create a surface plot.

By default it will be colored in shades of a solid color, but it also supports color mapping by supplying the `cmap` argument.

The `rstride` and `cstride` kwargs set the stride used to sample the input data to generate the graph. If 1k by 1k arrays are passed in, the default values for the strides will result in a 100x100 grid being plotted. Defaults to 10. Raises a `ValueError` if both stride and count kwargs (see next section) are provided.

The `rcount` and `ccount` kwargs supersedes `rstride` and `cstride` for default sampling method for surface plotting. These arguments will determine at most how many evenly spaced samples will be taken from the input data to generate the graph. This is the default sampling method unless using the 'classic' style. Will raise `ValueError` if both stride and count are specified. Added in v2.0.0.

Argument	Description
<i>X, Y, Z</i>	Data values as 2D arrays
<i>rstride</i>	Array row stride (step size)
<i>cstride</i>	Array column stride (step size)
<i>rcount</i>	Use at most this many rows, defaults to 50
<i>ccount</i>	Use at most this many columns, defaults to 50
<i>color</i>	Color of the surface patches
<i>cmap</i>	A colormap for the surface patches.
<i>facecolors</i>	Face colors for the individual patches
<i>norm</i>	An instance of <code>Normalize</code> to map values to colors
<i>vmin</i>	Minimum value to map
<i>vmax</i>	Maximum value to map
<i>shade</i>	Whether to shade the facecolors

Other arguments are passed on to `Poly3DCollection`

plot_trisurf(**args, **kwargs*)

Argument	Description
<i>X, Y, Z</i>	Data values as 1D arrays
<i>color</i>	Color of the surface patches
<i>cmap</i>	A colormap for the surface patches.
<i>norm</i>	An instance of Normalize to map values to colors
<i>vmin</i>	Minimum value to map
<i>vmax</i>	Maximum value to map
<i>shade</i>	Whether to shade the facecolors

The (optional) triangulation can be specified in one of two ways; either:

```
plot_trisurf(triangulation, ...)
```

where triangulation is a *Triangulation* object, or:

```
plot_trisurf(X, Y, ...)
plot_trisurf(X, Y, triangles, ...)
plot_trisurf(X, Y, triangles=triangles, ...)
```

in which case a Triangulation object will be created. See *Triangulation* for a explanation of these possibilities.

The remaining arguments are:

```
plot_trisurf(..., Z)
```

where *Z* is the array of values to contour, one per point in the triangulation.

Other arguments are passed on to *Poly3DCollection*

Examples:

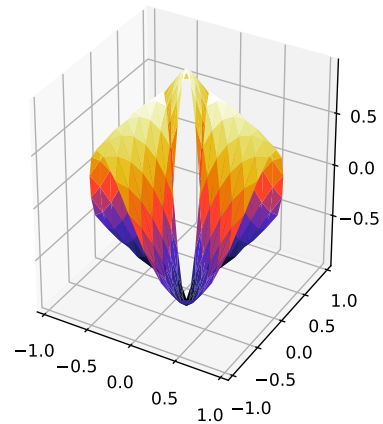
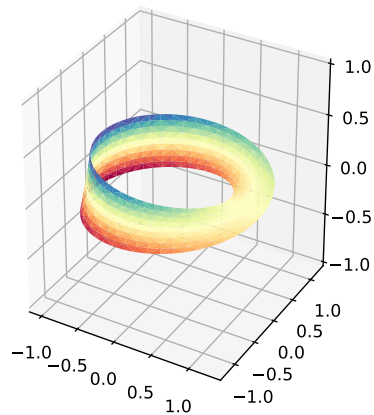
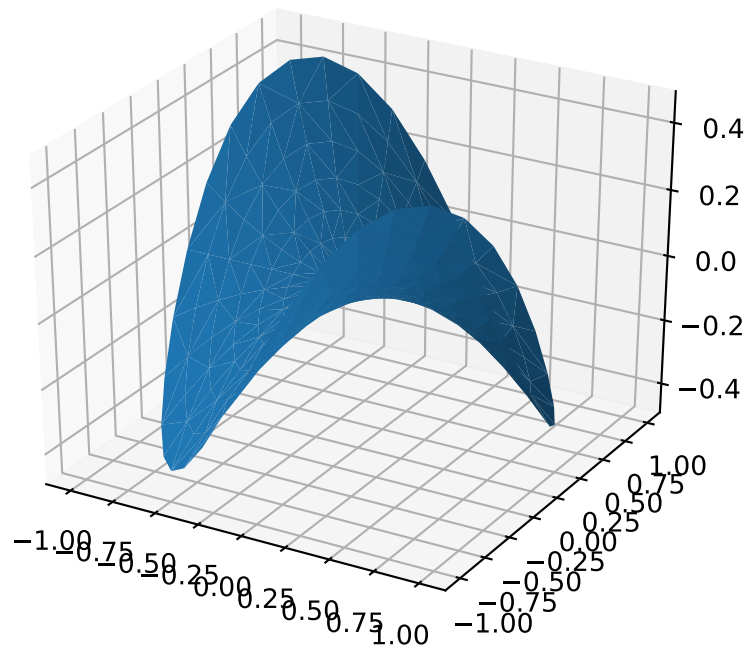

New in version 1.2.0: This plotting function was added for the v1.2.0 release.

`plot_wireframe(X, Y, Z, *args, **kwargs)`

Plot a 3D wireframe.

The `rstride` and `cstride` kwargs set the stride used to sample the input data to

generate the graph. If either is 0 the input data is not sampled along this direction producing a 3D line plot rather than a wireframe plot. The stride arguments are only used by default if in the ‘classic’ mode. They are now superseded by `rcount` and `ccount`. Will raise `ValueError` if both stride and count are used.

- ‘The `rcount` and `ccount` kwargs supersedes `rstride` and `cstride` for default sampling method for wireframe plotting. These arguments will determine at most how many evenly spaced samples will be taken from the input data to generate the graph. This is the default sampling method unless using the ‘classic’ style. Will raise `ValueError` if both stride and count are specified. If either is zero, then the input data is not sampled along this direction, producing a 3D line plot rather than a wireframe plot. Added in v2.0.0.

Argument	Description
<code>X, Y,</code>	Data values as 2D arrays
<code>Z</code>	
<code>rstride</code>	Array row stride (step size), defaults to 1
<code>cstride</code>	Array column stride (step size), defaults to 1
<code>rcount</code>	Use at most this many rows, defaults to 50
<code>ccount</code>	Use at most this many columns, defaults to 50

Keyword arguments are passed on to `LineCollection`.

Returns a `Line3DCollection`

quiver(*args, **kwargs)

Plot a 3D field of arrows.

call signatures:

```
quiver(X, Y, Z, U, V, W, **kwargs)
```

Arguments:

X, Y, Z: The x, y and z coordinates of the arrow locations (default is tail of arrow; see `pivot` kwarg)

U, V, W: The x, y and z components of the arrow vectors

The arguments could be array-like or scalars, so long as they they can be broadcast together. The arguments can also be masked arrays. If an element in any of argument is masked, then that corresponding quiver element will not be plotted.

Keyword arguments:

length: [**1.0** | **float**] The length of each quiver, default to 1.0, the unit is the same with the axes

arrow_length_ratio: [**0.3** | **float**] The ratio of the arrow head with respect to the quiver, default to 0.3

pivot: [‘tail’ | ‘middle’ | ‘tip’] The part of the arrow that is at the grid point; the arrow rotates about this point, hence the name `pivot`. Default is ‘tail’

normalize: [**False** | **True**] When True, all of the arrows will be the same length. This defaults to False, where the arrows will be different lengths depending on the values of u,v,w.

Any additional keyword arguments are delegated to *LineCollection*

quiver3D(*args, **kwargs)

Plot a 3D field of arrows.

call signatures:

```
quiver(X, Y, Z, U, V, W, **kwargs)
```

Arguments:

X, Y, Z: The x, y and z coordinates of the arrow locations (default is tail of arrow; see *pivot* kwarg)

U, V, W: The x, y and z components of the arrow vectors

The arguments could be array-like or scalars, so long as they they can be broadcast together. The arguments can also be masked arrays. If an element in any of argument is masked, then that corresponding quiver element will not be plotted.

Keyword arguments:

length: [**1.0** | **float**] The length of each quiver, default to 1.0, the unit is the same with the axes

arrow_length_ratio: [**0.3** | **float**] The ratio of the arrow head with respect to the quiver, default to 0.3

pivot: [**'tail'** | **'middle'** | **'tip'**] The part of the arrow that is at the grid point; the arrow rotates about this point, hence the name *pivot*. Default is 'tail'

normalize: [**False** | **True**] When True, all of the arrows will be the same length. This defaults to False, where the arrows will be different lengths depending on the values of u,v,w.

Any additional keyword arguments are delegated to *LineCollection*

scatter(xs, ys, zs=0, zdir='z', s=20, c=None, depthshade=True, *args, **kwargs)

Create a scatter plot.

Argument	Description
<i>xs, ys</i>	Positions of data points.
<i>zs</i>	Either an array of the same length as <i>xs</i> and <i>ys</i> or a single value to place all points in the same plane. Default is 0.
<i>zdir</i>	Which direction to use as z ('x', 'y' or 'z') when plotting a 2D set.
<i>s</i>	Size in points ² . It is a scalar or an array of the same length as <i>x</i> and <i>y</i> .
<i>c</i>	A color. <i>c</i> can be a single color format string, or a sequence of color specifications of length <i>N</i> , or a sequence of <i>N</i> numbers to be mapped to colors using the <i>cmap</i> and <i>norm</i> specified via <i>kwargs</i> (see below). Note that <i>c</i> should not be a single numeric RGB or RGBA sequence because that is indistinguishable from an array of values to be colormapped. <i>c</i> can be a 2-D array in which the rows are RGB or RGBA, however, including the case of a single row to specify the same color for all points.
<i>depthshade</i>	Whether or not to shade the scatter markers to give the appearance of depth. Default is <i>True</i> .

Keyword arguments are passed on to `scatter()`.

Returns a `Patch3DCollection`

scatter3D(*xs, ys, zs=0, zdir='z', s=20, c=None, depthshade=True, *args, **kwargs*)

Create a scatter plot.

Argument	Description
<i>xs, ys</i>	Positions of data points.
<i>zs</i>	Either an array of the same length as <i>xs</i> and <i>ys</i> or a single value to place all points in the same plane. Default is 0.
<i>zdir</i>	Which direction to use as z ('x', 'y' or 'z') when plotting a 2D set.
<i>s</i>	Size in points ² . It is a scalar or an array of the same length as <i>x</i> and <i>y</i> .
<i>c</i>	A color. <i>c</i> can be a single color format string, or a sequence of color specifications of length <i>N</i> , or a sequence of <i>N</i> numbers to be mapped to colors using the <i>cmap</i> and <i>norm</i> specified via <i>kwargs</i> (see below). Note that <i>c</i> should not be a single numeric RGB or RGBA sequence because that is indistinguishable from an array of values to be colormapped. <i>c</i> can be a 2-D array in which the rows are RGB or RGBA, however, including the case of a single row to specify the same color for all points.
<i>depthshade</i>	Whether or not to shade the scatter markers to give the appearance of depth. Default is <i>True</i> .

Keyword arguments are passed on to `scatter()`.

Returns a `Patch3DCollection`

set_autoscale_on(*b*)

Set whether autoscaling is applied on plot commands

accepts: [*True* | *False*]

New in version 1.1.0: This function was added, but not tested. Please report any bugs.

set_autoscalez_on(*b*)

Set whether autoscaling for the z-axis is applied on plot commands

accepts: [*True* | *False*]

New in version 1.1.0: This function was added, but not tested. Please report any bugs.

set_axis_off()

set_axis_on()

set_axisbelow(*b*)

Set whether the axis ticks and gridlines are above or below most artists

For axes3d objects, this will ignore any settings and just use *True*

ACCEPTS: [*True* | *False*]

New in version 1.1.0: This function was added for completeness.

set_frame_on(*b*)

Set whether the 3D axes panels are drawn

ACCEPTS: [*True* | *False*]

New in version 1.1.0.

set_title(*label*, *fontdict*=None, *loc*='center', *kwargs*)**

Set a title for the axes.

Set one of the three available axes titles. The available titles are positioned above the axes in the center, flush with the left edge, and flush with the right edge.

Parameters *label* : str

Text to use for the title

fontdict : dict

A dictionary controlling the appearance of the title text, the default *fontdict* is:

```
{'fontsize': rcParams['axes.titlesize'],
 'fontweight' : rcParams['axes.titleweight'],
 'verticalalignment': 'baseline',
 'horizontalalignment': loc}
```

loc : { 'center', 'left', 'right' }, str, optional

Which title to set, defaults to 'center'

Returns text : *Text*

The matplotlib text instance representing the title

Other Parameters *kwargs* : text properties

Other keyword arguments are text properties, see *Text* for a list of valid text properties.

set_top_view()

set_xlim(*left=None, right=None, emit=True, auto=False, **kw*)

Set 3D x limits.

See `matplotlib.axes.Axes.set_xlim()` for full documentation.

set_xlim3d(*left=None, right=None, emit=True, auto=False, **kw*)

Set 3D x limits.

See `matplotlib.axes.Axes.set_xlim()` for full documentation.

set_xscale(*value, **kwargs*)

Set the x-axis scale

Set the scaling of the x-axis: 'linear' | 'log' | 'logit' | 'symlog'

ACCEPTS: ['linear' | 'log' | 'logit' | 'symlog']

Different kwargs are accepted, depending on the scale: 'linear'

'log'

basex/basey: The base of the logarithm

nonposx/nonposy: ['mask' | 'clip'] non-positive values in *x* or *y* can be masked as invalid, or clipped to a very small positive number

subsx/subsy: Where to place the subticks between each major tick. Should be a sequence of integers. For example, in a log10 scale: [2, 3, 4, 5, 6, 7, 8, 9]

will place 8 logarithmically spaced minor ticks between each major tick.

'logit'

nonpos: ['mask' | 'clip'] values beyond]0, 1[can be masked as invalid, or clipped to a number very close to 0 or 1

'symlog'

basex/basey: The base of the logarithm

linthreshx/linthreshy: The range (*-x, x*) within which the plot is linear (to avoid having the plot go to infinity around zero).

subsx/subsy: Where to place the subticks between each major tick. Should be a sequence of integers. For example, in a log10 scale: [2, 3, 4, 5, 6, 7, 8, 9]

will place 8 logarithmically spaced minor ticks between each major tick.

linscalex/linscaley: This allows the linear range (*-linthresh* to *linthresh*) to be stretched relative to the logarithmic range. Its value is the number of decades to use for each half of the linear range. For example, when *linscale* == 1.0 (the default), the space used for the positive and negative halves of the linear range will be equal to one decade in the logarithmic range.

New in version 1.1.0: This function was added, but not tested. Please report any bugs.

set_ylim(*bottom=None, top=None, emit=True, auto=False, **kw*)

Set 3D y limits.

See `matplotlib.axes.Axes.set_ylim()` for full documentation.

set_ylim3d(*bottom=None, top=None, emit=True, auto=False, **kw*)

Set 3D y limits.

See `matplotlib.axes.Axes.set_ylim()` for full documentation.

set_yscale(*value, **kwargs*)

Set the y-axis scale

Set the scaling of the y-axis: ‘linear’ | ‘log’ | ‘logit’ | ‘symlog’

ACCEPTS: [‘linear’ | ‘log’ | ‘logit’ | ‘symlog’]

Different kwargs are accepted, depending on the scale: ‘linear’

‘log’

basex/basey: The base of the logarithm

nonposx/nonposy: [‘mask’ | ‘clip’] non-positive values in *x* or *y* can be masked as invalid, or clipped to a very small positive number

subsx/subsy: Where to place the subticks between each major tick. Should be a sequence of integers. For example, in a log10 scale: [2, 3, 4, 5, 6, 7, 8, 9]

will place 8 logarithmically spaced minor ticks between each major tick.

‘logit’

nonpos: [‘mask’ | ‘clip’] values beyond]0, 1[can be masked as invalid, or clipped to a number very close to 0 or 1

‘symlog’

basex/basey: The base of the logarithm

linthreshx/linthreshy: The range $(-x, x)$ within which the plot is linear (to avoid having the plot go to infinity around zero).

subsx/subsy: Where to place the subticks between each major tick. Should be a sequence of integers. For example, in a log10 scale: [2, 3, 4, 5, 6, 7, 8, 9]

will place 8 logarithmically spaced minor ticks between each major tick.

linscalex/linscaley: This allows the linear range $(-linthresh$ to $linthresh)$ to be stretched relative to the logarithmic range. Its value is the number of decades to use for each half of the linear range. For example, when `linscale == 1.0` (the default), the space used for the positive and negative halves of the linear range will be equal to one decade in the logarithmic range.

New in version 1.1.0: This function was added, but not tested. Please report any bugs.

set_zbound(*lower=None, upper=None*)

Set the lower and upper numerical bounds of the z-axis. This method will honor axes inversion regardless of parameter order. It will not change the `_autoscaleZon` attribute.

New in version 1.1.0: This function was added, but not tested. Please report any bugs.

set_zlabel(*zlabel, fontdict=None, labelpad=None, **kwargs*)

Set zlabel. See doc for `set_ylabel()` for description.

set_zlim(*bottom=None, top=None, emit=True, auto=False, **kw*)

Set 3D z limits.

See `matplotlib.axes.Axes.set_ylim()` for full documentation

set_zlim3d(*bottom=None, top=None, emit=True, auto=False, **kw*)

Set 3D z limits.

See `matplotlib.axes.Axes.set_ylim()` for full documentation

set_zmargin(*m*)

Set padding of Z data limits prior to autoscaling.

m times the data interval will be added to each end of that interval before it is used in autoscaling.

accepts: float in range 0 to 1

New in version 1.1.0: This function was added, but not tested. Please report any bugs.

set_zscale(*value, **kwargs*)

Set the scaling of the z-axis: 'linear' | 'log' | 'logit' | 'symlog'

ACCEPTS: ['linear' | 'log' | 'logit' | 'symlog']

Different kwargs are accepted, depending on the scale: 'linear'

'log'

basex/basey: The base of the logarithm

nonposx/nonposy: ['mask' | 'clip'] non-positive values in *x* or *y* can be masked as invalid, or clipped to a very small positive number

subsx/subsy: Where to place the subticks between each major tick. Should be a sequence of integers. For example, in a log10 scale: [2, 3, 4, 5, 6, 7, 8, 9]

will place 8 logarithmically spaced minor ticks between each major tick.

'logit'

nonpos: ['mask' | 'clip'] values beyond]0, 1[can be masked as invalid, or clipped to a number very close to 0 or 1

'symlog'

basex/basey: The base of the logarithm

linthreshx/linthreshy: The range $(-x, x)$ within which the plot is linear (to avoid having the plot go to infinity around zero).

subsx/subsy: Where to place the subticks between each major tick. Should be a sequence of integers. For example, in a log10 scale: [2, 3, 4, 5, 6, 7, 8, 9]

will place 8 logarithmically spaced minor ticks between each major tick.

linscalex/linscaley: This allows the linear range (*-linthresh* to *linthresh*) to be stretched relative to the logarithmic range. Its value is the number of decades to use for each half of the linear range. For example, when *linscale* == 1.0 (the default), the space used for the positive and negative halves of the linear range will be equal to one decade in the logarithmic range.

Note: Currently, Axes3D objects only supports linear scales. Other scales may or may not work, and support for these is improving with each release.

New in version 1.1.0: This function was added, but not tested. Please report any bugs.

set_zticklabels(*args, **kwargs)

Set z-axis tick labels. See [matplotlib.axes.Axes.set_yticklabels\(\)](#) for more details.

Note: Minor ticks are not supported by Axes3D objects.

New in version 1.1.0.

set_zticks(*args, **kwargs)

Set z-axis tick locations. See [matplotlib.axes.Axes.set_yticks\(\)](#) for more details.

Note: Minor ticks are not supported.

New in version 1.1.0.

text(x, y, z, s, zdir=None, **kwargs)

Add text to the plot. kwargs will be passed on to Axes.text, except for the zdir keyword, which sets the direction to be used as the z direction.

text2D(x, y, s, fontdict=None, withdash=False, **kwargs)

Add text to the axes.

Add text in string s to axis at location x, y, data coordinates.

Parameters x, y : scalars

data coordinates

s : string

text

fontdict : dictionary, optional, default: None

A dictionary to override the default text properties. If fontdict is None, the defaults are determined by your rc parameters.

withdash : boolean, optional, default: False

Creates a *TextWithDash* instance instead of a *Text* instance.

Other Parameters kwargs : *Text* properties.

Other miscellaneous text parameters.

Examples

Individual keyword arguments can be used to override any given parameter:

```
>>> text(x, y, s, fontsize=12)
```

The default transform specifies that text is in data coords, alternatively, you can specify text in axis coords (0,0 is lower-left and 1,1 is upper-right). The example below places text in the center of the axes:

```
>>> text(0.5, 0.5, 'matplotlib', horizontalalignment='center',
...      verticalalignment='center',
...      transform=ax.transAxes)
```

You can put a rectangular box around the text instance (e.g., to set a background color) by using the keyword `bbox`. `bbox` is a dictionary of *Rectangle* properties. For example:

```
>>> text(x, y, s, bbox=dict(facecolor='red', alpha=0.5))
```

text3D(*x, y, z, s, zdir=None, **kwargs*)

Add text to the plot. `kwargs` will be passed on to `Axes.text`, except for the `zdir` keyword, which sets the direction to be used as the `z` direction.

tick_params(*axis='both', **kwargs*)

Convenience method for changing the appearance of ticks and tick labels.

See `matplotlib.axes.Axes.tick_params()` for more complete documentation.

The only difference is that setting `axis` to 'both' will mean that the settings are applied to all three axes. Also, the `axis` parameter also accepts a value of 'z', which would mean to apply to only the `z`-axis.

Also, because of how `Axes3D` objects are drawn very differently from regular 2D axes, some of these settings may have ambiguous meaning. For simplicity, the 'z' axis will accept settings as if it was like the 'y' axis.

Note: While this function is currently implemented, the core part of the `Axes3D` object may ignore some of these settings. Future releases will fix this. Priority will be given to those who

file bugs.

New in version 1.1.0: This function was added, but not tested. Please report any bugs.

ticklabel_format(kwargs)**

Convenience method for manipulating the ScalarFormatter used by default for linear axes in Axes3D objects.

See `matplotlib.axes.Axes.ticklabel_format()` for full documentation. Note that this version applies to all three axes of the Axes3D object. Therefore, the *axis* argument will also accept a value of 'z' and the value of 'both' will apply to all three axes.

New in version 1.1.0: This function was added, but not tested. Please report any bugs.

tricontour(*args, **kwargs)

Create a 3D contour plot.

Argument	Description
X, Y,	Data values as numpy.arrays
Z	
<i>extend3d</i>	Whether to extend contour in 3D (default: False)
<i>stride</i>	Stride (step size) for extending contour
<i>zdir</i>	The direction to use: x, y or z (default)
<i>offset</i>	If specified plot a projection of the contour lines on this position in plane normal to zdir

Other keyword arguments are passed on to `tricontour()`

Returns a `contour`

Changed in version 1.3.0: Added support for custom triangulations

EXPERIMENTAL: This method currently produces incorrect output due to a longstanding bug in 3D PolyCollection rendering.

tricontourf(*args, **kwargs)

Create a 3D contourf plot.

Argument	Description
X, Y,	Data values as numpy.arrays
Z	
<i>zdir</i>	The direction to use: x, y or z (default)
<i>offset</i>	If specified plot a projection of the contour lines on this position in plane normal to zdir

Other keyword arguments are passed on to `tricontourf()`

Returns a `contour`

Changed in version 1.3.0: Added support for custom triangulations

EXPERIMENTAL: This method currently produces incorrect output due to a longstanding bug in 3D PolyCollection rendering.

tunit_cube(*vals=None, M=None*)

tunit_edges(*vals=None, M=None*)

unit_cube(*vals=None*)

update_datalim(*xys, **kwargs*)

view_init(*elev=None, azim=None*)

Set the elevation and azimuth of the axes.

This can be used to rotate the axes programatically.

‘elev’ stores the elevation angle in the z plane. ‘azim’ stores the azimuth angle in the x,y plane.

if elev or azim are None (default), then the initial value is used which was specified in the [Axes3D](#) constructor.

zaxis_date(*tz=None*)

Sets up z-axis ticks and labels that treat the z data as dates.

tz is a timezone string or `tzinfo` instance. Defaults to rc value.

Note: This function is merely provided for completeness. `Axes3D` objects do not officially support dates for ticks, and so this may or may not work as expected.

New in version 1.1.0: This function was added, but not tested. Please report any bugs.

zaxis_inverted()

Returns True if the z-axis is inverted.

New in version 1.1.0: This function was added, but not tested. Please report any bugs.

`mpl_toolkits.mplot3d.axes3d.get_test_data(delta=0.05)`

Return a tuple X, Y, Z with a test data set.

`mpl_toolkits.mplot3d.axes3d.unit_bbox()`

70.2.2 axis3d

Note: Historically, `axis3d` has suffered from having hard-coded constants controlling the look and feel of the 3D plot. This precluded user level adjustments such as label spacing, font colors and panel colors.

For version 1.1.0, these constants have been consolidated into a single private member dictionary, `self._axinfo`, for the axis object. This is intended only as a stop-gap measure to allow user-level customization, but it is not intended to be permanent.

```
class mpl_toolkits.mplot3d.axis3d.Axis(adir, v_intervalx, d_intervalx, axes, *args,  
                                         **kwargs)
```

```
    Bases: matplotlib.axis.XAxis
```

```
    draw(renderer)
```

```
    draw_pane(renderer)
```

```
    get_major_ticks(numticks=None)
```

```
    get_rotate_label(text)
```

```
    get_tick_positions()
```

```
    get_tightbbox(renderer)
```

```
    get_view_interval()
```

```
        return the Interval instance for this 3d axis view limits
```

```
    init3d()
```

```
    set_pane_color(color)
```

```
        Set pane color to a RGBA tuple
```

```
    set_pane_pos(xys)
```

```
    set_rotate_label(val)
```

```
        Whether to rotate the axis label: True, False or None. If set to None the label will be rotated if  
        longer than 4 chars.
```

```
    set_view_interval(vmin, vmax, ignore=False)
```

```
class mpl_toolkits.mplot3d.axis3d.XAxis(adir, v_intervalx, d_intervalx, axes, *args,  
                                         **kwargs)
```

```
    Bases: mpl_toolkits.mplot3d.axis3d.Axis
```

```
    get_data_interval()
```

```
        return the Interval instance for this axis data limits
```

```
class mpl_toolkits.mplot3d.axis3d.YAxis(adir, v_intervalx, d_intervalx, axes, *args,  
                                         **kwargs)
```

```
    Bases: mpl_toolkits.mplot3d.axis3d.Axis
```

get_data_interval()

return the Interval instance for this axis data limits

class `mpl_toolkits.mplot3d.axis3d.ZAxis`(*adir*, *v_intervalx*, *d_intervalx*, *axes*, **args*,
***kwargs*)

Bases: `mpl_toolkits.mplot3d.axis3d.Axis`

get_data_interval()

return the Interval instance for this axis data limits

`mpl_toolkits.mplot3d.axis3d.get_flip_min_max`(*coord*, *index*, *mins*, *maxs*)

`mpl_toolkits.mplot3d.axis3d.move_from_center`(*coord*, *centers*, *deltas*, *axmask*=(*True*,
True, *True*))

Return a coordinate that is moved by “deltas” away from the center.

`mpl_toolkits.mplot3d.axis3d.tick_update_position`(*tick*, *tickxs*, *tickys*, *labelpos*)

Update tick line and label position and style.

70.2.3 art3d

Module containing 3D artist code and functions to convert 2D artists into 3D versions which can be added to an Axes3D.

class `mpl_toolkits.mplot3d.art3d.Line3D`(*xs*, *ys*, *zs*, **args*, ***kwargs*)

Bases: `matplotlib.lines.Line2D`

3D line object.

Keyword arguments are passed onto `Line2D()`.

draw(*renderer*)

set_3d_properties(*zs=0*, *zdir='z'*)

class `mpl_toolkits.mplot3d.art3d.Line3DCollection`(*segments*, **args*, ***kwargs*)

Bases: `matplotlib.collections.LineCollection`

A collection of 3D lines.

Keyword arguments are passed onto `LineCollection()`.

do_3d_projection(*renderer*)

Project the points according to renderer matrix.

draw(*renderer*, *project=False*)

set_segments(*segments*)

Set 3D segments

set_sort_zpos(*val*)

Set the position to use for z-sorting.

class `mpl_toolkits.mplot3d.art3d.Patch3D(*args, **kwargs)`

Bases: `matplotlib.patches.Patch`

3D patch object.

do_3d_projection(*renderer*)

draw(*renderer*)

get_facecolor()

get_path()

set_3d_properties(*verts*, *zs=0*, *zdir='z'*)

class `mpl_toolkits.mplot3d.art3d.Patch3DCollection(*args, **kwargs)`

Bases: `matplotlib.collections.PatchCollection`

A collection of 3D patches.

Create a collection of flat 3D patches with its normal vector pointed in *zdir* direction, and located at *zs* on the *zdir* axis. ‘*zs*’ can be a scalar or an array-like of the same length as the number of patches in the collection.

Constructor arguments are the same as for `PatchCollection`. In addition, keywords *zs=0* and *zdir='z'* are available.

Also, the keyword argument “depthshade” is available to indicate whether or not to shade the patches in order to give the appearance of depth (default is `True`). This is typically desired in scatter plots.

do_3d_projection(*renderer*)

set_3d_properties(*zs*, *zdir*)

set_sort_zpos(*val*)

Set the position to use for z-sorting.

class `mpl_toolkits.mplot3d.art3d.Path3DCollection(*args, **kwargs)`

Bases: `matplotlib.collections.PathCollection`

A collection of 3D paths.

Create a collection of flat 3D paths with its normal vector pointed in *zdir* direction, and located at *zs* on the *zdir* axis. ‘*zs*’ can be a scalar or an array-like of the same length as the number of paths in the collection.

Constructor arguments are the same as for `PathCollection`. In addition, keywords *zs=0* and *zdir='z'* are available.

Also, the keyword argument “depthshade” is available to indicate whether or not to shade the patches in order to give the appearance of depth (default is *True*). This is typically desired in scatter plots.

do_3d_projection(*renderer*)

set_3d_properties(*zs, zdir*)

set_sort_zpos(*val*)

Set the position to use for z-sorting.

class `mpl_toolkits.mplot3d.art3d.PathPatch3D`(*path, **kwargs*)

Bases: `mpl_toolkits.mplot3d.art3d.Patch3D`

3D PathPatch object.

do_3d_projection(*renderer*)

set_3d_properties(*path, zs=0, zdir='z'*)

class `mpl_toolkits.mplot3d.art3d.Poly3DCollection`(*verts, *args, **kwargs*)

Bases: `matplotlib.collections.PolyCollection`

A collection of 3D polygons.

Create a Poly3DCollection.

verts should contain 3D coordinates.

Keyword arguments: *zsort*, see `set_zsort` for options.

Note that this class does a bit of magic with the `_facecolors` and `_edgecolors` properties.

do_3d_projection(*renderer*)

Perform the 3D projection for this object.

draw(*renderer*)

get_edgecolor()

get_edgecolors()

get_facecolor()

get_facecolors()

get_vector(*segments3d*)

Optimize points for projection

set_3d_properties()

set_alpha(*alpha*)

Set the alpha transparency of the collection. *alpha* must be a float or *None*.

ACCEPTS: float or *None*

set_edgecolor(*colors*)

set_edgecolors(*colors*)

set_facecolor(*colors*)

set_facecolors(*colors*)

set_sort_zpos(*val*)

Set the position to use for z-sorting.

set_verts(*verts*, *closed=True*)

Set 3D vertices.

set_verts_and_codes(*verts*, *codes*)

Sets 3D vertices with path codes

set_zsort(*zsort*)

Set z-sorting behaviour: boolean: if True use default 'average' string: 'average', 'min' or 'max'

class `mpl_toolkits.mplot3d.art3d.Text3D`(*x=0*, *y=0*, *z=0*, *text=''*, *zdir='z'*, ***kwargs*)

Bases: `matplotlib.text.Text`

Text object with 3D position and (in the future) direction.

x, *y*, *z* Position of text *text* Text string to display *zdir* Direction of text

Keyword arguments are passed onto `Text()`.

draw(*renderer*)

set_3d_properties(*z=0*, *zdir='z'*)

`mpl_toolkits.mplot3d.art3d.get_colors`(*c*, *num*)

Stretch the color argument to provide the required number *num*

`mpl_toolkits.mplot3d.art3d.get_dir_vector`(*zdir*)

`mpl_toolkits.mplot3d.art3d.get_patch_verts`(*patch*)

Return a list of vertices for the path of a patch.

`mpl_toolkits.mplot3d.art3d.iscolor(c)`

`mpl_toolkits.mplot3d.art3d.juggle_axes(xs, ys, zs, zdir)`

Reorder coordinates so that 2D *xs*, *ys* can be plotted in the plane orthogonal to *zdir*. *zdir* is normally *x*, *y* or *z*. However, if *zdir* starts with a '-' it is interpreted as a compensation for `rotate_axes`.

`mpl_toolkits.mplot3d.art3d.line_2d_to_3d(line, zs=0, zdir='z')`

Convert a 2D line to 3D.

`mpl_toolkits.mplot3d.art3d.line_collection_2d_to_3d(col, zs=0, zdir='z')`

Convert a `LineCollection` to a `Line3DCollection` object.

`mpl_toolkits.mplot3d.art3d.norm_angle(a)`

Return angle between -180 and +180

`mpl_toolkits.mplot3d.art3d.norm_text_angle(a)`

Return angle between -90 and +90

`mpl_toolkits.mplot3d.art3d.patch_2d_to_3d(patch, z=0, zdir='z')`

Convert a `Patch` to a `Patch3D` object.

`mpl_toolkits.mplot3d.art3d.patch_collection_2d_to_3d(col, zs=0, zdir='z', depthshade=True)`

Convert a `PatchCollection` into a `Patch3DCollection` object (or a `PathCollection` into a `Path3DCollection` object).

Keywords:

za The location or locations to place the patches in the collection along the *zdir* axis. Defaults to 0.

zdir The axis in which to place the patches. Default is "z".

depthshade Whether to shade the patches to give a sense of depth. Defaults to `True`.

`mpl_toolkits.mplot3d.art3d.path_to_3d_segment(path, zs=0, zdir='z')`

Convert a path to a 3D segment.

`mpl_toolkits.mplot3d.art3d.path_to_3d_segment_with_codes(path, zs=0, zdir='z')`

Convert a path to a 3D segment with path codes.

`mpl_toolkits.mplot3d.art3d.pathpatch_2d_to_3d(pathpatch, z=0, zdir='z')`

Convert a `PathPatch` to a `PathPatch3D` object.

`mpl_toolkits.mplot3d.art3d.paths_to_3d_segments(paths, zs=0, zdir='z')`

Convert paths from a collection object to 3D segments.

`mpl_toolkits.mplot3d.art3d.paths_to_3d_segments_with_codes(paths, zs=0, zdir='z')`

Convert paths from a collection object to 3D segments with path codes.

`mpl_toolkits.mplot3d.art3d.poly_collection_2d_to_3d(col, zs=0, zdir='z')`

Convert a `PolyCollection` to a `Poly3DCollection` object.

`mpl_toolkits.mplot3d.art3d.rotate_axes(xs, ys, zs, zdir)`

Reorder coordinates so that the axes are rotated with *zdir* along the original *z* axis. Prepending the axis with a '-' does the inverse transform, so *zdir* can be *x*, -*x*, *y*, -*y*, *z* or -*z*

`mpl_toolkits.mplot3d.art3d.text_2d_to_3d(obj, z=0, zdir='z')`
Convert a Text to a Text3D object.

`mpl_toolkits.mplot3d.art3d.zalpha(colors, zs)`
Modify the alphas of the color list according to depth

70.2.4 proj3d

Various transforms used for by the 3D code

`mpl_toolkits.mplot3d.proj3d.inv_transform(xs, ys, zs, M)`

`mpl_toolkits.mplot3d.proj3d.line2d(p0, p1)`
Return 2D equation of line in the form $ax+by+c = 0$

`mpl_toolkits.mplot3d.proj3d.line2d_dist(l, p)`
Distance from line to point line is a tuple of coefficients a,b,c

`mpl_toolkits.mplot3d.proj3d.line2d_seg_dist(p1, p2, p0)`
distance(s) from line defined by p1 - p2 to point(s) p0

$p0[0] = x(s)$ $p0[1] = y(s)$

intersection point $p = p1 + u*(p2-p1)$ and intersection point lies within segment if u is between 0 and 1

`mpl_toolkits.mplot3d.proj3d.mod(v)`
3d vector length

`mpl_toolkits.mplot3d.proj3d.persp_transformation(zfront, zback)`

`mpl_toolkits.mplot3d.proj3d.proj_points(points, M)`

`mpl_toolkits.mplot3d.proj3d.proj_trans_clip_points(points, M)`

`mpl_toolkits.mplot3d.proj3d.proj_trans_points(points, M)`

`mpl_toolkits.mplot3d.proj3d.proj_transform(xs, ys, zs, M)`
Transform the points by the projection matrix

`mpl_toolkits.mplot3d.proj3d.proj_transform_clip(xs, ys, zs, M)`
Transform the points by the projection matrix and return the clipping result returns txs,tys,tzs,tis

`mpl_toolkits.mplot3d.proj3d.proj_transform_vec(vec, M)`

`mpl_toolkits.mplot3d.proj3d.proj_transform_vec_clip(vec, M)`

```
mpl_toolkits.mplot3d.proj3d.rot_x(V, alpha)
```

```
mpl_toolkits.mplot3d.proj3d.test_lines_dists()
```

```
mpl_toolkits.mplot3d.proj3d.test_proj()
```

```
mpl_toolkits.mplot3d.proj3d.test_proj_draw_axes(M, s=1)
```

```
mpl_toolkits.mplot3d.proj3d.test_proj_make_M(E=None)
```

```
mpl_toolkits.mplot3d.proj3d.test_rot()
```

```
mpl_toolkits.mplot3d.proj3d.test_world()
```

```
mpl_toolkits.mplot3d.proj3d.transform(xs, ys, zs, M)
    Transform the points by the projection matrix
```

```
mpl_toolkits.mplot3d.proj3d.vec_pad_ones(xs, ys, zs)
```

```
mpl_toolkits.mplot3d.proj3d.view_transformation(E, R, V)
```

```
mpl_toolkits.mplot3d.proj3d.world_transformation(xmin, xmax, ymin, ymax, zmin,
                                                zmax)
```

70.3 mplot3d FAQ

70.3.1 How is mplot3d different from MayaVi?

[MayaVi2](#) is a very powerful and featureful 3D graphing library. For advanced 3D scenes and excellent rendering capabilities, it is highly recommended to use MayaVi2.

mplot3d was intended to allow users to create simple 3D graphs with the same “look-and-feel” as matplotlib’s 2D plots. Furthermore, users can use the same toolkit that they are already familiar with to generate both their 2D and 3D plots.

70.3.2 My 3D plot doesn’t look right at certain viewing angles

This is probably the most commonly reported issue with mplot3d. The problem is that – from some viewing angles – a 3D object would appear in front of another object, even though it is physically behind it. This can result in plots that do not look “physically correct.”

Unfortunately, while some work is being done to reduce the occurrence of this artifact, it is currently an intractable problem, and can not be fully solved until matplotlib supports 3D graphics rendering at its core.

The problem occurs due to the reduction of 3D data down to 2D + z-order scalar. A single value represents the 3rd dimension for all parts of 3D objects in a collection. Therefore, when the bounding boxes of two collections intersect, it becomes possible for this artifact to occur. Furthermore, the intersection of two 3D objects (such as polygons or patches) can not be rendered properly in matplotlib's 2D rendering engine.

This problem will likely not be solved until OpenGL support is added to all of the backends (patches are greatly welcomed). Until then, if you need complex 3D scenes, we recommend using [MayaVi](#).

70.3.3 I don't like how the 3D plot is laid out, how do I change that?

Historically, mplot3d has suffered from a hard-coding of parameters used to control visuals such as label spacing, tick length, and grid line width. Work is being done to eliminate this issue. For matplotlib v1.1.0, there is a semi-official manner to modify these parameters. See the note in the [axis3d](#) section of the mplot3d API documentation for more information.

Part VI

Toolkits

Toolkits are collections of application-specific functions that extend matplotlib.

MAPPING TOOLKITS

71.1 Basemap

(Not distributed with matplotlib)

Plots data on map projections, with continental and political boundaries, see [basemap docs](#).

contour lines over filled continent background

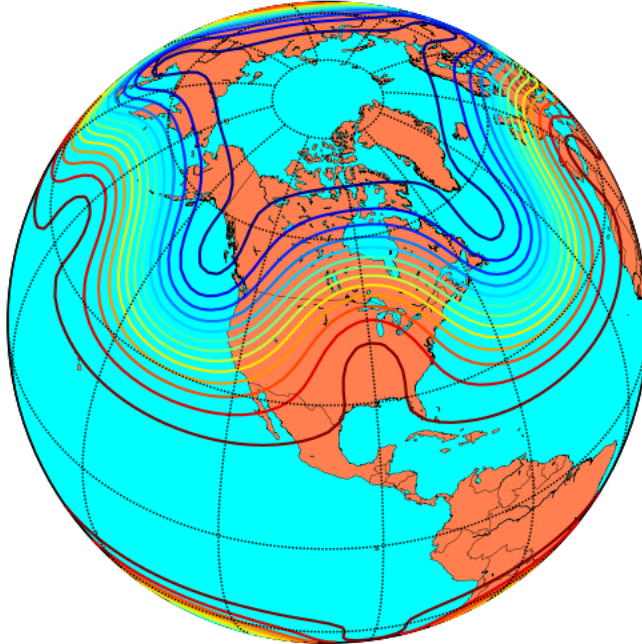

71.2 Cartopy

(Not distributed with matplotlib)

An alternative mapping library written for matplotlib v1.2 and beyond. [Cartopy](#) builds on top of matplotlib to provide object oriented map projection definitions and close integration with Shapely for powerful yet

easy-to-use vector data processing tools. An example plot from the [Cartopy gallery](#):

US States which intersect the track of Hurricane Katrina (2005)

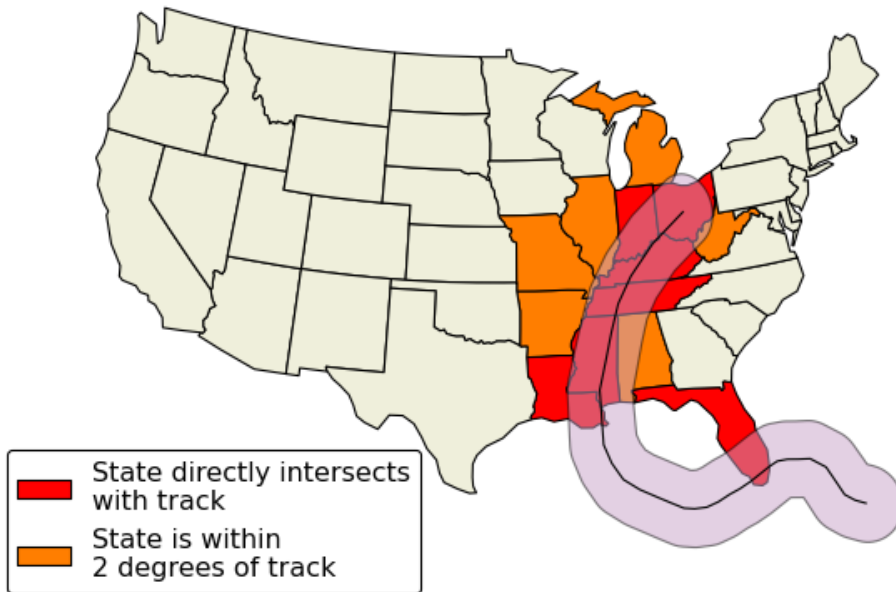

GENERAL TOOLKITS

72.1 mplot3d

mpl_toolkits.mplot3d provides some basic 3D plotting (scatter, surf, line, mesh) tools. Not the fastest or feature complete 3D library out there, but ships with matplotlib and thus may be a lighter weight solution for some use cases.

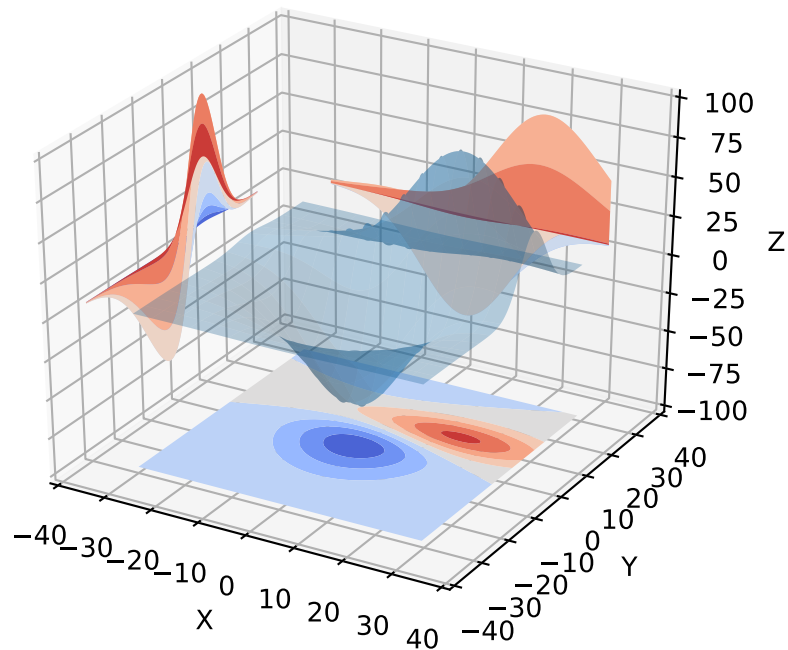

72.2 AxesGrid

The matplotlib *AxesGrid* toolkit is a collection of helper classes to ease displaying multiple images in matplotlib. The AxesGrid toolkit is distributed with matplotlib source.

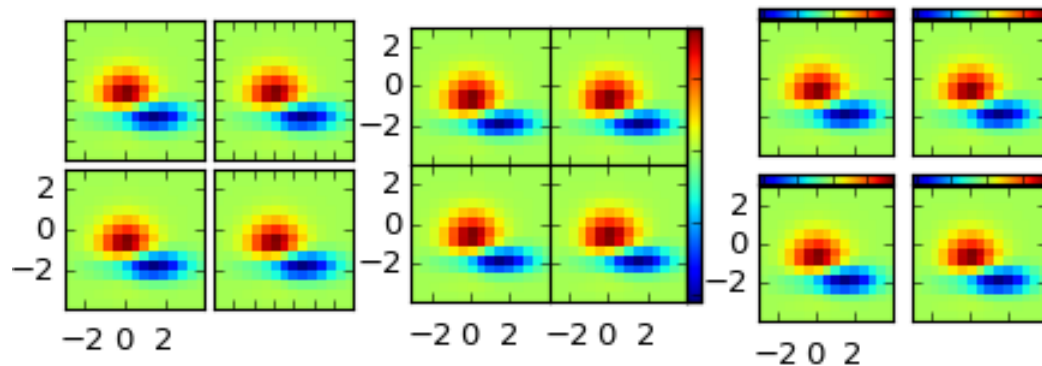

72.3 mplcursors

`mplcursors` provides interactive data cursors for matplotlib.

72.4 MplDataCursor

(Not distributed with matplotlib)

`MplDataCursor` is a toolkit written by Joe Kington to provide interactive “data cursors” (clickable annotation boxes) for matplotlib.

72.5 GTK Tools

`mpl_toolkits.gtktools` provides some utilities for working with GTK. This toolkit ships with matplotlib, but requires `pygtk`.

72.6 Excel Tools

`mpl_toolkits.exceltools` provides some utilities for working with Excel. This toolkit ships with matplotlib, but requires `xlwt`.

72.7 Natgrid

(Not distributed with matplotlib)

`mpl_toolkits.natgrid` is an interface to `natgrid` C library for gridding irregularly spaced data. This requires a separate installation of the `natgrid` toolkit.

72.8 Matplotlib-Venn

(Not distributed with matplotlib)

`Matplotlib-Venn` provides a set of functions for plotting 2- and 3-set area-weighted (or unweighted) Venn diagrams.

72.9 mplstereonet

(Not distributed with matplotlib)

`mplstereonet` provides stereonet for plotting and analyzing orientation data in Matplotlib.

HIGH-LEVEL PLOTTING

Several projects have started to provide a higher-level interface to matplotlib. These are independent projects.

73.1 seaborn

(Not distributed with matplotlib)

[seaborn](#) is a high level interface for drawing statistical graphics with matplotlib. It aims to make visualization a central part of exploring and understanding complex datasets.

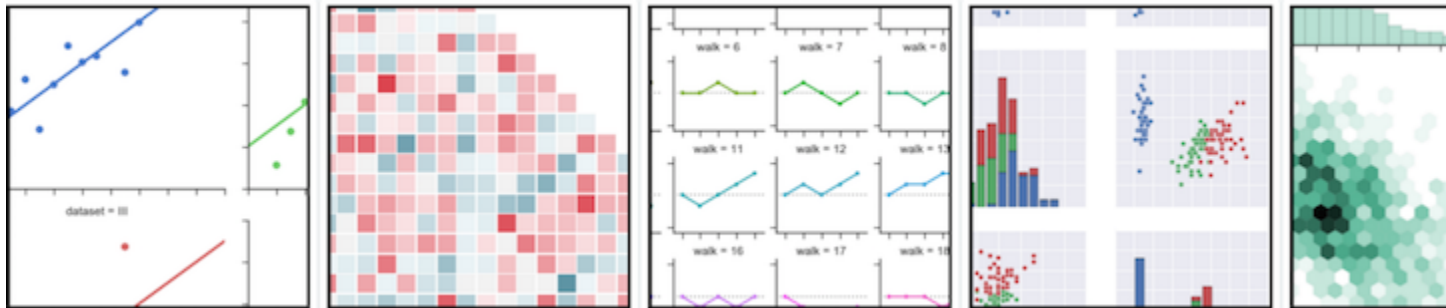

73.2 holoviews

(Not distributed with matplotlib)

[holoviews](#) makes it easier to visualize data interactively, especially in a [Jupyter notebook](#), by providing a set of declarative plotting objects that store your data and associated metadata. Your data is then immediately visualizable alongside or overlaid with other data, either statically or with automatically provided widgets for parameter exploration.

```
import numpy as np
import holoviews as hv
hv.notebook_extension('matplotlib')
fractal = hv.Image(np.load('mandelbrot.npy'))

((fractal * hv.HLine(y=0)).hist() + fractal.sample(y=0))
```

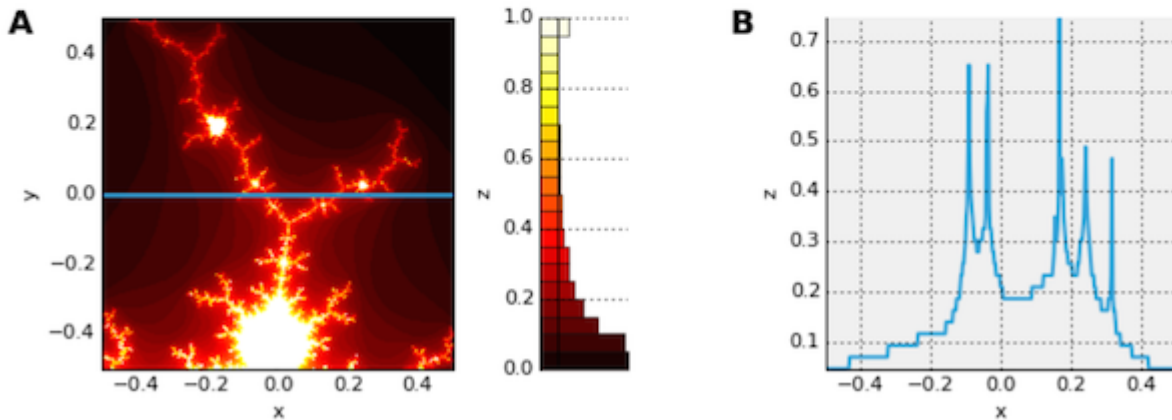

73.3 ggplot

(Not distributed with matplotlib)

ggplot is a port of the R ggplot2 to python based on matplotlib.

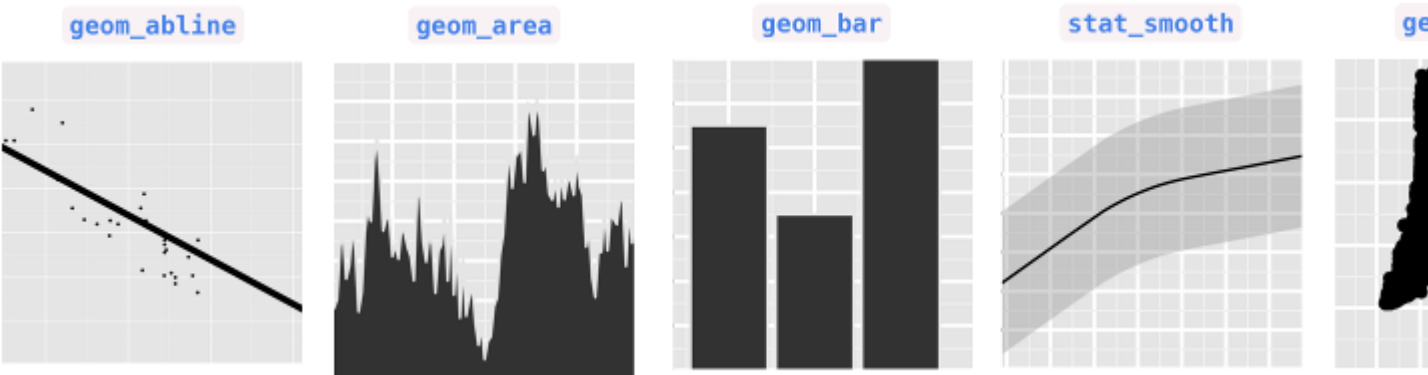

73.4 prettyplotlib

(Not distributed with matplotlib)

prettyplotlib is an extension to matplotlib which changes many of the defaults to make plots some consider more attractive.

73.5 iTerm2 terminal backend

(Not distributed with matplotlib)

`matplotlib_itehm2` is an external matplotlib backend uses iTerm2 nightly build inline image display feature.

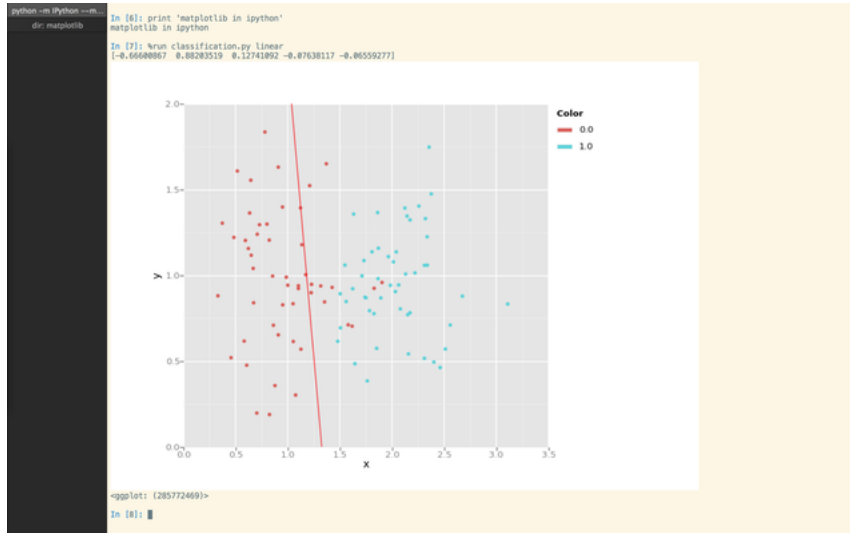

Part VII

External Resources

BOOKS, CHAPTERS AND ARTICLES

- [Mastering matplotlib](#) by Duncan M. McGregor
- [Interactive Applications Using Matplotlib](#) by Benjamin Root
- [Matplotlib for Python Developers](#) by Sandro Tosi
- [Matplotlib chapter](#) by John Hunter and Michael Droettboom in *The Architecture of Open Source Applications*
- [Graphics with Matplotlib](#) by David J. Raymond
- [Ten Simple Rules for Better Figures](#) by Nicolas P. Rougier, Michael Droettboom and Philip E. Bourne
- [Learning Scientific Programming with Python chapter 7](#) by Christian Hill

**CHAPTER
SEVENTYFIVE**

VIDEOS

- [Plotting with matplotlib](#) by Mike Müller
- [Introduction to NumPy and Matplotlib](#) by Eric Jones
- [Anatomy of Matplotlib](#) by Benjamin Root
- [Data Visualization Basics with Python \(O'Reilly\)](#) by Randal S. Olson

**CHAPTER
SEVENTYSIX**

TUTORIALS

- [Matplotlib tutorial](#) by Nicolas P. Rougier
- [Anatomy of Matplotlib - IPython Notebooks](#) by Benjamin Root

Part VIII

The Matplotlib Developers' Guide

This project is a community effort, and everyone is welcome to contribute.

The project is hosted on <https://github.com/matplotlib/matplotlib>

77.1 Submitting a bug report

If you find a bug in the code or documentation, do not hesitate to submit a ticket to the [Bug Tracker](#). You are also welcome to post feature requests or pull requests.

77.2 Retrieving and installing the latest version of the code

When working on the Matplotlib source, setting up a [virtual environment](#) or a [conda environment](#) is recommended.

Warning: If you already have a version of Matplotlib installed, use an virtual environment or uninstall using the same method you used to install it. Installing multiple versions of Matplotlib via different methods into the same environment may not always work as expected.

We use [Git](#) for version control and [GitHub](#) for hosting our main repository.

You can check out the latest sources with the command (see *Set up your fork* for more details):

```
git clone git@github.com:matplotlib/matplotlib.git
```

and navigate to the `matplotlib` directory.

To make sure the tests run locally you must build against the correct version of freetype. To configure the build system to fetch and build it either export the env `MPLLOCALFREETYPE` as:

```
export MPLLOCALFREETYPE=1
```

or copy `setup.cfg.template` to `setup.cfg` and edit it to contain

```
[test]
local_freetype = True
```

To install Matplotlib (and compile the c-extensions) run the following command from the top-level directory

```
pip install -v -e ./
```

This installs Matplotlib in ‘editable/develop mode’, i.e., builds everything and places the correct link entries in the install directory so that python will be able to import Matplotlib from the source directory. Thus, any changes to the *.py files will be reflected the next time you import the library. If you change the c-extension source (which might happen if you change branches) you will need to run:

```
python setup.py build
```

or re-run `pip install -v -e ./`.

Alternatively, if you do

```
pip install -v ./
```

all of the files will be copied to the installation directory however, you will have to rerun this command every time the source is changed. Additionally you will need to copy `setup.cfg.template` to `setup.cfg` and edit it to contain

```
[test]
local_freetype = True
tests = True
```

In either case you can then run the tests to check your work environment is set up properly:

```
python tests.py
```

Note: **Additional dependencies for testing:** `nose` (version 1.0 or later), `mock` (if python < 3.3), `Ghostscript`, `Inkscape`

See also:

- *Developer’s tips for testing*

77.3 Contributing code

77.3.1 How to contribute

The preferred way to contribute to Matplotlib is to fork the [main repository](#) on GitHub, then submit a “pull request” (PR):

1. [Create an account](#) on GitHub if you do not already have one.

2. Fork the [project repository](#): click on the ‘Fork’ button near the top of the page. This creates a copy of the code under your account on the GitHub server.
3. Clone this copy to your local disk:

```
$ git clone git@github.com:YourLogin/matplotlib.git
```

4. Create a branch to hold your changes:

```
$ git checkout -b my-feature origin/master
```

and start making changes. Never work in the master branch!

5. Work on this copy, on your computer, using Git to do the version control. When you’re done editing e.g., `lib/matplotlib/collections.py`, do:

```
$ git add lib/matplotlib/collections.py
$ git commit
```

to record your changes in Git, then push them to GitHub with:

```
$ git push -u origin my-feature
```

Finally, go to the web page of your fork of the Matplotlib repo, and click ‘Pull request’ to send your changes to the maintainers for review. You may want to consider sending an email to the mailing list for more visibility.

See also:

- [Git documentation](#)
- [Development workflow](#).
- [Working with Matplotlib source code](#)

77.3.2 Contributing pull requests

It is recommended to check that your contribution complies with the following rules before submitting a pull request:

- If your pull request addresses an issue, please use the title to describe the issue and mention the issue number in the pull request description to ensure a link is created to the original issue.
- All public methods should have informative docstrings with sample usage when appropriate. Use the [numpy docstring standard](#)
- Formatting should follow [PEP8 recommendation](#). You should consider installing/enabling automatic PEP8 checking in your editor. Part of the test suite is checking PEP8 compliance, things go smoother if the code is mostly PEP8 compliant to begin with.
- Each high-level plotting function should have a simple example in the `Example` section of the docstring. This should be as simple as possible to demonstrate the method. More complex examples should go in the `examples` tree.

- Changes (both new features and bugfixes) should be tested. See *Developer's tips for testing* for more details.
- Import the following modules using the standard scipy conventions:

```
import numpy as np
import numpy.ma as ma
import matplotlib as mpl
import matplotlib.pyplot as plt
import matplotlib.cbook as cbook
import matplotlib.patches as mpatches
```

- If your change is a major new feature, add an entry to the What's new section by adding a new file in `doc/users/whats_new` (see `doc/users/whats_new/README` for more information).
- If you change the API in a backward-incompatible way, please document it in `doc/api/api_changes`, by adding a new file describing your changes (see `doc/api/api_changes/README` for more information)
- See below for additional points about *Keyword argument processing*, if code in your pull request does that.

In addition, you can check for common programming errors with the following tools:

- Code with a good unittest coverage (at least 70%, better 100%), check with:

```
pip install coverage
python tests.py --with-coverage
```

- No pyflakes warnings, check with:

```
pip install pyflakes
pyflakes path/to/module.py
```

Note: The current state of the Matplotlib code base is not compliant with all of those guidelines, but we expect that enforcing those constraints on all new contributions will move the overall code base quality in the right direction.

See also:

- *Coding guidelines*
- *Developer's tips for testing*
- *Developer's tips for documenting matplotlib*

77.3.3 Issues for New Contributors

New contributors should look for the following tags when looking for issues. We strongly recommend that new contributors tackle `new-contributor-friendly` issues (easy, well documented issues, that do not require

an understanding of the different submodules of Matplotlib) and [Easy-fix](#) issues. This helps the contributor become familiar with the contribution workflow, and for the core devs to become acquainted with the contributor; besides which, we frequently underestimate how easy an issue is to solve!

77.4 Other ways to contribute

Code is not the only way to contribute to Matplotlib. For instance, documentation is also a very important part of the project and often doesn't get as much attention as it deserves. If you find a typo in the documentation, or have made improvements, do not hesitate to send an email to the mailing list or submit a GitHub pull request. Full documentation can be found under the `doc/` directory.

It also helps us if you spread the word: reference the project from your blog and articles or link to it from your website!

77.5 Coding guidelines

77.5.1 New modules and files: installation

- If you have added new files or directories, or reorganized existing ones, make sure the new files are included in the match patterns in `MANIFEST.in`, and/or in `package_data` in `setup.py`.

77.5.2 C/C++ extensions

- Extensions may be written in C or C++.
- Code style should conform to PEP7 (understanding that PEP7 doesn't address C++, but most of its admonitions still apply).
- Python/C interface code should be kept separate from the core C/C++ code. The interface code should be named `FOO_wrap.cpp` or `FOO_wrapper.cpp`.
- Header file documentation (aka docstrings) should be in Numpydoc format. We don't plan on using automated tools for these docstrings, and the Numpydoc format is well understood in the scientific Python community.

77.5.3 Keyword argument processing

Matplotlib makes extensive use of `**kwargs` for pass-through customizations from one function to another. A typical example is in `matplotlib.pyplot.text()`. The definition of the pylab text function is a simple pass-through to `matplotlib.axes.Axes.text()`:

```
# in pylab.py
def text(*args, **kwargs):
    ret = gca().text(*args, **kwargs)
    draw_if_interactive()
    return ret
```

`text()` in simplified form looks like this, i.e., it just passes all args and kwargs on to `matplotlib.text.Text.__init__()`:

```
# in axes/_axes.py
def text(self, x, y, s, fontdict=None, withdash=False, **kwargs):
    t = Text(x=x, y=y, text=s, **kwargs)
```

and `__init__()` (again with liberties for illustration) just passes them on to the `matplotlib.artist.Artist.update()` method:

```
# in text.py
def __init__(self, x=0, y=0, text='', **kwargs):
    Artist.__init__(self)
    self.update(kwargs)
```

`update` does the work looking for methods named like `set_property` if `property` is a keyword argument. i.e., no one looks at the keywords, they just get passed through the API to the artist constructor which looks for suitably named methods and calls them with the value.

As a general rule, the use of `**kwargs` should be reserved for pass-through keyword arguments, as in the example above. If all the keyword args are to be used in the function, and not passed on, use the key/value keyword args in the function definition rather than the `**kwargs` idiom.

In some cases, you may want to consume some keys in the local function, and let others pass through. You can pop the ones to be used locally and pass on the rest. For example, in `plot()`, `scalex` and `scaley` are local arguments and the rest are passed on as `Line2D()` keyword arguments:

```
# in axes/_axes.py
def plot(self, *args, **kwargs):
    scalex = kwargs.pop('scalex', True)
    scaley = kwargs.pop('scaley', True)
    if not self._hold: self.cla()
    lines = []
    for line in self._get_lines(*args, **kwargs):
        self.add_line(line)
        lines.append(line)
```

Note: there is a use case when kwargs are meant to be used locally in the function (not passed on), but you still need the `**kwargs` idiom. That is when you want to use `*args` to allow variable numbers of non-keyword args. In this case, python will not allow you to use named keyword args after the `*args` usage, so you will be forced to use `**kwargs`. An example is `matplotlib.contour.ContourLabeler.clabel()`:

```
# in contour.py
def clabel(self, *args, **kwargs):
    fontsize = kwargs.get('fontsize', None)
    inline = kwargs.get('inline', 1)
    self.fmt = kwargs.get('fmt', '%1.3f')
    colors = kwargs.get('colors', None)
    if len(args) == 0:
        levels = self.levels
        indices = range(len(self.levels))
    elif len(args) == 1:
        ...etc...
```

77.5.4 Developing a new backend

If you are working on a custom backend, the *backend* setting in `matplotlibrc` (*Customizing matplotlib*) supports an external backend via the module directive. If `my_backend.py` is a Matplotlib backend in your *PYTHONPATH*, you can set it on one of several ways

- in `matplotlibrc`:

```
backend : module://my_backend
```

- with the *MPLBACKEND* environment variable:

```
> export MPLBACKEND="module://my_backend"  
> python simple_plot.py
```

- from the command shell with the `-d` flag:

```
> python simple_plot.py -dmodule://my_backend
```

- with the `use` directive in your script:

```
import matplotlib  
matplotlib.use('module://my_backend')
```

77.5.5 Writing examples

We have hundreds of examples in subdirectories of `matplotlib/examples`, and these are automatically generated when the website is built to show up both in the examples and gallery sections of the website.

Any sample data that the example uses should be kept small and distributed with Matplotlib in the `lib/matplotlib/mpl-data/sample_data/` directory. Then in your example code you can load it into a file handle with:

```
import matplotlib.cbook as cbook  
fh = cbook.get_sample_data('mydata.dat')
```

DEVELOPER'S TIPS FOR TESTING

Matplotlib has a testing infrastructure based on `nose`, making it easy to write new tests. The tests are in `matplotlib.tests`, and customizations to the nose testing infrastructure are in `matplotlib.testing`. (There is other old testing cruft around, please ignore it while we consolidate our testing to these locations.)

78.1 Requirements

The following software is required to run the tests:

- `nose`, version 1.0 or later
- `mock`, when running python versions < 3.3
- Ghostscript (to render PDF files)
- Inkscape (to render SVG files)

Optionally you can install:

- `coverage` to collect coverage information
- `pep8` to test coding standards

78.2 Building matplotlib for image comparison tests

matplotlib's test suite makes heavy use of image comparison tests, meaning the result of a plot is compared against a known good result. Unfortunately, different versions of FreeType produce differently formed characters, causing these image comparisons to fail. To make them reproducible, matplotlib can be built with a special local copy of FreeType. This is recommended for all matplotlib developers.

Add the following content to a `setup.cfg` file at the root of the matplotlib source directory:

```
[test]
local_freetype = True
tests = True
```

or by setting the `MPLLOCALFREETYPE` environmental variable to any true value.

78.3 Running the tests

Running the tests is simple. Make sure you have nose installed and run:

```
python tests.py
```

in the root directory of the distribution. The script takes a set of commands, such as:

<code>--pep8</code>	pep8 checks
<code>--no-pep8</code>	Do not perform pep8 checks
<code>--no-network</code>	Disable tests that require network access

Additional arguments are passed on to nosetests. See the nose documentation for supported arguments. Some of the more important ones are given here:

<code>--verbose</code>	Be more verbose
<code>--processes=NUM</code>	Run tests in parallel over NUM processes
<code>--process-timeout=SECONDS</code>	Set timeout for results from test runner process
<code>--nocapture</code>	Do not capture stdout

To run a single test from the command line, you can provide a dot-separated path to the module followed by the function separated by a colon, e.g., (this is assuming the test is installed):

```
python tests.py matplotlib.tests.test_simplification:test_clipping
```

If you want to run the full test suite, but want to save wall time try running the tests in parallel:

```
python tests.py --nocapture --verbose --processes=5 --process-timeout=300
```

An alternative implementation that does not look at command line arguments works from within Python is to run the tests from the matplotlib library function `matplotlib.test()`:

```
import matplotlib
matplotlib.test()
```

Hint: To run the tests you need to install nose and mock if using python 2.7:

```
pip install nose
pip install mock
```

78.4 Writing a simple test

Many elements of Matplotlib can be tested using standard tests. For example, here is a test from `matplotlib.tests.test_basic`:

```
from nose.tools import assert_equal

def test_simple():
```

```

"""
very simple example test
"""
assert_equal(1+1,2)

```

Nose determines which functions are tests by searching for functions beginning with “test” in their name.

If the test has side effects that need to be cleaned up, such as creating figures using the pyplot interface, use the `@cleanup` decorator:

```

from matplotlib.testing.decorators import cleanup

@cleanup
def test_create_figure():
    """
    very simple example test that creates a figure using pyplot.
    """
    fig = figure()
    ...

```

78.5 Writing an image comparison test

Writing an image based test is only slightly more difficult than a simple test. The main consideration is that you must specify the “baseline”, or expected, images in the `image_comparison()` decorator. For example, this test generates a single image and automatically tests it:

```

import numpy as np
import matplotlib
from matplotlib.testing.decorators import image_comparison
import matplotlib.pyplot as plt

@image_comparison(baseline_images=['spines_axes_positions'],
                  extensions=['png'])
def test_spines_axes_positions():
    # SF bug 2852168
    fig = plt.figure()
    x = np.linspace(0, 2*np.pi, 100)
    y = 2*np.sin(x)
    ax = fig.add_subplot(1,1,1)
    ax.set_title('centered spines')
    ax.plot(x,y)
    ax.spines['right'].set_position(('axes',0.1))
    ax.yaxis.set_ticks_position('right')
    ax.spines['top'].set_position(('axes',0.25))
    ax.xaxis.set_ticks_position('top')
    ax.spines['left'].set_color('none')
    ax.spines['bottom'].set_color('none')

```

The first time this test is run, there will be no baseline image to compare against, so the test will fail. Copy the output images (in this case `result_images/test_category/spines_axes_positions.png`) to the

correct subdirectory of `baseline_images` tree in the source directory (in this case `lib/matplotlib/tests/baseline_images/test_category`). Put this new file under source code revision control (with `git add`). When rerunning the tests, they should now pass.

The `image_comparison()` decorator defaults to generating `png`, `pdf` and `svg` output, but in interest of keeping the size of the library from ballooning we should only include the `svg` or `pdf` outputs if the test is explicitly exercising a feature dependent on that backend.

There are two optional keyword arguments to the `image_comparison` decorator:

- `extensions`: If you only wish to test additional image formats (rather than just `png`), pass any additional file types in the list of the extensions to test. When copying the new baseline files be sure to only copy the output files, not their conversions to `png`. For example only copy the files ending in `pdf`, not in `_pdf.png`.
- `tol`: This is the image matching tolerance, the default `1e-3`. If some variation is expected in the image between runs, this value may be adjusted.

78.6 Known failing tests

If you're writing a test, you may mark it as a known failing test with the `knownfailureif()` decorator. This allows the test to be added to the test suite and run on the buildbots without causing undue alarm. For example, although the following test will fail, it is an expected failure:

```
from nose.tools import assert_equal
from matplotlib.testing.decorators import knownfailureif

@knownfailureif(True)
def test_simple_fail():
    "very simple example test that should fail"
    assert_equal(1+1,3)
```

Note that the first argument to the `knownfailureif()` decorator is a fail condition, which can be a value such as `True`, `False`, or `'indeterminate'`, or may be a dynamically evaluated expression.

78.7 Creating a new module in `matplotlib.tests`

We try to keep the tests categorized by the primary module they are testing. For example, the tests related to the `matplotlib.text` module are in `test_matplotlib.text.py`.

Let's say you've added a new module named `whizbang.py` and you want to add tests for it in `matplotlib.tests.test_whizbang`. To add this module to the list of default tests, append its name to `default_test_modules` in `lib/matplotlib/__init__.py`.

78.8 Using Travis CI

Travis CI is a hosted CI system "in the cloud".

Travis is configured to receive notifications of new commits to GitHub repos (via GitHub “service hooks”) and to run builds or tests when it sees these new commits. It looks for a YAML file called `.travis.yml` in the root of the repository to see how to test the project.

Travis CI is already enabled for the [main matplotlib GitHub repository](#) – for example, see its [Travis page](#).

If you want to enable Travis CI for your personal matplotlib GitHub repo, simply enable the repo to use Travis CI in either the Travis CI UI or the GitHub UI (Admin | Service Hooks). For details, see [the Travis CI Getting Started page](#). This generally isn’t necessary, since any pull request submitted against the main matplotlib repository will be tested.

Once this is configured, you can see the Travis CI results at https://travis-ci.org/your_GitHub_user_name/matplotlib – here’s an [example](#).

78.9 Using tox

Tox is a tool for running tests against multiple Python environments, including multiple versions of Python (e.g., 2.7, 3.4, 3.5) and even different Python implementations altogether (e.g., CPython, PyPy, Jython, etc.)

Testing all versions of Python (2.6, 2.7, 3.*) requires having multiple versions of Python installed on your system and on the PATH. Depending on your operating system, you may want to use your package manager (such as apt-get, yum or MacPorts) to do this.

tox makes it easy to determine if your working copy introduced any regressions before submitting a pull request. Here’s how to use it:

```
$ pip install tox
$ tox
```

You can also run tox on a subset of environments:

```
$ tox -e py26,py27
```

Tox processes everything serially so it can take a long time to test several environments. To speed it up, you might try using a new, parallelized version of tox called `detox`. Give this a try:

```
$ pip install -U -i http://pypi.testrun.org detox
$ detox
```

Tox is configured using a file called `tox.ini`. You may need to edit this file if you want to add new environments to test (e.g., py33) or if you want to tweak the dependencies or the way the tests are run. For more info on the `tox.ini` file, see the [Tox Configuration Specification](#).

DEVELOPER'S TIPS FOR DOCUMENTING MATPLOTLIB

79.1 Getting started

The documentation for matplotlib is generated from ReStructured Text using the [Sphinx](#) documentation generation tool. The requirements are as follows (<https://github.com/matplotlib/matplotlib/blob/master/doc-requirements.txt>)

1. Sphinx-1.3 or later (Version 1.5.0 is not supported)
2. numpydoc 0.4 or later
3. IPython
4. Mock
5. colorspacious
6. pillow
7. graphviz

The documentation sources are found in the `doc/` directory in the trunk. To build the users guide in html format, cd into `doc/` and do:

```
python make.py html
```

or:

```
./make.py html
```

you can also pass a `latex` flag to `make.py` to build a pdf, or pass no arguments to build everything.

The output produced by Sphinx can be configured by editing the `conf.py` file located in the `doc/`.

79.2 Organization of matplotlib's documentation

The actual ReStructured Text files are kept in `doc/users`, `doc/devel`, `doc/api` and `doc/faq`. The main entry point is `doc/index.rst`, which pulls in the `index.rst` file for the users guide, developers guide, api reference, and faqs. The documentation suite is built as a single document in order to make the most

effective use of cross referencing, we want to make navigating the Matplotlib documentation as easy as possible.

Additional files can be added to the various guides by including their base file name (the `.rst` extension is not necessary) in the table of contents. It is also possible to include other documents through the use of an include statement, such as:

```
.. include:: ../../TODO
```

79.2.1 docstrings

In addition to the “narrative” documentation described above, matplotlib also defines its API reference documentation in docstrings. For the most part, these are standard Python docstrings, but matplotlib also includes some features to better support documenting getters and setters.

Matplotlib uses artist introspection of docstrings to support properties. All properties that you want to support through `setp` and `getp` should have a `set_property` and `get_property` method in the `Artist` class. Yes, this is not ideal given python properties or enthought traits, but it is a historical legacy for now. The setter methods use the docstring with the `ACCEPTS` token to indicate the type of argument the method accepts. e.g., in `matplotlib.lines.Line2D`:

```
# in lines.py
def set_linestyle(self, linestyle):
    """
    Set the linestyle of the line

    ACCEPTS: [ '-' | '--' | '-.' | ':' | 'steps' | 'None' | '' | " ]
    """
```

Since matplotlib uses a lot of pass-through kwargs, e.g., in every function that creates a line (`plot()`, `semilogx()`, `semilogy()`, etc...), it can be difficult for the new user to know which kwargs are supported. Matplotlib uses a docstring interpolation scheme to support documentation of every function that takes a `**kwargs`. The requirements are:

1. single point of configuration so changes to the properties don't require multiple docstring edits.
2. as automated as possible so that as properties change, the docs are updated automagically.

The function `matplotlib.artist.kwdoc()` and the decorator `matplotlib.docstring.dedent_interpd()` facilitate this. They combine python string interpolation in the docstring with the matplotlib artist introspection facility that underlies `setp` and `getp`. The `kwdoc` function gives the list of properties as a docstring. In order to use this in another docstring, first update the `matplotlib.docstring.interpd` object, as seen in this example from `matplotlib.lines`:

```
# in lines.py
docstring.interpd.update(Line2D=artist.kwdoc(Line2D))
```

Then in any function accepting `Line2D` pass-through kwargs, e.g., `matplotlib.axes.Axes.plot()`:

```
# in axes.py
@docstring.dedent_interpd
```

```
def plot(self, *args, **kwargs):
    """
    Some stuff omitted

    The kwargs are Line2D properties:
    %(Line2D)s

    kwargs scalex and scaley, if defined, are passed on
    to autoscale_view to determine whether the x and y axes are
    autoscaled; default True. See Axes.autoscale_view for more
    information
    """
    pass
```

Note there is a problem for `Artist __init__` methods, e.g., `matplotlib.patches.Patch.__init__()`, which supports Patch kwargs, since the artist inspector cannot work until the class is fully defined and we can't modify the `Patch.__init__.__doc__` docstring outside the class definition. There are some manual hacks in this case, violating the "single entry point" requirement above – see the `docstring.interpd.update` calls in `matplotlib.patches`.

79.3 Formatting

The Sphinx website contains plenty of [documentation](#) concerning ReST markup and working with Sphinx in general. Here are a few additional things to keep in mind:

- Please familiarize yourself with the Sphinx directives for [inline markup](#). Matplotlib's documentation makes heavy use of cross-referencing and other semantic markup. For example, when referring to external files, use the `:file:` directive.
- Function arguments and keywords should be referred to using the *emphasis* role. This will keep matplotlib's documentation consistent with Python's documentation:

```
Here is a description of *argument*
```

Please do not use the default `role`:

```
Please do not describe `argument` like this.
```

nor the `literal` role:

```
Please do not describe ``argument`` like this.
```

- Sphinx does not support tables with column- or row-spanning cells for latex output. Such tables can not be used when documenting matplotlib.
- Mathematical expressions can be rendered as png images in html, and in the usual way by latex. For example:

```
:math: `\sin(x_n^2)` yields:  $\sin(x_n^2)$ , and:
```

```
.. math::  
  
\int_{-\infty}^{\infty}\frac{e^{i\phi}}{1+x^2}\frac{e^{i\phi}}{1+x^2}
```

yields:

$$\int_{-\infty}^{\infty} \frac{e^{i\phi}}{1+x^2} \frac{e^{i\phi}}{1+x^2} \quad (79.1)$$

- Interactive IPython sessions can be illustrated in the documentation using the following directive:

```
.. sourcecode:: ipython  
  
In [69]: lines = plot([1,2,3])
```

which would yield:

```
In [69]: lines = plot([1,2,3])
```

- Footnotes¹ can be added using [#]_, followed later by:

```
.. rubric:: Footnotes  
  
.. [#]
```

- Use the *note* and *warning* directives, sparingly, to draw attention to important comments:

```
.. note::  
Here is a note
```

yields:

Note: here is a note

also:

```
Warning: here is a warning
```

- Use the *deprecated* directive when appropriate:

```
.. deprecated:: 0.98  
This feature is obsolete, use something else.
```

yields:

Deprecated since version 0.98: This feature is obsolete, use something else.

¹ For example.

- Use the *versionadded* and *versionchanged* directives, which have similar syntax to the *deprecated* role:

```
.. versionadded:: 0.98
   The transforms have been completely revamped.
```

New in version 0.98: The transforms have been completely revamped.

- Use the *seealso* directive, for example:

```
.. seealso::

   Using ReST :ref:`emacs-helpers` :
       One example

   A bit about :ref:`referring-to-mpl-docs` :
       One more
```

yields:

See also:

Using ResT *Emacs helpers*: One example

A bit about *Referring to mpl documents*: One more

- Please keep the *Glossary* in mind when writing documentation. You can create a references to a term in the glossary with the `:term:` role.
- The autodoc extension will handle index entries for the API, but additional entries in the `index` need to be explicitly added.
- Please limit the text width of docstrings to 70 characters.
- Keyword arguments should be described using a definition list.

Note: matplotlib makes extensive use of keyword arguments as pass-through arguments, there are a many cases where a table is used in place of a definition list for autogenerated sections of docstrings.

79.4 Figures

79.4.1 Dynamically generated figures

Figures can be automatically generated from scripts and included in the docs. It is not necessary to explicitly save the figure in the script, this will be done automatically at build time to ensure that the code that is included runs and produces the advertised figure.

The path should be relative to the doc directory. Any plots specific to the documentation should be added to the `doc/mpl_examples/pyplots` directory and committed to git. Plots from the `examples` directory may be referenced through the symlink `mpl_examples` in the doc directory. e.g.:

```
.. plot:: mpl_examples/pylab_examples/simple_plot.py
```

The `:scale:` directive rescales the image to some percentage of the original size, though we don't recommend using this in most cases since it is probably better to choose the correct figure size and dpi in mpl and let it handle the scaling.

Plot directive documentation

A directive for including a matplotlib plot in a Sphinx document.

By default, in HTML output, `plot` will include a `.png` file with a link to a high-res `.png` and `.pdf`. In LaTeX output, it will include a `.pdf`.

The source code for the plot may be included in one of three ways:

1. A **path to a source file** as the argument to the directive:

```
.. plot:: path/to/plot.py
```

When a path to a source file is given, the content of the directive may optionally contain a caption for the plot:

```
.. plot:: path/to/plot.py

   This is the caption for the plot
```

Additionally, one may specify the name of a function to call (with no arguments) immediately after importing the module:

```
.. plot:: path/to/plot.py plot_function1
```

2. Included as **inline content** to the directive:

```
.. plot::

import matplotlib.pyplot as plt
import matplotlib.image as mpimg
import numpy as np
img = mpimg.imread('_static/stinkbug.png')
imgplot = plt.imshow(img)
```

3. Using **doctest** syntax:

```
.. plot::
A plotting example:
>>> import matplotlib.pyplot as plt
>>> plt.plot([1,2,3], [4,5,6])
```

Options

The `plot` directive supports the following options:

- format** [{ 'python', 'doctest' }] Specify the format of the input
- include-source** [bool] Whether to display the source code. The default can be changed using the `plot_include_source` variable in `conf.py`
- encoding** [str] If this source file is in a non-UTF8 or non-ASCII encoding, the encoding must be specified using the `:encoding:` option. The encoding will not be inferred using the `-*- coding -*-` metacomment.
- context** [bool or str] If provided, the code will be run in the context of all previous plot directives for which the `:context:` option was specified. This only applies to inline code plot directives, not those run from files. If the `:context: reset` option is specified, the context is reset for this and future plots, and previous figures are closed prior to running the code. `:context:close-figs` keeps the context but closes previous figures before running the code.
- nofigs** [bool] If specified, the code block will be run, but no figures will be inserted. This is usually useful with the `:context:` option.

Additionally, this directive supports all of the options of the `image` directive, except for `target` (since `plot` will add its own `target`). These include `alt`, `height`, `width`, `scale`, `align` and `class`.

Configuration options

The `plot` directive has the following configuration options:

- plot_include_source** Default value for the `include-source` option
- plot_html_show_source_link** Whether to show a link to the source in HTML.
- plot_pre_code** Code that should be executed before each plot.
- plot_basedir** Base directory, to which `plot::` file names are relative to. (If `None` or empty, file names are relative to the directory where the file containing the directive is.)
- plot_formats** File formats to generate. List of tuples or strings:

```
[(suffix, dpi), suffix, ...]
```

that determine the file format and the DPI. For entries whose DPI was omitted, sensible defaults are chosen. When passing from the command line through `sphinx_build` the list should be passed as `suffix:dpi,suffix:dpi, ...`

- plot_html_show_formats** Whether to show links to the files in HTML.
- plot_rcparams** A dictionary containing any non-standard rcParams that should be applied before each plot.

plot_apply_rcparams By default, rcParams are applied when `context` option is not used in a plot directive. This configuration option overrides this behavior and applies rcParams before each plot.

plot_working_directory By default, the working directory will be changed to the directory of the example, so the code can get at its data files, if any. Also its path will be added to `sys.path` so it can import any helper modules sitting beside it. This configuration option can be used to specify a central directory (also added to `sys.path`) where data files and helper modules for all code are located.

plot_template Provide a customized template for preparing restructured text.

79.4.2 Static figures

Any figures that rely on optional system configurations need to be handled a little differently. These figures are not to be generated during the documentation build, in order to keep the prerequisites to the documentation effort as low as possible. Please run the `doc/pyplots/make.py` script when adding such figures, and commit the script **and** the images to git. Please also add a line to the README in `doc/pyplots` for any additional requirements necessary to generate a new figure. Once these steps have been taken, these figures can be included in the usual way:

```
.. plot:: mpl_examples/pyplots/tex_unicode_demo.py
   :include-source:
```

79.4.3 Examples

The source of the files in the `examples` directory are automatically included in the HTML docs. An image is generated and included for all examples in the `api` and `pylab_examples` directories. To exclude the example from having an image rendered, insert the following special comment anywhere in the script:

```
# -*- noplot -*-
```

79.4.4 Animations

We have a matplotlib google/gmail account with username `mplgithub` which we used to setup the github account but can be used for other purposes, like hosting google docs or youtube videos. You can embed a matplotlib animation in the docs by first saving the animation as a movie using `matplotlib.animation.Animation.save()`, and then uploading to matplotlib's youtube channel and inserting the embedding string youtube provides like:

```
.. raw:: html

<iframe width="420" height="315"
  src="http://www.youtube.com/embed/32cjc6V00ZY"
  frameborder="0" allowfullscreen>
</iframe>
```

An example save command to generate a movie looks like this

```
ani = animation.FuncAnimation(fig, animate, np.arange(1, len(y)),
                             interval=25, blit=True, init_func=init)

ani.save('double_pendulum.mp4', fps=15)
```

Contact Michael Droettboom for the login password to upload youtube videos of google docs to the mplgithub account.

79.5 Referring to mpl documents

In the documentation, you may want to include to a document in the matplotlib src, e.g., a license file or an image file from `mpl-data`, refer to it via a relative path from the document where the rst file resides, e.g., in `users/navigation_toolbar.rst`, we refer to the image icons with:

```
.. image:: ../../lib/matplotlib/mpl-data/images/subplots.png
```

In the `users` subdirectory, if I want to refer to a file in the `mpl-data` directory, I use the `symlink` directory. For example, from `customizing.rst`:

```
.. literalinclude:: ../../lib/matplotlib/mpl-data/matplotlibrc
```

One exception to this is when referring to the `examples` dir. Relative paths are extremely confusing in the sphinx plot extensions, so without getting into the dirty details, it is easier to simply include a symlink to the files at the top doc level directory. This way, API documents like `matplotlib.pyplot.plot()` can refer to the examples in a known location.

In the top level doc directory we have symlinks pointing to the `mpl` examples:

```
home:~/mpl/doc> ls -l mpl_*
mpl_examples -> ../examples
```

So we can include plots from the `examples` dir using the symlink:

```
.. plot:: mpl_examples/pylab_examples/simple_plot.py
```

We used to use a symlink for `mpl-data` too, but the distro becomes very large on platforms that do not support links (e.g., the font files are duplicated and large)

79.6 Internal section references

To maximize internal consistency in section labeling and references, use hyphen separated, descriptive labels for section references, e.g.,:

```
.. _howto-webapp:
```

and refer to it using the standard reference syntax:

```
See :ref:`howto-webapp`
```

Keep in mind that we may want to reorganize the contents later, so let's avoid top level names in references like `user` or `devel` or `faq` unless necessary, because for example the FAQ “what is a backend?” could later become part of the users guide, so the label:

```
.. _what-is-a-backend
```

is better than:

```
.. _faq-backend
```

In addition, since underscores are widely used by Sphinx itself, let's prefer hyphens to separate words.

79.7 Section names, etc

For everything but top level chapters, please use Upper lower for section titles, e.g., Possible hangups rather than Possible Hangups

79.8 Inheritance diagrams

Class inheritance diagrams can be generated with the `inheritance-diagram` directive. To use it, you provide the directive with a number of class or module names (separated by whitespace). If a module name is provided, all classes in that module will be used. All of the ancestors of these classes will be included in the inheritance diagram.

A single option is available: `parts` controls how many of parts in the path to the class are shown. For example, if `parts == 1`, the class `matplotlib.patches.Patch` is shown as `Patch`. If `parts == 2`, it is shown as `patches.Patch`. If `parts == 0`, the full path is shown.

Example:

```
.. inheritance-diagram:: matplotlib.patches matplotlib.lines matplotlib.text
   :parts: 2
```

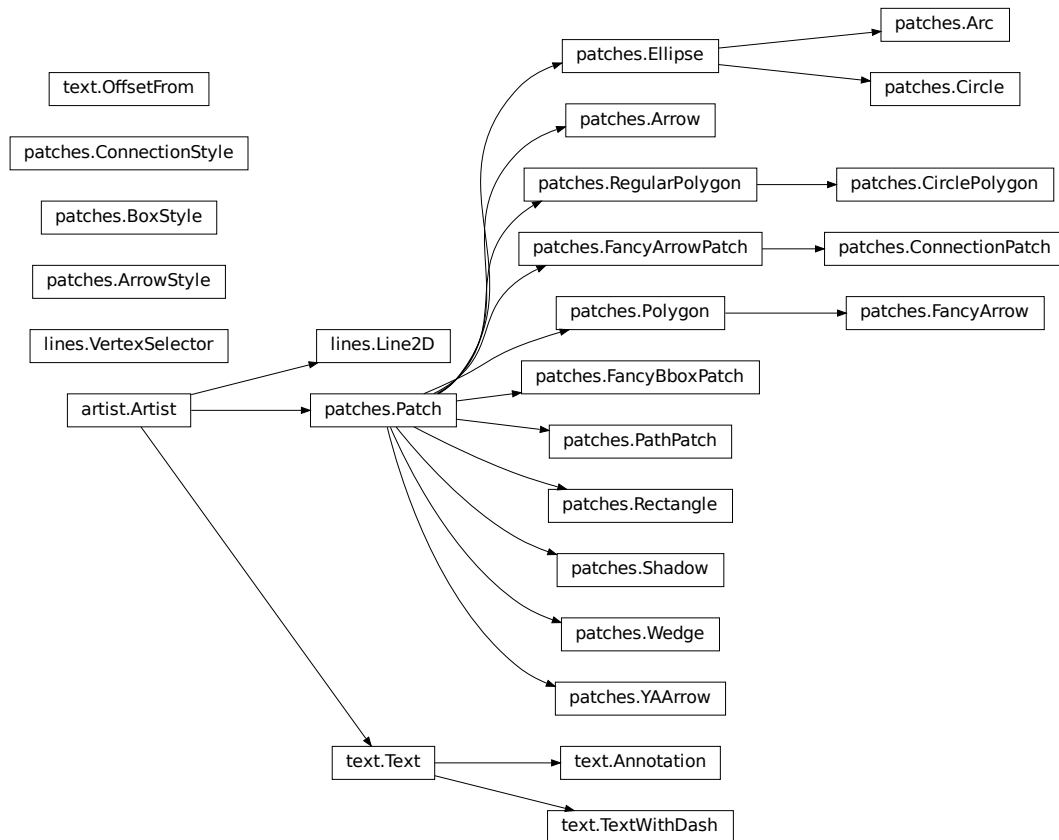

79.9 Emacs helpers

There is an emacs mode `rst.el` which automates many important ReST tasks like building and updating table-of-contents, and promoting or demoting section headings. Here is the basic `.emacs` configuration:

```
(require 'rst)
(setq auto-mode-alist
      (append '(("\\.txt$" . rst-mode)
                ("\\.rst$" . rst-mode)
                ("\\.rest$" . rst-mode)) auto-mode-alist))
```

Some helpful functions:

C-c TAB - `rst-toc-insert`

Insert table of contents at point

C-c C-u - `rst-toc-update`

Update the table of contents at point

C-c C-l rst-shift-region-left

Shift region to the left

C-c C-r rst-shift-region-right

Shift region to the right

DEVELOPER'S GUIDE FOR CREATING SCALES AND TRANSFORMATIONS

Matplotlib supports the addition of custom procedures that transform the data before it is displayed.

There is an important distinction between two kinds of transformations. Separable transformations, working on a single dimension, are called “scales”, and non-separable transformations, that handle data in two or more dimensions at a time, are called “projections”.

From the user's perspective, the scale of a plot can be set with `set_xscale()` and `set_yscale()`. Projections can be chosen using the `projection` keyword argument to the `plot()` or `subplot()` functions, e.g.:

```
plot(x, y, projection="custom")
```

This document is intended for developers and advanced users who need to create new scales and projections for matplotlib. The necessary code for scales and projections can be included anywhere: directly within a plot script, in third-party code, or in the matplotlib source tree itself.

80.1 Creating a new scale

Adding a new scale consists of defining a subclass of `matplotlib.scale.ScaleBase`, that includes the following elements:

- A transformation from data coordinates into display coordinates.
- An inverse of that transformation. This is used, for example, to convert mouse positions from screen space back into data space.
- A function to limit the range of the axis to acceptable values (`limit_range_for_scale()`). A log scale, for instance, would prevent the range from including values less than or equal to zero.
- Locators (major and minor) that determine where to place ticks in the plot, and optionally, how to adjust the limits of the plot to some “good” values. Unlike `limit_range_for_scale()`, which is always enforced, the range setting here is only used when automatically setting the range of the plot.
- Formatters (major and minor) that specify how the tick labels should be drawn.

Once the class is defined, it must be registered with matplotlib so that the user can select it.

A full-fledged and heavily annotated example is in `examples/api/custom_scale_example.py`. There are also some classes in `matplotlib.scale` that may be used as starting points.

80.2 Creating a new projection

Adding a new projection consists of defining a projection axes which subclasses `matplotlib.axes.Axes` and includes the following elements:

- A transformation from data coordinates into display coordinates.
- An inverse of that transformation. This is used, for example, to convert mouse positions from screen space back into data space.
- Transformations for the gridlines, ticks and ticklabels. Custom projections will often need to place these elements in special locations, and matplotlib has a facility to help with doing so.
- Setting up default values (overriding `cla()`), since the defaults for a rectilinear axes may not be appropriate.
- Defining the shape of the axes, for example, an elliptical axes, that will be used to draw the background of the plot and for clipping any data elements.
- Defining custom locators and formatters for the projection. For example, in a geographic projection, it may be more convenient to display the grid in degrees, even if the data is in radians.
- Set up interactive panning and zooming. This is left as an “advanced” feature left to the reader, but there is an example of this for polar plots in `matplotlib.projections.polar`.
- Any additional methods for additional convenience or features.

Once the projection axes is defined, it can be used in one of two ways:

- By defining the class attribute name, the projection axes can be registered with `matplotlib.projections.register_projection()` and subsequently simply invoked by name:

```
plt.axes(projection='my_proj_name')
```

- For more complex, parameterisable projections, a generic “projection” object may be defined which includes the method `_as_mpl_axes`. `_as_mpl_axes` should take no arguments and return the projection’s axes subclass and a dictionary of additional arguments to pass to the subclass’ `__init__` method. Subsequently a parameterised projection can be initialised with:

```
plt.axes(projection=MyProjection(param1=param1_value))
```

where `MyProjection` is an object which implements a `_as_mpl_axes` method.

A full-fledged and heavily annotated example is in `examples/api/custom_projection_example.py`. The polar plot functionality in `matplotlib.projections.polar` may also be of interest.

80.3 API documentation

- `matplotlib.scale`
- `matplotlib.projections`
- `matplotlib.projections.polar`

DEVELOPER'S TIPS FOR WRITING CODE FOR PYTHON 2 AND 3

As of matplotlib 1.4, the `six` library is used to support Python 2 and 3 from a single code base. The `2to3` tool is no longer used.

This document describes some of the issues with that approach and some recommended solutions. It is not a complete guide to Python 2 and 3 compatibility.

81.1 Welcome to the `__future__`

The top of every py file should include the following:

```
from __future__ import (absolute_import, division,
                        print_function, unicode_literals)
import six
```

This will make the Python 2 interpreter behave as close to Python 3 as possible.

All matplotlib files should also import `six`, whether they are using it or not, just to make moving code between modules easier, as `six` gets used *a lot*.

81.2 Finding places to use `six`

The only way to make sure code works on both Python 2 and 3 is to make sure it is covered by unit tests.

However, the `2to3` commandline tool can also be used to locate places that require special handling with `six`.

(The `modernize` tool may also be handy, though I've never used it personally).

The `six` documentation serves as a good reference for the sorts of things that need to be updated.

81.3 The dreaded `\u` escapes

When `from __future__ import unicode_literals` is used, all string literals (not preceded with a `b`) will become unicode literals.

Normally, one would use “raw” string literals to encode strings that contain a lot of slashes that we don’t want Python to interpret as special characters. A common example in matplotlib is when it deals with TeX and has to represent things like `r"\usepackage{foo}"`. Unfortunately, on Python 2 there is no way to represent `u` in a raw unicode string literal, since it will always be interpreted as the start of a unicode character escape, such as `u20af`. The only solution is to use a regular (non-raw) string literal and repeat all slashes, e.g. `"\\usepackage{foo}"`.

The following shows the problem on Python 2:

```
>>> ur'\u'
File "<stdin>", line 1
SyntaxError: (unicode error) 'rawunicodeescape' codec can't decode bytes in
position 0-1: truncated \uXXXX
>>> ur'\\u'
u'\\\\u'
>>> u'\u'
File "<stdin>", line 1
SyntaxError: (unicode error) 'unicodeescape' codec can't decode bytes in
position 0-1: truncated \uXXXX escape
>>> u'\\u'
u'\\u'
```

This bug has been fixed in Python 3, however, we can’t take advantage of that and still support Python 2:

```
>>> r'\u'
'\\u'
>>> r'\\u'
'\\\\u'
>>> '\u'
File "<stdin>", line 1
SyntaxError: (unicode error) 'unicodeescape' codec can't decode bytes in
position 0-1: truncated \uXXXX escape
>>> '\\u'
'\\u'
```

81.4 Iteration

The behavior of the methods for iterating over the items, values and keys of a dictionary has changed in Python 3. Additionally, other built-in functions such as `zip`, `range` and `map` have changed to return iterators rather than temporary lists.

In many cases, the performance implications of iterating vs. creating a temporary list won’t matter, so it’s tempting to use the form that is simplest to read. However, that results in code that behaves differently on Python 2 and 3, leading to subtle bugs that may not be detected by the regression tests. Therefore, unless the loop in question is provably simple and doesn’t call into other code, the six versions that ensure the same behavior on both Python 2 and 3 should be used. The following table shows the mapping of equivalent semantics between Python 2, 3 and six for `dict.items()`:

Python 2	Python 3	six
<code>d.items()</code>	<code>list(d.items())</code>	<code>list(six.iteritems(d))</code>
<code>d.iteritems()</code>	<code>d.items()</code>	<code>six.iteritems(d)</code>

81.5 Numpy-specific things

When specifying dtypes, all strings must be byte strings on Python 2 and unicode strings on Python 3. The best way to handle this is to force cast them using `str()`. The same is true of structure specifiers in the `struct` built-in module.

WORKING WITH *MATPLOTLIB* SOURCE CODE

Contents:

82.1 Introduction

These pages describe a [git](#) and [github](#) workflow for the [Matplotlib](#) project.

There are several different workflows here, for different ways of working with *Matplotlib*.

This is not a comprehensive [git](#) reference, it's just a workflow for our own project. It's tailored to the [github](#) hosting service. You may well find better or quicker ways of getting stuff done with [git](#), but these should get you started.

For general resources for learning [git](#), see [git resources](#).

82.2 Install [git](#)

82.2.1 Overview

Debian / Ubuntu	<code>sudo apt-get install git</code>
Fedora	<code>sudo yum install git</code>
Windows	Download and install msysGit
OS X	Use the git-osx-installer

82.2.2 In detail

See the [git](#) page for the most recent information.

Have a look at the [github](#) install help pages available from [github help](#)

There are good instructions here: <https://git-scm.com/book/en/v2/Getting-Started-Installing-Git>

82.3 Following the latest source

These are the instructions if you just want to follow the latest *Matplotlib* source, but you don't need to do any development for now.

The steps are:

- *Install git*
- get local copy of the [Matplotlib github](#) git repository
- update local copy from time to time

82.3.1 Get the local copy of the code

From the command line:

```
git clone git://github.com/matplotlib/matplotlib.git
```

You now have a copy of the code tree in the new `matplotlib` directory.

82.3.2 Updating the code

From time to time you may want to pull down the latest code. Do this with:

```
cd matplotlib
git pull
```

The tree in `matplotlib` will now have the latest changes from the initial repository.

82.4 Making a patch

You've discovered a bug or something else you want to change in [Matplotlib](#) .. — excellent!

You've worked out a way to fix it — even better!

You want to tell us about it — best of all!

The easiest way is to make a *patch* or set of patches. Here we explain how. Making a patch is the simplest and quickest, but if you're going to be doing anything more than simple quick things, please consider following the *Git for development* model instead.

82.4.1 Making patches

Overview

```

# tell git who you are
git config --global user.email you@yourdomain.example.com
git config --global user.name "Your Name Comes Here"
# get the repository if you don't have it
git clone git://github.com/matplotlib/matplotlib.git
# make a branch for your patching
cd matplotlib
git branch the-fix-im-thinking-of
git checkout the-fix-im-thinking-of
# hack, hack, hack
# Tell git about any new files you've made
git add somewhere/tests/test_my_bug.py
# commit work in progress as you go
git commit -am 'BF - added tests for Funny bug'
# hack hack, hack
git commit -am 'BF - added fix for Funny bug'
# make the patch files
git format-patch -M -C master

```

Then, send the generated patch files to the [Matplotlib mailing list](#) — where we will thank you warmly.

In detail

1. Tell git who you are so it can label the commits you've made:

```

git config --global user.email you@yourdomain.example.com
git config --global user.name "Your Name Comes Here"

```

2. If you don't already have one, clone a copy of the [Matplotlib](#) repository:

```

git clone git://github.com/matplotlib/matplotlib.git
cd matplotlib

```

3. Make a 'feature branch'. This will be where you work on your bug fix. It's nice and safe and leaves you with access to an unmodified copy of the code in the main branch:

```

git branch the-fix-im-thinking-of
git checkout the-fix-im-thinking-of

```

4. Do some edits, and commit them as you go:

```

# hack, hack, hack
# Tell git about any new files you've made
git add somewhere/tests/test_my_bug.py
# commit work in progress as you go
git commit -am 'BF - added tests for Funny bug'
# hack hack, hack
git commit -am 'BF - added fix for Funny bug'

```

Note the `-am` options to `commit`. The `m` flag just signals that you're going to type a message on the command line. The `a` flag — you can just take on faith — or see [why the -a flag?](#).

5. When you have finished, check you have committed all your changes:

```
git status
```

6. Finally, make your commits into patches. You want all the commits since you branched from the master branch:

```
git format-patch -M -C master
```

You will now have several files named for the commits:

```
0001-BF-added-tests-for-Funny-bug.patch
0002-BF-added-fix-for-Funny-bug.patch
```

Send these files to the [Matplotlib mailing list](#).

When you are done, to switch back to the main copy of the code, just return to the master branch:

```
git checkout master
```

82.4.2 Moving from patching to development

If you find you have done some patches, and you have one or more feature branches, you will probably want to switch to development mode. You can do this with the repository you have.

Fork the [Matplotlib repository on github](#) — *Making your own copy (fork) of Matplotlib*. Then:

```
# checkout and refresh master branch from main repo
git checkout master
git pull origin master
# rename pointer to main repository to 'upstream'
git remote rename origin upstream
# point your repo to default read / write to your fork on github
git remote add origin git@github.com:your-user-name/matplotlib.git
# push up any branches you've made and want to keep
git push origin the-fix-im-thinking-of
```

Then you can, if you want, follow the *Development workflow*.

82.5 Git for development

Contents:

82.5.1 Making your own copy (fork) of Matplotlib

You need to do this only once. The instructions here are very similar to the instructions at <https://help.github.com/forking/> — please see that page for more detail. We're repeating some of it here just to give the specifics for the [Matplotlib project](#), and to suggest some default names.

Set up and configure a github account

If you don't have a github account, go to the [github page](#), and make one.

You then need to configure your account to allow write access — see the [Generating SSH keys help on github help](#).

Create your own forked copy of Matplotlib

1. Log into your github account.
2. Go to the [Matplotlib github home](#) at [Matplotlib github](#).
3. Click on the *fork* button:

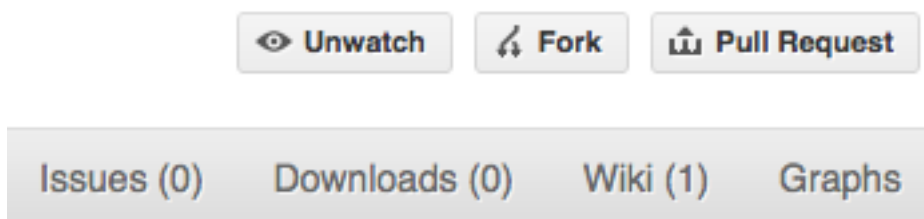

Now, after a short pause, you should find yourself at the home page for your own forked copy of [Matplotlib](#).

82.5.2 Set up your fork

First you follow the instructions for *Making your own copy (fork) of Matplotlib*.

Overview

```
git clone git@github.com:your-user-name/matplotlib.git
cd matplotlib
git remote add upstream git://github.com/matplotlib/matplotlib.git
```

In detail

Clone your fork

1. Clone your fork to the local computer with `git clone git@github.com:your-user-name/matplotlib.git`
2. Investigate. Change directory to your new repo: `cd matplotlib`. Then `git branch -a` to show you all branches. You'll get something like:

```
* master
remotes/origin/master
```

This tells you that you are currently on the master branch, and that you also have a remote connection to origin/master. What remote repository is remote/origin? Try `git remote -v` to see the URLs for the remote. They will point to your github fork.

Now you want to connect to the upstream [Matplotlib github](#) repository, so you can merge in changes from trunk.

Linking your repository to the upstream repo

```
cd matplotlib
git remote add upstream git://github.com/matplotlib/matplotlib.git
```

upstream here is just the arbitrary name we're using to refer to the main [Matplotlib](#) repository at [Matplotlib github](#).

Note that we've used `git://` for the URL rather than `git@`. The `git://` URL is read only. This means we that we can't accidentally (or deliberately) write to the upstream repo, and we are only going to use it to merge into our own code.

Just for your own satisfaction, show yourself that you now have a new 'remote', with `git remote -v show`, giving you something like:

```
upstream    git://github.com/matplotlib/matplotlib.git (fetch)
upstream    git://github.com/matplotlib/matplotlib.git (push)
origin      git@github.com:your-user-name/matplotlib.git (fetch)
origin      git@github.com:your-user-name/matplotlib.git (push)
```

82.5.3 Configure git

Overview

Your personal git configurations are saved in the `.gitconfig` file in your home directory.

Here is an example `.gitconfig` file:

```
[user]
  name = Your Name
  email = you@yourdomain.example.com

[alias]
  ci = commit -a
  co = checkout
  st = status
  stat = status
  br = branch
  wdiff = diff --color-words

[core]
  editor = vim
```

```
[merge]
    summary = true
```

You can edit this file directly or you can use the `git config --global` command:

```
git config --global user.name "Your Name"
git config --global user.email you@yourdomain.example.com
git config --global alias.ci "commit -a"
git config --global alias.co checkout
git config --global alias.st "status -a"
git config --global alias.stat "status -a"
git config --global alias.br branch
git config --global alias.wdiff "diff --color-words"
git config --global core.editor vim
git config --global merge.summary true
```

To set up on another computer, you can copy your `~/.gitconfig` file, or run the commands above.

In detail

user.name and user.email

It is good practice to tell `git` who you are, for labeling any changes you make to the code. The simplest way to do this is from the command line:

```
git config --global user.name "Your Name"
git config --global user.email you@yourdomain.example.com
```

This will write the settings into your git configuration file, which should now contain a user section with your name and email:

```
[user]
    name = Your Name
    email = you@yourdomain.example.com
```

Of course you'll need to replace `Your Name` and `you@yourdomain.example.com` with your actual name and email address.

Aliases

You might well benefit from some aliases to common commands.

For example, you might well want to be able to shorten `git checkout` to `git co`. Or you may want to alias `git diff --color-words` (which gives a nicely formatted output of the diff) to `git wdiff`

The following `git config --global` commands:

```
git config --global alias.ci "commit -a"
git config --global alias.co checkout
```

```
git config --global alias.st "status -a"
git config --global alias.stat "status -a"
git config --global alias.br branch
git config --global alias.wdiff "diff --color-words"
```

will create an alias section in your `.gitconfig` file with contents like this:

```
[alias]
  ci = commit -a
  co = checkout
  st = status -a
  stat = status -a
  br = branch
  wdiff = diff --color-words
```

Editor

You may also want to make sure that your editor of choice is used

```
git config --global core.editor vim
```

Merging

To enforce summaries when doing merges (`~/ .gitconfig` file again):

```
[merge]
  log = true
```

Or from the command line:

```
git config --global merge.log true
```

Fancy log output

This is a very nice alias to get a fancy log output; it should go in the alias section of your `.gitconfig` file:

```
lg = log --graph --pretty=format:'%Cred%h%Creset -%C(yellow)%d%Creset %s %Cgreen(%cr)
↪-%C(bold blue)[%an]%Creset' --abbrev-commit --date=relative
```

You use the alias with:

```
git lg
```

and it gives graph / text output something like this (but with color!):

```

* 6d8e1ee - (HEAD, origin/my-fancy-feature, my-fancy-feature) NF - a fancy file (45
↳minutes ago) [Matthew Brett]
* d304a73 - (origin/placeholder, placeholder) Merge pull request #48 from hhuuggoo/
↳master (2 weeks ago) [Jonathan Terhorst]
|\
| * 4aff2a8 - fixed bug 35, and added a test in test_bugfixes (2 weeks ago) [Hugo]
|/
* a7ff2e5 - Added notes on discussion/proposal made during Data Array Summit. (2 weeks
↳ago) [Corran Webster]
* 68f6752 - Initial implimentation of AxisIndexer - uses 'index_by' which needs to be
↳changed to a call on an Axes object - this is all very sketchy right now. (2 weeks
↳ago) [Corr
* 376adbd - Merge pull request #46 from terhorst/master (2 weeks ago) [Jonathan
↳Terhorst]
|\
| * b605216 - updated joshu example to current api (3 weeks ago) [Jonathan Terhorst]
| * 2e991e8 - add testing for outer ufunc (3 weeks ago) [Jonathan Terhorst]
| * 7beda5a - prevent axis from throwing an exception if testing equality with non-axis
↳object (3 weeks ago) [Jonathan Terhorst]
| * 65af65e - convert unit testing code to assertions (3 weeks ago) [Jonathan Terhorst]
| * 956fbab - Merge remote-tracking branch 'upstream/master' (3 weeks ago) [Jonathan
↳Terhorst]
| |\
| |/\

```

Thanks to Yury V. Zaytsev for posting it.

82.5.4 Development workflow

You already have your own forked copy of the [Matplotlib](#) repository, by following *Making your own copy (fork) of Matplotlib*. You have *Set up your fork*. You have configured git by following *Configure git*. Now you are ready for some real work.

Workflow summary

In what follows we'll refer to the upstream Matplotlib master branch, as “trunk”.

- Don't use your master branch for anything. Consider deleting it.
- When you are starting a new set of changes, fetch any changes from trunk, and start a new *feature branch* from that.
- Make a new branch for each separable set of changes — “one task, one branch” ([ipython git workflow](#)).
- Name your branch for the purpose of the changes - e.g. `bugfix-for-issue-14` or `refactor-database-code`.
- If you can possibly avoid it, avoid merging trunk or any other branches into your feature branch while you are working.
- If you do find yourself merging from trunk, consider *Rebasing on trunk*

- Ask on the [Matplotlib mailing list](#) if you get stuck.
- Ask for code review!

This way of working helps to keep work well organized, with readable history. This in turn makes it easier for project maintainers (that might be you) to see what you've done, and why you did it.

See [linux git workflow](#) and [ipython git workflow](#) for some explanation.

Consider deleting your master branch

It may sound strange, but deleting your own `master` branch can help reduce confusion about which branch you are on. See [deleting master on github](#) for details.

Update the mirror of trunk

First make sure you have done *Linking your repository to the upstream repo*.

From time to time you should fetch the upstream (trunk) changes from github:

```
git fetch upstream
```

This will pull down any commits you don't have, and set the remote branches to point to the right commit. For example, 'trunk' is the branch referred to by (remote/branchname) `upstream/master` - and if there have been commits since you last checked, `upstream/master` will change after you do the fetch.

Make a new feature branch

When you are ready to make some changes to the code, you should start a new branch. Branches that are for a collection of related edits are often called 'feature branches'.

Making an new branch for each set of related changes will make it easier for someone reviewing your branch to see what you are doing.

Choose an informative name for the branch to remind yourself and the rest of us what the changes in the branch are for. For example `add-ability-to-fly`, or `buxfix-for-issue-42`.

```
# Update the mirror of trunk
git fetch upstream
# Make new feature branch starting at current trunk
git branch my-new-feature upstream/master
git checkout my-new-feature
```

Generally, you will want to keep your feature branches on your public [github](#) fork of [Matplotlib](#). To do this, you [git push](#) this new branch up to your github repo. Generally (if you followed the instructions in these pages, and by default), git will have a link to your github repo, called `origin`. You push up to your own repo on github with:

```
git push origin my-new-feature
```

In git >= 1.7 you can ensure that the link is correctly set by using the `--set-upstream` option:

```
git push --set-upstream origin my-new-feature
```

From now on git will know that `my-new-feature` is related to the `my-new-feature` branch in the github repo.

The editing workflow

Overview

```
# hack hack
git add my_new_file
git commit -am 'NF - some message'
git push
```

In more detail

1. Make some changes
2. See which files have changed with `git status` (see [git status](#)). You'll see a listing like this one:

```
# On branch ny-new-feature
# Changed but not updated:
#   (use "git add <file>..." to update what will be committed)
#   (use "git checkout -- <file>..." to discard changes in working directory)
#
# modified:   README
#
# Untracked files:
#   (use "git add <file>..." to include in what will be committed)
#
# INSTALL
no changes added to commit (use "git add" and/or "git commit -a")
```

3. Check what the actual changes are with `git diff` ([git diff](#)).
4. Add any new files to version control `git add new_file_name` (see [git add](#)).
5. To commit all modified files into the local copy of your repo,, do `git commit -am 'A commit message'`. Note the `-am` options to `commit`. The `m` flag just signals that you're going to type a message on the command line. The `a` flag — you can just take on faith — or see [why the -a flag?](#) — and the helpful use-case description in the [tangled working copy problem](#). The [git commit manual](#) page might also be useful.
6. To push the changes up to your forked repo on github, do a `git push` (see [git push](#)).

Ask for your changes to be reviewed or merged

When you are ready to ask for someone to review your code and consider a merge:

1. Go to the URL of your forked repo, say `https://github.com/your-user-name/matplotlib`.
2. Use the ‘Switch Branches’ dropdown menu near the top left of the page to select the branch with your changes:

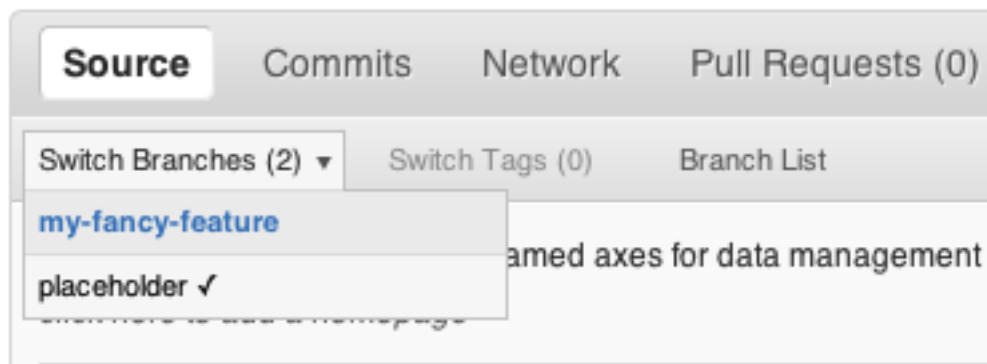

3. Click on the ‘Pull request’ button:

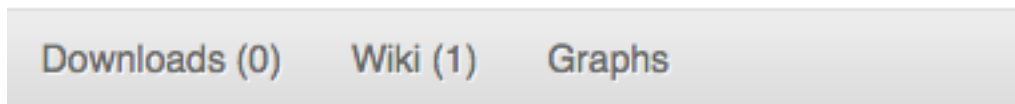

Enter a title for the set of changes, and some explanation of what you’ve done. Say if there is anything you’d like particular attention for - like a complicated change or some code you are not happy with.

If you don’t think your request is ready to be merged, just say so in your pull request message. This is still a good way of getting some preliminary code review.

Some other things you might want to do

Delete a branch on github

```
git checkout master
# delete branch locally
git branch -D my-unwanted-branch
# delete branch on github
git push origin :my-unwanted-branch
```

Note the colon `:` before `my-unwanted-branch`. See also: <https://help.github.com/articles/pushing-to-a-remote/#deleting-a-remote-branch-or-tag>

Several people sharing a single repository

If you want to work on some stuff with other people, where you are all committing into the same repository, or even the same branch, then just share it via github.

First fork Matplotlib into your account, as from *Making your own copy (fork) of Matplotlib*.

Then, go to your forked repository github page, say `https://github.com/your-user-name/matplotlib`

Click on the 'Admin' button, and add anyone else to the repo as a collaborator:

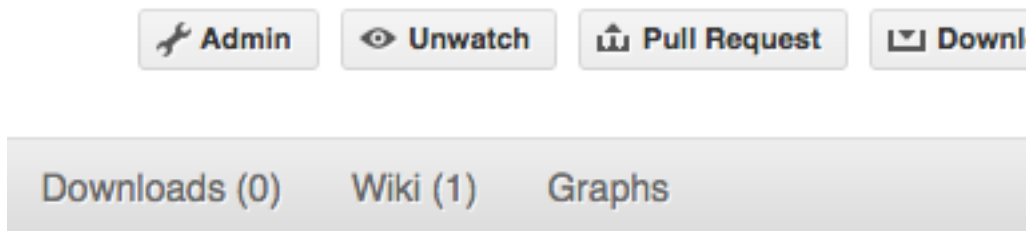

Now all those people can do:

```
git clone git@github.com:your-user-name/matplotlib.git
```

Remember that links starting with `git@` use the ssh protocol and are read-write; links starting with `git://` are read-only.

Your collaborators can then commit directly into that repo with the usual:

```
git commit -am 'ENH - much better code'
git push origin master # pushes directly into your repo
```

Explore your repository

To see a graphical representation of the repository branches and commits:

```
gitk --all
```

To see a linear list of commits for this branch:

```
git log
```

You can also look at the [network graph visualizer](#) for your github repo.

Finally the *Fancy log output* `lg` alias will give you a reasonable text-based graph of the repository.

Rebasing on trunk

Let's say you thought of some work you'd like to do. You *Update the mirror of trunk* and *Make a new feature branch* called `cool-feature`. At this stage trunk is at some commit, let's call it E. Now you make

some new commits on your `cool-feature` branch, let's call them A, B, C. Maybe your changes take a while, or you come back to them after a while. In the meantime, trunk has progressed from commit E to commit (say) G:

```
      A---B---C cool-feature
     /
D---E---F---G trunk
```

At this stage you consider merging trunk into your feature branch, and you remember that this here page sternly advises you not to do that, because the history will get messy. Most of the time you can just ask for a review, and not worry that trunk has got a little ahead. But sometimes, the changes in trunk might affect your changes, and you need to harmonize them. In this situation you may prefer to do a rebase.

rebase takes your changes (A, B, C) and replays them as if they had been made to the current state of `trunk`. In other words, in this case, it takes the changes represented by A, B, C and replays them on top of G. After the rebase, your history will look like this:

```
      A'--B'--C' cool-feature
     /
D---E---F---G trunk
```

See [rebase without tears](#) for more detail.

To do a rebase on trunk:

```
# Update the mirror of trunk
git fetch upstream
# go to the feature branch
git checkout cool-feature
# make a backup in case you mess up
git branch tmp cool-feature
# rebase cool-feature onto trunk
git rebase --onto upstream/master upstream/master cool-feature
```

In this situation, where you are already on branch `cool-feature`, the last command can be written more succinctly as:

```
git rebase upstream/master
```

When all looks good you can delete your backup branch:

```
git branch -D tmp
```

If it doesn't look good you may need to have a look at [Recovering from mess-ups](#).

If you have made changes to files that have also changed in trunk, this may generate merge conflicts that you need to resolve - see the [git rebase](#) man page for some instructions at the end of the "Description" section. There is some related help on merging in the git user manual - see [resolving a merge](#).

Recovering from mess-ups

Sometimes, you mess up merges or rebases. Luckily, in git it is relatively straightforward to recover from such mistakes.

If you mess up during a rebase:

```
git rebase --abort
```

If you notice you messed up after the rebase:

```
# reset branch back to the saved point
git reset --hard tmp
```

If you forgot to make a backup branch:

```
# look at the reflog of the branch
git reflog show cool-feature

8630830 cool-feature@{0}: commit: BUG: io: close file handles immediately
278dd2a cool-feature@{1}: rebase finished: refs/heads/my-feature-branch onto
↪11ee694744f2552d
26aa21a cool-feature@{2}: commit: BUG: lib: make seek_gzip_factory not leak gzip obj
...

# reset the branch to where it was before the botched rebase
git reset --hard cool-feature@{2}
```

Rewriting commit history

Note: Do this only for your own feature branches.

There's an embarrassing typo in a commit you made? Or perhaps the you made several false starts you would like the posterity not to see.

This can be done via *interactive rebasing*.

Suppose that the commit history looks like this:

```
git log --oneline
eadc391 Fix some remaining bugs
a815645 Modify it so that it works
2de1ac Fix a few bugs + disable
13d7934 First implementation
6ad92e5 * masked is now an instance of a new object, MaskedConstant
29001ed Add pre-nep for a copule of structured_array_extensions.
...
```

and 6ad92e5 is the last commit in the cool-feature branch. Suppose we want to make the following changes:

- Rewrite the commit message for 13d7934 to something more sensible.
- Combine the commits 2dec1ac, a815645, eadc391 into a single one.

We do as follows:

```
# make a backup of the current state
git branch tmp HEAD
# interactive rebase
git rebase -i 6ad92e5
```

This will open an editor with the following text in it:

```
pick 13d7934 First implementation
pick 2dec1ac Fix a few bugs + disable
pick a815645 Modify it so that it works
pick eadc391 Fix some remaining bugs

# Rebase 6ad92e5..eadc391 onto 6ad92e5
#
# Commands:
# p, pick = use commit
# r, reword = use commit, but edit the commit message
# e, edit = use commit, but stop for amending
# s, squash = use commit, but meld into previous commit
# f, fixup = like "squash", but discard this commit's log message
#
# If you remove a line here THAT COMMIT WILL BE LOST.
# However, if you remove everything, the rebase will be aborted.
#
```

To achieve what we want, we will make the following changes to it:

```
r 13d7934 First implementation
pick 2dec1ac Fix a few bugs + disable
f a815645 Modify it so that it works
f eadc391 Fix some remaining bugs
```

This means that (i) we want to edit the commit message for 13d7934, and (ii) collapse the last three commits into one. Now we save and quit the editor.

Git will then immediately bring up an editor for editing the commit message. After revising it, we get the output:

```
[detached HEAD 721fc64] FOO: First implementation
 2 files changed, 199 insertions(+), 66 deletions(-)
[detached HEAD 0f22701] Fix a few bugs + disable
 1 files changed, 79 insertions(+), 61 deletions(-)
Successfully rebased and updated refs/heads/my-feature-branch.
```

and the history looks now like this:

```
0f22701 Fix a few bugs + disable
721fc64 ENH: Sophisticated feature
6ad92e5 * masked is now an instance of a new object, MaskedConstant
```

If it went wrong, recovery is again possible as explained *above*.

82.5.5 Maintainer workflow

This page is for maintainers — those of us who merge our own or other peoples’ changes into the upstream repository.

Being as how you’re a maintainer, you are completely on top of the basic stuff in *Development workflow*.

The instructions in *Linking your repository to the upstream repo* add a remote that has read-only access to the upstream repo. Being a maintainer, you’ve got read-write access.

It’s good to have your upstream remote have a scary name, to remind you that it’s a read-write remote:

```
git remote add upstream-rw git@github.com:matplotlib/matplotlib.git
git fetch upstream-rw
```

Integrating changes

Let’s say you have some changes that need to go into trunk (upstream-rw/master).

The changes are in some branch that you are currently on. For example, you are looking at someone’s changes like this:

```
git remote add someone git://github.com/someone/matplotlib.git
git fetch someone
git branch cool-feature --track someone/cool-feature
git checkout cool-feature
```

So now you are on the branch with the changes to be incorporated upstream. The rest of this section assumes you are on this branch.

A few commits

If there are only a few commits, consider rebasing to upstream:

```
# Fetch upstream changes
git fetch upstream-rw
# rebase
git rebase upstream-rw/master
```

Remember that, if you do a rebase, and push that, you’ll have to close any github pull requests manually, because github will not be able to detect the changes have already been merged.

A long series of commits

If there are a longer series of related commits, consider a merge instead:

```
git fetch upstream-rw
git merge --no-ff upstream-rw/master
```

The merge will be detected by github, and should close any related pull requests automatically.

Note the `--no-ff` above. This forces git to make a merge commit, rather than doing a fast-forward, so that these set of commits branch off trunk then rejoin the main history with a merge, rather than appearing to have been made directly on top of trunk.

Check the history

Now, in either case, you should check that the history is sensible and you have the right commits:

```
git log --oneline --graph
git log -p upstream-rw/master..
```

The first line above just shows the history in a compact way, with a text representation of the history graph. The second line shows the log of commits excluding those that can be reached from trunk (`upstream-rw/master`), and including those that can be reached from current HEAD (implied with the `..` at the end). So, it shows the commits unique to this branch compared to trunk. The `-p` option shows the diff for these commits in patch form.

Push to trunk

```
git push upstream-rw my-new-feature:master
```

This pushes the `my-new-feature` branch in this repository to the `master` branch in the `upstream-rw` repository.

82.6 git resources

82.6.1 Tutorials and summaries

- [github help](#) has an excellent series of how-to guides.
- The [pro git book](#) is a good in-depth book on git.
- A [git cheat sheet](#) is a page giving summaries of common commands.
- The [git user manual](#)
- The [git tutorial](#)
- The [git community book](#)

- [git ready](#) — a nice series of tutorials
- [git magic](#) — extended introduction with intermediate detail
- The [git parable](#) is an easy read explaining the concepts behind git.
- [git foundation](#) expands on the [git parable](#).
- Fernando Perez' [git page](#) — [Fernando's git page](#) — many links and tips
- A good but technical page on [git concepts](#)
- [git svn crash course](#): git for those of us used to [subversion](#)

82.6.2 Advanced git workflow

There are many ways of working with git; here are some posts on the rules of thumb that other projects have come up with:

- Linus Torvalds on [git management](#)
- Linus Torvalds on [linux git workflow](#) . Summary; use the git tools to make the history of your edits as clean as possible; merge from upstream edits as little as possible in branches where you are doing active development.

82.6.3 Manual pages online

You can get these on your own machine with (e.g) `git help push` or (same thing) `git push --help`, but, for convenience, here are the online manual pages for some common commands:

- [git add](#)
- [git branch](#)
- [git checkout](#)
- [git clone](#)
- [git commit](#)
- [git config](#)
- [git diff](#)
- [git log](#)
- [git pull](#)
- [git push](#)
- [git remote](#)
- [git status](#)

82.7 Two and three dots in difference specs

Thanks to Yarik Halchenko for this explanation.

Imagine a series of commits A, B, C, D... Imagine that there are two branches, *topic* and *master*. You branched *topic* off *master* when *master* was at commit 'E'. The graph of the commits looks like this:

```
    A---B---C topic
   /
  D---E---F---G master
```

Then:

```
git diff master..topic
```

will output the difference from G to C (i.e. with effects of F and G), while:

```
git diff master...topic
```

would output just differences in the topic branch (i.e. only A, B, and C).

REVIEWERS GUIDELINE

83.1 Pull request checklist

83.1.1 Branch selection

- In general, simple bugfixes that are unlikely to introduce new bugs of their own should be merged onto the maintenance branch. New features, or anything that changes the API, should be made against master. The rules are fuzzy here – when in doubt, target master.
- Once changes are merged into the maintenance branch, they should be merged into master.

83.1.2 Documentation

- Every new feature should be documented. If it's a new module, don't forget to add a new rst file to the API docs.
- Each high-level plotting function should have a simple example in the `Example` section of the docstring. This should be as simple as possible to demonstrate the method. More complex examples should go in the `examples` tree.
- Build the docs and make sure all formatting warnings are addressed.
- See *Developer's tips for documenting matplotlib* for our documentation style guide.
- If your change is a major new feature, add an entry to `doc/users/whats_new.rst`.
- If you change the API in a backward-incompatible way, please document it in `doc/api/api_changes.rst`.

83.2 PR Review guidelines

- If you have a commit bit, then you are trusted to use it. Please help review and merge PRs!
- Two developers (those with commit rights) should review all pull requests. If you are the first to review a PR please and approve of the changes please edit the title to include ' [MRG+1] ' and use the github `'approve review'` tool to mark it as such. If you are a subsequent reviewer and you approve

either merge (and backport if needed) or increment the number in the title to ask for further review (and trigger the gh ‘approve review’). If you do the merge please removed the ‘[MRG+N]’ prefix.

- Make sure the Travis tests are passing before merging.
 - The Travis tests automatically test on all of the Python versions Matplotlib supports whenever a pull request is created or updated. The `tox` support in Matplotlib may be useful for testing locally.
- Do not self merge, except for ‘small’ patches to un-break the CI.
- Squashing is case-by-case. The balance is between burden on the contributor, keeping a relatively clean history, and keeping a history usable for bisecting. The only time we are really strict about it is to eliminate binary files (ex multiple test image re-generations) and to remove upstream merges.
- Be patient with new contributors.
- Do not let perfect be the enemy of the good, particularly for documentation or example PRs. If you find yourself making many small suggestions, either open a PR against the original branch or merge the PR and then open a new PR against upstream.

83.3 Backports

When doing backports please include the branch you backported the commit to along with the SHA in a comment on the original PR.

Assuming we have `matplotlib` as a read-only remote to the `matplotlib/matplotlib` repo and `DANGER` as a read/write remote to the `matplotlib/matplotlib` repo, we do a backport from `master` to `2.x`. The `TARGET_SHA` is the hash of the merge commit you would like to backport. This can be read off of the github PR page (in the UI with the merge notification) or through the git CLI tools.:

```
git fetch matplotlib
git checkout v2.x
git merge --ff-only matplotlib/v2.x
git cherry-pick -m 1 TARGET_SHA
gitk # to look at it
# local tests? (use your judgment)
git push DANGER v2.x
# leave a comment on PR noting sha of the resulting commit
# from the cherry-pick + branch it was moved to
```

These commands work on git 2.7.1.

RELEASE GUIDE

A guide for developers who are doing a matplotlib release.

84.1 All Releases

84.1.1 Testing

We use `travis-ci` for continuous integration. When preparing for a release, the final tagged commit should be tested locally before it is uploaded:

```
python tests.py --processes=8 --process-timeout=300
```

In addition the following two tests should be run and manually inspected:

```
python unit/memleak_hawaii3.py
pushd examples/tests/
python backend_driver.py
popd
```

84.1.2 GitHub Stats

We automatically extract GitHub issue, PRs, and authors from GitHub via the API:

```
python tools/github_stats.py --since-tag $TAG --project 'matplotlib/matplotlib' --links >
↪ doc/users/github_stats.rst
```

Review and commit changes. Some issue/PR titles may not be valid rst (the most common issue is `*` which is interpreted as unclosed markup).

84.1.3 Check Docs

Before tagging, make sure that the docs build cleanly

```
pushd doc
python make.py html latex -n 16
popd
```

After the docs are built, check that all of the links, internal and external, are still valid. We use `linkchecker` for this, which has not been ported to python3 yet. You will need to create a python2 environment with `requests==2.9.0` and `linkchecker`

```
conda create -p /tmp/lnkchk python=2 requests==2.9.0
source activate /tmp/lnkchk
pip install linkchecker
pushd doc/build/html
linkchecker index.html --check-extern
```

Address any issues which may arise. The internal links are checked on travis, this should only flag failed external links.

84.1.4 Create release commit and tag

To create the tag, first create an empty commit with a very terse set of the release notes in the commit message

```
git commit --allow-empty
```

and then create a signed, annotated tag with the same text in the body message

```
git tag -a -s v2.0.0
```

which will prompt you for your gpg key password and an annotation. For pre releases it is important to follow [PEP 440](#) so that the build artifacts will sort correctly in pypi. Finally, push the tag to GitHub

```
git push -t DANGER v2.0.0
```

Congratulations, the scariest part is done!

To prevent issues with any down-stream builders which download the tarball from GitHub it is important to move all branches away from the commit with the tag¹:

```
git commit --allow-empty
git push DANGER master
```

If this is a final release, also create a ‘doc’ branch (this is not done for pre-releases):

¹ The tarball that is provided by GitHub is produced using `git archive`. We use `versioneer` which uses a format string in `lib/matplotlib/_version.py` to have `git` insert a list of references to exported commit (see `.gitattributes` for the configuration). This string is then used by `versioneer` to produce the correct version, based on the `git` tag, when users install from the tarball. However, if there is a branch pointed at the tagged commit, then the branch name will also be included in the tarball. When the branch eventually moves, anyone who checked the hash of the tarball before the branch moved will have an incorrect hash.

To generate the file that GitHub does use

```
git archive v2.0.0 -o matplotlib-2.0.0.tar.gz --prefix=matplotlib-2.0.0/
```

```
git branch v2.0.0-doc
git push DANGER v2.0.0-doc
```

and if this is a major or minor release, also create a bug-fix branch (a micro release will be cut off of this branch):

```
git branch v2.0.x
git push DANGER v2.0.x
```

84.1.5 Release Management / DOI

Via the GitHub UI (chase down link), turn the newly pushed tag into a release. If this is a pre-release remember to mark it as such.

For final releases also get a DOI from [zenodo](#) and edit `doc/_templates/citing.html` with DOI link and commit to the VER-doc branch and push to GitHub

```
git checkout v2.0.0-doc
emacs doc/_templates/citing.html
git push DANGER v2.0.0-doc:v2.0.0-doc
```

84.1.6 Building binaries

We distribute mac, windows, and many linux wheels as well as a source tarball via pypi. Before uploading anything, contact the various builders. Mac and manylinux wheels are built on travis . You need to edit the `.travis.yml` file and push to master of [the build project](#).

Update the master branch (for pre-releases the devel branch) of the [conda-forge feedstock](#) via pull request.

If this is a final release the following downstream packagers should be contacted:

- Debian
- Fedora
- Arch
- Gentoo
- Macports
- Homebrew
- Christoph Gohlke
- Continuum
- Enthought

This can be done ahead of collecting all of the binaries and uploading to pypi.

84.1.7 make distribution and upload to pypi / SF

Once you have collected all of the wheels, generate the tarball

```
git checkout v2.0.0
git clean -xfd
python setup.py sdist
```

and copy all of the wheels into dist directory. You should use twine to upload all of the files to pypi

```
twine upload -s dist/matplotlib*tar.gz
twine upload dist/*whl
```

Congratulations, you have now done the second scariest part!

Additionally, for a final release, upload all of the files to sourceforge.

84.1.8 Build and Deploy Documentation

To build the documentation you must have the tagged version installed, but build the docs from the `ver-doc` branch. An easy way to arrange this is:

```
pip install matplotlib
pip install -r doc-requirements.txt
git checkout v2.0.0-doc
git clean -xfd
cd doc
python make.py html latex -n 16
```

which will build both the html and pdf version of the documentation.

The built documentation exists in the matplotlib.github.com repository. Pushing changes to master automatically updates the website.

The documentation is organized by version. At the root of the tree is always the documentation for the latest stable release. Under that, there are directories containing the documentation for older versions. The documentation for current master are built on travis and push to the [devdocs](https://matplotlib.org/devdocs) repository. These are available at matplotlib.org/devdocs.

Assuming you have this repository checked out in the same directory as matplotlib

```
cd ../matplotlib.github.com
mkdir 2.0.0
rsync -a ../matplotlib/doc/build/html/* 2.0.0
cp ../matplotlib/doc/build/latex/Matplotlib.pdf 2.0.0
```

which will copy the built docs over. If this is a final release, also replace the top-level docs

```
rsync -a 2.0.0/* ./
```

You will need to manually edit `versions.html` to show the last 3 tagged versions. Now commit and push everything to GitHub

```
git add *  
git commit -a -m 'Updating docs for v2.0.0'  
git push DANGER master
```

Congratulations you have now done the third scariest part!

It typically takes about 5-10 minutes for GitHub to process the push and update the live web page (remember to clear your browser cache).

84.1.9 Announcing

The final step is to announce the release to the world. A short version of the release notes along with acknowledgments should be sent to

- matplotlib-user@python.org
- matplotlib-devel@python.org
- matplotlib-announce@python.org

For final releases announcements should also be sent to the [numpy/scipy/jupyter](#) mailing lists and [python-announce](#).

In addition, announcements should be made on social networks (twitter, g+, FB). For major release, [NumFOCUS](#) should be contacted for inclusion in their newsletter and maybe to have something posted on their blog.

MATPLOTLIB ENHANCEMENT PROPOSALS

85.1 MEP Template

- *Status*
- *Branches and Pull requests*
- *Abstract*
- *Detailed description*
- *Implementation*
- *Backward compatibility*
- *Alternatives*

This MEP template is a guideline of the sections that a MEP should contain. Extra sections may be added if appropriate, and unnecessary sections may be noted as such.

85.1.1 Status

MEPs go through a number of phases in their lifetime:

- **Discussion:** The MEP is being actively discussed on the mailing list and it is being improved by its author. The mailing list discussion of the MEP should include the MEP number (MEPxxx) in the subject line so they can be easily related to the MEP.
- **Progress:** Consensus was reached on the mailing list and implementation work has begun.
- **Completed:** The implementation has been merged into master.
- **Superseded:** This MEP has been abandoned in favor of another approach.

85.1.2 Branches and Pull requests

All development branches containing work on this MEP should be linked to from here.

All pull requests submitted relating to this MEP should be linked to from here. (A MEP does not need to be implemented in a single pull request if it makes sense to implement it in discrete phases).

85.1.3 Abstract

The abstract should be a short description of what the MEP will achieve.

85.1.4 Detailed description

This section describes the need for the MEP. It should describe the existing problem that it is trying to solve and why this MEP makes the situation better. It should include examples of how the new functionality would be used and perhaps some use cases.

85.1.5 Implementation

This section lists the major steps required to implement the MEP. Where possible, it should be noted where one step is dependent on another, and which steps may be optionally omitted. Where it makes sense, each step should include a link related pull requests as the implementation progresses.

85.1.6 Backward compatibility

This section describes the ways in which the MEP breaks backward incompatibility.

85.1.7 Alternatives

If there were any alternative solutions to solving the same problem, they should be discussed here, along with a justification for the chosen approach.

85.2 MEP8: PEP8

- *Status*
- *Branches and Pull requests*
- *Abstract*
- *Detailed description*
- *Implementation*
- *Backward compatibility*
- *Alternatives*

85.2.1 Status

Discussion

85.2.2 Branches and Pull requests

None so far.

85.2.3 Abstract

The matplotlib codebase predates PEP8, and therefore is less than consistent style-wise in some areas. Bringing the codebase into compliance with PEP8 would go a long way to improving its legibility.

85.2.4 Detailed description

Some files use four space indentation, some use three. Some use different levels in the same file.

For the most part, class/function/variable naming follows PEP8, but it wouldn't hurt to fix where necessary.

85.2.5 Implementation

The implementation should be fairly mechanical: running the pep8 tool over the code and fixing where appropriate.

This should be merged in after the 2.0 release, since the changes will likely make merging any pending pull requests more difficult.

Additionally, and optionally, PEP8 compliance could be tracked by an automated build system.

85.2.6 Backward compatibility

Public names of classes and functions that require change (there shouldn't be many of these) should first be deprecated and then removed in the next release cycle.

85.2.7 Alternatives

PEP8 is a popular standard for Python code style, blessed by the Python core developers, making any alternatives less desirable.

85.3 MEP9: Global interaction manager

- *Status*
- *Branches and Pull requests*
- *Abstract*
- *Detailed description*
- *Implementation*
- *Current summary of the mixin*
- *Backward compatibility*
- *Alternatives*

Add a global manager for all user interactivity with artists; make any artist resizable, moveable, highlightable, and selectable as desired by the user.

85.3.1 Status

Discussion

85.3.2 Branches and Pull requests

<https://github.com/dhyams/matplotlib/tree/MEP9>

85.3.3 Abstract

The goal is to be able to interact with matplotlib artists in a very similar way as drawing programs do. When appropriate, the user should be able to move, resize, or select an artist that is already on the canvas. Of course, the script writer is ultimately in control of whether an artist is able to be interacted with, or whether it is static.

This code to do this has already been privately implemented and tested, and would need to be migrated from its current “mixin” implementation, to a bona-fide part of matplotlib.

The end result would be to have four new keywords available to `matplotlib.artist.Artist`: `_moveable_`, `_resizable_`, `_selectable_`, and `_highlightable_`. Setting any one of these keywords to `True` would activate interactivity for that artist.

In effect, this MEP is a logical extension of event handling in matplotlib; matplotlib already supports “low level” interactions like left mouse presses, a key press, or similar. The MEP extends the support to the logical level, where callbacks are performed on the artists when certain interactive gestures from the user are detected.

85.3.4 Detailed description

This new functionality would be used to allow the end-user to better interact with the graph. Many times, a graph is almost what the user wants, but a small repositioning and/or resizing of components is necessary. Rather than force the user to go back to the script to trial-and-error the location, and simple drag and drop would be appropriate.

Also, this would better support applications that use matplotlib; here, the end-user has no reasonable access or desire to edit the underlying source in order to fine-tune a plot. Here, if matplotlib offered the capability, one could move or resize artists on the canvas to suit their needs. Also, the user should be able to highlight (with a mouse over) an artist, and select it with a double-click, if the application supports that sort of thing. In this MEP, we also want to support the highlighting and selection natively; it is up to application to handle what happens when the artist is selected. A typical handling would be to display a dialog to edit the properties of the artist.

In the future, as well (this is not part of this MEP), matplotlib could offer backend-specific property dialogs for each artist, which are raised on artist selection. This MEP would be a necessary stepping stone for that sort of capability.

There are currently a few interactive capabilities in matplotlib (e.g. `legend.draggable()`), but they tend to be scattered and are not available for all artists. This MEP seeks to unify the interactive interface and make it work for all artists.

The current MEP also includes grab handles for resizing artists, and appropriate boxes drawn when artists are moved or resized.

85.3.5 Implementation

- Add appropriate methods to the “tree” of artists so that the interactivity manager has a consistent interface for the interactivity manager to deal with. The proposed methods to add to the artists, if they are to support interactivity, are:
 - `get_pixel_position_ll(self)`: get the pixel position of the lower left corner of the artist’s bounding box
 - `get_pixel_size(self)`: get the size of the artist’s bounding box, in pixels
 - `set_pixel_position_and_size(self,x,y,dx,dy)`: set the new size of the artist, such that it fits within the specified bounding box.
- add capability to the backends to 1) provide cursors, since these are needed for visual indication of moving/resizing, and 2) provide a function that gets the current mouse position
- Implement the manager. This has already been done privately (by dhyams) as a mixin, and has been tested quite a bit. The goal would be to move the functionality of the manager into the artists so that it is in matplotlib properly, and not as a “monkey patch” as I currently have it coded.

85.3.6 Current summary of the mixin

(Note that this mixin is for now just private code, but can be added to a branch obviously)

InteractiveArtistMixin:

Mixin class to make any generic object that is drawn on a matplotlib canvas moveable and possibly resizable. The Powerpoint model is followed as closely as possible; not because I'm enamoured with Powerpoint, but because that's what most people understand. An artist can also be selectable, which means that the artist will receive the `on_activated()` callback when double clicked. Finally, an artist can be highlightable, which means that a highlight is drawn on the artist whenever the mouse passes over. Typically, highlightable artists will also be selectable, but that is left up to the user. So, basically there are four attributes that can be set by the user on a per-artist basis:

- highlightable
- selectable
- moveable
- resizable

To be moveable (draggable) or resizable, the object that is the target of the mixin must support the following protocols:

- `get_pixel_position_ll(self)`
- `get_pixel_size(self)`
- `set_pixel_position_and_size(self,x,y,sx,sy)`

Note that nonresizable objects are free to ignore the `sx` and `sy` parameters. To be highlightable, the object that is the target of the mixin must also support the following protocol:

- `get_highlight(self)`

Which returns a list of artists that will be used to draw the highlight.

If the object that is the target of the mixin is not a matplotlib artist, the following protocols must also be implemented. Doing so is usually fairly trivial, as there has to be an artist *somewhere* that is being drawn. Typically your object would just route these calls to that artist.

- `get_figure(self)`
- `get_axes(self)`
- `contains(self,event)`
- `set_animated(self,flag)`
- `draw(self,renderer)`
- `get_visible(self)`

The following notifications are called on the artist, and the artist can optionally implement these.

- `on_select_begin(self)`
- `on_select_end(self)`
- `on_drag_begin(self)`
- `on_drag_end(self)`

- `on_activated(self)`
- `on_highlight(self)`
- `on_right_click(self,event)`
- `on_left_click(self,event)`
- `on_middle_click(self,event)`
- `on_context_click(self,event)`
- `on_key_up(self,event)`
- `on_key_down(self,event)`

The following notifications are called on the canvas, if no interactive artist handles the event:

- `on_press(self,event)`
- `on_left_click(self,event)`
- `on_middle_click(self,event)`
- `on_right_click(self,event)`
- `on_context_click(self,event)`
- `on_key_up(self,event)`
- `on_key_down(self,event)`

The following functions, if present, can be used to modify the behavior of the interactive object:

- `press_filter(self,event)` # determines if the object wants to have the press event routed to it
- `handle_unpicked_cursor()` # can be used by the object to set a cursor as the cursor passes over the object when it is unpicked.

Supports multiple canvases, maintaining a drag lock, motion notifier, and a global “enabled” flag per canvas. Supports fixed aspect ratio resizings by holding the shift key during the resize.

Known problems:

- Zorder is not obeyed during the selection/drag operations. Because of the blit technique used, I do not believe this can be fixed. The only way I can think of is to search for all artists that have a zorder greater than me, set them all to animated, and then redraw them all on top during each drag refresh. This might be very slow; need to try.
- the mixin only works for wx backends because of two things: 1) the cursors are hardcoded, and 2) there is a call to `wx.GetMousePosition()` Both of these shortcomings are reasonably fixed by having each backend supply these things.

85.3.7 Backward compatibility

No problems with backward compatibility, although once this is in place, it would be appropriate to obsolete some of the existing interactive functions (like `legend.draggable()`)

85.3.8 Alternatives

None that I know of.

85.4 MEP10: Docstring consistency

- *Status*
- *Branches and Pull requests*
- *Abstract*
- *Detailed description*
 - *Numpy docstring format*
 - *Cross references*
 - *Overriding signatures*
 - *Linking rather than duplicating*
 - *autosummary extension*
 - *Examples linking to relevant documentation*
 - *Documentation using help() vs a browser*
- *Implementation*
- *Backward compatibility*
- *Alternatives*

85.4.1 Status

Progress

Targeted for 1.3

85.4.2 Branches and Pull requests

#1665 #1757 #1795

85.4.3 Abstract

matplotlib has a great deal of inconsistency between docstrings. This not only makes the docs harder to read, but it is harder on contributors, because they don't know which specifications to follow. There should be a clear docstring convention that is followed consistently.

The organization of the API documentation is difficult to follow. Some pages, such as `pyplot` and `axes`, are enormous and hard to browse. There should instead be short summary tables that link to detailed documentation. In addition, some of the docstrings themselves are quite long and contain redundant information.

Building the documentation takes a long time and uses a `make.py` script rather than a Makefile.

85.4.4 Detailed description

There are number of new tools and conventions available since matplotlib started using Sphinx that make life easier. The following is a list of proposed changes to docstrings, most of which involve these new features.

Numpy docstring format

Numpy docstring format: This format divides the docstring into clear sections, each having different parsing rules that make the docstring easy to read both as raw text and as HTML. We could consider alternatives, or invent our own, but this is a strong choice, as it's well used and understood in the Numpy/Scipy community.

Cross references

Most of the docstrings in matplotlib use explicit “roles” when linking to other items, for example: `:func:`myfunction``. As of Sphinx 0.4, there is a “default_role” that can be set to “obj”, which will polymorphically link to a Python object of any type. This allows one to write ``myfunction`` instead. This makes docstrings much easier to read and edit as raw text. Additionally, Sphinx allows for setting a current module, so links like ``~matplotlib.axes.Axes.set_xlim`` could be written as ``~axes.Axes.set_xlim``.

Overriding signatures

Many methods in matplotlib use the `*args` and `**kwargs` syntax to dynamically handle the keyword arguments that are accepted by the function, or to delegate on to another function. This, however, is often not useful as a signature in the documentation. For this reason, many matplotlib methods include something like:

```
def annotate(self, *args, **kwargs):
    """
    Create an annotation: a piece of text referring to a data
    point.

    Call signature::

        annotate(s, xy, xytext=None, xycoords='data',
               textcoords='data', arrowprops=None, **kwargs)
    """
```

This can't be parsed by Sphinx, and is rather verbose in raw text. As of Sphinx 1.1, if the `autodoc_docstring_signature` config value is set to True, Sphinx will extract a replacement signature from the first line of the docstring, allowing this:

```
def annotate(self, *args, **kwargs):
    """
    annotate(s, xy, xytext=None, xycoords='data',
            textcoords='data', arrowprops=None, **kwargs)

    Create an annotation: a piece of text referring to a data
    point.
    """
```

The explicit signature will replace the actual Python one in the generated documentation.

Linking rather than duplicating

Many of the docstrings include long lists of accepted keywords by interpolating things into the docstring at load time. This makes the docstrings very long. Also, since these tables are the same across many docstrings, it inserts a lot of redundant information in the docs – particularly a problem in the printed version.

These tables should be moved to docstrings on functions whose only purpose is for help. The docstrings that refer to these tables should link to them, rather than including them verbatim.

autosummary extension

The Sphinx autosummary extension should be used to generate summary tables, that link to separate pages of documentation. Some classes that have many methods (e.g. `Axes.axes`) should be documented with one method per page, whereas smaller classes should have all of their methods together.

Examples linking to relevant documentation

The examples, while helpful at illustrating how to use a feature, do not link back to the relevant docstrings. This could be addressed by adding module-level docstrings to the examples, and then including that docstring in the parsed content on the example page. These docstrings could easily include references to any other part of the documentation.

Documentation using `help()` vs a browser

Using Sphinx markup in the source allows for good-looking docs in your browser, but the markup also makes the raw text returned using `help()` look terrible. One of the aims of improving the docstrings should be to make both methods of accessing the docs look good.

85.4.5 Implementation

1. The numpydoc extensions should be turned on for matplotlib. There is an important question as to whether these should be included in the matplotlib source tree, or used as a dependency. Installing Numpy is not sufficient to get the numpydoc extensions – it's a separate install procedure. In any

case, to the extent that they require customization for our needs, we should endeavor to submit those changes upstream and not fork them.

2. Manually go through all of the docstrings and update them to the new format and conventions. Updating the cross references (from ``:func: `myfunc`` to ``func``) may be able to be semi-automated. This is a lot of busy work, and perhaps this labor should be divided on a per-module basis so no single developer is over-burdened by it.
3. Reorganize the API docs using `autosummary` and `sphinx-autogen`. This should hopefully have minimal impact on the narrative documentation.
4. Modify the example page generator (`gen_rst.py`) so that it extracts the module docstring from the example and includes it in a non-literal part of the example page.
5. Use `sphinx-quickstart` to generate a new-style Sphinx Makefile. The following features in the current `make.py` will have to be addressed in some other way:
 - Copying of some static content
 - Specifying a “small” build (only low-resolution PNG files for examples)

Steps 1, 2, and 3 are interdependent. 4 and 5 may be done independently, though 5 has some dependency on 3.

85.4.6 Backward compatibility

As this mainly involves docstrings, there should be minimal impact on backward compatibility.

85.4.7 Alternatives

None yet discussed.

85.5 MEP11: Third-party dependencies

- *Status*
- *Branches and Pull requests*
- *Abstract*
- *Detailed description*
 - *Current behavior*
 - *Desired behavior*
- *Implementation*
- *Backward compatibility*

- *Alternatives*

This MEP attempts to improve the way in which third-party dependencies in matplotlib are handled.

85.5.1 Status

Completed – needs to be merged

85.5.2 Branches and Pull requests

#1157: Use automatic dependency resolution

#1290: Debundle pyparsing

#1261: Update six to 1.2

85.5.3 Abstract

One of the goals of matplotlib has been to keep it as easy to install as possible. To that end, some third-party dependencies are included in the source tree and, under certain circumstances, installed alongside matplotlib. This MEP aims to resolve some problems with that approach, bring some consistency, while continuing to make installation convenient.

At the time that was initially done, `setuptools`, `easy_install` and `PyPI` were not mature enough to be relied on. However, at present, we should be able to safely leverage the “modern” versions of those tools, `distribute` and `pip`.

While matplotlib has dependencies on both Python libraries and C/C++ libraries, this MEP addresses only the Python libraries so as to not confuse the issue. C libraries represent a larger and mostly orthogonal set of problems.

85.5.4 Detailed description

matplotlib depends on the following third-party Python libraries:

- Numpy
- dateutil (pure Python)
- pytz (pure Python)
- six – required by dateutil (pure Python)
- pyparsing (pure Python)
- PIL (optional)
- GUI frameworks: `pygtk`, `gobject`, `tkinter`, `PySide`, `PyQt4`, `wx` (all optional, but one is required for an interactive GUI)

Current behavior

When installing from source, a `git` checkout or `pip`:

- `setup.py` attempts to `import numpy`. If this fails, the installation fails.
- For each of `dateutil`, `pytz` and `six`, `setup.py` attempts to import them (from the top-level namespace). If that fails, matplotlib installs its local copy of the library into the top-level namespace.
- `pyparsing` is always installed inside of the matplotlib namespace.

This behavior is most surprising when used with `pip`, because no `pip` dependency resolution is performed, even though it is likely to work for all of these packages.

The fact that `pyparsing` is installed in the matplotlib namespace has reportedly (#1290) confused some users into thinking it is a matplotlib-related module and import it from there rather than the top-level.

When installing using the Windows installer, `dateutil`, `pytz` and `six` are installed at the top-level *always*, potentially overwriting already installed copies of those libraries.

TODO: Describe behavior with the OS-X installer.

When installing using a package manager (Debian, RedHat, MacPorts etc.), this behavior actually does the right thing, and there are no special patches in the matplotlib packages to deal with the fact that we handle `dateutil`, `pytz` and `six` in this way. However, care should be taken that whatever approach we move to continues to work in that context.

Maintaining these packages in the matplotlib tree and making sure they are up-to-date is a maintenance burden. Advanced new features that may require a third-party pure Python library have a higher barrier to inclusion because of this burden.

Desired behavior

Third-party dependencies are downloaded and installed from their canonical locations by leveraging `pip`, `distribute` and `PyPI`.

`dateutil`, `pytz`, and `pyparsing` should be made into optional dependencies – though obviously some features would fail if they aren't installed. This will allow the user to decide whether they want to bother installing a particular feature.

85.5.5 Implementation

For installing from source, and assuming the user has all of the C-level compilers and dependencies, this can be accomplished fairly easily using `distribute` and following the instructions [here](#). The only anticipated change to the matplotlib library code will be to import `pyparsing` from the top-level namespace rather than from within matplotlib. Note that `distribute` will also allow us to remove the direct dependency on `six`, since it is, strictly speaking, only a direct dependency of `dateutil`.

For binary installations, there are a number of alternatives (here ordered from best/hardest to worst/easiest):

1. The distutils wininst installer allows a post-install script to run. It might be possible to get this script to run `pip` to install the other dependencies. (See [this thread](#) for someone who has trod that ground before).
2. Continue to ship `dateutil`, `pytz`, `six` and `pyparsing` in our installer, but use the post-install-script to install them *only* if they can not already be found.
3. Move all of these packages inside a (new) `matplotlib.extern` namespace so it is clear for outside users that these are external packages. Add some conditional imports in the core matplotlib codebase so `dateutil` (at the top-level) is tried first, and failing that `matplotlib.extern.dateutil` is used.

2 and 3 are undesirable as they still require maintaining copies of these packages in our tree – and this is exacerbated by the fact that they are used less – only in the binary installers. None of these 3 approaches address Numpy, which will still have to be manually installed using an installer.

TODO: How does this relate to the Mac OS-X installer?

85.5.6 Backward compatibility

At present, matplotlib can be installed from source on a machine without the third party dependencies and without an internet connection. After this change, an internet connection (and a working PyPI) will be required to install matplotlib for the first time. (Subsequent matplotlib updates or development work will run without accessing the network).

85.5.7 Alternatives

Distributing binary eggs doesn't feel like a usable solution. That requires getting `easy_install` installed first, and Windows users generally prefer the well known `exe` or `msi` installer that works out of the box.

85.6 MEP12: Improve Gallery and Examples

- *Status*
- *Branches and Pull requests*
- *Abstract*
- *Detailed description*
- *Implementation*
 - *Gallery sections*
 - *Clean up guidelines*
 - * *Additional suggestions*
- *Backward compatibility*

- *Alternatives*

– *Tags*

85.6.1 Status

Progress

Initial changes added in 1.3. Conversion of the gallery is on-going. 29 September 2015 - The last `pylab_examples` where `pylab` is imported has been converted over to use `matplotlib` `pyplot` and `numpy`.

85.6.2 Branches and Pull requests

#1623, #1924, #2181

PR #2474 <<https://github.com/matplotlib/matplotlib/pull/2474>>_ demonstrates a single example being cleaned up and moved to the appropriate section.

85.6.3 Abstract

Reorganizing the matplotlib plot gallery would greatly simplify navigation of the gallery. In addition, examples should be cleaned-up and simplified for clarity.

85.6.4 Detailed description

The matplotlib gallery was recently set up to split examples up into sections. As discussed in that PR¹, the current example sections (`api`, `pylab_examples`) aren't terribly useful to users: New sections in the gallery would help users find relevant examples.

These sections would also guide a cleanup of the examples: Initially, all the current examples would remain and be listed under their current directories. Over time, these examples could be cleaned up and moved into one of the new sections.

This process allows users to easily identify examples that need to be cleaned up; i.e. anything in the `api` and `pylab_examples` directories.

85.6.5 Implementation

1. Create new gallery sections. [Done]
2. Clean up examples and move them to the new gallery sections (over the course of many PRs and with the help of many users/developers). [In progress]

¹ <https://github.com/matplotlib/matplotlib/pull/714>

Gallery sections

The naming of sections is critical and will guide the clean-up effort. The current sections are:

- Lines, bars, and markers (more-or-less 1D data)
- Shapes and collections
- Statistical plots
- Images, contours, and fields
- Pie and polar charts: Round things
- Color
- Text, labels, and annotations
- Ticks and spines
- Subplots, axes, and figures
- Specialty plots (e.g., sankey, radar, tornado)
- Showcase (plots with tweaks to make them publication-quality)
- separate sections for toolboxes (already exists: ‘mplot3d’, ‘axes_grid’, ‘units’, ‘widgets’)

These names are certainly up for debate. As these sections grow, we should reevaluate them and split them up as necessary.

Clean up guidelines

The current examples in the `api` and `pylab_examples` sections of the gallery would remain in those directories until they are cleaned up. After clean-up, they would be moved to one of the new gallery sections described above. “Clean-up” should involve:

- PEP8 clean-ups (running `flake8`, or a similar checker, is highly recommended)
- Commented-out code should be removed.
- Add introductory sentence or paragraph in the main docstring. See [6d1b8a2](#).
- Replace uses of `pylab` interface with `pyplot` (+ `numpy`, etc.). See [c25ef1e](#)
- Remove shebang line, e.g.:

```
#!/usr/bin/env python
```

- Use consistent imports. In particular:

```
import numpy as np
import matplotlib.pyplot as plt
```

Avoid importing specific functions from these modules (e.g. `from numpy import sin`)

- Each example should focus on a specific feature (excluding showcase examples, which will show more “polished” plots). Tweaking unrelated to that feature should be removed. See [f7b2217](#), [e57b5fc](#), and [1458aa8](#)

Use of `pylab` should be demonstrated/discussed on a dedicated help page instead of the gallery examples.

Note: When moving an existing example, you should search for references to that example. For example, the API documentation for `axes.py` and `pyplot.py` may use these examples to generate plots. Use your favorite search tool (e.g., `grep`, `ack`, `grin`, `pss`) to search the matplotlib package. See [2dc9a46](#) and [aa6b410](#)

Additional suggestions

- Provide links (both ways) between examples and API docs for the methods/objects used. (issue [#2222](#))
- Use `plt.subplots` (note trailing “s”) in preference over `plt.subplot`.
- Rename the example to clarify its purpose. For example, the most basic demo of `imshow` might be `imshow_demo.py`, and one demonstrating different interpolation settings would be `imshow_demo_interpolation.py` (*not* `imshow_demo2.py`).
- Split up examples that try to do too much. See [5099675](#) and [fc2ab07](#)
- Delete examples that don’t show anything new.
- Some examples exercise esoteric features for unit testing. These tweaks should be moved out of the gallery to an example in the `unit` directory located in the root directory of the package.
- Add plot titles to clarify intent of the example. See [bd2b13c](#)

85.6.6 Backward compatibility

The website for each Matplotlib version is readily accessible, so users who want to refer to old examples can still do so.

85.6.7 Alternatives

Tags

Tagging examples will also help users search the example gallery. Although tags would be a big win for users with specific goals, the plot gallery will remain the entry point to these examples, and sections could really help users navigate the gallery. Thus, tags are complementary to this reorganization.

85.7 MEP13: Use properties for Artists

- *Status*
- *Branches and Pull requests*
- *Abstract*
- *Detailed description*
- *Implementation*
- *Backward compatibility*
- *Examples*
 - *axes.Axes.set_axis_off/set_axis_on*
 - *axes.Axes.get_xlim/set_xlim and get_autoscalex_on/set_autoscalex_on*
 - *axes.Axes.get_title/set_title*
 - *axes.Axes.get_xticklabels/set_xticklabels*
- *Alternatives*

85.7.1 Status

- **Discussion**

85.7.2 Branches and Pull requests

None

85.7.3 Abstract

Wrap all of the matplotlib getter and setter methods with python [properties](#), allowing them to be read and written like class attributes.

85.7.4 Detailed description

Currently matplotlib uses getter and setter functions (usually prefixed with `get_` and `set_`, respectively) for reading and writing data related to classes. However, since 2.6 python supports properties, which allow such setter and getter functions to be accessed as though they were attributes. This proposal would implement all existing setter and getter methods as properties.

85.7.5 Implementation

1. All existing getter and setter methods will need to have two aliases, one with the `get_` or `set_` prefix and one without. Getter methods that currently lack prefixes should be recording in a text file.

2. Classes should be reorganized so setter and getter methods are sequential in the code, with getter methods first.
3. Getter and setter methods that provide additional optional arguments should have those arguments accessible in another manner, either as additional getter or setter methods or attributes of other classes. If those classes are not accessible, getters for them should be added.
4. Property decorators will be added to the setter and getter methods without the prefix. Those with the prefix will be marked as deprecated.
5. Docstrings will need to be rewritten so the getter with the prefix has the current docstring and the getter without the prefix has a generic docstring appropriate for an attribute.
6. Automatic alias generation will need to be modified so it will also create aliases for the properties.
7. All instances of getter and setter method calls will need to be changed to attribute access.
8. All setter and getter aliases with prefixes will be removed

The following steps can be done simultaneously: 1, 2, and 3; 4 and 5; 6 and 7.

Only the following steps must be done in the same release: 4, 5, and 6. All other changes can be done in separate releases. 8 should be done several major releases after everything else.

85.7.6 Backward compatibility

All existing getter methods that do not have a prefix (such as `get_`) will need to be changed from function calls to attribute access. In most cases this will only require removing the parenthesis.

setter and getter methods that have additional optional arguments will need to have those arguments implemented in another way, either as a separate property in the same class or as attributes or properties of another class.

Cases where the setter returns a value will need to be changed to using the setter followed by the getter.

Cases where there are `set_ATTR_on()` and `set_ATTR_off()` methods will be changed to `ATTR_on` properties.

85.7.7 Examples

`axes.Axes.set_axis_off/set_axis_on`

Current implementation:

```
axes.Axes.set_axis_off()
axes.Axes.set_axis_on()
```

New implementation:

```
True = axes.Axes.axis_on
False = axes.Axes.axis_on
axes.Axes.axis_on = True
axes.Axes.axis_on = False
```

axes.Axes.get_xlim/set_xlim and get_autoscalex_on/set_autoscalex_on

Current implementation:

```
[left, right] = axes.Axes.get_xlim()
auto = axes.Axes.get_autoscalex_on()

[left, right] = axes.Axes.set_xlim(left=left, right=right, emit=emit, auto=auto)
[left, right] = axes.Axes.set_xlim(left=left, right=None, emit=emit, auto=auto)
[left, right] = axes.Axes.set_xlim(left=None, right=right, emit=emit, auto=auto)
[left, right] = axes.Axes.set_xlim(left=left, emit=emit, auto=auto)
[left, right] = axes.Axes.set_xlim(right=right, emit=emit, auto=auto)

axes.Axes.set_autoscalex_on(auto)
```

New implementation:

```
[left, right] = axes.Axes.axes_xlim
auto = axes.Axes.autoscalex_on

axes.Axes.axes_xlim = [left, right]
axes.Axes.axes_xlim = [left, None]
axes.Axes.axes_xlim = [None, right]
axes.Axes.axes_xlim[0] = left
axes.Axes.axes_xlim[1] = right

axes.Axes.autoscalex_on = auto

axes.Axes.emit_xlim = emit
```

axes.Axes.get_title/set_title

Current implementation:

```
string = axes.Axes.get_title()
axes.Axes.set_title(string, fontdict=fontdict, **kwargs)
```

New implementation:

```
string = axes.Axes.title
string = axes.Axes.title_text.text

text.Text = axes.Axes.title_text
text.Text.<attribute> = attribute
text.Text.fontdict = fontdict

axes.Axes.title = string
axes.Axes.title = text.Text
axes.Axes.title_text = string
axes.Axes.title_text = text.Text
```

axes.Axes.get_xticklabels/set_xticklabels

Current implementation:

```
[text.Text] = axes.Axes.get_xticklabels()
[text.Text] = axes.Axes.get_xticklabels(minor=False)
[text.Text] = axes.Axes.get_xticklabels(minor=True)
[text.Text] = axes.Axes.([string], fontdict=None, **kwargs)
[text.Text] = axes.Axes.([string], fontdict=None, minor=False, **kwargs)
[text.Text] = axes.Axes.([string], fontdict=None, minor=True, **kwargs)
```

New implementation:

```
[text.Text] = axes.Axes.xticklabels
[text.Text] = axes.Axes.xminorticklabels
axes.Axes.xticklabels = [string]
axes.Axes.xminorticklabels = [string]
axes.Axes.xticklabels = [text.Text]
axes.Axes.xminorticklabels = [text.Text]
```

85.7.8 Alternatives

Instead of using decorators, it is also possible to use the property function. This would change the procedure so that all getter methods that lack a prefix will need to be renamed or removed. This makes handling docstrings more difficult and harder to read.

It is not necessary to deprecate the setter and getter methods, but leaving them in will complicate the code.

This could also serve as an opportunity to rewrite or even remove automatic alias generation.

Another alternate proposal:

Convert `set_xlim`, `set_xlabel`, `set_title`, etc. to `xlim`, `xlabel`, `title`,... to make the transition from `plt` functions to `axes` methods significantly simpler. These would still be methods, not properties, but it's still a great usability enhancement while retaining the interface.

85.8 MEP14: Text handling

- *Status*
- *Branches and Pull requests*
- *Abstract*
- *Detailed description*
- *Implementation*
- *Backward compatibility*

- *Alternatives*

85.8.1 Status

- **Discussion**

85.8.2 Branches and Pull requests

Issue #253 demonstrates a bug where using the bounding box rather than the advance width of text results in misaligned text. This is a minor point in the grand scheme of things, but it should be addressed as part of this MEP.

85.8.3 Abstract

By reorganizing how text is handled, this MEP aims to:

- improve support for Unicode and non-ltr languages
- improve text layout (especially multi-line text)
- allow support for more fonts, especially non-Apple-format TrueType fonts and OpenType fonts.
- make the font configuration easier and more transparent

85.8.4 Detailed description

Text layout

At present, matplotlib has two different ways to render text: “built-in” (based on FreeType and our own Python code), and “usetex” (based on calling out to a TeX installation). Adjunct to the “built-in” renderer there is also the Python-based “mathtext” system for rendering mathematical equations using a subset of the TeX language without having a TeX installation available. Support for these two engines is strewn about many source files, including every backend, where one finds clauses like

```
if rcParams['text.usetex']: # do one thing else: # do another
```

Adding a third text rendering approach (more on that later) would require editing all of these places as well, and therefore doesn't scale.

Instead, this MEP proposes adding a concept of “text engines”, where the user could select one of many different approaches for rendering text. The implementations of each of these would be localized to their own set of modules, and not have little pieces around the whole source tree.

Why add more text rendering engines? The “built-in” text rendering has a number of shortcomings.

- It only handles right-to-left languages, and doesn't handle many special features of Unicode, such as combining diacriticals.

- The multiline support is imperfect and only supports manual line-breaking – it can not break up a paragraph into lines of a certain length.
- It also does not handle inline formatting changes in order to support something like Markdown, reStructuredText or HTML. (Though rich-text formatting is contemplated in this MEP, since we want to make sure this design allows it, the specifics of a rich-text formatting implementation is outside of the scope of this MEP.)

Supporting these things is difficult, and is the “full-time job” of a number of other projects:

- [pango/harfbuzz](#)
- [QtTextLayout](#)
- [Microsoft DirectWrite](#)
- [Apple Core Text](#)

Of the above options, it should be noted that `harfbuzz` is designed from the start as a cross platform option with minimal dependencies, so therefore is a good candidate for a single option to support.

Additionally, for supporting rich text, we could consider using [WebKit](#), and possibly whether than represents a good single cross-platform option. Again, however, rich text formatting is outside of the scope of this project.

Rather than trying to reinvent the wheel and add these features to matplotlib’s “built-in” text renderer, we should provide a way to leverage these projects to get more powerful text layout. The “built-in” renderer will still need to exist for reasons of ease of installation, but its feature set will be more limited compared to the others. [TODO: This MEP should clearly decide what those limited features are, and fix any bugs to bring the implementation into a state of working correctly in all cases that we want it to work. I know @leejjoon has some thoughts on this.]

Font selection

Going from an abstract description of a font to a file on disk is the task of the font selection algorithm – it turns out to be much more complicated than it seems at first.

The “built-in” and “usetex” renderers have very different ways of handling font selection, given their different technologies. TeX requires the installation of TeX-specific font packages, for example, and can not use TrueType fonts directly. Unfortunately, despite the different semantics for font selection, the same set of font properties are used for each. This is true of both the `FontProperties` class and the font-related `rcParams` (which basically share the same code underneath). Instead, we should define a core set of font selection parameters that will work across all text engines, and have engine-specific configuration to allow the user to do engine-specific things when required. For example, it is possible to directly select a font by name in the “built-in” using `font.family`, but the same is not possible with “usetex”. It may be possible to make it easier to use TrueType fonts by using XeTeX, but users will still want to use the traditional metafonts through TeX font packages. So the issue still stands that different text engines will need engine-specific configuration, and it should be more obvious to the user which configuration will work across text engines and which are engine-specific.

Note that even excluding “usetex”, there are different ways to find fonts. The default is to use the font list cache in `font_manager.py` which matches fonts using our own algorithm based on the [CSS font matching algorithm](#). It doesn’t always do the same thing as the native font selection algorithms on Linux (`fontconfig`), Mac and Windows, and it doesn’t always find all of the fonts on the system that the OS would normally

pick up. However, it is cross-platform, and always finds the fonts that ship with matplotlib. The Cairo and MacOSX backends (and presumably a future HTML5-based backend) currently bypass this mechanism and use the OS-native ones. The same is true when not embedding fonts in SVG, PS or PDF files and opening them in a third-party viewer. A downside there is that (at least with Cairo, need to confirm with MacOSX) they don't always find the fonts we ship with matplotlib. (It may be possible to add the fonts to their search path, though, or we may need to find a way to install our fonts to a location the OS expects to find them).

There are also special modes in the PS and PDF to only use the core fonts that are always available to those formats. There, the font lookup mechanism must only match against those fonts. It is unclear whether the OS-native font lookup systems can handle this case.

There is also experimental support for using `fontconfig` for font selection in matplotlib, turned off by default. `fontconfig` is the native font selection algorithm on Linux, but is also cross platform and works well on the other platforms (though obviously is an additional dependency there).

Many of the text layout libraries proposed above (`pango`, `QtTextLayout`, `DirectWrite` and `CoreText` etc.) insist on using the font selection library from their own ecosystem.

All of the above seems to suggest that we should move away from our self-written font selection algorithm and use the native APIs where possible. That's what Cairo and MacOSX backends already want to use, and it will be a requirement of any complex text layout library. On Linux, we already have the bones of a `fontconfig` implementation (which could also be accessed through `pango`). On Windows and Mac we may need to write custom wrappers. The nice thing is that the API for font lookup is relatively small, and essentially consist of "given a dictionary of font properties, give me a matching font file".

Font subsetting

Font subsetting is currently handled using `tconv`. `tconv` was a standalone commandline utility for converting TrueType fonts to subsetted Type 3 fonts (among other features) written in 1995, which matplotlib (well, I) forked in order to make it work as a library. It only handles Apple-style TrueType fonts, not ones with the Microsoft (or other vendor) encodings. It doesn't handle OpenType fonts at all. This means that even though the STIX fonts come as `.otf` files, we have to convert them to `.ttf` files to ship them with matplotlib. The Linux packagers hate this – they'd rather just depend on the upstream STIX fonts. `tconv` has also been shown to have a few bugs that have been difficult to fix over time.

Instead, we should be able to use FreeType to get the font outlines and write our own code (probably in Python) to output subsetted fonts (Type 3 on PS and PDF and `SVGFonts` or `paths` on SVG). FreeType, as a popular and well-maintained project, handles a wide variety of fonts in the wild. This would remove a lot of custom C code, and remove some code duplication between backends.

Note that subsetting fonts this way, while the easiest route, does lose the hinting in the font, so we will need to continue, as we do now, provide a way to embed the entire font in the file where possible.

Alternative font subsetting options include using the subsetting built-in to Cairo (not clear if it can be used without the rest of Cairo), or using `fontforge` (which is a heavy and not terribly cross-platform dependency).

FreeType wrappers

Our FreeType wrapper could really use a reworking. It defines its own image buffer class (when a Numpy array would be easier). While FreeType can handle a huge diversity of font files, there are limitations to our wrapper that make it much harder to support non-Apple-vendor TrueType files, and certain features of

OpenType files. (See #2088 for a terrible result of this, just to support the fonts that ship with Windows 7 and 8). I think a fresh rewrite of this wrapper would go a long way.

Text anchoring and alignment and rotation

The handling of baselines was changed in 1.3.0 such that the backends are now given the location of the baseline of the text, not the bottom of the text. This is probably the correct behavior, and the MEP refactoring should also follow this convention.

In order to support alignment on multi-line text, it should be the responsibility of the (proposed) text engine to handle text alignment. For a given chunk of text, each engine calculates a bounding box for that text and the offset of the anchor point within that box. Therefore, if the va of a block was “top”, the anchor point would be at the top of the box.

Rotating of text should always be around the anchor point. I’m not sure that lines up with current behavior in matplotlib, but it seems like the sanest/least surprising choice. [This could be revisited once we have something working]. Rotation of text should not be handled by the text engine – that should be handled by a layer between the text engine and the rendering backend so it can be handled in a uniform way. [I don’t see any advantage to rotation being handled by the text engines individually...]

There are other problems with text alignment and anchoring that should be resolved as part of this work. [TODO: enumerate these].

Other minor problems to fix

The mathtext code has backend-specific code – it should instead provide its output as just another text engine. However, it’s still desirable to have mathtext layout inserted as part of a larger layout performed by another text engine, so it should be possible to do this. It’s an open question whether embedding the text layout of an arbitrary text engine in another should be possible.

The text mode is currently set by a global rcParam (“text.usetex”) so it’s either all on or all off. We should continue to have a global rcParam to choose the text engine (“text.layout_engine”), but it should under the hood be an overridable property on the Text object, so the same figure can combine the results of multiple text layout engines if necessary.

85.8.5 Implementation

A concept of a “text engine” will be introduced. Each text engine will implement a number of abstract classes. The TextFont interface will represent text for a given set of font properties. It isn’t necessarily limited to a single font file – if the layout engine supports rich text, it may handle a number of font files in a family. Given a TextFont instance, the user can get a TextLayout instance, which represents the layout for a given string of text in a given font. From a TextLayout, an iterator over TextSpans is returned so the engine can output raw editable text using as few spans as possible. If the engine would rather get individual characters, they can be obtained from the TextSpan instance:

```
class TextFont(TextFontBase):
    def __init__(self, font_properties):
        """
        Create a new object for rendering text using the given font properties.
        """
        pass
```

```
def get_layout(self, s, ha, va):
    """
    Get the TextLayout for the given string in the given font and
    the horizontal (left, center, right) and verticalalignment (top,
    center, baseline, bottom)
    """
    pass

class TextLayout(TextLayoutBase):
    def get_metrics(self):
        """
        Return the bounding box of the layout, anchored at (0, 0).
        """
        pass

    def get_spans(self):
        """
        Returns an iterator over the spans of different in the layout.
        This is useful for backends that want to editable raw text as
        individual lines. For rich text where the font may change,
        each span of different font type will have its own span.
        """
        pass

    def get_image(self):
        """
        Returns a rasterized image of the text. Useful for raster backends,
        like Agg.

        In all likelihood, this will be overridden in the backend, as it can
        be created from get_layout(), but certain backends may want to
        override it if their library provides it (as freetype does).
        """
        pass

    def get_rectangles(self):
        """
        Returns an iterator over the filled black rectangles in the layout.
        Used by TeX and mathtext for drawing, for example, fraction lines.
        """
        pass

    def get_path(self):
        """
        Returns a single Path object of the entire layed out text.

        [Not strictly necessary, but might be useful for textpath
        functionality]
        """
        pass

class TextSpan(TextSpanBase):
    x, y      # Position of the span -- relative to the text layout as a whole
```

```

        # where (0, 0) is the anchor. y is the baseline of the span.
fontfile # The font file to use for the span
text     # The text content of the span

def get_path(self):
    pass # See TextLayout.get_path

def get_chars(self):
    """
    Returns an iterator over the characters in the span.
    """
    pass

class TextChar(TextCharBase):
    x, y # Position of the character -- relative to the text layout as
        # a whole, where (0, 0) is the anchor. y is in the baseline
        # of the character.
    codepoint # The unicode code point of the character -- only for informational
        # purposes, since the mapping of codepoint to glyph_id may have been
        # handled in a complex way by the layout engine. This is an int
        # to avoid problems on narrow Unicode builds.
    glyph_id # The index of the glyph within the font
    fontfile # The font file to use for the char

    def get_path(self):
        """
        Get the path for the character.
        """
    pass

```

Graphic backends that want to output subset of fonts would likely build up a file-global dictionary of characters where the keys are (fontname, glyph_id) and the values are the paths so that only one copy of the path for each character will be stored in the file.

Special casing: The “usetex” functionality currently is able to get Postscript directly from TeX to insert directly in a Postscript file, but for other backends, parses a DVI file and generates something more abstract. For a case like this, TextLayout would implement `get_spans` for most backends, but add `get_ps` for the Postscript backend, which would look for the presence of this method and use it if available, or fall back to `get_spans`. This kind of special casing may also be necessary, for example, when the graphics backend and text engine belong to the same ecosystem, e.g. Cairo and Pango, or MacOSX and CoreText.

There are three main pieces to the implementation:

1. Rewriting the freetype wrapper, and removing ttconv.
1. Once (1) is done, as a proof of concept, we can move to the upstream STIX .otf fonts
2. Add support for web fonts loaded from a remote URL. (Enabled by using freetype for font subsetting).
2. Refactoring the existing “builtin” and “usetex” code into separate text engines and to follow the API outlined above.
3. Implementing support for advanced text layout libraries.

(1) and (2) are fairly independent, though having (1) done first will allow (2) to be simpler. (3) is dependent on (1) and (2), but even if it doesn't get done (or is postponed), completing (1) and (2) will make it easier to move forward with improving the "builtin" text engine.

85.8.6 Backward compatibility

The layout of text with respect to its anchor and rotation will change in hopefully small, but improved, ways. The layout of multiline text will be much better, as it will respect horizontal alignment. The layout of bidirectional text or other advanced Unicode features will now work inherently, which may break some things if users are currently using their own workarounds.

Fonts will be selected differently. Hacks that used to sort of work between the "builtin" and "usetex" text rendering engines may no longer work. Fonts found by the OS that weren't previously found by matplotlib may be selected.

85.8.7 Alternatives

TBD

85.9 MEP15 - Fix axis autoscaling when limits are specified for one axis only

- *Status*
- *Branches and Pull requests*
- *Abstract*
- *Detailed description*
- *Implementation*
- *Backward compatibility*
- *Alternatives*

85.9.1 Status

Discussion

85.9.2 Branches and Pull requests

None so far.

85.9.3 Abstract

When one axis of a 2-dimensional plot is overridden via `xlim` or `ylim`, automatic scaling of the remaining axis should be based on the data that falls within the specified limits of the first axis.

85.9.4 Detailed description

When axis limits for a 2-D plot are specified for one axis only (via `xlim` or `ylim`), matplotlib currently does not currently rescale the other axis. The result is that the displayed curves or symbols may be compressed into a tiny portion of the available area, so that the final plot conveys much less information than it would with appropriate axis scaling.

The proposed change of behavior would make matplotlib choose the scale for the remaining axis using only the data that falls within the limits for the axis where limits were specified.

85.9.5 Implementation

I don't know enough about the internals of matplotlib to be able to suggest an implementation.

85.9.6 Backward compatibility

From the standpoint of software interfaces, there would be no break in backward compatibility. Some outputs would be different, but if the user truly desires the previous behavior, he/she can achieve this by overriding the axis scaling for both axes.

85.9.7 Alternatives

The only alternative that I can see is to maintain the status quo.

85.10 MEP19: Continuous Integration

85.10.1 Status

Discussion

85.10.2 Branches and Pull requests

85.10.3 Abstract

matplotlib could benefit from better and more reliable continuous integration, both for testing and building installers and documentation.

85.10.4 Detailed description

Current state-of-the-art

Testing

matplotlib currently uses Travis-CI for automated tests. While Travis-CI should be praised for how much it does as a free service, it has a number of shortcomings:

- It often fails due to network timeouts when installing dependencies.
- It often fails for inexplicable reasons.
- build or test products can only be saved from build off of branches on the main repo, not pull requests, so it is often difficult to “post mortem” analyse what went wrong. This is particularly frustrating when the failure can not be subsequently reproduced locally.
- It is not extremely fast. matplotlib’s cpu and memory requirements for testing are much higher than the average Python project.
- It only tests on Ubuntu Linux, and we have only minimal control over the specifics of the platform. It can be upgraded at any time outside of our control, causing unexpected delays at times that may not be convenient in our release schedule.

On the plus side, Travis-CI’s integration with github – automatically testing all pending pull requests – is exceptional.

Builds

There is no centralized effort for automated binary builds for matplotlib. However, the following disparate things are being done [If the authors mentioned here could fill in detail, that would be great!]:

- @sandrotosi: builds Debian packages
- @takluyver: Has automated Ubuntu builds on Launchpad
- @cgohlke: Makes Windows builds (don’t know how automated that is)
- @r-owen: Makes OS-X builds (don’t know how automated that is)

Documentation

Documentation of master is now built by travis and uploaded to <http://matplotlib.org/devdocs/index.html>

@NelleV, I believe, generates the docs automatically and posts them on the web to chart MEP10 progress.

Peculiarities of matplotlib

matplotlib has complex requirements that make testing and building more taxing than many other Python projects.

- The CPU time to run the tests is quite high. It puts us beyond the free accounts of many CI services (e.g. ShiningPanda)
- It has a large number of dependencies, and testing the full matrix of all combinations is impractical. We need to be clever about what space we test and guarantee to support.

Requirements

This section outlines the requirements that we would like to have.

1. Testing all pull requests by hooking into the Github API, as Travis-CI does
2. Testing on all major platforms: Linux, Mac OS-X, MS Windows (in that order of priority, based on user survey)
3. Retain the last n days worth of build and test products, to aid in post-mortem debugging.
4. Automated nightly binary builds, so that users can test the bleeding edge without installing a complete compilation environment.
5. Automated benchmarking. It would be nice to have a standard benchmark suite (separate from the tests) whose performance could be tracked over time, in different backends and platforms. While this is separate from building and testing, ideally it would run on the same infrastructure.
6. Automated nightly building and publishing of documentation (or as part of testing, to ensure PRs don't introduce documentation bugs). (This would not replace the static documentation for stable releases as a default).
7. The test systems should be manageable by multiple developers, so that no single person becomes a bottleneck. (Travis-CI's design does this well – storing build configuration in the git repository, rather than elsewhere, is a very good design.)
8. Make it easy to test a large but sparse matrix of different versions of matplotlib's dependencies. The matplotlib user survey provides some good data as to where to focus our efforts: <https://docs.google.com/spreadsheet/ccc?key=0AjrPjlTMRTwTdHpQS25pcTZIRWdqX0pNckNSU01sMHc#gid=0>
9. Nice to have: A decentralized design so that those with more obscure platforms can publish build results to a central dashboard.

85.10.5 Implementation

This part is yet-to-be-written.

However, ideally, the implementation would be a third-party service, to avoid adding system administration to our already stretched time. As we have some donated funds, this service may be a paid one if it offers significant time-saving advantages over free offerings.

85.10.6 Backward compatibility

Backward compatibility is not a major concern for this MEP. We will replace current tools and procedures with something better and throw out the old.

85.10.7 Alternatives

85.10.8 Hangout Notes

CI Infrastructure

- We like Travis and it will probably remain part of our arsenal in any event. The reliability issues are being looked into.
- Enable Amazon S3 uploads of testing products on Travis. This will help with post-mortem of failures (@mdboom is looking into this now).
- We want Mac coverage. The best bet is probably to push Travis to enable it for our project by paying them for a Pro account (since they don't otherwise allow testing on both Linux and Mac).
- We want Windows coverage. Shining Panda is an option there.
- Investigate finding or building a tool that would collect and synthesize test results from a number of sources and post it to Github using the Github API. This may be of general use to the Scipy community.
- For both Windows and Mac, we should document (or better yet, script) the process of setting up the machine for a build, and how to build binaries and installers. This may require getting information from Russel Owen and Christoph Gohlke. This is a necessary step for doing automated builds, but would also be valuable for a number of other reasons.

The test framework itself

- We should investigate ways to make it take less time
 - Eliminating redundant tests, if possible
 - General performance improvements to matplotlib will help
- We should be covering more things, particularly more backends
- We should have more unit tests, fewer integration tests, if possible

85.11 MEP21: color and cm refactor

- *Status*
- *Branches and Pull requests*
- *Abstract*
- *Detailed description*
- *Implementation*
- *Backward compatibility*
- *Alternatives*

85.11.1 Status

- **Discussion:** This MEP has not commenced yet, but here are some ongoing ideas which may become a part of this MEP:

85.11.2 Branches and Pull requests

85.11.3 Abstract

- color
 - tidy up the namespace
 - Define a “Color” class
 - make it easy to convert from one color type to another ``hex` -> RGB`, `RGB` -> hex`, `HSV` -> RGB` etc.`
 - improve the construction of a colormap - the dictionary approach is archaic and overly complex (though incredibly powerful)
 - make it possible to interpolate between two or more color types in different modes, especially useful for construction of colormaps in HSV space for instance
- cm
 - rename the module to something more descriptive - mappables?

Overall, there are a lot of improvements that can be made with matplotlib color handling - managing backwards compatibility will be difficult as there are some badly named variables/modules which really shouldn't exist - but a clear path and message for migration should be available, with a large amount of focus on this in the API changes documentation.

85.11.4 Detailed description

85.11.5 Implementation

85.11.6 Backward compatibility

85.11.7 Alternatives

85.12 MEP22: Toolbar rewrite

- *Status*
- *Branches and Pull requests*
- *Abstract*

- *Detailed description*
- *Implementation*
 - *ToolBase(object)*
 - *ToolToggleBase(ToolBase)*
 - *NavigationBase*
 - *ToolbarBase*
- *Backward compatibility*

85.12.1 Status

Progress

85.12.2 Branches and Pull requests

Previous work

- <https://github.com/matplotlib/matplotlib/pull/1849>
- <https://github.com/matplotlib/matplotlib/pull/2557>
- <https://github.com/matplotlib/matplotlib/pull/2465>

Pull Requests:

- Removing the NavigationToolbar classes <https://github.com/matplotlib/matplotlib/pull/2740>
CLOSED
- Keeping the NavigationToolbar classes <https://github.com/matplotlib/matplotlib/pull/2759>
CLOSED
- Navigation by events: <https://github.com/matplotlib/matplotlib/pull/3652>

85.12.3 Abstract

The main goal of this MEP is to make it easier to modify (add, change, remove) the way the user interacts with the figures.

The user interaction with the figure is deeply integrated within the Canvas and Toolbar. Making extremely difficult to do any modification.

This MEP proposes the separation of this interaction into Toolbar, Navigation and Tools to provide independent access and reconfiguration.

This approach will make easier to create and share tools among users. In the far future, we can even foresee a kind of Marketplace for Tools where the most popular can be added into the main distribution.

85.12.4 Detailed description

The reconfiguration of the Toolbar is complex, most of the time it requires a custom backend.

The creation of custom Tools sometimes interferes with the Toolbar, as example see <https://github.com/matplotlib/matplotlib/issues/2694> also the shortcuts are hardcoded and again not easily modifiable <https://github.com/matplotlib/matplotlib/issues/2699>

The proposed solution is to take the actions out of the Toolbar and the shortcuts out of the Canvas. This actions and shortcuts will be in the form of Tools.

A new class `Navigation` will be the bridge between the events from the Canvas and Toolbar and redirect them to the appropriate Tool.

At the end the user interaction will be divided into three classes:

- `NavigationBase`: This class is instantiated for each `FigureManager` and connect the all user interactions with the Tools
- `ToolbarBase`: This existing class is relegated only as a GUI access to Tools.
- `ToolBase`: Is the basic definition of Tools.

85.12.5 Implementation

`ToolBase(object)`

Tools can have a graphical representation as the `SubplotTool` or not even be present in the Toolbar as `Quit`

The `ToolBase` has the following class attributes for configuration at definition time

- `keymap = None`: Key(s) to be used to trigger the tool
- `description = ''`: Small description of the tool
- `image = None`: Image that is used in the toolbar

The following instance attributes are set at instantiation:

- `name`
- `navigation`

Methods

- `trigger(self, event)`: This is the main method of the Tool, it is called when the Tool is triggered by: * Toolbar button click * keypress associated with the Tool Keymap * Call to `navigation.trigger_tool(name)`
- `set_figure(self, figure)`: Set the figure and navigation attributes
- `destroy(self, *args)`: Destroy the Tool graphical interface (if exists)

Available Tools

- `ToolQuit`

- ToolEnableAllNavigation
- ToolEnableNavigation
- ToolToggleGrid
- ToolToggleFullScreen
- ToolToggleYScale
- ToolToggleXScale
- ToolHome
- ToolBack
- ToolForward
- SaveFigureBase
- ConfigureSubplotsBase

ToolToggleBase(ToolBase)

The ToolToggleBase has the following class attributes for configuration at definition time

- radio_group = None: Attribute to group 'radio' like tools (mutually exclusive)
- cursor = None: Cursor to use when the tool is active

The **Toggleable** Tools, can capture keypress, mouse moves, and mouse button press

It defines the following methods

- enable(self, event): Called by ToolToggleBase.trigger method
- disable(self, event): Called when the tool is untoggled
- toggled : **Property** True or False

Available Tools

- ToolZoom
- ToolPan

NavigationBase

Defines the following attributes

- canvas:
- **keypresslock: Lock to know if the canvas key_press_event' is** available and process it
- messagelock: Lock to know if the message is available to write

Public methods for User use:

- nav_connect(self, s, func): Connect to to navigation for events

- `nav_disconnect(self, cid)`: Disconnect from navigation event
- `message_event(self, message, sender=None)`: Emit a `tool_message_event` event
- `active_toggle(self)`: **Property** The currently toggled tools or None
- `get_tool_keymap(self, name)`: Return a list of keys that are associated with the tool
- `set_tool_keymap(self, name, *keys)`: Set the keys for the given tool
- `remove_tool(self, name)`: Removes tool from the navigation control.
- `add_tools(self, tools)`: Add multiple tools to `Navigation`
- `add_tool(self, name, tool, group=None, position=None)`: Add a tool to the `Navigation`
- `tool_trigger_event(self, name, sender=None, canvasevent=None, data=None)`: Trigger a tool and fire the event
- `tools(self)` **Property**: Return a dict with available tools with corresponding keymaps, descriptions and objects
- `get_tool(self, name)`: Return the tool object

ToolbarBase

Methods for Backend implementation

- `add_toolitem(self, name, group, position, image, description, toggle)`: Add a toolitem to the toolbar. This method is a callback from `tool_added_event` (emited by navigation)
- `set_message(self, s)`: Display a message on toolbar or in status bar
- `toggle_toolitem(self, name)`: Toggle the toolitem without firing event.
- `remove_toolitem(self, name)`: Remove a toolitem from the `Toolbar`

85.12.6 Backward compatibility

For backward compatibility added a 'navigation' key to `rcsetup.validate_toolbar`, that is used for `Navigation` classes instantiation instead of the `NavigationToolbar` classes

With this parameter, it makes it transparent to anyone using the existing backends.

[@pelson comment: This also gives us an opportunity to avoid needing to implement all of this in the same PR - some backends can potentially exist without the new functionality for a short while (but it must be done at some point).]

85.13 MEP23: Multiple Figures per GUI window

- *Status*
- *Branches and Pull requests*
- *Abstract*
- *Detailed description*
- *Implementation*
 - *FigureManagerBase*
 - *new_figure_manager*
 - *new_figure_manager_given_figure*
 - *NavigationBase*
- *Backward compatibility*
- *Alternatives*

85.13.1 Status

Discussion

85.13.2 Branches and Pull requests

Previous work - <https://github.com/matplotlib/matplotlib/pull/2465> **To-delete**

85.13.3 Abstract

Add the possibility to have multiple figures grouped under the same `FigureManager`

85.13.4 Detailed description

Under the current structure, every canvas has its own window.

This is and may continue to be the desired method of operation for most use cases.

Sometimes when there are too many figures open at the same time, it is desirable to be able to group these under the same window [see](<https://github.com/matplotlib/matplotlib/issues/2194>).

The proposed solution modifies `FigureManagerBase` to contain and manage more than one canvas. The settings parameter `rcParams['backend.multifigure']` control when the **MultiFigure** behaviour is desired.

Note

It is important to note, that the proposed solution, assumes that the [MEP22](<https://github.com/matplotlib/matplotlib/wiki/Mep22>) is already in place. This is simply because the actual implementation of the Toolbar makes it pretty hard to switch between canvases.

85.13.5 Implementation

The first implementation will be done in GTK3 using a Notebook as canvas container.

FigureManagerBase

will add the following new methods

- `add_canvas`: To add a canvas to an existing `FigureManager` object
- `remove_canvas`: To remove a canvas from a `FigureManager` object, if it is the last one, it will be destroyed
- `move_canvas`: To move a canvas from one `FigureManager` to another.
- `set_canvas_title`: To change the title associated with a specific canvas container
- `get_canvas_title`: To get the title associated with a specific canvas container
- `get_active_canvas`: To get the canvas that is in the foreground and is subject to the gui events. There is no `set_active_canvas` because the active canvas, is defined when `show` is called on a `Canvas` object.

`new_figure_manager`

To control which `FigureManager` will contain the new figures, an extra optional parameter `figuremanager` will be added, this parameter value will be passed to `new_figure_manager_given_figure`

`new_figure_manager_given_figure`

- If `figuremanager` parameter is give, this `FigureManager` object will be used instead of creating a new one.
- If `rcParams['backend.multifigure'] == True`: The last `FigureManager` object will be used instead of creating a new one.

NavigationBase

Modifies the `NavigationBase` to keep a list of canvases, directing the actions to the active one

85.13.6 Backward compatibility

For the **MultiFigure** properties to be visible, the user has to activate them directly setting `rcParams['backend.multifigure'] = True`

It should be backwards compatible for backends that adhere to the current `FigureManagerBase` structure even if they have not implemented the **MultiFigure** magic yet.

85.13.7 Alternatives

Insted of modifying the `FigureManagerBase` it could be possible to add a parallel class, that handles the cases where `rcParams['backend.multifigure'] = True`. This will warranty that there won't be any problems with custom made backends, but also makes bigger the code, and more things to mantain.

85.14 MEP24: negative radius in polar plots

- *Status*
- *Branches and Pull requests*
- *Abstract*
- *Detailed description*
- *Implementation*
- *Related Issues*
- *Backward compatibility*
- *Alternatives*

85.14.1 Status

Discussion

85.14.2 Branches and Pull requests

None

85.14.3 Abstract

It is clear that polar plots need to be able to gracefully handle negative r values (not by clipping or reflection).

85.14.4 Detailed description

One obvious application that we should support is bB plots (see <https://github.com/matplotlib/matplotlib/issues/1730#issuecomment-40815837>), but this seems more generally useful (for example growth rate as a function of angle). The assumption in the current code (as I understand it) is that the center of the graph is $r=0$, however it would be good to be able to set the center to be at any r (with any value less than the off set clipped).

85.14.5 Implementation

85.14.6 Related Issues

#1730, #1603, #2203, #2133

85.14.7 Backward compatibility

85.14.8 Alternatives

85.15 MEP25: Serialization

- *Status*
- *Branches and Pull requests*
- *Abstract*
- *Detailed description*
- *Examples*
- *Implementation*
- *Backward compatibility*
- *Alternatives*

85.15.1 Status

Discussion

85.15.2 Branches and Pull requests

- development branches:
- related pull requests:

85.15.3 Abstract

This MEP aims at adding a serializable `Controller` objects to act as an `Artist` managers. Users would then communicate changes to an `Artist` via a `Controller`. In this way, functionality of the `Controller` objects may be added incrementally since each `Artist` is still responsible for drawing everything. The goal is to create an API that is usable both by graphing libraries requiring high-level descriptions of figures and libraries requiring low-level interpretations.

85.15.4 Detailed description

Matplotlib is a core plotting engine with an API that many users already understand. It's difficult/impossible for other graphing libraries to (1) get a complete figure description, (2) output raw data from the figure object as the user has provided it, (3) understand the semantics of the figure objects without heuristics, and (4) give matplotlib a complete figure description to visualize. In addition, because an `Artist` has no conception of its own semantics within the figure, it's difficult to interact with them in a natural way.

In this sense, matplotlib will adopt a standard Model-View-Controller (MVC) framework. The *Model* will be the user defined data, style, and semantics. The *Views* are the ensemble of each individual `Artist`, which are responsible for producing the final image based on the *model*. The *Controller* will be the `Controller` object managing its set of `Artist` objects.

The `Controller` must be able to export the information that it's carrying about the figure on command, perhaps via a `to_json` method or similar. Because it would be extremely extraneous to duplicate all of the information in the model with the controller, only user-specified information (data + style) are explicitly kept. If a user wants more information (defaults) from the view/model, it should be able to query for it.

- This might be annoying to do, non-specified kwargs are pulled from the `rcParams` object which is in turn created from reading a user specified file and can be dynamically changed at run time. I suppose we could keep a dict of default defaults and compare against that. Not clear how this will interact with the style sheet [[MEP26]] - @tacaswell

Additional Notes:

- The raw data does not necessarily need to be a `list`, `ndarray`, etc. Rather, it can more abstractly just have a method to yield data when needed.
- Because the `Controller` will contain extra information that users may not want to keep around, it should *not* be created by default. You should be able to both (a) instantiate a `Controller` with a figure and (b) build a figure with a `Controller`.

Use Cases:

- Export all necessary informat
- Serializing a matplotlib figure, saving it, and being able to rerun later.
- Any other source sending an appropriately formatted representation to matplotlib to open

85.15.5 Examples

Here are some examples of what the controllers should be able to do.

1. Instantiate a matplotlib figure from a serialized representation (e.g., JSON):

```
import json
from matplotlib.controllers import Controller
with open('my_figure') as f:
    o = json.load(f)
c = Controller(o)
fig = c.figure
```

2. Manage artists from the controller (e.g., Line2D):

```
# not really sure how this should look
c.axes[0].lines[0].color = 'b'
# ?
```

3. Export serializable figure representation:

```
o = c.to_json()
# or... we should be able to throw a figure object in there too
o = Controller.to_json(mpl_fig)
```

85.15.6 Implementation

1. Create base Controller objects that are able to manage Artist objects (e.g., Hist)

Comments:

- initialization should happen via unpacking **, so we need a copy of call signature parameter for the Artist we're ultimately trying to control. Unfortunate hard-coded repetition...
- should the additional **kwargs accepted by each Artist be tracked at the Controller
- how does a Controller know which artist belongs where? E.g., do we need to pass axes references?

Progress:

- A simple NB demonstrating some functionality for Line2DController objects: <https://nbviewer.jupyter.org/gist/theengineear/f0aa8d79f64325e767c0>

2. Write in protocols for the Controller to *update* the model.

Comments:

- how should containers be dealt with? E.g., what happens to old patches when we re-bin a histogram?
- in the link from (1), the old line is completely destroyed and redrawn, what if something is referencing it?

3. Create method by which a json object can be assembled from the Controllers

4. Deal with serializing the unserializable aspects of a figure (e.g., non-affine transforms?)

5. Be able to instantiate from a serialized representation
6. Reimplement the existing `pyplot` and `Axes` method, e.g. `pyplot.hist` and `Axes.hist` in terms of the new controller class.

> @theengineer: in #2 above, what do you mean by *get updates* from each `Artist`?

^ Yup. The `Controller` *shouldn't* need to get updated. This just happens in #3. Delete comments when you see this.

85.15.7 Backward compatibility

- pickling will change
- non-affine transformations will require a defined pickling method

85.15.8 Alternatives

PR #3150 suggested adding semantics by parasitically attaching extra containers to axes objects. This is a more complete solution with what should be a more developed/flexible/powerful framework.

85.16 MEP26: Artist styling

- *Status*
- *Branches and Pull requests*
- *Abstract*
- *Detailed description*
- *Implementation*
 - *BNF Grammar*
 - *Syntax*
 - * *Selectors*
 - * *GID selector*
 - * *Attributes and values*
 - *Parsing*
 - *Visitor pattern for matplotlib figure*
- *Backward compatibility*
- *Alternatives*
- *Appendix*

85.16.1 Status

Proposed

85.16.2 Branches and Pull requests

85.16.3 Abstract

This MEP proposes a new stylesheet implementation to allow more comprehensive and dynamic styling of artists.

The current version of matplotlib (1.4.0) allows stylesheets based on the rcParams syntax to be applied before creation of a plot. The methodology below proposes a new syntax, based on CSS, which would allow styling of individual artists and properties, which can be applied dynamically to existing objects.

This is related to (and makes steps toward) the overall goal of moving to a DOM/tree-like architecture.

85.16.4 Detailed description

Currently, the look and appearance of existing artist objects (figure, axes, Line2D etc...) can only be updated via `set_` and `get_` methods on the artist object, which is quite laborious, especially if no reference to the artist(s) has been stored. The new style sheets introduced in 1.4 allow styling before a plot is created, but do not offer any means to dynamically update plots or distinguish between artists of the same type (i.e. to specify the `line_color` and `line_style` separately for differing Line2D objects).

The initial development should concentrate on allowing styling of artist primitives (those `artists` that do not contain other `artists`), and further development could expand the CSS syntax rules and parser to allow more complex styling. See the appendix for a list of primitives.

The new methodology would require development of a number of steps:

- A new stylesheet syntax (likely based on CSS) to allow selection of artists by type, class, id etc...
- A mechanism by which to parse a stylesheet into a tree
- A mechanism by which to translate the parse-tree into something which can be used to update the properties of relevant artists. Ideally this would implement a method by which to traverse the artists in a tree-like structure.
- A mechanism by which to generate a stylesheet from existing artist properties. This would be useful to allow a user to export a stylesheet from an existing figure (where the appearance may have been set using the matplotlib API)...

85.16.5 Implementation

It will be easiest to allow a '3rd party' to modify/set the style of an artist if the 'style' is created as a separate class and store against the artist as a property. The `GraphicsContext` class already provides the basis of a `Style` class and an artists `draw` method can be refactored to use the `Style` class rather than setting up it's own `GraphicsContext` and transferring it's style-related properties to it. A minimal example of how this could be implemented is shown here: https://github.com/JamesRamm/mpl_experiment

IMO, this will also make the API and code base much neater as individual get/set methods for artist style properties are now redundant... Indirectly related would be a general drive to replace get/set methods with properties. Implementing the style class with properties would be a big stride toward this...

For initial development, I suggest developing a syntax based on a much (much much) simplified version of CSS. I am in favour of dubbing this Artist Style Sheets :+1: :

BNF Grammar

I propose a very simple syntax to implement initially (like a proof of concept), which can be expanded upon in the future. The BNF form of the syntax is given below and then explained

```
RuleSet ::= SelectorSequence "{"Declaration"}"
SelectorSequence ::= Selector {"," Selector}
Declaration ::= propName":" propValue";"
Selector ::= ArtistIdent{"#"Ident}
propName ::= Ident
propValue ::= Ident | Number | Colour | "None"
```

`ArtistIdent`, `Ident`, `Number` and `Colour` are tokens (the basic building blocks of the expression) which are defined by regular expressions.

Syntax

A CSS stylesheet consists of a series of **rule sets** in hierarchical order (rules are applied from top to bottom). Each rule follows the syntax

```
selector {attribute: value;}
```

Each rule can have any number of `attribute: value` pairs, and a stylesheet can have any number of rules.

The initial syntax is designed only for artist primitives. It does not address the question of how to set properties on container types (whose properties may themselves be artists with settable properties), however, a future solution to this could simply be nested `RuleSet` s

Selectors

Selectors define the object to which the attribute updates should be applied. As a starting point, I propose just 2 selectors to use in initial development:

Artist Type Selector

Select an artist by it's type. E.g Line2D or Text:

```
Line2D {attribute: value}
```

The regex for matching the artist type selector (`ArtistIdent` in the BNF grammar) would be:

```
ArtistIdent = r'(?P<ArtistIdent>
->\bLine2D\b|\bText\b|\bAxesImage\b|\bFigureImage\b|\bPatch\b)'
```

GID selector

Select an artist by its gid:

```
Line2D#myGID {attribute: value}
```

A gid can be any string, so the regex could be as follows:

```
Ident = r'(?P<Ident>[a-zA-Z_][a-zA-Z_0-9]*)'
```

The above selectors roughly correspond to their CSS counterparts (<http://www.w3.org/TR/CSS21/selector.html>)

Attributes and values

- **Attributes** are any valid (settable) property for the **artist** in question.
- **Values** are any valid value for the property (Usually a string, or number).

Parsing

Parsing would consist of breaking the stylesheet into tokens (the python cookbook gives a nice tokenizing recipe on page 66), applying the syntax rules and constructing a **Tree**. This requires defining the grammar of the stylesheet (again, we can borrow from CSS) and writing a parser. Happily, there is a recipe for this in the python cookbook aswell.

Visitor pattern for matplotlib figure

In order to apply the stylesheet rules to the relevant artists, we need to 'visit' each artist in a figure and apply the relevant rule. Here is a visitor class (again, thanks to python cookbook), where each node would be

an artist in the figure. A `visit_` method would need to be implemented for each mpl artist, to handle the different properties for each

```
class Visitor:
    def visit(self, node):
        name = 'visit_' + type(node).__name__
        meth = getattr(self, name, None)
        if meth is None:
            raise NotImplementedError
        return meth(node)
```

An evaluator class would then take the stylesheet rules and implement the visitor on each one of them.

85.16.6 Backward compatibility

Implementing a separate `Style` class would break backward compatibility as many `get/set` methods on an artist would become redundant. While it would be possible to alter these methods to hook into the `Style` class (stored as a property against the artist), I would be in favor of simply removing them to both neaten/simplify the codebase and to provide a simple, uncluttered API...

85.16.7 Alternatives

No alternatives, but some of the ground covered here overlaps with MEP25, which may assist in this development

85.16.8 Appendix

Matplotlib primitives

This will form the initial selectors which stylesheets can use.

- `Line2D`
- `Text`
- `AxesImage`
- `FigureImage`
- `Patch`

85.17 MEP27: decouple pyplot from backends

- *Status*
- *Branches and Pull requests*

- *Abstract*
- *Detailed description*
- *Implementation*
- *Future compatibility*
- *Backward compatibility*
- *Alternatives*
- *Questions*

85.17.1 Status

Discussion

85.17.2 Branches and Pull requests

Main PR (including GTK3): + <https://github.com/matplotlib/matplotlib/pull/4143>

Backend specific branch diffs: + <https://github.com/OceanWolf/matplotlib/compare/backend-refactor...OceanWolf:backend-refactor-tkagg> + <https://github.com/OceanWolf/matplotlib/compare/backend-refactor...OceanWolf:backend-refactor-qt> + <https://github.com/OceanWolf/matplotlib/compare/backend-refactor...backend-refactor-wx>

85.17.3 Abstract

This MEP refactors the backends to give a more structured and consistent API, removing generic code and consolidate existing code. To do this we propose splitting:

1. `FigureManagerBase` and its derived classes into the core functionality class `FigureManager` and a backend specific class `WindowBase` and
2. `ShowBase` and its derived classes into `Gcf.show_all` and `MainLoopBase`.

85.17.4 Detailed description

This MEP aims to consolidate the backends API into one single uniform API, removing generic code out of the backend (which includes `_pylab_helpers` and `Gcf`), and push code to a more appropriate level in `matplotlib`. With this we automatically remove inconsistencies that appear in the backends, such as `FigureManagerBase.resize(w, h)` which sometimes sets the canvas, and other times set the entire window to the dimensions given, depending on the backend.

Two main places for generic code appear in the classes derived from `FigureManagerBase` and `ShowBase`.

1. `FigureManagerBase` has **three** jobs at the moment:

- (a) The documentation describes it as a *“Helper class for pyplot mode, wraps everything up into a neat bundle”*
 - (b) But it doesn't just wrap the canvas and toolbar, it also does all of the windowing tasks itself. The conflation of these two tasks gets seen the best in the following line: ``python self.set_window_title("Figure %d" % num) `` This combines backend specific code `self.set_window_title(title)` with matplotlib generic code `title = "Figure %d" % num`.
 - (c) Currently the backend specific subclass of `FigureManager` decides when to end the mainloop. This also seems very wrong as the figure should have no control over the other figures.
2. `ShowBase` has two jobs:
- (a) It has the job of going through all figure managers registered in `_pylab_helpers.Gcf` and telling them to show themselves.
 - (b) And secondly it has the job of performing the backend specific mainloop to block the main programme and thus keep the figures from dying.

85.17.5 Implementation

The description of this MEP gives us most of the solution:

1. To remove the windowing aspect out of `FigureManagerBase` letting it simply wrap this new class along with the other backend classes. Create a new `WindowBase` class that can handle this functionality, with pass-through methods (`:arrow_right:`) to `WindowBase`. Classes that subclass `WindowBase` should also subclass the GUI specific window class to ensure backward compatibility (`manager.window == manager.window`).
2. Refactor the mainloop of `ShowBase` into `MainLoopBase`, which encapsulates the end of the loop as well. We give an instance of `MainLoop` to `FigureManager` as a key unlock the exit method (requiring all keys returned before the loop can die). Note this opens the possibility for multiple backends to run concurrently.
3. Now that `FigureManagerBase` has no backend specifics in it, to rename it to `FigureManager`, and move to a new file `backend_managers.py` noting that:
 - (a) This allows us to break up the conversion of backends into separate PRs as we can keep the existing `FigureManagerBase` class and its dependencies intact.
 - (b) and this also anticipates MEP22 where the new `NavigationBase` has morphed into a backend independent `ToolManager`.

FigureManager-Base(canvas, num)	FigureManager(fig, num)	WindowBase(title)	Notes
show		show	
destroy	calls destroy on all components	destroy	
full_screen_toggle	handles logic	set_fullscreen	
resize		resize	
key_press	key_press		
show_popup	show_poup		Not used anywhere in mpl, and does nothing.
get_window_title		get_window_title	
set_window_title		set_window_title	
	_get_toolbar		A common method to all subclasses of FigureManagerBase
		set_default_size	
		add_element_to_window	

ShowBase	MainLoopBase	Notes
mainloop	begin	
	end	Gets called automagically when no more instances of the subclass exist
__call__		Method moved to Gcf.show_all

85.17.6 Future compatibility

As eluded to above when discussing MEP 22, this refactor makes it easy to add in new generic features. At the moment, MEP 22 has to make ugly hacks to each class extending from `FigureManagerBase`. With this code, this only needs to get made in the single `FigureManager` class. This also makes the later deprecation of `NavigationToolbar2` very straightforward, only needing to touch the single `FigureManager` class

MEP 23 makes for another use case where this refactored code will come in very handy.

85.17.7 Backward compatibility

As we leave all backend code intact, only adding missing methods to existing classes, this should work seamlessly for all use cases. The only difference will lie for backends that used `FigureManager.resize` to resize the canvas and not the window, due to the standardisation of the API.

I would envision that the classes made obsolete by this refactor get deprecated and removed on the same timetable as `NavigationToolbar2`, also note that the change in call signature to the `FigureCanvasWx` constructor, while backward compatible, I think the old (imho ugly style) signature should get deprecated and removed in the same manner as everything else.

back-end	manager.resize(w,h)	Extra
gtk3	window	
Tk	canvas	
Qt	window	
Wx	canvas	FigureManagerWx had <code>frame</code> as an alias to <code>window</code> , so this also breaks BC.

85.17.8 Alternatives

If there were any alternative solutions to solving the same problem, they should be discussed here, along with a justification for the chosen approach.

85.17.9 Questions

Mdehoon: Can you elaborate on how to run multiple backends concurrently?

OceanWolf: @mdehoon, as I say, not for this MEP, but I see this MEP opens it up as a future possibility. Basically the `MainLoopBase` class acts a per backend Gcf, in this MEP it tracks the number of figures open per backend, and manages the mainloops for those backends. It closes the backend specific mainloop when it detects that no figures remain open for that backend. Because of this I imagine that with only a small amount of tweaking that we can do full-multi-backend matplotlib. No idea yet why one would want to, but I leave the possibility there in `MainLoopBase`. With all the backend-code specifics refactored out of `FigureManager` also aids in this, one manager to rule them (the backends) all.

Mdehoon: @OceanWolf, OK, thanks for the explanation. Having a uniform API for the backends is very important for the maintainability of matplotlib. I think this MEP is a step in the right direction.

Matplotlib only uses BSD compatible code. If you bring in code from another project make sure it has a PSF, BSD, MIT or compatible license (see the Open Source Initiative [licenses page](#) for details on individual licenses). If it doesn't, you may consider contacting the author and asking them to relicense it. GPL and LGPL code are not acceptable in the main code base, though we are considering an alternative way of distributing L/GPL code through an separate channel, possibly a toolkit. If you include code, make sure you include a copy of that code's license in the license directory if the code's license requires you to distribute the license with it. Non-BSD compatible licenses are acceptable in matplotlib toolkits (e.g., basemap), but make sure you clearly state the licenses you are using.

86.1 Why BSD compatible?

The two dominant license variants in the wild are GPL-style and BSD-style. There are countless other licenses that place specific restrictions on code reuse, but there is an important difference to be considered in the GPL and BSD variants. The best known and perhaps most widely used license is the GPL, which in addition to granting you full rights to the source code including redistribution, carries with it an extra obligation. If you use GPL code in your own code, or link with it, your product must be released under a GPL compatible license. i.e., you are required to give the source code to other people and give them the right to redistribute it as well. Many of the most famous and widely used open source projects are released under the GPL, including linux, gcc, emacs and sage.

The second major class are the BSD-style licenses (which includes MIT and the python PSF license). These basically allow you to do whatever you want with the code: ignore it, include it in your own open source project, include it in your proprietary product, sell it, whatever. python itself is released under a BSD compatible license, in the sense that, quoting from the PSF license page:

There **is** no GPL-like "copyleft" restriction. Distributing binary-only versions of Python, modified **or not**, **is** allowed. There **is** no requirement to release **any** of your source code. You can also write extension modules **for** Python **and** provide them only **in** binary form.

Famous projects released under a BSD-style license in the permissive sense of the last paragraph are the BSD operating system, python and TeX.

There are several reasons why early matplotlib developers selected a BSD compatible license. matplotlib is a python extension, and we choose a license that was based on the python license (BSD compatible).

Also, we wanted to attract as many users and developers as possible, and many software companies will not use GPL code in software they plan to distribute, even those that are highly committed to open source development, such as [enthought](#), out of legitimate concern that use of the GPL will “infect” their code base by its viral nature. In effect, they want to retain the right to release some proprietary code. Companies and institutions who use matplotlib often make significant contributions, because they have the resources to get a job done, even a boring one. Two of the matplotlib backends (FLTK and WX) were contributed by private companies. The final reason behind the licensing choice is compatibility with the other python extensions for scientific computing: ipython, numpy, scipy, the enthought tool suite and python itself are all distributed under BSD compatible licenses.

DEFAULT COLOR CHANGES

As discussed at length elsewhere [insert links], `jet` is an empirically bad color map and should not be the default color map. Due to the position that changing the appearance of the plot breaks backward compatibility, this change has been put off for far longer than it should have been. In addition to changing the default color map we plan to take the chance to change the default color-cycle on plots and to adopt a different color map for filled plots (`imshow`, `pcolor`, `contourf`, etc) and for scatter like plots.

87.1 Default Heat Map Colormap

The choice of a new color map is fertile ground to bike-shedding (“No, it should be `_this_` color”) so we have a proposed set criteria (via Nathaniel Smith) to evaluate proposed color maps.

- it should be a sequential colormap, because diverging colormaps are really misleading unless you know where the “center” of the data is, and for a default colormap we generally won’t.
- it should be perceptually uniform, i.e., human subjective judgments of how far apart nearby colors are should correspond as linearly as possible to the difference between the numerical values they represent, at least locally.
- it should have a perceptually uniform luminance ramp, i.e. if you convert to greyscale it should still be uniform. This is useful both in practical terms (greyscale printers are still a thing!) and because luminance is a very strong and natural cue to magnitude.
- it should also have some kind of variation in hue, because hue variation is a really helpful additional cue to perception, having two cues is better than one, and there’s no reason not to do it.
- the hue variation should be chosen to produce reasonable results even for viewers with the more common types of colorblindness. (Which rules out things like red-to-green.)
- For bonus points, it would be nice to choose a hue ramp that still works if you throw away the luminance variation, because then we could use the version with varying luminance for 2d plots, and the version with just hue variation for 3d plots. (In 3d plots you really want to reserve the luminance channel for lighting/shading, because your brain is *really* good at extracting 3d shape from luminance variation. If the 3d surface itself has massively varying luminance then this screws up the ability to see shape.)
- Not infringe any existing IP

87.1.1 Example script

87.1.2 Proposed Colormaps

87.2 Default Scatter Colormap

For heat-map like applications it can be desirable to cover as much of the luminance scale as possible, however when color mapping markers, having markers too close to white can be a problem. For that reason we propose using a different (but maybe related) color map to the heat map for marker-based. The design parameters are the same as above, only with a more limited luminance variation.

87.2.1 Example script

```
import numpy as np
import matplotlib.pyplot as plt

np.random.seed(1234)

fig, (ax1, ax2) = plt.subplots(1, 2)

N = 50
x = np.random.rand(N)
y = np.random.rand(N)
colors = np.random.rand(N)
area = np.pi * (15 * np.random.rand(N))**2 # 0 to 15 point radiuses

ax1.scatter(x, y, s=area, c=colors, alpha=0.5)

X,Y = np.meshgrid(np.arange(0, 2*np.pi, .2),
                  np.arange(0, 2*np.pi, .2))
U = np.cos(X)
V = np.sin(Y)
Q = ax2.quiver(X, Y, U, V, units='width')
qd = np.random.rand(np.prod(X.shape))
Q.set_array(qd)
```

87.2.2 Proposed Colormaps

87.3 Color Cycle / Qualitative color map

When plotting lines it is frequently desirable to plot multiple lines or artists which need to be distinguishable, but there is no inherent ordering.

87.3.1 Example script

```
import numpy as np
import matplotlib.pyplot as plt

fig, (ax1, ax2) = plt.subplots(1, 2)

x = np.linspace(0, 1, 10)

for j in range(10):
    ax1.plot(x, x * j)

th = np.linspace(0, 2*np.pi, 1024)
for j in np.linspace(0, np.pi, 10):
    ax2.plot(th, np.sin(th + j))

ax2.set_xlim(0, 2*np.pi)
```

87.3.2 Proposed Color cycle

Part IX

Matplotlib Examples

ANIMATION EXAMPLES

88.1 animation example code: moviewriter.py

[source code]

```
"""
=====
MovieWriter
=====

This example uses a MovieWriter directly to grab individual frames and write
them to a file. This avoids any event loop integration, but has the advantage
of working with even the Agg backend. This is not recommended for use in an
interactive setting.

"""
# -*- noplots -*-

import numpy as np
import matplotlib
matplotlib.use("Agg")
import matplotlib.pyplot as plt
import matplotlib.animation as animation

FFMpegWriter = animation.writers['ffmpeg']
metadata = dict(title='Movie Test', artist='Matplotlib',
                comment='Movie support!')
writer = FFMpegWriter(fps=15, metadata=metadata)

fig = plt.figure()
l, = plt.plot([], [], 'k-o')

plt.xlim(-5, 5)
plt.ylim(-5, 5)

x0, y0 = 0, 0

with writer.saving(fig, "writer_test.mp4", 100):
    for i in range(100):
        x0 += 0.1 * np.random.randn()
```

```

y0 += 0.1 * np.random.randn()
l.set_data(x0, y0)
writer.grab_frame()

```

Keywords: python, matplotlib, pylab, example, codex (see *Search examples*)

88.2 animation example code: subplots.py

[source code]

```

"""
=====
Animated subplots
=====

This example uses subclassing, but there is no reason that the proper function
couldn't be set up and then use FuncAnimation. The code is long, but not
really complex. The length is due solely to the fact that there are a total of
9 lines that need to be changed for the animation as well as 3 subplots that
need initial set up.

"""

import numpy as np
import matplotlib.pyplot as plt
from matplotlib.lines import Line2D
import matplotlib.animation as animation

class SubplotAnimation(animation.TimedAnimation):
    def __init__(self):
        fig = plt.figure()
        ax1 = fig.add_subplot(1, 2, 1)
        ax2 = fig.add_subplot(2, 2, 2)
        ax3 = fig.add_subplot(2, 2, 4)

        self.t = np.linspace(0, 80, 400)
        self.x = np.cos(2 * np.pi * self.t / 10.)
        self.y = np.sin(2 * np.pi * self.t / 10.)
        self.z = 10 * self.t

        ax1.set_xlabel('x')
        ax1.set_ylabel('y')
        self.line1 = Line2D([], [], color='black')
        self.line1a = Line2D([], [], color='red', linewidth=2)
        self.line1e = Line2D(
            [], [], color='red', marker='o', markeredgecolor='r')
        ax1.add_line(self.line1)
        ax1.add_line(self.line1a)
        ax1.add_line(self.line1e)
        ax1.set_xlim(-1, 1)

```



```

ax1.set_ylim(-2, 2)
ax1.set_aspect('equal', 'datalim')

ax2.set_xlabel('y')
ax2.set_ylabel('z')
self.line2 = Line2D([], [], color='black')
self.line2a = Line2D([], [], color='red', linewidth=2)
self.line2e = Line2D(
    [], [], color='red', marker='o', markeredgecolor='r')
ax2.add_line(self.line2)
ax2.add_line(self.line2a)
ax2.add_line(self.line2e)
ax2.set_xlim(-1, 1)
ax2.set_ylim(0, 800)

ax3.set_xlabel('x')
ax3.set_ylabel('z')
self.line3 = Line2D([], [], color='black')
self.line3a = Line2D([], [], color='red', linewidth=2)
self.line3e = Line2D(
    [], [], color='red', marker='o', markeredgecolor='r')
ax3.add_line(self.line3)
ax3.add_line(self.line3a)
ax3.add_line(self.line3e)
ax3.set_xlim(-1, 1)
ax3.set_ylim(0, 800)

animation.TimedAnimation.__init__(self, fig, interval=50, blit=True)

def _draw_frame(self, framedata):
    i = framedata
    head = i - 1
    head_slice = (self.t > self.t[i] - 1.0) & (self.t < self.t[i])

    self.line1.set_data(self.x[:i], self.y[:i])
    self.line1a.set_data(self.x[head_slice], self.y[head_slice])
    self.line1e.set_data(self.x[head], self.y[head])

    self.line2.set_data(self.y[:i], self.z[:i])
    self.line2a.set_data(self.y[head_slice], self.z[head_slice])
    self.line2e.set_data(self.y[head], self.z[head])

    self.line3.set_data(self.x[:i], self.z[:i])
    self.line3a.set_data(self.x[head_slice], self.z[head_slice])
    self.line3e.set_data(self.x[head], self.z[head])

    self._drawn_artists = [self.line1, self.line1a, self.line1e,
                           self.line2, self.line2a, self.line2e,
                           self.line3, self.line3a, self.line3e]

def new_frame_seq(self):
    return iter(range(self.t.size))

```

```
def _init_draw(self):
    lines = [self.line1, self.line1a, self.line1e,
             self.line2, self.line2a, self.line2e,
             self.line3, self.line3a, self.line3e]
    for l in lines:
        l.set_data([], [])

ani = SubplotAnimation()
# ani.save('test_sub.mp4')
plt.show()
```

Keywords: python, matplotlib, pylab, example, codex (see [Search examples](#))

89.1 api example code: agg_oo.py

[source code]

```
# -*- noplots -*-
"""
=====
The object-oriented interface
=====

A pure OO (look Ma, no pylab!) example using the agg backend
"""
from matplotlib.backends.backend_agg import FigureCanvasAgg as FigureCanvas
from matplotlib.figure import Figure

fig = Figure()
canvas = FigureCanvas(fig)
ax = fig.add_subplot(111)
ax.plot([1, 2, 3])
ax.set_title('hi mom')
ax.grid(True)
ax.set_xlabel('time')
ax.set_ylabel('volts')
canvas.print_figure('test')
```

Keywords: python, matplotlib, pylab, example, codex (see [Search examples](#))

89.2 api example code: barchart_demo.py

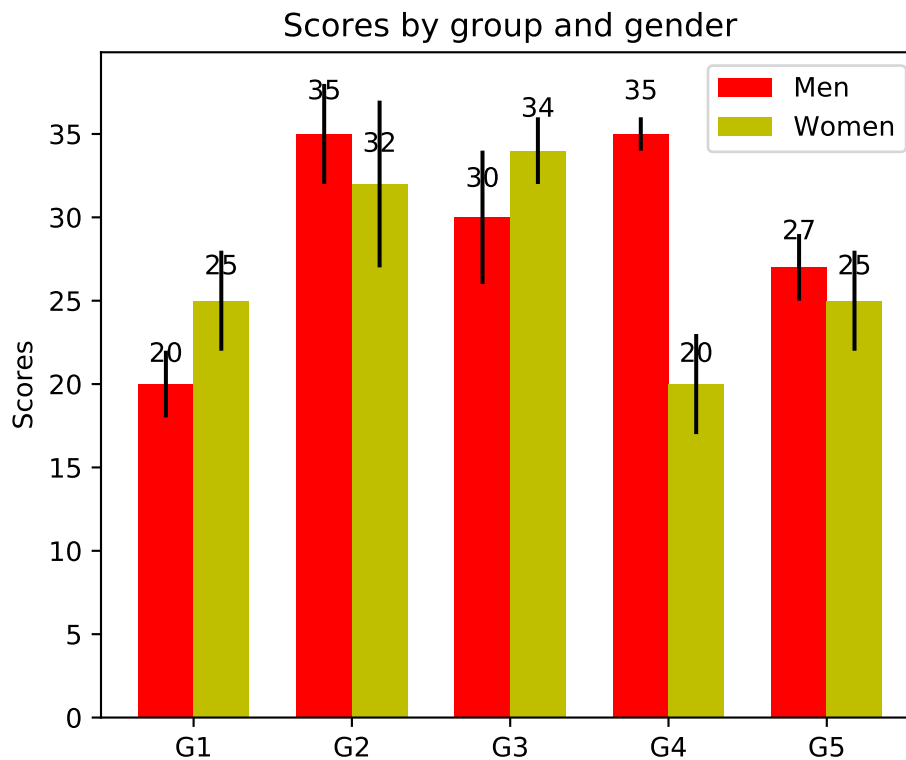

```

"""
=====
Barchart
=====

A bar plot with errorbars and height labels on individual bars
"""
import numpy as np
import matplotlib.pyplot as plt

N = 5
men_means = (20, 35, 30, 35, 27)
men_std = (2, 3, 4, 1, 2)

ind = np.arange(N) # the x locations for the groups
width = 0.35      # the width of the bars

fig, ax = plt.subplots()
rects1 = ax.bar(ind, men_means, width, color='r', yerr=men_std)

women_means = (25, 32, 34, 20, 25)
women_std = (3, 5, 2, 3, 3)

```

```
rects2 = ax.bar(ind + width, women_means, width, color='y', yerr=women_std)

# add some text for labels, title and axes ticks
ax.set_ylabel('Scores')
ax.set_title('Scores by group and gender')
ax.set_xticks(ind + width / 2)
ax.set_xticklabels(('G1', 'G2', 'G3', 'G4', 'G5'))

ax.legend((rects1[0], rects2[0]), ('Men', 'Women'))

def autolabel(rects):
    """
    Attach a text label above each bar displaying its height
    """
    for rect in rects:
        height = rect.get_height()
        ax.text(rect.get_x() + rect.get_width()/2., 1.05*height,
               '%d' % int(height),
               ha='center', va='bottom')

autolabel(rects1)
autolabel(rects2)

plt.show()
```

Keywords: python, matplotlib, pylab, example, codex (see [Search examples](#))

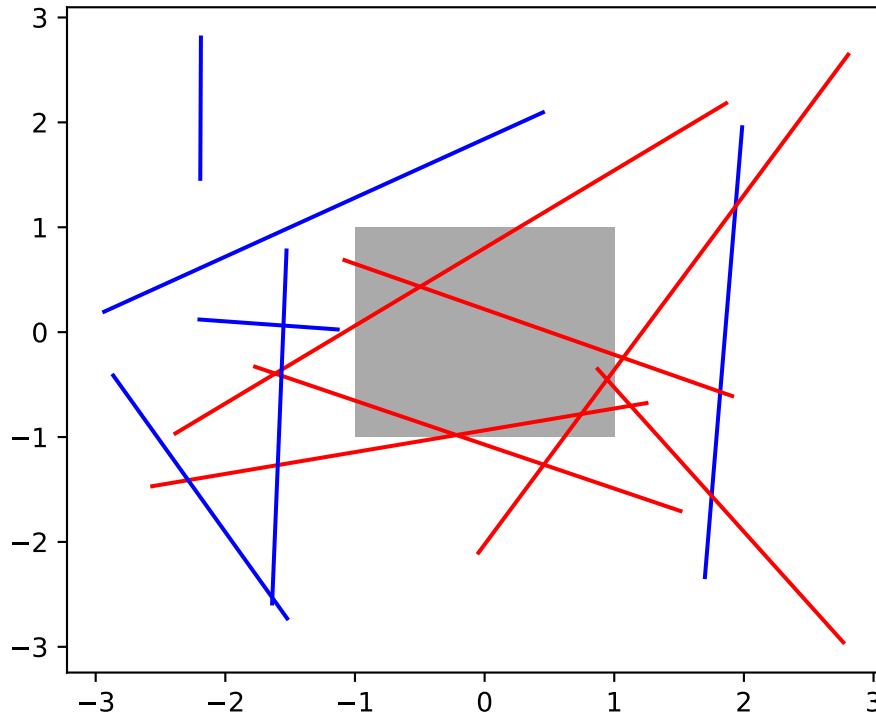
89.3 api example code: `bbox_intersect.py`

```

"""
=====
Changing colors of lines intersecting a box
=====

The lines intersecting the rectangle are colored in red, while the others
are left as blue lines. This example showcases the `intersect_bbox` function.

"""

import numpy as np
import matplotlib.pyplot as plt
from matplotlib.transforms import Bbox
from matplotlib.path import Path

left, bottom, width, height = (-1, -1, 2, 2)
rect = plt.Rectangle((left, bottom), width, height, facecolor="#aaaaaa")

fig, ax = plt.subplots()
ax.add_patch(rect)

bbox = Bbox.from_bounds(left, bottom, width, height)

```

```

for i in range(12):
    vertices = (np.random.random((2, 2)) - 0.5) * 6.0
    path = Path(vertices)
    if path.intersects_bbox(bbox):
        color = 'r'
    else:
        color = 'b'
    ax.plot(vertices[:, 0], vertices[:, 1], color=color)

plt.show()

```

Keywords: python, matplotlib, pylab, example, codex (see [Search examples](#))

89.4 api example code: collections_demo.py

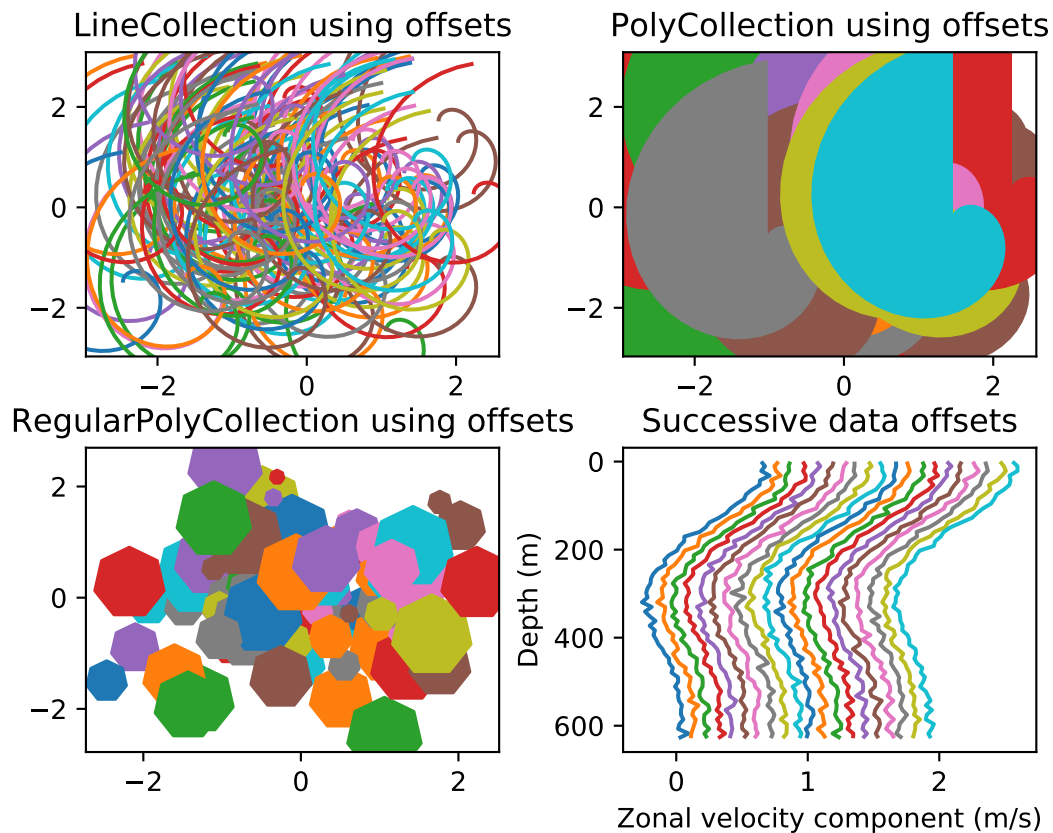

```

"""
=====
Line, Poly and RegularPoly Collection with autoscaling
=====

For the first two subplots, we will use spirals. Their

```

size will be set in plot units, not data units. Their positions will be set in data units by using the "offsets" and "transOffset" kwargs of the LineCollection and PolyCollection.

The third subplot will make regular polygons, with the same type of scaling and positioning as in the first two.

The last subplot illustrates the use of "offsets=(x0,y0)", that is, a single tuple instead of a list of tuples, to generate successively offset curves, with the offset given in data units. This behavior is available only for the LineCollection.

'''

```
import matplotlib.pyplot as plt
from matplotlib import collections, colors, transforms
import numpy as np

nverts = 50
npts = 100

# Make some spirals
r = np.arange(nverts)
theta = np.linspace(0, 2*np.pi, nverts)
xx = r * np.sin(theta)
yy = r * np.cos(theta)
spiral = list(zip(xx, yy))

# Make some offsets
rs = np.random.RandomState([12345678])
xo = rs.randn(npts)
yo = rs.randn(npts)
xyo = list(zip(xo, yo))

# Make a list of colors cycling through the default series.
colors = [colors.to_rgba(c)
           for c in plt.rcParams['axes.prop_cycle'].by_key()['color']]

fig, axes = plt.subplots(2, 2)
fig.subplots_adjust(top=0.92, left=0.07, right=0.97,
                    hspace=0.3, wspace=0.3)
((ax1, ax2), (ax3, ax4)) = axes # unpack the axes

col = collections.LineCollection([spiral], offsets=xyo,
                                 transOffset=ax1.transData)
trans = fig.dpi_scale_trans + transforms.Affine2D().scale(1.0/72.0)
col.set_transform(trans) # the points to pixels transform
# Note: the first argument to the collection initializer
# must be a list of sequences of x,y tuples; we have only
# one sequence, but we still have to put it in a list.
ax1.add_collection(col, autolim=True)
# autolim=True enables autoscaling. For collections with
```



```

# offsets like this, it is neither efficient nor accurate,
# but it is good enough to generate a plot that you can use
# as a starting point.  If you know beforehand the range of
# x and y that you want to show, it is better to set them
# explicitly, leave out the autolim kwarg (or set it to False),
# and omit the 'ax1.autoscale_view()' call below.

# Make a transform for the line segments such that their size is
# given in points:
col.set_color(colors)

ax1.autoscale_view() # See comment above, after ax1.add_collection.
ax1.set_title('LineCollection using offsets')

# The same data as above, but fill the curves.
col = collections.PolyCollection([spiral], offsets=xyo,
                                transOffset=ax2.transData)
trans = transforms.Affine2D().scale(fig.dpi/72.0)
col.set_transform(trans) # the points to pixels transform
ax2.add_collection(col, autolim=True)
col.set_color(colors)

ax2.autoscale_view()
ax2.set_title('PolyCollection using offsets')

# 7-sided regular polygons
col = collections.RegularPolyCollection(7,
                                       sizes=np.fabs(xx) * 10.0, offsets=xyo,
                                       transOffset=ax3.transData)
trans = transforms.Affine2D().scale(fig.dpi / 72.0)
col.set_transform(trans) # the points to pixels transform
ax3.add_collection(col, autolim=True)
col.set_color(colors)
ax3.autoscale_view()
ax3.set_title('RegularPolyCollection using offsets')

# Simulate a series of ocean current profiles, successively
# offset by 0.1 m/s so that they form what is sometimes called
# a "waterfall" plot or a "stagger" plot.

nverts = 60
ncurves = 20
offs = (0.1, 0.0)

yy = np.linspace(0, 2*np.pi, nverts)
ym = np.amax(yy)
xx = (0.2 + (ym - yy)/ym)**2 * np.cos(yy - 0.4)*0.5
segs = []
for i in range(ncurves):

```

```

xxx = xx + 0.02*rs.randn(nverts)
curve = list(zip(xxx, yy*100))
segs.append(curve)

col = collections.LineCollection(segs, offsets=offs)
ax4.add_collection(col, autolim=True)
col.set_color(colors)
ax4.autoscale_view()
ax4.set_title('Successive data offsets')
ax4.set_xlabel('Zonal velocity component (m/s)')
ax4.set_ylabel('Depth (m)')
# Reverse the y-axis so depth increases downward
ax4.set_ylim(ax4.get_ylim()[::-1])

plt.show()

```

Keywords: python, matplotlib, pylab, example, codex (see [Search examples](#))

89.5 api example code: colorbar_basics.py

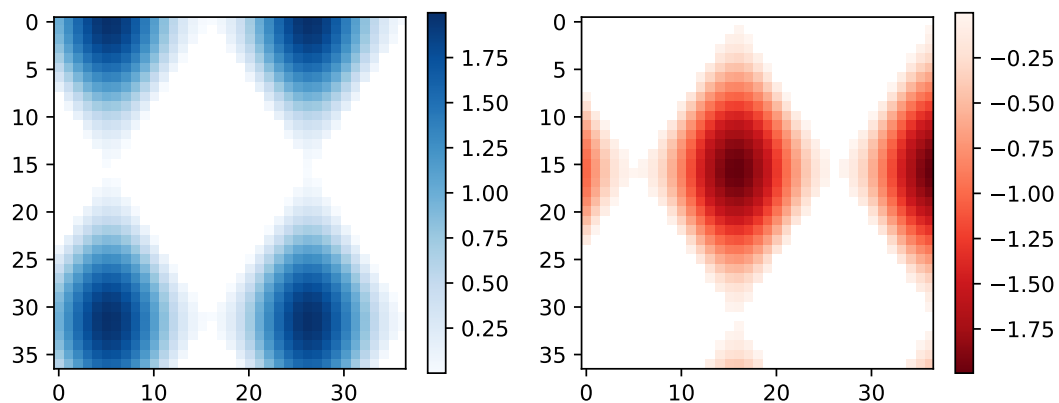

```

"""
=====
Colorbar
=====

This example shows how to use colorbar by specifying the mappable object (here
the imshow returned object) and the axes to attach the colorbar to.
"""

import numpy as np
import matplotlib.pyplot as plt

# setup some generic data
N = 37

```

```

x, y = np.mgrid[:N, :N]
Z = (np.cos(x*0.2) + np.sin(y*0.3))

# mask out the negative and positive values, respectively
Zpos = np.ma.masked_less(Z, 0)
Zneg = np.ma.masked_greater(Z, 0)

fig, (ax1, ax2) = plt.subplots(figsize=(8, 3), ncols=2)

# plot just the positive data and save the
# color "mappable" object returned by ax1.imshow
pos = ax1.imshow(Zpos, cmap='Blues', interpolation='none')

# add the colorbar using the figure's method,
# telling which mappable we're talking about and
# which axes object it should be near
fig.colorbar(pos, ax=ax1)

# repeat everything above for the the negative data
neg = ax2.imshow(Zneg, cmap='Reds_r', interpolation='none')
fig.colorbar(neg, ax=ax2)

plt.show()

```

Keywords: python, matplotlib, pylab, example, codex (see [Search examples](#))

89.6 api example code: colorbar_only.py

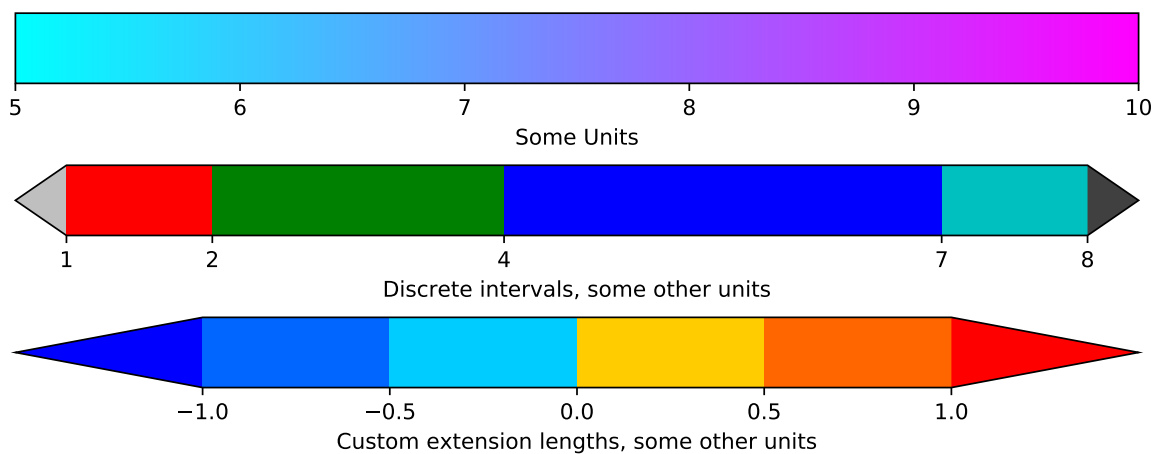

```

"""
=====
Customized colorbars
=====

This example shows how to build colorbars without an attached mappable.
"""

```

```
import matplotlib.pyplot as plt
import matplotlib as mpl

# Make a figure and axes with dimensions as desired.
fig = plt.figure(figsize=(8, 3))
ax1 = fig.add_axes([0.05, 0.80, 0.9, 0.15])
ax2 = fig.add_axes([0.05, 0.475, 0.9, 0.15])
ax3 = fig.add_axes([0.05, 0.15, 0.9, 0.15])

# Set the colormap and norm to correspond to the data for which
# the colorbar will be used.
cmap = mpl.cm.cool
norm = mpl.colors.Normalize(vmin=5, vmax=10)

# ColorbarBase derives from ScalarMappable and puts a colorbar
# in a specified axes, so it has everything needed for a
# standalone colorbar. There are many more kwargs, but the
# following gives a basic continuous colorbar with ticks
# and labels.
cb1 = mpl.colorbar.ColorbarBase(ax1, cmap=cmap,
                                norm=norm,
                                orientation='horizontal')
cb1.set_label('Some Units')

# The second example illustrates the use of a ListedColormap, a
# BoundaryNorm, and extended ends to show the "over" and "under"
# value colors.
cmap = mpl.colors.ListedColormap(['r', 'g', 'b', 'c'])
cmap.set_over('0.25')
cmap.set_under('0.75')

# If a ListedColormap is used, the length of the bounds array must be
# one greater than the length of the color list. The bounds must be
# monotonically increasing.
bounds = [1, 2, 4, 7, 8]
norm = mpl.colors.BoundaryNorm(bounds, cmap.N)
cb2 = mpl.colorbar.ColorbarBase(ax2, cmap=cmap,
                                norm=norm,
                                # to use 'extend', you must
                                # specify two extra boundaries:
                                boundaries=[0] + bounds + [13],
                                extend='both',
                                ticks=bounds, # optional
                                spacing='proportional',
                                orientation='horizontal')
cb2.set_label('Discrete intervals, some other units')

# The third example illustrates the use of custom length colorbar
# extensions, used on a colorbar with discrete intervals.
cmap = mpl.colors.ListedColormap([[0., .4, 1.], [0., .8, 1.],
                                   [1., .8, 0.], [1., .4, 0.]])
cmap.set_over((1., 0., 0.))
```

```
cmap.set_under((0., 0., 1.))

bounds = [-1., -.5, 0., .5, 1.]
norm = mpl.colors.BoundaryNorm(bounds, cmap.N)
cb3 = mpl.colorbar.ColorbarBase(ax3, cmap=cmap,
                                norm=norm,
                                boundaries=[-10] + bounds + [10],
                                extend='both',
                                # Make the length of each extension
                                # the same as the length of the
                                # interior colors:
                                extendfrac='auto',
                                ticks=bounds,
                                spacing='uniform',
                                orientation='horizontal')
cb3.set_label('Custom extension lengths, some other units')

plt.show()
```

Keywords: python, matplotlib, pylab, example, codex (see [Search examples](#))

89.7 api example code: compound_path.py

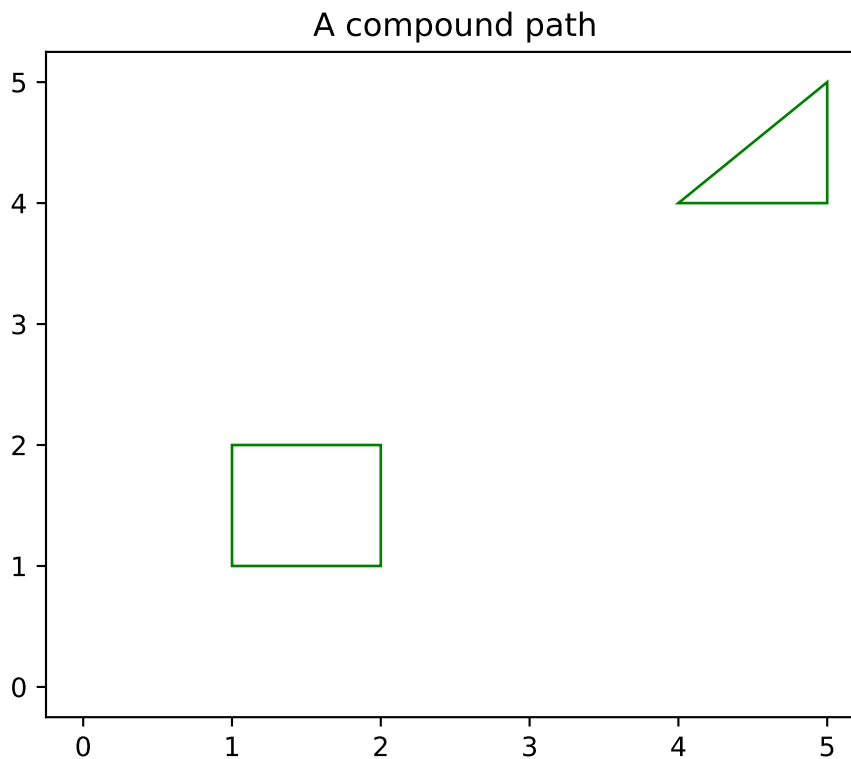

```
"""
=====
Compound path
=====

Make a compound path -- in this case two simple polygons, a rectangle
and a triangle. Use CLOSEPOLY and MOVETO for the different parts of
the compound path
"""
import numpy as np
from matplotlib.path import Path
from matplotlib.patches import PathPatch
import matplotlib.pyplot as plt

vertices = []
codes = []

codes = [Path.MOVETO] + [Path.LINETO]*3 + [Path.CLOSEPOLY]
vertices = [(1, 1), (1, 2), (2, 2), (2, 1), (0, 0)]

codes += [Path.MOVETO] + [Path.LINETO]*2 + [Path.CLOSEPOLY]
vertices += [(4, 4), (5, 5), (5, 4), (0, 0)]

vertices = np.array(vertices, float)
path = Path(vertices, codes)

pathpatch = PathPatch(path, facecolor='None', edgecolor='green')

fig, ax = plt.subplots()
ax.add_patch(pathpatch)
ax.set_title('A compound path')

ax.dataLim.update_from_data_xy(vertices)
ax.autoscale_view()

plt.show()
```

Keywords: python, matplotlib, pylab, example, codex (see [Search examples](#))

89.8 api example code: custom_projection_example.py

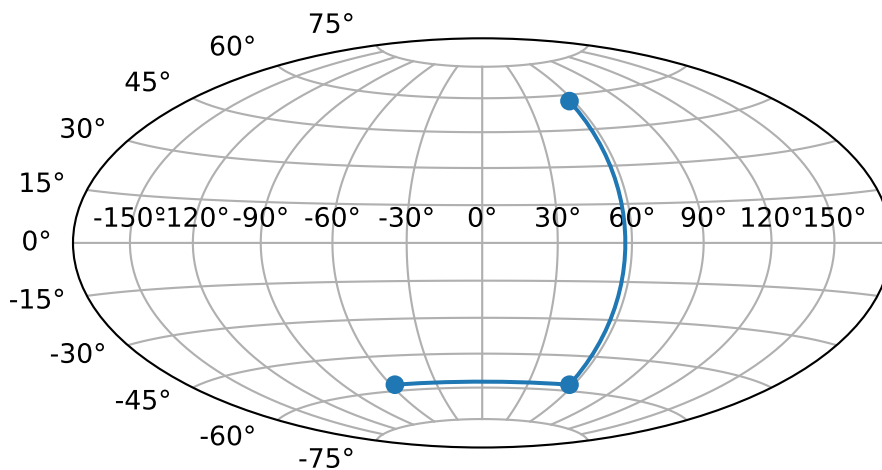

```

"""
=====
Custom projection
=====

This example showcases the Hammer projection by alleviating many features of
matplotlib.
"""

from __future__ import unicode_literals

import matplotlib
from matplotlib.axes import Axes
from matplotlib.patches import Circle
from matplotlib.path import Path
from matplotlib.ticker import NullLocator, Formatter, FixedLocator
from matplotlib.transforms import Affine2D, BboxTransformTo, Transform
from matplotlib.projections import register_projection
import matplotlib.spines as mspines
import matplotlib.axis as maxis
import numpy as np

```

```

rcParams = matplotlib.rcParams

# This example projection class is rather long, but it is designed to
# illustrate many features, not all of which will be used every time.
# It is also common to factor out a lot of these methods into common
# code used by a number of projections with similar characteristics
# (see geo.py).

class GeoAxes(Axes):
    """
    An abstract base class for geographic projections
    """
    class ThetaFormatter(Formatter):
        """
        Used to format the theta tick labels. Converts the native
        unit of radians into degrees and adds a degree symbol.
        """
        def __init__(self, round_to=1.0):
            self._round_to = round_to

        def __call__(self, x, pos=None):
            degrees = (x / np.pi) * 180.0
            degrees = np.round(degrees / self._round_to) * self._round_to
            if rcParams['text.usetex'] and not rcParams['text.latex.unicode']:
                return r"%0.0f^\circ$" % degrees
            else:
                return "%0.0f\u00b0" % degrees

    RESOLUTION = 75

    def _init_axis(self):
        self.xaxis = maxis.XAxis(self)
        self.yaxis = maxis.YAxis(self)
        # Do not register xaxis or yaxis with spines -- as done in
        # Axes._init_axis() -- until GeoAxes.xaxis.cla() works.
        # self.spines['geo'].register_axis(self.yaxis)
        self._update_transScale()

    def cla(self):
        Axes.cla(self)

        self.set_longitude_grid(30)
        self.set_latitude_grid(15)
        self.set_longitude_grid_ends(75)
        self.xaxis.set_minor_locator(NullLocator())
        self.yaxis.set_minor_locator(NullLocator())
        self.xaxis.set_ticks_position('none')
        self.yaxis.set_ticks_position('none')
        self.yaxis.set_tick_params(label10n=True)
        # Why do we need to turn on yaxis tick labels, but
        # xaxis tick labels are already on?

```



```

self.grid(rcParams['axes.grid'])

Axes.set_xlim(self, -np.pi, np.pi)
Axes.set_ylim(self, -np.pi / 2.0, np.pi / 2.0)

def _set_lim_and_transforms(self):
    # A (possibly non-linear) projection on the (already scaled) data

    # There are three important coordinate spaces going on here:
    #
    # 1. Data space: The space of the data itself
    #
    # 2. Axes space: The unit rectangle (0, 0) to (1, 1)
    #    covering the entire plot area.
    #
    # 3. Display space: The coordinates of the resulting image,
    #    often in pixels or dpi/inch.

    # This function makes heavy use of the Transform classes in
    # ``lib/matplotlib/transforms.py`` For more information, see
    # the inline documentation there.

    # The goal of the first two transformations is to get from the
    # data space (in this case longitude and latitude) to axes
    # space. It is separated into a non-affine and affine part so
    # that the non-affine part does not have to be recomputed when
    # a simple affine change to the figure has been made (such as
    # resizing the window or changing the dpi).

    # 1) The core transformation from data space into
    # rectilinear space defined in the HammerTransform class.
    self.transProjection = self._get_core_transform(self.RESOLUTION)

    # 2) The above has an output range that is not in the unit
    # rectangle, so scale and translate it so it fits correctly
    # within the axes. The peculiar calculations of xscale and
    # yscale are specific to a Aitoff-Hammer projection, so don't
    # worry about them too much.
    self.transAffine = self._get_affine_transform()

    # 3) This is the transformation from axes space to display
    # space.
    self.transAxes = BboxTransformTo(self.bbox)

    # Now put these 3 transforms together -- from data all the way
    # to display coordinates. Using the '+' operator, these
    # transforms will be applied "in order". The transforms are
    # automatically simplified, if possible, by the underlying
    # transformation framework.
    self.transData = \
        self.transProjection + \
        self.transAffine + \

```

```

    self.transAxes

    # The main data transformation is set up. Now deal with
    # gridlines and tick labels.

    # Longitude gridlines and ticklabels. The input to these
    # transforms are in display space in x and axes space in y.
    # Therefore, the input values will be in range (-xmin, 0),
    # (xmax, 1). The goal of these transforms is to go from that
    # space to display space. The tick labels will be offset 4
    # pixels from the equator.
    self._xaxis_pretransform = \
        Affine2D() \
        .scale(1.0, self._longitude_cap * 2.0) \
        .translate(0.0, -self._longitude_cap)
    self._xaxis_transform = \
        self._xaxis_pretransform + \
        self.transData
    self._xaxis_text1_transform = \
        Affine2D().scale(1.0, 0.0) + \
        self.transData + \
        Affine2D().translate(0.0, 4.0)
    self._xaxis_text2_transform = \
        Affine2D().scale(1.0, 0.0) + \
        self.transData + \
        Affine2D().translate(0.0, -4.0)

    # Now set up the transforms for the latitude ticks. The input to
    # these transforms are in axes space in x and display space in
    # y. Therefore, the input values will be in range (0, -ymin),
    # (1, ymax). The goal of these transforms is to go from that
    # space to display space. The tick labels will be offset 4
    # pixels from the edge of the axes ellipse.
    yaxis_stretch = Affine2D().scale(np.pi*2, 1).translate(-np.pi, 0)
    yaxis_space = Affine2D().scale(1.0, 1.1)
    self._yaxis_transform = \
        yaxis_stretch + \
        self.transData
    yaxis_text_base = \
        yaxis_stretch + \
        self.transProjection + \
        (yaxis_space +
         self.transAffine +
         self.transAxes)
    self._yaxis_text1_transform = \
        yaxis_text_base + \
        Affine2D().translate(-8.0, 0.0)
    self._yaxis_text2_transform = \
        yaxis_text_base + \
        Affine2D().translate(8.0, 0.0)

def _get_affine_transform(self):
    transform = self._get_core_transform(1)

```

```

xscale, _ = transform.transform_point((np.pi, 0))
_, yscale = transform.transform_point((0, np.pi / 2.0))
return Affine2D() \
    .scale(0.5 / xscale, 0.5 / yscale) \
    .translate(0.5, 0.5)

def get_xaxis_transform(self, which='grid'):
    """
    Override this method to provide a transformation for the
    x-axis tick labels.

    Returns a tuple of the form (transform, valign, halign)
    """
    if which not in ['tick1', 'tick2', 'grid']:
        msg = "'which' must be on of [ 'tick1' | 'tick2' | 'grid' ]"
        raise ValueError(msg)
    return self._xaxis_transform

def get_xaxis_text1_transform(self, pad):
    return self._xaxis_text1_transform, 'bottom', 'center'

def get_xaxis_text2_transform(self, pad):
    """
    Override this method to provide a transformation for the
    secondary x-axis tick labels.

    Returns a tuple of the form (transform, valign, halign)
    """
    return self._xaxis_text2_transform, 'top', 'center'

def get_yaxis_transform(self, which='grid'):
    """
    Override this method to provide a transformation for the
    y-axis grid and ticks.
    """
    if which not in ['tick1', 'tick2', 'grid']:
        msg = "'which' must be one of [ 'tick1' | 'tick2' | 'grid' ]"
        raise ValueError(msg)
    return self._yaxis_transform

def get_yaxis_text1_transform(self, pad):
    """
    Override this method to provide a transformation for the
    y-axis tick labels.

    Returns a tuple of the form (transform, valign, halign)
    """
    return self._yaxis_text1_transform, 'center', 'right'

def get_yaxis_text2_transform(self, pad):
    """
    Override this method to provide a transformation for the
    secondary y-axis tick labels.

```

```

    Returns a tuple of the form (transform, valign, halign)
    """
    return self._yaxis_text2_transform, 'center', 'left'

def _gen_axes_patch(self):
    """
    Override this method to define the shape that is used for the
    background of the plot. It should be a subclass of Patch.

    In this case, it is a Circle (that may be warped by the axes
    transform into an ellipse). Any data and gridlines will be
    clipped to this shape.
    """
    return Circle((0.5, 0.5), 0.5)

def _gen_axes_spines(self):
    return {'geo': mspines.Spine.circular_spine(self, (0.5, 0.5), 0.5)}

def set_yscale(self, *args, **kwargs):
    if args[0] != 'linear':
        raise NotImplementedError

# Prevent the user from applying scales to one or both of the
# axes. In this particular case, scaling the axes wouldn't make
# sense, so we don't allow it.
set_xscale = set_yscale

# Prevent the user from changing the axes limits. In our case, we
# want to display the whole sphere all the time, so we override
# set_xlim and set_ylim to ignore any input. This also applies to
# interactive panning and zooming in the GUI interfaces.
def set_xlim(self, *args, **kwargs):
    raise TypeError("It is not possible to change axes limits "
                    "for geographic projections. Please consider "
                    "using Basemap or Cartopy.")

set_ylim = set_xlim

def format_coord(self, lon, lat):
    """
    Override this method to change how the values are displayed in
    the status bar.

    In this case, we want them to be displayed in degrees N/S/E/W.
    """
    lon = lon * (180.0 / np.pi)
    lat = lat * (180.0 / np.pi)
    if lat >= 0.0:
        ns = 'N'
    else:
        ns = 'S'
    if lon >= 0.0:

```

```

        ew = 'E'
    else:
        ew = 'W'
    return '%f\u00b0%s, %f\u00b0%s' % (abs(lat), ns, abs(lon), ew)

def set_longitude_grid(self, degrees):
    """
    Set the number of degrees between each longitude grid.

    This is an example method that is specific to this projection
    class -- it provides a more convenient interface to set the
    ticking than set_xticks would.
    """
    number = (360.0 / degrees) + 1
    self.xaxis.set_major_locator(
        FixedLocator(
            np.linspace(-np.pi, np.pi, number, True)[1:-1]))
    self.xaxis.set_major_formatter(self.ThetaFormatter(degrees))

def set_latitude_grid(self, degrees):
    """
    Set the number of degrees between each longitude grid.

    This is an example method that is specific to this projection
    class -- it provides a more convenient interface than
    set_yticks would.
    """
    number = (180.0 / degrees) + 1
    self.yaxis.set_major_locator(
        FixedLocator(
            np.linspace(-np.pi / 2.0, np.pi / 2.0, number, True)[1:-1]))
    self.yaxis.set_major_formatter(self.ThetaFormatter(degrees))

def set_longitude_grid_ends(self, degrees):
    """
    Set the latitude(s) at which to stop drawing the longitude grids.

    Often, in geographic projections, you wouldn't want to draw
    longitude gridlines near the poles. This allows the user to
    specify the degree at which to stop drawing longitude grids.

    This is an example method that is specific to this projection
    class -- it provides an interface to something that has no
    analogy in the base Axes class.
    """
    self._longitude_cap = degrees * (np.pi / 180.0)
    self._xaxis_pretransform \
        .clear() \
        .scale(1.0, self._longitude_cap * 2.0) \
        .translate(0.0, -self._longitude_cap)

def get_data_ratio(self):
    """

```

```

    Return the aspect ratio of the data itself.

    This method should be overridden by any Axes that have a
    fixed data ratio.
    """
    return 1.0

# Interactive panning and zooming is not supported with this projection,
# so we override all of the following methods to disable it.
def can_zoom(self):
    """
    Return *True* if this axes supports the zoom box button functionality.
    This axes object does not support interactive zoom box.
    """
    return False

def can_pan(self):
    """
    Return *True* if this axes supports the pan/zoom button functionality.
    This axes object does not support interactive pan/zoom.
    """
    return False

def start_pan(self, x, y, button):
    pass

def end_pan(self):
    pass

def drag_pan(self, button, key, x, y):
    pass

class HammerAxes(GeoAxes):
    """
    A custom class for the Aitoff-Hammer projection, an equal-area map
    projection.

    https://en.wikipedia.org/wiki/Hammer_projection
    """

    # The projection must specify a name. This will be used by the
    # user to select the projection,
    # i.e. ``subplot(111, projection='custom_hammer')``.
    name = 'custom_hammer'

    class HammerTransform(Transform):
        """
        The base Hammer transform.
        """
        input_dims = 2
        output_dims = 2
        is_separable = False

```

```

def __init__(self, resolution):
    """
    Create a new Hammer transform. Resolution is the number of steps
    to interpolate between each input line segment to approximate its
    path in curved Hammer space.
    """
    Transform.__init__(self)
    self._resolution = resolution

def transform_non_affine(self, ll):
    longitude = ll[:, 0:1]
    latitude = ll[:, 1:2]

    # Pre-compute some values
    half_long = longitude / 2.0
    cos_latitude = np.cos(latitude)
    sqrt2 = np.sqrt(2.0)

    alpha = np.sqrt(1.0 + cos_latitude * np.cos(half_long))
    x = (2.0 * sqrt2) * (cos_latitude * np.sin(half_long)) / alpha
    y = (sqrt2 * np.sin(latitude)) / alpha
    return np.concatenate((x, y), 1)
transform_non_affine.__doc__ = Transform.transform_non_affine.__doc__

def transform_path_non_affine(self, path):
    # vertices = path.vertices
    ipath = path.interpolated(self._resolution)
    return Path(self.transform(ipath.vertices), ipath.codes)
transform_path_non_affine.__doc__ = \
    Transform.transform_path_non_affine.__doc__

def inverted(self):
    return HammerAxes.InvertedHammerTransform(self._resolution)
inverted.__doc__ = Transform.inverted.__doc__

class InvertedHammerTransform(Transform):
    input_dims = 2
    output_dims = 2
    is_separable = False

    def __init__(self, resolution):
        Transform.__init__(self)
        self._resolution = resolution

    def transform_non_affine(self, xy):
        x = xy[:, 0:1]
        y = xy[:, 1:2]

        quarter_x = 0.25 * x
        half_y = 0.5 * y
        z = np.sqrt(1.0 - quarter_x*quarter_x - half_y*half_y)
        longitude = 2 * np.arctan((z*x) / (2.0 * (2.0*z*z - 1.0)))

```

```
        latitude = np.arcsin(y*z)
        return np.concatenate((longitude, latitude), 1)
transform_non_affine.__doc__ = Transform.transform_non_affine.__doc__

def inverted(self):
    return HammerAxes.HammerTransform(self._resolution)
inverted.__doc__ = Transform.inverted.__doc__

def __init__(self, *args, **kwargs):
    self._longitude_cap = np.pi / 2.0
    GeoAxes.__init__(self, *args, **kwargs)
    self.set_aspect(0.5, adjustable='box', anchor='C')
    self.cla()

def _get_core_transform(self, resolution):
    return self.HammerTransform(resolution)

# Now register the projection with matplotlib so the user can select
# it.
register_projection(HammerAxes)

if __name__ == '__main__':
    import matplotlib.pyplot as plt
    # Now make a simple example using the custom projection.
    plt.subplot(111, projection="custom_hammer")
    p = plt.plot([-1, 1, 1], [-1, -1, 1], "o-")
    plt.grid(True)

    plt.show()
```

Keywords: python, matplotlib, pylab, example, codex (see [Search examples](#))

89.9 api example code: custom_scale_example.py

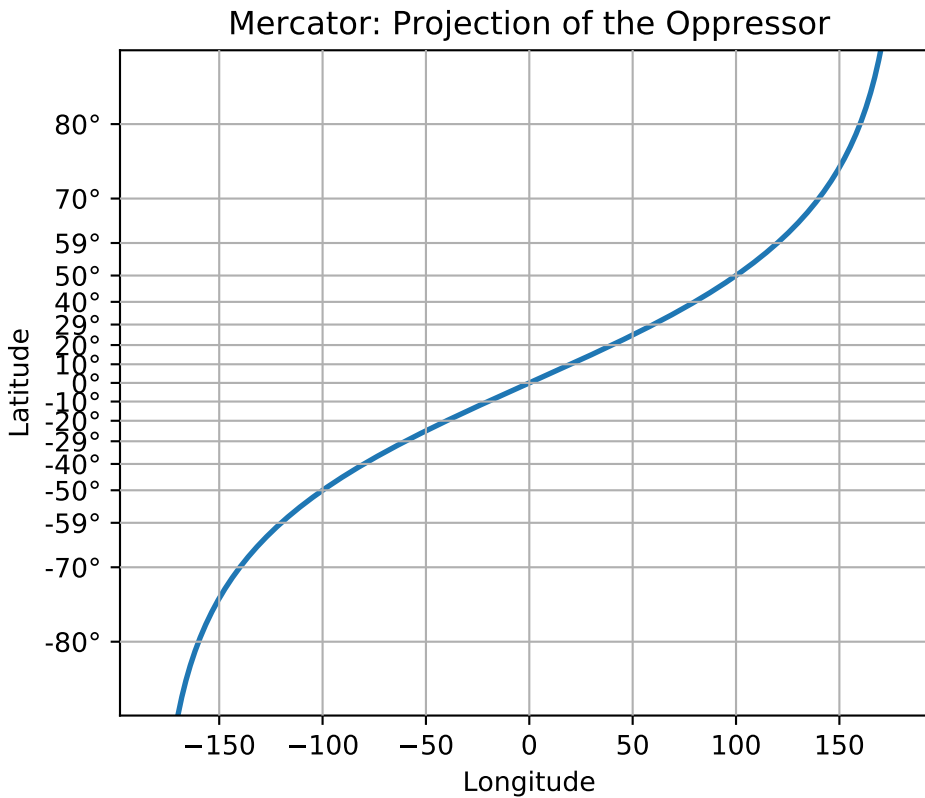

```

"""
=====
Custom scale
=====

This example showcases how to create a custom scale, by implementing the
scaling use for latitude data in a Mercator Projection.
"""

from __future__ import unicode_literals

import numpy as np
from numpy import ma
from matplotlib import scale as mscale
from matplotlib import transforms as mtransforms
from matplotlib.ticker import Formatter, FixedLocator
from matplotlib import rcParams

# BUG: this example fails with any other setting of axisbelow
rcParams['axes.axisbelow'] = False

```

```

class MercatorLatitudeScale(mscale.ScaleBase):
    """
    Scales data in range  $-\pi/2$  to  $\pi/2$  (-90 to 90 degrees) using
    the system used to scale latitudes in a Mercator projection.

    The scale function:
     $\ln(\tan(y) + \sec(y))$ 

    The inverse scale function:
     $\text{atan}(\sinh(y))$ 

    Since the Mercator scale tends to infinity at  $\pm 90$  degrees,
    there is user-defined threshold, above and below which nothing
    will be plotted. This defaults to  $\pm 85$  degrees.

    source:
    http://en.wikipedia.org/wiki/Mercator\_projection
    """

    # The scale class must have a member ``name`` that defines the
    # string used to select the scale. For example,
    # ``gca().set_yscale("mercator")`` would be used to select this
    # scale.
    name = 'mercator'

    def __init__(self, axis, **kwargs):
        """
        Any keyword arguments passed to ``set_xscale`` and
        ``set_yscale`` will be passed along to the scale's
        constructor.

        thresh: The degree above which to crop the data.
        """
        mscale.ScaleBase.__init__(self)
        thresh = kwargs.pop("thresh", np.radians(85))
        if thresh >= np.pi / 2.0:
            raise ValueError("thresh must be less than pi/2")
        self.thresh = thresh

    def get_transform(self):
        """
        Override this method to return a new instance that does the
        actual transformation of the data.

        The MercatorLatitudeTransform class is defined below as a
        nested class of this one.
        """
        return self.MercatorLatitudeTransform(self.thresh)

    def set_default_locators_and_formatters(self, axis):
        """

```

Override to set up the locators and formatters to use with the scale. This is only required if the scale requires custom locators and formatters. Writing custom locators and formatters is rather outside the scope of this example, but there are many helpful examples in ```ticker.py```.

In our case, the Mercator example uses a fixed locator from -90 to 90 degrees and a custom formatter class to put convert the radians to degrees and put a degree symbol after the value::

```

"""
class DegreeFormatter(Formatter):
    def __call__(self, x, pos=None):
        # \u00b0 : degree symbol
        return "%d\u00b0" % (np.degrees(x))

axis.set_major_locator(FixedLocator(
    np.radians(np.arange(-90, 90, 10))))
axis.set_major_formatter(DegreeFormatter())
axis.set_minor_formatter(DegreeFormatter())

def limit_range_for_scale(self, vmin, vmax, minpos):
    """
    Override to limit the bounds of the axis to the domain of the
    transform. In the case of Mercator, the bounds should be
    limited to the threshold that was passed in. Unlike the
    autoscaling provided by the tick locators, this range limiting
    will always be adhered to, whether the axis range is set
    manually, determined automatically or changed through panning
    and zooming.
    """
    return max(vmin, -self.thresh), min(vmax, self.thresh)

class MercatorLatitudeTransform(mtransforms.Transform):
    # There are two value members that must be defined.
    # ``input_dims`` and ``output_dims`` specify number of input
    # dimensions and output dimensions to the transformation.
    # These are used by the transformation framework to do some
    # error checking and prevent incompatible transformations from
    # being connected together. When defining transforms for a
    # scale, which are, by definition, separable and have only one
    # dimension, these members should always be set to 1.
    input_dims = 1
    output_dims = 1
    is_separable = True

    def __init__(self, thresh):
        mtransforms.Transform.__init__(self)
        self.thresh = thresh

    def transform_non_affine(self, a):
        """
        This transform takes an Nx1 ``numpy`` array and returns a

```

```

    transformed copy. Since the range of the Mercator scale
    is limited by the user-specified threshold, the input
    array must be masked to contain only valid values.
    ``matplotlib`` will handle masked arrays and remove the
    out-of-range data from the plot. Importantly, the
    ``transform`` method must return an array that is the
    same shape as the input array, since these values need to
    remain synchronized with values in the other dimension.
    """
    masked = ma.masked_where((a < -self.thresh) | (a > self.thresh), a)
    if masked.mask.any():
        return ma.log(np.abs(ma.tan(masked) + 1.0 / ma.cos(masked)))
    else:
        return np.log(np.abs(np.tan(a) + 1.0 / np.cos(a)))

    def inverted(self):
        """
        Override this method so matplotlib knows how to get the
        inverse transform for this transform.
        """
        return MercatorLatitudeScale.InvertedMercatorLatitudeTransform(
            self.thresh)

class InvertedMercatorLatitudeTransform(mtransforms.Transform):
    input_dims = 1
    output_dims = 1
    is_separable = True

    def __init__(self, thresh):
        mtransforms.Transform.__init__(self)
        self.thresh = thresh

    def transform_non_affine(self, a):
        return np.arctan(np.sinh(a))

    def inverted(self):
        return MercatorLatitudeScale.MercatorLatitudeTransform(self.thresh)

# Now that the Scale class has been defined, it must be registered so
# that ``matplotlib`` can find it.
mscale.register_scale(MercatorLatitudeScale)

if __name__ == '__main__':
    import matplotlib.pyplot as plt

    t = np.arange(-180.0, 180.0, 0.1)
    s = np.radians(t)/2.

    plt.plot(t, s, '-', lw=2)
    plt.gca().set_yscale('mercator')

    plt.xlabel('Longitude')

```

```
plt.ylabel('Latitude')
plt.title('Mercator: Projection of the Oppressor')
plt.grid(True)

plt.show()
```

Keywords: python, matplotlib, pylab, example, codex (see *Search examples*)

89.10 api example code: date_demo.py



```
"""
=====
Date tick labels
=====

Show how to make date plots in matplotlib using date tick locators and
formatters. See major_minor_demo1.py for more information on
controlling major and minor ticks

All matplotlib date plotting is done by converting date instances into
days since the 0001-01-01 UTC. The conversion, tick locating and
formatting is done behind the scenes so this is most transparent to
```

```

you. The dates module provides several converter functions date2num
and num2date

"""
import datetime
import numpy as np
import matplotlib.pyplot as plt
import matplotlib.dates as mdates
import matplotlib.cbook as cbook

years = mdates.YearLocator() # every year
months = mdates.MonthLocator() # every month
yearsFmt = mdates.DateFormatter('%Y')

# load a numpy record array from yahoo csv data with fields date,
# open, close, volume, adj_close from the mpl-data/example directory.
# The record array stores python datetime.date as an object array in
# the date column
datafile = cbook.get_sample_data('goog.npy')
try:
    # Python3 cannot load python2 .npy files with datetime(object) arrays
    # unless the encoding is set to bytes. However this option was
    # not added until numpy 1.10 so this example will only work with
    # python 2 or with numpy 1.10 and later.
    r = np.load(datafile, encoding='bytes').view(np.recarray)
except TypeError:
    r = np.load(datafile).view(np.recarray)

fig, ax = plt.subplots()
ax.plot(r.date, r.adj_close)

# format the ticks
ax.xaxis.set_major_locator(years)
ax.xaxis.set_major_formatter(yearsFmt)
ax.xaxis.set_minor_locator(months)

datemin = datetime.date(r.date.min().year, 1, 1)
datemax = datetime.date(r.date.max().year + 1, 1, 1)
ax.set_xlim(datemin, datemax)

# format the coords message box
def price(x):
    return '$%1.2f' % x
ax.format_xdata = mdates.DateFormatter('%Y-%m-%d')
ax.format_ydata = price
ax.grid(True)

# rotates and right aligns the x labels, and moves the bottom of the
# axes up to make room for them
fig.autofmt_xdate()

```

```
plt.show()
```

Keywords: python, matplotlib, pylab, example, codex (see [Search examples](#))

89.11 api example code: date_index_formatter.py

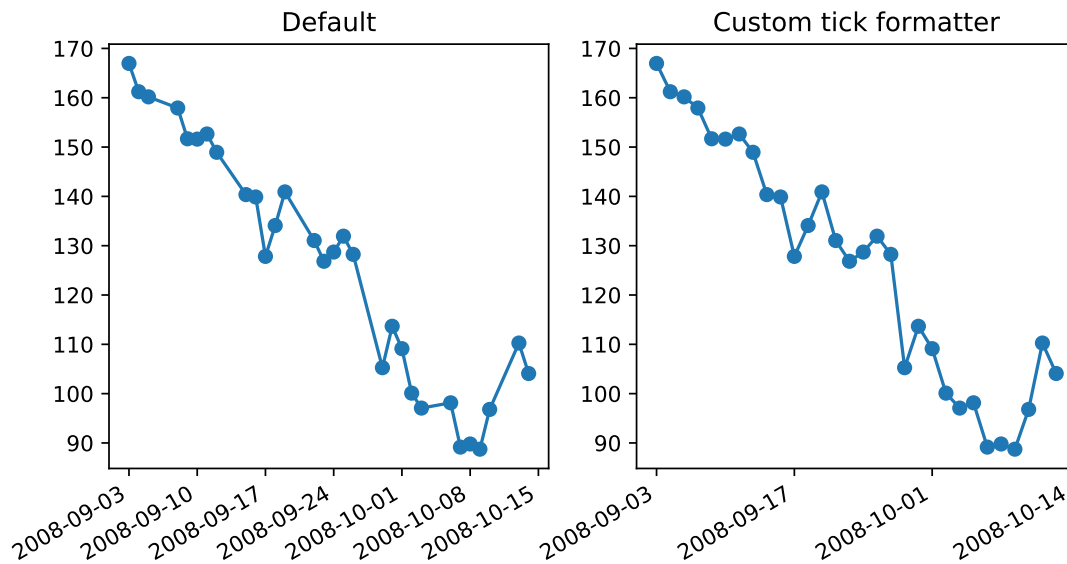

```
"""
=====
Custom tick formatter for time series
=====

When plotting time series, e.g., financial time series, one often wants
to leave out days on which there is no data, i.e. weekends. The example
below shows how to use an 'index formatter' to achieve the desired plot
"""

from __future__ import print_function
import numpy as np
import matplotlib.pyplot as plt
import matplotlib.mlab as mlab
import matplotlib.cbook as cbook
import matplotlib.ticker as ticker

datafile = cbook.get_sample_data('aapl.csv', asfileobj=False)
print('loading %s' % datafile)
r = mlab.csv2rec(datafile)

r.sort()
r = r[-30:] # get the last 30 days
```

```
# first we'll do it the default way, with gaps on weekends
fig, axes = plt.subplots(ncols=2, figsize=(8, 4))
ax = axes[0]
ax.plot(r.date, r.adj_close, 'o-')
ax.set_title("Default")
fig.autofmt_xdate()

# next we'll write a custom formatter
N = len(r)
ind = np.arange(N) # the evenly spaced plot indices

def format_date(x, pos=None):
    thisind = np.clip(int(x + 0.5), 0, N - 1)
    return r.date[thisind].strftime('%Y-%m-%d')

ax = axes[1]
ax.plot(ind, r.adj_close, 'o-')
ax.xaxis.set_major_formatter(ticker.FuncFormatter(format_date))
ax.set_title("Custom tick formatter")
fig.autofmt_xdate()

plt.show()
```

Keywords: python, matplotlib, pylab, example, codex (see [Search examples](#))

89.12 api example code: demo_affine_image.py

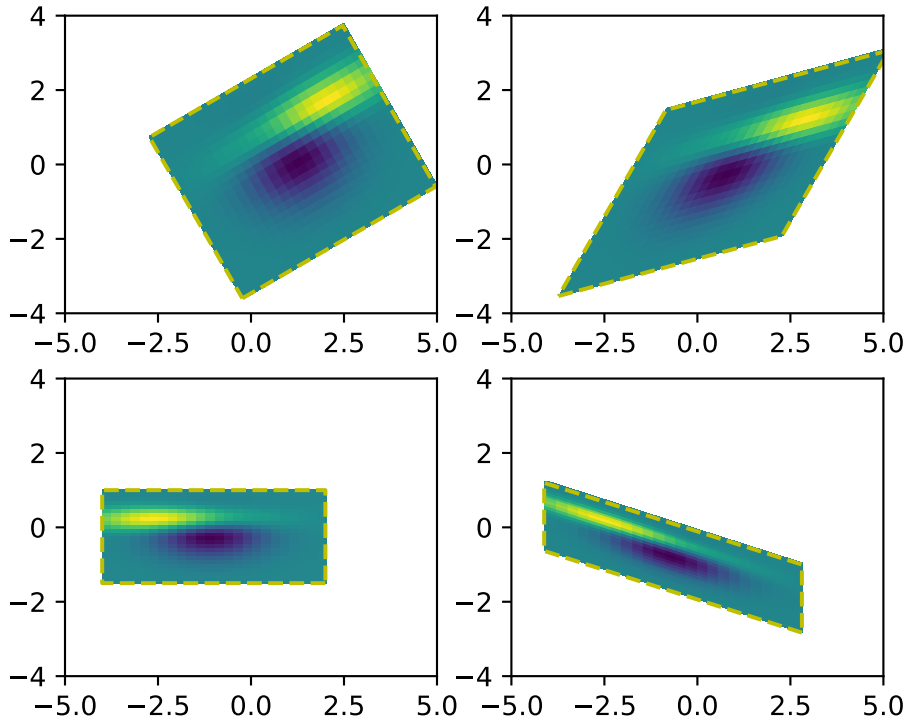

```

"""
=====
Affine transform of an image
=====

For the backends that support draw_image with optional affine
transform (e.g., agg, ps backend), the image of the output should
have its boundary match the dashed yellow rectangle.
"""

import numpy as np
import matplotlib.mlab as mlab
import matplotlib.pyplot as plt
import matplotlib.transforms as mtransforms

def get_image():
    delta = 0.25
    x = y = np.arange(-3.0, 3.0, delta)
    X, Y = np.meshgrid(x, y)
    Z1 = mlab.bivariate_normal(X, Y, 1.0, 1.0, 0.0, 0.0)
    Z2 = mlab.bivariate_normal(X, Y, 1.5, 0.5, 1, 1)

```

```
Z = Z2 - Z1 # difference of Gaussians
return Z

def do_plot(ax, Z, transform):
    im = ax.imshow(Z, interpolation='none',
                  origin='lower',
                  extent=[-2, 4, -3, 2], clip_on=True)

    trans_data = transform + ax.transData
    im.set_transform(trans_data)

    # display intended extent of the image
    x1, x2, y1, y2 = im.get_extent()
    ax.plot([x1, x2, x2, x1, x1], [y1, y1, y2, y2, y1], "y--",
            transform=trans_data)
    ax.set_xlim(-5, 5)
    ax.set_ylim(-4, 4)

# prepare image and figure
fig, ((ax1, ax2), (ax3, ax4)) = plt.subplots(2, 2)
Z = get_image()

# image rotation
do_plot(ax1, Z, mtransforms.Affine2D().rotate_deg(30))

# image skew
do_plot(ax2, Z, mtransforms.Affine2D().skew_deg(30, 15))

# scale and reflection
do_plot(ax3, Z, mtransforms.Affine2D().scale(-1, .5))

# everything and a translation
do_plot(ax4, Z, mtransforms.Affine2D().
        rotate_deg(30).skew_deg(30, 15).scale(-1, .5).translate(.5, -1))

plt.show()
```

Keywords: python, matplotlib, pylab, example, codex (see [Search examples](#))

89.13 api example code: donut_demo.py

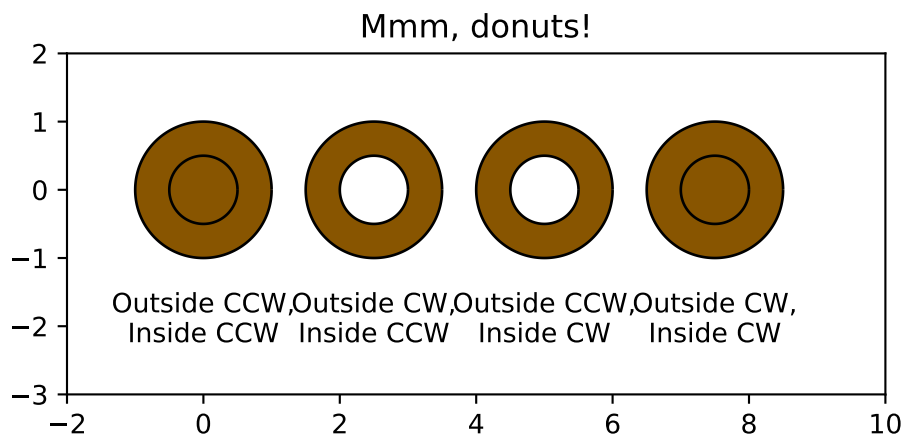

```

"""
=====
Mmh Donuts!!!
=====

This example draws donuts (miam!) using Path and Patches.
"""

import numpy as np
import matplotlib.path as mpath
import matplotlib.patches as mpatches
import matplotlib.pyplot as plt

def wise(v):
    if v == 1:
        return "CCW"
    else:
        return "CW"

def make_circle(r):

```

```

t = np.arange(0, np.pi * 2.0, 0.01)
t = t.reshape((len(t), 1))
x = r * np.cos(t)
y = r * np.sin(t)
return np.hstack((x, y))

Path = mpath.Path

fig, ax = plt.subplots()

inside_vertices = make_circle(0.5)
outside_vertices = make_circle(1.0)
codes = np.ones(
    len(inside_vertices), dtype=mpath.Path.code_type) * mpath.Path.LINETO
codes[0] = mpath.Path.MOVETO

for i, (inside, outside) in enumerate(((1, 1), (1, -1), (-1, 1), (-1, -1))):
    # Concatenate the inside and outside subpaths together, changing their
    # order as needed
    vertices = np.concatenate((outside_vertices[:, :outside],
                               inside_vertices[:, :inside]))

    # Shift the path
    vertices[:, 0] += i * 2.5
    # The codes will be all "LINETO" commands, except for "MOVETO"s at the
    # beginning of each subpath
    all_codes = np.concatenate((codes, codes))
    # Create the Path object
    path = mpath.Path(vertices, all_codes)
    # Add plot it
    patch = mpatches.PathPatch(path, facecolor='#885500', edgecolor='black')
    ax.add_patch(patch)

    ax.annotate("Outside %s,\nInside %s" % (wise(outside), wise(inside)),
               (i * 2.5, -1.5), va="top", ha="center")

ax.set_xlim(-2, 10)
ax.set_ylim(-3, 2)
ax.set_title('Mmm, donuts!')
ax.set_aspect(1.0)
plt.show()

```

Keywords: python, matplotlib, pylab, example, codex (see [Search examples](#))

89.14 api example code: engineering_formatter.py

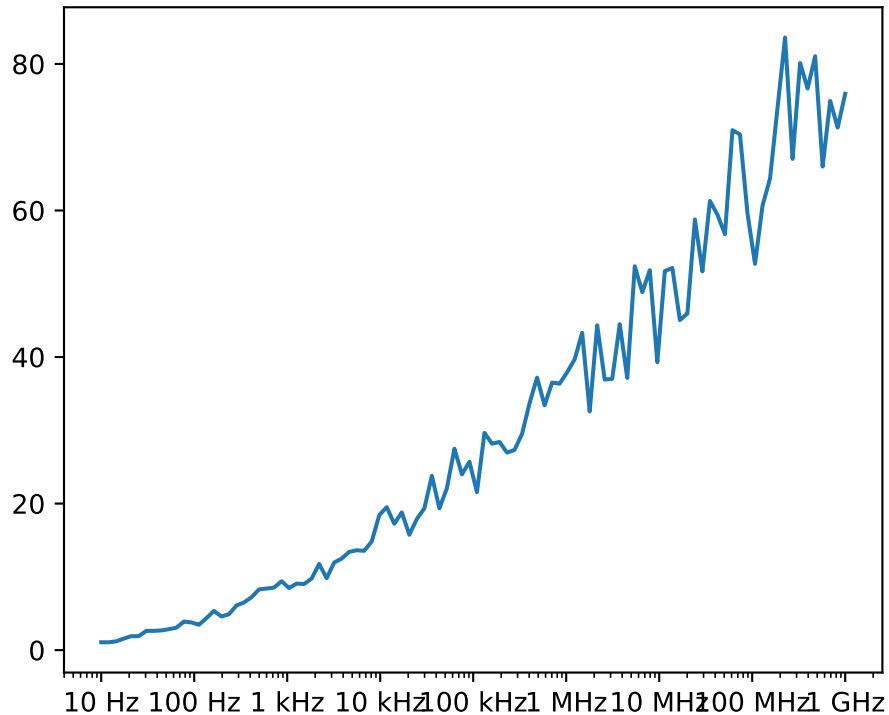

```

"""
=====
Labeling ticks using engineering notation
=====

Demo to show use of the engineering Formatter.
"""

import matplotlib.pyplot as plt
import numpy as np

from matplotlib.ticker import EngFormatter

prng = np.random.RandomState(123)

fig, ax = plt.subplots()
ax.set_xscale('log')
formatter = EngFormatter(unit='Hz')
ax.xaxis.set_major_formatter(formatter)

xs = np.logspace(1, 9, 100)
ys = (0.8 + 0.4 * prng.uniform(size=100)) * np.log10(xs)**2

```

```
ax.plot(xs, ys)
```

```
plt.show()
```

Keywords: python, matplotlib, pylab, example, codex (see [Search examples](#))

89.15 api example code: filled_step.py

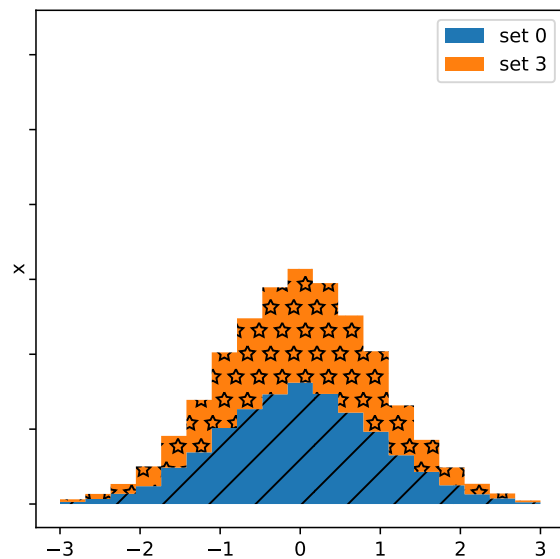
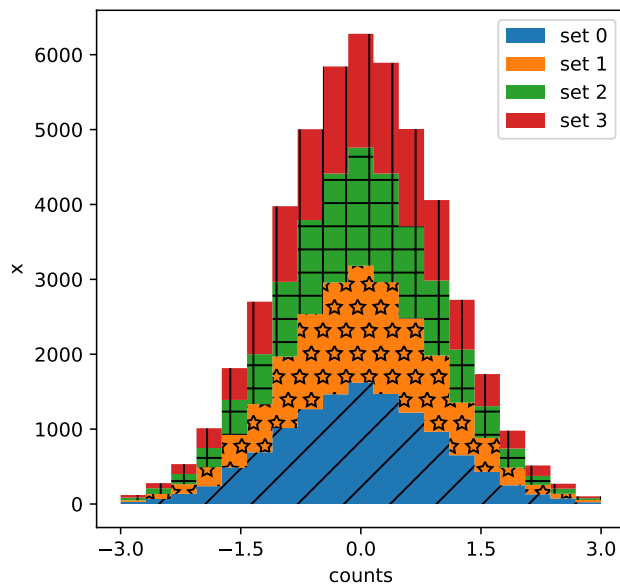
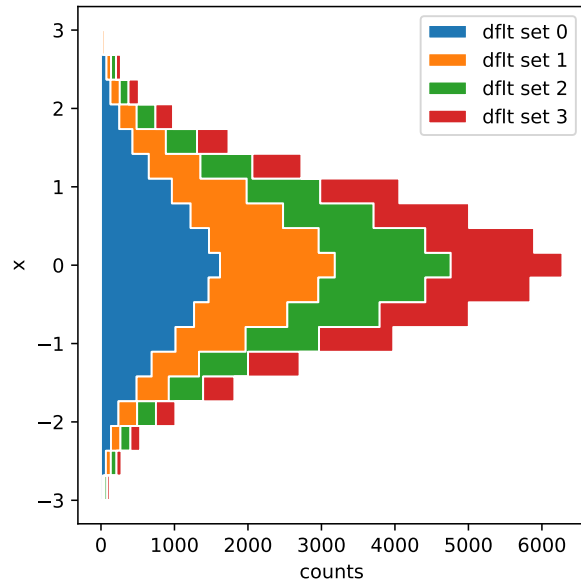
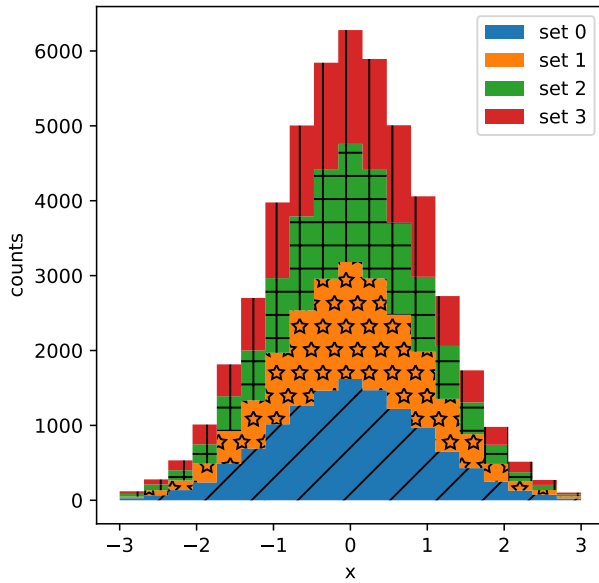

```
""""
=====
```

Hatch-filled histograms

=====

This example showcases the hatching capabilities of matplotlib by plotting various histograms.

"""

```
import itertools
from collections import OrderedDict
from functools import partial
```

```
import numpy as np
import matplotlib.pyplot as plt
import matplotlib.ticker as mticker
from cycler import cycler
from six.moves import zip
```

```
def filled_hist(ax, edges, values, bottoms=None, orientation='v',
               **kwargs):
    """
    Draw a histogram as a stepped patch.

    Extra kwargs are passed through to `fill_between`

    Parameters
    -----
    ax : Axes
        The axes to plot to

    edges : array
        A length n+1 array giving the left edges of each bin and the
        right edge of the last bin.

    values : array
        A length n array of bin counts or values

    bottoms : scalar or array, optional
        A length n array of the bottom of the bars. If None, zero is used.

    orientation : {'v', 'h'}
        Orientation of the histogram. 'v' (default) has
        the bars increasing in the positive y-direction.

    Returns
    -----
    ret : PolyCollection
        Artist added to the Axes
    """
    print(orientation)
    if orientation not in set('hv'):
        raise ValueError("orientation must be in {'h', 'v'} "
                          "not {o}".format(o=orientation))
```

```

kwargs.setdefault('step', 'post')
edges = np.asarray(edges)
values = np.asarray(values)
if len(edges) - 1 != len(values):
    raise ValueError('Must provide one more bin edge than value not: '
                    'len(edges): {lb} len(values): {lv}'.format(
                        lb=len(edges), lv=len(values)))

if bottoms is None:
    bottoms = np.zeros_like(values)
if np.isscalar(bottoms):
    bottoms = np.ones_like(values) * bottoms

values = np.r_[values, values[-1]]
bottoms = np.r_[bottoms, bottoms[-1]]
if orientation == 'h':
    return ax.fill_betweenx(edges, values, bottoms,
                            **kwargs)
elif orientation == 'v':
    return ax.fill_between(edges, values, bottoms,
                            **kwargs)
else:
    raise AssertionError("you should never be here")

def stack_hist(ax, stacked_data, sty_cycle, bottoms=None,
              hist_func=None, labels=None,
              plot_func=None, plot_kwargs=None):
    """
    ax : axes.Axes
        The axes to add artists too

    stacked_data : array or Mapping
        A (N, M) shaped array. The first dimension will be iterated over to
        compute histograms row-wise

    sty_cycle : Cyclor or operable of dict
        Style to apply to each set

    bottoms : array, optional
        The initial positions of the bottoms, defaults to 0

    hist_func : callable, optional
        Must have signature `bin_vals, bin_edges = f(data)`.
        `bin_edges` expected to be one longer than `bin_vals`

    labels : list of str, optional
        The label for each set.

        If not given and stacked data is an array defaults to 'default set {n}'

        If stacked_data is a mapping, and labels is None, default to the keys

```

(which may come out in a random order).

If `stacked_data` is a mapping and `labels` is given then only the columns listed by be plotted.

`plot_func` : callable, optional

Function to call to draw the histogram must have signature:

```
ret = plot_func(ax, edges, top, bottoms=bottoms,
                label=label, **kwargs)
```

`plot_kwargs` : dict, optional

Any extra `kwargs` to pass through to the plotting function. This will be the same for all calls to the plotting function and will over-ride the values in `cycle`.

Returns

`arts` : dict

Dictionary of artists keyed on their labels

"""

deal with default binning function

if `hist_func` **is** `None`:

`hist_func` = `np.histogram`

deal with default plotting function

if `plot_func` **is** `None`:

`plot_func` = `filled_hist`

deal with default

if `plot_kwargs` **is** `None`:

`plot_kwargs` = {}

print(`plot_kwargs`)

try:

`l_keys` = `stacked_data.keys()`

`label_data` = `True`

if `labels` **is** `None`:

`labels` = `l_keys`

except `AttributeError`:

`label_data` = `False`

if `labels` **is** `None`:

`labels` = `itertools.repeat(None)`

if `label_data`:

`loop_iter` = `enumerate((stacked_data[lab], lab, s) for lab, s in zip(labels, sty_cycle))`

else:

`loop_iter` = `enumerate(zip(stacked_data, labels, sty_cycle))`

`arts` = {}

for `j`, (`data`, `label`, `sty`) **in** `loop_iter`:

if `label` **is** `None`:

```

        label = 'dflt set {n}'.format(n=j)
        label = sty.pop('label', label)
        vals, edges = hist_func(data)
        if bottoms is None:
            bottoms = np.zeros_like(vals)
        top = bottoms + vals
        print(sty)
        sty.update(plot_kwargs)
        print(sty)
        ret = plot_func(ax, edges, top, bottoms=bottoms,
                        label=label, **sty)

        bottoms = top
        arts[label] = ret
    ax.legend(fontsize=10)
    return arts

# set up histogram function to fixed bins
edges = np.linspace(-3, 3, 20, endpoint=True)
hist_func = partial(np.histogram, bins=edges)

# set up style cycles
color_cycle = cycler(facecolor=plt.rcParams['axes.prop_cycle'][:4])
label_cycle = cycler('label', ['set {n}'.format(n=n) for n in range(4)])
hatch_cycle = cycler('hatch', ['/', '*', '+', '|'])

# make some synthetic data
np.random.seed(0)
stack_data = np.random.randn(4, 12250)
dict_data = OrderedDict(zip((c['label'] for c in label_cycle), stack_data))

# work with plain arrays
fig, (ax1, ax2) = plt.subplots(1, 2, figsize=(9, 4.5), tight_layout=True)
arts = stack_hist(ax1, stack_data, color_cycle + label_cycle + hatch_cycle,
                  hist_func=hist_func)

arts = stack_hist(ax2, stack_data, color_cycle,
                  hist_func=hist_func,
                  plot_kwargs=dict(edgecolor='w', orientation='h'))
ax1.set_ylabel('counts')
ax1.set_xlabel('x')
ax2.set_xlabel('counts')
ax2.set_ylabel('x')

# work with labeled data
fig, (ax1, ax2) = plt.subplots(1, 2, figsize=(9, 4.5),
                               tight_layout=True, sharey=True)

arts = stack_hist(ax1, dict_data, color_cycle + hatch_cycle,
                  hist_func=hist_func)

arts = stack_hist(ax2, dict_data, color_cycle + hatch_cycle,

```

```

        hist_func=hist_func, labels=['set 0', 'set 3'])
ax1.xaxis.set_major_locator(mticker.MaxNLocator(5))
ax1.set_xlabel('counts')
ax1.set_ylabel('x')
ax2.set_ylabel('x')

plt.show()

```

Keywords: python, matplotlib, pylab, example, codex (see [Search examples](#))

89.16 api example code: font_family_rc.py

[source code]

```

"""
=====
Configuring the font family
=====

You can explicitly set which font family is picked up for a given font
style (e.g., 'serif', 'sans-serif', or 'monospace').

In the example below, we only allow one font family (Tahoma) for the
san-serif font style. You the default family with the font.family rc
param, e.g.,::

    rcParams['font.family'] = 'sans-serif'

and for the font.family you set a list of font styles to try to find
in order::

    rcParams['font.sans-serif'] = ['Tahoma', 'DejaVu Sans',
                                   'Lucida Grande', 'Verdana']

"""

# -*- noplots -*-

from matplotlib import rcParams
rcParams['font.family'] = 'sans-serif'
rcParams['font.sans-serif'] = ['Tahoma']
import matplotlib.pyplot as plt

fig, ax = plt.subplots()
ax.plot([1, 2, 3], label='test')

ax.legend()
plt.show()

```

Keywords: python, matplotlib, pylab, example, codex (see [Search examples](#))

89.17 api example code: font_file.py

[source code]

```
# -*- noplots -*-
"""
=====
Using a ttf font file in matplotlib
=====

Although it is usually not a good idea to explicitly point to a single
ttf file for a font instance, you can do so using the
font_manager.FontProperties fname argument (for a more flexible
solution, see the font_family_rc.py and fonts_demo.py examples).
"""
import sys
import os
import matplotlib.font_manager as fm

import matplotlib.pyplot as plt

fig, ax = plt.subplots()
ax.plot([1, 2, 3])

if sys.platform == 'win32':
    fpath = 'C:\\Windows\\Fonts\\Tahoma.ttf'
elif sys.platform.startswith('linux'):
    basedir = '/usr/share/fonts/truetype'
    fonts = ['freefont/FreeSansBoldOblique.ttf',
             'ttf-liberation/LiberationSans-BoldItalic.ttf',
             'msttcorefonts/Comic_Sans_MS.ttf']
    for fpath in fonts:
        if os.path.exists(os.path.join(basedir, fpath)):
            break
else:
    fpath = '/Library/Fonts/Tahoma.ttf'

if os.path.exists(fpath):
    prop = fm.FontProperties(fname=fpath)
    fname = os.path.split(fpath)[1]
    ax.set_title('this is a special font: %s' % fname, fontproperties=prop)
else:
    ax.set_title('Demo fails--cannot find a demo font')
ax.set_xlabel('This is the default font')

plt.show()
```

Keywords: python, matplotlib, pylab, example, codex (see [Search examples](#))

89.18 api example code: histogram_path_demo.py

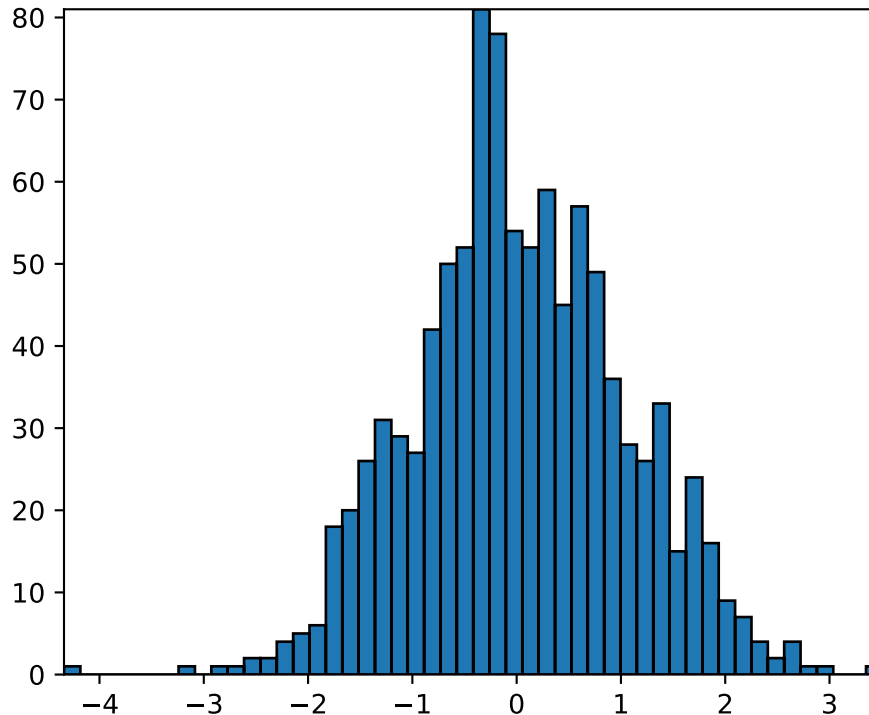

```

"""
=====
Building histograms using Rectangles and PolyCollections
=====

This example shows how to use a path patch to draw a bunch of
rectangles. The technique of using lots of Rectangle instances, or
the faster method of using PolyCollections, were implemented before we
had proper paths with moveto/lineto, closepoly etc in mpl. Now that
we have them, we can draw collections of regularly shaped objects with
homogeneous properties more efficiently with a PathCollection. This
example makes a histogram -- its more work to set up the vertex arrays
at the outset, but it should be much faster for large numbers of
objects
"""

import numpy as np
import matplotlib.pyplot as plt
import matplotlib.patches as patches
import matplotlib.path as path

fig, ax = plt.subplots()

```

```
# histogram our data with numpy
data = np.random.randn(1000)
n, bins = np.histogram(data, 50)

# get the corners of the rectangles for the histogram
left = np.array(bins[:-1])
right = np.array(bins[1:])
bottom = np.zeros(len(left))
top = bottom + n

# we need a (numrects x numsides x 2) numpy array for the path helper
# function to build a compound path
XY = np.array([[left, left, right, right], [bottom, top, top, bottom]]).T

# get the Path object
barpath = path.Path.make_compound_path_from_polys(XY)

# make a patch out of it
patch = patches.PathPatch(barpath)
ax.add_patch(patch)

# update the view limits
ax.set_xlim(left[0], right[-1])
ax.set_ylim(bottom.min(), top.max())

plt.show()
```

Keywords: python, matplotlib, pylab, example, codex (see [Search examples](#))

89.19 api example code: image_zcoord.py

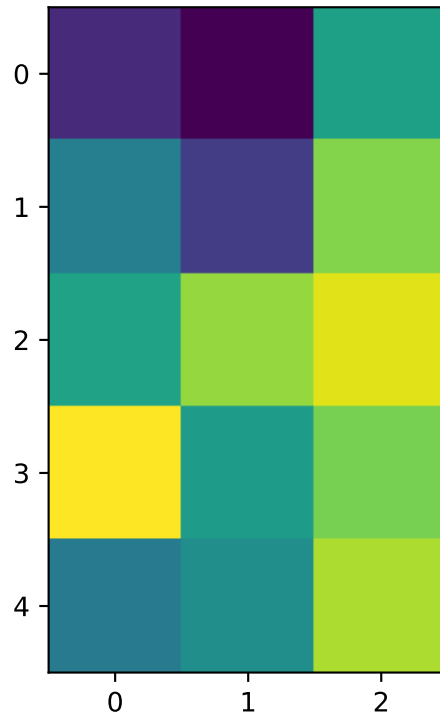

```

"""
=====
Modifying the coordinate formatter
=====

Show how to modify the coordinate formatter to report the image "z"
value of the nearest pixel given x and y
"""
import numpy as np
import matplotlib.pyplot as plt

X = 10*np.random.rand(5, 3)

fig, ax = plt.subplots()
ax.imshow(X, interpolation='nearest')

numrows, numcols = X.shape

def format_coord(x, y):
    col = int(x + 0.5)
    row = int(y + 0.5)

```

```

if col >= 0 and col < numcols and row >= 0 and row < numRows:
    z = X[row, col]
    return 'x=%1.4f, y=%1.4f, z=%1.4f' % (x, y, z)
else:
    return 'x=%1.4f, y=%1.4f' % (x, y)

```

```

ax.format_coord = format_coord
plt.show()

```

Keywords: python, matplotlib, pylab, example, codex (see [Search examples](#))

89.20 api example code: joinstyle.py

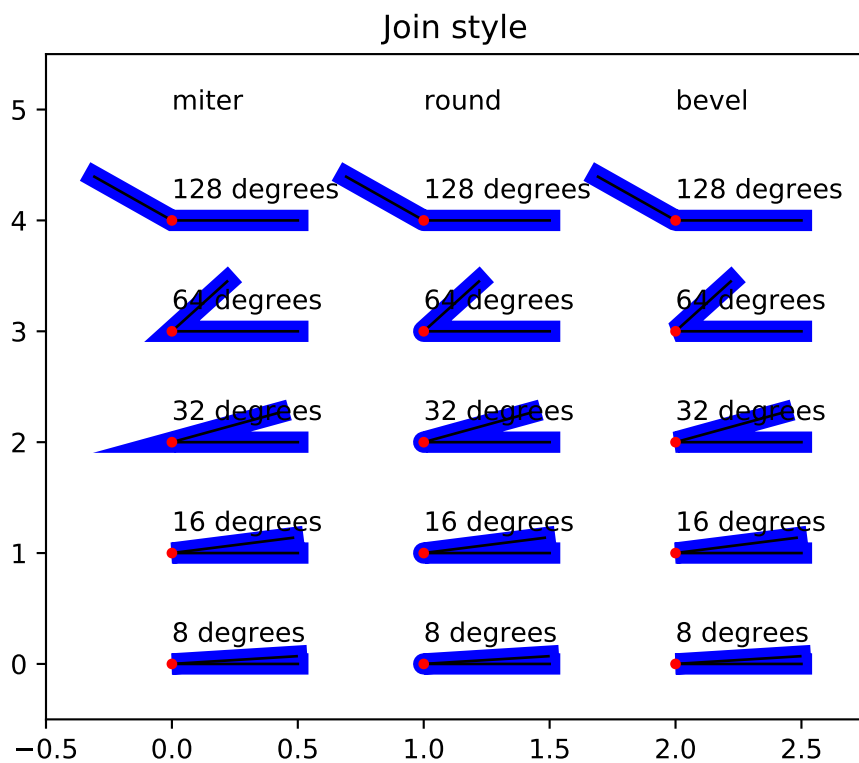

```

"""
=====
Join styles
=====

Illustrate the three different join styles
"""

import numpy as np

```



```
import matplotlib.pyplot as plt

def plot_angle(ax, x, y, angle, style):
    phi = np.radians(angle)
    xx = [x + .5, x, x + .5*np.cos(phi)]
    yy = [y, y, y + .5*np.sin(phi)]
    ax.plot(xx, yy, lw=8, color='blue', solid_joinstyle=style)
    ax.plot(xx[1:], yy[1:], lw=1, color='black')
    ax.plot(xx[1::-1], yy[1::-1], lw=1, color='black')
    ax.plot(xx[1:2], yy[1:2], 'o', color='red', markersize=3)
    ax.text(x, y + .2, '%.0f degrees' % angle)

fig, ax = plt.subplots()
ax.set_title('Join style')

for x, style in enumerate(('miter', 'round', 'bevel')):
    ax.text(x, 5, style)
    for i in range(5):
        plot_angle(ax, x, i, pow(2.0, 3 + i), style)

ax.set_xlim(-.5, 2.75)
ax.set_ylim(-.5, 5.5)
plt.show()
```

Keywords: python, matplotlib, pylab, example, codex (see [Search examples](#))

89.21 api example code: legend_demo.py

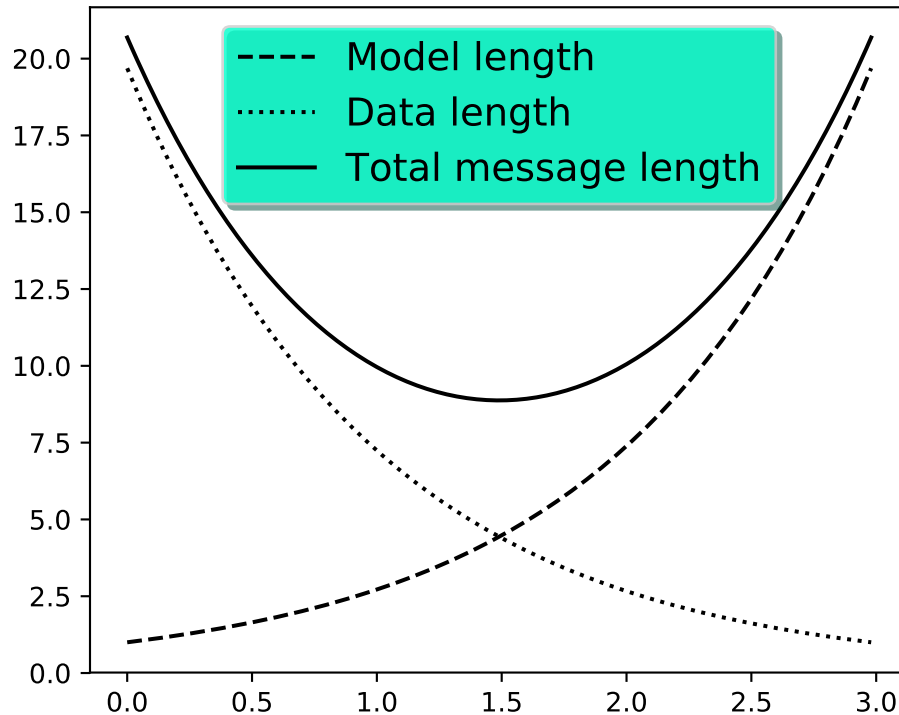

```

"""
=====
Legend using pre-defined labels
=====

Notice how the legend labels are defined with the plots!
"""

import numpy as np
import matplotlib.pyplot as plt

# Make some fake data.
a = b = np.arange(0, 3, .02)
c = np.exp(a)
d = c[::-1]

# Create plots with pre-defined labels.
fig, ax = plt.subplots()
ax.plot(a, c, 'k--', label='Model length')
ax.plot(a, d, 'k:', label='Data length')
ax.plot(a, c + d, 'k', label='Total message length')

```

```

legend = ax.legend(loc='upper center', shadow=True, fontsize='x-large')

# Put a nicer background color on the legend.
legend.get_frame().set_facecolor('#00FFCC')

plt.show()

```

Keywords: python, matplotlib, pylab, example, codex (see *Search examples*)

89.22 api example code: line_with_text.py

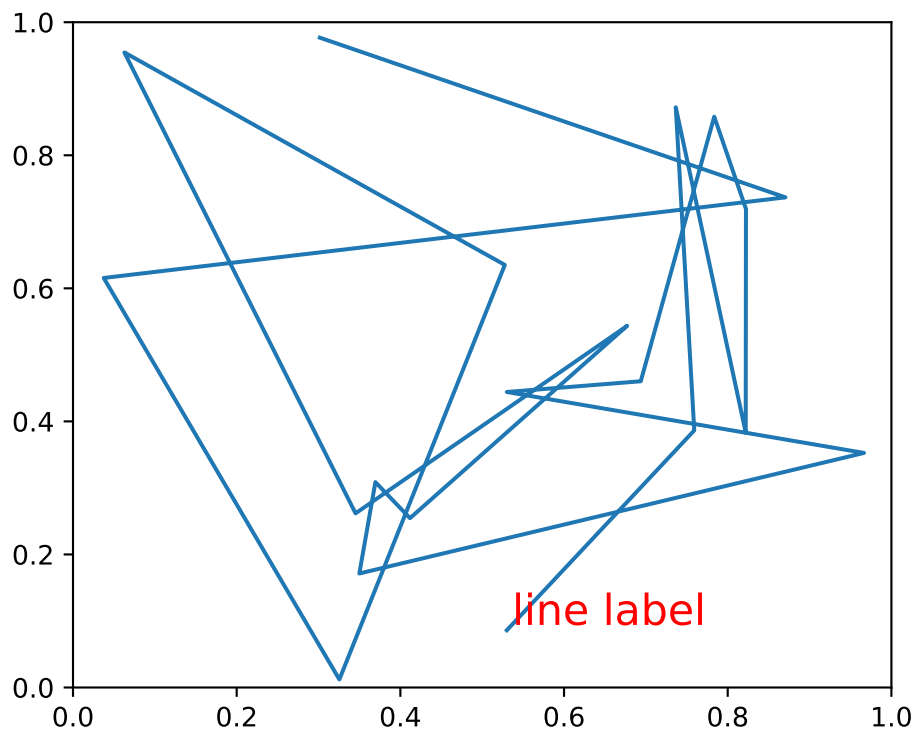

```

"""
=====
Artist within an artist
=====

Show how to override basic methods so an artist can contain another
artist. In this case, the line contains a Text instance to label it.
"""
import numpy as np
import matplotlib.pyplot as plt

```

```
import matplotlib.lines as lines
import matplotlib.transforms as mtransforms
import matplotlib.text as mtext

class MyLine(lines.Line2D):
    def __init__(self, *args, **kwargs):
        # we'll update the position when the line data is set
        self.text = mtext.Text(0, 0, '')
        lines.Line2D.__init__(self, *args, **kwargs)

        # we can't access the label attr until *after* the line is
        # initied
        self.text.set_text(self.get_label())

    def set_figure(self, figure):
        self.text.set_figure(figure)
        lines.Line2D.set_figure(self, figure)

    def set_axes(self, axes):
        self.text.set_axes(axes)
        lines.Line2D.set_axes(self, axes)

    def set_transform(self, transform):
        # 2 pixel offset
        texttrans = transform + mtransforms.Affine2D().translate(2, 2)
        self.text.set_transform(texttrans)
        lines.Line2D.set_transform(self, transform)

    def set_data(self, x, y):
        if len(x):
            self.text.set_position((x[-1], y[-1]))

        lines.Line2D.set_data(self, x, y)

    def draw(self, renderer):
        # draw my label at the end of the line with 2 pixel offset
        lines.Line2D.draw(self, renderer)
        self.text.draw(renderer)

fig, ax = plt.subplots()
x, y = np.random.rand(2, 20)
line = MyLine(x, y, mfc='red', ms=12, label='line label')
#line.text.set_text('line label')
line.text.set_color('red')
line.text.set_fontsize(16)

ax.add_line(line)

plt.show()
```

Keywords: python, matplotlib, pylab, example, codex (see *Search examples*)

89.23 api example code: logo2.py

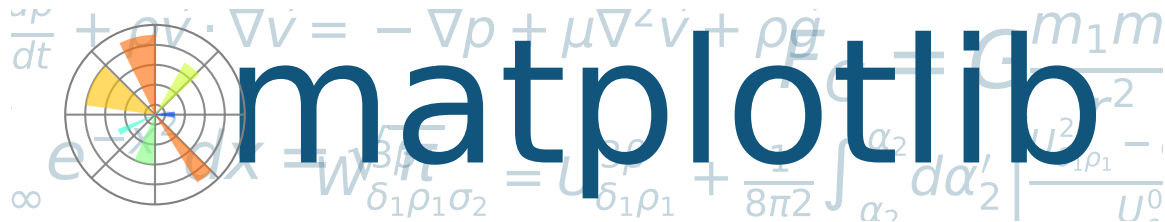

```

"""
=====
matplotlib
=====

Thanks to Tony Yu <tsyu80@gmail.com> for the logo design
"""

import numpy as np
import matplotlib as mpl
import matplotlib.pyplot as plt
import matplotlib.cm as cm

mpl.rcParams['xtick.labelsize'] = 10
mpl.rcParams['ytick.labelsize'] = 12
mpl.rcParams['axes.edgecolor'] = 'gray'

axalpha = 0.05
figcolor = 'white'
dpi = 80
fig = plt.figure(figsize=(6, 1.1), dpi=dpi)
fig.figurePatch.set_edgecolor(figcolor)
fig.figurePatch.set_facecolor(figcolor)

def add_math_background():
    ax = fig.add_axes([0., 0., 1., 1.])

    text = []
    text.append(
        (r"$W^{\{3\beta\}}_{\{\delta_1 \rho_1 \sigma_2\}} = $",
         r"$U^{\{3\beta\}}_{\{\delta_1 \rho_1\}} + \frac{1}{8 \pi^2}$",
         r"$\int^{\{\alpha_2\}}_{\{\alpha_2\}} d \alpha^{\prime_2}$",
         r"$\left[ \frac{U^{\{2\beta\}}_{\{\delta_1 \rho_1\}} - $",
         r"$\alpha^{\prime_2} U^{\{1\beta\}}_{\{\rho_1 \sigma_2\}} $",
         r"$\right]_{U^{\{0\beta\}}_{\{\rho_1 \sigma_2\}}}$", (0.7, 0.2), 20))
    text.append((r"$\frac{d\rho}{dt} + \rho \vec{v} \cdot \nabla \vec{v}$",
                 r"$= -\nabla p + \mu \nabla^2 \vec{v} + \rho \vec{g}$",
                 (0.35, 0.9), 20))

```

```

text.append((r"$\int_{-\infty}^{\infty} e^{-x^2}dx=\sqrt{\pi}$",
             (0.15, 0.3), 25))
text.append((r"$F_G = G\frac{m_1m_2}{r^2}$",
             (0.85, 0.7), 30))
for eq, (x, y), size in text:
    ax.text(x, y, eq, ha='center', va='center', color="#11557c",
            alpha=0.25, transform=ax.transAxes, fontsize=size)
ax.set_axis_off()
return ax

def add_matplotlib_text(ax):
    ax.text(0.95, 0.5, 'matplotlib', color='#11557c', fontsize=65,
           ha='right', va='center', alpha=1.0, transform=ax.transAxes)

def add_polar_bar():
    ax = fig.add_axes([0.025, 0.075, 0.2, 0.85], projection='polar')

    ax.axesPatch.set_alpha(axalpha)
    ax.set_axisbelow(True)
    N = 7
    arc = 2. * np.pi
    theta = np.arange(0.0, arc, arc/N)
    radii = 10 * np.array([0.2, 0.6, 0.8, 0.7, 0.4, 0.5, 0.8])
    width = np.pi / 4 * np.array([0.4, 0.4, 0.6, 0.8, 0.2, 0.5, 0.3])
    bars = ax.bar(theta, radii, width=width, bottom=0.0)
    for r, bar in zip(radii, bars):
        bar.set_facecolor(cm.jet(r/10.))
        bar.set_alpha(0.6)

    for label in ax.get_xticklabels() + ax.get_yticklabels():
        label.set_visible(False)

    for line in ax.get_ygridlines() + ax.get_xgridlines():
        line.set_lw(0.8)
        line.set_alpha(0.9)
        line.set_ls('-')
        line.set_color('0.5')

    ax.set_yticks(np.arange(1, 9, 2))
    ax.set_rmax(9)

if __name__ == '__main__':
    main_axes = add_math_background()
    add_polar_bar()
    add_matplotlib_text(main_axes)
    plt.show()

```

Keywords: python, matplotlib, pylab, example, codex (see [Search examples](#))

89.24 api example code: mathtext_asarray.py

```
"""
=====
A mathtext image as numpy array
=====

This example shows how to make images from LaTeX strings.
"""

import matplotlib.mathtext as mathtext
import matplotlib.pyplot as plt
import matplotlib
matplotlib.rc('image', origin='upper')

parser = mathtext.MathTextParser("Bitmap")
parser.to_png('test2.png',
             r'$\left[\left\lfloor\frac{5}{\frac{\left(3\right)}{4}}\right\right]$ ',
             r'y\right)\right]$', color='green', fontsize=14, dpi=100)

rgba1, depth1 = parser.to_rgba(
    r'IQ: $\sigma_i=15$', color='blue', fontsize=20, dpi=200)
rgba2, depth2 = parser.to_rgba(
    r'some other string', color='red', fontsize=20, dpi=200)
```

```

fig = plt.figure()
fig.figimage(rgba1.astype(float)/255., 100, 100)
fig.figimage(rgba2.astype(float)/255., 100, 300)

plt.show()

```

Keywords: python, matplotlib, pylab, example, codex (see [Search examples](#))

89.25 api example code: patch_collection.py

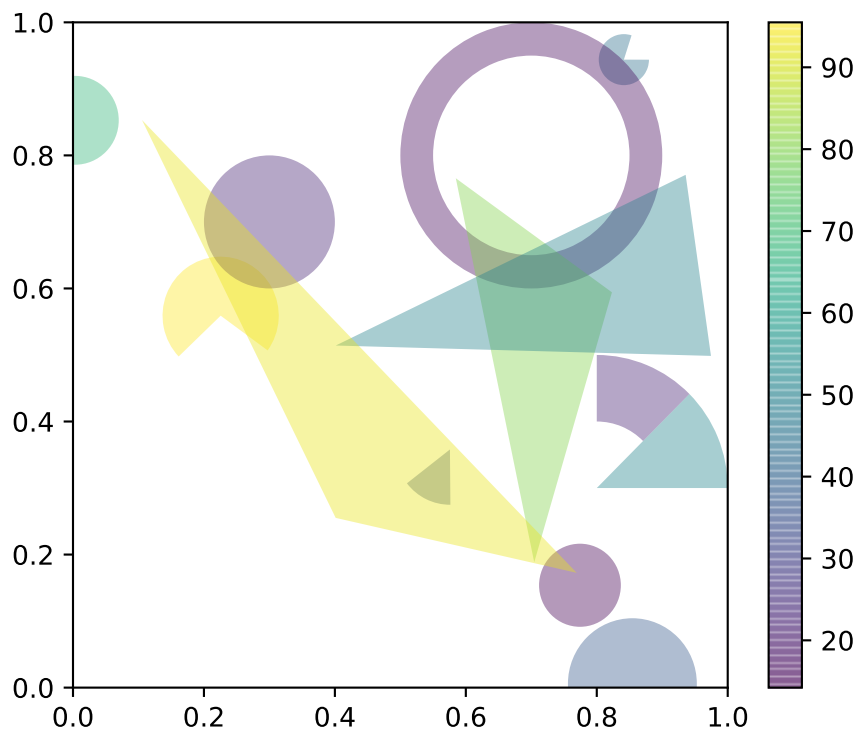

```

"""
=====
Circles, Wedges and Polygons
=====
"""

import numpy as np
import matplotlib
from matplotlib.patches import Circle, Wedge, Polygon
from matplotlib.collections import PatchCollection
import matplotlib.pyplot as plt

```



```

fig, ax = plt.subplots()

resolution = 50 # the number of vertices
N = 3
x = np.random.rand(N)
y = np.random.rand(N)
radii = 0.1*np.random.rand(N)
patches = []
for x1, y1, r in zip(x, y, radii):
    circle = Circle((x1, y1), r)
    patches.append(circle)

x = np.random.rand(N)
y = np.random.rand(N)
radii = 0.1*np.random.rand(N)
theta1 = 360.0*np.random.rand(N)
theta2 = 360.0*np.random.rand(N)
for x1, y1, r, t1, t2 in zip(x, y, radii, theta1, theta2):
    wedge = Wedge((x1, y1), r, t1, t2)
    patches.append(wedge)

# Some limiting conditions on Wedge
patches += [
    Wedge((.3, .7), .1, 0, 360), # Full circle
    Wedge((.7, .8), .2, 0, 360, width=0.05), # Full ring
    Wedge((.8, .3), .2, 0, 45), # Full sector
    Wedge((.8, .3), .2, 45, 90, width=0.10), # Ring sector
]

for i in range(N):
    polygon = Polygon(np.random.rand(N, 2), True)
    patches.append(polygon)

colors = 100*np.random.rand(len(patches))
p = PatchCollection(patches, alpha=0.4)
p.set_array(np.array(colors))
ax.add_collection(p)
fig.colorbar(p, ax=ax)

plt.show()

```

Keywords: python, matplotlib, pylab, example, codex (see [Search examples](#))

89.26 api example code: power_norm_demo.py

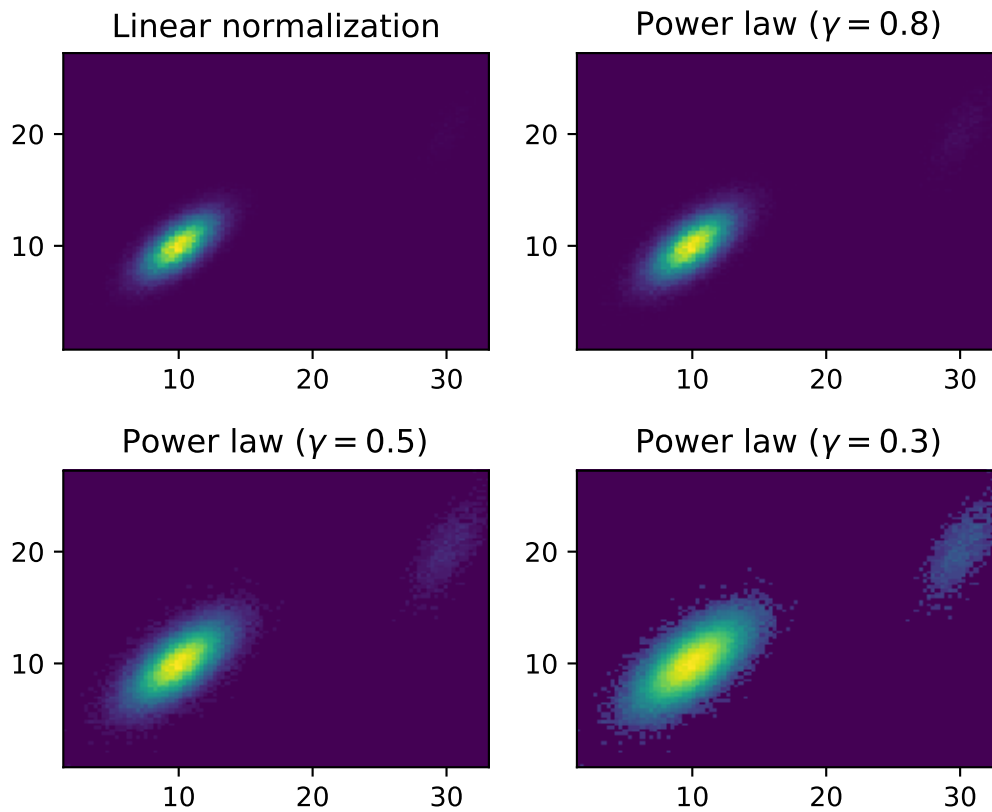

```

"""
=====
Exploring normalizations
=====

Let's explore various normalization on a multivariate normal distribution.

"""

from matplotlib import pyplot as plt
import matplotlib.colors as mcolors
import numpy as np
from numpy.random import multivariate_normal

data = np.vstack([
    multivariate_normal([10, 10], [[3, 2], [2, 3]], size=1000000),
    multivariate_normal([30, 20], [[2, 3], [1, 3]], size=1000)
])

gammas = [0.8, 0.5, 0.3]

fig, axes = plt.subplots(nrows=2, ncols=2)

```

```

axes[0, 0].set_title('Linear normalization')
axes[0, 0].hist2d(data[:, 0], data[:, 1], bins=100)

for ax, gamma in zip(axes.flat[1:], gammas):
    ax.set_title('Power law $(\gamma=%1.1f)$' % gamma)
    ax.hist2d(data[:, 0], data[:, 1],
              bins=100, norm=mcolors.PowerNorm(gamma))

fig.tight_layout()

plt.show()

```

Keywords: python, matplotlib, pylab, example, codex (see [Search examples](#))

89.27 api example code: quad_bezier.py

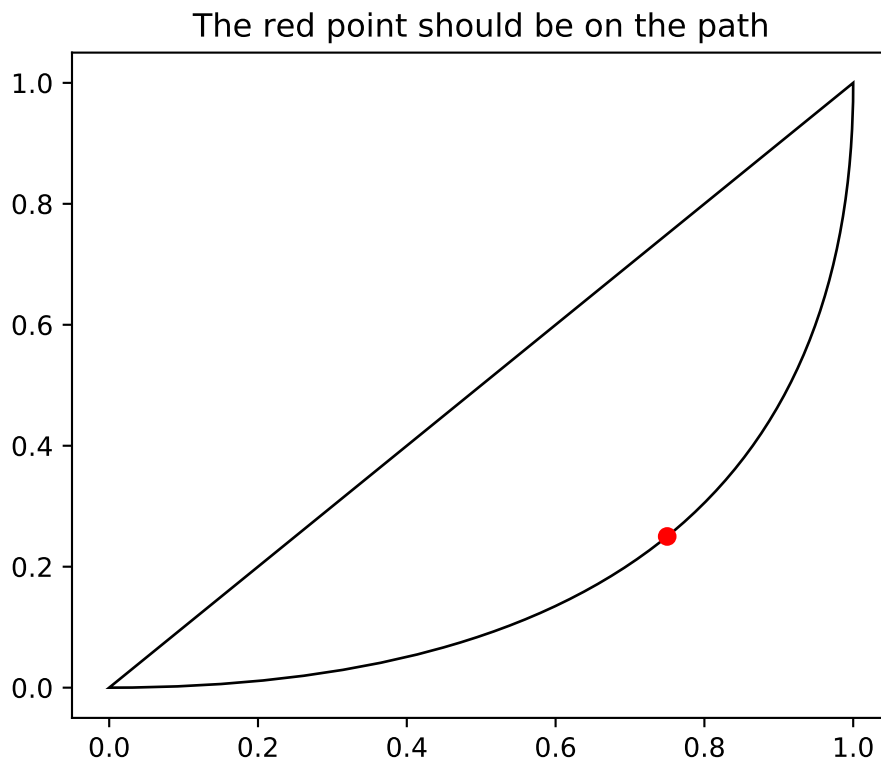

```

"""
=====
Bezier Curve
=====

```

This example showcases the PathPatch object to create a Bezier polycurve path patch.

```
"""  
  
import matplotlib.path as mpath  
import matplotlib.patches as mpatches  
import matplotlib.pyplot as plt  
  
Path = mpath.Path  
  
fig, ax = plt.subplots()  
pp1 = mpatches.PathPatch(  
    Path([(0, 0), (1, 0), (1, 1), (0, 0)],  
        [Path.MOVETO, Path.CURVE3, Path.CURVE3, Path.CLOSEPOLY]),  
    fc="none", transform=ax.transData)  
  
ax.add_patch(pp1)  
ax.plot([0.75], [0.25], "ro")  
ax.set_title('The red point should be on the path')  
  
plt.show()
```

Keywords: python, matplotlib, pylab, example, codex (see [Search examples](#))

89.28 api example code: radar_chart.py

5-Factor Solution Profiles Across Four Scenarios

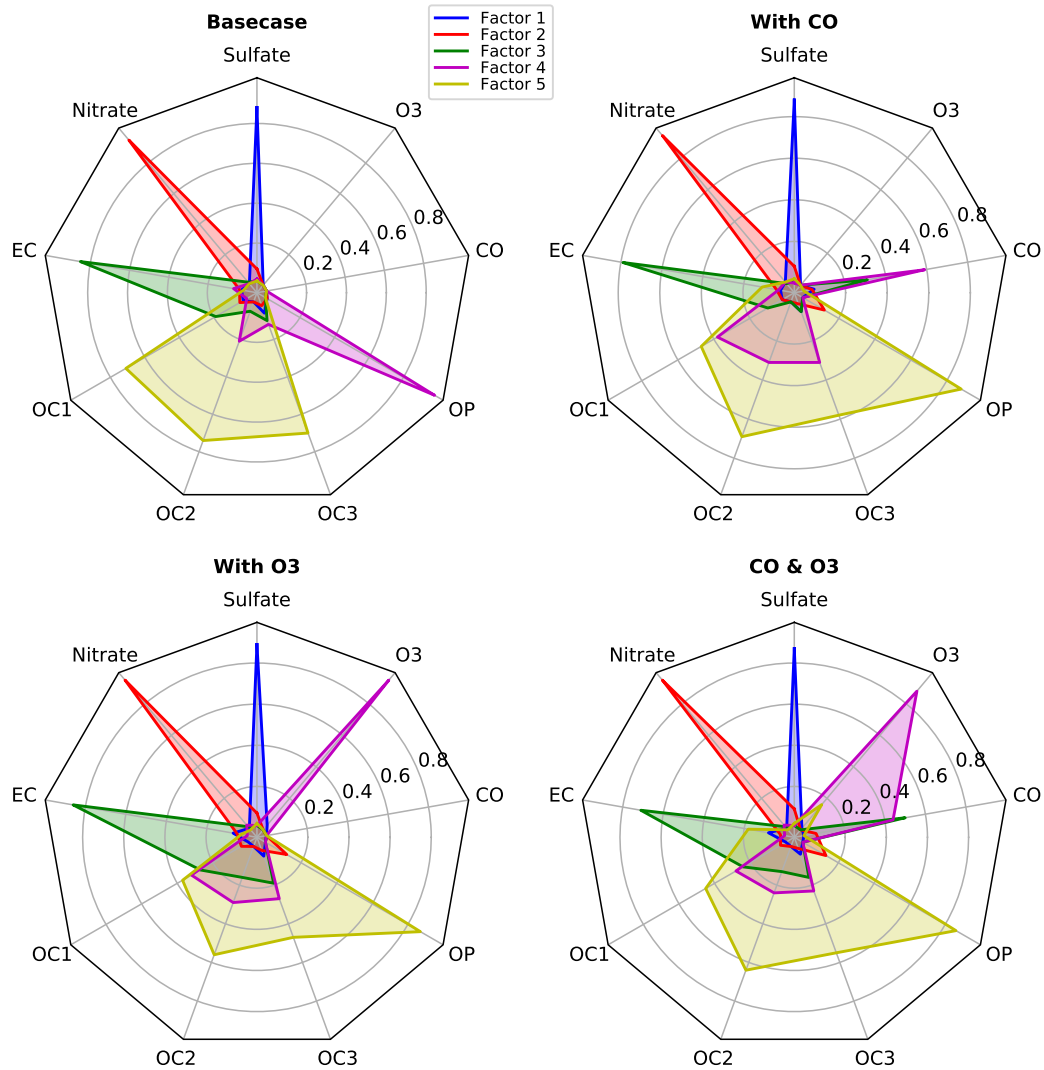

```

"""
=====
Radar chart (aka spider or star chart)
=====

This example creates a radar chart, also known as a spider or star chart [1]_.

Although this example allows a frame of either 'circle' or 'polygon', polygon
frames don't have proper gridlines (the lines are circles instead of polygons).
It's possible to get a polygon grid by setting GRIDLINE_INTERPOLATION_STEPS in

```

matplotlib.axis to the desired number of vertices, but the orientation of the polygon is not aligned with the radial axes.

```

.. [1] http://en.wikipedia.org/wiki/Radar\_chart
"""
import numpy as np

import matplotlib.pyplot as plt
from matplotlib.path import Path
from matplotlib.spines import Spine
from matplotlib.projections.polar import PolarAxes
from matplotlib.projections import register_projection

def radar_factory(num_vars, frame='circle'):
    """Create a radar chart with `num_vars` axes.

    This function creates a RadarAxes projection and registers it.

    Parameters
    -----
    num_vars : int
        Number of variables for radar chart.
    frame : {'circle' | 'polygon'}
        Shape of frame surrounding axes.

    """
    # calculate evenly-spaced axis angles
    theta = np.linspace(0, 2*np.pi, num_vars, endpoint=False)
    # rotate theta such that the first axis is at the top
    theta += np.pi/2

    def draw_poly_patch(self):
        verts = unit_poly_verts(theta)
        return plt.Polygon(verts, closed=True, edgecolor='k')

    def draw_circle_patch(self):
        # unit circle centered on (0.5, 0.5)
        return plt.Circle((0.5, 0.5), 0.5)

    patch_dict = {'polygon': draw_poly_patch, 'circle': draw_circle_patch}
    if frame not in patch_dict:
        raise ValueError('unknown value for `frame`: %s' % frame)

    class RadarAxes(PolarAxes):

        name = 'radar'
        # use 1 line segment to connect specified points
        RESOLUTION = 1
        # define draw_frame method
        draw_patch = patch_dict[frame]

        def fill(self, *args, **kwargs):

```

```

        """Override fill so that line is closed by default"""
        closed = kwargs.pop('closed', True)
        return super(RadarAxes, self).fill(closed=closed, *args, **kwargs)

    def plot(self, *args, **kwargs):
        """Override plot so that line is closed by default"""
        lines = super(RadarAxes, self).plot(*args, **kwargs)
        for line in lines:
            self._close_line(line)

    def _close_line(self, line):
        x, y = line.get_data()
        # FIXME: markers at x[0], y[0] get doubled-up
        if x[0] != x[-1]:
            x = np.concatenate((x, [x[0]]))
            y = np.concatenate((y, [y[0]]))
            line.set_data(x, y)

    def set_varlabels(self, labels):
        self.set_thetagrids(np.degrees(theta), labels)

    def _gen_axes_patch(self):
        return self.draw_patch()

    def _gen_axes_spines(self):
        if frame == 'circle':
            return PolarAxes._gen_axes_spines(self)
        # The following is a hack to get the spines (i.e. the axes frame)
        # to draw correctly for a polygon frame.

        # spine_type must be 'left', 'right', 'top', 'bottom', or `circle`.
        spine_type = 'circle'
        verts = unit_poly_verts(theta)
        # close off polygon by repeating first vertex
        verts.append(verts[0])
        path = Path(verts)

        spine = Spine(self, spine_type, path)
        spine.set_transform(self.transAxes)
        return {'polar': spine}

register_projection(RadarAxes)
return theta

def unit_poly_verts(theta):
    """Return vertices of polygon for subplot axes.

    This polygon is circumscribed by a unit circle centered at (0.5, 0.5)
    """
    x0, y0, r = [0.5] * 3
    verts = [(r*np.cos(t) + x0, r*np.sin(t) + y0) for t in theta]
    return verts

```

```

def example_data():
    # The following data is from the Denver Aerosol Sources and Health study.
    # See doi:10.1016/j.atmosenv.2008.12.017
    #
    # The data are pollution source profile estimates for five modeled
    # pollution sources (e.g., cars, wood-burning, etc) that emit 7-9 chemical
    # species. The radar charts are experimented with here to see if we can
    # nicely visualize how the modeled source profiles change across four
    # scenarios:
    # 1) No gas-phase species present, just seven particulate counts on
    #   Sulfate
    #   Nitrate
    #   Elemental Carbon (EC)
    #   Organic Carbon fraction 1 (OC)
    #   Organic Carbon fraction 2 (OC2)
    #   Organic Carbon fraction 3 (OC3)
    #   Pyrolized Organic Carbon (OP)
    # 2)Inclusion of gas-phase specie carbon monoxide (CO)
    # 3)Inclusion of gas-phase specie ozone (O3).
    # 4)Inclusion of both gas-phase species is present...
    data = [
        ['Sulfate', 'Nitrate', 'EC', 'OC1', 'OC2', 'OC3', 'OP', 'CO', 'O3'],
        ('Basecase', [
            [0.88, 0.01, 0.03, 0.03, 0.00, 0.06, 0.01, 0.00, 0.00],
            [0.07, 0.95, 0.04, 0.05, 0.00, 0.02, 0.01, 0.00, 0.00],
            [0.01, 0.02, 0.85, 0.19, 0.05, 0.10, 0.00, 0.00, 0.00],
            [0.02, 0.01, 0.07, 0.01, 0.21, 0.12, 0.98, 0.00, 0.00],
            [0.01, 0.01, 0.02, 0.71, 0.74, 0.70, 0.00, 0.00, 0.00]]),
        ('With CO', [
            [0.88, 0.02, 0.02, 0.02, 0.00, 0.05, 0.00, 0.05, 0.00],
            [0.08, 0.94, 0.04, 0.02, 0.00, 0.01, 0.12, 0.04, 0.00],
            [0.01, 0.01, 0.79, 0.10, 0.00, 0.05, 0.00, 0.31, 0.00],
            [0.00, 0.02, 0.03, 0.38, 0.31, 0.31, 0.00, 0.59, 0.00],
            [0.02, 0.02, 0.11, 0.47, 0.69, 0.58, 0.88, 0.00, 0.00]]),
        ('With O3', [
            [0.89, 0.01, 0.07, 0.00, 0.00, 0.05, 0.00, 0.00, 0.03],
            [0.07, 0.95, 0.05, 0.04, 0.00, 0.02, 0.12, 0.00, 0.00],
            [0.01, 0.02, 0.86, 0.27, 0.16, 0.19, 0.00, 0.00, 0.00],
            [0.01, 0.03, 0.00, 0.32, 0.29, 0.27, 0.00, 0.00, 0.95],
            [0.02, 0.00, 0.03, 0.37, 0.56, 0.47, 0.87, 0.00, 0.00]]),
        ('CO & O3', [
            [0.87, 0.01, 0.08, 0.00, 0.00, 0.04, 0.00, 0.00, 0.01],
            [0.09, 0.95, 0.02, 0.03, 0.00, 0.01, 0.13, 0.06, 0.00],
            [0.01, 0.02, 0.71, 0.24, 0.13, 0.16, 0.00, 0.50, 0.00],
            [0.01, 0.03, 0.00, 0.28, 0.24, 0.23, 0.00, 0.44, 0.88],
            [0.02, 0.00, 0.18, 0.45, 0.64, 0.55, 0.86, 0.00, 0.16]])
    ]
    return data

if __name__ == '__main__':

```



```

N = 9
theta = radar_factory(N, frame='polygon')

data = example_data()
spoke_labels = data.pop(0)

fig, axes = plt.subplots(figsize=(9, 9), nrows=2, ncols=2,
                          subplot_kw=dict(projection='radar'))
fig.subplots_adjust(wspace=0.25, hspace=0.20, top=0.85, bottom=0.05)

colors = ['b', 'r', 'g', 'm', 'y']
# Plot the four cases from the example data on separate axes
for ax, (title, case_data) in zip(axes.flatten(), data):
    ax.set_rgrids([0.2, 0.4, 0.6, 0.8])
    ax.set_title(title, weight='bold', size='medium', position=(0.5, 1.1),
                 horizontalalignment='center', verticalalignment='center')
    for d, color in zip(case_data, colors):
        ax.plot(theta, d, color=color)
        ax.fill(theta, d, facecolor=color, alpha=0.25)
    ax.set_varlabels(spoke_labels)

# add legend relative to top-left plot
ax = axes[0, 0]
labels = ('Factor 1', 'Factor 2', 'Factor 3', 'Factor 4', 'Factor 5')
legend = ax.legend(labels, loc=(0.9, .95),
                  labelspacing=0.1, fontsize='small')

fig.text(0.5, 0.965, '5-Factor Solution Profiles Across Four Scenarios',
         horizontalalignment='center', color='black', weight='bold',
         size='large')

plt.show()

```

Keywords: python, matplotlib, pylab, example, codex (see [Search examples](#))

89.29 api example code: sankey_demo_basics.py

The default settings produce a diagram like this.

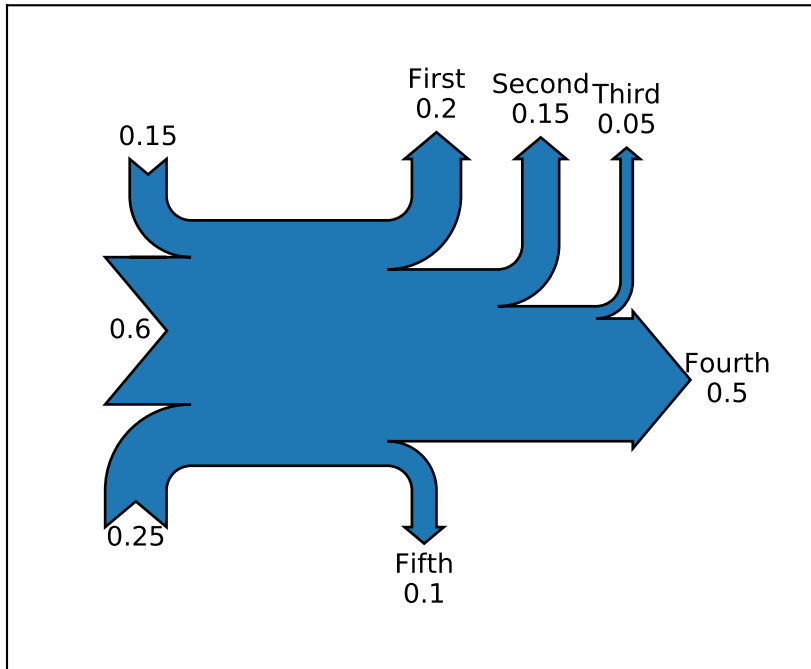

Flow Diagram of a Widget

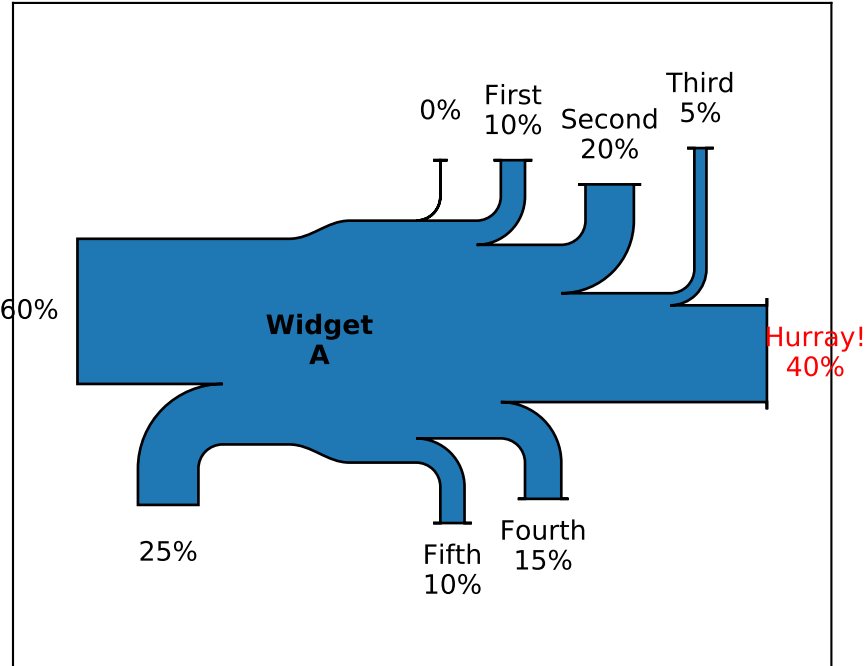

Two Systems

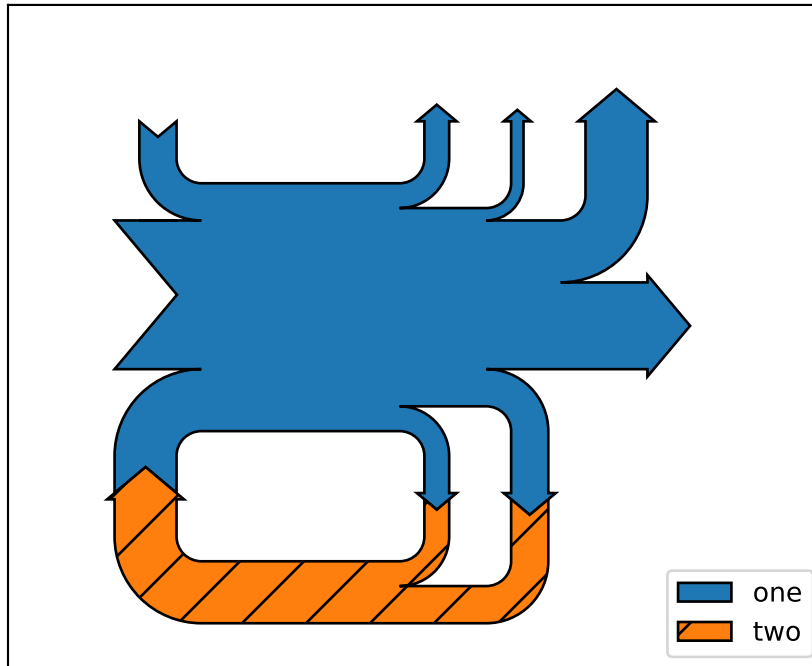

```

"""
=====
The Sankey class
=====

Demonstrate the Sankey class by producing three basic diagrams.
"""
import numpy as np
import matplotlib.pyplot as plt

from matplotlib.sankey import Sankey

# Example 1 -- Mostly defaults
# This demonstrates how to create a simple diagram by implicitly calling the
# Sankey.add() method and by appending finish() to the call to the class.
Sankey(flows=[0.25, 0.15, 0.60, -0.20, -0.15, -0.05, -0.50, -0.10],
       labels=['', '', '', 'First', 'Second', 'Third', 'Fourth', 'Fifth'],
       orientations=[-1, 1, 0, 1, 1, 1, 0, -1]).finish()
plt.title("The default settings produce a diagram like this.")
# Notice:
# 1. Axes weren't provided when Sankey() was instantiated, so they were
#    created automatically.
# 2. The scale argument wasn't necessary since the data was already
#    normalized.
# 3. By default, the lengths of the paths are justified.

```

```

# Example 2
# This demonstrates:
# 1. Setting one path longer than the others
# 2. Placing a label in the middle of the diagram
# 3. Using the scale argument to normalize the flows
# 4. Implicitly passing keyword arguments to PathPatch()
# 5. Changing the angle of the arrow heads
# 6. Changing the offset between the tips of the paths and their labels
# 7. Formatting the numbers in the path labels and the associated unit
# 8. Changing the appearance of the patch and the labels after the figure is
#    created
fig = plt.figure()
ax = fig.add_subplot(1, 1, 1, xticks=[], yticks=[],
                    title="Flow Diagram of a Widget")
sankey = Sankey(ax=ax, scale=0.01, offset=0.2, head_angle=180,
               format='%.0f', unit='%')
sankey.add(flows=[25, 0, 60, -10, -20, -5, -15, -10, -40],
          labels=['', '', '', 'First', 'Second', 'Third', 'Fourth',
                'Fifth', 'Hurray!'],
          orientations=[-1, 1, 0, 1, 1, 1, -1, -1, 0],
          pathlengths=[0.25, 0.25, 0.25, 0.25, 0.25, 0.6, 0.25, 0.25,
                      0.25],
          patchlabel="Widget\nA") # Arguments to matplotlib.patches.PathPatch()
diagrams = sankey.finish()
diagrams[0].texts[-1].set_color('r')
diagrams[0].text.set_fontweight('bold')
# Notice:
# 1. Since the sum of the flows is nonzero, the width of the trunk isn't
#    uniform. If verbose.level is helpful (in matplotlibrc), a message is
#    given in the terminal window.
# 2. The second flow doesn't appear because its value is zero. Again, if
#    verbose.level is helpful, a message is given in the terminal window.

# Example 3
# This demonstrates:
# 1. Connecting two systems
# 2. Turning off the labels of the quantities
# 3. Adding a legend
fig = plt.figure()
ax = fig.add_subplot(1, 1, 1, xticks=[], yticks=[], title="Two Systems")
flows = [0.25, 0.15, 0.60, -0.10, -0.05, -0.25, -0.15, -0.10, -0.35]
sankey = Sankey(ax=ax, unit=None)
sankey.add(flows=flows, label='one',
          orientations=[-1, 1, 0, 1, 1, 1, -1, -1, 0])
sankey.add(flows=[-0.25, 0.15, 0.1], label='two',
          orientations=[-1, -1, -1], prior=0, connect=(0, 0))
diagrams = sankey.finish()
diagrams[-1].patch.set_hatch('/')
plt.legend(loc='best')
# Notice that only one connection is specified, but the systems form a
# circuit since: (1) the lengths of the paths are justified and (2) the
# orientation and ordering of the flows is mirrored.

```

```
plt.show()
```

Keywords: python, matplotlib, pylab, example, codex (see [Search examples](#))

89.30 api example code: sankey_demo_links.py

Why would you want to do this?
(But you could.)

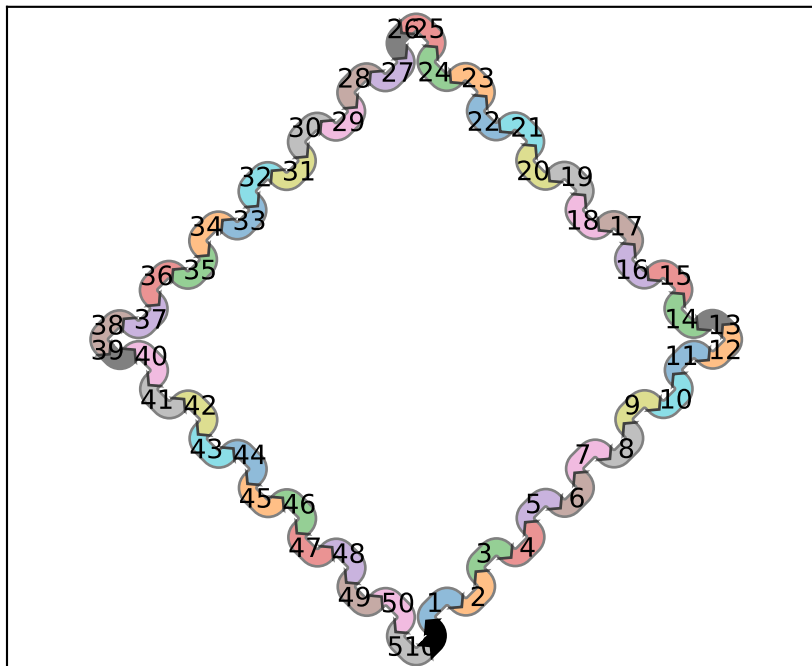

```
"""
=====
Long chain of connections using Sankey
=====

Demonstrate/test the Sankey class by producing a long chain of connections.
"""

from itertools import cycle

import matplotlib.pyplot as plt
from matplotlib.sankey import Sankey

links_per_side = 6
```

```

def side(sankey, n=1):
    """Generate a side chain."""
    prior = len(sankey.diagrams)
    for i in range(0, 2*n, 2):
        sankey.add(flows=[1, -1], orientations=[-1, -1],
                   patchlabel=str(prior + i),
                   prior=prior + i - 1, connect=(1, 0), alpha=0.5)
        sankey.add(flows=[1, -1], orientations=[1, 1],
                   patchlabel=str(prior + i + 1),
                   prior=prior + i, connect=(1, 0), alpha=0.5)

def corner(sankey):
    """Generate a corner link."""
    prior = len(sankey.diagrams)
    sankey.add(flows=[1, -1], orientations=[0, 1],
               patchlabel=str(prior), facecolor='k',
               prior=prior - 1, connect=(1, 0), alpha=0.5)

fig = plt.figure()
ax = fig.add_subplot(1, 1, 1, xticks=[], yticks=[],
                    title="Why would you want to do this?\n(But you could.)")
sankey = Sankey(ax=ax, unit=None)
sankey.add(flows=[1, -1], orientations=[0, 1],
           patchlabel="0", facecolor='k',
           rotation=45)
side(sankey, n=links_per_side)
corner(sankey)
side(sankey, n=links_per_side)
corner(sankey)
side(sankey, n=links_per_side)
corner(sankey)
side(sankey, n=links_per_side)
sankey.finish()
# Notice:
# 1. The alignment doesn't drift significantly (if at all; with 16007
#    subdiagrams there is still closure).
# 2. The first diagram is rotated 45 deg, so all other diagrams are rotated
#    accordingly.

plt.show()

```

Keywords: python, matplotlib, pylab, example, codex (see [Search examples](#))

89.31 api example code: sankey_demo_old.py

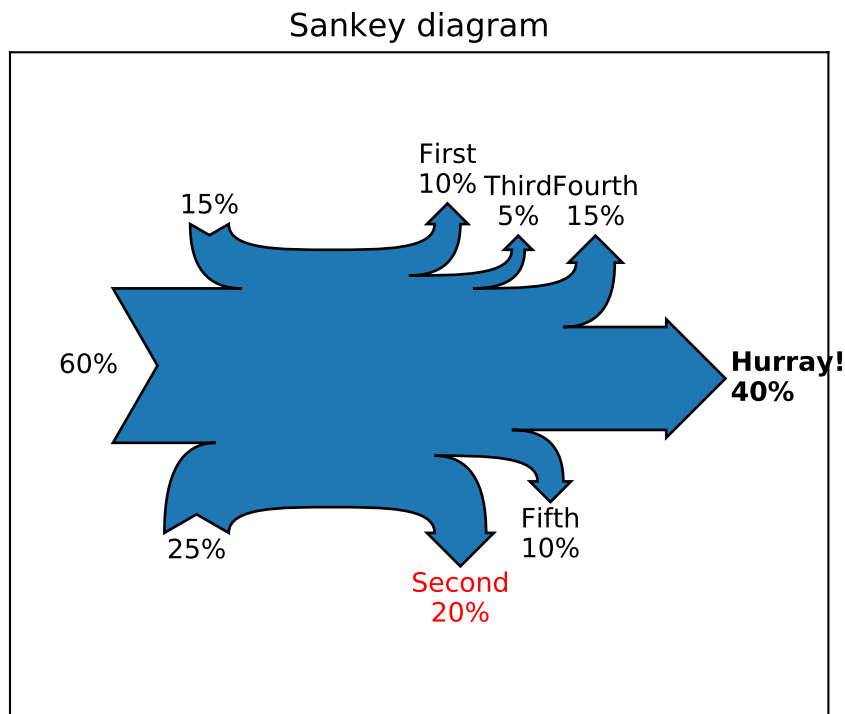

```

"""
=====
Yet another Sankey diagram
=====

This example showcases a more complex sankey diagram.
"""

from __future__ import print_function

__author__ = "Yannick Copin <ycopin@ipnl.in2p3.fr>"
__version__ = "Time-stamp: <10/02/2010 16:49 ycopin@lyopc548.in2p3.fr>"

import numpy as np

def sankey(ax,
           outputs=[100.], outlabels=None,
           inputs=[100.], inlabels='',
           dx=40, dy=10, outangle=45, w=3, inangle=30, offset=2, **kwargs):
    """Draw a Sankey diagram.

```



```

outputs: array of outputs, should sum up to 100%
outlabels: output labels (same length as outputs),
or None (use default labels) or " (no labels)
inputs and inlabels: similar for inputs
dx: horizontal elongation
dy: vertical elongation
outangle: output arrow angle [deg]
w: output arrow shoulder
inangle: input dip angle
offset: text offset
**kwargs: propagated to Patch (e.g., fill=False)

Return (patch,[intexts,outtexts]).
"""
import matplotlib.patches as mpatches
from matplotlib.path import Path

outs = np.absolute(outputs)
outsigns = np.sign(outputs)
outsigns[-1] = 0 # Last output

ins = np.absolute(inputs)
insigns = np.sign(inputs)
insigns[0] = 0 # First input

assert sum(outs) == 100, "Outputs don't sum up to 100%"
assert sum(ins) == 100, "Inputs don't sum up to 100%"

def add_output(path, loss, sign=1):
    # Arrow tip height
    h = (loss/2 + w) * np.tan(np.radians(outangle))
    move, (x, y) = path[-1] # Use last point as reference
    if sign == 0: # Final loss (horizontal)
        path.extend([(Path.LINETO, [x + dx, y]),
                    (Path.LINETO, [x + dx, y + w]),
                    (Path.LINETO, [x + dx + h, y - loss/2]), # Tip
                    (Path.LINETO, [x + dx, y - loss - w]),
                    (Path.LINETO, [x + dx, y - loss])])
        outtips.append((sign, path[-3][1]))
    else: # Intermediate loss (vertical)
        path.extend([(Path.CURVE4, [x + dx/2, y]),
                    (Path.CURVE4, [x + dx, y]),
                    (Path.CURVE4, [x + dx, y + sign*dy]),
                    (Path.LINETO, [x + dx - w, y + sign*dy]),
                    # Tip
                    (Path.LINETO, [
                        x + dx + loss/2, y + sign*(dy + h)]),
                    (Path.LINETO, [x + dx + loss + w, y + sign*dy]),
                    (Path.LINETO, [x + dx + loss, y + sign*dy]),
                    (Path.CURVE3, [x + dx + loss, y - sign*loss]),
                    (Path.CURVE3, [x + dx/2 + loss, y - sign*loss])])
        outtips.append((sign, path[-5][1]))

```

```

def add_input(path, gain, sign=1):
    h = (gain / 2) * np.tan(np.radians(inangle)) # Dip depth
    move, (x, y) = path[-1] # Use last point as reference
    if sign == 0: # First gain (horizontal)
        path.extend([(Path.LINETO, [x - dx, y]),
                    (Path.LINETO, [x - dx + h, y + gain/2]), # Dip
                    (Path.LINETO, [x - dx, y + gain])])
        xd, yd = path[-2][1] # Dip position
        indips.append((sign, [xd - h, yd]))
    else: # Intermediate gain (vertical)
        path.extend([(Path.CURVE4, [x - dx/2, y]),
                    (Path.CURVE4, [x - dx, y]),
                    (Path.CURVE4, [x - dx, y + sign*dy]),
                    # Dip
                    (Path.LINETO, [
                        x - dx - gain / 2, y + sign*(dy - h)]),
                    (Path.LINETO, [x - dx - gain, y + sign*dy]),
                    (Path.CURVE3, [x - dx - gain, y - sign*gain]),
                    (Path.CURVE3, [x - dx/2 - gain, y - sign*gain])])
        xd, yd = path[-4][1] # Dip position
        indips.append((sign, [xd, yd + sign*h]))

    outtips = [] # Output arrow tip dir. and positions
    urpath = [(Path.MOVETO, [0, 100])] # 1st point of upper right path
    lrpath = [(Path.LINETO, [0, 0])] # 1st point of lower right path
    for loss, sign in zip(outs, outsigns):
        add_output(sign >= 0 and urpath or lrpath, loss, sign=sign)

    indips = [] # Input arrow tip dir. and positions
    llpath = [(Path.LINETO, [0, 0])] # 1st point of lower left path
    ulpath = [(Path.MOVETO, [0, 100])] # 1st point of upper left path
    for gain, sign in reversed(list(zip(ins, insigns))):
        add_input(sign <= 0 and llpath or ulpath, gain, sign=sign)

def revert(path):
    """A path is not just revertable by path[::-1] because of Bezier
    curves."""
    rpath = []
    nextmove = Path.LINETO
    for move, pos in path[::-1]:
        rpath.append((nextmove, pos))
        nextmove = move
    return rpath

# Concatenate subpaths in correct order
path = urpath + revert(lrpath) + llpath + revert(ulpath)

codes, verts = zip(*path)
verts = np.array(verts)

# Path patch
path = Path(verts, codes)
patch = mpatches.PathPatch(path, **kwargs)

```

```

ax.add_patch(patch)

if False: # DEBUG
    print("urpath", urpath)
    print("lrpath", revert(lrpath))
    print("llpath", llpath)
    print("ulpath", revert(ulpath))
    xs, ys = zip(*verts)
    ax.plot(xs, ys, 'go-')

# Labels

def set_labels(labels, values):
    """Set or check labels according to values."""
    if labels == '': # No labels
        return labels
    elif labels is None: # Default labels
        return ['%2d%' % val for val in values]
    else:
        assert len(labels) == len(values)
        return labels

def put_labels(labels, positions, output=True):
    """Put labels to positions."""
    texts = []
    lbls = output and labels or labels[::-1]
    for i, label in enumerate(lbls):
        s, (x, y) = positions[i] # Label direction and position
        if s == 0:
            t = ax.text(x + offset, y, label,
                        ha=output and 'left' or 'right', va='center')
        elif s > 0:
            t = ax.text(x, y + offset, label, ha='center', va='bottom')
        else:
            t = ax.text(x, y - offset, label, ha='center', va='top')
        texts.append(t)
    return texts

outlabels = set_labels(outlabels, outs)
outtexts = put_labels(outlabels, outtips, output=True)

inlabels = set_labels(inlabels, ins)
intexts = put_labels(inlabels, indips, output=False)

# Axes management
ax.set_xlim(verts[:, 0].min() - dx, verts[:, 0].max() + dx)
ax.set_ylim(verts[:, 1].min() - dy, verts[:, 1].max() + dy)
ax.set_aspect('equal', adjustable='datalim')

return patch, [intexts, outtexts]

if __name__ == '__main__':

```

```
import matplotlib.pyplot as plt

outputs = [10., -20., 5., 15., -10., 40.]
outlabels = ['First', 'Second', 'Third', 'Fourth', 'Fifth', 'Hurray!']
outlabels = [s + '\n%d%%' % abs(l) for l, s in zip(outputs, outlabels)]

inputs = [60., -25., 15.]

fig = plt.figure()
ax = fig.add_subplot(1, 1, 1, xticks=[], yticks=[], title="Sankey diagram")

patch, (intexts, outtexts) = sankey(ax, outputs=outputs,
                                   outlabels=outlabels, inputs=inputs,
                                   inlabels=None)

outtexts[1].set_color('r')
outtexts[-1].set_fontweight('bold')

plt.show()
```

Keywords: python, matplotlib, pylab, example, codex (see [Search examples](#))

89.32 api example code: sankey_demo_rankine.py

Rankine Power Cycle: Example 8.6 from Moran and Shapiro
 "Fundamentals of Engineering Thermodynamics ", 6th ed., 2008

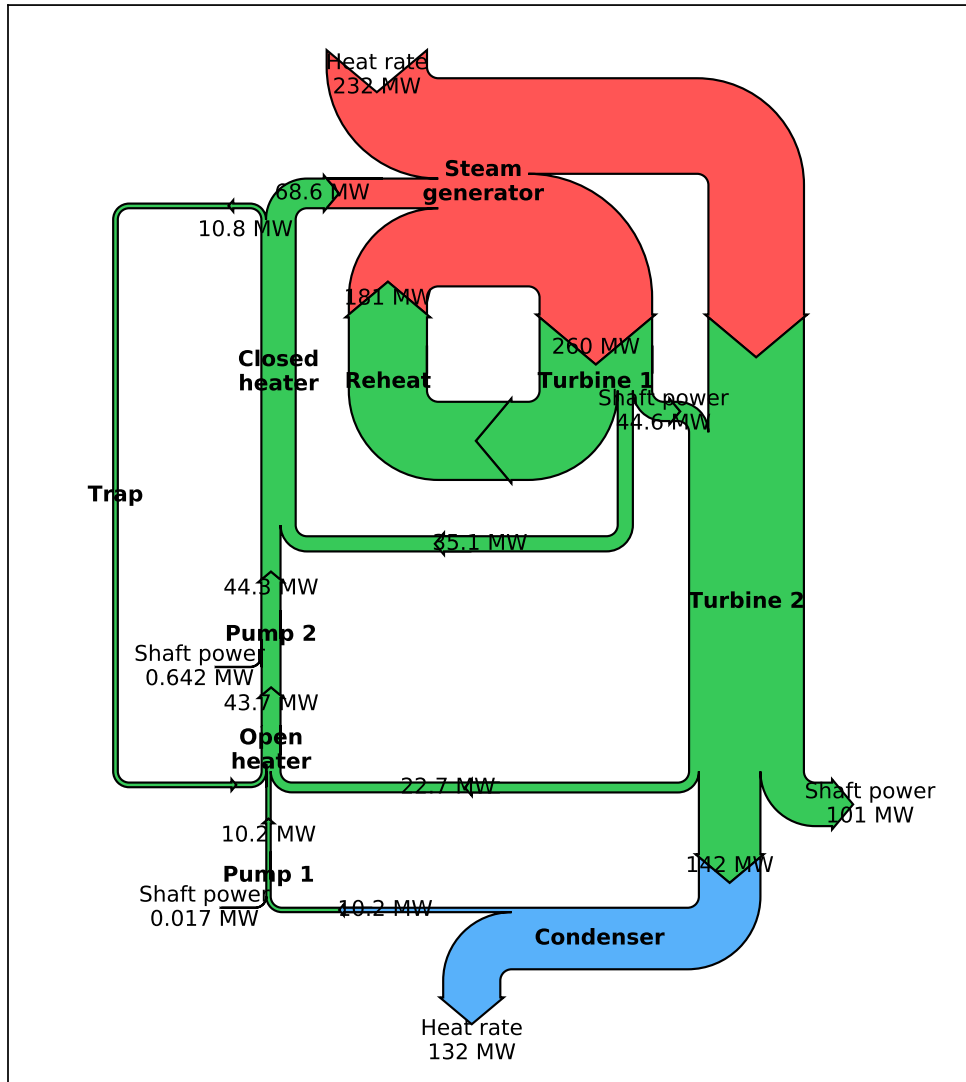

```

****
=====
Rankine power cycle
=====

Demonstrate the Sankey class with a practical example of a Rankine power
    
```

```

cycle.

"""
import matplotlib.pyplot as plt

from matplotlib.sankey import Sankey

fig = plt.figure(figsize=(8, 9))
ax = fig.add_subplot(1, 1, 1, xticks=[], yticks=[],
                    title="Rankine Power Cycle: Example 8.6 from Moran and "
                          "Shapiro\n\x22Fundamentals of Engineering Thermodynamics "
                          "\x22, 6th ed., 2008")
Hdot = [260.431, 35.078, 180.794, 221.115, 22.700,
        142.361, 10.193, 10.210, 43.670, 44.312,
        68.631, 10.758, 10.758, 0.017, 0.642,
        232.121, 44.559, 100.613, 132.168] # MW
sankey = Sankey(ax=ax, format='%.3G', unit=' MW', gap=0.5, scale=1.0/Hdot[0])
sankey.add(patchlabel='\n\nPump 1', rotation=90, facecolor='#37c959',
          flows=[Hdot[13], Hdot[6], -Hdot[7]],
          labels=['Shaft power', '', None],
          pathlengths=[0.4, 0.883, 0.25],
          orientations=[1, -1, 0])
sankey.add(patchlabel='\n\nOpen\nheater', facecolor='#37c959',
          flows=[Hdot[11], Hdot[7], Hdot[4], -Hdot[8]],
          labels=[None, '', None, None],
          pathlengths=[0.25, 0.25, 1.93, 0.25],
          orientations=[1, 0, -1, 0], prior=0, connect=(2, 1))
sankey.add(patchlabel='\n\nPump 2', facecolor='#37c959',
          flows=[Hdot[14], Hdot[8], -Hdot[9]],
          labels=['Shaft power', '', None],
          pathlengths=[0.4, 0.25, 0.25],
          orientations=[1, 0, 0], prior=1, connect=(3, 1))
sankey.add(patchlabel='Closed\nheater', trunklength=2.914, fc='#37c959',
          flows=[Hdot[9], Hdot[1], -Hdot[11], -Hdot[10]],
          pathlengths=[0.25, 1.543, 0.25, 0.25],
          labels=['', '', None, None],
          orientations=[0, -1, 1, -1], prior=2, connect=(2, 0))
sankey.add(patchlabel='Trap', facecolor='#37c959', trunklength=5.102,
          flows=[Hdot[11], -Hdot[12]],
          labels=['\n', None],
          pathlengths=[1.0, 1.01],
          orientations=[1, 1], prior=3, connect=(2, 0))
sankey.add(patchlabel='Steam\ngenerator', facecolor='#ff5555',
          flows=[Hdot[15], Hdot[10], Hdot[2], -Hdot[3], -Hdot[0]],
          labels=['Heat rate', '', '', None, None],
          pathlengths=0.25,
          orientations=[1, 0, -1, -1, -1], prior=3, connect=(3, 1))
sankey.add(patchlabel='\n\n\nTurbine 1', facecolor='#37c959',
          flows=[Hdot[0], -Hdot[16], -Hdot[1], -Hdot[2]],
          labels=['', None, None, None],
          pathlengths=[0.25, 0.153, 1.543, 0.25],
          orientations=[0, 1, -1, -1], prior=5, connect=(4, 0))
sankey.add(patchlabel='\n\n\nReheat', facecolor='#37c959',

```

```

        flows=[Hdot[2], -Hdot[2]],
        labels=[None, None],
        pathlengths=[0.725, 0.25],
        orientations=[-1, 0], prior=6, connect=(3, 0))
sankey.add(patchlabel='Turbine 2', trunklength=3.212, facecolor='#37c959',
        flows=[Hdot[3], Hdot[16], -Hdot[5], -Hdot[4], -Hdot[17]],
        labels=[None, 'Shaft power', None, '', 'Shaft power'],
        pathlengths=[0.751, 0.15, 0.25, 1.93, 0.25],
        orientations=[0, -1, 0, -1, 1], prior=6, connect=(1, 1))
sankey.add(patchlabel='Condenser', facecolor='#58b1fa', trunklength=1.764,
        flows=[Hdot[5], -Hdot[18], -Hdot[6]],
        labels=['', 'Heat rate', None],
        pathlengths=[0.45, 0.25, 0.883],
        orientations=[-1, 1, 0], prior=8, connect=(2, 0))
diagrams = sankey.finish()
for diagram in diagrams:
    diagram.text.set_fontweight('bold')
    diagram.text.set_fontsize('10')
    for text in diagram.texts:
        text.set_fontsize('10')
# Notice that the explicit connections are handled automatically, but the
# implicit ones currently are not. The lengths of the paths and the trunks
# must be adjusted manually, and that is a bit tricky.

plt.show()

```

Keywords: python, matplotlib, pylab, example, codex (see [Search examples](#))

89.33 api example code: scatter_piecharts.py

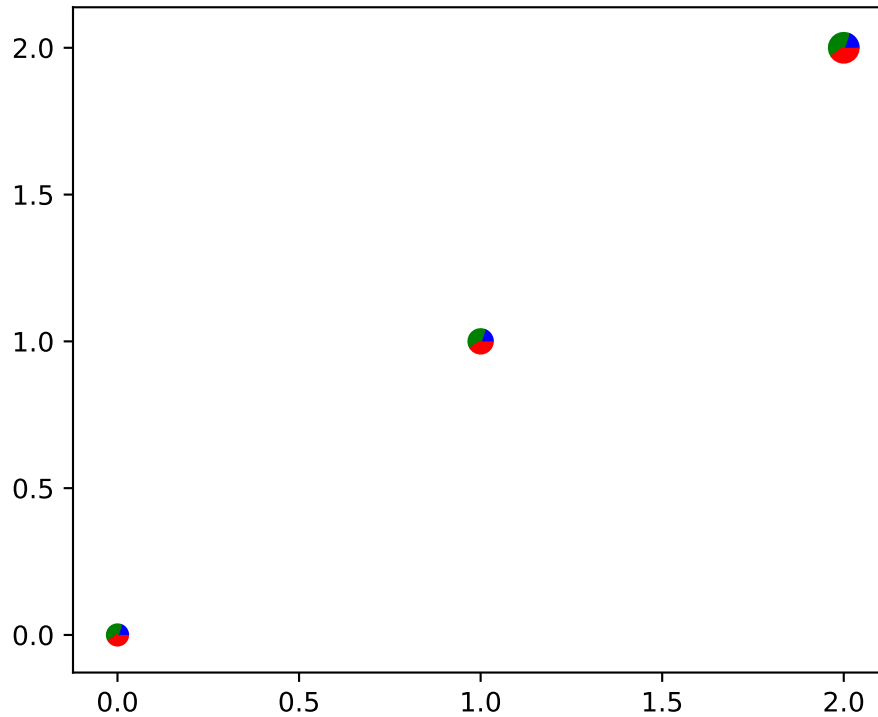

```
"""
=====
Scatter plot with pie chart markers
=====

This example makes custom 'pie charts' as the markers for a scatter plot.

Thanks to Manuel Metz for the example
"""
import math
import numpy as np
import matplotlib.pyplot as plt

# first define the ratios
r1 = 0.2      # 20%
r2 = r1 + 0.4 # 40%

# define some sizes of the scatter marker
sizes = [60, 80, 120]

# calculate the points of the first pie marker
#
```



```

# these are just the origin (0,0) +
# some points on a circle cos,sin
x = [0] + np.cos(np.linspace(0, 2*math.pi*r1, 10)).tolist()
y = [0] + np.sin(np.linspace(0, 2*math.pi*r1, 10)).tolist()

xy1 = list(zip(x, y))
s1 = max(max(x), max(y))

# ...
x = [0] + np.cos(np.linspace(2*math.pi*r1, 2*math.pi*r2, 10)).tolist()
y = [0] + np.sin(np.linspace(2*math.pi*r1, 2*math.pi*r2, 10)).tolist()
xy2 = list(zip(x, y))
s2 = max(max(x), max(y))

x = [0] + np.cos(np.linspace(2*math.pi*r2, 2*math.pi, 10)).tolist()
y = [0] + np.sin(np.linspace(2*math.pi*r2, 2*math.pi, 10)).tolist()
xy3 = list(zip(x, y))
s3 = max(max(x), max(y))

fig, ax = plt.subplots()
ax.scatter(np.arange(3), np.arange(3), marker=(xy1, 0),
           s=[s1*s1*_ for _ in sizes], facecolor='blue')
ax.scatter(np.arange(3), np.arange(3), marker=(xy2, 0),
           s=[s2*s2*_ for _ in sizes], facecolor='green')
ax.scatter(np.arange(3), np.arange(3), marker=(xy3, 0),
           s=[s3*s3*_ for _ in sizes], facecolor='red')

plt.show()

```

Keywords: python, matplotlib, pylab, example, codex (see [Search examples](#))

89.34 api example code: skewt.py

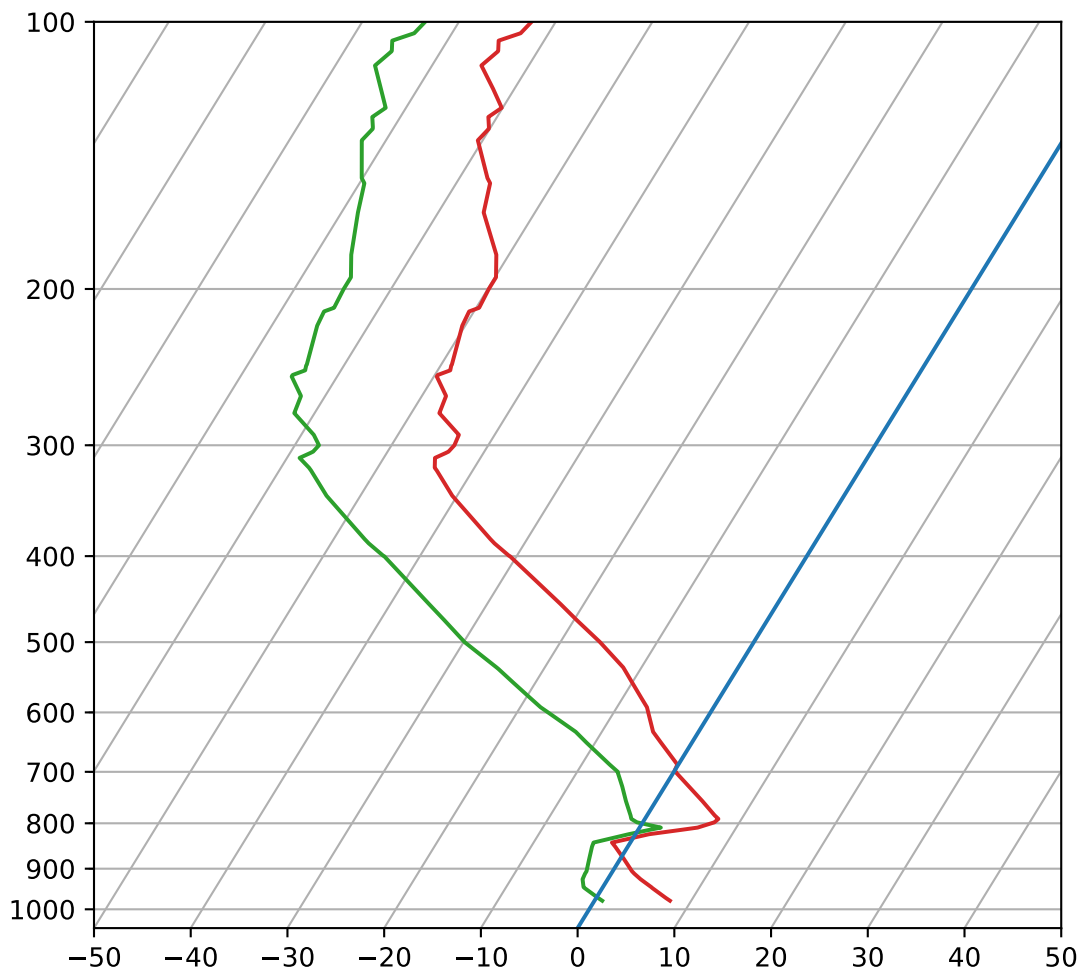

```
"""
```

```
=====
SkewT-logP diagram: using transforms and custom projections
=====
```

```
This serves as an intensive exercise of matplotlib's transforms and custom
projection API. This example produces a so-called SkewT-logP diagram, which is
a common plot in meteorology for displaying vertical profiles of temperature.
As far as matplotlib is concerned, the complexity comes from having X and Y
axes that are not orthogonal. This is handled by including a skew component to
the basic Axes transforms. Additional complexity comes in handling the fact
that the upper and lower X-axes have different data ranges, which necessitates
a bunch of custom classes for ticks,spines, and the axis to handle this.
```

```

"""

from matplotlib.axes import Axes
import matplotlib.transforms as transforms
import matplotlib.axis as maxis
import matplotlib.spines as mspines
from matplotlib.projections import register_projection

# The sole purpose of this class is to look at the upper, lower, or total
# interval as appropriate and see what parts of the tick to draw, if any.
class SkewXTick(maxis.XTick):
    def update_position(self, loc):
        # This ensures that the new value of the location is set before
        # any other updates take place
        self._loc = loc
        super(SkewXTick, self).update_position(loc)

    def _has_default_loc(self):
        return self.get_loc() is None

    def _need_lower(self):
        return (self._has_default_loc() or
                transforms.interval_contains(self.axes.lower_xlim,
                                             self.get_loc()))

    def _need_upper(self):
        return (self._has_default_loc() or
                transforms.interval_contains(self.axes.upper_xlim,
                                             self.get_loc()))

    @property
    def gridOn(self):
        return (self._gridOn and (self._has_default_loc() or
                                   transforms.interval_contains(self.get_view_interval(),
                                                               self.get_loc())))

    @gridOn.setter
    def gridOn(self, value):
        self._gridOn = value

    @property
    def tick10n(self):
        return self._tick10n and self._need_lower()

    @tick10n.setter
    def tick10n(self, value):
        self._tick10n = value

    @property
    def label10n(self):
        return self._label10n and self._need_lower()

```

```

@label1On.setter
def label1On(self, value):
    self._label1On = value

@property
def tick2On(self):
    return self._tick2On and self._need_upper()

@tick2On.setter
def tick2On(self, value):
    self._tick2On = value

@property
def label2On(self):
    return self._label2On and self._need_upper()

@label2On.setter
def label2On(self, value):
    self._label2On = value

def get_view_interval(self):
    return self.axes.xaxis.get_view_interval()

# This class exists to provide two separate sets of intervals to the tick,
# as well as create instances of the custom tick
class SkewXAxis(maxis.XAxis):
    def _get_tick(self, major):
        return SkewXTick(self.axes, None, '', major=major)

    def get_view_interval(self):
        return self.axes.upper_xlim[0], self.axes.lower_xlim[1]

# This class exists to calculate the separate data range of the
# upper X-axis and draw the spine there. It also provides this range
# to the X-axis artist for ticking and gridlines
class SkewSpine(mspines.Spine):
    def _adjust_location(self):
        pts = self._path.vertices
        if self.spine_type == 'top':
            pts[:, 0] = self.axes.upper_xlim
        else:
            pts[:, 0] = self.axes.lower_xlim

# This class handles registration of the skew-xaxes as a projection as well
# as setting up the appropriate transformations. It also overrides standard
# spines and axes instances as appropriate.
class SkewXAxes(Axes):
    # The projection must specify a name. This will be used by the
    # user to select the projection, i.e. ``subplot(111,

```

```

# projection='skewx')`.
name = 'skewx'

def _init_axis(self):
    # Taken from Axes and modified to use our modified X-axis
    self.xaxis = SkewXAxis(self)
    self.spines['top'].register_axis(self.xaxis)
    self.spines['bottom'].register_axis(self.xaxis)
    self.yaxis = maxis.YAxis(self)
    self.spines['left'].register_axis(self.yaxis)
    self.spines['right'].register_axis(self.yaxis)

def _gen_axes_spines(self):
    spines = {'top': SkewSpine.linear_spine(self, 'top'),
              'bottom': mspines.Spine.linear_spine(self, 'bottom'),
              'left': mspines.Spine.linear_spine(self, 'left'),
              'right': mspines.Spine.linear_spine(self, 'right')}
    return spines

def _set_lim_and_transforms(self):
    """
    This is called once when the plot is created to set up all the
    transforms for the data, text and grids.
    """
    rot = 30

    # Get the standard transform setup from the Axes base class
    Axes._set_lim_and_transforms(self)

    # Need to put the skew in the middle, after the scale and limits,
    # but before the transAxes. This way, the skew is done in Axes
    # coordinates thus performing the transform around the proper origin
    # We keep the pre-transAxes transform around for other users, like the
    # spines for finding bounds
    self.transDataToAxes = self.transScale + \
        self.transLimits + transforms.Affine2D().skew_deg(rot, 0)

    # Create the full transform from Data to Pixels
    self.transData = self.transDataToAxes + self.transAxes

    # Blended transforms like this need to have the skewing applied using
    # both axes, in axes coords like before.
    self._xaxis_transform = (transforms.blended_transform_factory(
        self.transScale + self.transLimits,
        transforms.IdentityTransform()) +
        transforms.Affine2D().skew_deg(rot, 0)) + self.transAxes

@property
def lower_xlim(self):
    return self.axes.viewLim.intervalx

@property
def upper_xlim(self):

```

```

    pts = [[0., 1.], [1., 1.]]
    return self.transDataToAxes.inverted().transform(pts)[: , 0]

# Now register the projection with matplotlib so the user can select
# it.
register_projection(SkewXAxes)

if __name__ == '__main__':
    # Now make a simple example using the custom projection.
    from matplotlib.ticker import (MultipleLocator, NullFormatter,
                                   ScalarFormatter)

    import matplotlib.pyplot as plt
    from six import StringIO
    import numpy as np

    # Some examples data
    data_txt = '''
978.0    345    7.8    0.8    61    4.16    325    14    282.7    294.6    283.4
971.0    404    7.2    0.2    61    4.01    327    17    282.7    294.2    283.4
946.7    610    5.2    -1.8    61    3.56    335    26    282.8    293.0    283.4
944.0    634    5.0    -2.0    61    3.51    336    27    282.8    292.9    283.4
925.0    798    3.4    -2.6    65    3.43    340    32    282.8    292.7    283.4
911.8    914    2.4    -2.7    69    3.46    345    37    282.9    292.9    283.5
906.0    966    2.0    -2.7    71    3.47    348    39    283.0    293.0    283.6
877.9    1219    0.4    -3.2    77    3.46    0    48    283.9    293.9    284.5
850.0    1478    -1.3    -3.7    84    3.44    0    47    284.8    294.8    285.4
841.0    1563    -1.9    -3.8    87    3.45    358    45    285.0    295.0    285.6
823.0    1736    1.4    -0.7    86    4.44    353    42    290.3    303.3    291.0
813.6    1829    4.5    1.2    80    5.17    350    40    294.5    309.8    295.4
809.0    1875    6.0    2.2    77    5.57    347    39    296.6    313.2    297.6
798.0    1988    7.4    -0.6    57    4.61    340    35    299.2    313.3    300.1
791.0    2061    7.6    -1.4    53    4.39    335    33    300.2    313.6    301.0
783.9    2134    7.0    -1.7    54    4.32    330    31    300.4    313.6    301.2
755.1    2438    4.8    -3.1    57    4.06    300    24    301.2    313.7    301.9
727.3    2743    2.5    -4.4    60    3.81    285    29    301.9    313.8    302.6
700.5    3048    0.2    -5.8    64    3.57    275    31    302.7    313.8    303.3
700.0    3054    0.2    -5.8    64    3.56    280    31    302.7    313.8    303.3
698.0    3077    0.0    -6.0    64    3.52    280    31    302.7    313.7    303.4
687.0    3204    -0.1    -7.1    59    3.28    281    31    304.0    314.3    304.6
648.9    3658    -3.2    -10.9    55    2.59    285    30    305.5    313.8    305.9
631.0    3881    -4.7    -12.7    54    2.29    289    33    306.2    313.6    306.6
600.7    4267    -6.4    -16.7    44    1.73    295    39    308.6    314.3    308.9
592.0    4381    -6.9    -17.9    41    1.59    297    41    309.3    314.6    309.6
577.6    4572    -8.1    -19.6    39    1.41    300    44    310.1    314.9    310.3
555.3    4877    -10.0    -22.3    36    1.16    295    39    311.3    315.3    311.5
536.0    5151    -11.7    -24.7    33    0.97    304    39    312.4    315.8    312.6
533.8    5182    -11.9    -25.0    33    0.95    305    39    312.5    315.8    312.7
500.0    5680    -15.9    -29.9    29    0.64    290    44    313.6    315.9    313.7
472.3    6096    -19.7    -33.4    28    0.49    285    46    314.1    315.8    314.1
453.0    6401    -22.4    -36.0    28    0.39    300    50    314.4    315.8    314.4
400.0    7310    -30.7    -43.7    27    0.20    285    44    315.0    315.8    315.0
399.7    7315    -30.8    -43.8    27    0.20    285    44    315.0    315.8    315.0
'''

```

```

387.0  7543  -33.1  -46.1    26  0.16   281   47  314.9  315.5  314.9
382.7  7620  -33.8  -46.8    26  0.15   280   48  315.0  315.6  315.0
342.0  8398  -40.5  -53.5    23  0.08   293   52  316.1  316.4  316.1
320.4  8839  -43.7  -56.7    22  0.06   300   54  317.6  317.8  317.6
318.0  8890  -44.1  -57.1    22  0.05   301   55  317.8  318.0  317.8
310.0  9060  -44.7  -58.7    19  0.04   304   61  319.2  319.4  319.2
306.1  9144  -43.9  -57.9    20  0.05   305   63  321.5  321.7  321.5
305.0  9169  -43.7  -57.7    20  0.05   303   63  322.1  322.4  322.1
300.0  9280  -43.5  -57.5    20  0.05   295   64  323.9  324.2  323.9
292.0  9462  -43.7  -58.7    17  0.05   293   67  326.2  326.4  326.2
276.0  9838  -47.1  -62.1    16  0.03   290   74  326.6  326.7  326.6
264.0 10132  -47.5  -62.5    16  0.03   288   79  330.1  330.3  330.1
251.0 10464  -49.7  -64.7    16  0.03   285   85  331.7  331.8  331.7
250.0 10490  -49.7  -64.7    16  0.03   285   85  332.1  332.2  332.1
247.0 10569  -48.7  -63.7    16  0.03   283   88  334.7  334.8  334.7
244.0 10649  -48.9  -63.9    16  0.03   280   91  335.6  335.7  335.6
243.3 10668  -48.9  -63.9    16  0.03   280   91  335.8  335.9  335.8
220.0 11327  -50.3  -65.3    15  0.03   280   85  343.5  343.6  343.5
212.0 11569  -50.5  -65.5    15  0.03   280   83  346.8  346.9  346.8
210.0 11631  -49.7  -64.7    16  0.03   280   83  349.0  349.1  349.0
200.0 11950  -49.9  -64.9    15  0.03   280   80  353.6  353.7  353.6
194.0 12149  -49.9  -64.9    15  0.03   279   78  356.7  356.8  356.7
183.0 12529  -51.3  -66.3    15  0.03   278   75  360.4  360.5  360.4
164.0 13233  -55.3  -68.3    18  0.02   277   69  365.2  365.3  365.2
152.0 13716  -56.5  -69.5    18  0.02   275   65  371.1  371.2  371.1
150.0 13800  -57.1  -70.1    18  0.02   275   64  371.5  371.6  371.5
136.0 14414  -60.5  -72.5    19  0.02   268   54  376.0  376.1  376.0
132.0 14600  -60.1  -72.1    19  0.02   265   51  380.0  380.1  380.0
131.4 14630  -60.2  -72.2    19  0.02   265   51  380.3  380.4  380.3
128.0 14792  -60.9  -72.9    19  0.02   266   50  381.9  382.0  381.9
125.0 14939  -60.1  -72.1    19  0.02   268   49  385.9  386.0  385.9
119.0 15240  -62.2  -73.8    20  0.01   270   48  387.4  387.5  387.4
112.0 15616  -64.9  -75.9    21  0.01   265   53  389.3  389.3  389.3
108.0 15838  -64.1  -75.1    21  0.01   265   58  394.8  394.9  394.8
107.8 15850  -64.1  -75.1    21  0.01   265   58  395.0  395.1  395.0
105.0 16010  -64.7  -75.7    21  0.01   272   50  396.9  396.9  396.9
103.0 16128  -62.9  -73.9    21  0.02   277   45  402.5  402.6  402.5
100.0 16310  -62.5  -73.5    21  0.02   285   36  406.7  406.8  406.7
'''

```

```

# Parse the data
sound_data = StringIO(data_txt)
p, h, T, Td = np.loadtxt(sound_data, usecols=range(0, 4), unpack=True)

# Create a new figure. The dimensions here give a good aspect ratio
fig = plt.figure(figsize=(6.5875, 6.2125))
ax = fig.add_subplot(111, projection='skewx')

plt.grid(True)

# Plot the data using normal plotting functions, in this case using
# log scaling in Y, as dictated by the typical meteorological plot
ax.semilogy(T, p, color='C3')

```

```

ax.semilogy(Td, p, color='C2')

# An example of a slanted line at constant X
l = ax.axvline(0, color='C0')

# Disables the log-formatting that comes with semilogy
ax.yaxis.set_major_formatter(ScalarFormatter())
ax.yaxis.set_minor_formatter(NullFormatter())
ax.set_yticks(np.linspace(100, 1000, 10))
ax.set_ylim(1050, 100)

ax.xaxis.set_major_locator(MultipleLocator(10))
ax.set_xlim(-50, 50)

plt.show()

```

Keywords: python, matplotlib, pylab, example, codex (see [Search examples](#))

89.35 api example code: span_regions.py

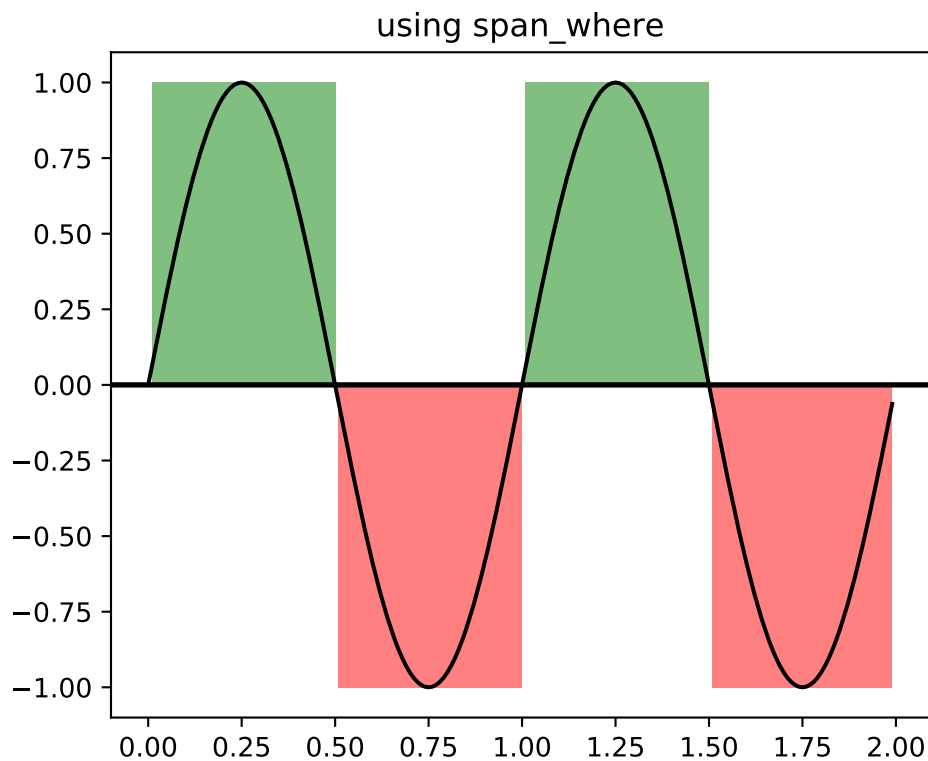

```

"""
=====

```



```
Using span_where
=====

Illustrate some helper functions for shading regions where a logical
mask is True

See :meth:`matplotlib.collections.BrokenBarHCollection.span_where`
"""
import numpy as np
import matplotlib.pyplot as plt
import matplotlib.collections as collections

t = np.arange(0.0, 2, 0.01)
s1 = np.sin(2*np.pi*t)
s2 = 1.2*np.sin(4*np.pi*t)

fig, ax = plt.subplots()
ax.set_title('using span_where')
ax.plot(t, s1, color='black')
ax.axhline(0, color='black', lw=2)

collection = collections.BrokenBarHCollection.span_where(
    t, ymin=0, ymax=1, where=s1 > 0, facecolor='green', alpha=0.5)
ax.add_collection(collection)

collection = collections.BrokenBarHCollection.span_where(
    t, ymin=-1, ymax=0, where=s1 < 0, facecolor='red', alpha=0.5)
ax.add_collection(collection)

plt.show()
```

Keywords: python, matplotlib, pylab, example, codex (see [Search examples](#))

89.36 api example code: two_scales.py

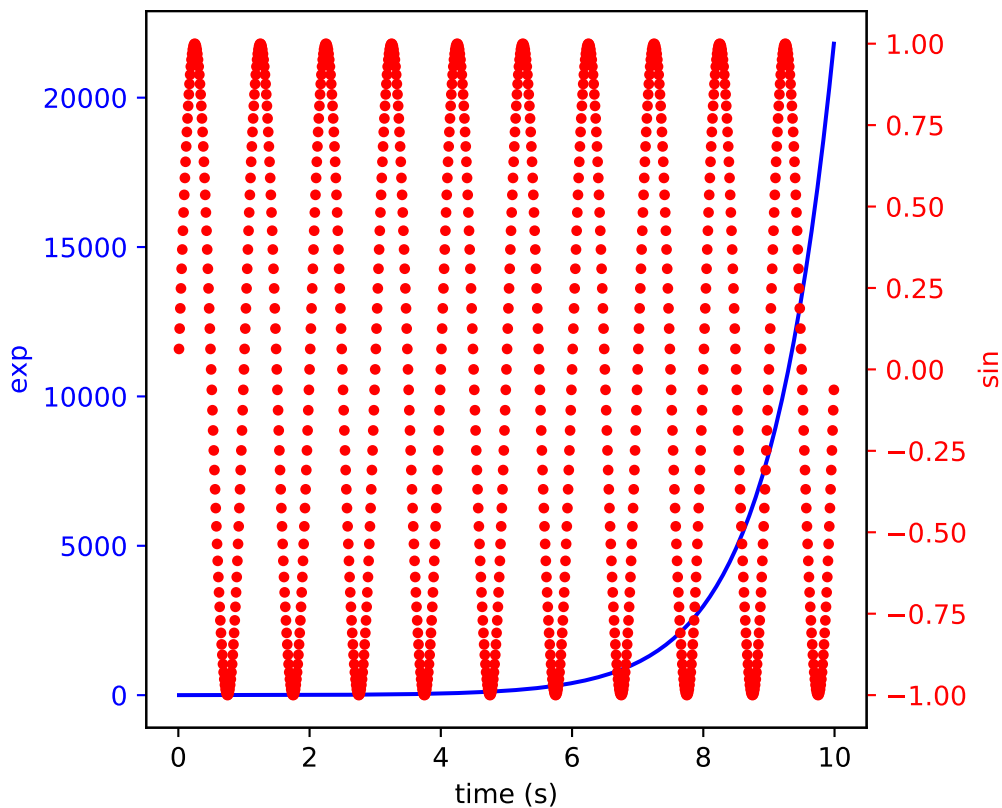

```

"""
=====
Plots with different scales
=====

Demonstrate how to do two plots on the same axes with different left and
right scales.

The trick is to use two different axes that share the same x axis.
You can use separate matplotlib.ticker formatters and locators as
desired since the two axes are independent.

Such axes are generated by calling the Axes.twinx method. Likewise,
Axes.twinx is available to generate axes that share a y axis but
have different top and bottom scales.

The twinx and twinx methods are also exposed as pyplot functions.

"""

import numpy as np
import matplotlib.pyplot as plt

```

```

fig, ax1 = plt.subplots()
t = np.arange(0.01, 10.0, 0.01)
s1 = np.exp(t)
ax1.plot(t, s1, 'b-')
ax1.set_xlabel('time (s)')
# Make the y-axis label, ticks and tick labels match the line color.
ax1.set_ylabel('exp', color='b')
ax1.tick_params('y', colors='b')

ax2 = ax1.twinx()
s2 = np.sin(2 * np.pi * t)
ax2.plot(t, s2, 'r.')
ax2.set_ylabel('sin', color='r')
ax2.tick_params('y', colors='r')

fig.tight_layout()
plt.show()

```

Keywords: python, matplotlib, pylab, example, codex (see [Search examples](#))

89.37 api example code: unicode_minus.py

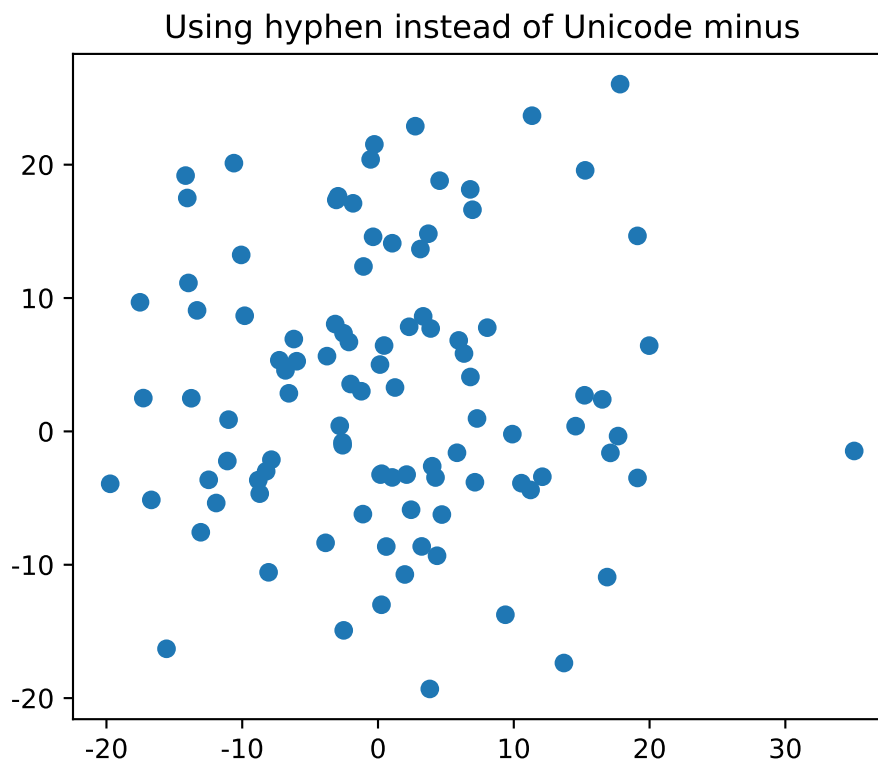

```
"""
=====
Unicode minus
=====

You can use the proper typesetting Unicode minus (see
https://en.wikipedia.org/wiki/Plus\_sign#Plus\_sign) or the ASCII hyphen
for minus, which some people prefer. The matplotlibrc param
axes.unicode_minus controls the default behavior.

The default is to use the Unicode minus.
"""
import numpy as np
import matplotlib
import matplotlib.pyplot as plt

matplotlib.rcParams['axes.unicode_minus'] = False
fig, ax = plt.subplots()
ax.plot(10*np.random.randn(100), 10*np.random.randn(100), 'o')
ax.set_title('Using hyphen instead of Unicode minus')
plt.show()
```

Keywords: python, matplotlib, pylab, example, codex (see *Search examples*)

89.38 api example code: watermark_image.py

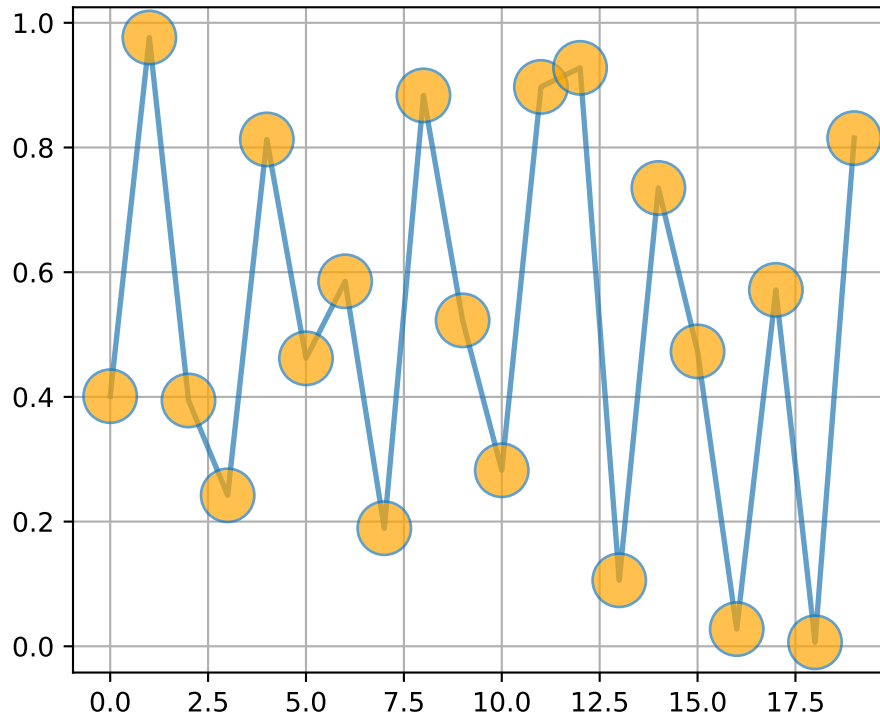

```

"""
=====
Watermark image
=====

Use a PNG file as a watermark
"""
from __future__ import print_function
import numpy as np
import matplotlib.cbook as cbook
import matplotlib.image as image
import matplotlib.pyplot as plt

datafile = cbook.get_sample_data('logo2.png', asfileobj=False)
print('loading %s' % datafile)
im = image.imread(datafile)
im[:, :, -1] = 0.5 # set the alpha channel

fig, ax = plt.subplots()

ax.plot(np.random.rand(20), '-o', ms=20, lw=2, alpha=0.7, mfc='orange')
ax.grid()

```

```
fig.figimage(im, 10, 10, zorder=3)

plt.show()
```

Keywords: python, matplotlib, pylab, example, codex (see *Search examples*)

89.39 api example code: watermark_text.py

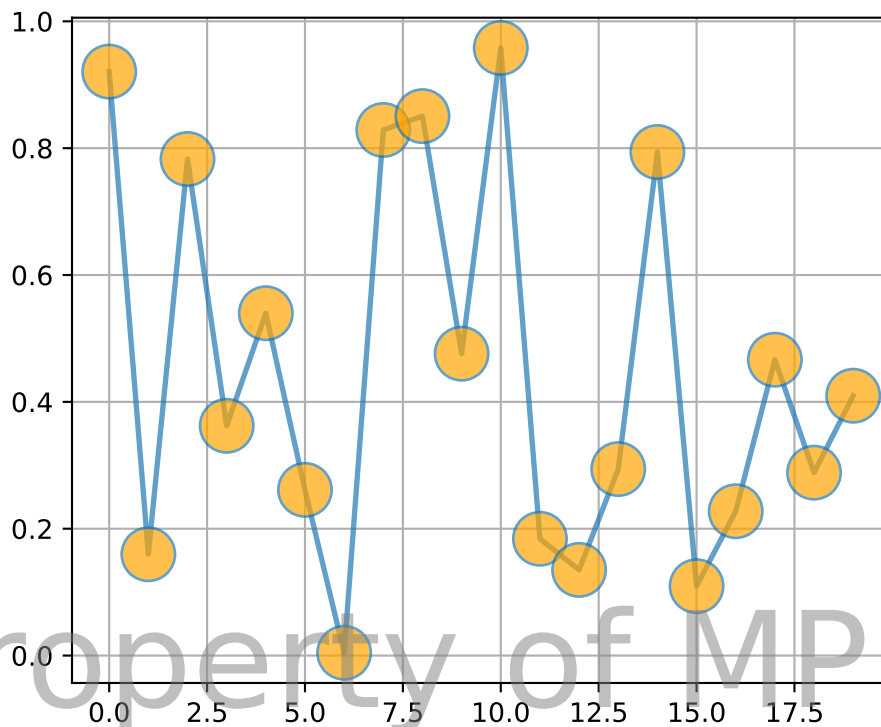

```
"""
=====
Text watermark
=====

Use a Text as a watermark
"""
import numpy as np
#import matplotlib
#matplotlib.use('Agg')

import matplotlib.pyplot as plt

fig, ax = plt.subplots()
```

```
ax.plot(np.random.rand(20), '-o', ms=20, lw=2, alpha=0.7, mfc='orange')
ax.grid()

# position bottom right
fig.text(0.95, 0.05, 'Property of MPL',
        fontsize=50, color='gray',
        ha='right', va='bottom', alpha=0.5)

plt.show()
```

Keywords: python, matplotlib, pylab, example, codex (see [Search examples](#))

AXES_GRID EXAMPLES

90.1 axes_grid example code: demo_axes_divider.py

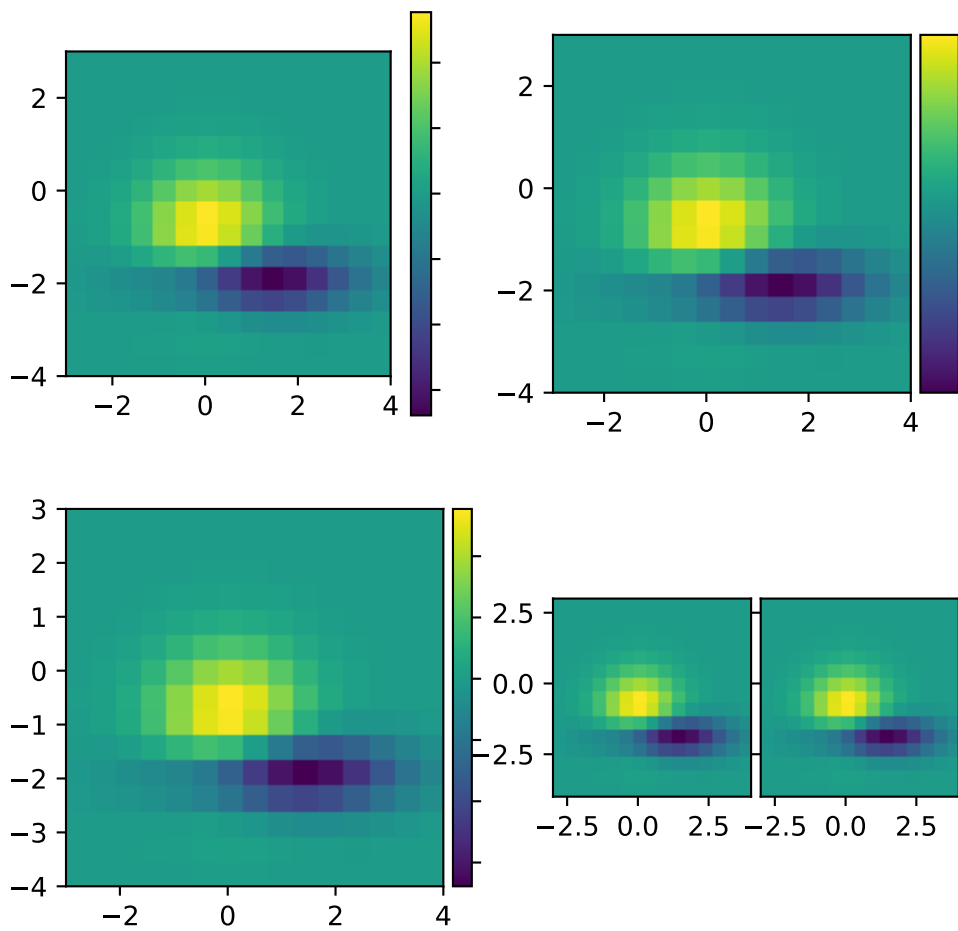

```

import matplotlib.pyplot as plt

def get_demo_image():
    import numpy as np
    from matplotlib.cbook import get_sample_data
    f = get_sample_data("axes_grid/bivariate_normal.npy", asfileobj=False)
    z = np.load(f)
    # z is a numpy array of 15x15
    return z, (-3, 4, -4, 3)

def demo_simple_image(ax):
    Z, extent = get_demo_image()

    im = ax.imshow(Z, extent=extent, interpolation="nearest")
    cb = plt.colorbar(im)
    plt.setp(cb.ax.get_yticklabels(), visible=False)

def demo_locatable_axes_hard(fig1):
    from mpl_toolkits.axes_grid1 \
        import SubplotDivider, LocatableAxes, Size

    divider = SubplotDivider(fig1, 2, 2, 2, aspect=True)

    # axes for image
    ax = LocatableAxes(fig1, divider.get_position())

    # axes for colorbar
    ax_cb = LocatableAxes(fig1, divider.get_position())

    h = [Size.AxesX(ax), # main axes
         Size.Fixed(0.05), # padding, 0.1 inch
         Size.Fixed(0.2), # colorbar, 0.3 inch
        ]

    v = [Size.AxesY(ax)]

    divider.set_horizontal(h)
    divider.set_vertical(v)

    ax.set_axes_locator(divider.new_locator(nx=0, ny=0))
    ax_cb.set_axes_locator(divider.new_locator(nx=2, ny=0))

    fig1.add_axes(ax)
    fig1.add_axes(ax_cb)

    ax_cb.axis["left"].toggle(all=False)
    ax_cb.axis["right"].toggle(ticks=True)

    Z, extent = get_demo_image()

```

```

im = ax.imshow(Z, extent=extent, interpolation="nearest")
plt.colorbar(im, cax=ax_cb)
plt.setp(ax_cb.get_yticklabels(), visible=False)

def demo_locatable_axes_easy(ax):
    from mpl_toolkits.axes_grid1 import make_axes_locatable

    divider = make_axes_locatable(ax)

    ax_cb = divider.new_horizontal(size="5%", pad=0.05)
    fig1 = ax.get_figure()
    fig1.add_axes(ax_cb)

    Z, extent = get_demo_image()
    im = ax.imshow(Z, extent=extent, interpolation="nearest")

    plt.colorbar(im, cax=ax_cb)
    ax_cb.yaxis.tick_right()
    for tl in ax_cb.get_yticklabels():
        tl.set_visible(False)
    ax_cb.yaxis.tick_right()

def demo_images_side_by_side(ax):
    from mpl_toolkits.axes_grid1 import make_axes_locatable

    divider = make_axes_locatable(ax)

    Z, extent = get_demo_image()
    ax2 = divider.new_horizontal(size="100%", pad=0.05)
    fig1 = ax.get_figure()
    fig1.add_axes(ax2)

    ax.imshow(Z, extent=extent, interpolation="nearest")
    ax2.imshow(Z, extent=extent, interpolation="nearest")
    for tl in ax2.get_yticklabels():
        tl.set_visible(False)

def demo():

    fig1 = plt.figure(1, (6, 6))
    fig1.clf()

    # PLOT 1
    # simple image & colorbar
    ax = fig1.add_subplot(2, 2, 1)
    demo_simple_image(ax)

    # PLOT 2
    # image and colorbar whose location is adjusted in the drawing time.

```

```

# a hard way

demo_locatable_axes_hard(fig1)

# PLOT 3
# image and colorbar whose location is adjusted in the drawing time.
# a easy way

ax = fig1.add_subplot(2, 2, 3)
demo_locatable_axes_easy(ax)

# PLOT 4
# two images side by side with fixed padding.

ax = fig1.add_subplot(2, 2, 4)
demo_images_side_by_side(ax)

plt.draw()
plt.show()

demo()

```

Keywords: python, matplotlib, pylab, example, codex (see [Search examples](#))

90.2 axes_grid example code: demo_axes_grid.py

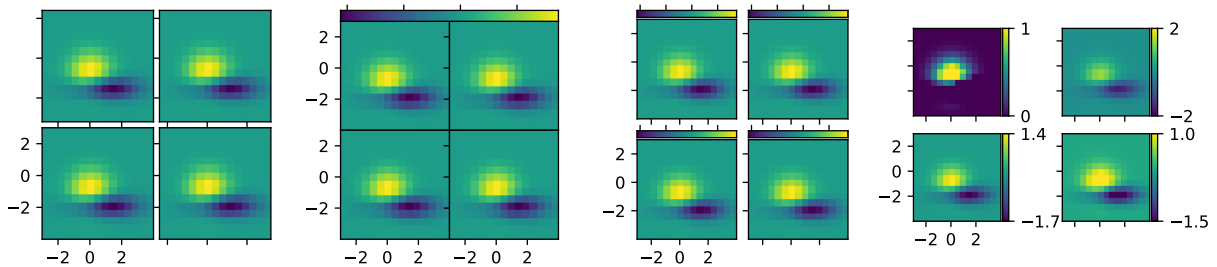

```

import matplotlib.pyplot as plt
from mpl_toolkits.axes_grid1 import AxesGrid

def get_demo_image():
    import numpy as np
    from matplotlib.cbook import get_sample_data
    f = get_sample_data("axes_grid/bivariate_normal.npy", asfileobj=False)
    z = np.load(f)
    # z is a numpy array of 15x15
    return z, (-3, 4, -4, 3)

```

```

def demo_simple_grid(fig):
    """
    A grid of 2x2 images with 0.05 inch pad between images and only
    the lower-left axes is labeled.
    """
    grid = AxesGrid(fig, 141, # similar to subplot(141)
                    nrows_ncols=(2, 2),
                    axes_pad=0.05,
                    label_mode="1",
                    )

    Z, extent = get_demo_image()
    for i in range(4):
        im = grid[i].imshow(Z, extent=extent, interpolation="nearest")

    # This only affects axes in first column and second row as share_all =
    # False.
    grid.axes_llc.set_xticks([-2, 0, 2])
    grid.axes_llc.set_yticks([-2, 0, 2])

def demo_grid_with_single_cbar(fig):
    """
    A grid of 2x2 images with a single colorbar
    """
    grid = AxesGrid(fig, 142, # similar to subplot(142)
                    nrows_ncols=(2, 2),
                    axes_pad=0.0,
                    share_all=True,
                    label_mode="L",
                    cbar_location="top",
                    cbar_mode="single",
                    )

    Z, extent = get_demo_image()
    for i in range(4):
        im = grid[i].imshow(Z, extent=extent, interpolation="nearest")
    #plt.colorbar(im, cax = grid.cbar_axes[0])
    grid.cbar_axes[0].colorbar(im)

    for cax in grid.cbar_axes:
        cax.toggle_label(False)

    # This affects all axes as share_all = True.
    grid.axes_llc.set_xticks([-2, 0, 2])
    grid.axes_llc.set_yticks([-2, 0, 2])

def demo_grid_with_each_cbar(fig):
    """
    A grid of 2x2 images. Each image has its own colorbar.
    """

```

```

grid = AxesGrid(fig, 143, # similar to subplot(143)
                nrows_ncols=(2, 2),
                axes_pad=0.1,
                label_mode="1",
                share_all=True,
                cbar_location="top",
                cbar_mode="each",
                cbar_size="7%",
                cbar_pad="2%",
                )
Z, extent = get_demo_image()
for i in range(4):
    im = grid[i].imshow(Z, extent=extent, interpolation="nearest")
    grid.cbar_axes[i].colorbar(im)

for cax in grid.cbar_axes:
    cax.toggle_label(False)

# This affects all axes because we set share_all = True.
grid.axes_llc.set_xticks([-2, 0, 2])
grid.axes_llc.set_yticks([-2, 0, 2])

def demo_grid_with_each_cbar_labelled(fig):
    """
    A grid of 2x2 images. Each image has its own colorbar.
    """

    grid = AxesGrid(fig, 144, # similar to subplot(144)
                    nrows_ncols=(2, 2),
                    axes_pad=(0.45, 0.15),
                    label_mode="1",
                    share_all=True,
                    cbar_location="right",
                    cbar_mode="each",
                    cbar_size="7%",
                    cbar_pad="2%",
                    )
    Z, extent = get_demo_image()

    # Use a different colorbar range every time
    limits = ((0, 1), (-2, 2), (-1.7, 1.4), (-1.5, 1))
    for i in range(4):
        im = grid[i].imshow(Z, extent=extent, interpolation="nearest",
                            vmin=limits[i][0], vmax=limits[i][1])
        grid.cbar_axes[i].colorbar(im)

    for i, cax in enumerate(grid.cbar_axes):
        cax.set_yticks((limits[i][0], limits[i][1]))

    # This affects all axes because we set share_all = True.
    grid.axes_llc.set_xticks([-2, 0, 2])
    grid.axes_llc.set_yticks([-2, 0, 2])

```

```
if 1:
    F = plt.figure(1, (10.5, 2.5))

    F.subplots_adjust(left=0.05, right=0.95)

    demo_simple_grid(F)
    demo_grid_with_single_cbar(F)
    demo_grid_with_each_cbar(F)
    demo_grid_with_each_cbar_labelled(F)

    plt.draw()
    plt.show()
```

Keywords: python, matplotlib, pylab, example, codex (see [Search examples](#))

90.3 axes_grid example code: demo_axes_grid2.py

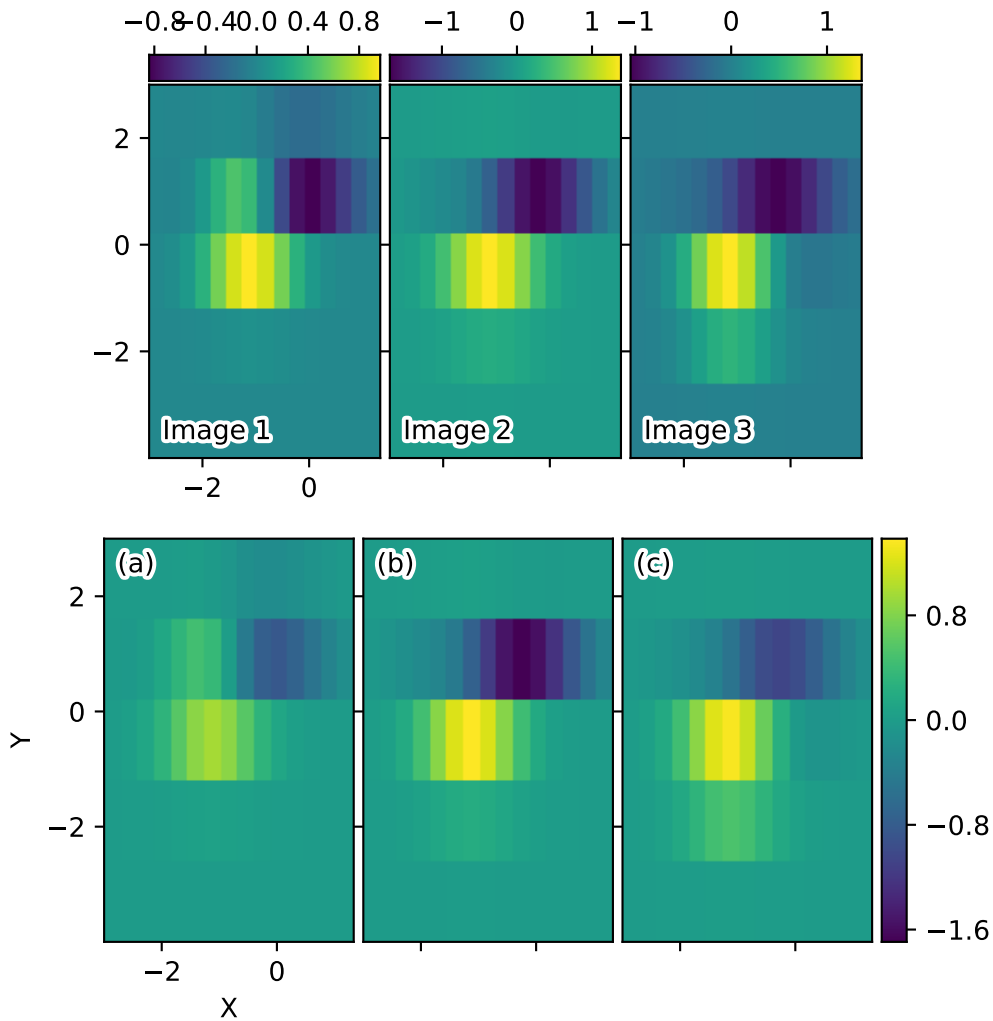

```
import matplotlib.pyplot as plt
from mpl_toolkits.axes_grid1 import ImageGrid
import numpy as np

def get_demo_image():
    from matplotlib.cbook import get_sample_data
    f = get_sample_data("axes_grid/bivariate_normal.npy", asfileobj=False)
    z = np.load(f)
    # z is a numpy array of 15x15
    return z, (-3, 4, -4, 3)
```



```

def add_inner_title(ax, title, loc, size=None, **kwargs):
    from matplotlib.offsetbox import AnchoredText
    from matplotlib.path_effects import withStroke
    if size is None:
        size = dict(size=plt.rcParams['legend.fontsize'])
    at = AnchoredText(title, loc=loc, prop=size,
                      pad=0., borderpad=0.5,
                      frameon=False, **kwargs)
    ax.add_artist(at)
    at.txt._text.set_path_effects([withStroke(foreground="w", linewidth=3)])
    return at

if 1:
    F = plt.figure(1, (6, 6))
    F.clf()

    # prepare images
    Z, extent = get_demo_image()
    ZS = [Z[i::3, :] for i in range(3)]
    extent = extent[0], extent[1]/3., extent[2], extent[3]

    # demo 1 : colorbar at each axes

    grid = ImageGrid(F, 211, # similar to subplot(111)
                     nrows_ncols=(1, 3),
                     direction="row",
                     axes_pad=0.05,
                     add_all=True,
                     label_mode="1",
                     share_all=True,
                     cbar_location="top",
                     cbar_mode="each",
                     cbar_size="7%",
                     cbar_pad="1%",
                     )

    for ax, z in zip(grid, ZS):
        im = ax.imshow(
            z, origin="lower", extent=extent, interpolation="nearest")
        ax.cax.colorbar(im)

    for ax, im_title in zip(grid, ["Image 1", "Image 2", "Image 3"]):
        t = add_inner_title(ax, im_title, loc=3)
        t.patch.set_alpha(0.5)

    for ax, z in zip(grid, ZS):
        ax.cax.toggle_label(True)
        #axis = ax.cax.axis[ax.cax.orientation]
        #axis.label.set_text("counts s^{%-1}$")
        #axis.label.set_size(10)
        #axis.major_ticklabels.set_size(6)

    # changing the colorbar ticks

```

```

grid[1].cax.set_xticks([-1, 0, 1])
grid[2].cax.set_xticks([-1, 0, 1])

grid[0].set_xticks([-2, 0])
grid[0].set_yticks([-2, 0, 2])

# demo 2 : shared colorbar

grid2 = ImageGrid(F, 212,
                  nrows_ncols=(1, 3),
                  direction="row",
                  axes_pad=0.05,
                  add_all=True,
                  label_mode="1",
                  share_all=True,
                  cbar_location="right",
                  cbar_mode="single",
                  cbar_size="10%",
                  cbar_pad=0.05,
                  )

grid2[0].set_xlabel("X")
grid2[0].set_ylabel("Y")

vmax, vmin = np.max(ZS), np.min(ZS)
import matplotlib.colors
norm = matplotlib.colors.Normalize(vmax=vmax, vmin=vmin)

for ax, z in zip(grid2, ZS):
    im = ax.imshow(z, norm=norm,
                  origin="lower", extent=extent,
                  interpolation="nearest")

# With cbar_mode="single", cax attribute of all axes are identical.
ax.cax.colorbar(im)
ax.cax.toggle_label(True)

for ax, im_title in zip(grid2, ["(a)", "(b)", "(c)"]):
    t = add_inner_title(ax, im_title, loc=2)
    t.patch.set_ec("none")
    t.patch.set_alpha(0.5)

grid2[0].set_xticks([-2, 0])
grid2[0].set_yticks([-2, 0, 2])

plt.draw()
plt.show()

```

Keywords: python, matplotlib, pylab, example, codex (see [Search examples](#))

90.4 axes_grid example code: demo_axes_hbox_divider.py

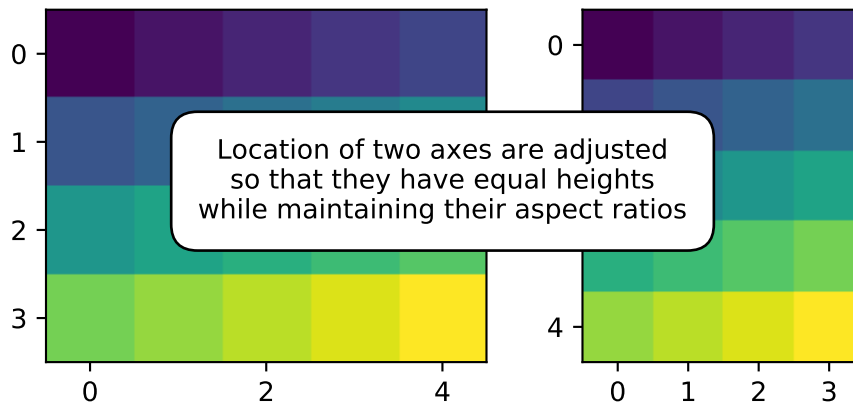

```

import numpy as np
import matplotlib.pyplot as plt
from mpl_toolkits.axes_grid1.axes_divider import HBoxDivider
import mpl_toolkits.axes_grid1.axes_size as Size

def make_heights_equal(fig, rect, ax1, ax2, pad):
    # pad in inches

    h1, v1 = Size.AxesX(ax1), Size.AxesY(ax1)
    h2, v2 = Size.AxesX(ax2), Size.AxesY(ax2)

    pad_v = Size.Scaled(1)
    pad_h = Size.Fixed(pad)

    my_divider = HBoxDivider(fig, rect,
                              horizontal=[h1, pad_h, h2],
                              vertical=[v1, pad_v, v2])

    ax1.set_axes_locator(my_divider.new_locator(0))
    ax2.set_axes_locator(my_divider.new_locator(2))

```

```
if __name__ == "__main__":

    arr1 = np.arange(20).reshape((4, 5))
    arr2 = np.arange(20).reshape((5, 4))

    fig, (ax1, ax2) = plt.subplots(1, 2)
    ax1.imshow(arr1, interpolation="nearest")
    ax2.imshow(arr2, interpolation="nearest")

    rect = 111 # subplot param for combined axes
    make_heights_equal(fig, rect, ax1, ax2, pad=0.5) # pad in inches

    for ax in [ax1, ax2]:
        ax.locator_params(nbins=4)

    # annotate
    ax3 = plt.axes([0.5, 0.5, 0.001, 0.001], frameon=False)
    ax3.xaxis.set_visible(False)
    ax3.yaxis.set_visible(False)
    ax3.annotate("Location of two axes are adjusted\n"
                "so that they have equal heights\n"
                "while maintaining their aspect ratios", (0.5, 0.5),
                xycoords="axes fraction", va="center", ha="center",
                bbox=dict(boxstyle="round, pad=1", fc="w"))

    plt.show()
```

Keywords: python, matplotlib, pylab, example, codex (see [Search examples](#))

90.5 axes_grid example code: demo_axes_rgb.py

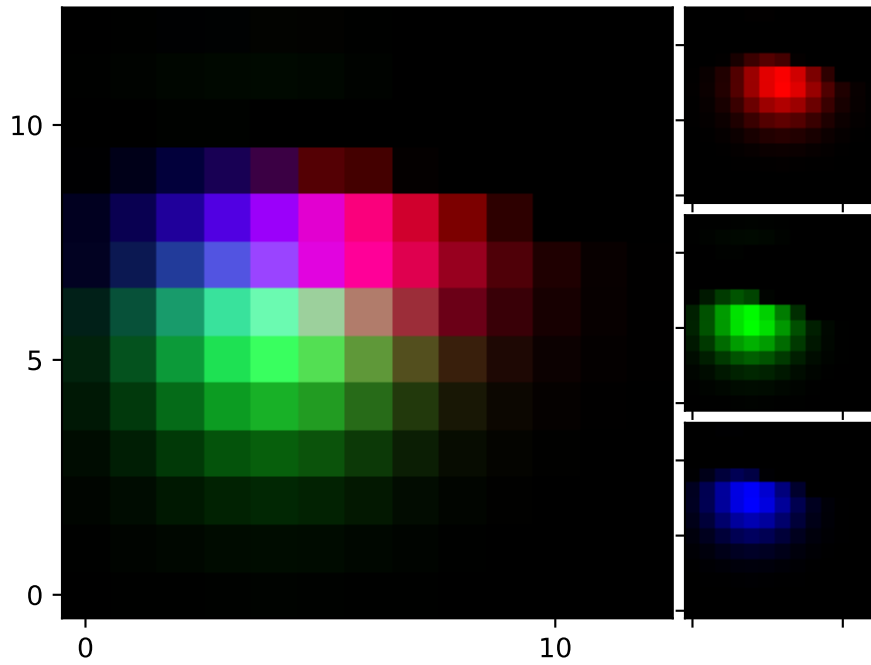

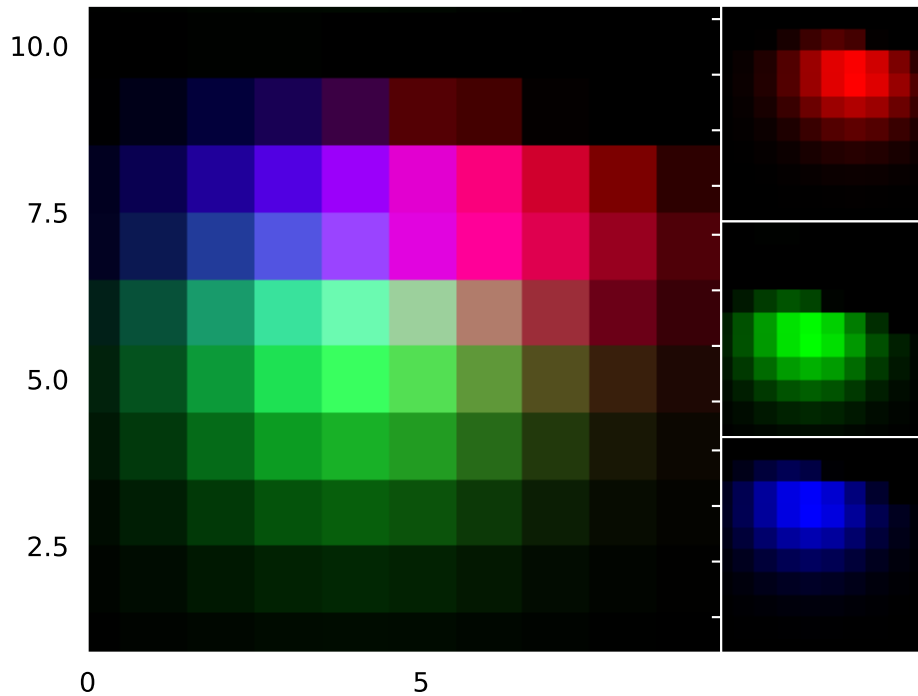

```

import numpy as np
import matplotlib.pyplot as plt

from mpl_toolkits.axes_grid1.axes_rgb import make_rgb_axes, RGBAxes

def get_demo_image():
    from matplotlib.cbook import get_sample_data
    f = get_sample_data("axes_grid/bivariate_normal.npy", asfileobj=False)
    z = np.load(f)
    # z is a numpy array of 15x15
    return z, (-3, 4, -4, 3)

def get_rgb():
    Z, extent = get_demo_image()

    Z[Z < 0] = 0.
    Z = Z/Z.max()

    R = Z[:13, :13]
    G = Z[2:, 2:]
    B = Z[:13, 2:]

    return R, G, B

```

```

def make_cube(r, g, b):
    ny, nx = r.shape
    R = np.zeros([ny, nx, 3], dtype="d")
    R[:, :, 0] = r
    G = np.zeros_like(R)
    G[:, :, 1] = g
    B = np.zeros_like(R)
    B[:, :, 2] = b

    RGB = R + G + B

    return R, G, B, RGB

def demo_rgb():
    fig, ax = plt.subplots()
    ax_r, ax_g, ax_b = make_rgb_axes(ax, pad=0.02)
    #fig.add_axes(ax_r)
    #fig.add_axes(ax_g)
    #fig.add_axes(ax_b)

    r, g, b = get_rgb()
    im_r, im_g, im_b, im_rgb = make_cube(r, g, b)
    kwargs = dict(origin="lower", interpolation="nearest")
    ax.imshow(im_rgb, **kwargs)
    ax_r.imshow(im_r, **kwargs)
    ax_g.imshow(im_g, **kwargs)
    ax_b.imshow(im_b, **kwargs)

def demo_rgb2():
    fig = plt.figure(2)
    ax = RGBAxes(fig, [0.1, 0.1, 0.8, 0.8], pad=0.0)
    #fig.add_axes(ax)
    #ax.add_RGB_to_figure()

    r, g, b = get_rgb()
    kwargs = dict(origin="lower", interpolation="nearest")
    ax.imshow_rgb(r, g, b, **kwargs)

    ax.RGB.set_xlim(0., 9.5)
    ax.RGB.set_ylim(0.9, 10.6)

    for ax1 in [ax.RGB, ax.R, ax.G, ax.B]:
        for sp1 in ax1.spines.values():
            sp1.set_color("w")
        for tick in ax1.xaxis.get_major_ticks() + ax1.yaxis.get_major_ticks():
            tick.tick1line.set_mec("w")
            tick.tick2line.set_mec("w")

    return ax

```

```
demo_rgb()
ax = demo_rgb2()

plt.show()
```

Keywords: python, matplotlib, pylab, example, codex (see [Search examples](#))

90.6 axes_grid example code: demo_axisline_style.py

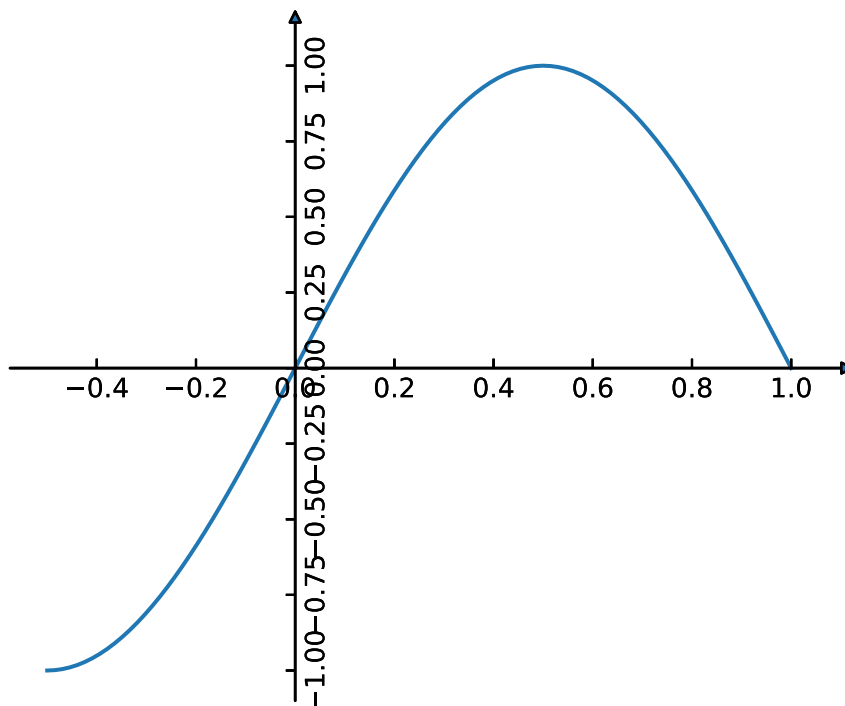

```
from mpl_toolkits.axes_grid.axislines import SubplotZero
import matplotlib.pyplot as plt
import numpy as np

if 1:
    fig = plt.figure(1)
    ax = SubplotZero(fig, 111)
    fig.add_subplot(ax)

    for direction in ["xzero", "yzero"]:
        ax.axis[direction].set_axisline_style("-|>")
        ax.axis[direction].set_visible(True)
```



```

for direction in ["left", "right", "bottom", "top"]:
    ax.axis[direction].set_visible(False)

x = np.linspace(-0.5, 1., 100)
ax.plot(x, np.sin(x*np.pi))

plt.show()

```

Keywords: python, matplotlib, pylab, example, codex (see [Search examples](#))

90.7 axes_grid example code: demo_colorbar_with_inset_locator.py

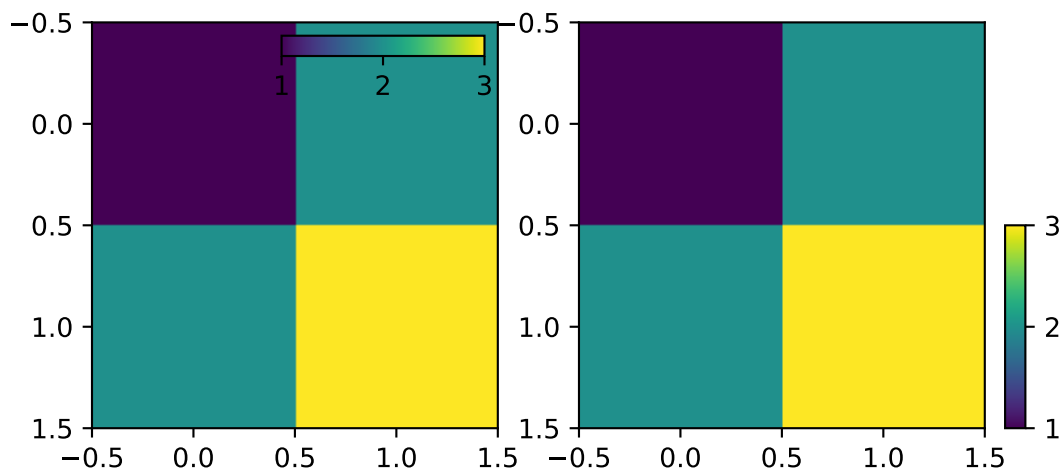

```

import matplotlib.pyplot as plt

from mpl_toolkits.axes_grid1.inset_locator import inset_axes

fig, (ax1, ax2) = plt.subplots(1, 2, figsize=[6, 3])

axins1 = inset_axes(ax1,
                    width="50%", # width = 10% of parent_bbox width
                    height="5%", # height : 50%
                    loc=1)

im1 = ax1.imshow([[1, 2], [2, 3]])
plt.colorbar(im1, cax=axins1, orientation="horizontal", ticks=[1, 2, 3])
axins1.xaxis.set_ticks_position("bottom")

axins = inset_axes(ax2,
                  width="5%", # width = 10% of parent_bbox width
                  height="50%", # height : 50%

```

```

        loc=3,
        bbox_to_anchor=(1.05, 0., 1, 1),
        bbox_transform=ax2.transAxes,
        borderpad=0,
    )

# Controlling the placement of the inset axes is basically same as that
# of the legend. you may want to play with the borderpad value and
# the bbox_to_anchor coordinate.

im = ax2.imshow([[1, 2], [2, 3]])
plt.colorbar(im, cax=axins, ticks=[1, 2, 3])

plt.draw()
plt.show()

```

Keywords: python, matplotlib, pylab, example, codex (see [Search examples](#))

90.8 axes_grid example code: demo_curvelinear_grid.py

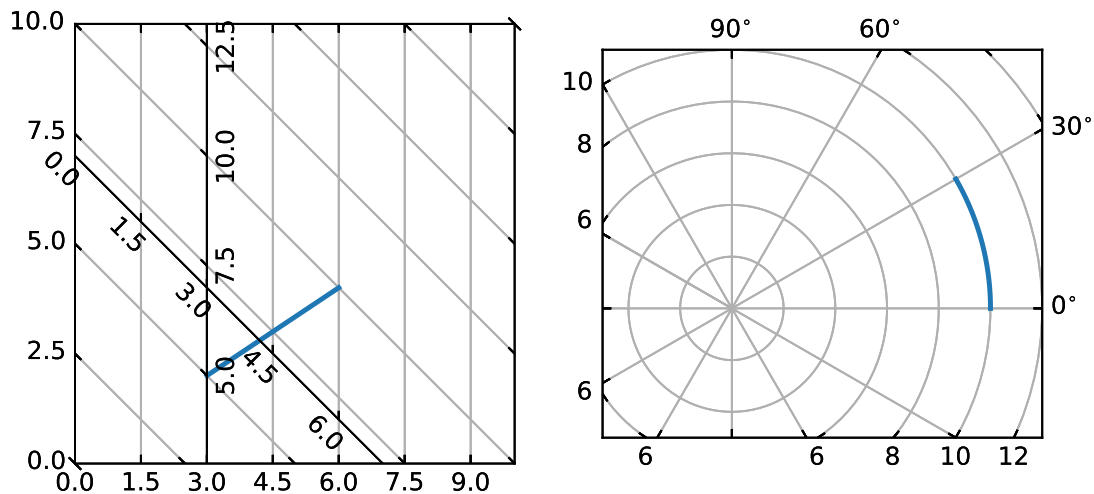

```

"""
Custom grid and ticklines.

This example demonstrates how to use GridHelperCurveLinear to define
custom grids and ticklines by applying a transformation on the grid.
This can be used, as showcase on the second plot, to create polar
projections in a rectangular box.

```

```

"""

import numpy as np

import matplotlib.pyplot as plt
import matplotlib.cbook as cbook

from mpl_toolkits.axisartist import Subplot
from mpl_toolkits.axisartist import SubplotHost, \
    ParasiteAxesAuxTrans
from mpl_toolkits.axisartist.grid_helper_curvelinear import \
    GridHelperCurveLinear

def curvelinear_test1(fig):
    """
    grid for custom transform.
    """

    def tr(x, y):
        x, y = np.asarray(x), np.asarray(y)
        return x, y - x

    def inv_tr(x, y):
        x, y = np.asarray(x), np.asarray(y)
        return x, y + x

    grid_helper = GridHelperCurveLinear((tr, inv_tr))

    ax1 = Subplot(fig, 1, 2, 1, grid_helper=grid_helper)
    # ax1 will have a ticks and gridlines defined by the given
    # transform (+ transData of the Axes). Note that the transform of
    # the Axes itself (i.e., transData) is not affected by the given
    # transform.

    fig.add_subplot(ax1)

    xx, yy = tr([3, 6], [5.0, 10.])
    ax1.plot(xx, yy, linewidth=2.0)

    ax1.set_aspect(1.)
    ax1.set_xlim(0, 10.)
    ax1.set_ylim(0, 10.)

    ax1.axis["t"] = ax1.new_floating_axis(0, 3.)
    ax1.axis["t2"] = ax1.new_floating_axis(1, 7.)
    ax1.grid(True, zorder=0)

import mpl_toolkits.axisartist.angle_helper as angle_helper

from matplotlib.projections import PolarAxes
from matplotlib.transforms import Affine2D

```

```

def curvilinear_test2(fig):
    """
    polar projection, but in a rectangular box.
    """

    # PolarAxes.PolarTransform takes radian. However, we want our coordinate
    # system in degree
    tr = Affine2D().scale(np.pi/180., 1.) + PolarAxes.PolarTransform()

    # polar projection, which involves cycle, and also has limits in
    # its coordinates, needs a special method to find the extremes
    # (min, max of the coordinate within the view).

    # 20, 20 : number of sampling points along x, y direction
    extreme_finder = angle_helper.ExtremeFinderCycle(20, 20,
                                                    lon_cycle=360,
                                                    lat_cycle=None,
                                                    lon_minmax=None,
                                                    lat_minmax=(0, np.inf),
                                                    )

    grid_locator1 = angle_helper.LocatorDMS(12)
    # Find a grid values appropriate for the coordinate (degree,
    # minute, second).

    tick_formatter1 = angle_helper.FormatterDMS()
    # And also uses an appropriate formatter. Note that, the
    # acceptable Locator and Formatter class is a bit different than
    # that of mpl's, and you cannot directly use mpl's Locator and
    # Formatter here (but may be possible in the future).

    grid_helper = GridHelperCurveLinear(tr,
                                       extreme_finder=extreme_finder,
                                       grid_locator1=grid_locator1,
                                       tick_formatter1=tick_formatter1
                                       )

    ax1 = SubplotHost(fig, 1, 2, 2, grid_helper=grid_helper)

    # make ticklabels of right and top axis visible.
    ax1.axis["right"].major_ticklabels.set_visible(True)
    ax1.axis["top"].major_ticklabels.set_visible(True)

    # let right axis shows ticklabels for 1st coordinate (angle)
    ax1.axis["right"].get_helper().nth_coord_ticks = 0
    # let bottom axis shows ticklabels for 2nd coordinate (radius)
    ax1.axis["bottom"].get_helper().nth_coord_ticks = 1

    fig.add_subplot(ax1)

    # A parasite axes with given transform

```

```
ax2 = ParasiteAxesAuxTrans(ax1, tr, "equal")
# note that ax2.transData == tr + ax1.transData
# Anything you draw in ax2 will match the ticks and grids of ax1.
ax1.parasites.append(ax2)
intp = cbook.simple_linear_interpolation
ax2.plot(intp(np.array([0, 30]), 50),
         intp(np.array([10., 10.]), 50),
         linewidth=2.0)

ax1.set_aspect(1.)
ax1.set_xlim(-5, 12)
ax1.set_ylim(-5, 10)

ax1.grid(True, zorder=0)

if 1:
    fig = plt.figure(1, figsize=(7, 4))
    fig.clf()

    curvelinear_test1(fig)
    curvelinear_test2(fig)

    plt.draw()
    plt.show()
```

Keywords: python, matplotlib, pylab, example, codex (see [Search examples](#))

90.9 axes_grid example code: demo_curvelinear_grid2.py

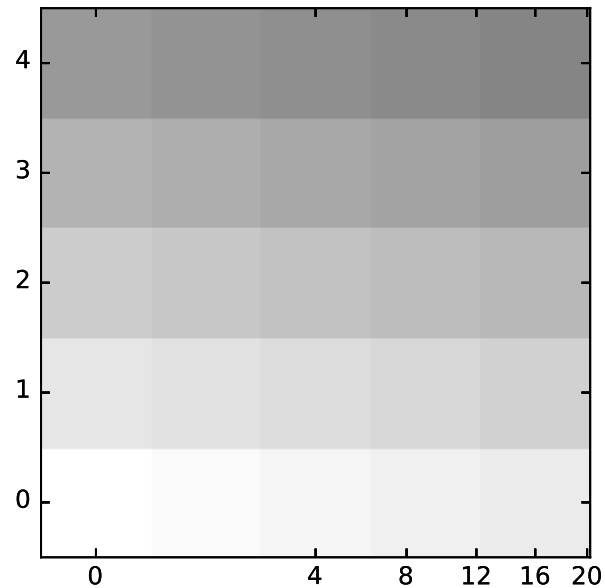

```

"""
Custom grid and ticklines.

This example demonstrates how to use GridHelperCurveLinear to define
custom grids and ticklines by applying a transformation on the grid.
As showcase on the plot, a 5x5 matrix is displayed on the axes.
"""

import numpy as np
import matplotlib.pyplot as plt

from mpl_toolkits.axes_grid.grid_helper_curvelinear import \
    GridHelperCurveLinear
from mpl_toolkits.axes_grid.axislines import Subplot

import mpl_toolkits.axes_grid.angle_helper as angle_helper

def curvelinear_test1(fig):
    """
    grid for custom transform.
    """

    def tr(x, y):
        sgn = np.sign(x)
        x, y = np.abs(np.asarray(x)), np.asarray(y)
        return sgn*x**.5, y

```

```

def inv_tr(x, y):
    sgn = np.sign(x)
    x, y = np.asarray(x), np.asarray(y)
    return sgn*x**2, y

extreme_finder = angle_helper.ExtremeFinderCycle(20, 20,
                                                  lon_cycle=None,
                                                  lat_cycle=None,
                                                  # (0, np.inf),
                                                  lon_minmax=None,
                                                  lat_minmax=None,
                                                  )

grid_helper = GridHelperCurveLinear((tr, inv_tr),
                                    extreme_finder=extreme_finder)

ax1 = Subplot(fig, 111, grid_helper=grid_helper)
# ax1 will have a ticks and gridlines defined by the given
# transform (+ transData of the Axes). Note that the transform of
# the Axes itself (i.e., transData) is not affected by the given
# transform.

fig.add_subplot(ax1)

ax1.imshow(np.arange(25).reshape(5, 5),
           vmax=50, cmap=plt.cm.gray_r,
           interpolation="nearest",
           origin="lower")

# tick density
grid_helper.grid_finder.grid_locator1._nbins = 6
grid_helper.grid_finder.grid_locator2._nbins = 6

if 1:
    fig = plt.figure(1, figsize=(7, 4))
    fig.clf()

    curvelinear_test1(fig)
    plt.show()

```

Keywords: python, matplotlib, pylab, example, codex (see [Search examples](#))

90.10 axes_grid example code: demo_edge_colorbar.py

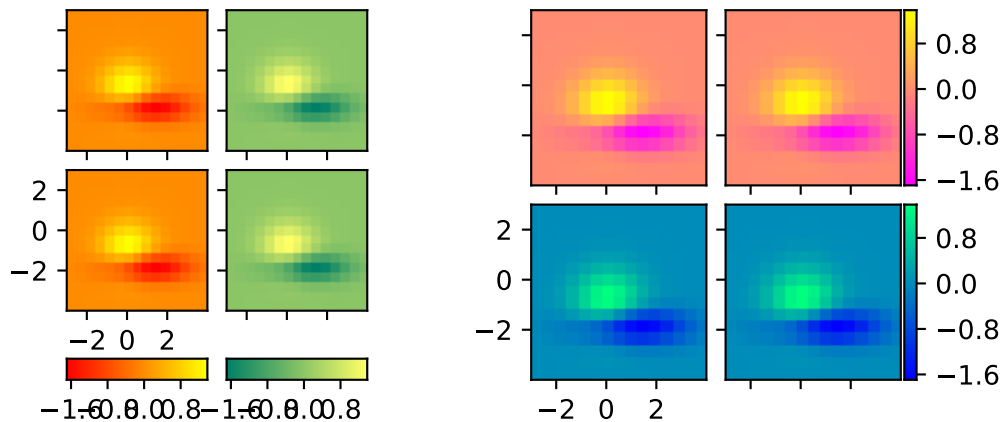

```
import matplotlib.pyplot as plt
from mpl_toolkits.axes_grid1 import AxesGrid

def get_demo_image():
    import numpy as np
    from matplotlib.cbook import get_sample_data
    f = get_sample_data("axes_grid/bivariate_normal.npy", asfileobj=False)
    z = np.load(f)
    # z is a numpy array of 15x15
    return z, (-3, 4, -4, 3)

def demo_bottom_cbar(fig):
    """
    A grid of 2x2 images with a colorbar for each column.
    """
    grid = AxesGrid(fig, 121, # similar to subplot(132)
                    nrows_ncols=(2, 2),
                    axes_pad=0.10,
                    share_all=True,
                    label_mode="1",
                    cbar_location="bottom",
                    cbar_mode="edge",
                    cbar_pad=0.25,
                    cbar_size="15%",
                    direction="column"
                    )

    Z, extent = get_demo_image()
    cmaps = [plt.get_cmap("autumn"), plt.get_cmap("summer")]
    for i in range(4):
        im = grid[i].imshow(Z, extent=extent, interpolation="nearest",
                            cmap=cmaps[i//2])
        if i % 2:

```



```

        cbar = grid.cbar_axes[i//2].colorbar(im)

    for cax in grid.cbar_axes:
        cax.toggle_label(True)
        cax.axis[cax.orientation].set_label("Bar")

# This affects all axes as share_all = True.
    grid.axes_llc.set_xticks([-2, 0, 2])
    grid.axes_llc.set_yticks([-2, 0, 2])

def demo_right_cbar(fig):
    """
    A grid of 2x2 images. Each row has its own colorbar.
    """

    grid = AxesGrid(F, 122, # similar to subplot(122)
                    nrows_ncols=(2, 2),
                    axes_pad=0.10,
                    label_mode="1",
                    share_all=True,
                    cbar_location="right",
                    cbar_mode="edge",
                    cbar_size="7%",
                    cbar_pad="2%",
                    )
    Z, extent = get_demo_image()
    cmaps = [plt.get_cmap("spring"), plt.get_cmap("winter")]
    for i in range(4):
        im = grid[i].imshow(Z, extent=extent, interpolation="nearest",
                            cmap=cmaps[i//2])

        if i % 2:
            grid.cbar_axes[i//2].colorbar(im)

    for cax in grid.cbar_axes:
        cax.toggle_label(True)
        cax.axis[cax.orientation].set_label('Foo')

    # This affects all axes because we set share_all = True.
    grid.axes_llc.set_xticks([-2, 0, 2])
    grid.axes_llc.set_yticks([-2, 0, 2])

if 1:
    F = plt.figure(1, (5.5, 2.5))

    F.subplots_adjust(left=0.05, right=0.93)

    demo_bottom_cbar(F)
    demo_right_cbar(F)

    plt.draw()
    plt.show()

```

Keywords: python, matplotlib, pylab, example, codex (see [Search examples](#))

90.11 axes_grid example code: demo_floating_axes.py

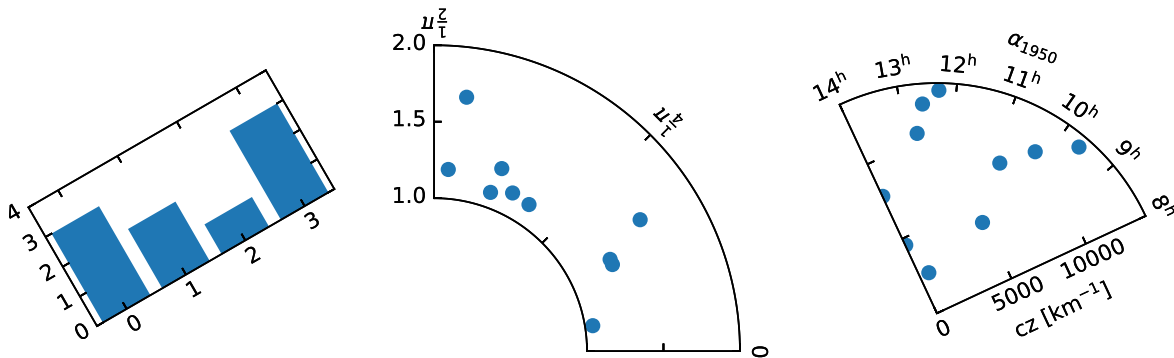

```

"""
Demo of the floating axes.

This demo shows features of functions in floating_axes:
* Using scatter function and bar function with changing the
  shape of the plot.
* Using GridHelperCurveLinear to rotate the plot and set the
  boundary of the plot.
* Using FloatingSubplot to create a subplot using the return
  value from GridHelperCurveLinear.
* Making sector plot by adding more features to GridHelperCurveLinear.
"""
from matplotlib.transforms import Affine2D
import mpl_toolkits.axisartist.floating_axes as floating_axes
import numpy as np
import mpl_toolkits.axisartist.angle_helper as angle_helper
from matplotlib.projections import PolarAxes
from mpl_toolkits.axisartist.grid_finder import (FixedLocator, MaxNLocator,
                                                DictFormatter)

import matplotlib.pyplot as plt

def setup_axes1(fig, rect):
    """
    A simple one.
    """
    tr = Affine2D().scale(2, 1).rotate_deg(30)

```

```

grid_helper = floating_axes.GridHelperCurveLinear(
    tr, extremes=(-0.5, 3.5, 0, 4))

ax1 = floating_axes.FloatingSubplot(fig, rect, grid_helper=grid_helper)
fig.add_subplot(ax1)

aux_ax = ax1.get_aux_axes(tr)

grid_helper.grid_finder.grid_locator1._nbins = 4
grid_helper.grid_finder.grid_locator2._nbins = 4

return ax1, aux_ax

def setup_axes2(fig, rect):
    """
    With custom locator and formatter.
    Note that the extreme values are swapped.
    """
    tr = PolarAxes.PolarTransform()

    pi = np.pi
    angle_ticks = [(0, r"$0$"),
                   (.25*pi, r"$\frac{1}{4}\pi$"),
                   (.5*pi, r"$\frac{1}{2}\pi$")]
    grid_locator1 = FixedLocator([v for v, s in angle_ticks])
    tick_formatter1 = DictFormatter(dict(angle_ticks))

    grid_locator2 = MaxNLocator(2)

    grid_helper = floating_axes.GridHelperCurveLinear(
        tr, extremes=(.5*pi, 0, 2, 1),
        grid_locator1=grid_locator1,
        grid_locator2=grid_locator2,
        tick_formatter1=tick_formatter1,
        tick_formatter2=None)

    ax1 = floating_axes.FloatingSubplot(fig, rect, grid_helper=grid_helper)
    fig.add_subplot(ax1)

    # create a parasite axes whose transData in RA, cz
    aux_ax = ax1.get_aux_axes(tr)

    aux_ax.patch = ax1.patch # for aux_ax to have a clip path as in ax
    ax1.patch.zorder = 0.9 # but this has a side effect that the patch is
    # drawn twice, and possibly over some other
    # artists. So, we decrease the zorder a bit to
    # prevent this.

    return ax1, aux_ax

```

```

def setup_axes3(fig, rect):
    """
    Sometimes, things like axis_direction need to be adjusted.
    """

    # rotate a bit for better orientation
    tr_rotate = Affine2D().translate(-95, 0)

    # scale degree to radians
    tr_scale = Affine2D().scale(np.pi/180., 1.)

    tr = tr_rotate + tr_scale + PolarAxes.PolarTransform()

    grid_locator1 = angle_helper.LocatorHMS(4)
    tick_formatter1 = angle_helper.FormatterHMS()

    grid_locator2 = MaxNLocator(3)

    ra0, ra1 = 8.*15, 14.*15
    cz0, cz1 = 0, 14000
    grid_helper = floating_axes.GridHelperCurveLinear(
        tr, extremes=(ra0, ra1, cz0, cz1),
        grid_locator1=grid_locator1,
        grid_locator2=grid_locator2,
        tick_formatter1=tick_formatter1,
        tick_formatter2=None)

    ax1 = floating_axes.FloatingSubplot(fig, rect, grid_helper=grid_helper)
    fig.add_subplot(ax1)

    # adjust axis
    ax1.axis["left"].set_axis_direction("bottom")
    ax1.axis["right"].set_axis_direction("top")

    ax1.axis["bottom"].set_visible(False)
    ax1.axis["top"].set_axis_direction("bottom")
    ax1.axis["top"].toggle(ticklabels=True, label=True)
    ax1.axis["top"].major_ticklabels.set_axis_direction("top")
    ax1.axis["top"].label.set_axis_direction("top")

    ax1.axis["left"].label.set_text(r"cz [km-1}")
    ax1.axis["top"].label.set_text(r"$\alpha_{1950}$")

    # create a parasite axes whose transData in RA, cz
    aux_ax = ax1.get_aux_axes(tr)

    aux_ax.patch = ax1.patch # for aux_ax to have a clip path as in ax
    ax1.patch.zorder = 0.9 # but this has a side effect that the patch is
    # drawn twice, and possibly over some other
    # artists. So, we decrease the zorder a bit to
    # prevent this.

    return ax1, aux_ax

```

```
#####  
fig = plt.figure(1, figsize=(8, 4))  
fig.subplots_adjust(wspace=0.3, left=0.05, right=0.95)  
  
ax1, aux_ax1 = setup_axes1(fig, 131)  
aux_ax1.bar([0, 1, 2, 3], [3, 2, 1, 3])  
  
ax2, aux_ax2 = setup_axes2(fig, 132)  
theta = np.random.rand(10)*.5*np.pi  
radius = np.random.rand(10) + 1.  
aux_ax2.scatter(theta, radius)  
  
ax3, aux_ax3 = setup_axes3(fig, 133)  
  
theta = (8 + np.random.rand(10)*(14 - 8))*15. # in degrees  
radius = np.random.rand(10)*14000.  
aux_ax3.scatter(theta, radius)  
  
plt.show()
```

Keywords: python, matplotlib, pylab, example, codex (see [Search examples](#))

90.12 axes_grid example code: demo_floating_axis.py

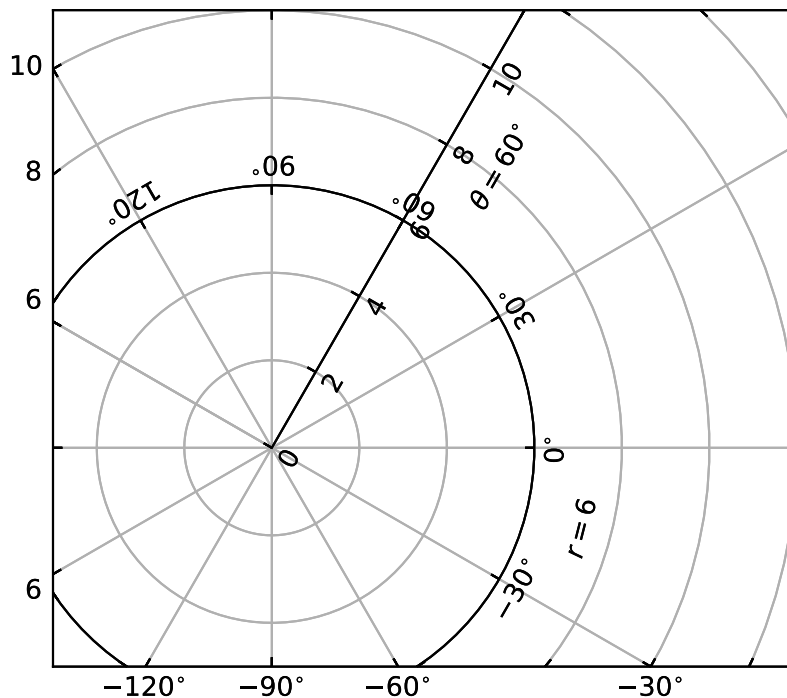

```

"""
Axis within rectangular frame

The following code demonstrates how to put a floating polar curve within a
rectangular box. In order to get a better sense of polar curves, please look at
demo_curvelinear_grid.py.
"""
import numpy as np
import matplotlib.pyplot as plt
import mpl_toolkits.axisartist.angle_helper as angle_helper
from matplotlib.projections import PolarAxes
from matplotlib.transforms import Affine2D
from mpl_toolkits.axisartist import SubplotHost
from mpl_toolkits.axisartist import GridHelperCurveLinear

def curvelinear_test2(fig):
    """
    polar projection, but in a rectangular box.

```

```

"""
global ax1
# see demo_curvelinear_grid.py for details
tr = Affine2D().scale(np.pi / 180., 1.) + PolarAxes.PolarTransform()

extreme_finder = angle_helper.ExtremeFinderCycle(20,
                                                  20,
                                                  lon_cycle=360,
                                                  lat_cycle=None,
                                                  lon_minmax=None,
                                                  lat_minmax=(0,
                                                            np.inf),
                                                  )

grid_locator1 = angle_helper.LocatorDMS(12)

tick_formatter1 = angle_helper.FormatterDMS()

grid_helper = GridHelperCurveLinear(tr,
                                    extreme_finder=extreme_finder,
                                    grid_locator1=grid_locator1,
                                    tick_formatter1=tick_formatter1
                                    )

ax1 = SubplotHost(fig, 1, 1, 1, grid_helper=grid_helper)

fig.add_subplot(ax1)

# Now creates floating axis

# floating axis whose first coordinate (theta) is fixed at 60
ax1.axis["lat"] = axis = ax1.new_floating_axis(0, 60)
axis.label.set_text(r"$\theta = 60^\{\circ}$")
axis.label.set_visible(True)

# floating axis whose second coordinate (r) is fixed at 6
ax1.axis["lon"] = axis = ax1.new_floating_axis(1, 6)
axis.label.set_text(r"$r = 6$")

ax1.set_aspect(1.)
ax1.set_xlim(-5, 12)
ax1.set_ylim(-5, 10)

ax1.grid(True)

fig = plt.figure(1, figsize=(5, 5))
fig.clf()

curvelinear_test2(fig)

plt.show()

```

Keywords: python, matplotlib, pylab, example, codex (see [Search examples](#))

90.13 axes_grid example code: demo_imagegrid_aspect.py

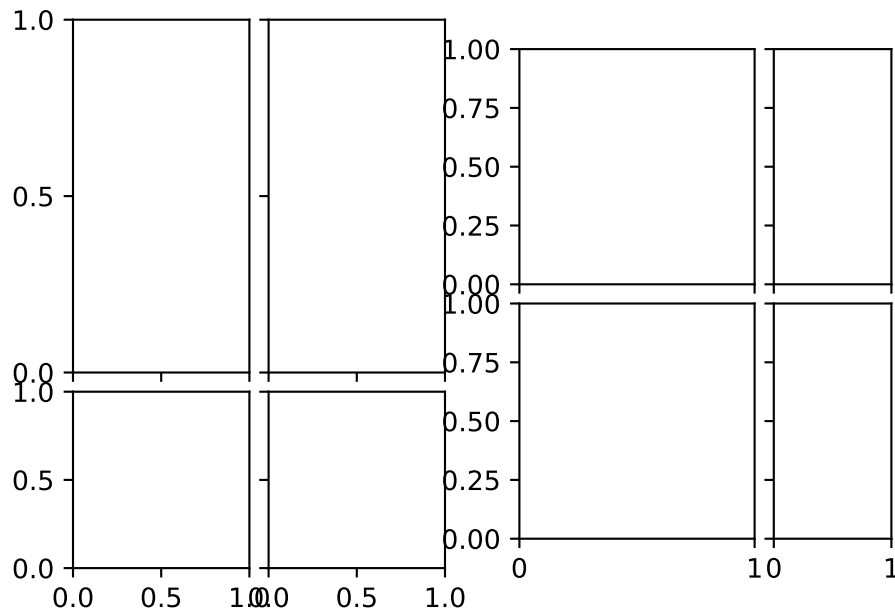

```
import matplotlib.pyplot as plt

from mpl_toolkits.axes_grid1 import ImageGrid
fig = plt.figure(1)

grid1 = ImageGrid(fig, 121, (2, 2), axes_pad=0.1,
                  aspect=True, share_all=True)

for i in [0, 1]:
    grid1[i].set_aspect(2)

grid2 = ImageGrid(fig, 122, (2, 2), axes_pad=0.1,
                  aspect=True, share_all=True)

for i in [1, 3]:
    grid2[i].set_aspect(2)

plt.show()
```

Keywords: python, matplotlib, pylab, example, codex (see [Search examples](#))

90.14 axes_grid example code: demo_parasite_axes2.py

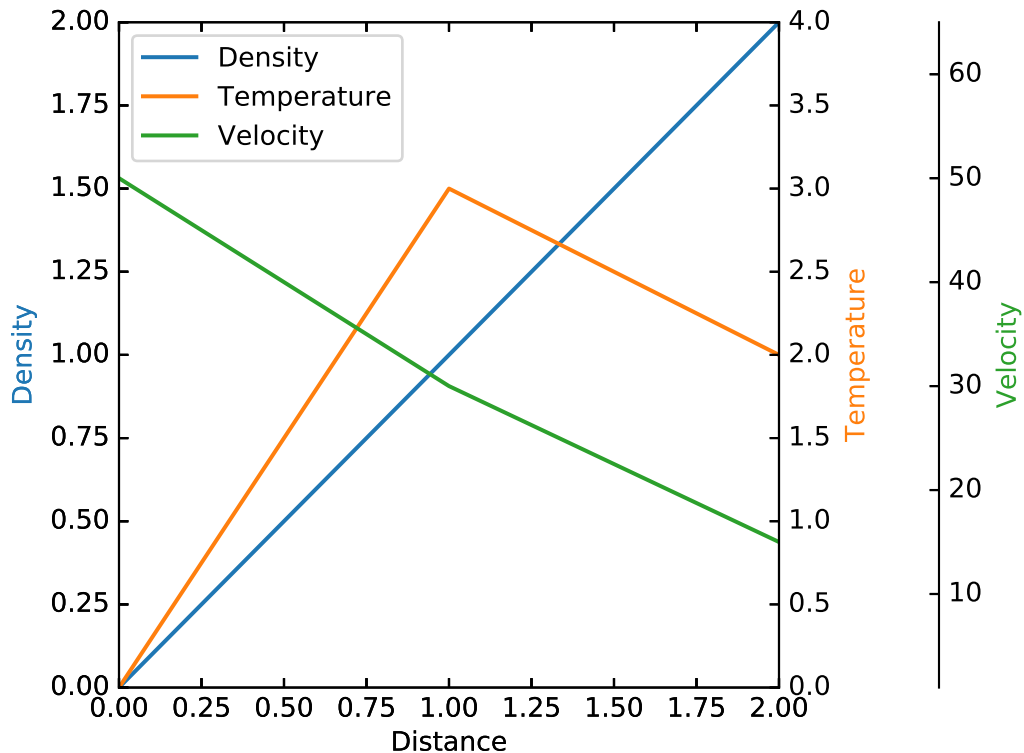

```

"""
Parasite axis demo

The following code is an example of a parasite axis. It aims to show a user how
to plot multiple different values onto one single plot. Notice how in this
example, par1 and par2 are both calling twinx meaning both are tied directly to
the x-axis. From there, each of those two axis can behave separately from the
each other, meaning they can take on separate values from themselves as well as
the x-axis.
"""
from mpl_toolkits.axes_grid1 import host_subplot
import mpl_toolkits.axisartist as AA
import matplotlib.pyplot as plt

host = host_subplot(111, axes_class=AA.Axes)
plt.subplots_adjust(right=0.75)

par1 = host.twinx()
par2 = host.twinx()

offset = 60
new_fixed_axis = par2.get_grid_helper().new_fixed_axis

```

```
par2.axis["right"] = new_fixed_axis(loc="right",
                                   axes=par2,
                                   offset=(offset, 0))

par2.axis["right"].toggle(all=True)

host.set_xlim(0, 2)
host.set_ylim(0, 2)

host.set_xlabel("Distance")
host.set_ylabel("Density")
par1.set_ylabel("Temperature")
par2.set_ylabel("Velocity")

p1, = host.plot([0, 1, 2], [0, 1, 2], label="Density")
p2, = par1.plot([0, 1, 2], [0, 3, 2], label="Temperature")
p3, = par2.plot([0, 1, 2], [50, 30, 15], label="Velocity")

par1.set_ylim(0, 4)
par2.set_ylim(1, 65)

host.legend()

host.axis["left"].label.set_color(p1.get_color())
par1.axis["right"].label.set_color(p2.get_color())
par2.axis["right"].label.set_color(p3.get_color())

plt.draw()
plt.show()
```

Keywords: python, matplotlib, pylab, example, codex (see [Search examples](#))

90.15 axes_grid example code: inset_locator_demo.py

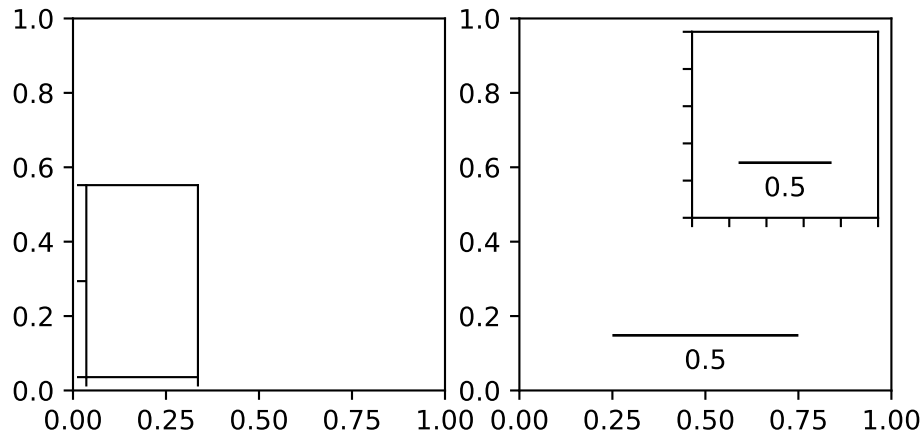

```

import matplotlib.pyplot as plt

from mpl_toolkits.axes_grid1.inset_locator import inset_axes, zoomed_inset_axes
from mpl_toolkits.axes_grid1.anchored_artists import AnchoredSizeBar

def add_sizebar(ax, size):
    asb = AnchoredSizeBar(ax.transData,
                          size,
                          str(size),
                          loc=8,
                          pad=0.1, borderpad=0.5, sep=5,
                          frameon=False)
    ax.add_artist(asb)

fig, (ax, ax2) = plt.subplots(1, 2, figsize=[5.5, 3])

# first subplot
ax.set_aspect(1.)

axins = inset_axes(ax,
                   width="30%", # width = 30% of parent_bbox
                   height=1., # height : 1 inch
                   loc=3)

plt.xticks(visible=False)
plt.yticks(visible=False)

# second subplot

```

```
ax2.set_aspect(1.)

axins = zoomed_inset_axes(ax2, 0.5, loc=1) # zoom = 0.5
# fix the number of ticks on the inset axes
axins.yaxis.get_major_locator().set_params(nbins=7)
axins.xaxis.get_major_locator().set_params(nbins=7)

plt.xticks(visible=False)
plt.yticks(visible=False)

add_sizebar(ax2, 0.5)
add_sizebar(axins, 0.5)

plt.draw()
plt.show()
```

Keywords: python, matplotlib, pylab, example, codex (see [Search examples](#))

90.16 axes_grid example code: inset_locator_demo2.py

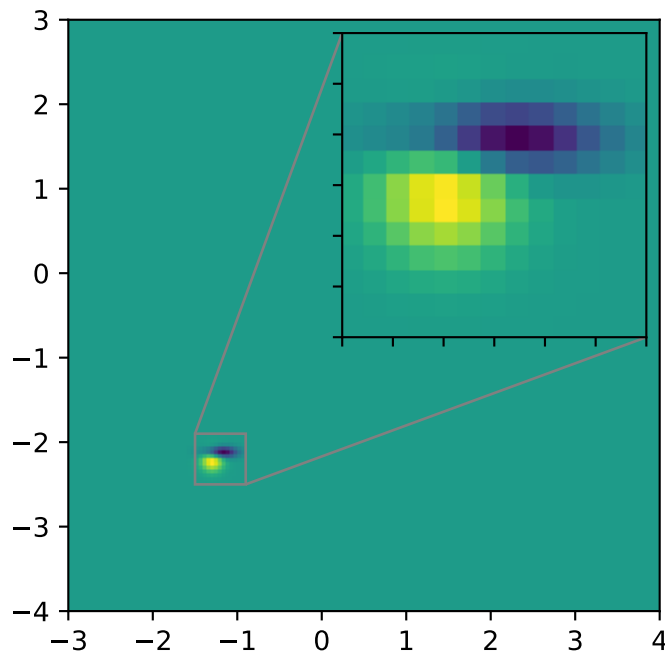

```
import matplotlib.pyplot as plt

from mpl_toolkits.axes_grid1.inset_locator import zoomed_inset_axes
from mpl_toolkits.axes_grid1.inset_locator import mark_inset
```

```

import numpy as np

def get_demo_image():
    from matplotlib.cbook import get_sample_data
    import numpy as np
    f = get_sample_data("axes_grid/bivariate_normal.npy", asfileobj=False)
    z = np.load(f)
    # z is a numpy array of 15x15
    return z, (-3, 4, -4, 3)

fig, ax = plt.subplots(figsize=[5, 4])

# prepare the demo image
Z, extent = get_demo_image()
Z2 = np.zeros([150, 150], dtype="d")
ny, nx = Z.shape
Z2[30:30 + ny, 30:30 + nx] = Z

# extent = [-3, 4, -4, 3]
ax.imshow(Z2, extent=extent, interpolation="nearest",
          origin="lower")

axins = zoomed_inset_axes(ax, 6, loc=1) # zoom = 6
axins.imshow(Z2, extent=extent, interpolation="nearest",
             origin="lower")

# sub region of the original image
x1, x2, y1, y2 = -1.5, -0.9, -2.5, -1.9
axins.set_xlim(x1, x2)
axins.set_ylim(y1, y2)
# fix the number of ticks on the inset axes
axins.yaxis.get_major_locator().set_params(nbins=7)
axins.xaxis.get_major_locator().set_params(nbins=7)

plt.xticks(visible=False)
plt.yticks(visible=False)

# draw a bbox of the region of the inset axes in the parent axes and
# connecting lines between the bbox and the inset axes area
mark_inset(ax, axins, loc1=2, loc2=4, fc="none", ec="0.5")

plt.draw()
plt.show()

```

Keywords: python, matplotlib, pylab, example, codex (see [Search examples](#))

90.17 axes_grid example code: make_room_for_ylabel_using_axesgrid.py

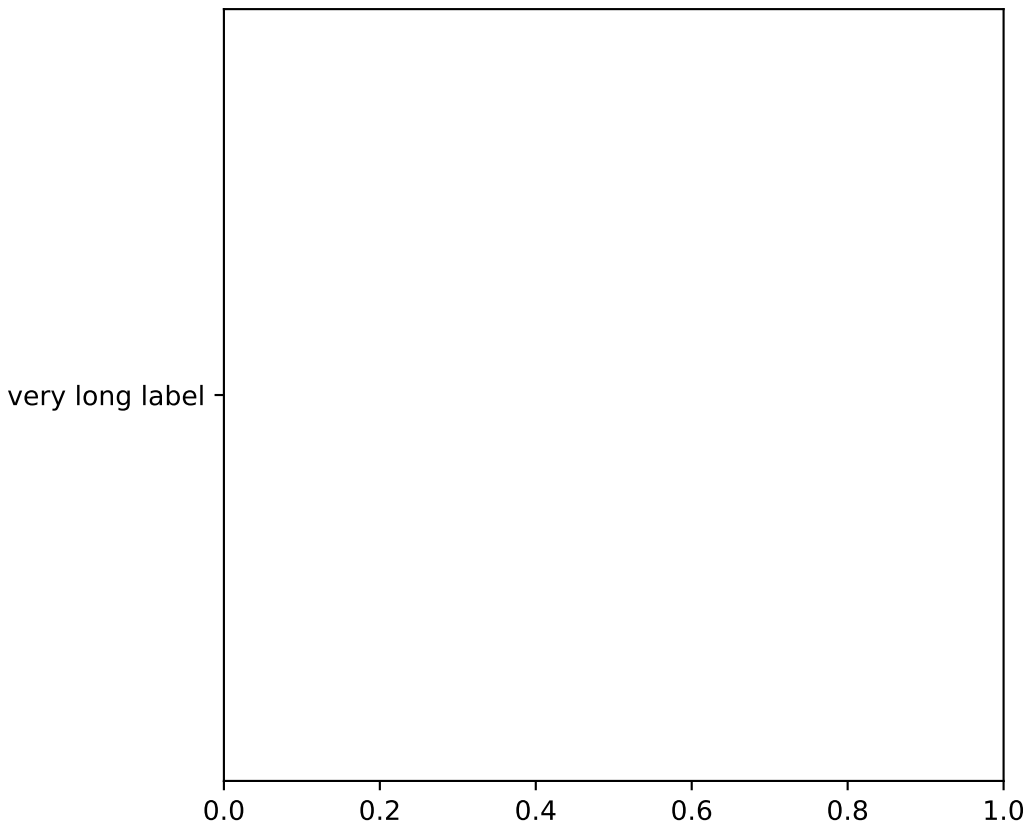

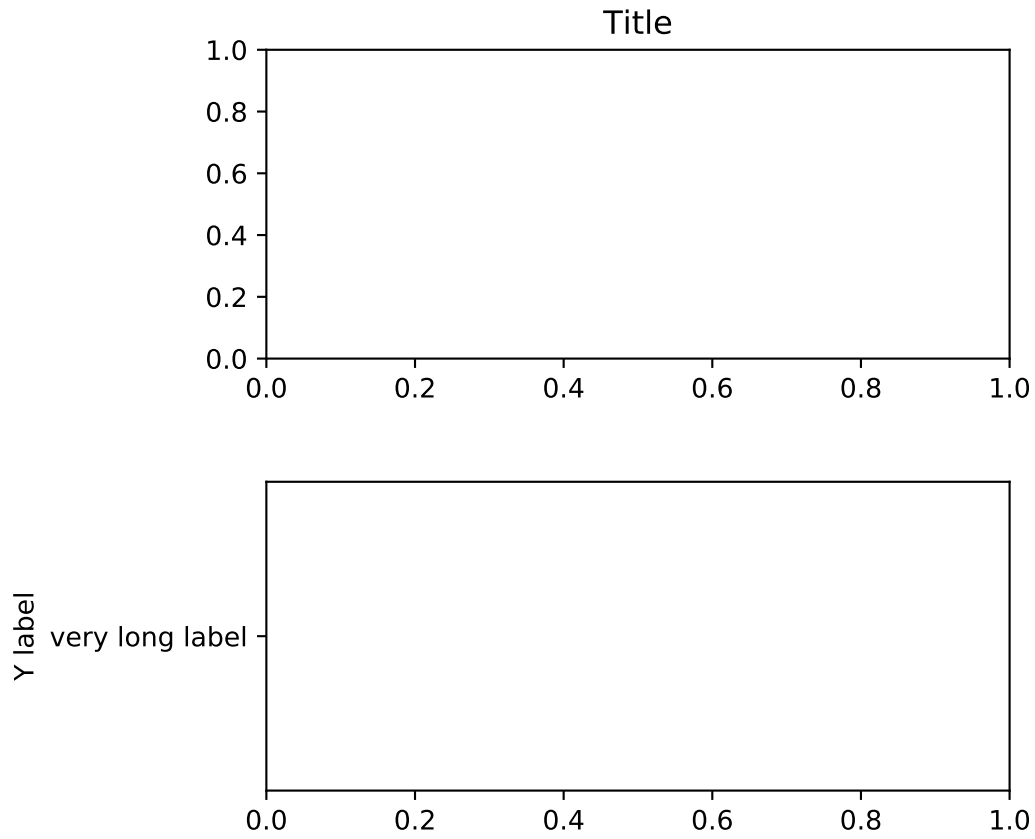

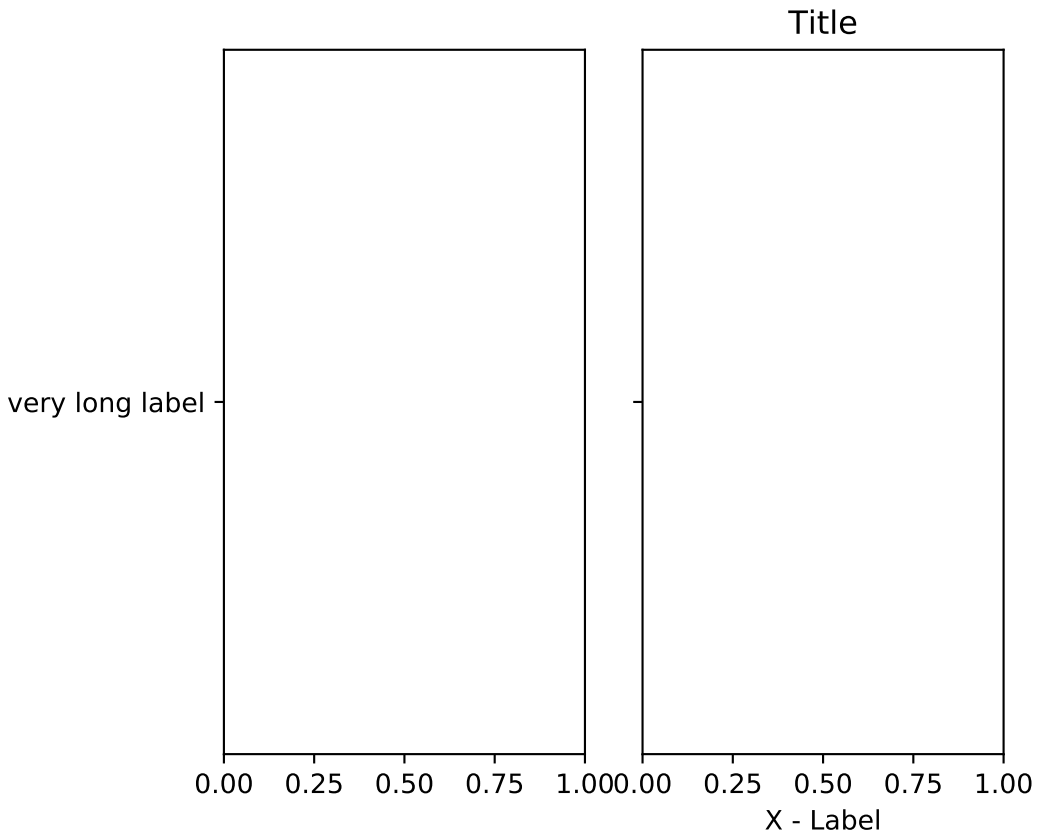

```

from mpl_toolkits.axes_grid1 import make_axes_locatable
from mpl_toolkits.axes_grid1.axes_divider import make_axes_area_auto_adjustable

if __name__ == "__main__":

    import matplotlib.pyplot as plt

    def ex1():
        plt.figure(1)
        ax = plt.axes([0, 0, 1, 1])
        #ax = plt.subplot(111)

        ax.set_yticks([0.5])
        ax.set_yticklabels(["very long label"])

        make_axes_area_auto_adjustable(ax)

    def ex2():

        plt.figure(2)
        ax1 = plt.axes([0, 0, 1, 0.5])
        ax2 = plt.axes([0, 0.5, 1, 0.5])

        ax1.set_yticks([0.5])
        ax1.set_yticklabels(["very long label"])

```



```
ax1.set_ylabel("Y label")

ax2.set_title("Title")

make_axes_area_auto_adjustable(ax1, pad=0.1, use_axes=[ax1, ax2])
make_axes_area_auto_adjustable(ax2, pad=0.1, use_axes=[ax1, ax2])

def ex3():

    fig = plt.figure(3)
    ax1 = plt.axes([0, 0, 1, 1])
    divider = make_axes_locatable(ax1)

    ax2 = divider.new_horizontal("100%", pad=0.3, sharey=ax1)
    ax2.tick_params(labelleft="off")
    fig.add_axes(ax2)

    divider.add_auto_adjustable_area(use_axes=[ax1], pad=0.1,
                                     adjust_dirs=["left"])
    divider.add_auto_adjustable_area(use_axes=[ax2], pad=0.1,
                                     adjust_dirs=["right"])
    divider.add_auto_adjustable_area(use_axes=[ax1, ax2], pad=0.1,
                                     adjust_dirs=["top", "bottom"])

    ax1.set_yticks([0.5])
    ax1.set_yticklabels(["very long label"])

    ax2.set_title("Title")
    ax2.set_xlabel("X - Label")

ex1()
ex2()
ex3()

plt.show()
```

Keywords: python, matplotlib, pylab, example, codex (see [Search examples](#))

90.18 axes_grid example code: parasite_simple2.py

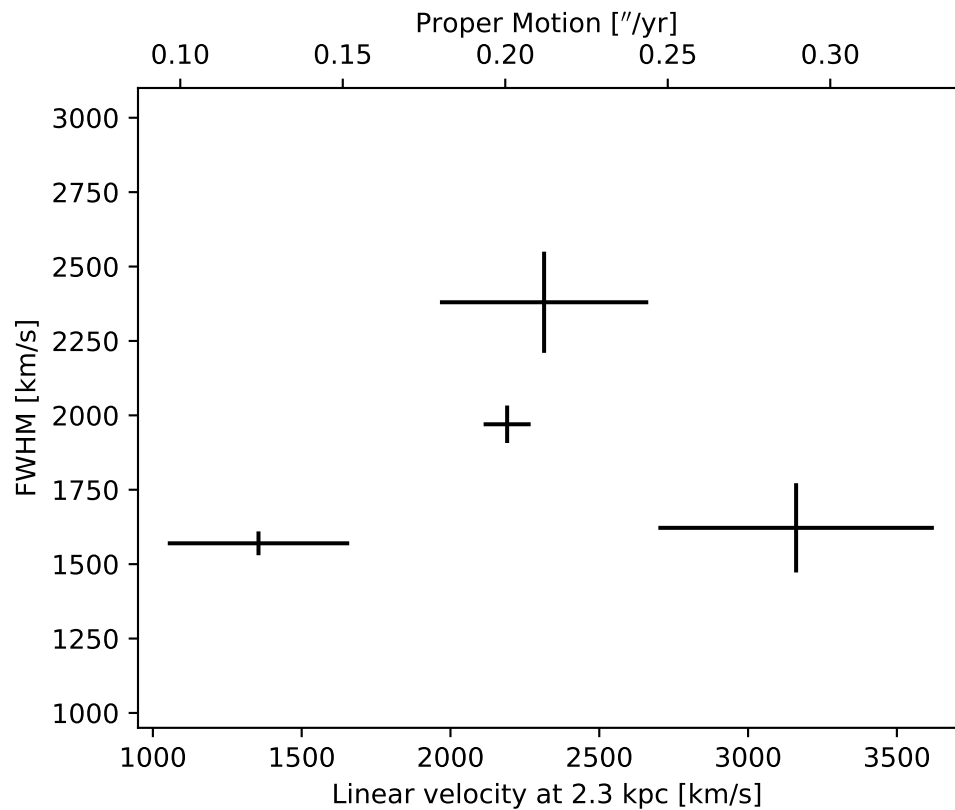

```

import matplotlib.transforms as mtransforms
import matplotlib.pyplot as plt
from mpl_toolkits.axes_grid1.parasite_axes import SubplotHost

obs = [
    ["01_S1", 3.88, 0.14, 1970, 63],
    ["01_S4", 5.6, 0.82, 1622, 150],
    ["02_S1", 2.4, 0.54, 1570, 40],
    ["03_S1", 4.1, 0.62, 2380, 170]]

fig = plt.figure()

ax_kms = SubplotHost(fig, 1, 1, 1, aspect=1.)

# angular proper motion("/yr) to linear velocity(km/s) at distance=2.3kpc
pm_to_kms = 1./206265.*2300*3.085e18/3.15e7/1.e5

aux_trans = mtransforms.Affine2D().scale(pm_to_kms, 1.)
ax_pm = ax_kms.twin(aux_trans)
ax_pm.set_viewlim_mode("transform")

fig.add_subplot(ax_kms)

```

```
for n, ds, dse, w, we in obs:
    time = ((2007 + (10. + 4/30.)/12) - 1988.5)
    v = ds / time * pm_to_kms
    ve = dse / time * pm_to_kms
    ax_kms.errorbar([v], [w], xerr=[ve], yerr=[we], color="k")

ax_kms.axis["bottom"].set_label("Linear velocity at 2.3 kpc [km/s]")
ax_kms.axis["left"].set_label("FWHM [km/s]")
ax_pm.axis["top"].set_label(r"Proper Motion [$$/yr]")
ax_pm.axis["top"].label.set_visible(True)
ax_pm.axis["right"].major_ticklabels.set_visible(False)

ax_kms.set_xlim(950, 3700)
ax_kms.set_ylim(950, 3100)
# xlim and ylim of ax_pms will be automatically adjusted.

plt.draw()
plt.show()
```

Keywords: python, matplotlib, pylab, example, codex (see [Search examples](#))

90.19 axes_grid example code: scatter_hist.py

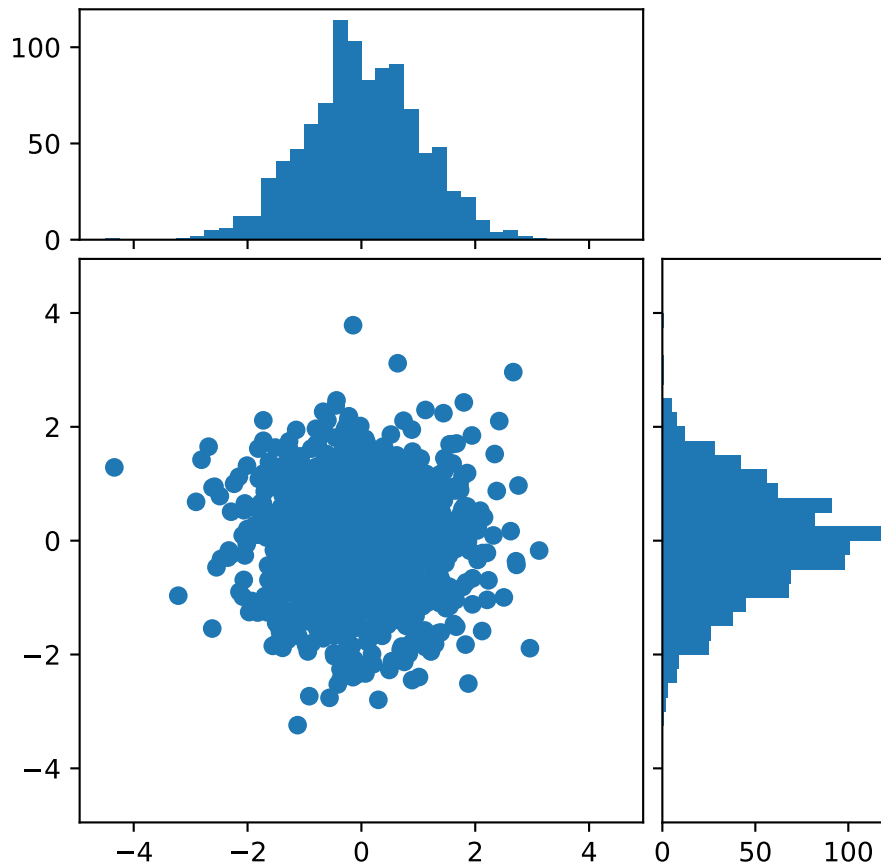

```
import numpy as np
import matplotlib.pyplot as plt
from mpl_toolkits.axes_grid1 import make_axes_locatable

# the random data
x = np.random.randn(1000)
y = np.random.randn(1000)

fig, axScatter = plt.subplots(figsize=(5.5, 5.5))

# the scatter plot:
axScatter.scatter(x, y)
axScatter.set_aspect(1.)

# create new axes on the right and on the top of the current axes
```

```
# The first argument of the new_vertical(new_horizontal) method is
# the height (width) of the axes to be created in inches.
divider = make_axes_locatable(axScatter)
axHistx = divider.append_axes("top", 1.2, pad=0.1, sharex=axScatter)
axHisty = divider.append_axes("right", 1.2, pad=0.1, sharey=axScatter)

# make some labels invisible
plt.setp(axHistx.get_xticklabels() + axHisty.get_yticklabels(),
         visible=False)

# now determine nice limits by hand:
binwidth = 0.25
xymax = np.max([np.max(np.fabs(x)), np.max(np.fabs(y))])
lim = (int(xymax/binwidth) + 1)*binwidth

bins = np.arange(-lim, lim + binwidth, binwidth)
axHistx.hist(x, bins=bins)
axHisty.hist(y, bins=bins, orientation='horizontal')

# the xaxis of axHistx and yaxis of axHisty are shared with axScatter,
# thus there is no need to manually adjust the xlim and ylim of these
# axis.

#axHistx.axis["bottom"].major_ticklabels.set_visible(False)
for tl in axHistx.get_xticklabels():
    tl.set_visible(False)
axHistx.set_yticks([0, 50, 100])

#axHisty.axis["left"].major_ticklabels.set_visible(False)
for tl in axHisty.get_yticklabels():
    tl.set_visible(False)
axHisty.set_xticks([0, 50, 100])

plt.draw()
plt.show()
```

Keywords: python, matplotlib, pylab, example, codex (see [Search examples](#))

90.20 axes_grid example code: simple_anchored_artists.py

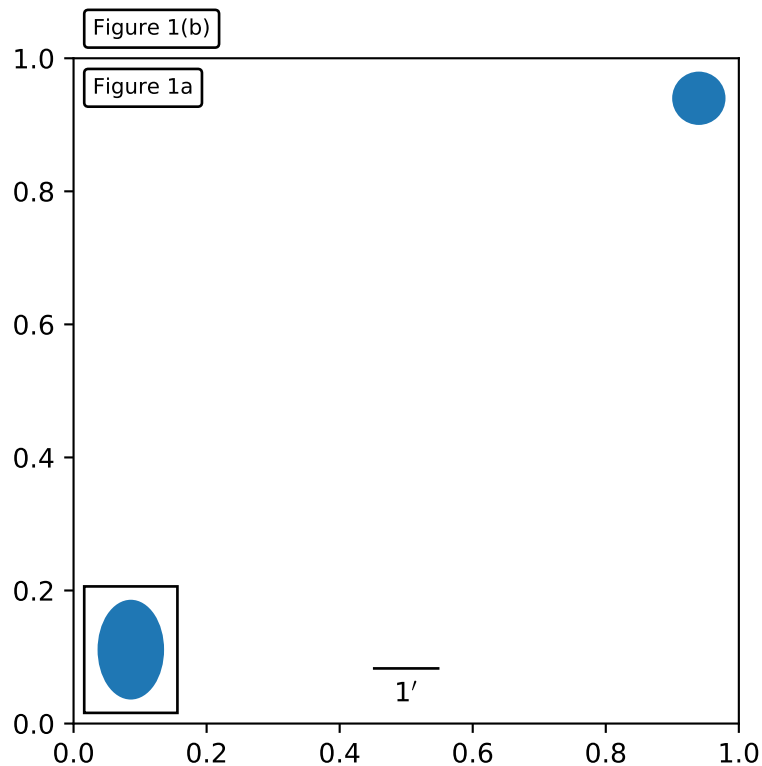

```
import matplotlib.pyplot as plt

def draw_text(ax):
    from matplotlib.offsetbox import AnchoredText
    at = AnchoredText("Figure 1a",
                      loc=2, prop=dict(size=8), frameon=True,
                      )
    at.patch.set_boxstyle("round,pad=0.,rounding_size=0.2")
    ax.add_artist(at)

    at2 = AnchoredText("Figure 1(b)",
                       loc=3, prop=dict(size=8), frameon=True,
                       bbox_to_anchor=(0., 1.),
                       bbox_transform=ax.transAxes
                       )
    at2.patch.set_boxstyle("round,pad=0.,rounding_size=0.2")
    ax.add_artist(at2)

def draw_circle(ax): # circle in the canvas coordinate
    from mpl_toolkits.axes_grid1.anchored_artists import AnchoredDrawingArea
```

```

from matplotlib.patches import Circle
ada = AnchoredDrawingArea(20, 20, 0, 0,
                          loc=1, pad=0., frameon=False)

p = Circle((10, 10), 10)
ada.da.add_artist(p)
ax.add_artist(ada)

def draw_ellipse(ax):
    from mpl_toolkits.axes_grid1.anchored_artists import AnchoredEllipse
    # draw an ellipse of width=0.1, height=0.15 in the data coordinate
    ae = AnchoredEllipse(ax.transData, width=0.1, height=0.15, angle=0.,
                          loc=3, pad=0.5, borderpad=0.4, frameon=True)

    ax.add_artist(ae)

def draw_sizebar(ax):
    from mpl_toolkits.axes_grid1.anchored_artists import AnchoredSizeBar
    # draw a horizontal bar with length of 0.1 in Data coordinate
    # (ax.transData) with a label underneath.
    asb = AnchoredSizeBar(ax.transData,
                           0.1,
                           r"1${\prime}$",
                           loc=8,
                           pad=0.1, borderpad=0.5, sep=5,
                           frameon=False)

    ax.add_artist(asb)

if 1:
    ax = plt.gca()
    ax.set_aspect(1.)

    draw_text(ax)
    draw_circle(ax)
    draw_ellipse(ax)
    draw_sizebar(ax)

plt.show()

```

Keywords: python, matplotlib, pylab, example, codex (see [Search examples](#))

90.21 axes_grid example code: simple_axesgrid.py

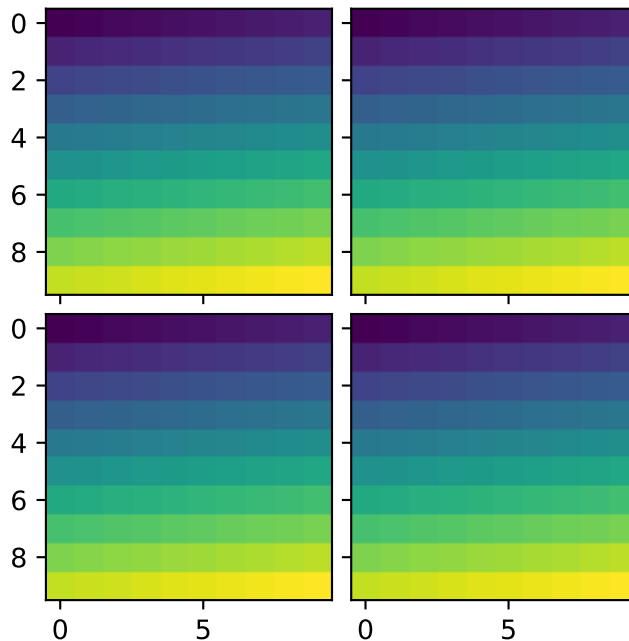

```
import matplotlib.pyplot as plt
from mpl_toolkits.axes_grid1 import ImageGrid
import numpy as np

im = np.arange(100)
im.shape = 10, 10

fig = plt.figure(1, (4., 4.))
grid = ImageGrid(fig, 111, # similar to subplot(111)
                 nrows_ncols=(2, 2), # creates 2x2 grid of axes
                 axes_pad=0.1, # pad between axes in inch.
                 )

for i in range(4):
    grid[i].imshow(im) # The AxesGrid object work as a list of axes.

plt.show()
```

Keywords: python, matplotlib, pylab, example, codex (see [Search examples](#))

90.22 axes_grid example code: simple_axesgrid2.py

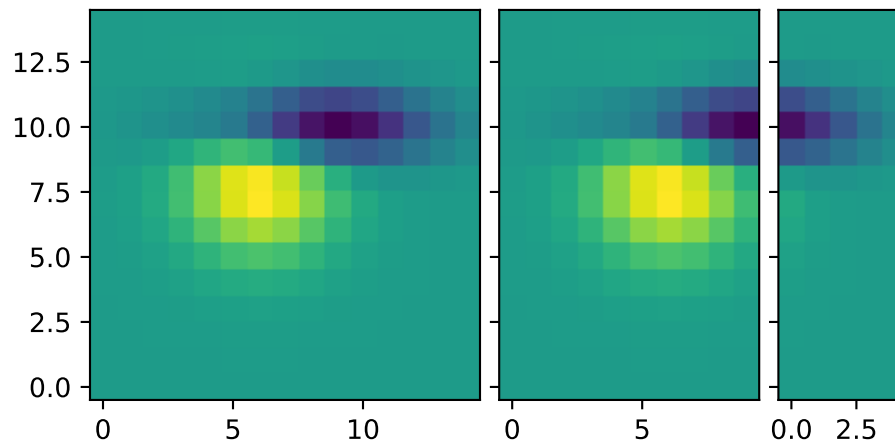

```
import matplotlib.pyplot as plt
from mpl_toolkits.axes_grid1 import ImageGrid

def get_demo_image():
    import numpy as np
    from matplotlib.cbook import get_sample_data
    f = get_sample_data("axes_grid/bivariate_normal.npy", asfileobj=False)
    z = np.load(f)
    # z is a numpy array of 15x15
    return z, (-3, 4, -4, 3)

F = plt.figure(1, (5.5, 3.5))
grid = ImageGrid(F, 111, # similar to subplot(111)
                 nrows_ncols=(1, 3),
                 axes_pad=0.1,
                 add_all=True,
                 label_mode="L",
                 )

Z, extent = get_demo_image() # demo image

im1 = Z
im2 = Z[:, :10]
im3 = Z[:, 10:]
vmin, vmax = Z.min(), Z.max()
for i, im in enumerate([im1, im2, im3]):
    ax = grid[i]
```

```

ax.imshow(im, origin="lower", vmin=vmin,
          vmax=vmax, interpolation="nearest")

plt.draw()
plt.show()

```

Keywords: python, matplotlib, pylab, example, codex (see *Search examples*)

90.23 axes_grid example code: simple_axisline4.py

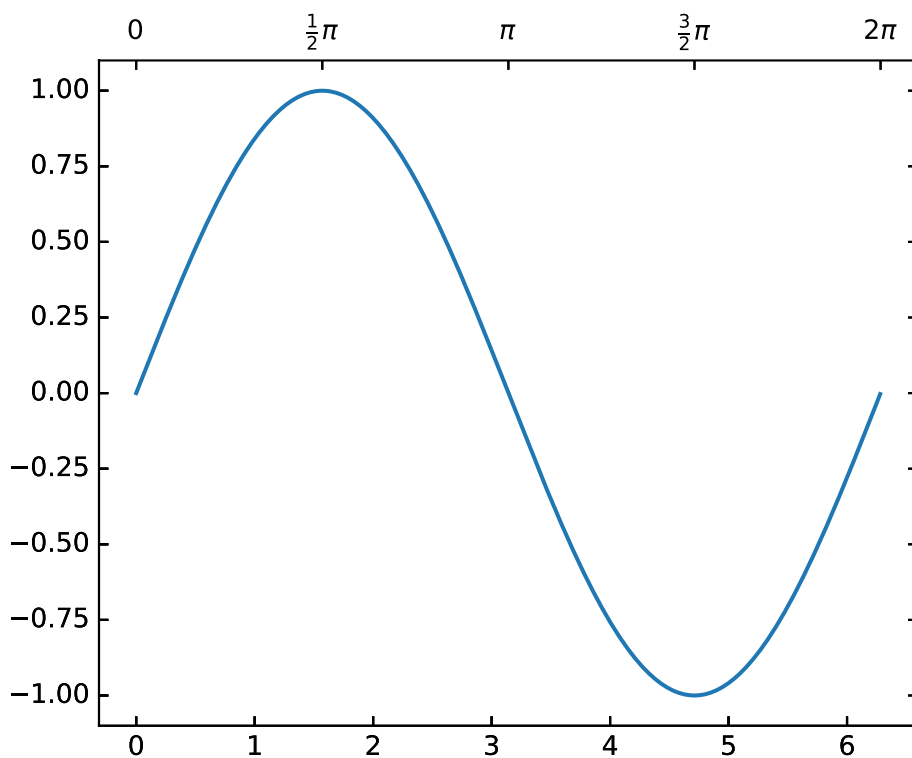

```

import matplotlib.pyplot as plt
from mpl_toolkits.axes_grid1 import host_subplot
import mpl_toolkits.axisartist as AA
import numpy as np

ax = host_subplot(111, axes_class=AA.Axes)
xx = np.arange(0, 2*np.pi, 0.01)
ax.plot(xx, np.sin(xx))

ax2 = ax.twin() # ax2 is responsible for "top" axis and "right" axis
ax2.set_xticks([0., .5*np.pi, np.pi, 1.5*np.pi, 2*np.pi])
ax2.set_xticklabels(["$0$", r"\frac{1}{2}\pi$",

```

```
        r"$\pi$", r"$\frac{3}{2}\pi$", r"$2\pi$"]])  
ax2.axis["right"].major_ticklabels.set_visible(False)  
ax2.axis["top"].major_ticklabels.set_visible(True)  
  
plt.draw()  
plt.show()
```

Keywords: python, matplotlib, pylab, example, codex (see [Search examples](#))

COLOR EXAMPLES

91.1 color example code: color_cycle_default.py

Colors in the default prop_cycle

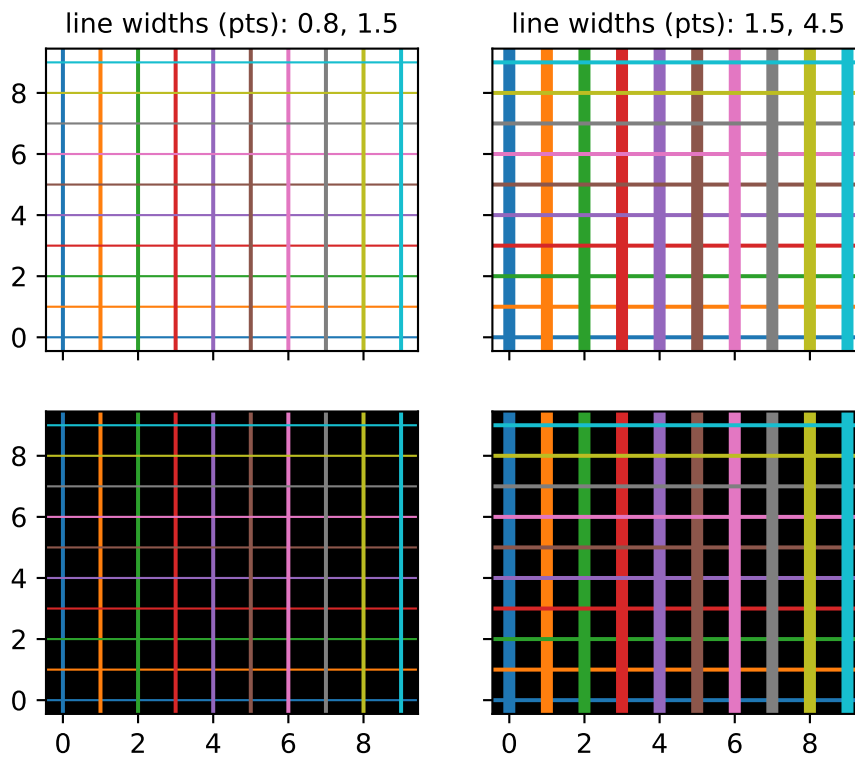

```
"""  
=====   
Colors in the default property cycle   
=====   
  
Display the colors from the default prop_cycle.   
"""  
import numpy as np  
import matplotlib.pyplot as plt
```

```
prop_cycle = plt.rcParams['axes.prop_cycle']
colors = prop_cycle.by_key()['color']

lwbase = plt.rcParams['lines.linewidth']
thin = float('%0.1f' % (lwbase / 2))
thick = lwbase * 3

fig, axs = plt.subplots(nrows=2, ncols=2, sharex=True, sharey=True)
for icol in range(2):
    if icol == 0:
        lwx, lwy = thin, lwbase
    else:
        lwx, lwy = lwbase, thick
    for irow in range(2):
        for i, color in enumerate(colors):
            axs[irow, icol].axhline(i, color=color, lw=lwx)
            axs[irow, icol].axvline(i, color=color, lw=lwy)

    axs[1, icol].set_facecolor('k')
    axs[1, icol].xaxis.set_ticks(np.arange(0, 10, 2))
    axs[0, icol].set_title('line widths (pts): %0.1f, %0.1f' % (lwx, lwy),
                           fontsize='medium')

for irow in range(2):
    axs[irow, 0].yaxis.set_ticks(np.arange(0, 10, 2))

fig.suptitle('Colors in the default prop_cycle', fontsize='large')

plt.show()
```

Keywords: python, matplotlib, pylab, example, codex (see [Search examples](#))

91.2 color example code: color_cycle_demo.py

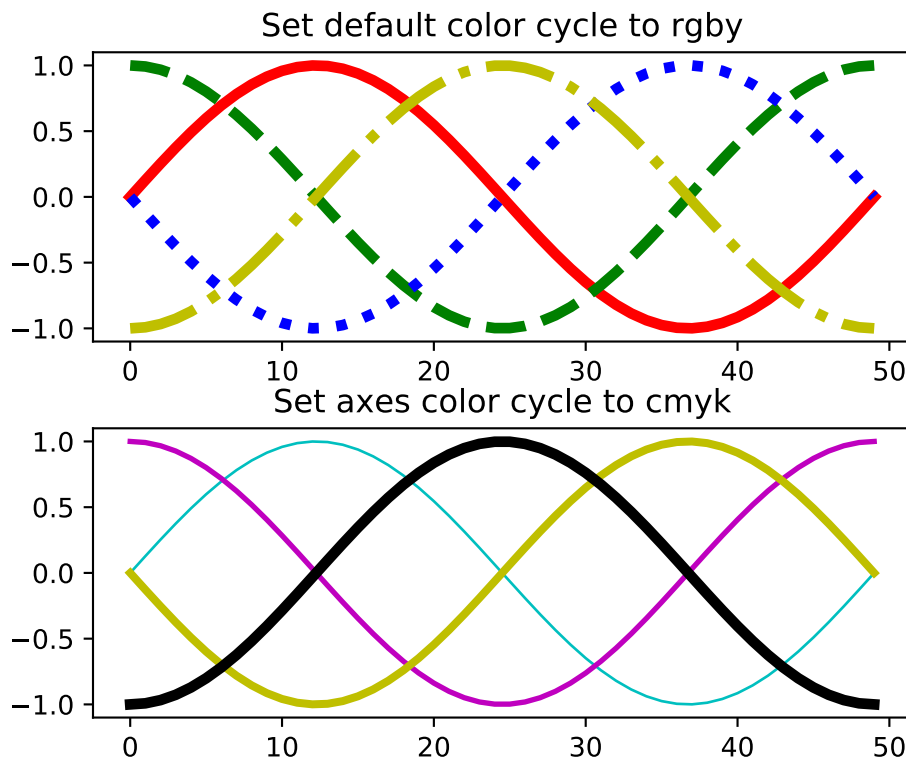

```

"""
=====
Styling with cycler
=====

Demo of custom property-cycle settings to control colors and other style
properties for multi-line plots.

This example demonstrates two different APIs:

    1. Setting the default rc parameter specifying the property cycle.
       This affects all subsequent axes (but not axes already created).
    2. Setting the property cycle for a single pair of axes.
"""
from cycler import cycler
import numpy as np
import matplotlib.pyplot as plt

x = np.linspace(0, 2 * np.pi)
offsets = np.linspace(0, 2*np.pi, 4, endpoint=False)
# Create array with shifted-sine curve along each column

```

```

yy = np.transpose([np.sin(x + phi) for phi in offsets])

# 1. Setting prop cycle on default rc parameter
plt.rc('lines', linewidth=4)
plt.rc('axes', prop_cycle=(cycler('color', ['r', 'g', 'b', 'y']) +
                             cycler('linestyle', ['- ', '--', ':', '-.']))))
fig, (ax0, ax1) = plt.subplots(nrows=2)
ax0.plot(yy)
ax0.set_title('Set default color cycle to rgby')

# 2. Define prop cycle for single set of axes
ax1.set_prop_cycle(cycler('color', ['c', 'm', 'y', 'k']) +
                   cycler('lw', [1, 2, 3, 4]))
ax1.plot(yy)
ax1.set_title('Set axes color cycle to cmyk')

# Tweak spacing between subplots to prevent labels from overlapping
fig.subplots_adjust(hspace=0.3)
plt.show()

```

Keywords: python, matplotlib, pylab, example, codex (see [Search examples](#))

91.3 color example code: colormaps_reference.py



Sequential colormaps

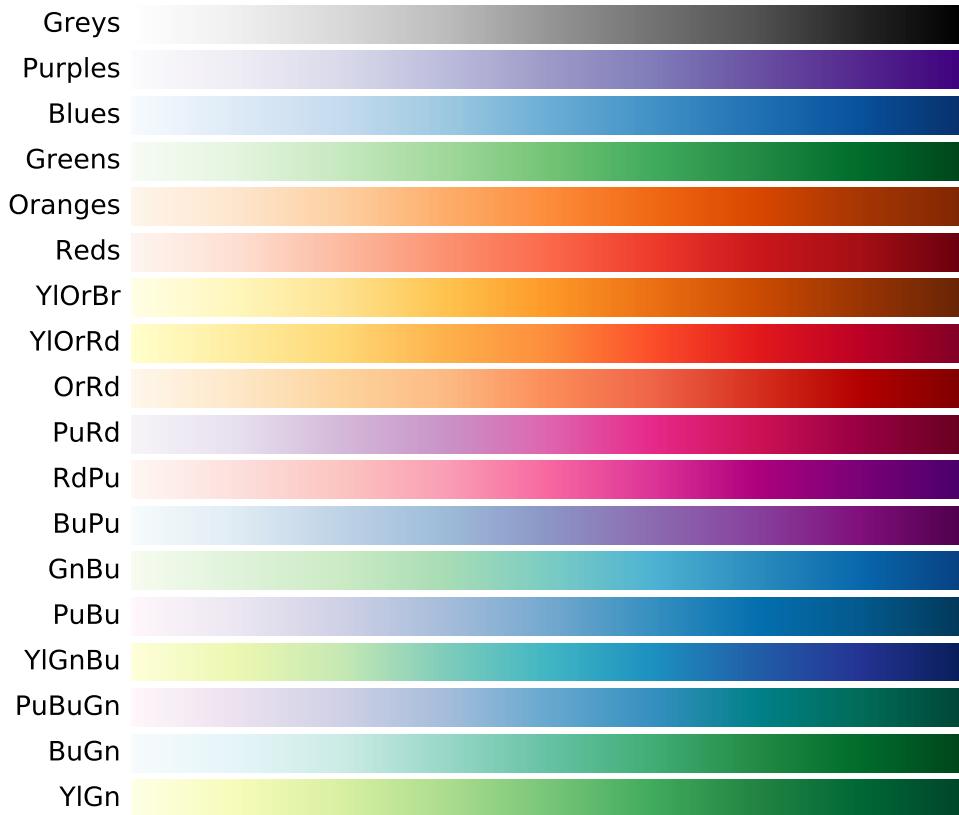

Sequential (2) colormaps

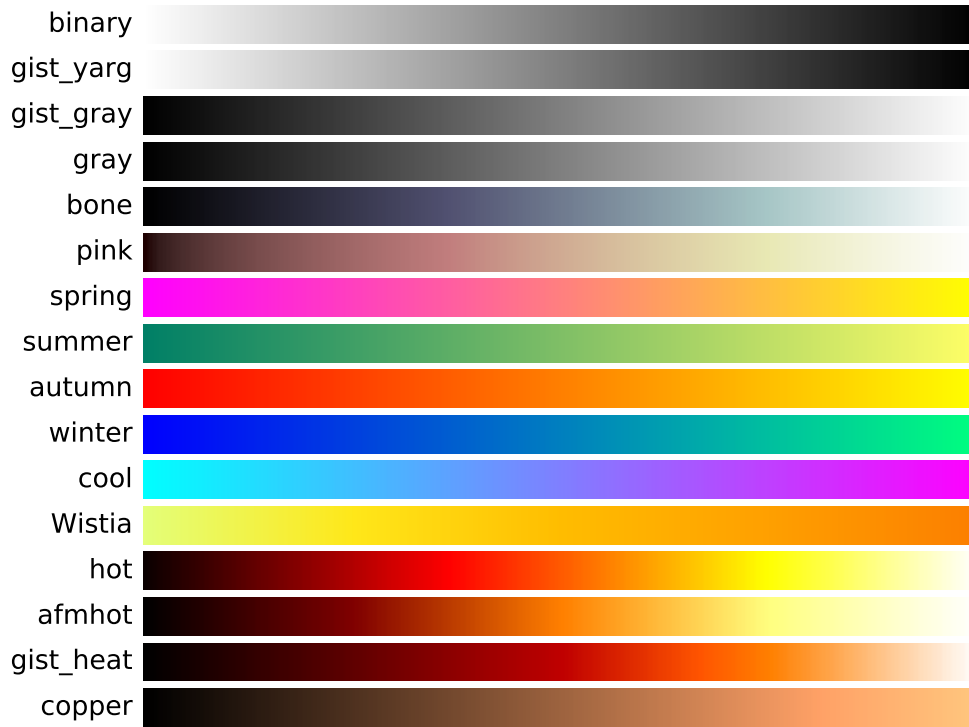

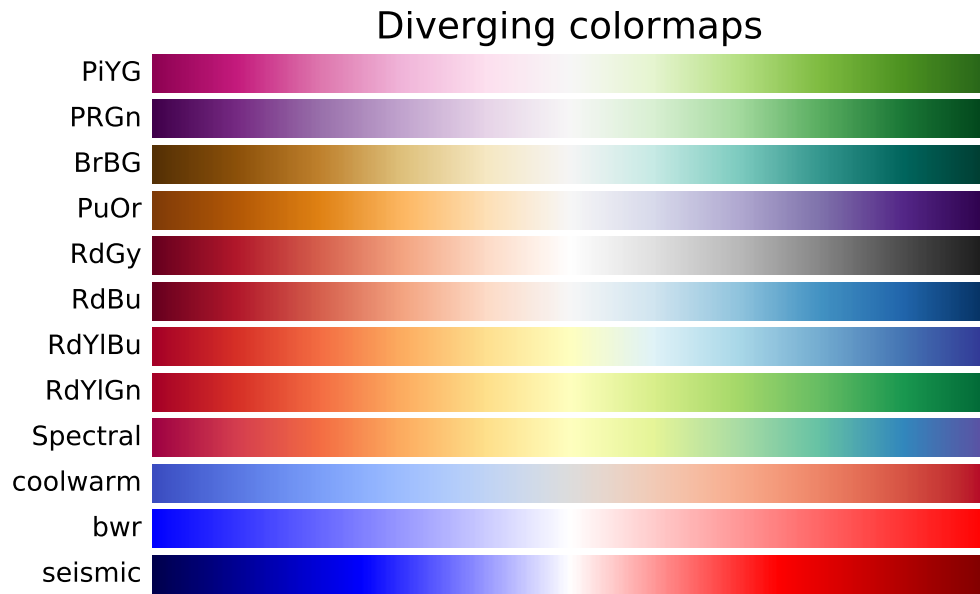

Qualitative colormaps



Miscellaneous colormaps

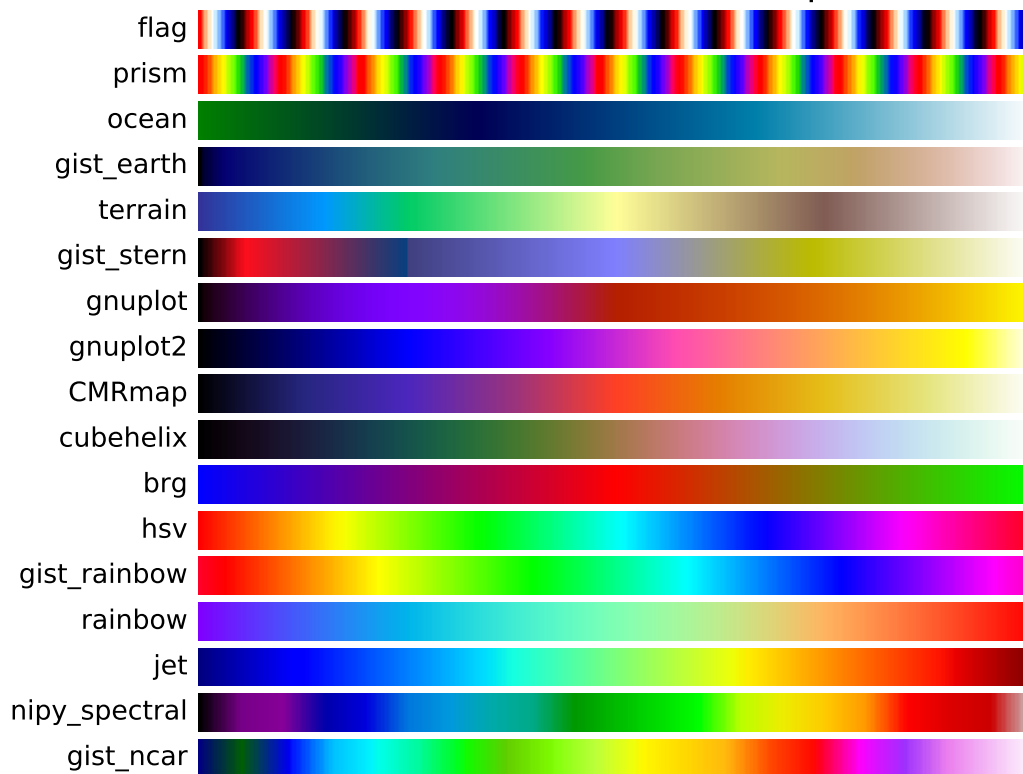

```
"""
```

```
=====
Colormap reference
=====
```

Reference for colormaps included with Matplotlib.

This reference example shows all colormaps included with Matplotlib. Note that any colormap listed here can be reversed by appending "_r" (e.g., "pink_r"). These colormaps are divided into the following categories:

Sequential:

These colormaps are approximately monochromatic colormaps varying smoothly between two color tones---usually from low saturation (e.g. white) to high saturation (e.g. a bright blue). Sequential colormaps are ideal for representing most scientific data since they show a clear progression from low-to-high values.

Diverging:

These colormaps have a median value (usually light in color) and vary smoothly to two different color tones at high and low values. Diverging colormaps are ideal when your data has a median value that is significant (e.g. 0, such that positive and negative values are represented by different colors of the colormap).

Qualitative:

These colormaps vary rapidly in color. Qualitative colormaps are useful for choosing a set of discrete colors. For example::

```
color_list = plt.cm.Set3(np.linspace(0, 1, 12))
```

gives a list of RGB colors that are good for plotting a series of lines on a dark background.

Miscellaneous:

Colormaps that don't fit into the categories above.

```
"""
import numpy as np
import matplotlib.pyplot as plt

# Have colormaps separated into categories:
# http://matplotlib.org/examples/color/colormaps_reference.html
cmaps = [('Perceptually Uniform Sequential', [
    'viridis', 'plasma', 'inferno', 'magma']),
 ('Sequential', [
    'Greys', 'Purples', 'Blues', 'Greens', 'Oranges', 'Reds',
    'YlOrBr', 'YlOrRd', 'OrRd', 'PuRd', 'RdPu', 'BuPu',
    'GnBu', 'PuBu', 'YlGnBu', 'PuBuGn', 'BuGn', 'YlGn']),
 ('Sequential (2)', [
    'binary', 'gist_yarg', 'gist_gray', 'gray', 'bone', 'pink',
    'spring', 'summer', 'autumn', 'winter', 'cool', 'Wistia',
    'hot', 'afmhot', 'gist_heat', 'copper']),
 ('Diverging', [
    'PiYG', 'PRGn', 'BrBG', 'PuOr', 'RdGy', 'RdBu',
    'RdYlBu', 'RdYlGn', 'Spectral', 'coolwarm', 'bwr', 'seismic']),
 ('Qualitative', [
    'Pastel1', 'Pastel2', 'Paired', 'Accent',
    'Dark2', 'Set1', 'Set2', 'Set3',
    'tab10', 'tab20', 'tab20b', 'tab20c']),
 ('Miscellaneous', [
    'flag', 'prism', 'ocean', 'gist_earth', 'terrain', 'gist_stern',
    'gnuplot', 'gnuplot2', 'CMRmap', 'cubehelix', 'brg', 'hsv',
    'gist_rainbow', 'rainbow', 'jet', 'nipy_spectral', 'gist_ncar'])]

nrows = max(len(cmap_list) for cmap_category, cmap_list in cmaps)
gradient = np.linspace(0, 1, 256)
gradient = np.vstack((gradient, gradient))

def plot_color_gradients(cmap_category, cmap_list, nrows):
    fig, axes = plt.subplots(nrows=nrows)
    fig.subplots_adjust(top=0.95, bottom=0.01, left=0.2, right=0.99)
    axes[0].set_title(cmap_category + ' colormaps', fontsize=14)

    for ax, name in zip(axes, cmap_list):
        ax.imshow(gradient, aspect='auto', cmap=plt.get_cmap(name))
```

```

pos = list(ax.get_position().bounds)
x_text = pos[0] - 0.01
y_text = pos[1] + pos[3]/2.
fig.text(x_text, y_text, name, va='center', ha='right', fontsize=10)

# Turn off all ticks & spines, not just the ones with colormaps.
for ax in axes:
    ax.set_axis_off()









































































for cmap_category, cmap_list in cmaps:
    plot_color_gradients(cmap_category, cmap_list, nrows)

plt.show()

```

Keywords: python, matplotlib, pylab, example, codex (see [Search examples](#))

91.4 color example code: named_colors.py

	black		k		dimgray		dimgray
	gray		grey		darkgray		darkgrey
	silver		lightgray		lightgrey		gainsboro
	whitesmoke		w		white		snow
	rosybrown		lightcoral		indianred		brown
	firebrick		maroon		darkred		r
	red		mistyrose		salmon		tomato
	darksalmon		coral		orangered		lightsalmon
	sienna		seashell		chocolate		saddlebrown
	sandybrown		peachpuff		peru		linen
	bisque		darkorange		burlywood		antiquewhite
	tan		navajowhite		blanchedalmond		papayawhip
	moccasin		orange		wheat		oldlace
	floralwhite		darkgoldenrod		goldenrod		cornsilk
	gold		lemonchiffon		khaki		palegoldenrod
	darkkhaki		ivory		beige		lightyellow
	lightgoldenrodyellow		olive		y		yellow
	olivedrab		yellowgreen		darkolivegreen		greenyellow
	chartreuse		lawngreen		honeydew		darkseagreen
	palegreen		lightgreen		forestgreen		limegreen
	darkgreen		g		green		lime
	seagreen		mediumseagreen		springgreen		mintcream
	mediumspringgreen		mediumaquamarine		aquamarine		turquoise
	lightseagreen		mediumturquoise		azure		lightcyan
	paleturquoise		darkslategray		darkslategray		teal
	darkcyan		c		aqua		cyan
	darkturquoise		cadetblue		powderblue		lightblue
	deeppskyblue		skyblue		lightskyblue		steelblue
	aliceblue		dodgerblue		lightslategray		lightslategray
	slategray		slategray		lightsteelblue		cornflowerblue
	royalblue		ghostwhite		lavender		midnightblue
	navy		darkblue		mediumblue		b
	blue		slateblue		darkslateblue		mediumslateblue
	mediumpurple		rebeccapurple		blueviolet		indigo
	darkorchid		darkviolet		mediumorchid		thistle
	plum		violet		purple		darkmagenta
	m		fuchsia		magenta		orchid
	mediumvioletred		deeppink		hotpink		lavenderblush
	palevioletred		crimson		pink		lightpink

```

"""
=====
Visualizing named colors
=====

Simple plot example with the named colors and its visual representation.

```

```

"""
from __future__ import division

import matplotlib.pyplot as plt
from matplotlib import colors as mcolors

colors = dict(mcolors.BASE_COLORS, **mcolors.CSS4_COLORS)

# Sort colors by hue, saturation, value and name.
by_hsv = sorted((tuple(mcolors.rgb_to_hsv(mcolors.to_rgba(color)[:3])), name)
                 for name, color in colors.items())
                sorted_names = [name for hsv, name in by_hsv]

n = len(sorted_names)
ncols = 4
nrows = n // ncols + 1

fig, ax = plt.subplots(figsize=(8, 5))

# Get height and width
X, Y = fig.get_dpi() * fig.get_size_inches()
h = Y / (nrows + 1)
w = X / ncols

for i, name in enumerate(sorted_names):
    col = i % ncols
    row = i // ncols
    y = Y - (row * h) - h

    xi_line = w * (col + 0.05)
    xf_line = w * (col + 0.25)
    xi_text = w * (col + 0.3)

    ax.text(xi_text, y, name, fontsize=(h * 0.8),
            horizontalalignment='left',
            verticalalignment='center')

    ax.hlines(y + h * 0.1, xi_line, xf_line,
              color=colors[name], linewidth=(h * 0.6))

ax.set_xlim(0, X)
ax.set_ylim(0, Y)
ax.set_axis_off()

fig.subplots_adjust(left=0, right=1,
                    top=1, bottom=0,
                    hspace=0, wspace=0)

plt.show()

```

Keywords: python, matplotlib, pylab, example, codex (see [Search examples](#))

EVENT_HANDLING EXAMPLES

92.1 event_handling example code: close_event.py

[source code]

```
from __future__ import print_function
import matplotlib.pyplot as plt

def handle_close(evt):
    print('Closed Figure!')

fig = plt.figure()
fig.canvas.mpl_connect('close_event', handle_close)

plt.text(0.35, 0.5, 'Close Me!', dict(size=30))
plt.show()
```

Keywords: python, matplotlib, pylab, example, codex (see *Search examples*)

92.2 event_handling example code: data_browser.py

[source code]

```
import numpy as np

class PointBrowser(object):
    """
    Click on a point to select and highlight it -- the data that
    generated the point will be shown in the lower axes. Use the 'n'
    and 'p' keys to browse through the next and previous points
    """

    def __init__(self):
        self.lastind = 0

        self.text = ax.text(0.05, 0.95, 'selected: none',
```

```

        transform=ax.transAxes, va='top')
self.selected, = ax.plot([xs[0]], [ys[0]], 'o', ms=12, alpha=0.4,
                        color='yellow', visible=False)

def onpress(self, event):
    if self.lastind is None:
        return
    if event.key not in ('n', 'p'):
        return
    if event.key == 'n':
        inc = 1
    else:
        inc = -1

    self.lastind += inc
    self.lastind = np.clip(self.lastind, 0, len(xs) - 1)
    self.update()

def onpick(self, event):

    if event.artist != line:
        return True

    N = len(event.ind)
    if not N:
        return True

    # the click locations
    x = event.mouseevent.xdata
    y = event.mouseevent.ydata

    distances = np.hypot(x - xs[event.ind], y - ys[event.ind])
    indmin = distances.argmin()
    dataind = event.ind[indmin]

    self.lastind = dataind
    self.update()

def update(self):
    if self.lastind is None:
        return

    dataind = self.lastind

    ax2.cla()
    ax2.plot(X[dataind])

    ax2.text(0.05, 0.9, 'mu=%1.3f\nsigma=%1.3f' % (xs[dataind], ys[dataind]),
            transform=ax2.transAxes, va='top')
    ax2.set_ylim(-0.5, 1.5)
    self.selected.set_visible(True)
    self.selected.set_data(xs[dataind], ys[dataind])

```

```

        self.text.set_text('selected: %d' % dataind)
        fig.canvas.draw()

if __name__ == '__main__':
    import matplotlib.pyplot as plt

    X = np.random.rand(100, 200)
    xs = np.mean(X, axis=1)
    ys = np.std(X, axis=1)

    fig, (ax, ax2) = plt.subplots(2, 1)
    ax.set_title('click on point to plot time series')
    line, = ax.plot(xs, ys, 'o', picker=5) # 5 points tolerance

    browser = PointBrowser()

    fig.canvas.mpl_connect('pick_event', browser.onpick)
    fig.canvas.mpl_connect('key_press_event', browser.onpress)

    plt.show()

```

Keywords: python, matplotlib, pylab, example, codex (see [Search examples](#))

92.3 event_handling example code: figure_axes_enter_leave.py

[source code]

```

"""
Illustrate the figure and axes enter and leave events by changing the
frame colors on enter and leave
"""
from __future__ import print_function
import matplotlib.pyplot as plt

def enter_axes(event):
    print('enter_axes', event.inaxes)
    event.inaxes.patch.set_facecolor('yellow')
    event.canvas.draw()

def leave_axes(event):
    print('leave_axes', event.inaxes)
    event.inaxes.patch.set_facecolor('white')
    event.canvas.draw()

def enter_figure(event):
    print('enter_figure', event.canvas.figure)
    event.canvas.figure.patch.set_facecolor('red')

```

```

event.canvas.draw()

def leave_figure(event):
    print('leave_figure', event.canvas.figure)
    event.canvas.figure.patch.set_facecolor('grey')
    event.canvas.draw()

fig1, (ax, ax2) = plt.subplots(2, 1)
fig1.suptitle('mouse hover over figure or axes to trigger events')

fig1.canvas.mpl_connect('figure_enter_event', enter_figure)
fig1.canvas.mpl_connect('figure_leave_event', leave_figure)
fig1.canvas.mpl_connect('axes_enter_event', enter_axes)
fig1.canvas.mpl_connect('axes_leave_event', leave_axes)

fig2, (ax, ax2) = plt.subplots(2, 1)
fig2.suptitle('mouse hover over figure or axes to trigger events')

fig2.canvas.mpl_connect('figure_enter_event', enter_figure)
fig2.canvas.mpl_connect('figure_leave_event', leave_figure)
fig2.canvas.mpl_connect('axes_enter_event', enter_axes)
fig2.canvas.mpl_connect('axes_leave_event', leave_axes)

plt.show()

```

Keywords: python, matplotlib, pylab, example, codex (see [Search examples](#))

92.4 event_handling example code: idle_and_timeout.py

[source code]

```

from __future__ import print_function
"""
Demonstrate/test the idle and timeout API

WARNING: idle_event is deprecated. Use the animations module instead.

This is only tested on gtk so far and is a prototype implementation
"""
import numpy as np
import matplotlib.pyplot as plt

fig, ax = plt.subplots()

t = np.arange(0.0, 2.0, 0.01)
y1 = np.sin(2*np.pi*t)
y2 = np.cos(2*np.pi*t)
line1, = ax.plot(y1)
line2, = ax.plot(y2)

```

```

N = 100

def on_idle(event):
    on_idle.count += 1
    print('idle', on_idle.count)
    line1.set_ydata(np.sin(2*np.pi*t*(N - on_idle.count)/float(N)))
    event.canvas.draw()
    # test boolean return removal
    if on_idle.count == N:
        return False
    return True
on_idle.cid = None
on_idle.count = 0

fig.canvas.mpl_connect('idle_event', on_idle)

plt.show()

```

Keywords: python, matplotlib, pylab, example, codex (see [Search examples](#))

92.5 event_handling example code: keypress_demo.py

[source code]

```

"""
Show how to connect to keypress events
"""
from __future__ import print_function
import sys
import numpy as np
import matplotlib.pyplot as plt

def press(event):
    print('press', event.key)
    sys.stdout.flush()
    if event.key == 'x':
        visible = xl.get_visible()
        xl.set_visible(not visible)
        fig.canvas.draw()

fig, ax = plt.subplots()

fig.canvas.mpl_connect('key_press_event', press)

ax.plot(np.random.rand(12), np.random.rand(12), 'go')
xl = ax.set_xlabel('easy come, easy go')
ax.set_title('Press a key')
plt.show()

```

Keywords: python, matplotlib, pylab, example, codex (see *Search examples*)

92.6 event_handling example code: lasso_demo.py

[source code]

```
"""
Show how to use a lasso to select a set of points and get the indices
of the selected points. A callback is used to change the color of the
selected points

This is currently a proof-of-concept implementation (though it is
usable as is). There will be some refinement of the API.
"""
from matplotlib.widgets import Lasso
from matplotlib.collections import RegularPolyCollection
from matplotlib import colors as mcolors, path

import matplotlib.pyplot as plt
from numpy import nonzero
from numpy.random import rand

class Datum(object):
    colorin = mcolors.to_rgba("red")
    colorout = mcolors.to_rgba("blue")

    def __init__(self, x, y, include=False):
        self.x = x
        self.y = y
        if include:
            self.color = self.colorin
        else:
            self.color = self.colorout

class LassoManager(object):
    def __init__(self, ax, data):
        self.axes = ax
        self.canvas = ax.figure.canvas
        self.data = data

        self.Nxy = len(data)

        facecolors = [d.color for d in data]
        self.xys = [(d.x, d.y) for d in data]
        self.collection = RegularPolyCollection(
            6, sizes=(100,),
            facecolors=facecolors,
            offsets=self.xys,
            transOffset=ax.transData)
```

```

ax.add_collection(self.collection)

self.cid = self.canvas.mpl_connect('button_press_event', self.onpress)

def callback(self, verts):
    facecolors = self.collection.get_facecolors()
    p = path.Path(verts)
    ind = p.contains_points(self.xys)
    for i in range(len(self.xys)):
        if ind[i]:
            facecolors[i] = Datum.colorin
        else:
            facecolors[i] = Datum.colorout

    self.canvas.draw_idle()
    self.canvas.widgetlock.release(self.lasso)
    del self.lasso

def onpress(self, event):
    if self.canvas.widgetlock.locked():
        return
    if event.inaxes is None:
        return
    self.lasso = Lasso(event.inaxes,
                      (event.xdata, event.ydata),
                      self.callback)
    # acquire a lock on the widget drawing
    self.canvas.widgetlock(self.lasso)

if __name__ == '__main__':

    data = [Datum(*xy) for xy in rand(100, 2)]
    ax = plt.axes(xlim=(0, 1), ylim=(0, 1), autoscale_on=False)
    ax.set_title('Lasso points using left mouse button')

    lman = LassoManager(ax, data)

    plt.show()

```

Keywords: python, matplotlib, pylab, example, codex (see [Search examples](#))

92.7 event_handling example code: legend_picking.py

[source code]

```

"""
Enable picking on the legend to toggle the original line on and off
"""
import numpy as np
import matplotlib.pyplot as plt

```

```

t = np.arange(0.0, 0.2, 0.1)
y1 = 2*np.sin(2*np.pi*t)
y2 = 4*np.sin(2*np.pi*2*t)

fig, ax = plt.subplots()
ax.set_title('Click on legend line to toggle line on/off')
line1, = ax.plot(t, y1, lw=2, color='red', label='1 HZ')
line2, = ax.plot(t, y2, lw=2, color='blue', label='2 HZ')
leg = ax.legend(loc='upper left', fancybox=True, shadow=True)
leg.get_frame().set_alpha(0.4)

# we will set up a dict mapping legend line to orig line, and enable
# picking on the legend line
lines = [line1, line2]
lined = dict()
for legline, origline in zip(leg.get_lines(), lines):
    legline.set_picker(5) # 5 pts tolerance
    lined[legline] = origline

def onpick(event):
    # on the pick event, find the orig line corresponding to the
    # legend proxy line, and toggle the visibility
    legline = event.artist
    origline = lined[legline]
    vis = not origline.get_visible()
    origline.set_visible(vis)
    # Change the alpha on the line in the legend so we can see what lines
    # have been toggled
    if vis:
        legline.set_alpha(1.0)
    else:
        legline.set_alpha(0.2)
    fig.canvas.draw()

fig.canvas.mpl_connect('pick_event', onpick)

plt.show()

```

Keywords: python, matplotlib, pylab, example, codex (see [Search examples](#))

92.8 event_handling example code: looking_glass.py

[source code]

```

import numpy as np
import matplotlib.pyplot as plt
import matplotlib.patches as patches
x, y = np.random.rand(2, 200)

```



```

fig, ax = plt.subplots()
circ = patches.Circle((0.5, 0.5), 0.25, alpha=0.8, fc='yellow')
ax.add_patch(circ)

ax.plot(x, y, alpha=0.2)
line, = ax.plot(x, y, alpha=1.0, clip_path=circ)
ax.set_title("Left click and drag to move looking glass")

class EventHandler(object):
    def __init__(self):
        fig.canvas.mpl_connect('button_press_event', self.onpress)
        fig.canvas.mpl_connect('button_release_event', self.onrelease)
        fig.canvas.mpl_connect('motion_notify_event', self.onmove)
        self.x0, self.y0 = circ.center
        self.pressevent = None

    def onpress(self, event):
        if event.inaxes != ax:
            return

        if not circ.contains(event)[0]:
            return

        self.pressevent = event

    def onrelease(self, event):
        self.pressevent = None
        self.x0, self.y0 = circ.center

    def onmove(self, event):
        if self.pressevent is None or event.inaxes != self.pressevent.inaxes:
            return

        dx = event.xdata - self.pressevent.xdata
        dy = event.ydata - self.pressevent.ydata
        circ.center = self.x0 + dx, self.y0 + dy
        line.set_clip_path(circ)
        fig.canvas.draw()

handler = EventHandler()
plt.show()

```

Keywords: python, matplotlib, pylab, example, codex (see [Search examples](#))

92.9 event_handling example code: path_editor.py

[source code]

```

import numpy as np
import matplotlib.path as mpath
import matplotlib.patches as mpatches
import matplotlib.pyplot as plt

Path = mpath.Path

fig, ax = plt.subplots()

pathdata = [
    (Path.MOVETO, (1.58, -2.57)),
    (Path.CURVE4, (0.35, -1.1)),
    (Path.CURVE4, (-1.75, 2.0)),
    (Path.CURVE4, (0.375, 2.0)),
    (Path.LINETO, (0.85, 1.15)),
    (Path.CURVE4, (2.2, 3.2)),
    (Path.CURVE4, (3, 0.05)),
    (Path.CURVE4, (2.0, -0.5)),
    (Path.CLOSEPOLY, (1.58, -2.57)),
]

codes, verts = zip(*pathdata)
path = mpath.Path(verts, codes)
patch = mpatches.PathPatch(path, facecolor='green', edgecolor='yellow', alpha=0.5)
ax.add_patch(patch)

class PathInteractor(object):
    """
    An path editor.

    Key-bindings

    't' toggle vertex markers on and off.  When vertex markers are on,
        you can move them, delete them

    """
    showverts = True
    epsilon = 5 # max pixel distance to count as a vertex hit

    def __init__(self, pathpatch):

        self.ax = pathpatch.axes
        canvas = self.ax.figure.canvas
        self.pathpatch = pathpatch
        self.pathpatch.set_animated(True)

        x, y = zip(*self.pathpatch.get_path().vertices)

        self.line, = ax.plot(x, y, marker='o', markerfacecolor='r', animated=True)

```

```

self._ind = None # the active vert

canvas.mpl_connect('draw_event', self.draw_callback)
canvas.mpl_connect('button_press_event', self.button_press_callback)
canvas.mpl_connect('key_press_event', self.key_press_callback)
canvas.mpl_connect('button_release_event', self.button_release_callback)
canvas.mpl_connect('motion_notify_event', self.motion_notify_callback)
self.canvas = canvas

def draw_callback(self, event):
    self.background = self.canvas.copy_from_bbox(self.ax.bbox)
    self.ax.draw_artist(self.pathpatch)
    self.ax.draw_artist(self.line)
    self.canvas.blit(self.ax.bbox)

def pathpatch_changed(self, pathpatch):
    'this method is called whenever the pathpatchgon object is called'
    # only copy the artist props to the line (except visibility)
    vis = self.line.get_visible()
    plt.Artist.update_from(self.line, pathpatch)
    self.line.set_visible(vis) # don't use the pathpatch visibility state

def get_ind_under_point(self, event):
    'get the index of the vertex under point if within epsilon tolerance'

    # display coords
    xy = np.asarray(self.pathpatch.get_path().vertices)
    xyt = self.pathpatch.get_transform().transform(xy)
    xt, yt = xyt[:, 0], xyt[:, 1]
    d = np.sqrt((xt - event.x)**2 + (yt - event.y)**2)
    ind = d.argmin()

    if d[ind] >= self.epsilon:
        ind = None

    return ind

def button_press_callback(self, event):
    'whenever a mouse button is pressed'
    if not self.showverts:
        return
    if event.inaxes is None:
        return
    if event.button != 1:
        return
    self._ind = self.get_ind_under_point(event)

def button_release_callback(self, event):
    'whenever a mouse button is released'
    if not self.showverts:
        return
    if event.button != 1:
        return

```

```

        self._ind = None

    def key_press_callback(self, event):
        'whenever a key is pressed'
        if not event.inaxes:
            return
        if event.key == 't':
            self.showverts = not self.showverts
            self.line.set_visible(self.showverts)
            if not self.showverts:
                self._ind = None

        self.canvas.draw()

    def motion_notify_callback(self, event):
        'on mouse movement'
        if not self.showverts:
            return
        if self._ind is None:
            return
        if event.inaxes is None:
            return
        if event.button != 1:
            return
        x, y = event.xdata, event.ydata

        vertices = self.pathpatch.get_path().vertices

        vertices[self._ind] = x, y
        self.line.set_data(zip(*vertices))

        self.canvas.restore_region(self.background)
        self.ax.draw_artist(self.pathpatch)
        self.ax.draw_artist(self.line)
        self.canvas.blit(self.ax.bbox)

interactor = PathInteractor(patch)
ax.set_title('drag vertices to update path')
ax.set_xlim(-3, 4)
ax.set_ylim(-3, 4)

plt.show()

```

Keywords: python, matplotlib, pylab, example, codex (see [Search examples](#))

92.10 event_handling example code: pick_event_demo.py

[source code]

"""

You can enable picking by setting the "picker" property of an artist (for example, a matplotlib Line2D, Text, Patch, Polygon, AxesImage, etc...)

There are a variety of meanings of the picker property

None - picking is disabled for this artist (default)

boolean - if True then picking will be enabled and the artist will fire a pick event if the mouse event is over the artist

float - if picker is a number it is interpreted as an epsilon tolerance in points and the artist will fire off an event if it's data is within epsilon of the mouse event. For some artists like lines and patch collections, the artist may provide additional data to the pick event that is generated, for example, the indices of the data within epsilon of the pick event

function - if picker is callable, it is a user supplied function which determines whether the artist is hit by the mouse event.

```
hit, props = picker(artist, mouseevent)
```

to determine the hit test. If the mouse event is over the artist, return hit=True and props is a dictionary of properties you want added to the PickEvent attributes

After you have enabled an artist for picking by setting the "picker" property, you need to connect to the figure canvas pick_event to get pick callbacks on mouse press events. For example,

```
def pick_handler(event):
    mouseevent = event.mouseevent
    artist = event.artist
    # now do something with this...
```

The pick event (`matplotlib.backend_bases.PickEvent`) which is passed to your callback is always fired with two attributes:

`mouseevent` - the mouse event that generate the pick event. The mouse event in turn has attributes like `x` and `y` (the coordinates in display space, such as pixels from left, bottom) and `xdata`, `ydata` (the coords in data space). Additionally, you can get information about which buttons were pressed, which keys were pressed, which Axes the mouse is over, etc. See `matplotlib.backend_bases.MouseEvent` for details.

artist - the `matplotlib.artist` that generated the pick event.

Additionally, certain artists like `Line2D` and `PatchCollection` may attach additional meta data like the indices into the data that meet the picker criteria (for example, all the points in the line that are within the specified epsilon tolerance)

The examples below illustrate each of these methods.

```

"""
from __future__ import print_function
import matplotlib.pyplot as plt
from matplotlib.lines import Line2D
from matplotlib.patches import Rectangle
from matplotlib.text import Text
from matplotlib.image import AxesImage
import numpy as np
from numpy.random import rand

if 1: # simple picking, lines, rectangles and text
    fig, (ax1, ax2) = plt.subplots(2, 1)
    ax1.set_title('click on points, rectangles or text', picker=True)
    ax1.set_ylabel('ylabel', picker=True, bbox=dict(facecolor='red'))
    line, = ax1.plot(rand(100), 'o', picker=5) # 5 points tolerance

    # pick the rectangle
    bars = ax2.bar(range(10), rand(10), picker=True)
    for label in ax2.get_xticklabels(): # make the xtick labels pickable
        label.set_picker(True)

    def onpick1(event):
        if isinstance(event.artist, Line2D):
            thisline = event.artist
            xdata = thisline.get_xdata()
            ydata = thisline.get_ydata()
            ind = event.ind
            print('onpick1 line:', zip(np.take(xdata, ind), np.take(ydata, ind)))
        elif isinstance(event.artist, Rectangle):
            patch = event.artist
            print('onpick1 patch:', patch.get_path())
        elif isinstance(event.artist, Text):
            text = event.artist
            print('onpick1 text:', text.get_text())

    fig.canvas.mpl_connect('pick_event', onpick1)

if 1: # picking with a custom hit test function
    # you can define custom pickers by setting picker to a callable
    # function. The function has the signature
    #
    # hit, props = func(artist, mouseevent)
    #

```

```

# to determine the hit test.  if the mouse event is over the artist,
# return hit=True and props is a dictionary of
# properties you want added to the PickEvent attributes

def line_picker(line, mouseevent):
    """
    find the points within a certain distance from the mouseclick in
    data coords and attach some extra attributes, pickx and picky
    which are the data points that were picked
    """
    if mouseevent.xdata is None:
        return False, dict()
    xdata = line.get_xdata()
    ydata = line.get_ydata()
    maxd = 0.05
    d = np.sqrt((xdata - mouseevent.xdata)**2. + (ydata - mouseevent.ydata)**2.)

    ind = np.nonzero(np.less_equal(d, maxd))
    if len(ind):
        pickx = np.take(xdata, ind)
        picky = np.take(ydata, ind)
        props = dict(ind=ind, pickx=pickx, picky=picky)
        return True, props
    else:
        return False, dict()

def onpick2(event):
    print('onpick2 line:', event.pickx, event.picky)

fig, ax = plt.subplots()
ax.set_title('custom picker for line data')
line, = ax.plot(rand(100), rand(100), 'o', picker=line_picker)
fig.canvas.mpl_connect('pick_event', onpick2)

if 1: # picking on a scatter plot (matplotlib.collections.RegularPolyCollection)

    x, y, c, s = rand(4, 100)

    def onpick3(event):
        ind = event.ind
        print('onpick3 scatter:', ind, np.take(x, ind), np.take(y, ind))

    fig, ax = plt.subplots()
    col = ax.scatter(x, y, 100*s, c, picker=True)
    #fig.savefig('pscoll.eps')
    fig.canvas.mpl_connect('pick_event', onpick3)

if 1: # picking images (matplotlib.image.AxesImage)
    fig, ax = plt.subplots()
    im1 = ax.imshow(rand(10, 5), extent=(1, 2, 1, 2), picker=True)
    im2 = ax.imshow(rand(5, 10), extent=(3, 4, 1, 2), picker=True)
    im3 = ax.imshow(rand(20, 25), extent=(1, 2, 3, 4), picker=True)

```

```
im4 = ax.imshow(rand(30, 12), extent=(3, 4, 3, 4), picker=True)
ax.axis([0, 5, 0, 5])

def onpick4(event):
    artist = event.artist
    if isinstance(artist, AxesImage):
        im = artist
        A = im.get_array()
        print('onpick4 image', A.shape)

fig.canvas.mpl_connect('pick_event', onpick4)

plt.show()
```

Keywords: python, matplotlib, pylab, example, codex (see [Search examples](#))

92.11 event_handling example code: pick_event_demo2.py

[source code]

```
"""
compute the mean and standard deviation (stddev) of 100 data sets and plot
mean vs stddev. When you click on one of the mu, sigma points, plot the raw
data from the dataset that generated the mean and stddev.
"""
import numpy
import matplotlib.pyplot as plt

X = numpy.random.rand(100, 1000)
xs = numpy.mean(X, axis=1)
ys = numpy.std(X, axis=1)

fig, ax = plt.subplots()
ax.set_title('click on point to plot time series')
line, = ax.plot(xs, ys, 'o', picker=5) # 5 points tolerance

def onpick(event):

    if event.artist != line:
        return True

    N = len(event.ind)
    if not N:
        return True

    figi = plt.figure()
    for subplotnum, dataind in enumerate(event.ind):
        ax = figi.add_subplot(N, 1, subplotnum + 1)
```



```

    ax.plot(X[dataind])
    ax.text(0.05, 0.9, 'mu=%1.3f\nsigma=%1.3f' % (xs[dataind], ys[dataind]),
           transform=ax.transAxes, va='top')
    ax.set_ylim(-0.5, 1.5)
    figi.show()
    return True

fig.canvas.mpl_connect('pick_event', onpick)

plt.show()

```

Keywords: python, matplotlib, pylab, example, codex (see *Search examples*)

92.12 event_handling example code: pipong.py

[source code]

```

# A matplotlib based game of Pong illustrating one way to write interactive
# animation which are easily ported to multiple backends
# pipong.py was written by Paul Ivanov <http://pirsquared.org>

from __future__ import print_function

import numpy as np
import matplotlib.pyplot as plt
from numpy.random import randn, randint

instructions = """
Player A:      Player B:
'e'           up    'i'
'd'           down  'k'

press 't' -- close these instructions
              (animation will be much faster)
press 'a' -- add a puck
press 'A' -- remove a puck
press '1' -- slow down all pucks
press '2' -- speed up all pucks
press '3' -- slow down distractors
press '4' -- speed up distractors
press ' ' -- reset the first puck
press 'n' -- toggle distractors on/off
press 'g' -- toggle the game on/off

"""

class Pad(object):
    def __init__(self, disp, x, y, type='1'):
        self.disp = disp
        self.x = x

```

```

self.y = y
self.w = .3
self.score = 0
self.xoffset = 0.3
self.yoffset = 0.1
if type == 'r':
    self.xoffset *= -1.0

if type == 'l' or type == 'r':
    self.signx = -1.0
    self.signy = 1.0
else:
    self.signx = 1.0
    self.signy = -1.0

def contains(self, loc):
    return self.disp.get_bbox().contains(loc.x, loc.y)

class Puck(object):
    def __init__(self, disp, pad, field):
        self.vmax = .2
        self.disp = disp
        self.field = field
        self._reset(pad)

    def _reset(self, pad):
        self.x = pad.x + pad.xoffset
        if pad.y < 0:
            self.y = pad.y + pad.yoffset
        else:
            self.y = pad.y - pad.yoffset
        self.vx = pad.x - self.x
        self.vy = pad.y + pad.w/2 - self.y
        self._speedlimit()
        self._slower()
        self._slower()

    def update(self, pads):
        self.x += self.vx
        self.y += self.vy
        for pad in pads:
            if pad.contains(self):
                self.vx *= 1.2 * pad.signx
                self.vy *= 1.2 * pad.signy
        fudge = .001
        # probably cleaner with something like...
        #if not self.field.contains(self.x, self.y):
        if self.x < fudge:
            #print("player A loses")
            pads[1].score += 1
            self._reset(pads[0])
        return True

```

```

    if self.x > 7 - fudge:
        #print("player B loses")
        pads[0].score += 1
        self._reset(pads[1])
        return True
    if self.y < -1 + fudge or self.y > 1 - fudge:
        self.vy *= -1.0
        # add some randomness, just to make it interesting
        self.vy -= (randn()/300.0 + 1/300.0) * np.sign(self.vy)
    self._speedlimit()
    return False

def _slower(self):
    self.vx /= 5.0
    self.vy /= 5.0

def _faster(self):
    self.vx *= 5.0
    self.vy *= 5.0

def _speedlimit(self):
    if self.vx > self.vmax:
        self.vx = self.vmax
    if self.vx < -self.vmax:
        self.vx = -self.vmax

    if self.vy > self.vmax:
        self.vy = self.vmax
    if self.vy < -self.vmax:
        self.vy = -self.vmax

class Game(object):
    def __init__(self, ax):
        # create the initial line
        self.ax = ax
        padAx = padBx = .50
        padAy = padBy = .30
        padBx += 6.3
        pA, = self.ax.barh(padAy, .2, height=.3, color='k', alpha=.5, edgecolor='b',
↪lw=2, label="Player B", animated=True)
        pB, = self.ax.barh(padBy, .2, height=.3, left=padBx, color='k', alpha=.5,
↪edgecolor='r', lw=2, label="Player A", animated=True)

        # distractors
        self.x = np.arange(0, 2.22*np.pi, 0.01)
        self.line, = self.ax.plot(self.x, np.sin(self.x), "r", animated=True, lw=4)
        self.line2, = self.ax.plot(self.x, np.cos(self.x), "g", animated=True, lw=4)
        self.line3, = self.ax.plot(self.x, np.cos(self.x), "g", animated=True, lw=4)
        self.line4, = self.ax.plot(self.x, np.cos(self.x), "r", animated=True, lw=4)
        self.centerline, = self.ax.plot([3.5, 3.5], [1, -1], 'k', alpha=.5,
↪animated=True, lw=8)
        self.puckdisp = self.ax.scatter([1], [1], label='_nolegend_', s=200, c='g',
↪alpha=.9, animated=True)

```

```

self.canvas = self.ax.figure.canvas
self.background = None
self.cnt = 0
self.distract = True
self.res = 100.0
self.on = False
self.inst = True # show instructions from the beginning
self.background = None
self.pads = []
self.pads.append(Pad(pA, 0, padAy))
self.pads.append(Pad(pB, padBx, padBy, 'r'))
self.pucks = []
self.i = self.ax.annotate(instructions, (.5, 0.5),
                           name='monospace',
                           verticalalignment='center',
                           horizontalalignment='center',
                           multialignment='left',
                           textcoords='axes fraction', animated=True)
self.canvas.mpl_connect('key_press_event', self.key_press)

def draw(self, evt):
    draw_artist = self.ax.draw_artist
    if self.background is None:
        self.background = self.canvas.copy_from_bbox(self.ax.bbox)

    # restore the clean slate background
    self.canvas.restore_region(self.background)

    # show the distractors
    if self.distract:
        self.line.set_ydata(np.sin(self.x + self.cnt/self.res))
        self.line2.set_ydata(np.cos(self.x - self.cnt/self.res))
        self.line3.set_ydata(np.tan(self.x + self.cnt/self.res))
        self.line4.set_ydata(np.tan(self.x - self.cnt/self.res))
        draw_artist(self.line)
        draw_artist(self.line2)
        draw_artist(self.line3)
        draw_artist(self.line4)

    # show the instructions - this is very slow
    if self.inst:
        self.ax.draw_artist(self.i)

    # pucks and pads
    if self.on:
        self.ax.draw_artist(self.centerline)
        for pad in self.pads:
            pad.disp.set_y(pad.y)
            pad.disp.set_x(pad.x)
            self.ax.draw_artist(pad.disp)

        for puck in self.pucks:

```

```

        if puck.update(self.pads):
            # we only get here if someone scored
            self.pads[0].disp.set_label("  " + str(self.pads[0].score))
            self.pads[1].disp.set_label("  " + str(self.pads[1].score))
            self.ax.legend(loc='center')
            self.leg = self.ax.get_legend()
            #self.leg.draw_frame(False) #don't draw the legend border
            self.leg.get_frame().set_alpha(.2)
            plt.setp(self.leg.get_texts(), fontweight='bold', fontsize='xx-large')

            self.leg.get_frame().set_facecolor('0.2')
            self.background = None
            self.ax.figure.canvas.draw()
            return True
        puck.disp.set_offsets([puck.x, puck.y])
        self.ax.draw_artist(puck.disp)

    # just redraw the axes rectangle
    self.canvas.blit(self.ax.bbox)

    if self.cnt == 50000:
        # just so we don't get carried away
        print("...and you've been playing for too long!!!")
        plt.close()

    self.cnt += 1
    return True

def key_press(self, event):
    if event.key == '3':
        self.res *= 5.0
    if event.key == '4':
        self.res /= 5.0

    if event.key == 'e':
        self.pads[0].y += .1
        if self.pads[0].y > 1 - .3:
            self.pads[0].y = 1 - .3
    if event.key == 'd':
        self.pads[0].y -= .1
        if self.pads[0].y < -1:
            self.pads[0].y = -1

    if event.key == 'i':
        self.pads[1].y += .1
        if self.pads[1].y > 1 - .3:
            self.pads[1].y = 1 - .3
    if event.key == 'k':
        self.pads[1].y -= .1
        if self.pads[1].y < -1:
            self.pads[1].y = -1

    if event.key == 'a':

```

```

        self.pucks.append(Puck(self.puckdisp, self.pads[randint(2)], self.ax.bbox))
    if event.key == 'A' and len(self.pucks):
        self.pucks.pop()
    if event.key == ' ' and len(self.pucks):
        self.pucks[0]._reset(self.pads[randint(2)])
    if event.key == '1':
        for p in self.pucks:
            p._slower()
    if event.key == '2':
        for p in self.pucks:
            p._faster()

    if event.key == 'n':
        self.distract = not self.distract

    if event.key == 'g':
        #self.ax.clear()
        self.on = not self.on
    if event.key == 't':
        self.inst = not self.inst
        self.i.set_visible(self.i.get_visible())
    if event.key == 'q':
        plt.close()

```

Keywords: python, matplotlib, pylab, example, codex (see [Search examples](#))

92.13 event_handling example code: poly_editor.py

[source code]

```

"""
This is an example to show how to build cross-GUI applications using
matplotlib event handling to interact with objects on the canvas

"""
import numpy as np
from matplotlib.lines import Line2D
from matplotlib.artist import Artist
from matplotlib.mlab import dist_point_to_segment

class PolygonInteractor(object):
    """
    An polygon editor.

    Key-bindings

    't' toggle vertex markers on and off.  When vertex markers are on,
        you can move them, delete them

    'd' delete the vertex under point

```

```

'i' insert a vertex at point. You must be within epsilon of the
line connecting two existing vertices

"""

showverts = True
epsilon = 5 # max pixel distance to count as a vertex hit

def __init__(self, ax, poly):
    if poly.figure is None:
        raise RuntimeError('You must first add the polygon to a figure or canvas.
↳before defining the interactor')
    self.ax = ax
    canvas = poly.figure.canvas
    self.poly = poly

    x, y = zip(*self.poly.xy)
    self.line = Line2D(x, y, marker='o', markerfacecolor='r', animated=True)
    self.ax.add_line(self.line)
    #self._update_line(poly)

    cid = self.poly.add_callback(self.poly_changed)
    self._ind = None # the active vert

    canvas.mpl_connect('draw_event', self.draw_callback)
    canvas.mpl_connect('button_press_event', self.button_press_callback)
    canvas.mpl_connect('key_press_event', self.key_press_callback)
    canvas.mpl_connect('button_release_event', self.button_release_callback)
    canvas.mpl_connect('motion_notify_event', self.motion_notify_callback)
    self.canvas = canvas

def draw_callback(self, event):
    self.background = self.canvas.copy_from_bbox(self.ax.bbox)
    self.ax.draw_artist(self.poly)
    self.ax.draw_artist(self.line)
    self.canvas.blit(self.ax.bbox)

def poly_changed(self, poly):
    'this method is called whenever the polygon object is called'
    # only copy the artist props to the line (except visibility)
    vis = self.line.get_visible()
    Artist.update_from(self.line, poly)
    self.line.set_visible(vis) # don't use the poly visibility state

def get_ind_under_point(self, event):
    'get the index of the vertex under point if within epsilon tolerance'

    # display coords
    xy = np.asarray(self.poly.xy)
    xyt = self.poly.get_transform().transform(xy)
    xt, yt = xyt[:, 0], xyt[:, 1]
    d = np.sqrt((xt - event.x)**2 + (yt - event.y)**2)

```

```

indseq = np.nonzero(np.equal(d, np.amin(d)))[0]
ind = indseq[0]

if d[ind] >= self.epsilon:
    ind = None

return ind

def button_press_callback(self, event):
    'whenever a mouse button is pressed'
    if not self.showverts:
        return
    if event.inaxes is None:
        return
    if event.button != 1:
        return
    self._ind = self.get_ind_under_point(event)

def button_release_callback(self, event):
    'whenever a mouse button is released'
    if not self.showverts:
        return
    if event.button != 1:
        return
    self._ind = None

def key_press_callback(self, event):
    'whenever a key is pressed'
    if not event.inaxes:
        return
    if event.key == 't':
        self.showverts = not self.showverts
        self.line.set_visible(self.showverts)
        if not self.showverts:
            self._ind = None
    elif event.key == 'd':
        ind = self.get_ind_under_point(event)
        if ind is not None:
            self.poly.xy = [tup for i, tup in enumerate(self.poly.xy) if i != ind]
            self.line.set_data(zip(*self.poly.xy))
    elif event.key == 'i':
        xys = self.poly.get_transform().transform(self.poly.xy)
        p = event.x, event.y # display coords
        for i in range(len(xys) - 1):
            s0 = xys[i]
            s1 = xys[i + 1]
            d = dist_point_to_segment(p, s0, s1)
            if d <= self.epsilon:
                self.poly.xy = np.array(
                    list(self.poly.xy[:i]) +
                    [(event.xdata, event.ydata)] +
                    list(self.poly.xy[i:]))
                self.line.set_data(zip(*self.poly.xy))

```



```

        break

    self.canvas.draw()

def motion_notify_callback(self, event):
    'on mouse movement'
    if not self.showverts:
        return
    if self._ind is None:
        return
    if event.inaxes is None:
        return
    if event.button != 1:
        return
    x, y = event.xdata, event.ydata

    self.poly.xy[self._ind] = x, y
    if self._ind == 0:
        self.poly.xy[-1] = x, y
    elif self._ind == len(self.poly.xy) - 1:
        self.poly.xy[0] = x, y
    self.line.set_data(zip(*self.poly.xy))

    self.canvas.restore_region(self.background)
    self.ax.draw_artist(self.poly)
    self.ax.draw_artist(self.line)
    self.canvas.blit(self.ax.bbox)

if __name__ == '__main__':
    import matplotlib.pyplot as plt
    from matplotlib.patches import Polygon

    theta = np.arange(0, 2*np.pi, 0.1)
    r = 1.5

    xs = r*np.cos(theta)
    ys = r*np.sin(theta)

    poly = Polygon(list(zip(xs, ys)), animated=True)

    fig, ax = plt.subplots()
    ax.add_patch(poly)
    p = PolygonInteractor(ax, poly)

    #ax.add_line(p.line)
    ax.set_title('Click and drag a point to move it')
    ax.set_xlim((-2, 2))
    ax.set_ylim((-2, 2))
    plt.show()

```

Keywords: python, matplotlib, pylab, example, codex (see [Search examples](#))

92.14 event_handling example code: pong_gtk.py

[source code]

```
from __future__ import print_function

# For detailed comments on animation and the techniques used here, see
# the wiki entry
# http://www.scipy.org/wikis/topical_software/MatplotlibAnimation
import time

import gobject

import matplotlib
matplotlib.use('GTKAgg')

import matplotlib.pyplot as plt
import pipong

fig, ax = plt.subplots()
canvas = ax.figure.canvas

def start_anim(event):
    # gobject.idle_add(animation.draw, animation)
    gobject.timeout_add(10, animation.draw, animation)
    canvas.mpl_disconnect(start_anim.cid)

animation = pipong.Game(ax)
start_anim.cid = canvas.mpl_connect('draw_event', start_anim)

tstart = time.time()
plt.grid() # to ensure proper background restore
plt.show()
print('FPS: %f' % animation.cnt/(time.time() - tstart))
```

Keywords: python, matplotlib, pylab, example, codex (see *Search examples*)

92.15 event_handling example code: resample.py

[source code]

```
import numpy as np
import matplotlib.pyplot as plt

# A class that will downsample the data and recompute when zoomed.
class DataDisplayDownsampler(object):
    def __init__(self, xdata, ydata):
```

```

self.origYData = ydata
self.origXData = xdata
self.ratio = 5
self.delta = xdata[-1] - xdata[0]

def downsample(self, xstart, xend):
    # Very simple downsampling that takes the points within the range
    # and picks every Nth point
    mask = (self.origXData > xstart) & (self.origXData < xend)
    xdata = self.origXData[mask]
    xdata = xdata[::self.ratio]

    ydata = self.origYData[mask]
    ydata = ydata[::self.ratio]

    return xdata, ydata

def update(self, ax):
    # Update the line
    lims = ax.viewLim
    if np.abs(lims.width - self.delta) > 1e-8:
        self.delta = lims.width
        xstart, xend = lims.intervalx
        self.line.set_data(*self.downsample(xstart, xend))
        ax.figure.canvas.draw_idle()

# Create a signal
xdata = np.linspace(16, 365, 365-16)
ydata = np.sin(2*np.pi*xdata/153) + np.cos(2*np.pi*xdata/127)

d = DataDisplayDownsampler(xdata, ydata)

fig, ax = plt.subplots()

# Hook up the line
d.line, = ax.plot(xdata, ydata, 'o-')
ax.set_autoscale_on(False) # Otherwise, infinite loop

# Connect for changing the view limits
ax.callbacks.connect('xlim_changed', d.update)

plt.show()

```

Keywords: python, matplotlib, pylab, example, codex (see [Search examples](#))

92.16 event_handling example code: test_mouseclicks.py

[source code]

```
from __future__ import print_function
```

```
import matplotlib
#matplotlib.use("WxAgg")
#matplotlib.use("TkAgg")
#matplotlib.use("GTKAgg")
#matplotlib.use("Qt4Agg")
#matplotlib.use("MacOSX")
import matplotlib.pyplot as plt

#print("***** TESTING WITH BACKEND: %s"%matplotlib.get_backend() + " *****")

def OnClick(event):
    if event.dblclick:
        print("DBLCLICK", event)
    else:
        print("DOWN    ", event)

def OnRelease(event):
    print("UP        ", event)

fig = plt.gcf()
cid_up = fig.canvas.mpl_connect('button_press_event', OnClick)
cid_down = fig.canvas.mpl_connect('button_release_event', OnRelease)

plt.gca().text(0.5, 0.5, "Click on the canvas to test mouse events.",
               ha="center", va="center")

plt.show()
```

Keywords: python, matplotlib, pylab, example, codex (see [Search examples](#))

92.17 event_handling example code: timers.py

[source code]

```
# Simple example of using general timer objects. This is used to update
# the time placed in the title of the figure.
import matplotlib.pyplot as plt
import numpy as np
from datetime import datetime

def update_title(axes):
    axes.set_title(datetime.now())
    axes.figure.canvas.draw()

fig, ax = plt.subplots()

x = np.linspace(-3, 3)
```

```

ax.plot(x, x*x)

# Create a new timer object. Set the interval to 100 milliseconds
# (1000 is default) and tell the timer what function should be called.
timer = fig.canvas.new_timer(interval=100)
timer.add_callback(update_title, ax)
timer.start()

# Or could start the timer on first figure draw
#def start_timer(evt):
#    timer.start()
#    fig.canvas.mpl_disconnect(drawid)
#drawid = fig.canvas.mpl_connect('draw_event', start_timer)

plt.show()

```

Keywords: python, matplotlib, pylab, example, codex (see [Search examples](#))

92.18 event_handling example code: trifinder_event_demo.py

[source code]

```

"""
Example showing the use of a TriFinder object. As the mouse is moved over the
triangulation, the triangle under the cursor is highlighted and the index of
the triangle is displayed in the plot title.
"""
import matplotlib.pyplot as plt
from matplotlib.tri import Triangulation
from matplotlib.patches import Polygon
import numpy as np
import math

def update_polygon(tri):
    if tri == -1:
        points = [0, 0, 0]
    else:
        points = triangulation.triangles[tri]
    xs = triangulation.x[points]
    ys = triangulation.y[points]
    polygon.set_xy(list(zip(xs, ys)))

def motion_notify(event):
    if event.inaxes is None:
        tri = -1
    else:
        tri = trifinder(event.xdata, event.ydata)
    update_polygon(tri)
    plt.title('In triangle %i' % tri)

```

```

event.canvas.draw()

# Create a Triangulation.
n_angles = 16
n_radii = 5
min_radius = 0.25
radii = np.linspace(min_radius, 0.95, n_radii)
angles = np.linspace(0, 2*math.pi, n_angles, endpoint=False)
angles = np.repeat(angles[..., np.newaxis], n_radii, axis=1)
angles[:, 1::2] += math.pi / n_angles
x = (radii*np.cos(angles)).flatten()
y = (radii*np.sin(angles)).flatten()
triangulation = Triangulation(x, y)
xmid = x[triangulation.triangles].mean(axis=1)
ymid = y[triangulation.triangles].mean(axis=1)
mask = np.where(xmid*xmid + ymid*ymid < min_radius*min_radius, 1, 0)
triangulation.set_mask(mask)

# Use the triangulation's default TriFinder object.
trifinder = triangulation.get_trifinder()

# Setup plot and callbacks.
plt.subplot(111, aspect='equal')
plt.triplot(triangulation, 'bo-')
polygon = Polygon([[0, 0], [0, 0]], facecolor='y') # dummy data for xs,ys
update_polygon(-1)
plt.gca().add_patch(polygon)
plt.gcf().canvas.mpl_connect('motion_notify_event', motion_notify)
plt.show()

```

Keywords: python, matplotlib, pylab, example, codex (see [Search examples](#))

92.19 event_handling example code: viewlims.py

[source code]

```

# Creates two identical panels. Zooming in on the right panel will show
# a rectangle in the first panel, denoting the zoomed region.
import numpy as np
import matplotlib.pyplot as plt
from matplotlib.patches import Rectangle

# We just subclass Rectangle so that it can be called with an Axes
# instance, causing the rectangle to update its shape to match the
# bounds of the Axes
class UpdatingRect(Rectangle):
    def __call__(self, ax):
        self.set_bounds(*ax.viewLim.bounds)
        ax.figure.canvas.draw_idle()

```

```

# A class that will regenerate a fractal set as we zoom in, so that you
# can actually see the increasing detail. A box in the left panel will show
# the area to which we are zoomed.
class MandelbrotDisplay(object):
    def __init__(self, h=500, w=500, niter=50, radius=2., power=2):
        self.height = h
        self.width = w
        self.niter = niter
        self.radius = radius
        self.power = power

    def __call__(self, xstart, xend, ystart, yend):
        self.x = np.linspace(xstart, xend, self.width)
        self.y = np.linspace(ystart, yend, self.height).reshape(-1, 1)
        c = self.x + 1.0j * self.y
        threshold_time = np.zeros((self.height, self.width))
        z = np.zeros(threshold_time.shape, dtype=np.complex)
        mask = np.ones(threshold_time.shape, dtype=np.bool)
        for i in range(self.niter):
            z[mask] = z[mask]**self.power + c[mask]
            mask = (np.abs(z) < self.radius)
            threshold_time += mask
        return threshold_time

    def ax_update(self, ax):
        ax.set_autoscale_on(False) # Otherwise, infinite loop

        # Get the number of points from the number of pixels in the window
        dims = ax.axesPatch.get_window_extent().bounds
        self.width = int(dims[2] + 0.5)
        self.height = int(dims[3] + 0.5)

        # Get the range for the new area
        xstart, ystart, xdelta, ydelta = ax.viewLim.bounds
        xend = xstart + xdelta
        yend = ystart + ydelta

        # Update the image object with our new data and extent
        im = ax.images[-1]
        im.set_data(self.__call__(xstart, xend, ystart, yend))
        im.set_extent((xstart, xend, ystart, yend))
        ax.figure.canvas.draw_idle()

md = MandelbrotDisplay()
Z = md(-2., 0.5, -1.25, 1.25)

fig1, (ax1, ax2) = plt.subplots(1, 2)
ax1.imshow(Z, origin='lower', extent=(md.x.min(), md.x.max(), md.y.min(), md.y.max()))
ax2.imshow(Z, origin='lower', extent=(md.x.min(), md.x.max(), md.y.min(), md.y.max()))

rect = UpdatingRect([0, 0], 0, 0, facecolor='None', edgecolor='black', linewidth=1.0)

```

```
rect.set_bounds(*ax2.viewLim.bounds)
ax1.add_patch(rect)

# Connect for changing the view limits
ax2.callbacks.connect('xlim_changed', rect)
ax2.callbacks.connect('ylim_changed', rect)

ax2.callbacks.connect('xlim_changed', md.ax_update)
ax2.callbacks.connect('ylim_changed', md.ax_update)
ax2.set_title("Zoom here")

plt.show()
```

Keywords: python, matplotlib, pylab, example, codex (see [Search examples](#))

92.20 event_handling example code: zoom_window.py

[source code]

```
"""
This example shows how to connect events in one window, for example, a mouse
press, to another figure window.

If you click on a point in the first window, the x and y limits of the
second will be adjusted so that the center of the zoom in the second
window will be the x,y coordinates of the clicked point.

Note the diameter of the circles in the scatter are defined in
points**2, so their size is independent of the zoom
"""
from matplotlib.pyplot import figure, show
import numpy
figsrc = figure()
figzoom = figure()

axsrc = figsrc.add_subplot(111, xlim=(0, 1), ylim=(0, 1), autoscale_on=False)
axzoom = figzoom.add_subplot(111, xlim=(0.45, 0.55), ylim=(0.4, .6),
                             autoscale_on=False)
axsrc.set_title('Click to zoom')
axzoom.set_title('zoom window')
x, y, s, c = numpy.random.rand(4, 200)
s *= 200

axsrc.scatter(x, y, s, c)
axzoom.scatter(x, y, s, c)

def onpress(event):
    if event.button != 1:
        return
```



```
x, y = event.xdata, event.ydata
axzoom.set_xlim(x - 0.1, x + 0.1)
axzoom.set_ylim(y - 0.1, y + 0.1)
figzoom.canvas.draw()

figsrc.canvas.mpl_connect('button_press_event', onpress)
show()
```

Keywords: python, matplotlib, pylab, example, codex (see [Search examples](#))

FRONTPAGE EXAMPLES

93.1 frontpage example code: plot_3D.py

[source code]

```
"""
=====
Frontpage 3D example
=====

This example reproduces the frontpage 3D example.

"""
from mpl_toolkits.mplot3d import Axes3D
from matplotlib import cbook
from matplotlib import cm
from matplotlib.colors import LightSource
import matplotlib.pyplot as plt
import numpy as np

filename = cbook.get_sample_data('jacksboro_fault_dem.npz', asfileobj=False)
with np.load(filename) as dem:
    z = dem['elevation']
    nrows, ncols = z.shape
    x = np.linspace(dem['xmin'], dem['xmax'], ncols)
    y = np.linspace(dem['ymin'], dem['ymax'], nrows)
    x, y = np.meshgrid(x, y)

region = np.s_[5:50, 5:50]
x, y, z = x[region], y[region], z[region]

fig, ax = plt.subplots(subplot_kw=dict(projection='3d'))

ls = LightSource(270, 45)
# To use a custom hillshading mode, override the built-in shading and pass
# in the rgb colors of the shaded surface calculated from "shade".
rgb = ls.shade(z, cmap=cm.gist_earth, vert_exag=0.1, blend_mode='soft')
surf = ax.plot_surface(x, y, z, rstride=1, cstride=1, facecolors=rgb,
                      linewidth=0, antialiased=False, shade=False)
ax.set_xticks([])
```

```
ax.set_yticks([])
ax.set_zticks([])
fig.savefig("surface3d_frontpage.png", dpi=25) # results in 160x120 px image
```

Keywords: python, matplotlib, pylab, example, codex (see *Search examples*)

93.2 frontpage example code: plot_contour.py

[source code]

```
"""
=====
Frontpage contour example
=====

This example reproduces the frontpage contour example.
"""

import matplotlib.pyplot as plt
import numpy as np
from matplotlib import mlab, cm

extent = (-3, 3, -3, 3)

delta = 0.5
x = np.arange(-3.0, 4.001, delta)
y = np.arange(-4.0, 3.001, delta)
X, Y = np.meshgrid(x, y)
Z1 = mlab.bivariate_normal(X, Y, 1.0, 1.0, 0.0, -0.5)
Z2 = mlab.bivariate_normal(X, Y, 1.5, 0.5, 1, 1)
Z = (Z1 - Z2) * 10

levels = np.linspace(-2.0, 1.601, 40)
norm = cm.colors.Normalize(vmax=abs(Z).max(), vmin=-abs(Z).max())

fig, ax = plt.subplots()
cset1 = ax.contourf(
    X, Y, Z, levels,
    norm=norm)
ax.set_xlim(-3, 3)
ax.set_ylim(-3, 3)
ax.set_xticks([])
ax.set_yticks([])
fig.savefig("contour_frontpage.png", dpi=25) # results in 160x120 px image
```

Keywords: python, matplotlib, pylab, example, codex (see *Search examples*)

93.3 frontpage example code: plot_histogram.py

[source code]

```

"""
=====
Frontpage histogram example
=====

This example reproduces the frontpage histogram example.
"""

import matplotlib.pyplot as plt
import numpy as np

random_state = np.random.RandomState(19680801)
X = random_state.randn(10000)

fig, ax = plt.subplots()
ax.hist(X, bins=25, normed=True)
x = np.linspace(-5, 5, 1000)
ax.plot(x, 1 / np.sqrt(2*np.pi) * np.exp(-(x**2)/2), linewidth=4)
ax.set_xticks([])
ax.set_yticks([])
fig.savefig("histogram_frontpage.png", dpi=25) # results in 160x120 px image

```

Keywords: python, matplotlib, pylab, example, codex (see *Search examples*)

93.4 frontpage example code: plot_membrane.py

[source code]

```

"""
=====
Frontpage plot example
=====

This example reproduces the frontpage simple plot example.
"""

import matplotlib.pyplot as plt
import matplotlib.cbook as cbook
import numpy as np

datafile = cbook.get_sample_data('membrane.dat', asfileobj=False)
x = np.fromfile(datafile, np.float32)
# 0.0005 is the sample interval

```

```
fig, ax = plt.subplots()
ax.plot(x, linewidth=4)
ax.set_xlim(5000, 6000)
ax.set_ylim(-0.6, 0.1)
ax.set_xticks([])
ax.set_yticks([])
fig.savefig("membrane_frontpage.png", dpi=25) # results in 160x120 px image
```

Keywords: python, matplotlib, pylab, example, codex (see *Search examples*)

IMAGES_CONTOURS_AND_FIELDS EXAMPLES

94.1 images_contours_and_fields example code: contourf_log.py

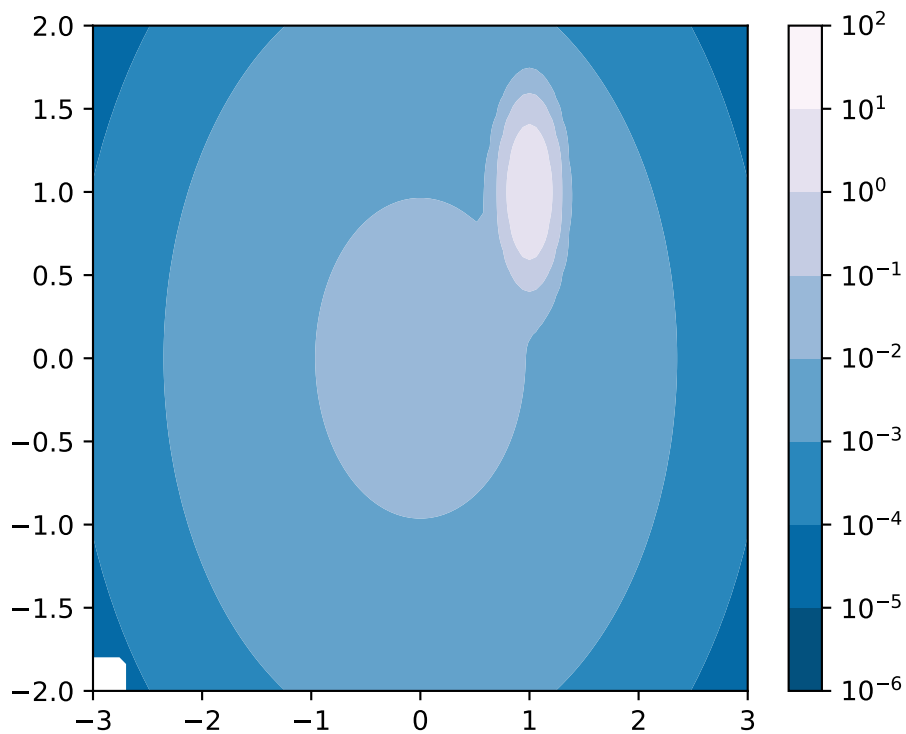

```
"""  
Demonstrate use of a log color scale in contourf  
"""  
  
import matplotlib.pyplot as plt  
import numpy as np  
from numpy import ma  
from matplotlib import colors, ticker, cm  
from matplotlib.mlab import bivariate_normal
```

```
N = 100
x = np.linspace(-3.0, 3.0, N)
y = np.linspace(-2.0, 2.0, N)

X, Y = np.meshgrid(x, y)

# A low hump with a spike coming out of the top right.
# Needs to have z/colour axis on a log scale so we see both hump and spike.
# linear scale only shows the spike.
z = (bivariate_normal(X, Y, 0.1, 0.2, 1.0, 1.0)
      + 0.1 * bivariate_normal(X, Y, 1.0, 1.0, 0.0, 0.0))

# Put in some negative values (lower left corner) to cause trouble with logs:
z[:5, :5] = -1

# The following is not strictly essential, but it will eliminate
# a warning. Comment it out to see the warning.
z = ma.masked_where(z <= 0, z)

# Automatic selection of levels works; setting the
# log locator tells contourf to use a log scale:
fig, ax = plt.subplots()
cs = ax.contourf(X, Y, z, locator=ticker.LogLocator(), cmap=cm.PuBu_r)

# Alternatively, you can manually set the levels
# and the norm:
#lev_exp = np.arange(np.floor(np.log10(z.min()))-1,
#                    np.ceil(np.log10(z.max()))+1)
#levs = np.power(10, lev_exp)
#cs = P.contourf(X, Y, z, levs, norm=colors.LogNorm())

# The 'extend' kwarg does not work yet with a log scale.

cbar = fig.colorbar(cs)

plt.show()
```

Keywords: python, matplotlib, pylab, example, codex (see [Search examples](#))

94.2 images_contours_and_fields example code: image_demo.py



```
"""
Simple demo of the imshow function.
"""
import matplotlib.pyplot as plt
import matplotlib.cbook as cbook

image_file = cbook.get_sample_data('ada.png')
image = plt.imread(image_file)

fig, ax = plt.subplots()
ax.imshow(image)
ax.axis('off') # clear x- and y-axes
plt.show()
```

Keywords: python, matplotlib, pylab, example, codex (see [Search examples](#))

94.3 images_contours_and_fields
age_demo_clip_path.py

example

code:

im-



```
"""
Demo of image that's been clipped by a circular patch.
"""
import matplotlib.pyplot as plt
import matplotlib.patches as patches
import matplotlib.cbook as cbook

image_file = cbook.get_sample_data('grace_hopper.png')
image = plt.imread(image_file)

fig, ax = plt.subplots()
im = ax.imshow(image)
patch = patches.Circle((260, 200), radius=200, transform=ax.transData)
im.set_clip_path(patch)

ax.axis('off')
plt.show()
```

Keywords: python, matplotlib, pylab, example, codex (see [Search examples](#))

94.4 images_contours_and_fields example code: interpolation_methods.py

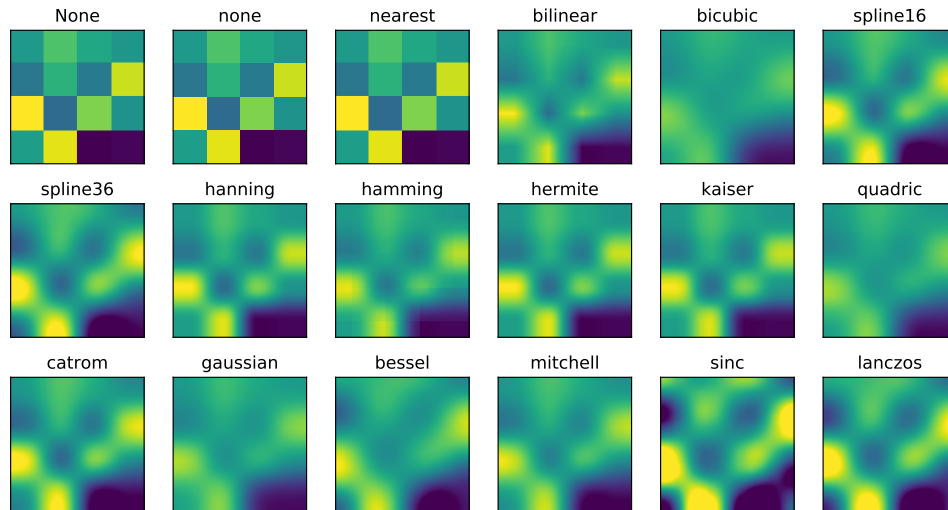

```

"""
Show all different interpolation methods for imshow
"""

import matplotlib.pyplot as plt
import numpy as np

# from the docs:

# If interpolation is None, default to rc image.interpolation. See also
# the filternorm and filterrad parameters. If interpolation is 'none', then
# no interpolation is performed on the Agg, ps and pdf backends. Other
# backends will fall back to 'nearest'.
#
# http://matplotlib.org/api/pyplot_api.html#matplotlib.pyplot.imshow

methods = [None, 'none', 'nearest', 'bilinear', 'bicubic', 'spline16',
           'spline36', 'hanning', 'hamming', 'hermite', 'kaiser', 'quadric',
           'catrom', 'gaussian', 'bessel', 'mitchell', 'sinc', 'lanczos']

np.random.seed(0)
grid = np.random.rand(4, 4)

fig, axes = plt.subplots(3, 6, figsize=(12, 6),
                        subplot_kw={'xticks': [], 'yticks': []})

fig.subplots_adjust(hspace=0.3, wspace=0.05)

```

```

for ax, interp_method in zip(axes.flat, methods):
    ax.imshow(grid, interpolation=interp_method, cmap='viridis')
    ax.set_title(interp_method)

plt.show()

```

Keywords: python, matplotlib, pylab, example, codex (see [Search examples](#))

94.5 images_contours_and_fields example code: pcolormesh_levels.py

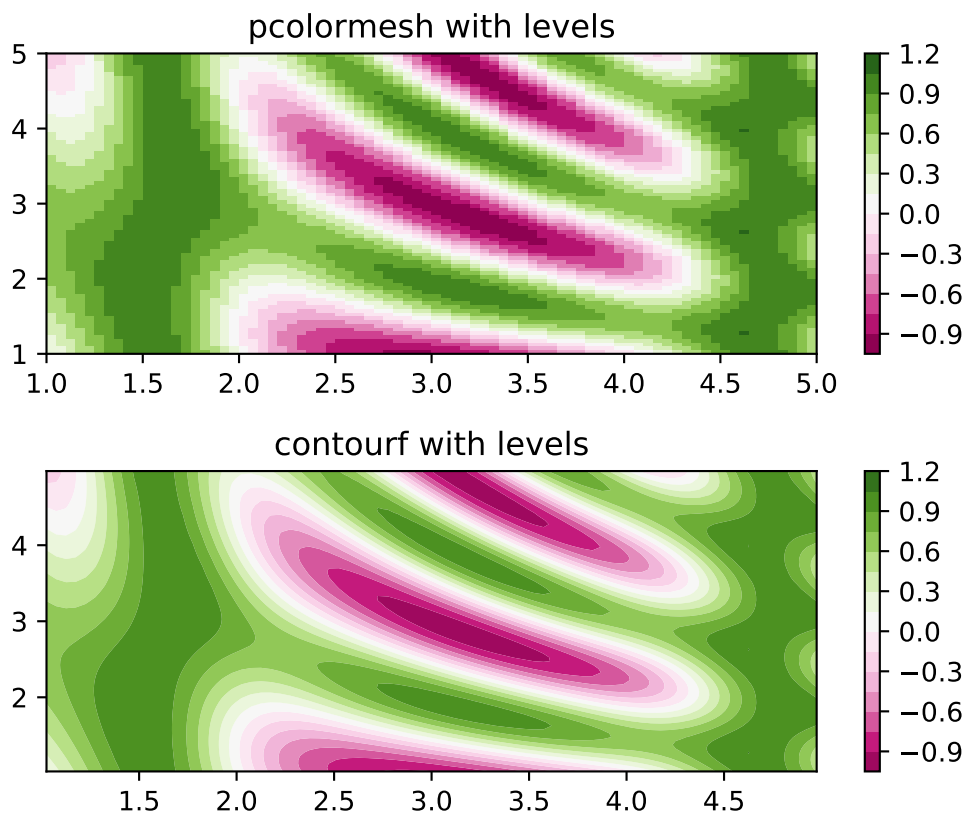

```

"""
Shows how to combine Normalization and Colormap instances to draw
"levels" in pcolor, pcolormesh and imshow type plots in a similar
way to the levels keyword argument to contour/contourf.
"""

```

```

"""
import matplotlib.pyplot as plt
from matplotlib.colors import BoundaryNorm
from matplotlib.ticker import MaxNLocator
import numpy as np

```

```

# make these smaller to increase the resolution
dx, dy = 0.05, 0.05

# generate 2 2d grids for the x & y bounds
y, x = np.mgrid[slice(1, 5 + dy, dy),
                slice(1, 5 + dx, dx)]

z = np.sin(x)**10 + np.cos(10 + y*x) * np.cos(x)

# x and y are bounds, so z should be the value *inside* those bounds.
# Therefore, remove the last value from the z array.
z = z[:-1, :-1]
levels = MaxNLocator(nbins=15).tick_values(z.min(), z.max())

# pick the desired colormap, sensible levels, and define a normalization
# instance which takes data values and translates those into levels.
cmap = plt.get_cmap('PiYG')
norm = BoundaryNorm(levels, ncolors=cmap.N, clip=True)

fig, (ax0, ax1) = plt.subplots(nrows=2)

im = ax0.pcolormesh(x, y, z, cmap=cmap, norm=norm)
fig.colorbar(im, ax=ax0)
ax0.set_title('pcolormesh with levels')

# contours are *point* based plots, so convert our bound into point
# centers
cf = ax1.contourf(x[:-1, :-1] + dx/2.,
                 y[:-1, :-1] + dy/2., z, levels=levels,
                 cmap=cmap)
fig.colorbar(cf, ax=ax1)
ax1.set_title('contourf with levels')

# adjust spacing between subplots so `ax1` title and `ax0` tick labels
# don't overlap
fig.tight_layout()

plt.show()

```

Keywords: python, matplotlib, pylab, example, codex (see [Search examples](#))

94.6 images_contours_and_fields
plot_demo_features.py

example

code:

stream-

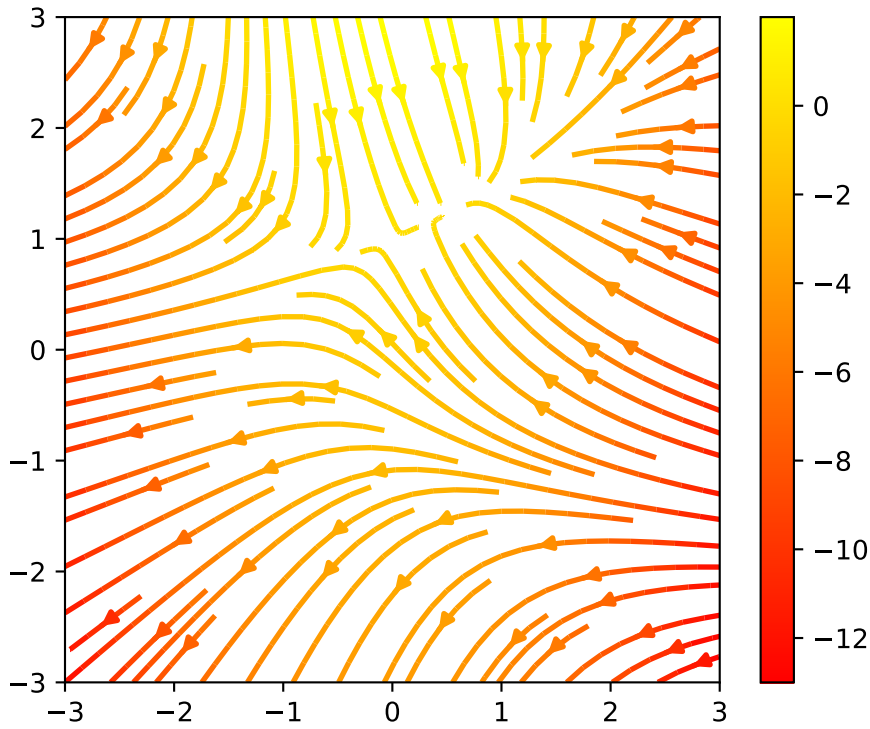

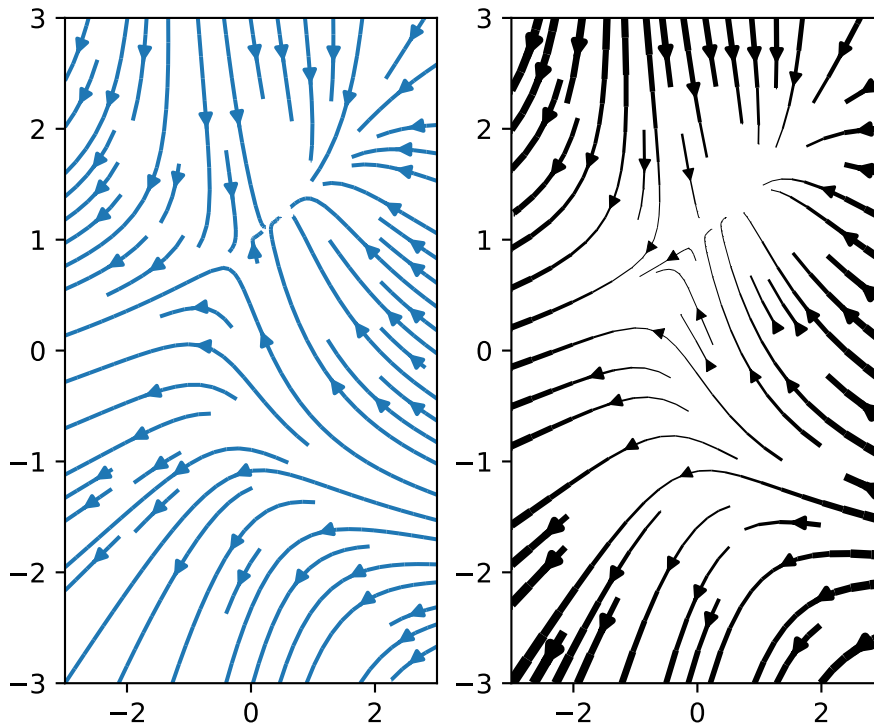

```

"""
Demo of the `streamplot` function.

A streamplot, or streamline plot, is used to display 2D vector fields. This
example shows a few features of the stream plot function:

    * Varying the color along a streamline.
    * Varying the density of streamlines.
    * Varying the line width along a stream line.
"""
import numpy as np
import matplotlib.pyplot as plt

Y, X = np.mgrid[-3:3:100j, -3:3:100j]
U = -1 - X**2 + Y
V = 1 + X - Y**2
speed = np.sqrt(U*U + V*V)

fig0, ax0 = plt.subplots()
strm = ax0.streamplot(X, Y, U, V, color=U, linewidth=2, cmap=plt.cm.autumn)
fig0.colorbar(strm.lines)

fig1, (ax1, ax2) = plt.subplots(ncols=2)
ax1.streamplot(X, Y, U, V, density=[0.5, 1])

lw = 5*speed / speed.max()

```

```
ax2.streamplot(X, Y, U, V, density=0.6, color='k', linewidth=lw)

plt.show()
```

Keywords: python, matplotlib, pylab, example, codex (see [Search examples](#))

94.7 images_contours_and_fields example code: stream-plot_demo_masking.py

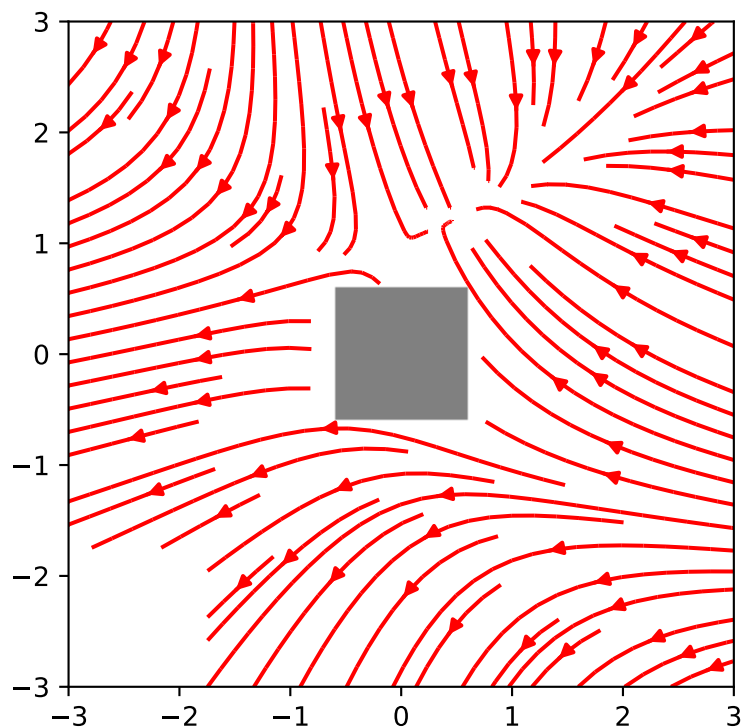

```
"""
Demo of the streamplot function with masking.

This example shows how streamlines created by the streamplot function skips
masked regions and NaN values.
"""
import numpy as np
import matplotlib.pyplot as plt

w = 3
Y, X = np.mgrid[-w:w:100j, -w:w:100j]
U = -1 - X**2 + Y
V = 1 + X - Y**2
```



```

speed = np.sqrt(U*U + V*V)

mask = np.zeros(U.shape, dtype=bool)
mask[40:60, 40:60] = True
U[:20, :20] = np.nan
U = np.ma.array(U, mask=mask)

fig, ax = plt.subplots()
ax.streamplot(X, Y, U, V, color='r')

ax.imshow(~mask, extent=(-w, w, -w, w), alpha=0.5,
          interpolation='nearest', cmap=plt.cm.gray)

plt.show()

```

Keywords: python, matplotlib, pylab, example, codex (see [Search examples](#))

94.8 images_contours_and_fields example code: streamplot_demo_start_points.py

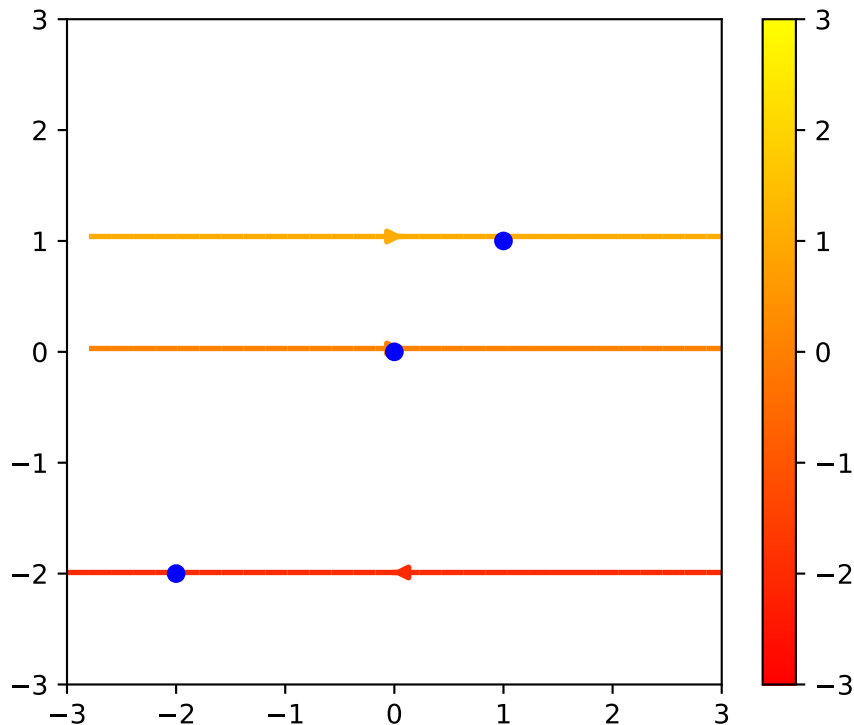

```

"""
Demo of the `streamplot` function.

```

A streamplot, or streamline plot, is used to display 2D vector fields. This example shows a few features of the stream plot function:

```
* Varying the color along a streamline.
* Varying the density of streamlines.
* Varying the line width along a stream line.
"""
import numpy as np
import matplotlib.pyplot as plt

X, Y = (np.linspace(-3, 3, 100),
        np.linspace(-3, 3, 100))

U, V = np.mgrid[-3:3:100j, 0:0:100j]

seed_points = np.array([[ -2,  0,  1], [ -2,  0,  1]])

fig0, ax0 = plt.subplots()
strm = ax0.streamplot(X, Y, U, V, color=U, linewidth=2,
                    cmap=plt.cm.autumn, start_points=seed_points.T)
fig0.colorbar(strm.lines)

ax0.plot(seed_points[0], seed_points[1], 'bo')

ax0.axis((-3, 3, -3, 3))

plt.show()
```

Keywords: python, matplotlib, pylab, example, codex (see [Search examples](#))

LINES_BARS_AND_MARKERS EXAMPLES

95.1 lines_bars_and_markers example code: barh_demo.py

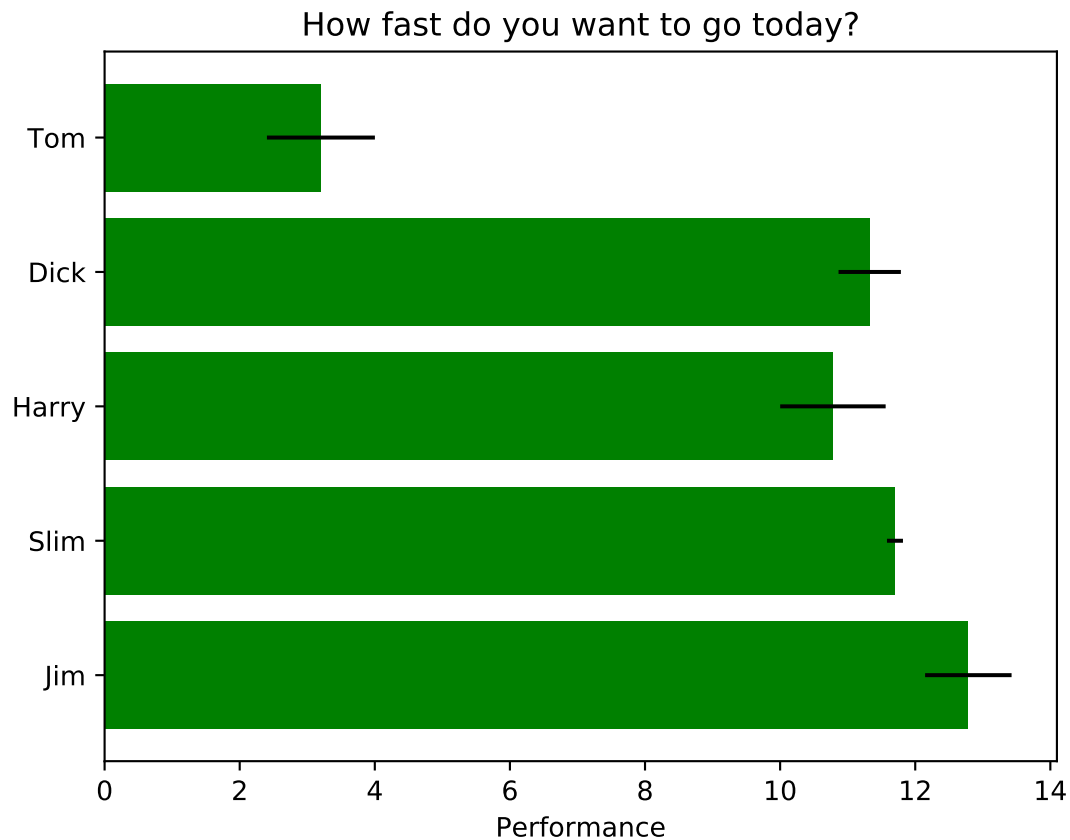

```
"""  
=====   
Horizontal bar chart  
=====   
  
This example showcases a simple horizontal bar chart.  
"""
```

```
import matplotlib.pyplot as plt
plt.rcParams()
import numpy as np
import matplotlib.pyplot as plt

plt.rcParams()
fig, ax = plt.subplots()

# Example data
people = ('Tom', 'Dick', 'Harry', 'Slim', 'Jim')
y_pos = np.arange(len(people))
performance = 3 + 10 * np.random.rand(len(people))
error = np.random.rand(len(people))

ax.barh(y_pos, performance, xerr=error, align='center',
        color='green', ecolor='black')
ax.set_yticks(y_pos)
ax.set_yticklabels(people)
ax.invert_yaxis() # labels read top-to-bottom
ax.set_xlabel('Performance')
ax.set_title('How fast do you want to go today?')

plt.show()
```

Keywords: python, matplotlib, pylab, example, codex (see [Search examples](#))

95.2 lines_bars_and_markers example code: fill_demo.py

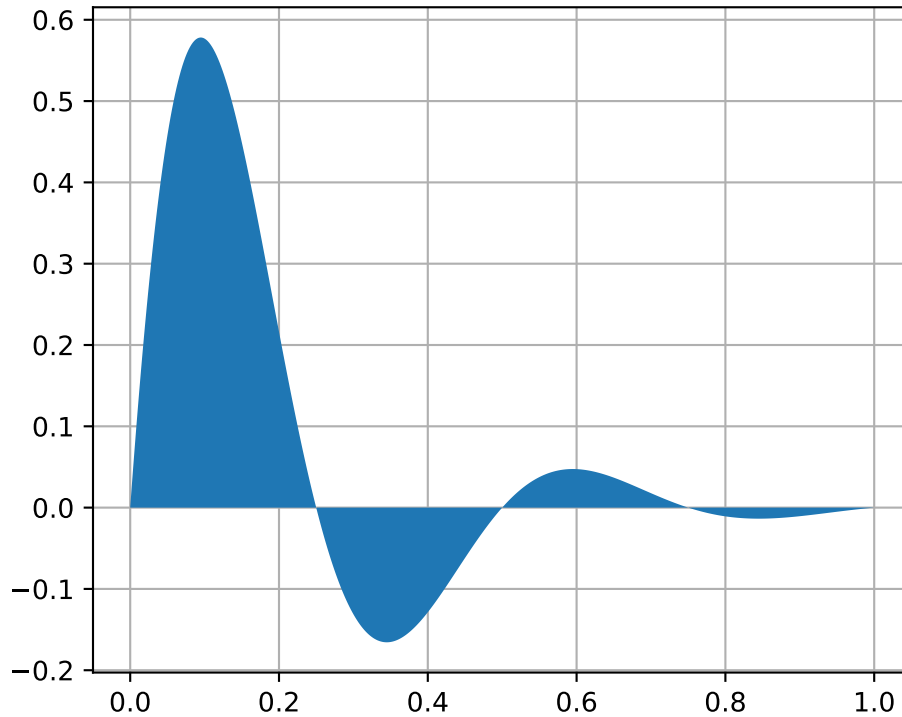

```
"""
=====
A simple Fill plot
=====

This example showcases the most basic fill plot a user can do with matplotlib.
"""
import numpy as np
import matplotlib.pyplot as plt

x = np.linspace(0, 1, 500)
y = np.sin(4 * np.pi * x) * np.exp(-5 * x)

fig, ax = plt.subplots()

ax.fill(x, y, zorder=10)
ax.grid(True, zorder=5)
plt.show()
```

Keywords: python, matplotlib, pylab, example, codex (see [Search examples](#))

95.3 lines_bars_and_markers example code: fill_demo_features.py

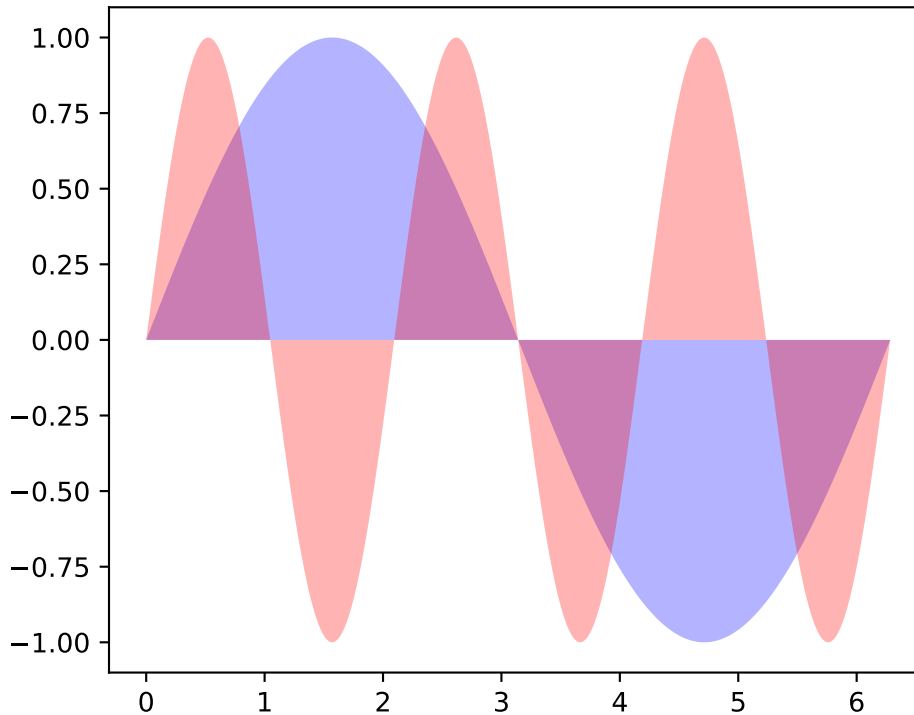

```
"""
=====
A more complex fill demo
=====

In addition to the basic fill plot, this demo shows a few optional features:

    * Multiple curves with a single command.
    * Setting the fill color.
    * Setting the opacity (alpha value).
"""
import numpy as np
import matplotlib.pyplot as plt

x = np.linspace(0, 2 * np.pi, 500)
y1 = np.sin(x)
y2 = np.sin(3 * x)

fig, ax = plt.subplots()
ax.fill(x, y1, 'b', x, y2, 'r', alpha=0.3)
plt.show()
```

Keywords: python, matplotlib, pylab, example, codex (see [Search examples](#))

95.4 lines_bars_and_markers example code: line_demo_dash_control.py

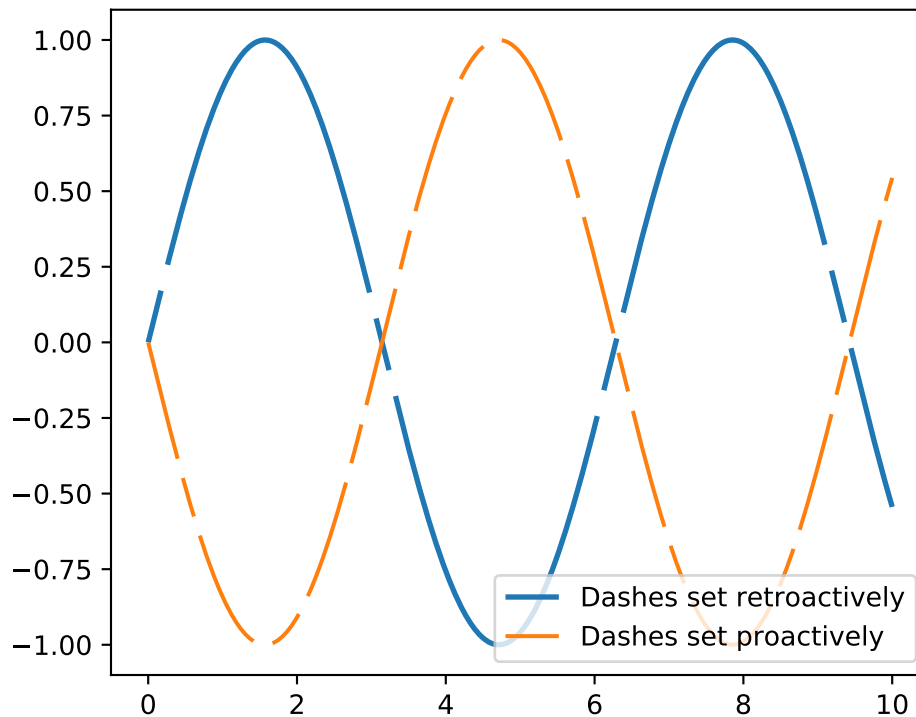

```

"""
=====
A simple plot with a custom dashed line
=====

A Line object's ``set_dashes`` method allows you to specify dashes with
a series of on/off lengths (in points).
"""
import numpy as np
import matplotlib.pyplot as plt

x = np.linspace(0, 10, 500)
dashes = [10, 5, 100, 5] # 10 points on, 5 off, 100 on, 5 off

fig, ax = plt.subplots()
line1, = ax.plot(x, np.sin(x), '--', linewidth=2,
                 label='Dashes set retroactively')
line1.set_dashes(dashes)

```

```
line2, = ax.plot(x, -1 * np.sin(x), dashes=[30, 5, 10, 5],
                 label='Dashes set proactively')

ax.legend(loc='lower right')
plt.show()
```

Keywords: python, matplotlib, pylab, example, codex (see *Search examples*)

95.5 lines_bars_and_markers example code: line_styles_reference.py

line styles



```
"""
=====
Line-style reference
=====

Reference for line-styles included with Matplotlib.
"""
import numpy as np
import matplotlib.pyplot as plt
```



```
color = 'cornflowerblue'
points = np.ones(5) # Draw 5 points for each line
text_style = dict(horizontalalignment='right', verticalalignment='center',
                   fontsize=12, fontdict={'family': 'monospace'})

def format_axes(ax):
    ax.margins(0.2)
    ax.set_axis_off()

def nice_repr(text):
    return repr(text).lstrip('u')

# Plot all line styles.
fig, ax = plt.subplots()

linestyles = ['-', '--', '-.', ':']
for y, linestyle in enumerate(linestyles):
    ax.text(-0.1, y, nice_repr(linestyle), **text_style)
    ax.plot(y * points, linestyle=linestyle, color=color, linewidth=3)
    format_axes(ax)
    ax.set_title('line styles')

plt.show()
```

Keywords: python, matplotlib, pylab, example, codex (see [Search examples](#))

95.6 lines_bars_and_markers example code: linestyle.py

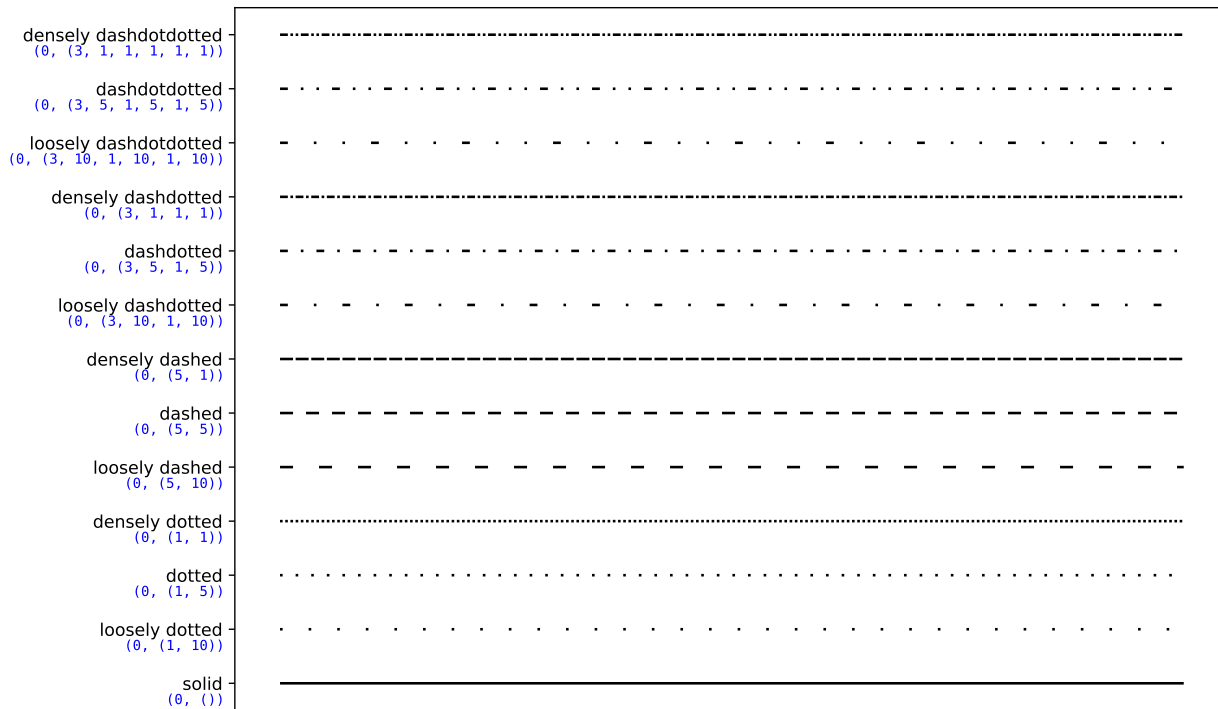

```

"""
=====
Linestyles
=====

This examples showcases different linestyles copying those of Tikz/PGF.
"""
import numpy as np
import matplotlib.pyplot as plt
from collections import OrderedDict
from matplotlib.transforms import blended_transform_factory

linestyles = OrderedDict(
    [('solid', (0, ())),
     ('loosely dotted', (0, (1, 10))),
     ('dotted', (0, (1, 5))),
     ('densely dotted', (0, (1, 1))),

     ('loosely dashed', (0, (5, 10))),
     ('dashed', (0, (5, 5))),
     ('densely dashed', (0, (5, 1))),

     ('loosely dashdotted', (0, (3, 10, 1, 10))),
     ('dashdotted', (0, (3, 5, 1, 5))),
     ('densely dashdotted', (0, (3, 1, 1, 1))),

```

```
    ('loosely dashdotdotted', (0, (3, 10, 1, 10, 1, 10))),
    ('dashdotdotted',        (0, (3, 5, 1, 5, 1, 5))),
    ('densely dashdotdotted', (0, (3, 1, 1, 1, 1, 1)))]

plt.figure(figsize=(10, 6))
ax = plt.subplot(1, 1, 1)

X, Y = np.linspace(0, 100, 10), np.zeros(10)
for i, (name, linestyle) in enumerate(linestyles.items()):
    ax.plot(X, Y+i, linestyle=linestyle, linewidth=1.5, color='black')

ax.set_ylim(-0.5, len(linestyles)-0.5)
plt.yticks(np.arange(len(linestyles)), linestyles.keys())
plt.xticks([])

# For each line style, add a text annotation with a small offset from
# the reference point (0 in Axes coords, y tick value in Data coords).
reference_transform = blended_transform_factory(ax.transAxes, ax.transData)
for i, (name, linestyle) in enumerate(linestyles.items()):
    ax.annotate(str(linestyle), xy=(0.0, i), xycoords=reference_transform,
               xytext=(-6, -12), textcoords='offset points', color="blue",
               fontsize=8, ha="right", family="monospace")

plt.tight_layout()
plt.show()
```

Keywords: python, matplotlib, pylab, example, codex (see [Search examples](#))

95.7 lines_bars_and_markers example code: marker_fillstyle_reference.py

fill style

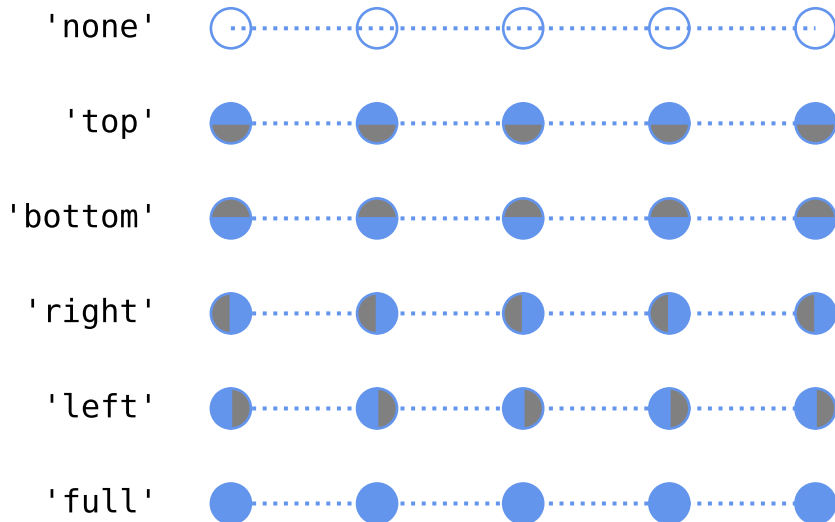

```

"""
=====
Marker filling-styles
=====

Reference for marker fill-styles included with Matplotlib.
"""
import numpy as np
import matplotlib.pyplot as plt
from matplotlib.lines import Line2D

points = np.ones(5) # Draw 3 points for each line
text_style = dict(horizontalalignment='right', verticalalignment='center',
                   fontsize=12, fontdict={'family': 'monospace'})
marker_style = dict(color='cornflowerblue', linestyle=':', marker='o',
                    markersize=15, markerfacecoloralt='gray')

def format_axes(ax):
    ax.margins(0.2)
    ax.set_axis_off()

```

```

def nice_repr(text):
    return repr(text).lstrip('u')

fig, ax = plt.subplots()

# Plot all fill styles.
for y, fill_style in enumerate(Line2D.fillStyles):
    ax.text(-0.5, y, nice_repr(fill_style), **text_style)
    ax.plot(y * points, fillstyle=fill_style, **marker_style)
    format_axes(ax)
    ax.set_title('fill style')

plt.show()

```

Keywords: python, matplotlib, pylab, example, codex (see [Search examples](#))

95.8 lines_bars_and_markers example code: marker_reference.py

un-filled markers

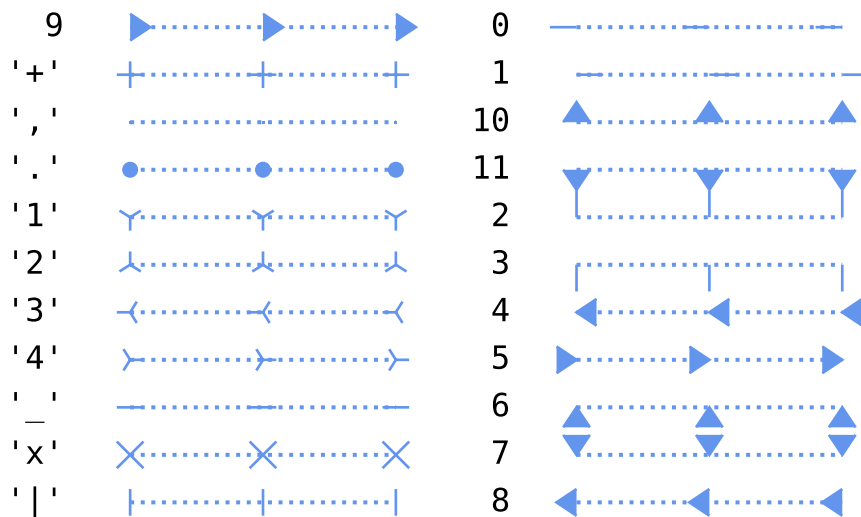

filled markers

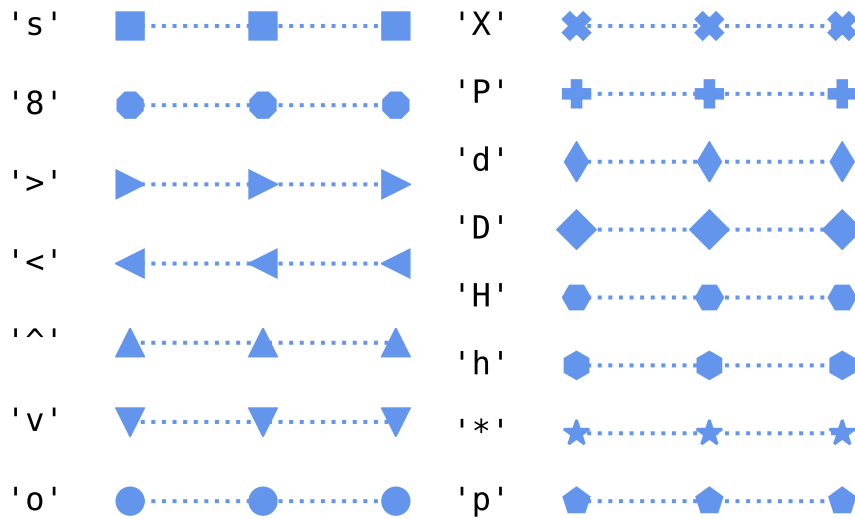

```

"""
=====
Filled and unfilled-marker types
=====

Reference for filled- and unfilled-marker types included with Matplotlib.
"""
from six import iteritems
import numpy as np
import matplotlib.pyplot as plt
from matplotlib.lines import Line2D

points = np.ones(3) # Draw 3 points for each line
text_style = dict(horizontalalignment='right', verticalalignment='center',
                   fontsize=12, fontdict={'family': 'monospace'})
marker_style = dict(linestyle=':', color='cornflowerblue', markersize=10)

def format_axes(ax):
    ax.margins(0.2)
    ax.set_axis_off()

def nice_repr(text):
    return repr(text).rstrip('u')

```

```

def split_list(a_list):
    i_half = len(a_list) // 2
    return (a_list[:i_half], a_list[i_half:])

# Plot all un-filled markers
# -----

fig, axes = plt.subplots(ncols=2)

# Filter out filled markers and marker settings that do nothing.
# We use iteritems from six to make sure that we get an iterator
# in both python 2 and 3
unfilled_markers = [m for m, func in iteritems(Line2D.markers)
                    if func != 'nothing' and m not in Line2D.filled_markers]
# Reverse-sort for pretty. We use our own sort key which is essentially
# a python3 compatible reimplementation of python2 sort.
unfilled_markers = sorted(unfilled_markers,
                          key=lambda x: (str(type(x)), str(x)))[::-1]
for ax, markers in zip(axes, split_list(unfilled_markers)):
    for y, marker in enumerate(markers):
        ax.text(-0.5, y, nice_repr(marker), **text_style)
        ax.plot(y * points, marker=marker, **marker_style)
        format_axes(ax)
fig.suptitle('un-filled markers', fontsize=14)

# Plot all filled markers.
# -----

fig, axes = plt.subplots(ncols=2)
for ax, markers in zip(axes, split_list(Line2D.filled_markers)):
    for y, marker in enumerate(markers):
        ax.text(-0.5, y, nice_repr(marker), **text_style)
        ax.plot(y * points, marker=marker, **marker_style)
        format_axes(ax)
fig.suptitle('filled markers', fontsize=14)

plt.show()

```

Keywords: python, matplotlib, pylab, example, codex (see [Search examples](#))

95.9 lines_bars_and_markers example code: scatter_with_legend.py

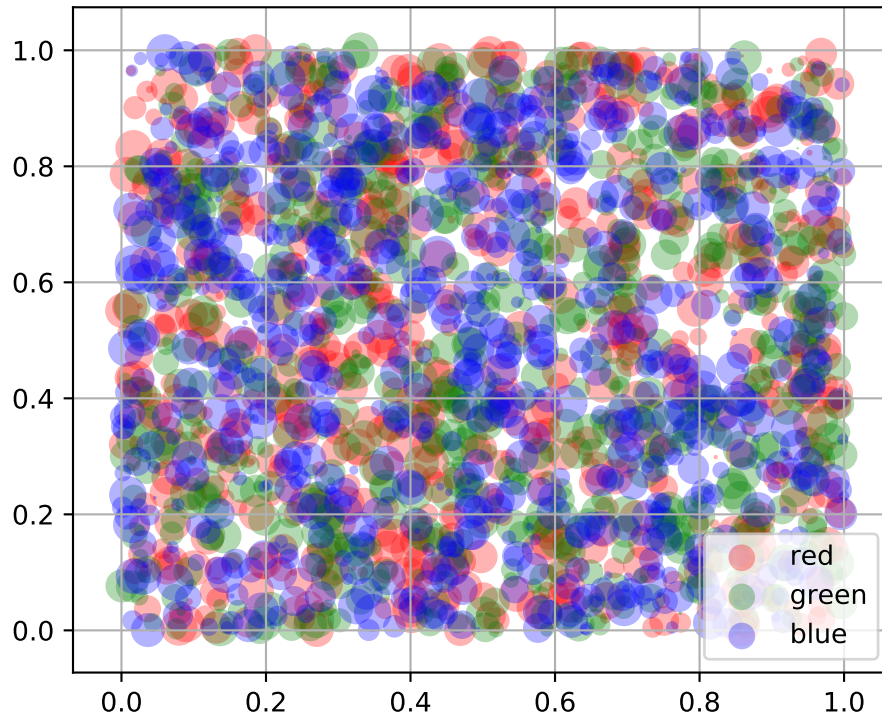

```
import matplotlib.pyplot as plt
from numpy.random import rand

fig, ax = plt.subplots()
for color in ['red', 'green', 'blue']:
    n = 750
    x, y = rand(2, n)
    scale = 200.0 * rand(n)
    ax.scatter(x, y, c=color, s=scale, label=color,
              alpha=0.3, edgecolors='none')

ax.legend()
ax.grid(True)

plt.show()
```

Keywords: python, matplotlib, pylab, example, codex (see [Search examples](#))

MISC EXAMPLES

96.1 misc example code: `contour_manual.py`

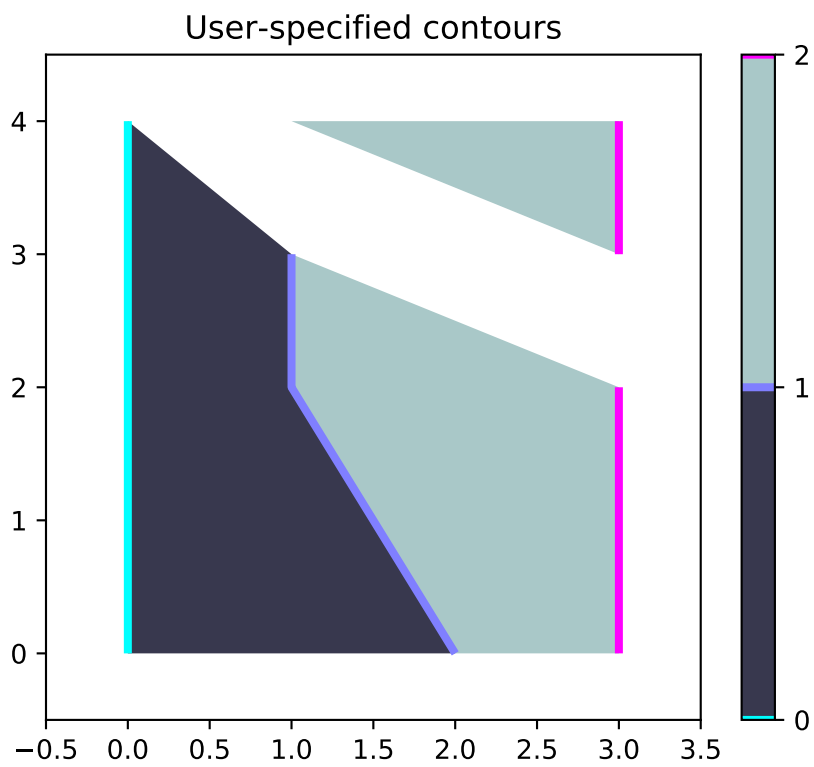

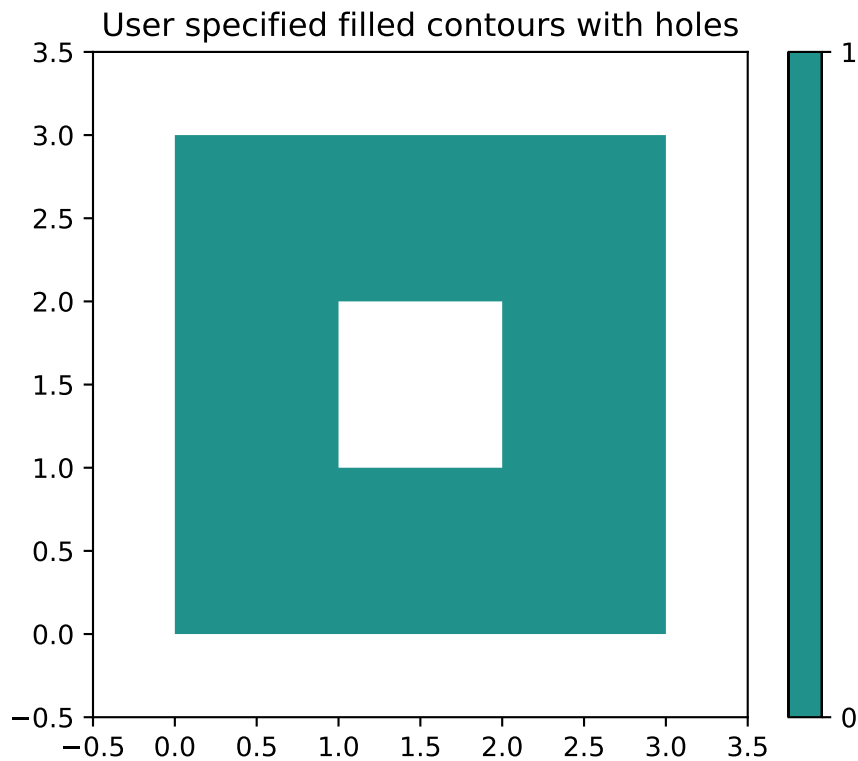

```

"""
Example of displaying your own contour lines and polygons using ContourSet.
"""
import matplotlib.pyplot as plt
from matplotlib.contour import ContourSet
import matplotlib.cm as cm

# Contour lines for each level are a list/tuple of polygons.
lines0 = [[[0, 0], [0, 4]]]
lines1 = [[[2, 0], [1, 2], [1, 3]]]
lines2 = [[[3, 0], [3, 2]], [[3, 3], [3, 4]]] # Note two lines.

# Filled contours between two levels are also a list/tuple of polygons.
# Points can be ordered clockwise or anticlockwise.
filled01 = [[[0, 0], [0, 4], [1, 3], [1, 2], [2, 0]]]
filled12 = [[[2, 0], [3, 0], [3, 2], [1, 3], [1, 2]], # Note two polygons.
            [[1, 4], [3, 4], [3, 3]]]

plt.figure()

# Filled contours using filled=True.
cs = ContourSet(plt.gca(), [0, 1, 2], [filled01, filled12], filled=True, cmap=cm.bone)
cbar = plt.colorbar(cs)

# Contour lines (non-filled).

```

```

lines = ContourSet(plt.gca(), [0, 1, 2], [lines0, lines1, lines2], cmap=cm.cool,
                    linewidths=3)
cbar.add_lines(lines)

plt.axis([-0.5, 3.5, -0.5, 4.5])
plt.title('User-specified contours')

# Multiple filled contour lines can be specified in a single list of polygon
# vertices along with a list of vertex kinds (code types) as described in the
# Path class. This is particularly useful for polygons with holes.
# Here a code type of 1 is a MOVETO, and 2 is a LINETO.

plt.figure()
filled01 = [[[0, 0], [3, 0], [3, 3], [0, 3], [1, 1], [1, 2], [2, 2], [2, 1]]]
kinds01 = [[1, 2, 2, 2, 1, 2, 2, 2]]
cs = ContourSet(plt.gca(), [0, 1], [filled01], [kinds01], filled=True)
cbar = plt.colorbar(cs)

plt.axis([-0.5, 3.5, -0.5, 3.5])
plt.title('User specified filled contours with holes')

plt.show()

```

Keywords: python, matplotlib, pylab, example, codex (see *Search examples*)

96.2 misc example code: font_indexing.py

```

"""
A little example that shows how the various indexing into the font
tables relate to one another.  Mainly for mpl developers....

"""
from __future__ import print_function
import matplotlib
from matplotlib.ft2font import FT2Font, KERNING_DEFAULT, KERNING_UNFITTED, KERNING_
↳UNSCALED

#fname = '/usr/share/fonts/sfd/FreeSans.ttf'
fname = matplotlib.get_data_path() + '/fonts/ttf/DejaVuSans.ttf'
font = FT2Font(fname)
font.set_charmap(0)

codes = font.get_charmap().items()
#dsu = [(ccode, glyphind) for ccode, glyphind in codes]
#dsu.sort()
#for ccode, glyphind in dsu:
#    try: name = font.get_glyph_name(glyphind)
#    except RuntimeError: pass
#    else: print('% 4d % 4d %s %s' % (glyphind, ccode, hex(int(ccode)), name))

```

```

# make a charname to charcode and glyphind dictionary
coded = {}
glyphd = {}
for ccode, glyphind in codes:
    name = font.get_glyph_name(glyphind)
    coded[name] = ccode
    glyphd[name] = glyphind

code = coded['A']
glyph = font.load_char(code)
#print(glyph.bbox)
print(glyphd['A'], glyphd['V'], coded['A'], coded['V'])
print('AV', font.get_kerning(glyphd['A'], glyphd['V'], KERNING_DEFAULT))
print('AV', font.get_kerning(glyphd['A'], glyphd['V'], KERNING_UNFITTED))
print('AV', font.get_kerning(glyphd['A'], glyphd['V'], KERNING_UNSCALED))
print('AV', font.get_kerning(glyphd['A'], glyphd['T'], KERNING_UNSCALED))

```

Keywords: python, matplotlib, pylab, example, codex (see *Search examples*)

96.3 misc example code: `ftface_props.py`

```

from __future__ import print_function
"""
This is a demo script to show you how to use all the properties of an
FT2Font object. These describe global font properties. For
individual character metrics, use the Glyph object, as returned by
load_char
"""
import matplotlib
import matplotlib.ft2font as ft

#fname = '/usr/local/share/matplotlib/VeraIt.ttf'
fname = matplotlib.get_data_path() + '/fonts/ttf/DejaVuSans-Oblique.ttf'
#fname = '/usr/local/share/matplotlib/cmr10.ttf'

font = ft.FT2Font(fname)

print('Num faces   :', font.num_faces)           # number of faces in file
print('Num glyphs  :', font.num_glyphs)         # number of glyphs in the face
print('Family name :', font.family_name)        # face family name
print('Style name  :', font.style_name)         # face style name
print('PS name     :', font.postscript_name)    # the postscript name
print('Num fixed   :', font.num_fixed_sizes)    # number of embedded bitmap in face

# the following are only available if face.scalable
if font.scalable:
    # the face global bounding box (xmin, ymin, xmax, ymax)
    print('Bbox           :', font.bbox)

```

```

# number of font units covered by the EM
print('EM          :', font.units_per_EM)
# the ascender in 26.6 units
print('Ascender     :', font.ascender)
# the descender in 26.6 units
print('Descender    :', font.descender)
# the height in 26.6 units
print('Height       :', font.height)
# maximum horizontal cursor advance
print('Max adv width  :', font.max_advance_width)
# same for vertical layout
print('Max adv height :', font.max_advance_height)
# vertical position of the underline bar
print('Underline pos  :', font.underline_position)
# vertical thickness of the underline
print('Underline thickness :', font.underline_thickness)

for style in ('Italic',
             'Bold',
             'Scalable',
             'Fixed sizes',
             'Fixed width',
             'SFNT',
             'Horizontal',
             'Vertical',
             'Kerning',
             'Fast glyphs',
             'Multiple masters',
             'Glyph names',
             'External stream'):
    bitpos = getattr(ft, style.replace(' ', '_').upper()) - 1
    print('%-17s:' % style, bool(font.style_flags & (1 << bitpos)))

print(dir(font))

print(font.get_kerning)

```

Keywords: python, matplotlib, pylab, example, codex (see [Search examples](#))

96.4 misc example code: image_thumbnail.py

[source code]

```

# -*- noplots -*-
"""
You can use matplotlib to generate thumbnails from existing images.
matplotlib natively supports PNG files on the input side, and other
image types transparently if you have PIL installed
"""

from __future__ import print_function

```

```
# build thumbnails of all images in a directory
import sys
import os
import glob
import matplotlib.image as image

if len(sys.argv) != 2:
    print('Usage: python %s IMAGEDIR' % __file__)
    raise SystemExit
indir = sys.argv[1]
if not os.path.isdir(indir):
    print('Could not find input directory "%s"' % indir)
    raise SystemExit

outdir = 'thumbs'
if not os.path.exists(outdir):
    os.makedirs(outdir)

for fname in glob.glob(os.path.join(indir, '*.png')):
    basedir, basename = os.path.split(fname)
    outfile = os.path.join(outdir, basename)
    fig = image.thumbnail(fname, outfile, scale=0.15)
    print('saved thumbnail of %s to %s' % (fname, outfile))
```

Keywords: python, matplotlib, pylab, example, codex (see [Search examples](#))

96.5 misc example code: multiprocessing.py

[source code]

```
# -*- noplots -*-
# Demo of using multiprocessing for generating data in one process and plotting
# in another.
# Written by Robert Cimrman

from __future__ import print_function
import time
from multiprocessing import Process, Pipe
import numpy as np

import matplotlib
matplotlib.use('GtkAgg')
import matplotlib.pyplot as plt
import gobject

class ProcessPlotter(object):
    def __init__(self):
        self.x = []
        self.y = []
```

```

def terminate(self):
    plt.close('all')

def poll_draw(self):

    def call_back():
        while 1:
            if not self.pipe.poll():
                break

            command = self.pipe.recv()

            if command is None:
                self.terminate()
                return False

            else:
                self.x.append(command[0])
                self.y.append(command[1])
                self.ax.plot(self.x, self.y, 'ro')

        self.fig.canvas.draw()
        return True

    return call_back

def __call__(self, pipe):
    print('starting plotter...')

    self.pipe = pipe
    self.fig, self.ax = plt.subplots()
    self.gid = gobject.timeout_add(1000, self.poll_draw())

    print('...done')
    plt.show()

class NBPlot(object):
    def __init__(self):
        self.plot_pipe, plotter_pipe = Pipe()
        self.plotter = ProcessPlotter()
        self.plot_process = Process(target=self.plotter,
                                    args=(plotter_pipe,))

        self.plot_process.daemon = True
        self.plot_process.start()

    def plot(self, finished=False):
        send = self.plot_pipe.send
        if finished:
            send(None)
        else:
            data = np.random.random(2)

```

```

        send(data)

def main():
    pl = NBPlot()
    for ii in range(10):
        pl.plot()
        time.sleep(0.5)
    try:
        input = raw_input
    except NameError:
        pass
    input('press Enter...')
    pl.plot(finished=True)

if __name__ == '__main__':
    main()

```

Keywords: python, matplotlib, pylab, example, codex (see [Search examples](#))

96.6 misc example code: rasterization_demo.py

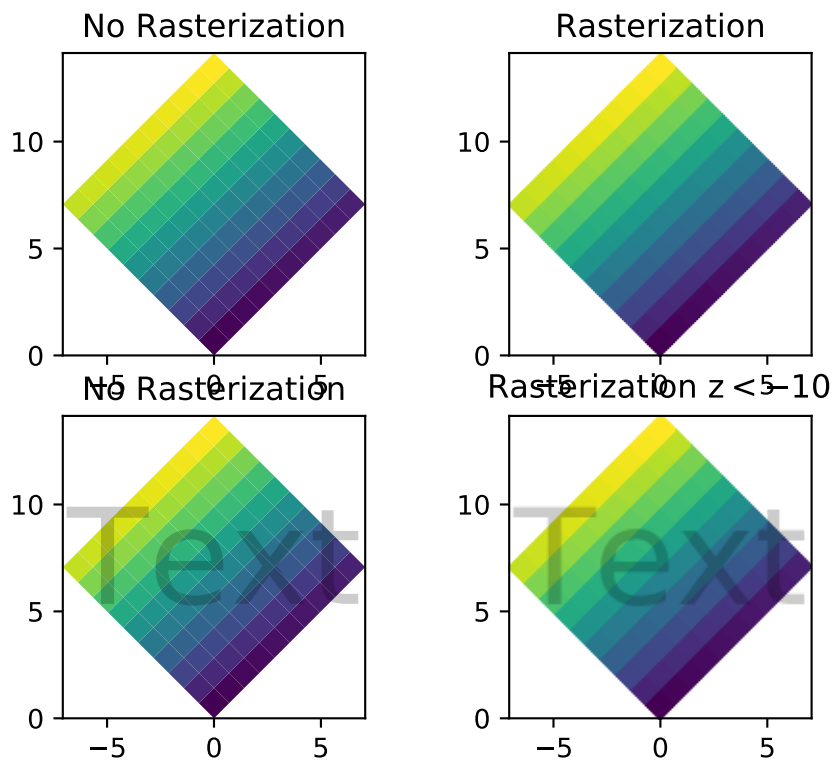

```

import numpy as np
import matplotlib.pyplot as plt

d = np.arange(100).reshape(10, 10)
x, y = np.meshgrid(np.arange(11), np.arange(11))

theta = 0.25*np.pi
xx = x*np.cos(theta) - y*np.sin(theta)
yy = x*np.sin(theta) + y*np.cos(theta)

fig, ((ax1, ax2), (ax3, ax4)) = plt.subplots(2, 2)
ax1.set_aspect(1)
ax1.pcolormesh(xx, yy, d)
ax1.set_title("No Rasterization")

ax2.set_aspect(1)
ax2.set_title("Rasterization")

m = ax2.pcolormesh(xx, yy, d)
m.set_rasterized(True)

ax3.set_aspect(1)
ax3.pcolormesh(xx, yy, d)
ax3.text(0.5, 0.5, "Text", alpha=0.2,
         va="center", ha="center", size=50, transform=ax3.transAxes)

ax3.set_title("No Rasterization")

ax4.set_aspect(1)
m = ax4.pcolormesh(xx, yy, d)
m.set_zorder(-20)

ax4.text(0.5, 0.5, "Text", alpha=0.2,
         zorder=-15,
         va="center", ha="center", size=50, transform=ax4.transAxes)

ax4.set_rasterization_zorder(-10)

ax4.set_title("Rasterization z$<-10$")

# ax2.title.set_rasterized(True) # should display a warning

plt.savefig("test_rasterization.pdf", dpi=150)
plt.savefig("test_rasterization.eps", dpi=150)

if not plt.rcParams["text.usetex"]:
    plt.savefig("test_rasterization.svg", dpi=150)
    # svg backend currently ignores the dpi

```

Keywords: python, matplotlib, pylab, example, codex (see [Search examples](#))

96.7 misc example code: rc_traits.py

[source code]

```
# -*- noplots -*-
# Here is some example code showing how to define some representative
# rc properties and construct a matplotlib artist using traits.
# matplotlib does not ship with enthought.traits, so you will need to
# install it separately.

from __future__ import print_function

import sys
import os
import re
import traits.api as traits
from matplotlib.cbook import is_string_like
from matplotlib.artist import Artist

doprint = True
flexible_true_trait = traits.Trait(
    True,
    {'true': True, 't': True, 'yes': True, 'y': True, 'on': True, True: True,
     'false': False, 'f': False, 'no': False, 'n': False, 'off': False, False: False
    })
flexible_false_trait = traits.Trait(False, flexible_true_trait)

colors = {
    'c': '#00bfff',
    'b': '#0000ff',
    'g': '#008000',
    'k': '#000000',
    'm': '#bf00bf',
    'r': '#ff0000',
    'w': '#ffffff',
    'y': '#bfff00',
    'gold': '#FFD700',
    'peachpuff': '#FFDAB9',
    'navajowhite': '#FFDEAD',
}

def hex2color(s):
    "Convert hex string (like html uses, eg, #efefef) to a r,g,b tuple"
    return tuple([int(n, 16)/255.0 for n in (s[1:3], s[3:5], s[5:7])])

class RGBA(traits.HasTraits):
    # r,g,b,a in the range 0-1 with default color 0,0,0,1 (black)
    r = traits.Range(0., 1., 0.)
    g = traits.Range(0., 1., 0.)
    b = traits.Range(0., 1., 0.)
    a = traits.Range(0., 1., 1.)
```

```

def __init__(self, r=0., g=0., b=0., a=1.):
    self.r = r
    self.g = g
    self.b = b
    self.a = a

def __repr__(self):
    return 'r,g,b,a = (%1.2f, %1.2f, %1.2f, %1.2f)' %\
        (self.r, self.g, self.b, self.a)

def tuple_to_rgba(ob, name, val):
    tup = [float(x) for x in val]
    if len(tup) == 3:
        r, g, b = tup
        return RGBA(r, g, b)
    elif len(tup) == 4:
        r, g, b, a = tup
        return RGBA(r, g, b, a)
    else:
        raise ValueError
tuple_to_rgba.info = 'a RGB or RGBA tuple of floats'

def hex_to_rgba(ob, name, val):
    rgx = re.compile('^#[0-9A-Fa-f]{6}$')

    if not is_string_like(val):
        raise TypeError
    if rgx.match(val) is None:
        raise ValueError
    r, g, b = hex2color(val)
    return RGBA(r, g, b, 1.0)
hex_to_rgba.info = 'a hex color string'

def colorname_to_rgba(ob, name, val):
    hex = colors[val.lower()]
    r, g, b = hex2color(hex)
    return RGBA(r, g, b, 1.0)
colorname_to_rgba.info = 'a named color'

def float_to_rgba(ob, name, val):
    val = float(val)
    return RGBA(val, val, val, 1.)
float_to_rgba.info = 'a grayscale intensity'

Color = traits.Trait(RGBA(), float_to_rgba, colorname_to_rgba, RGBA,
                    hex_to_rgba, tuple_to_rgba)

```

```

def file_exists(ob, name, val):
    fh = file(val, 'r')
    return val

linestyles = ('-', '--', '-.', ':', 'steps', 'None')
TICKLEFT, TICKRIGHT, TICKUP, TICKDOWN = range(4)
linemarkers = (None, '.', ',', 'o', '^', 'v', '<', '>', 's',
               '+', 'x', 'd', 'D', '|', '_', 'h', 'H',
               'p', '1', '2', '3', '4',
               TICKLEFT,
               TICKRIGHT,
               TICKUP,
               TICKDOWN,
               'None'
               )

class LineRC(trait.HasTraits):
    linewidth = traits.Float(0.5)
    linestyle = traits.Trait(*linestyles)
    color = Color
    marker = traits.Trait(*linemarkers)
    markerfacecolor = Color
    markeredgecolor = Color
    markeredgewidth = traits.Float(0.5)
    markersize = traits.Float(6)
    antialiased = flexible_true_trait
    data_clipping = flexible_false_trait

class PatchRC(trait.HasTraits):
    linewidth = traits.Float(1.0)
    facecolor = Color
    edgecolor = Color
    antialiased = flexible_true_trait

timezones = 'UTC', 'US/Central', 'ES/Eastern' # fixme: and many more
backends = ('GTKAgg', 'Cairo', 'GDK', 'GTK', 'Agg',
            'GTKCairo', 'PS', 'SVG', 'Template', 'TkAgg',
            'WX')

class RC(trait.HasTraits):
    backend = traits.Trait(*backends)
    interactive = flexible_false_trait
    toolbar = traits.Trait('toolbar2', 'classic', None)
    timezone = traits.Trait(*timezones)
    lines = traits.Trait(LineRC())
    patch = traits.Trait(PatchRC())

rc = RC()
rc.lines.color = 'r'

```

```

if doprint:
    print('RC')
    rc.print_traits()
    print('RC lines')
    rc.lines.print_traits()
    print('RC patches')
    rc.patch.print_traits()

class Patch(Artist, traits.HasTraits):
    linewidth = traits.Float(0.5)
    facecolor = Color
    fc = facecolor
    edgecolor = Color
    fill = flexible_true_trait

    def __init__(self,
                 edgecolor=None,
                 facecolor=None,
                 linewidth=None,
                 antialiased=None,
                 fill=1,
                 **kwargs
                ):
        Artist.__init__(self)

        if edgecolor is None:
            edgecolor = rc.patch.edgecolor
        if facecolor is None:
            facecolor = rc.patch.facecolor
        if linewidth is None:
            linewidth = rc.patch.linewidth
        if antialiased is None:
            antialiased = rc.patch.antialiased

        self.edgecolor = edgecolor
        self.facecolor = facecolor
        self.linewidth = linewidth
        self.antialiased = antialiased
        self.fill = fill

p = Patch()
p.facecolor = '#bfbf00'
p.edgecolor = 'gold'
p.facecolor = (1, .5, .5, .25)
p.facecolor = 0.25
p.fill = 'f'
print('p.facecolor', type(p.facecolor), p.facecolor)
print('p.fill', type(p.fill), p.fill)
if p.fill_:
    print('fill')
else:

```

```

    print('no fill')
if doprint:
    print()
    print('Patch')
    p.print_traits()

```

Keywords: python, matplotlib, pylab, example, codex (see *Search examples*)

96.8 misc example code: rec_groupby_demo.py

```

from __future__ import print_function
import numpy as np
import matplotlib.mlab as mlab
import matplotlib.cbook as cbook

datafile = cbook.get_sample_data('aapl.csv', asfileobj=False)
print('loading', datafile)
r = mlab.csv2rec(datafile)
r.sort()

def daily_return(prices):
    'an array of daily returns from price array'
    g = np.zeros_like(prices)
    g[1:] = (prices[1:] - prices[:-1])/prices[:-1]
    return g

def volume_code(volume):
    'code the continuous volume data categorically'
    ind = np.searchsorted([1e5, 1e6, 5e6, 10e6, 1e7], volume)
    return ind

# a list of (dtype_name, summary_function, output_dtype_name).
# rec_summarize will call on each function on the indicated recarray
# attribute, and the result assigned to output name in the return
# record array.
summaryfuncs = (
    ('date', lambda x: [thisdate.year for thisdate in x], 'years'),
    ('date', lambda x: [thisdate.month for thisdate in x], 'months'),
    ('date', lambda x: [thisdate.weekday() for thisdate in x], 'weekday'),
    ('adj_close', daily_return, 'dreturn'),
    ('volume', volume_code, 'volcode'),
)

rsum = mlab.rec_summarize(r, summaryfuncs)

# stats is a list of (dtype_name, function, output_dtype_name).
# rec_groupby will summarize the attribute identified by the
# dtype_name over the groups in the groupby list, and assign the
# result to the output_dtype_name

```

```

stats = (
    ('dreturn', len, 'rcnt'),
    ('dreturn', np.mean, 'rmean'),
    ('dreturn', np.median, 'rmedian'),
    ('dreturn', np.std, 'rsigma'),
)

# you can summarize over a single variable, like years or months
print('summary by years')
ry = mlab.rec_groupby(rsum, ('years',), stats)
print(mlab.rec2txt(ry))

print('summary by months')
rm = mlab.rec_groupby(rsum, ('months',), stats)
print(mlab.rec2txt(rm))

# or over multiple variables like years and months
print('summary by year and month')
rym = mlab.rec_groupby(rsum, ('years', 'months'), stats)
print(mlab.rec2txt(rym))

print('summary by volume')
rv = mlab.rec_groupby(rsum, ('volcode',), stats)
print(mlab.rec2txt(rv))

```

Keywords: python, matplotlib, pylab, example, codex (see [Search examples](#))

96.9 misc example code: rec_join_demo.py

```

from __future__ import print_function
import numpy as np
import matplotlib.mlab as mlab
import matplotlib.cbook as cbook

datafile = cbook.get_sample_data('aapl.csv', asfileobj=False)
print('loading', datafile)
r = mlab.csv2rec(datafile)

r.sort()
r1 = r[-10:]

# Create a new array
r2 = np.empty(12, dtype=[('date', '|04'), ('high', np.float),
                        ('marker', np.float)])
r2 = r2.view(np.recarray)
r2.date = r.date[-17:-5]
r2.high = r.high[-17:-5]
r2.marker = np.arange(12)

print("r1:")
print(mlab.rec2txt(r1))

```

```

print("r2:")
print(mlab.rec2txt(r2))

defaults = {'marker': -1, 'close': np.NaN, 'low': -4444.}

for s in ('inner', 'outer', 'leftouter'):
    rec = mlab.rec_join(['date', 'high'], r1, r2,
                       jointype=s, defaults=defaults)
    print("\n%sjoin : \n%s" % (s, mlab.rec2txt(rec)))

```

Keywords: python, matplotlib, pylab, example, codex (see *Search examples*)

96.10 misc example code: sample_data_demo.py

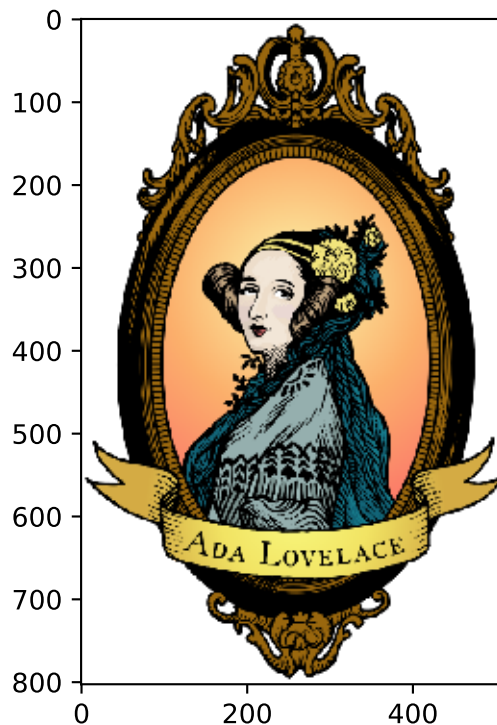

```

"""
Grab mpl data from the ~/.matplotlib/sample_data cache if it exists, else
fetch it from GitHub and cache it
"""
from __future__ import print_function
import matplotlib.cbook as cbook
import matplotlib.pyplot as plt
fname = cbook.get_sample_data('ada.png', asfileobj=False)

```



```
print('fname', fname)
im = plt.imread(fname)
plt.imshow(im)
plt.show()
```

Keywords: python, matplotlib, pylab, example, codex (see *Search examples*)

96.11 misc example code: svg_filter_line.py

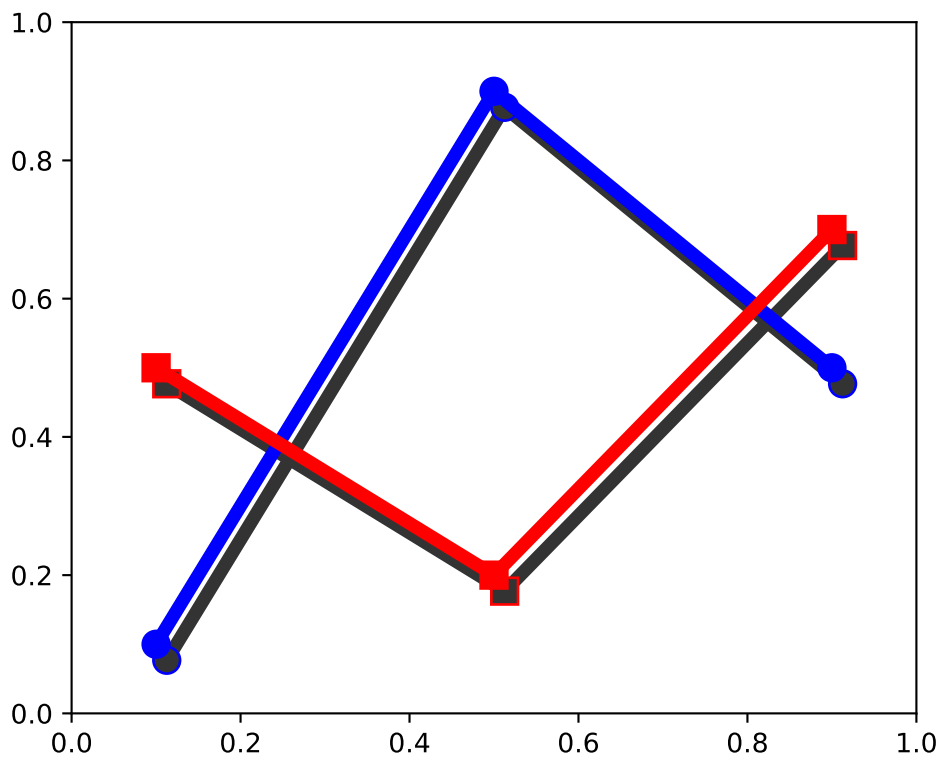

```
"""
Demonstrate SVG filtering effects which might be used with mpl.

Note that the filtering effects are only effective if your svg renderer
support it.
"""

from __future__ import print_function
import matplotlib

matplotlib.use("Svg")
```

```

import matplotlib.pyplot as plt
import matplotlib.transforms as mtransforms

fig1 = plt.figure()
ax = fig1.add_axes([0.1, 0.1, 0.8, 0.8])

# draw lines
l1, = ax.plot([0.1, 0.5, 0.9], [0.1, 0.9, 0.5], "bo-",
              mec="b", lw=5, ms=10, label="Line 1")
l2, = ax.plot([0.1, 0.5, 0.9], [0.5, 0.2, 0.7], "rs-",
              mec="r", lw=5, ms=10, color="r", label="Line 2")

for l in [l1, l2]:

    # draw shadows with same lines with slight offset and gray colors.

    xx = l.get_xdata()
    yy = l.get_ydata()
    shadow, = ax.plot(xx, yy)
    shadow.update_from(l)

    # adjust color
    shadow.set_color("0.2")
    # adjust zorder of the shadow lines so that it is drawn below the
    # original lines
    shadow.set_zorder(l.get_zorder() - 0.5)

    # offset transform
    ot = mtransforms.offset_copy(l.get_transform(), fig1,
                                x=4.0, y=-6.0, units='points')

    shadow.set_transform(ot)

    # set the id for a later use
    shadow.set_gid(l.get_label() + "_shadow")

ax.set_xlim(0., 1.)
ax.set_ylim(0., 1.)

# save the figure as a bytes string in the svg format.
from io import BytesIO
f = BytesIO()
plt.savefig(f, format="svg")

import xml.etree.cElementTree as ET

# filter definition for a gaussian blur
filter_def = """
<defs xmlns='http://www.w3.org/2000/svg' xmlns:xlink='http://www.w3.org/1999/xlink'>
  <filter id='dropshadow' height='1.2' width='1.2'>

```

```
        <feGaussianBlur result='blur' stdDeviation='3' />
    </filter>
</defs>
"""

# read in the saved svg
tree, xmlid = ET.XMLID(f.getvalue())

# insert the filter definition in the svg dom tree.
tree.insert(0, ET.XML(filter_def))

for l in [l1, l2]:
    # pick up the svg element with given id
    shadow = xmlid[l.get_label() + "_shadow"]
    # apply shadow filter
    shadow.set("filter", 'url(#dropshadow)')

fn = "svg_filter_line.svg"
print("Saving '%s'" % fn)
ET.ElementTree(tree).write(fn)
```

Keywords: python, matplotlib, pylab, example, codex (see [Search examples](#))

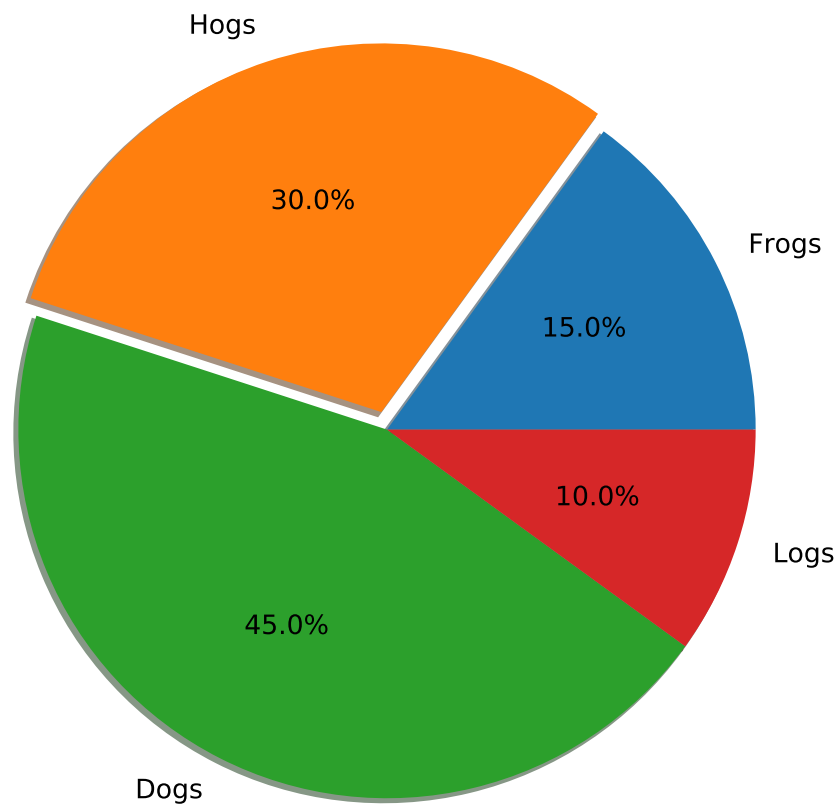
96.12 misc example code: `svg_filter_pie.py`

```
"""  
Demonstrate SVG filtering effects which might be used with mpl.  
The pie chart drawing code is borrowed from pie_demo.py  
  
Note that the filtering effects are only effective if your svg renderer  
support it.  
"""  
  
import matplotlib  
matplotlib.use("Svg")  
  
import matplotlib.pyplot as plt
```

```

from matplotlib.patches import Shadow

# make a square figure and axes
fig1 = plt.figure(1, figsize=(6, 6))
ax = fig1.add_axes([0.1, 0.1, 0.8, 0.8])

labels = 'Frogs', 'Hogs', 'Dogs', 'Logs'
fracs = [15, 30, 45, 10]

explode = (0, 0.05, 0, 0)

# We want to draw the shadow for each pie but we will not use "shadow"
# option as it doesn't save the references to the shadow patches.
pies = ax.pie(fracs, explode=explode, labels=labels, autopct='%1.1f%%')

for w in pies[0]:
    # set the id with the label.
    w.set_gid(w.get_label())

    # we don't want to draw the edge of the pie
    w.set_ec("none")

for w in pies[0]:
    # create shadow patch
    s = Shadow(w, -0.01, -0.01)
    s.set_gid(w.get_gid() + "_shadow")
    s.set_zorder(w.get_zorder() - 0.1)
    ax.add_patch(s)

# save
from io import BytesIO
f = BytesIO()
plt.savefig(f, format="svg")

import xml.etree.cElementTree as ET

# filter definition for shadow using a gaussian blur
# and lightening effect.
# The lightening filter is copied from http://www.w3.org/TR/SVG/filters.html

# I tested it with Inkscape and Firefox3. "Gaussian blur" is supported
# in both, but the lightening effect only in the Inkscape. Also note
# that, Inkscape's exporting also may not support it.

filter_def = """
<defs xmlns='http://www.w3.org/2000/svg' xmlns:xlink='http://www.w3.org/1999/xlink'>
  <filter id='dropshadow' height='1.2' width='1.2'>
    <feGaussianBlur result='blur' stdDeviation='2' />
  </filter>

  <filter id='MyFilter' filterUnits='objectBoundingBox' x='0' y='0' width='1' height='1
  """

```

```
<feGaussianBlur in='SourceAlpha' stdDeviation='4%' result='blur' />
<feOffset in='blur' dx='4%' dy='4%' result='offsetBlur' />
<feSpecularLighting in='blur' surfaceScale='5' specularConstant='.75'
    specularExponent='20' lighting-color='#bbbbbb' result='specOut' />
    <fePointLight x='-5000%' y='-10000%' z='20000%' />
</feSpecularLighting>
<feComposite in='specOut' in2='SourceAlpha' operator='in' result='specOut' />
<feComposite in='SourceGraphic' in2='specOut' operator='arithmetic'
k1='0' k2='1' k3='1' k4='0' />
</filter>
</defs>
"""

tree, xmlid = ET.XMLID(f.getvalue())

# insert the filter definition in the svg dom tree.
tree.insert(0, ET.XML(filter_def))

for i, pie_name in enumerate(labels):
    pie = xmlid[pie_name]
    pie.set("filter", 'url(#MyFilter)')

    shadow = xmlid[pie_name + "_shadow"]
    shadow.set("filter", 'url(#dropshadow)')

fn = "svg_filter_pie.svg"
print("Saving '%s'" % fn)
ET.ElementTree(tree).write(fn)
```

Keywords: python, matplotlib, pylab, example, codex (see [Search examples](#))

96.13 misc example code: tight_bbox_test.py

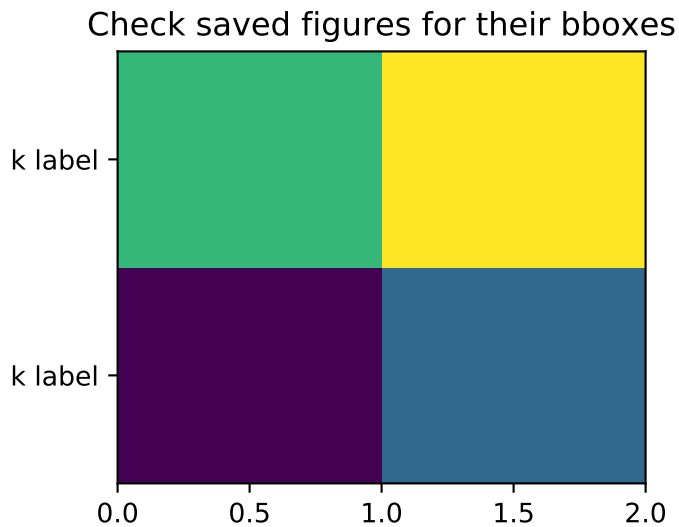

```

from __future__ import print_function
import matplotlib.pyplot as plt
import numpy as np

ax = plt.axes([0.1, 0.3, 0.5, 0.5])

ax.pcolormesh(np.array([[1, 2], [3, 4]]))
plt.yticks([0.5, 1.5], ["long long tick label",
                        "tick label"])
plt.ylabel("My y-label")
plt.title("Check saved figures for their bboxes")
for ext in ["png", "pdf", "svg", "svgz", "eps"]:
    print("saving tight_bbox_test.%s" % (ext,))
    plt.savefig("tight_bbox_test.%s" % (ext,), bbox_inches="tight")
plt.show()

```

Keywords: python, matplotlib, pylab, example, codex (see [Search examples](#))

MPLLOT3D EXAMPLES

97.1 mplot3d example code: 2dcollections3d_demo.py

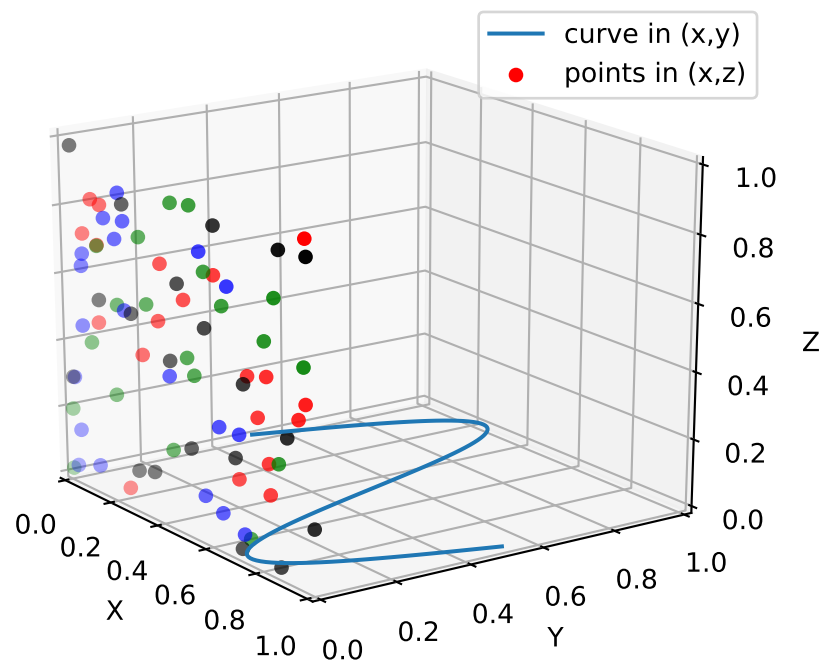

```
"""  
=====   
Plot 2D data on 3D plot  
=====   
  
Demonstrates using ax.plot's zdir keyword to plot 2D data on  
selective axes of a 3D plot.  
"""
```

```
from mpl_toolkits.mplot3d import Axes3D
import numpy as np
import matplotlib.pyplot as plt

fig = plt.figure()
ax = fig.gca(projection='3d')

# Plot a sin curve using the x and y axes.
x = np.linspace(0, 1, 100)
y = np.sin(x * 2 * np.pi) / 2 + 0.5
ax.plot(x, y, zs=0, zdir='z', label='curve in (x,y)')

# Plot scatterplot data (20 2D points per colour) on the x and z axes.
colors = ('r', 'g', 'b', 'k')
x = np.random.sample(20*len(colors))
y = np.random.sample(20*len(colors))
c_list = []
for c in colors:
    c_list.append([c]*20)
# By using zdir='y', the y value of these points is fixed to the zs value 0
# and the (x,y) points are plotted on the x and z axes.
ax.scatter(x, y, zs=0, zdir='y', c=c_list, label='points in (x,z)')

# Make legend, set axes limits and labels
ax.legend()
ax.set_xlim(0, 1)
ax.set_ylim(0, 1)
ax.set_zlim(0, 1)
ax.set_xlabel('X')
ax.set_ylabel('Y')
ax.set_zlabel('Z')

# Customize the view angle so it's easier to see that the scatter points lie
# on the plane y=0
ax.view_init(elev=20., azim=-35)

plt.show()
```

Keywords: python, matplotlib, pylab, example, codex (see [Search examples](#))

97.2 mplot3d example code: bars3d_demo.py

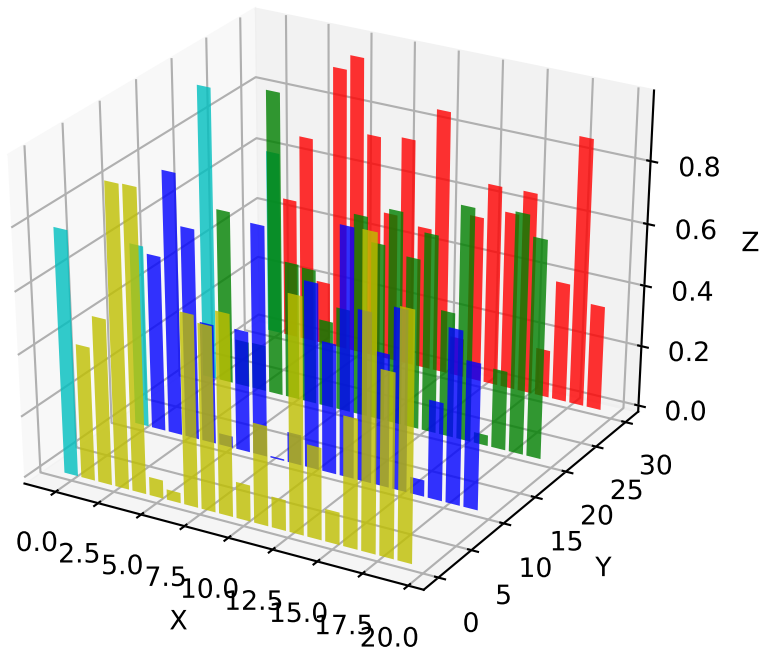

```

"""
=====
Create 2D bar graphs in different planes
=====

Demonstrates making a 3D plot which has 2D bar graphs projected onto
planes y=0, y=1, etc.
"""

from mpl_toolkits.mplot3d import Axes3D
import matplotlib.pyplot as plt
import numpy as np

fig = plt.figure()
ax = fig.add_subplot(111, projection='3d')
for c, z in zip(['r', 'g', 'b', 'y'], [30, 20, 10, 0]):
    xs = np.arange(20)
    ys = np.random.rand(20)

    # You can provide either a single color or an array. To demonstrate this,
    # the first bar of each set will be colored cyan.
    cs = [c] * len(xs)

```

```
cs[0] = 'c'
ax.bar(xs, ys, zs=z, zdir='y', color=cs, alpha=0.8)

ax.set_xlabel('X')
ax.set_ylabel('Y')
ax.set_zlabel('Z')

plt.show()
```

Keywords: python, matplotlib, pylab, example, codex (see [Search examples](#))

97.3 mplot3d example code: contour3d_demo.py

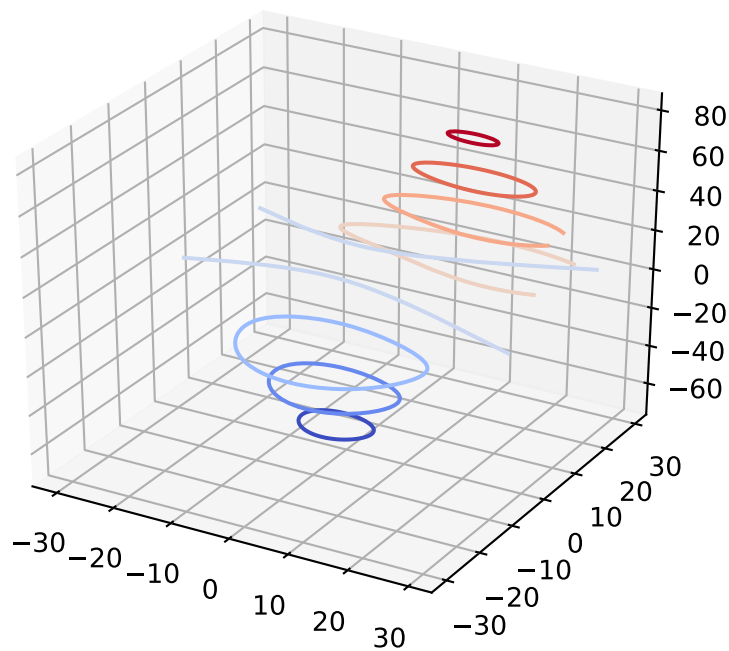

```
from mpl_toolkits.mplot3d import axes3d
import matplotlib.pyplot as plt
from matplotlib import cm

fig = plt.figure()
ax = fig.add_subplot(111, projection='3d')
X, Y, Z = axes3d.get_test_data(0.05)
cset = ax.contour(X, Y, Z, cmap=cm.coolwarm)
ax.clabel(cset, fontsize=9, inline=1)
```

```
plt.show()
```

Keywords: python, matplotlib, pylab, example, codex (see [Search examples](#))

97.4 mplot3d example code: contour3d_demo2.py

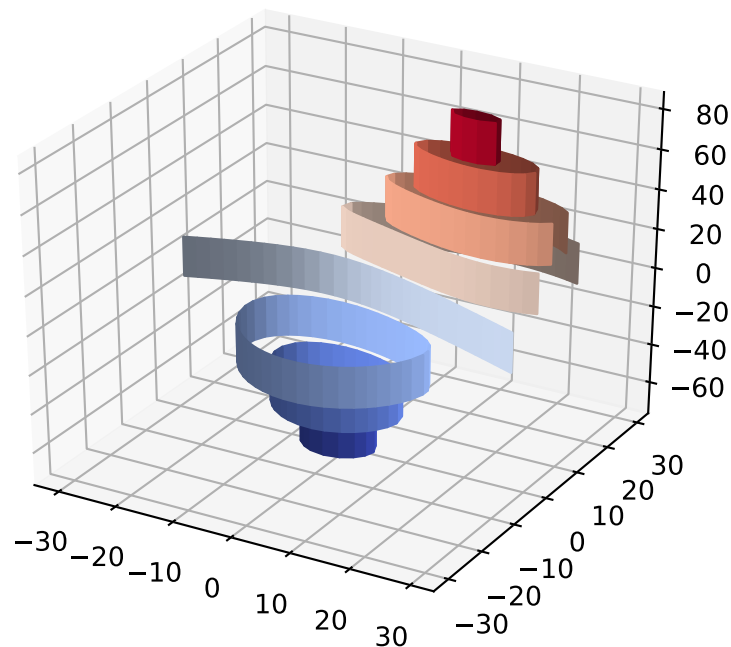

```
from mpl_toolkits.mplot3d import axes3d
import matplotlib.pyplot as plt
from matplotlib import cm

fig = plt.figure()
ax = fig.gca(projection='3d')
X, Y, Z = axes3d.get_test_data(0.05)
cset = ax.contour(X, Y, Z, extend3d=True, cmap=cm.coolwarm)
ax.clabel(cset, fontsize=9, inline=1)

plt.show()
```

Keywords: python, matplotlib, pylab, example, codex (see [Search examples](#))

97.5 mplot3d example code: contour3d_demo3.py

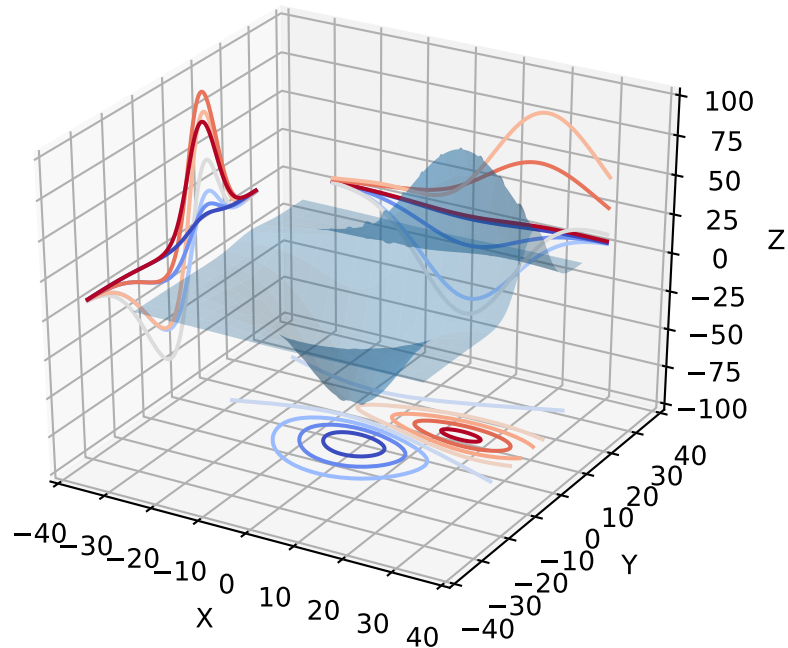

```

from mpl_toolkits.mplot3d import axes3d
import matplotlib.pyplot as plt
from matplotlib import cm

fig = plt.figure()
ax = fig.gca(projection='3d')
X, Y, Z = axes3d.get_test_data(0.05)
ax.plot_surface(X, Y, Z, rstride=8, cstride=8, alpha=0.3)
cset = ax.contour(X, Y, Z, zdir='z', offset=-100, cmap=cm.coolwarm)
cset = ax.contour(X, Y, Z, zdir='x', offset=-40, cmap=cm.coolwarm)
cset = ax.contour(X, Y, Z, zdir='y', offset=40, cmap=cm.coolwarm)

ax.set_xlabel('X')
ax.set_xlim(-40, 40)
ax.set_ylabel('Y')
ax.set_ylim(-40, 40)
ax.set_zlabel('Z')
ax.set_zlim(-100, 100)

plt.show()

```

Keywords: python, matplotlib, pylab, example, codex (see [Search examples](#))

97.6 mplot3d example code: contourf3d_demo.py

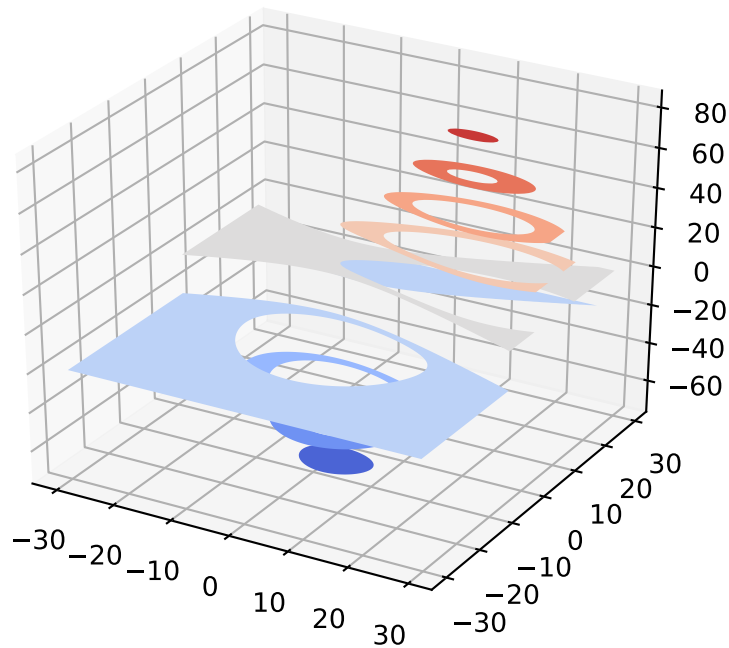

```
from mpl_toolkits.mplot3d import axes3d
import matplotlib.pyplot as plt
from matplotlib import cm

fig = plt.figure()
ax = fig.gca(projection='3d')
X, Y, Z = axes3d.get_test_data(0.05)
cset = ax.contourf(X, Y, Z, cmap=cm.coolwarm)
ax.clabel(cset, fontsize=9, inline=1)

plt.show()
```

Keywords: python, matplotlib, pylab, example, codex (see [Search examples](#))

97.7 mplot3d example code: contourf3d_demo2.py

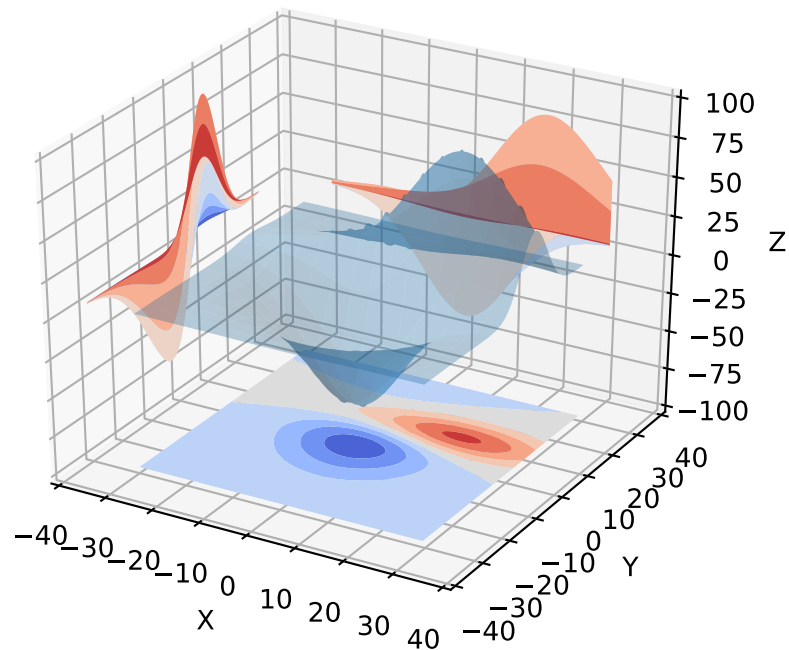

```

"""
.. versionadded:: 1.1.0
   This demo depends on new features added to contourf3d.
"""

from mpl_toolkits.mplot3d import axes3d
import matplotlib.pyplot as plt
from matplotlib import cm

fig = plt.figure()
ax = fig.gca(projection='3d')
X, Y, Z = axes3d.get_test_data(0.05)
ax.plot_surface(X, Y, Z, rstride=8, cstride=8, alpha=0.3)
cset = ax.contourf(X, Y, Z, zdir='z', offset=-100, cmap=cm.coolwarm)
cset = ax.contourf(X, Y, Z, zdir='x', offset=-40, cmap=cm.coolwarm)
cset = ax.contourf(X, Y, Z, zdir='y', offset=40, cmap=cm.coolwarm)

ax.set_xlabel('X')
ax.set_xlim(-40, 40)
ax.set_ylabel('Y')
ax.set_ylim(-40, 40)
ax.set_zlabel('Z')

```



```
ax.set_zlim(-100, 100)

plt.show()
```

Keywords: python, matplotlib, pylab, example, codex (see [Search examples](#))

97.8 mplot3d example code: custom_shaded_3d_surface.py

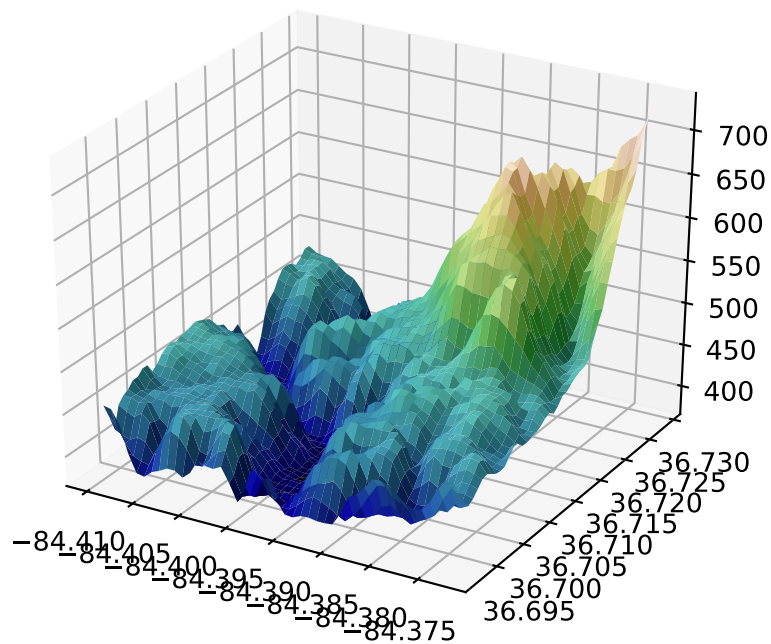

```
"""
Demonstrates using custom hillshading in a 3D surface plot.
"""
from mpl_toolkits.mplot3d import Axes3D
from matplotlib import cbook
from matplotlib import cm
from matplotlib.colors import LightSource
import matplotlib.pyplot as plt
import numpy as np

filename = cbook.get_sample_data('jacksboro_fault_dem.npz', asfileobj=False)
with np.load(filename) as dem:
    z = dem['elevation']
    nrows, ncols = z.shape
```

```

x = np.linspace(dem['xmin'], dem['xmax'], ncols)
y = np.linspace(dem['ymin'], dem['ymax'], nrows)
x, y = np.meshgrid(x, y)

region = np.s_[5:50, 5:50]
x, y, z = x[region], y[region], z[region]

fig, ax = plt.subplots(subplot_kw=dict(projection='3d'))

ls = LightSource(270, 45)
# To use a custom hillshading mode, override the built-in shading and pass
# in the rgb colors of the shaded surface calculated from "shade".
rgb = ls.shade(z, cmap=cm.gist_earth, vert_exag=0.1, blend_mode='soft')
surf = ax.plot_surface(x, y, z, rstride=1, cstride=1, facecolors=rgb,
                      linewidth=0, antialiased=False, shade=False)

plt.show()

```

Keywords: python, matplotlib, pylab, example, codex (see [Search examples](#))

97.9 mplot3d example code: hist3d_demo.py

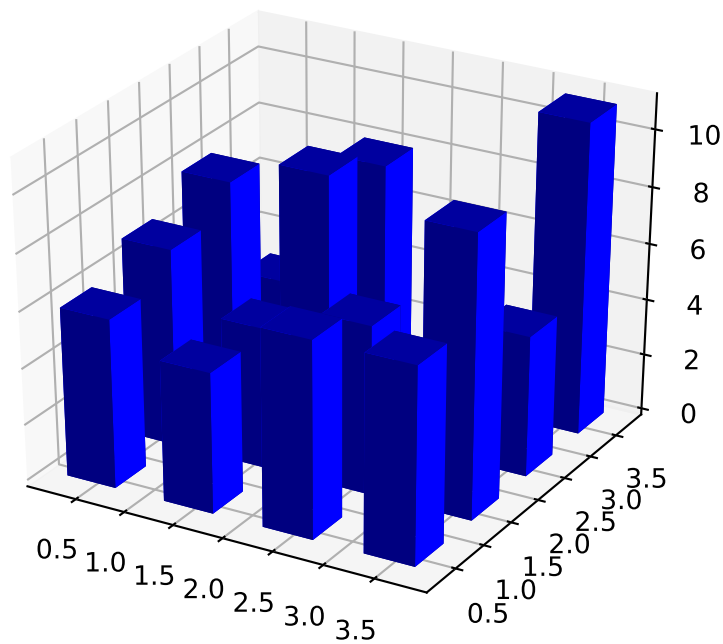

```

"""
=====
Create 3D histogram of 2D data
=====

Demo of a histogram for 2 dimensional data as a bar graph in 3D.
"""

from mpl_toolkits.mplot3d import Axes3D
import matplotlib.pyplot as plt
import numpy as np

fig = plt.figure()
ax = fig.add_subplot(111, projection='3d')
x, y = np.random.rand(2, 100) * 4
hist, xedges, yedges = np.histogram2d(x, y, bins=4, range=[[0, 4], [0, 4]])

# Construct arrays for the anchor positions of the 16 bars.
# Note: np.meshgrid gives arrays in (ny, nx) so we use 'F' to flatten xpos,
# ypos in column-major order. For numpy >= 1.7, we could instead call meshgrid
# with indexing='ij'.
xpos, ypos = np.meshgrid(xedges[:-1] + 0.25, yedges[:-1] + 0.25)
xpos = xpos.flatten('F')
ypos = ypos.flatten('F')
zpos = np.zeros_like(xpos)

# Construct arrays with the dimensions for the 16 bars.
dx = 0.5 * np.ones_like(zpos)
dy = dx.copy()
dz = hist.flatten()

ax.bar3d(xpos, ypos, zpos, dx, dy, dz, color='b', zsort='average')

plt.show()

```

Keywords: python, matplotlib, pylab, example, codex (see [Search examples](#))

97.10 mplot3d example code: lines3d_demo.py

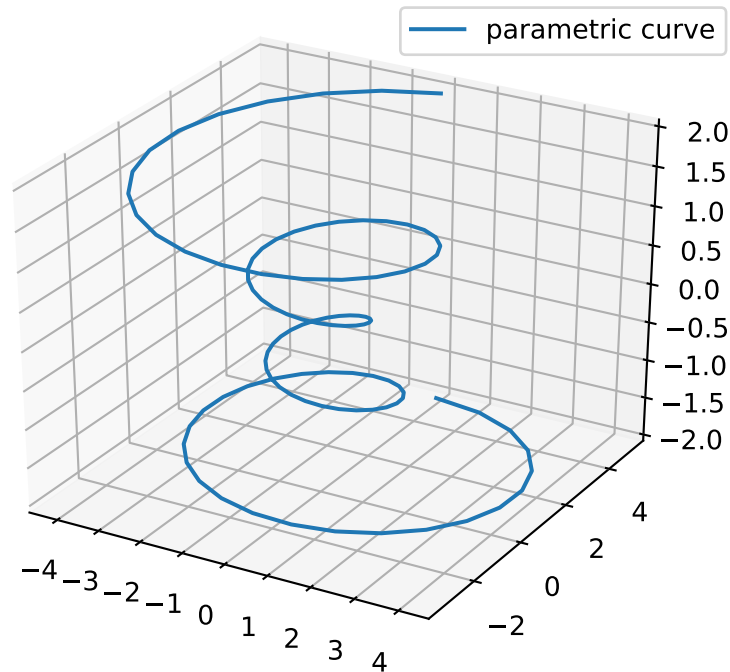

```
import matplotlib as mpl
from mpl_toolkits.mplot3d import Axes3D
import numpy as np
import matplotlib.pyplot as plt

mpl.rcParams['legend.fontsize'] = 10

fig = plt.figure()
ax = fig.gca(projection='3d')
theta = np.linspace(-4 * np.pi, 4 * np.pi, 100)
z = np.linspace(-2, 2, 100)
r = z**2 + 1
x = r * np.sin(theta)
y = r * np.cos(theta)
ax.plot(x, y, z, label='parametric curve')
ax.legend()

plt.show()
```

Keywords: python, matplotlib, pylab, example, codex (see [Search examples](#))

97.11 mplot3d example code: lorenz_attractor.py

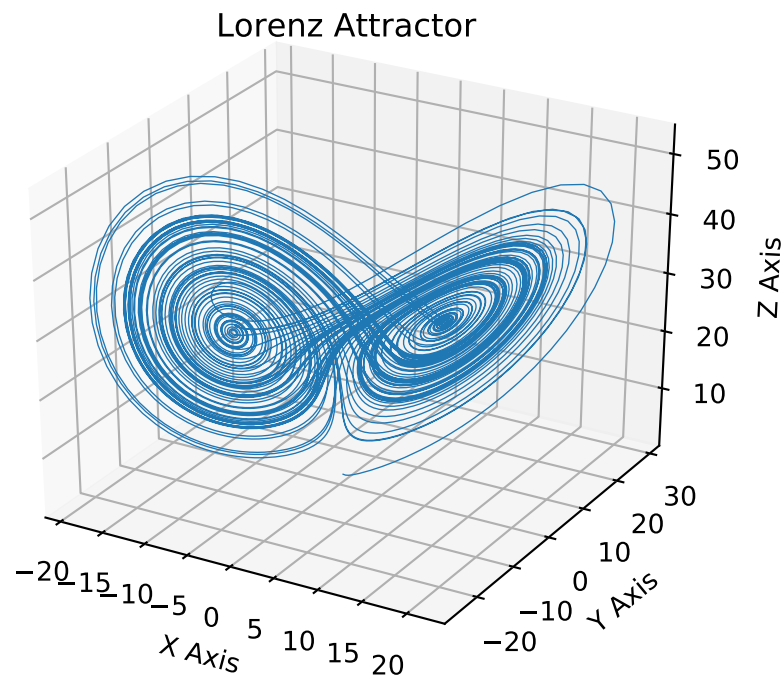

```
# Plot of the Lorenz Attractor based on Edward Lorenz's 1963 "Deterministic
# Nonperiodic Flow" publication.
# http://journals.ametsoc.org/doi/abs/10.1175/1520-0469%281963%29020%3C0130%3ADNF%3E2.0.
# ↪CO%3B2
#
# Note: Because this is a simple non-linear ODE, it would be more easily
#       done using SciPy's ode solver, but this approach depends only
#       upon NumPy.

import numpy as np
import matplotlib.pyplot as plt
from mpl_toolkits.mplot3d import Axes3D

def lorenz(x, y, z, s=10, r=28, b=2.667):
    x_dot = s*(y - x)
    y_dot = r*x - y - x*z
    z_dot = x*y - b*z
    return x_dot, y_dot, z_dot

dt = 0.01
```

```
stepCnt = 10000

# Need one more for the initial values
xs = np.empty((stepCnt + 1,))
ys = np.empty((stepCnt + 1,))
zs = np.empty((stepCnt + 1,))

# Setting initial values
xs[0], ys[0], zs[0] = (0., 1., 1.05)

# Stepping through "time".
for i in range(stepCnt):
    # Derivatives of the X, Y, Z state
    x_dot, y_dot, z_dot = lorenz(xs[i], ys[i], zs[i])
    xs[i + 1] = xs[i] + (x_dot * dt)
    ys[i + 1] = ys[i] + (y_dot * dt)
    zs[i + 1] = zs[i] + (z_dot * dt)

fig = plt.figure()
ax = fig.gca(projection='3d')

ax.plot(xs, ys, zs, lw=0.5)
ax.set_xlabel("X Axis")
ax.set_ylabel("Y Axis")
ax.set_zlabel("Z Axis")
ax.set_title("Lorenz Attractor")

plt.show()
```

Keywords: python, matplotlib, pylab, example, codex (see [Search examples](#))

97.12 mplot3d example code: mixed_subplots_demo.py

A tale of 2 subplots

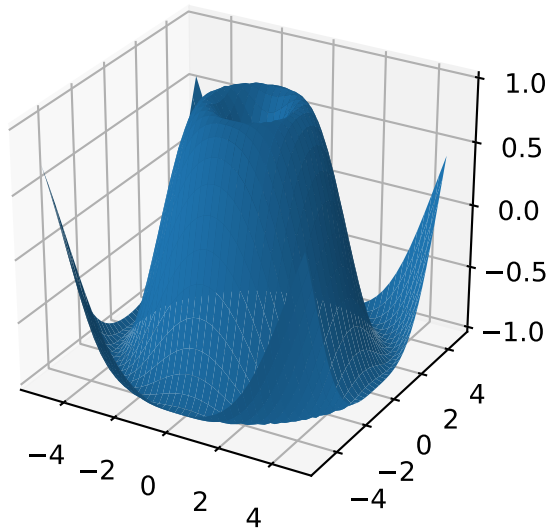
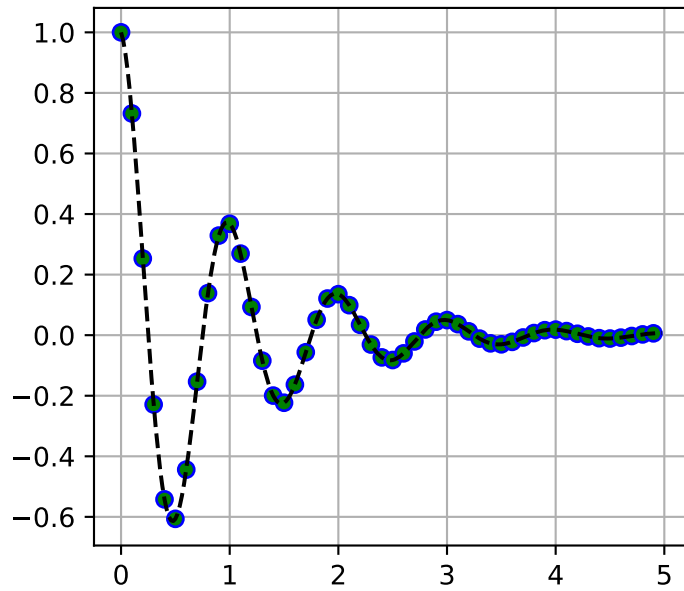

```
"""
Demonstrate the mixing of 2d and 3d subplots
"""
from mpl_toolkits.mplot3d import Axes3D
import matplotlib.pyplot as plt
import numpy as np

def f(t):
    s1 = np.cos(2*np.pi*t)
    e1 = np.exp(-t)
    return np.multiply(s1, e1)

#####
# First subplot
#####
t1 = np.arange(0.0, 5.0, 0.1)
t2 = np.arange(0.0, 5.0, 0.02)
t3 = np.arange(0.0, 2.0, 0.01)

# Twice as tall as it is wide.
fig = plt.figure(figsize=plt.figaspect(2.))
fig.suptitle('A tale of 2 subplots')
ax = fig.add_subplot(2, 1, 1)
l = ax.plot(t1, f(t1), 'bo',
            t2, f(t2), 'k--', markerfacecolor='green')
ax.grid(True)
ax.set_ylabel('Damped oscillation')

#####
# Second subplot
#####
ax = fig.add_subplot(2, 1, 2, projection='3d')
X = np.arange(-5, 5, 0.25)
xlen = len(X)
Y = np.arange(-5, 5, 0.25)
ylen = len(Y)
X, Y = np.meshgrid(X, Y)
R = np.sqrt(X**2 + Y**2)
Z = np.sin(R)

surf = ax.plot_surface(X, Y, Z, rstride=1, cstride=1,
                      linewidth=0, antialiased=False)

ax.set_zlim3d(-1, 1)

plt.show()
```

Keywords: python, matplotlib, pylab, example, codex (see [Search examples](#))

97.13 mplot3d example code: offset_demo.py

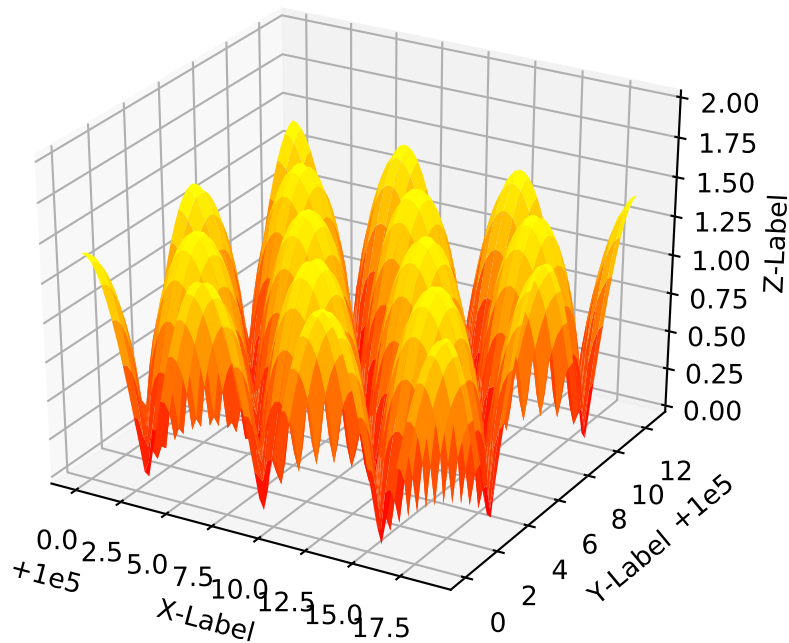

```

from mpl_toolkits.mplot3d import Axes3D
import matplotlib.pyplot as plt
import numpy as np

# This example demonstrates mplot3d's offset text display.
# As one rotates the 3D figure, the offsets should remain oriented
# same way as the axis label, and should also be located "away"
# from the center of the plot.
#
# This demo triggers the display of the offset text for the x and
# y axis by adding 1e5 to X and Y. Anything less would not
# automatically trigger it.

fig = plt.figure()
ax = fig.gca(projection='3d')
X, Y = np.mgrid[0:6*np.pi:0.25, 0:4*np.pi:0.25]
Z = np.sqrt(np.abs(np.cos(X) + np.cos(Y)))

surf = ax.plot_surface(X + 1e5, Y + 1e5, Z, cmap='autumn', cstride=2, rstride=2)
ax.set_xlabel("X-Label")
ax.set_ylabel("Y-Label")
ax.set_zlabel("Z-Label")

```

```
ax.set_zlim(0, 2)

plt.show()
```

Keywords: python, matplotlib, pylab, example, codex (see [Search examples](#))

97.14 mplot3d example code: pathpatch3d_demo.py

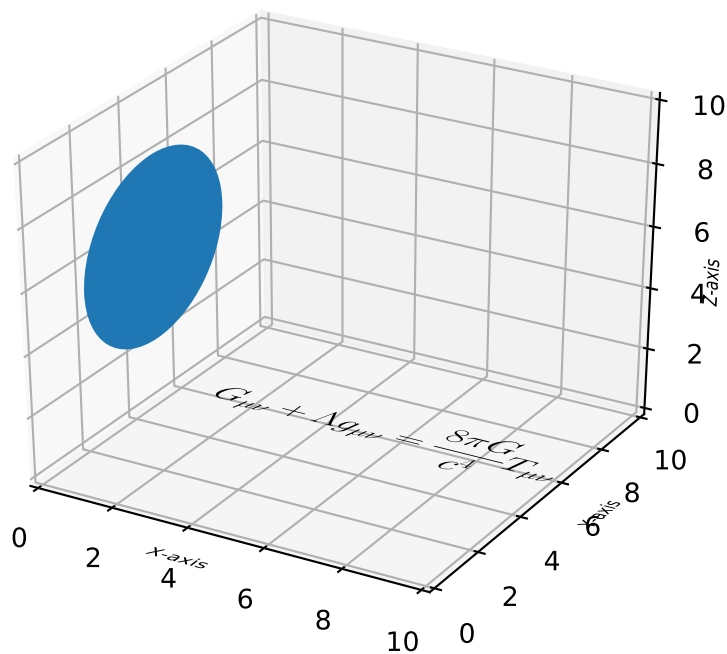

```
"""
=====
Draw flat objects in 3D plot
=====

Demonstrate using pathpatch_2d_to_3d to 'draw' shapes and text on a 3D plot.
"""

import matplotlib.pyplot as plt
from matplotlib.patches import Circle, PathPatch
# register Axes3D class with matplotlib by importing Axes3D
from mpl_toolkits.mplot3d import Axes3D
import mpl_toolkits.mplot3d.art3d as art3d
from matplotlib.text import TextPath
```

```

from matplotlib.transforms import Affine2D

def text3d(ax, xyz, s, zdir="z", size=None, angle=0, usetex=False, **kwargs):

    x, y, z = xyz
    if zdir == "y":
        xy1, z1 = (x, z), y
    elif zdir == "x":
        xy1, z1 = (y, z), x
    else:
        xy1, z1 = (x, y), z

    text_path = TextPath((0, 0), s, size=size, usetex=usetex)
    trans = Affine2D().rotate(angle).translate(xy1[0], xy1[1])

    p1 = PathPatch(trans.transform_path(text_path), **kwargs)
    ax.add_patch(p1)
    art3d.pathpatch_2d_to_3d(p1, z=z1, zdir=zdir)

fig = plt.figure()
ax = fig.add_subplot(111, projection='3d')

p = Circle((5, 5), 3)
ax.add_patch(p)
art3d.pathpatch_2d_to_3d(p, z=0, zdir="x")

text3d(ax, (4, -2, 0), "X-axis", zdir="z", size=.5, usetex=False,
        ec="none", fc="k")
text3d(ax, (12, 4, 0), "Y-axis", zdir="z", size=.5, usetex=False,
        angle=.5*3.14159, ec="none", fc="k")
text3d(ax, (12, 10, 4), "Z-axis", zdir="y", size=.5, usetex=False,
        angle=.5*3.14159, ec="none", fc="k")

text3d(ax, (1, 5, 0),
        r"$\displaystyle G_{\mu\nu} + \Lambda g_{\mu\nu} = "
        r"\frac{8\pi G}{c^4} T_{\mu\nu} \quad $",
        zdir="z", size=1, usetex=True,
        ec="none", fc="k")

ax.set_xlim3d(0, 10)
ax.set_ylim3d(0, 10)
ax.set_zlim3d(0, 10)

plt.show()

```

Keywords: python, matplotlib, pylab, example, codex (see [Search examples](#))

97.15 mplot3d example code: polys3d_demo.py

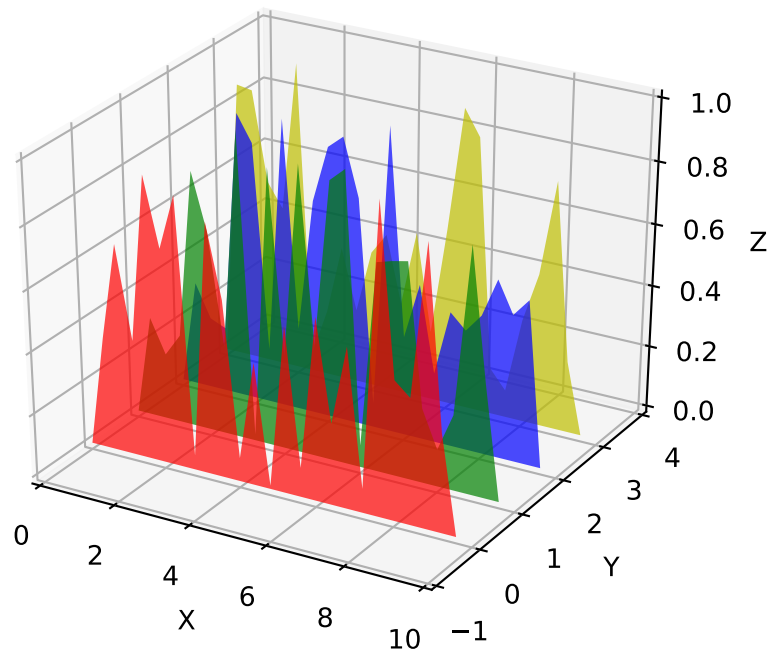

```

"""
=====
Generate polygons to fill under 3D line graph
=====

Demonstrate how to create polygons which fill the space under a line
graph. In this example polygons are semi-transparent, creating a sort
of 'jagged stained glass' effect.
"""

from mpl_toolkits.mplot3d import Axes3D
from matplotlib.collections import PolyCollection
import matplotlib.pyplot as plt
from matplotlib import colors as mcolors
import numpy as np

fig = plt.figure()
ax = fig.gca(projection='3d')

def cc(arg):

```

```
    return mcolors.to_rgba(arg, alpha=0.6)

xs = np.arange(0, 10, 0.4)
verts = []
zs = [0.0, 1.0, 2.0, 3.0]
for z in zs:
    ys = np.random.rand(len(xs))
    ys[0], ys[-1] = 0, 0
    verts.append(list(zip(xs, ys)))

poly = PolyCollection(verts, facecolors=[cc('r'), cc('g'), cc('b'),
                                       cc('y')])
poly.set_alpha(0.7)
ax.add_collection3d(poly, zs=zs, zdir='y')

ax.set_xlabel('X')
ax.set_xlim3d(0, 10)
ax.set_ylabel('Y')
ax.set_ylim3d(-1, 4)
ax.set_zlabel('Z')
ax.set_zlim3d(0, 1)

plt.show()
```

Keywords: python, matplotlib, pylab, example, codex (see [Search examples](#))

97.16 mplot3d example code: quiver3d_demo.py

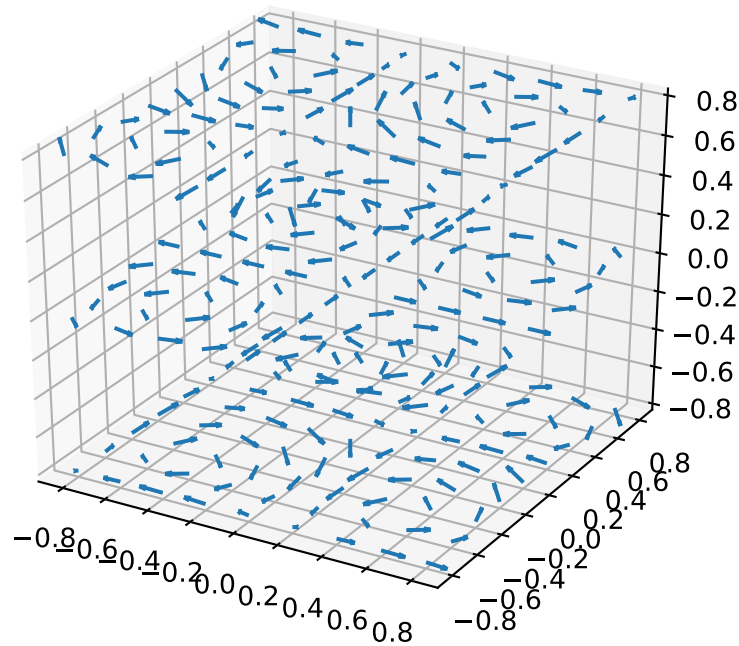

```

"""
=====
3D quiver plot
=====

Demonstrates plotting directional arrows at points on a 3d meshgrid.
"""

from mpl_toolkits.mplot3d import axes3d
import matplotlib.pyplot as plt
import numpy as np

fig = plt.figure()
ax = fig.gca(projection='3d')

# Make the grid
x, y, z = np.meshgrid(np.arange(-0.8, 1, 0.2),
                      np.arange(-0.8, 1, 0.2),
                      np.arange(-0.8, 1, 0.8))

# Make the direction data for the arrows
u = np.sin(np.pi * x) * np.cos(np.pi * y) * np.cos(np.pi * z)

```

```

v = -np.cos(np.pi * x) * np.sin(np.pi * y) * np.cos(np.pi * z)
w = (np.sqrt(2.0 / 3.0) * np.cos(np.pi * x) * np.cos(np.pi * y) *
      np.sin(np.pi * z))

ax.quiver(x, y, z, u, v, w, length=0.1, normalize=True)

plt.show()

```

Keywords: python, matplotlib, pylab, example, codex (see [Search examples](#))

97.17 mplot3d example code: rotate_axes3d_demo.py

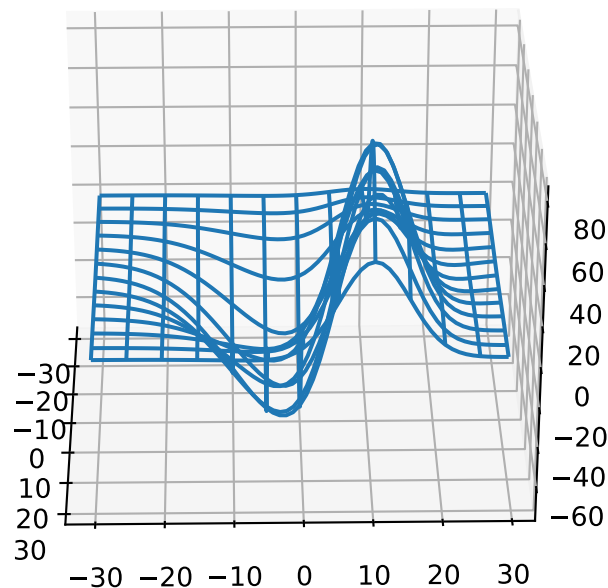

```

"""
=====
Rotating a 3D plot
=====

A very simple animation of a rotating 3D plot.

See wire3d_animation_demo for another simple example of animating a 3D plot.
"""

```

```

from mpl_toolkits.mplot3d import axes3d
import matplotlib.pyplot as plt

fig = plt.figure()
ax = fig.add_subplot(111, projection='3d')

# load some test data for demonstration and plot a wireframe
X, Y, Z = axes3d.get_test_data(0.1)
ax.plot_wireframe(X, Y, Z, rstride=5, cstride=5)

# rotate the axes and update
for angle in range(0, 360):
    ax.view_init(30, angle)
    plt.draw()
    plt.pause(.001)

```

Keywords: python, matplotlib, pylab, example, codex (see [Search examples](#))

97.18 mplot3d example code: scatter3d_demo.py

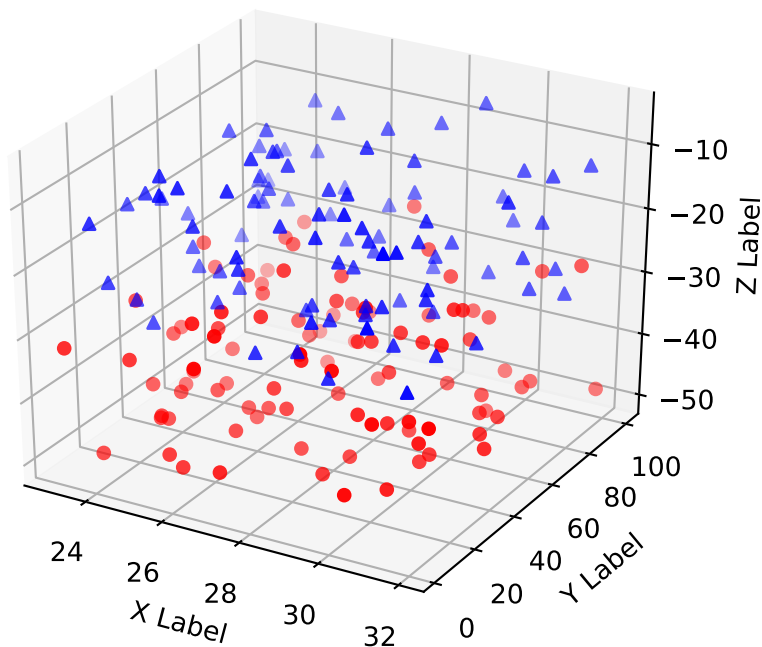

```

"""
=====

```



```
3D scatterplot
=====

Demonstration of a basic scatterplot in 3D.
"""

from mpl_toolkits.mplot3d import Axes3D
import matplotlib.pyplot as plt
import numpy as np

def randrange(n, vmin, vmax):
    """
    Helper function to make an array of random numbers having shape (n, )
    with each number distributed Uniform(vmin, vmax).
    """
    return (vmax - vmin)*np.random.rand(n) + vmin

fig = plt.figure()
ax = fig.add_subplot(111, projection='3d')

n = 100

# For each set of style and range settings, plot n random points in the box
# defined by x in [23, 32], y in [0, 100], z in [zlow, zhigh].
for c, m, zlow, zhigh in [('r', 'o', -50, -25), ('b', '^', -30, -5)]:
    xs = randrange(n, 23, 32)
    ys = randrange(n, 0, 100)
    zs = randrange(n, zlow, zhigh)
    ax.scatter(xs, ys, zs, c=c, marker=m)

ax.set_xlabel('X Label')
ax.set_ylabel('Y Label')
ax.set_zlabel('Z Label')

plt.show()
```

Keywords: python, matplotlib, pylab, example, codex (see [Search examples](#))

97.19 mplot3d example code: subplot3d_demo.py

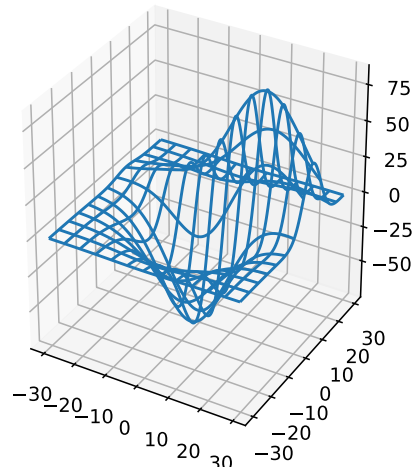
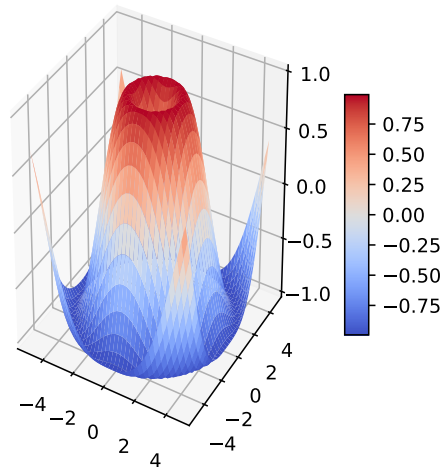

```

"""
=====
3D plots as subplots
=====

Demonstrate including 3D plots as subplots.
"""

import matplotlib.pyplot as plt
from mpl_toolkits.mplot3d.axes3d import Axes3D, get_test_data
from matplotlib import cm
import numpy as np

# set up a figure twice as wide as it is tall
fig = plt.figure(figsize=plt.figaspect(0.5))

#=====
# First subplot
#=====
# set up the axes for the first plot
ax = fig.add_subplot(1, 2, 1, projection='3d')

# plot a 3D surface like in the example mplot3d/surface3d_demo
X = np.arange(-5, 5, 0.25)
Y = np.arange(-5, 5, 0.25)
X, Y = np.meshgrid(X, Y)
R = np.sqrt(X**2 + Y**2)
Z = np.sin(R)
surf = ax.plot_surface(X, Y, Z, rstride=1, cstride=1, cmap=cm.coolwarm,

```

```

        linewidth=0, antialiased=False)
ax.set_zlim(-1.01, 1.01)
fig.colorbar(surf, shrink=0.5, aspect=10)

#=====
# Second subplot
#=====
# set up the axes for the second plot
ax = fig.add_subplot(1, 2, 2, projection='3d')

# plot a 3D wireframe like in the example mplot3d/wire3d_demo
X, Y, Z = get_test_data(0.05)
ax.plot_wireframe(X, Y, Z, rstride=10, cstride=10)

plt.show()

```

Keywords: python, matplotlib, pylab, example, codex (see [Search examples](#))

97.20 mplot3d example code: surface3d_demo.py

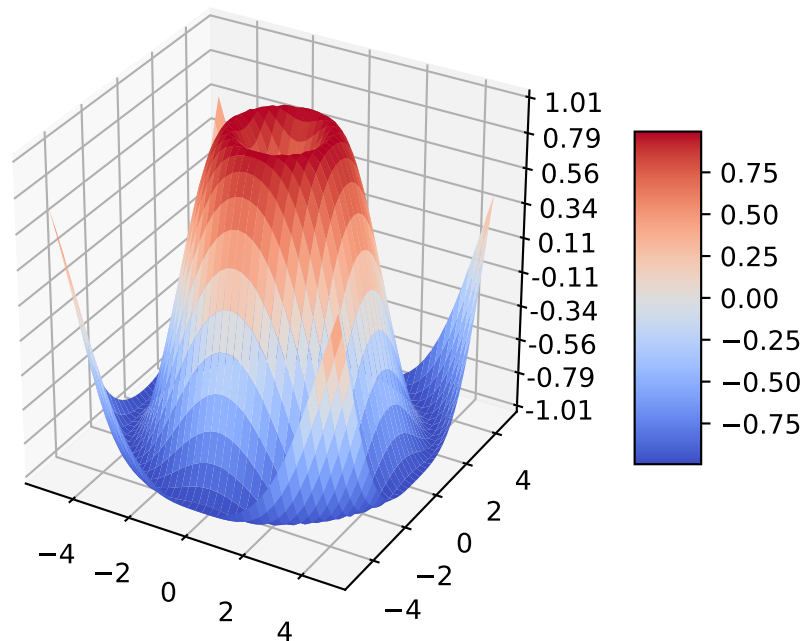

```

'''
=====

```

3D surface (color map)

=====

Demonstrates plotting a 3D surface colored with the coolwarm color map. The surface is made opaque by using antialiased=False.

Also demonstrates using the LinearLocator and custom formatting for the z axis tick labels.

"""

```
from mpl_toolkits.mplot3d import Axes3D
import matplotlib.pyplot as plt
from matplotlib import cm
from matplotlib.ticker import LinearLocator, FormatStrFormatter
import numpy as np
```

```
fig = plt.figure()
ax = fig.gca(projection='3d')
```

```
# Make data.
```

```
X = np.arange(-5, 5, 0.25)
Y = np.arange(-5, 5, 0.25)
X, Y = np.meshgrid(X, Y)
R = np.sqrt(X**2 + Y**2)
Z = np.sin(R)
```

```
# Plot the surface.
```

```
surf = ax.plot_surface(X, Y, Z, cmap=cm.coolwarm,
                      linewidth=0, antialiased=False)
```

```
# Customize the z axis.
```

```
ax.set_zlim(-1.01, 1.01)
ax.zaxis.set_major_locator(LinearLocator(10))
ax.zaxis.set_major_formatter(FormatStrFormatter('%.02f'))
```

```
# Add a color bar which maps values to colors.
```

```
fig.colorbar(surf, shrink=0.5, aspect=5)
```

```
plt.show()
```

Keywords: python, matplotlib, pylab, example, codex (see [Search examples](#))

97.21 mplot3d example code: surface3d_demo2.py

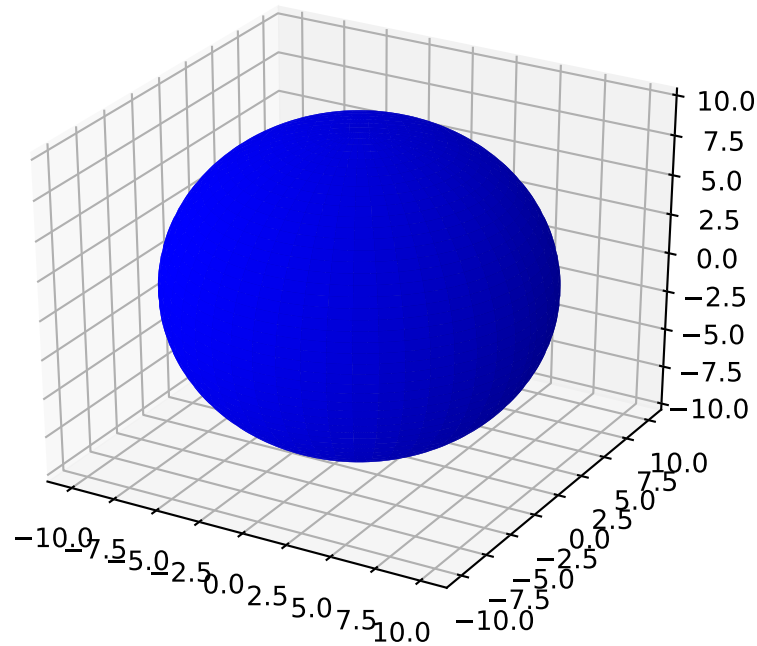

```

"""
=====
3D surface (solid color)
=====

Demonstrates a very basic plot of a 3D surface using a solid color.
"""

from mpl_toolkits.mplot3d import Axes3D
import matplotlib.pyplot as plt
import numpy as np

fig = plt.figure()
ax = fig.add_subplot(111, projection='3d')

# Make data
u = np.linspace(0, 2 * np.pi, 100)
v = np.linspace(0, np.pi, 100)
x = 10 * np.outer(np.cos(u), np.sin(v))
y = 10 * np.outer(np.sin(u), np.sin(v))
z = 10 * np.outer(np.ones(np.size(u)), np.cos(v))

```

```
# Plot the surface
ax.plot_surface(x, y, z, color='b')

plt.show()
```

Keywords: python, matplotlib, pylab, example, codex (see [Search examples](#))

97.22 mplot3d example code: surface3d_demo3.py

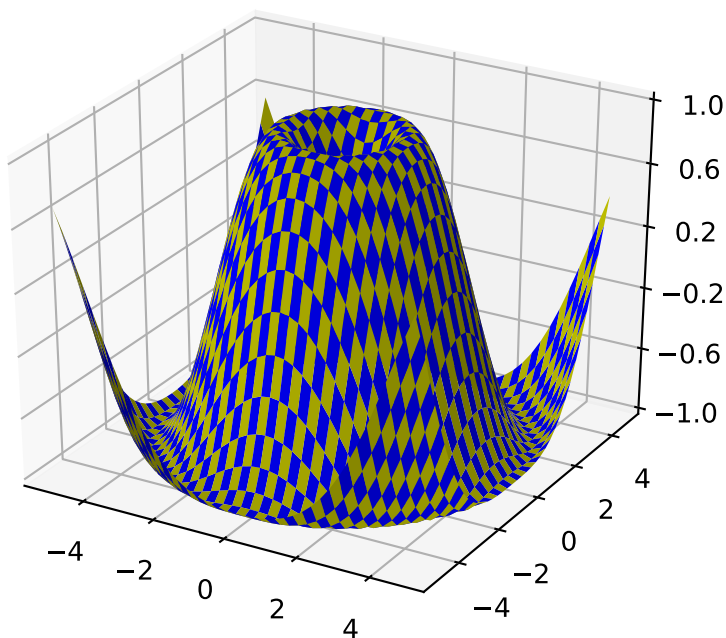

```
"""
=====
3D surface (checkerboard)
=====

Demonstrates plotting a 3D surface colored in a checkerboard pattern.
"""

from mpl_toolkits.mplot3d import Axes3D
import matplotlib.pyplot as plt
from matplotlib import cm
from matplotlib.ticker import LinearLocator
```

```
import numpy as np

fig = plt.figure()
ax = fig.gca(projection='3d')

# Make data.
X = np.arange(-5, 5, 0.25)
xlen = len(X)
Y = np.arange(-5, 5, 0.25)
ylen = len(Y)
X, Y = np.meshgrid(X, Y)
R = np.sqrt(X**2 + Y**2)
Z = np.sin(R)

# Create an empty array of strings with the same shape as the meshgrid, and
# populate it with two colors in a checkerboard pattern.
colortuple = ('y', 'b')
colors = np.empty(X.shape, dtype=str)
for y in range(ylen):
    for x in range(xlen):
        colors[x, y] = colortuple[(x + y) % len(colortuple)]

# Plot the surface with face colors taken from the array we made.
surf = ax.plot_surface(X, Y, Z, facecolors=colors, linewidth=0)

# Customize the z axis.
ax.set_zlim(-1, 1)
ax.w_zaxis.set_major_locator(LinearLocator(6))

plt.show()
```

Keywords: python, matplotlib, pylab, example, codex (see [Search examples](#))

97.23 mplot3d example code: surface3d_radial_demo.py

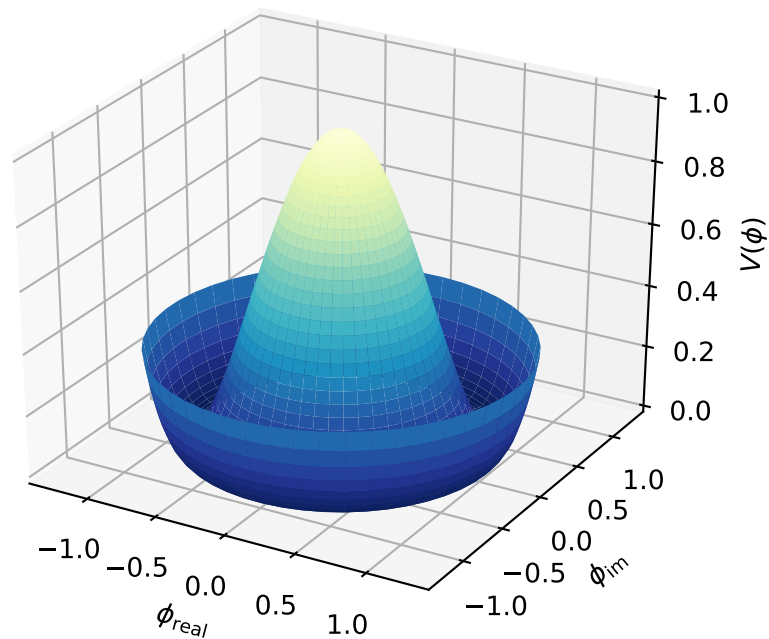

```

"""
=====
3D surface with polar coordinates
=====

Demonstrates plotting a surface defined in polar coordinates.
Uses the reversed version of the YlGnBu color map.
Also demonstrates writing axis labels with latex math mode.

Example contributed by Armin Moser.
"""

from mpl_toolkits.mplot3d import Axes3D
from matplotlib import pyplot as plt
import numpy as np

fig = plt.figure()
ax = fig.add_subplot(111, projection='3d')

# Create the mesh in polar coordinates and compute corresponding Z.
r = np.linspace(0, 1.25, 50)

```



```

p = np.linspace(0, 2*np.pi, 50)
R, P = np.meshgrid(r, p)
Z = ((R**2 - 1)**2)

# Express the mesh in the cartesian system.
X, Y = R*np.cos(P), R*np.sin(P)

# Plot the surface.
ax.plot_surface(X, Y, Z, cmap=plt.cm.YlGnBu_r)

# Tweak the limits and add latex math labels.
ax.set_zlim(0, 1)
ax.set_xlabel(r'$\phi_{\mathrm{real}}$')
ax.set_ylabel(r'$\phi_{\mathrm{im}}$')
ax.set_zlabel(r'$V(\phi)$')

plt.show()

```

Keywords: python, matplotlib, pylab, example, codex (see [Search examples](#))

97.24 mplot3d example code: text3d_demo.py

2D Text

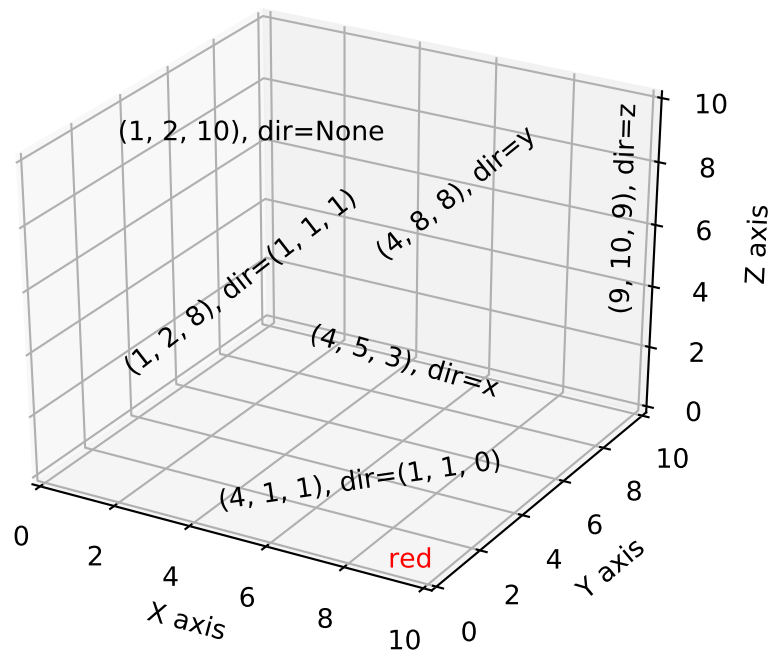

```

"""
=====
Text annotations in 3D
=====

Demonstrates the placement of text annotations on a 3D plot.

Functionality shown:
- Using the text function with three types of 'zdir' values: None,
  an axis name (ex. 'x'), or a direction tuple (ex. (1, 1, 0)).
- Using the text function with the color keyword.
- Using the text2D function to place text on a fixed position on the ax object.
"""

from mpl_toolkits.mplot3d import Axes3D
import matplotlib.pyplot as plt

fig = plt.figure()
ax = fig.gca(projection='3d')

# Demo 1: zdir
zdirs = (None, 'x', 'y', 'z', (1, 1, 0), (1, 1, 1))
xs = (1, 4, 4, 9, 4, 1)
ys = (2, 5, 8, 10, 1, 2)
zs = (10, 3, 8, 9, 1, 8)

for zdir, x, y, z in zip(zdirs, xs, ys, zs):
    label = '%d, %d, %d, dir=%s' % (x, y, z, zdir)
    ax.text(x, y, z, label, zdir)

# Demo 2: color
ax.text(9, 0, 0, "red", color='red')

# Demo 3: text2D
# Placement 0, 0 would be the bottom left, 1, 1 would be the top right.
ax.text2D(0.05, 0.95, "2D Text", transform=ax.transAxes)

# Tweaking display region and labels
ax.set_xlim(0, 10)
ax.set_ylim(0, 10)
ax.set_zlim(0, 10)
ax.set_xlabel('X axis')
ax.set_ylabel('Y axis')
ax.set_zlabel('Z axis')

plt.show()

```

Keywords: python, matplotlib, pylab, example, codex (see [Search examples](#))

97.25 mplot3d example code: tricontour3d_demo.py

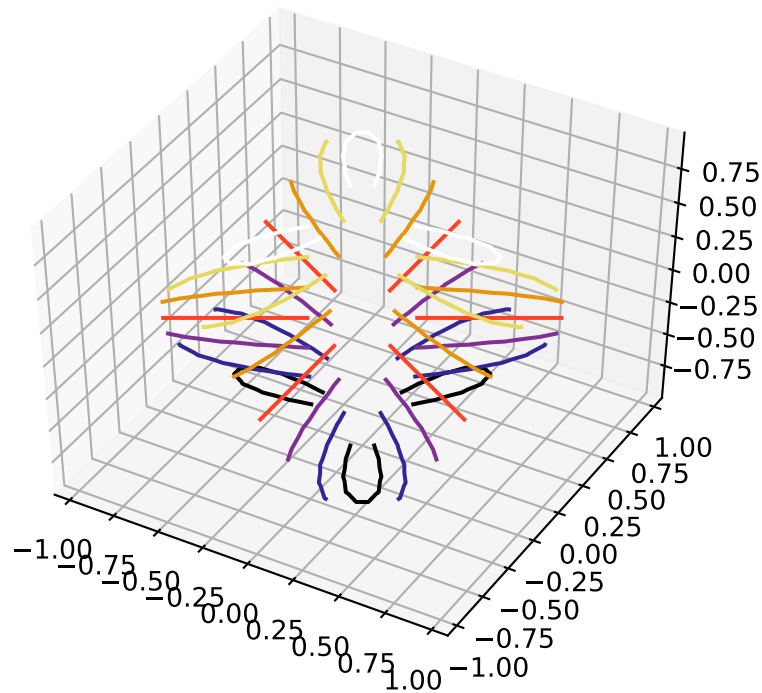

```

"""
=====
Triangular 3D contour plot
=====

Contour plots of unstructured triangular grids.

The data used is the same as in the second plot of trisurf3d_demo2.
tricontourf3d_demo shows the filled version of this example.
"""

import matplotlib.pyplot as plt
from mpl_toolkits.mplot3d import Axes3D
import matplotlib.tri as tri
import numpy as np

n_angles = 48
n_radii = 8
min_radius = 0.25

# Create the mesh in polar coordinates and compute x, y, z.
radii = np.linspace(min_radius, 0.95, n_radii)

```

```
angles = np.linspace(0, 2*np.pi, n_angles, endpoint=False)
angles = np.repeat(angles[..., np.newaxis], n_radii, axis=1)
angles[:, 1::2] += np.pi/n_angles

x = (radii*np.cos(angles)).flatten()
y = (radii*np.sin(angles)).flatten()
z = (np.cos(radii)*np.cos(angles*3.0)).flatten()

# Create a custom triangulation.
triang = tri.Triangulation(x, y)

# Mask off unwanted triangles.
xmid = x[triang.triangles].mean(axis=1)
ymid = y[triang.triangles].mean(axis=1)
mask = np.where(xmid*xmid + ymid*ymid < min_radius*min_radius, 1, 0)
triang.set_mask(mask)

fig = plt.figure()
ax = fig.gca(projection='3d')
ax.tricontour(triang, z, cmap=plt.cm.CMRmap)

# Customize the view angle so it's easier to understand the plot.
ax.view_init(elev=45.)

plt.show()
```

Keywords: python, matplotlib, pylab, example, codex (see [Search examples](#))

97.26 mplot3d example code: tricontourf3d_demo.py

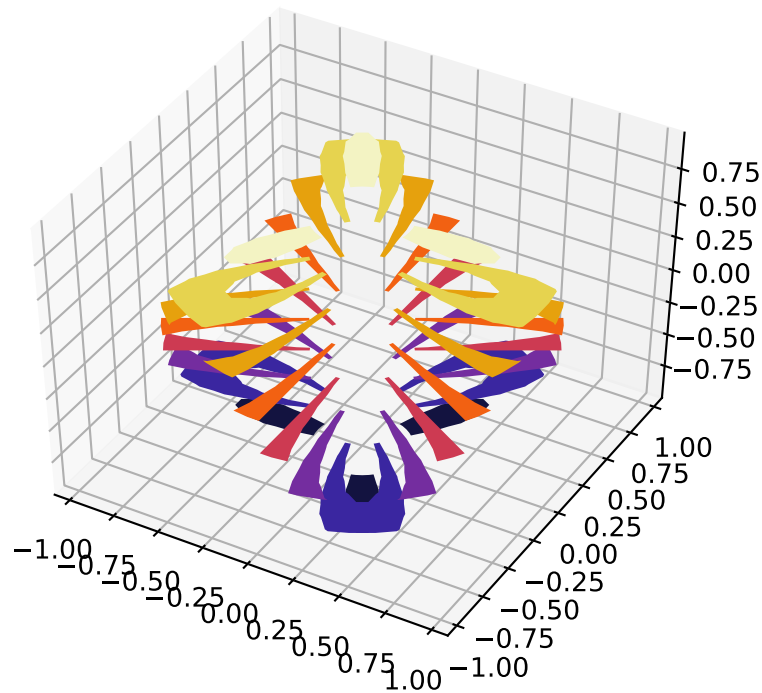

```

"""
=====
Triangular 3D filled contour plot
=====

Filled contour plots of unstructured triangular grids.

The data used is the same as in the second plot of trisurf3d_demo2.
tricontour3d_demo shows the unfilled version of this example.
"""

import matplotlib.pyplot as plt
from mpl_toolkits.mplot3d import Axes3D
import matplotlib.tri as tri
import numpy as np

# First create the x, y, z coordinates of the points.
n_angles = 48
n_radii = 8
min_radius = 0.25

# Create the mesh in polar coordinates and compute x, y, z.

```

```
radii = np.linspace(min_radius, 0.95, n_radii)
angles = np.linspace(0, 2*np.pi, n_angles, endpoint=False)
angles = np.repeat(angles[..., np.newaxis], n_radii, axis=1)
angles[:, 1::2] += np.pi/n_angles

x = (radii*np.cos(angles)).flatten()
y = (radii*np.sin(angles)).flatten()
z = (np.cos(radii)*np.cos(angles*3.0)).flatten()

# Create a custom triangulation.
triang = tri.Triangulation(x, y)

# Mask off unwanted triangles.
xmid = x[triang.triangles].mean(axis=1)
ymid = y[triang.triangles].mean(axis=1)
mask = np.where(xmid*xmid + ymid*ymid < min_radius*min_radius, 1, 0)
triang.set_mask(mask)

fig = plt.figure()
ax = fig.gca(projection='3d')
ax.tricontourf(triang, z, cmap=plt.cm.CMRmap)

# Customize the view angle so it's easier to understand the plot.
ax.view_init(elev=45.)

plt.show()
```

Keywords: python, matplotlib, pylab, example, codex (see [Search examples](#))

97.27 mplot3d example code: trisurf3d_demo.py

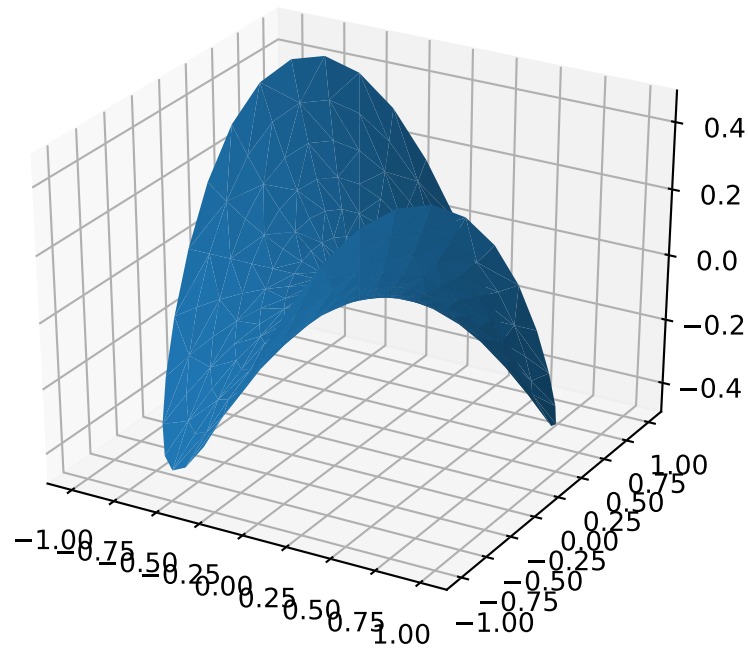

```

"""
=====
Triangular 3D surfaces
=====

Plot a 3D surface with a triangular mesh.
"""

from mpl_toolkits.mplot3d import Axes3D
import matplotlib.pyplot as plt
import numpy as np

n_radii = 8
n_angles = 36

# Make radii and angles spaces (radius r=0 omitted to eliminate duplication).
radii = np.linspace(0.125, 1.0, n_radii)
angles = np.linspace(0, 2*np.pi, n_angles, endpoint=False)

# Repeat all angles for each radius.
angles = np.repeat(angles[...], n_radii, axis=1)

```

```

# Convert polar (radii, angles) coords to cartesian (x, y) coords.
# (0, 0) is manually added at this stage, so there will be no duplicate
# points in the (x, y) plane.
x = np.append(0, (radii*np.cos(angles)).flatten())
y = np.append(0, (radii*np.sin(angles)).flatten())

# Compute z to make the pringle surface.
z = np.sin(-x*y)

fig = plt.figure()
ax = fig.gca(projection='3d')

ax.plot_trisurf(x, y, z, linewidth=0.2, antialiased=True)

plt.show()

```

Keywords: python, matplotlib, pylab, example, codex (see [Search examples](#))

97.28 mplot3d example code: trisurf3d_demo2.py

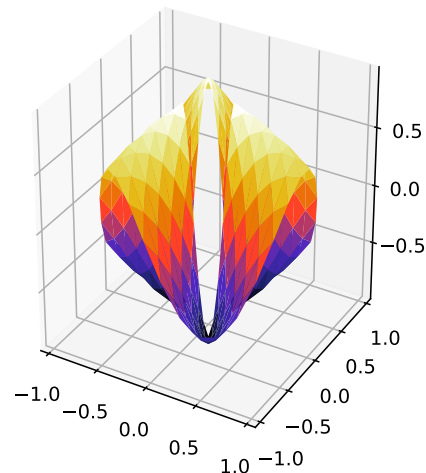
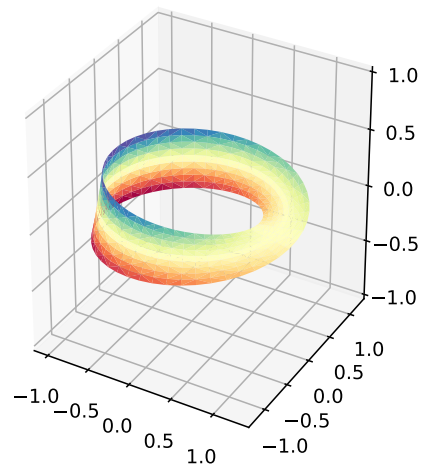

```

"""
=====
More triangular 3D surfaces
=====

Two additional examples of plotting surfaces with triangular mesh.

The first demonstrates use of plot_trisurf's triangles argument, and the
second sets a Triangulation object's mask and passes the object directly

```



```

to plot_trisurf.
"""

import numpy as np
import matplotlib.pyplot as plt
from mpl_toolkits.mplot3d import Axes3D
import matplotlib.tri as mtri

fig = plt.figure(figsize=plt.figaspect(0.5))

#=====
# First plot
#=====

# Make a mesh in the space of parameterisation variables u and v
u = np.linspace(0, 2.0 * np.pi, endpoint=True, num=50)
v = np.linspace(-0.5, 0.5, endpoint=True, num=10)
u, v = np.meshgrid(u, v)
u, v = u.flatten(), v.flatten()

# This is the Mobius mapping, taking a u, v pair and returning an x, y, z
# triple
x = (1 + 0.5 * v * np.cos(u / 2.0)) * np.cos(u)
y = (1 + 0.5 * v * np.cos(u / 2.0)) * np.sin(u)
z = 0.5 * v * np.sin(u / 2.0)

# Triangulate parameter space to determine the triangles
tri = mtri.Triangulation(u, v)

# Plot the surface. The triangles in parameter space determine which x, y, z
# points are connected by an edge.
ax = fig.add_subplot(1, 2, 1, projection='3d')
ax.plot_trisurf(x, y, z, triangles=tri.triangles, cmap=plt.cm.Spectral)
ax.set_zlim(-1, 1)

#=====
# Second plot
#=====

# Make parameter spaces radii and angles.
n_angles = 36
n_radii = 8
min_radius = 0.25
radii = np.linspace(min_radius, 0.95, n_radii)

angles = np.linspace(0, 2*np.pi, n_angles, endpoint=False)
angles = np.repeat(angles[...], n_radii, axis=1)
angles[:, 1::2] += np.pi/n_angles

# Map radius, angle pairs to x, y, z points.
x = (radii*np.cos(angles)).flatten()

```

```

y = (radii*np.sin(angles)).flatten()
z = (np.cos(radii)*np.cos(angles*3.0)).flatten()

# Create the Triangulation; no triangles so Delaunay triangulation created.
triang = mtri.Triangulation(x, y)

# Mask off unwanted triangles.
xmid = x[triang.triangles].mean(axis=1)
ymid = y[triang.triangles].mean(axis=1)
mask = np.where(xmid**2 + ymid**2 < min_radius**2, 1, 0)
triang.set_mask(mask)

# Plot the surface.
ax = fig.add_subplot(1, 2, 2, projection='3d')
ax.plot_trisurf(triang, z, cmap=plt.cm.CMRmap)

plt.show()

```

Keywords: python, matplotlib, pylab, example, codex (see [Search examples](#))

97.29 mplot3d example code: wire3d_animation_demo.py

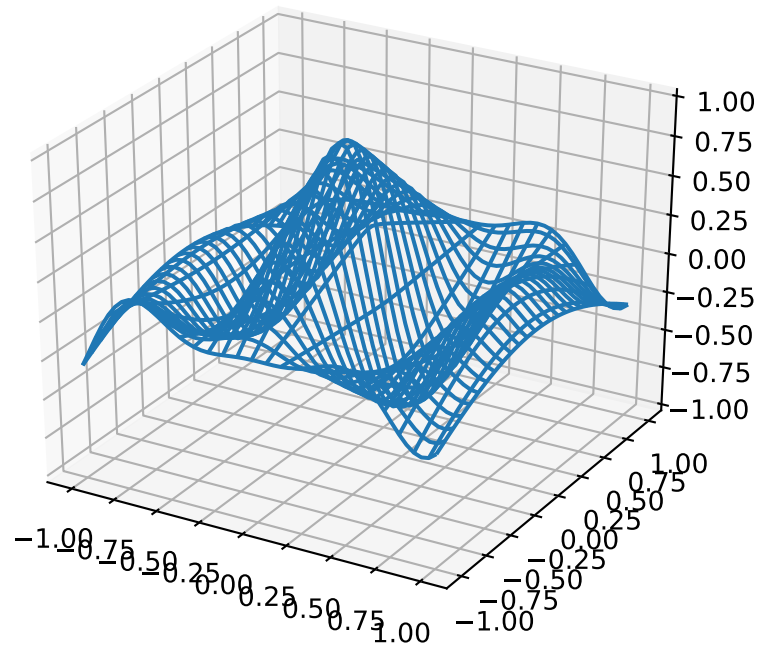

```

"""
=====
Rotating 3D wireframe plot
=====

A very simple 'animation' of a 3D plot. See also rotate_axes3d_demo.
"""

from __future__ import print_function

from mpl_toolkits.mplot3d import axes3d
import matplotlib.pyplot as plt
import numpy as np
import time

def generate(X, Y, phi):
    """
    Generates Z data for the points in the X, Y meshgrid and parameter phi.
    """
    R = 1 - np.sqrt(X**2 + Y**2)
    return np.cos(2 * np.pi * X + phi) * R

fig = plt.figure()
ax = fig.add_subplot(111, projection='3d')

# Make the X, Y meshgrid.
xs = np.linspace(-1, 1, 50)
ys = np.linspace(-1, 1, 50)
X, Y = np.meshgrid(xs, ys)

# Set the z axis limits so they aren't recalculated each frame.
ax.set_zlim(-1, 1)

# Begin plotting.
wframe = None
tstart = time.time()
for phi in np.linspace(0, 180. / np.pi, 100):
    # If a line collection is already remove it before drawing.
    if wframe:
        ax.collections.remove(wframe)

    # Plot the new wireframe and pause briefly before continuing.
    Z = generate(X, Y, phi)
    wframe = ax.plot_wireframe(X, Y, Z, rstride=2, cstride=2)
    plt.pause(.001)

print('Average FPS: %f' % (100 / (time.time() - tstart)))

```

Keywords: python, matplotlib, pylab, example, codex (see [Search examples](#))

97.30 mplot3d example code: wire3d_demo.py

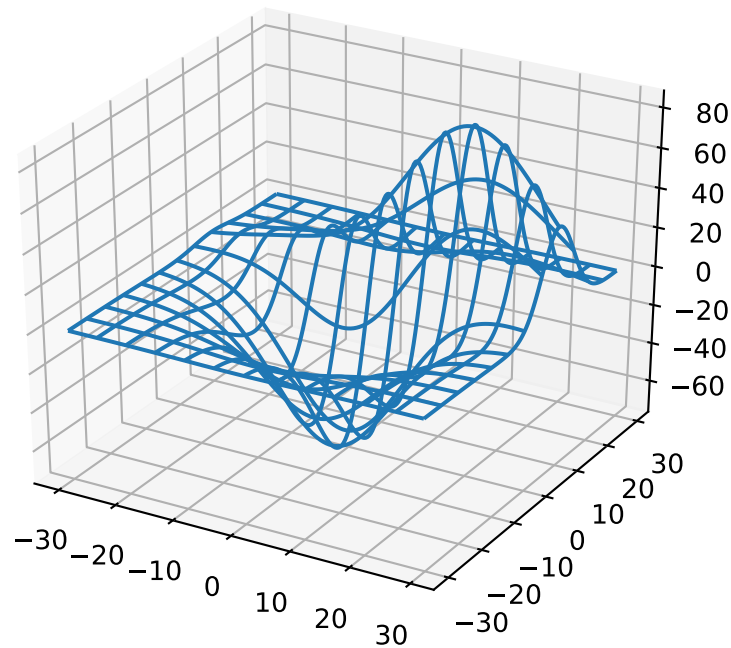

```
"""
=====
3D wireframe plot
=====

A very basic demonstration of a wireframe plot.
"""

from mpl_toolkits.mplot3d import axes3d
import matplotlib.pyplot as plt

fig = plt.figure()
ax = fig.add_subplot(111, projection='3d')

# Grab some test data.
X, Y, Z = axes3d.get_test_data(0.05)

# Plot a basic wireframe.
ax.plot_wireframe(X, Y, Z, rstride=10, cstride=10)

plt.show()
```

Keywords: python, matplotlib, pylab, example, codex (see [Search examples](#))

97.31 mplot3d example code: wire3d_zero_stride.py

Column (x) stride set to 0

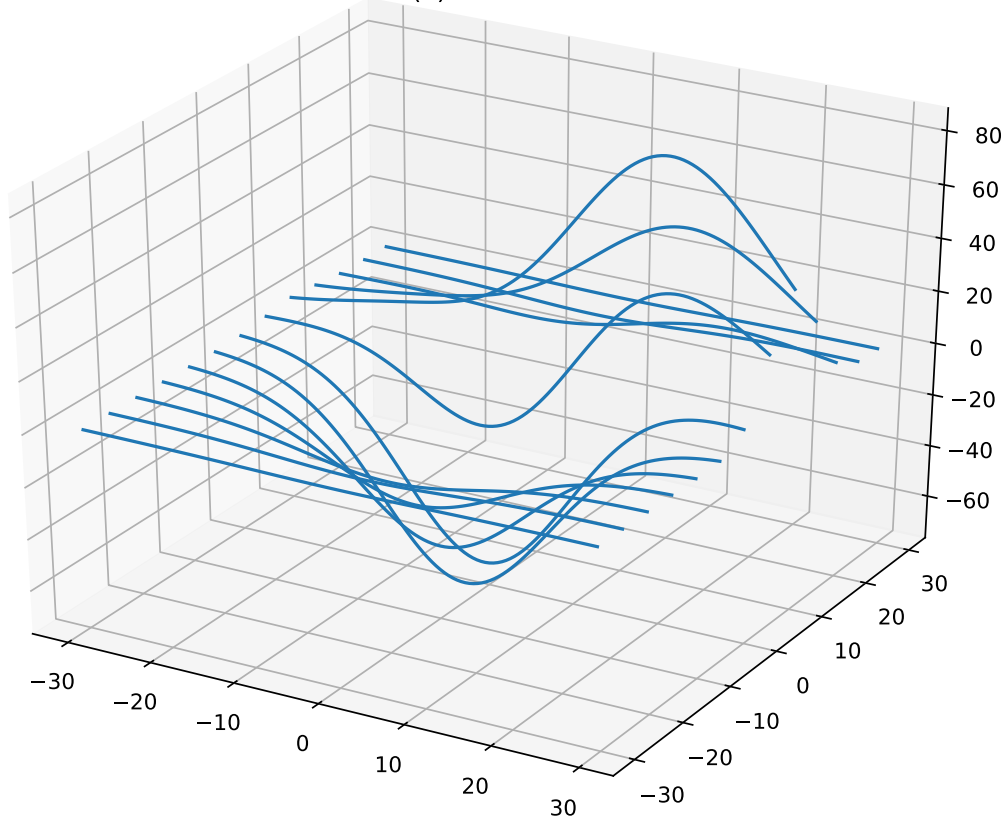

Row (y) stride set to 0

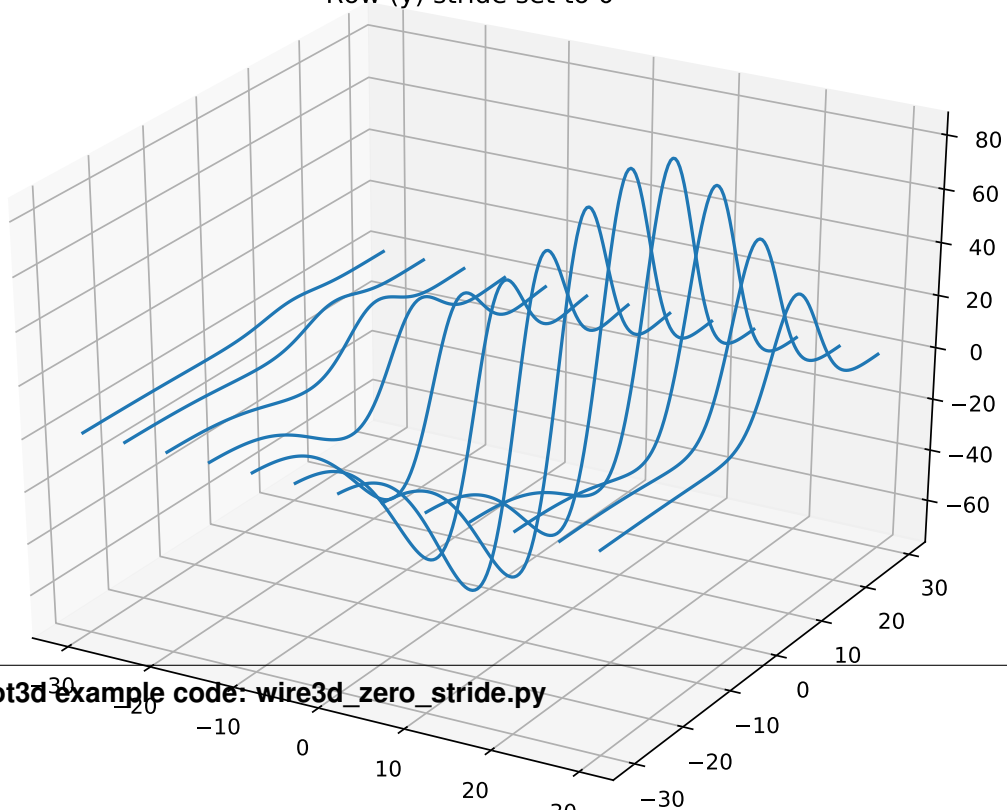

```
"""
=====
3D wireframe plots in one direction
=====

Demonstrates that setting rstride or cstride to 0 causes wires to not be
generated in the corresponding direction.
"""

from mpl_toolkits.mplot3d import axes3d
import matplotlib.pyplot as plt

fig, [ax1, ax2] = plt.subplots(2, 1, figsize=(8, 12), subplot_kw={'projection': '3d'})

# Get the test data
X, Y, Z = axes3d.get_test_data(0.05)

# Give the first plot only wireframes of the type y = c
ax1.plot_wireframe(X, Y, Z, rstride=10, cstride=0)
ax1.set_title("Column (x) stride set to 0")

# Give the second plot only wireframes of the type x = c
ax2.plot_wireframe(X, Y, Z, rstride=0, cstride=10)
ax2.set_title("Row (y) stride set to 0")

plt.tight_layout()
plt.show()
```

Keywords: python, matplotlib, pylab, example, codex (see [Search examples](#))

PIE_AND_POLAR_CHARTS EXAMPLES

98.1 pie_and_polar_charts example code: pie_demo_features.py

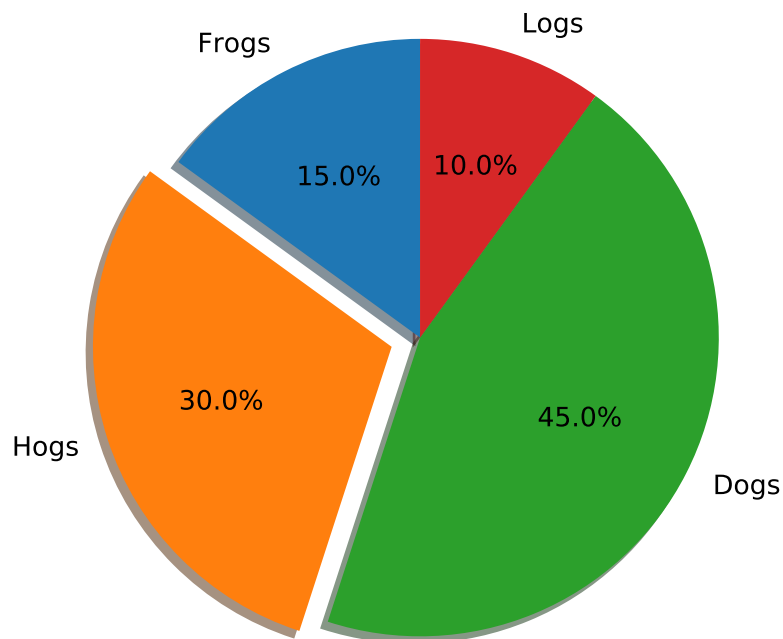

```
"""  
=====   
Basic pie chart  
=====   
  
Demo of a basic pie chart plus a few additional features.  
  
In addition to the basic pie chart, this demo shows a few optional features:  
"""
```

```
* slice labels
* auto-labeling the percentage
* offsetting a slice with "explode"
* drop-shadow
* custom start angle
```

Note about the custom start angle:

The default `startangle` is 0, which would start the "Frogs" slice on the positive x-axis. This example sets `startangle = 90` such that everything is rotated counter-clockwise by 90 degrees, and the frog slice starts on the positive y-axis.

```
"""
```

```
import matplotlib.pyplot as plt
```

```
# Pie chart, where the slices will be ordered and plotted counter-clockwise:
```

```
labels = 'Frogs', 'Hogs', 'Dogs', 'Logs'
```

```
sizes = [15, 30, 45, 10]
```

```
explode = (0, 0.1, 0, 0) # only "explode" the 2nd slice (i.e. 'Hogs')
```

```
fig1, ax1 = plt.subplots()
```

```
ax1.pie(sizes, explode=explode, labels=labels, autopct='%1.1f%%',
        shadow=True, startangle=90)
```

```
ax1.axis('equal') # Equal aspect ratio ensures that pie is drawn as a circle.
```

```
plt.show()
```

Keywords: python, matplotlib, pylab, example, codex (see [Search examples](#))

98.2 pie_and_polar_charts example code: polar_bar_demo.py

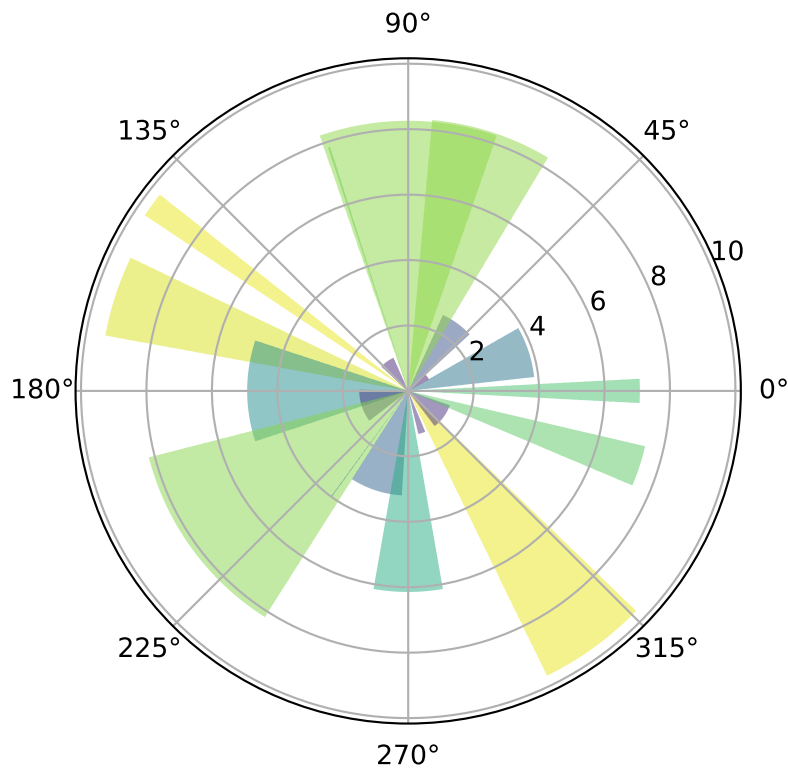

```

"""
=====
Pie chart on polar axis
=====

Demo of bar plot on a polar axis.
"""
import numpy as np
import matplotlib.pyplot as plt

# Compute pie slices
N = 20
theta = np.linspace(0.0, 2 * np.pi, N, endpoint=False)
radii = 10 * np.random.rand(N)
width = np.pi / 4 * np.random.rand(N)

ax = plt.subplot(111, projection='polar')
bars = ax.bar(theta, radii, width=width, bottom=0.0)

# Use custom colors and opacity
for r, bar in zip(radii, bars):

```

```

bar.set_facecolor(plt.cm.viridis(r / 10.))
bar.set_alpha(0.5)

plt.show()

```

Keywords: python, matplotlib, pylab, example, codex (see [Search examples](#))

98.3 pie_and_polar_charts example code: polar_scatter_demo.py

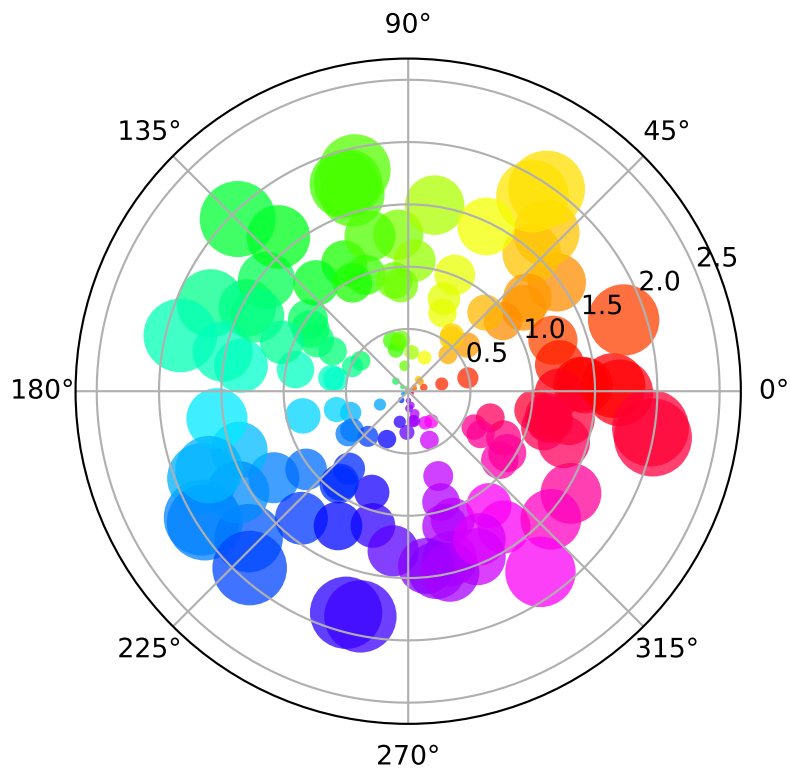

```

"""
=====
Scatter plot on polar axis
=====

Demo of scatter plot on a polar axis.

Size increases radially in this example and color increases with angle
(just to verify the symbols are being scattered correctly).
"""
import numpy as np
import matplotlib.pyplot as plt

```

```
# Compute areas and colors
N = 150
r = 2 * np.random.rand(N)
theta = 2 * np.pi * np.random.rand(N)
area = 200 * r**2
colors = theta

ax = plt.subplot(111, projection='polar')
c = ax.scatter(theta, r, c=colors, s=area, cmap='hsv', alpha=0.75)

plt.show()
```

Keywords: python, matplotlib, pylab, example, codex (see [Search examples](#))

PYLAB_EXAMPLES EXAMPLES

99.1 pylab_examples example code: accented_text.py

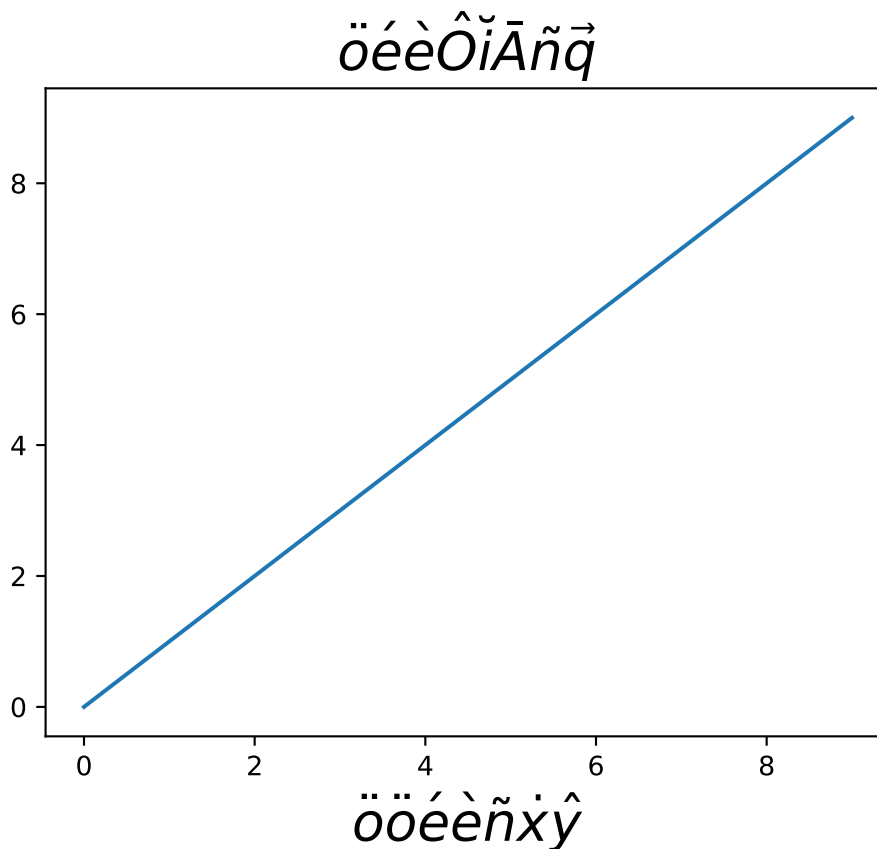

```
r"""
matplotlib supports accented characters via TeX mathtext

The following accents are provided: \hat, \breve, \grave, \bar,
\acute, \tilde, \vec, \dot, \ddot. All of them have the same syntax,
e.g., to make an overbar you do \bar{o} or to make an o umlaut you do
\ddot{o}. The shortcuts are also provided, e.g.,: \"o \"e \"e ~n ~x
^y
```

```

"""
import matplotlib.pyplot as plt

plt.axes([0.1, 0.15, 0.8, 0.75])
plt.plot(range(10))

plt.title(r'$\ddot{o}\acute{e}\grave{e}\hat{0}\breve{i}\bar{A}\tilde{n}\vec{q}$',
↪fontsize=20)
# shorthand is also supported and curly's are optional
plt.xlabel(r"o\ddot{o} \e\~n.x^y", fontsize=20)

plt.show()

```

Keywords: python, matplotlib, pylab, example, codex (see *Search examples*)

99.2 pylab_examples example code: agg_buffer.py

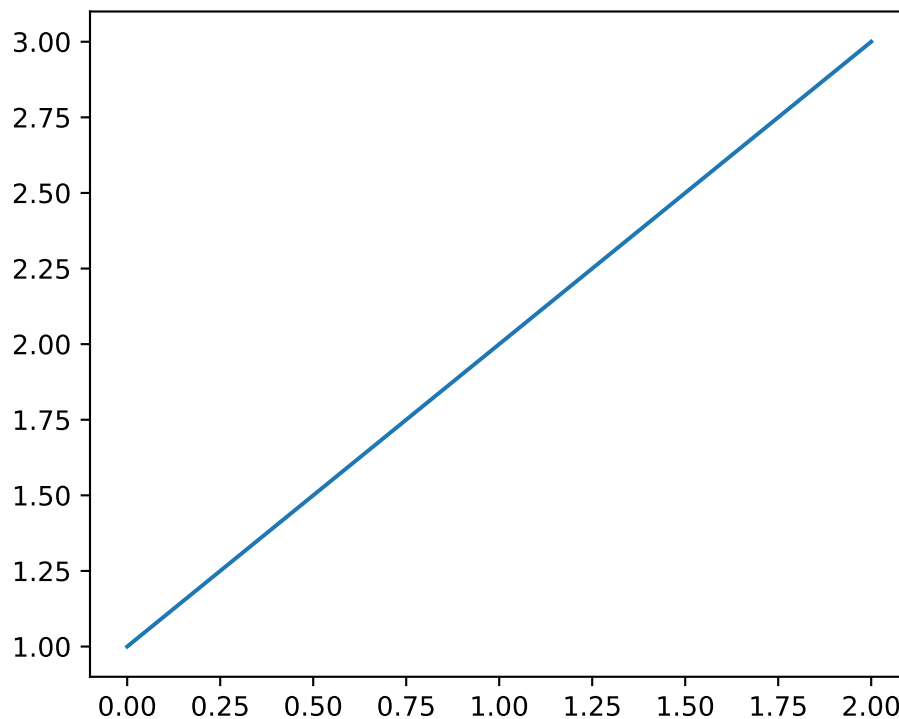

```

"""
Use backend agg to access the figure canvas as an RGB string and then
convert it to an array and pass it to Pillow for rendering.
"""

```



```
import numpy as np

import matplotlib.pyplot as plt
from matplotlib.backends.backend_agg import FigureCanvasAgg

try:
    from PIL import Image
except ImportError:
    raise SystemExit("Pillow must be installed to run this example")

plt.plot([1, 2, 3])

canvas = plt.get_current_fig_manager().canvas

agg = canvas.switch_backends(FigureCanvasAgg)
agg.draw()
s = agg.tostring_rgb()

# get the width and the height to resize the matrix
l, b, w, h = agg.figure.bbox.bounds
w, h = int(w), int(h)

X = np.fromstring(s, np.uint8)
X.shape = h, w, 3

try:
    im = Image.fromstring("RGB", (w, h), s)
except Exception:
    im = Image.frombytes("RGB", (w, h), s)

# Uncomment this line to display the image using ImageMagick's
# `display` tool.
# im.show()
```

Keywords: python, matplotlib, pylab, example, codex (see [Search examples](#))

99.3 pylab_examples example code: agg_buffer_to_array.py

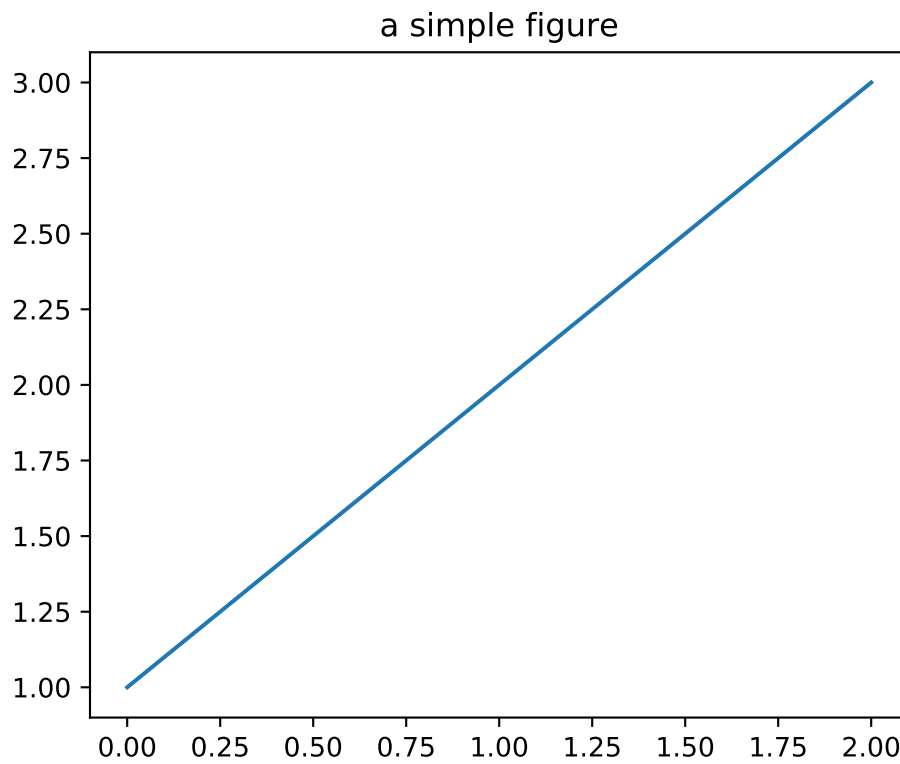

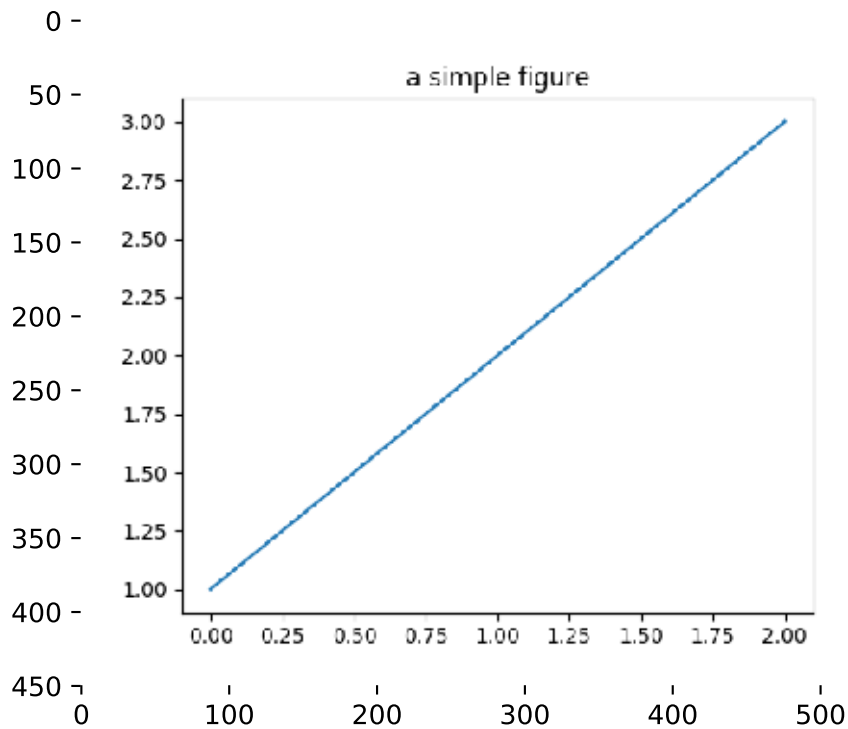

```
import matplotlib.pyplot as plt
import numpy as np

# make an agg figure
fig, ax = plt.subplots()
ax.plot([1, 2, 3])
ax.set_title('a simple figure')
fig.canvas.draw()

# grab the pixel buffer and dump it into a numpy array
X = np.array(fig.canvas.renderer._renderer)

# now display the array X as an Axes in a new figure
fig2 = plt.figure()
ax2 = fig2.add_subplot(111, frameon=False)
ax2.imshow(X)
plt.show()
```

Keywords: python, matplotlib, pylab, example, codex (see [Search examples](#))

99.4 pylab_examples example code: alignment_test.py

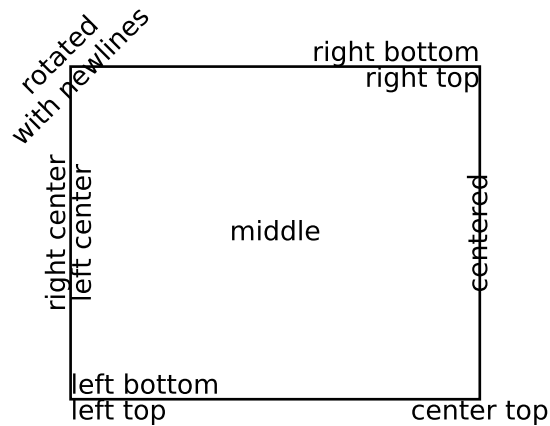

```

"""
You can precisely layout text in data or axes (0,1) coordinates. This
example shows you some of the alignment and rotation specifications to
layout text
"""

import matplotlib.pyplot as plt
from matplotlib.lines import Line2D
from matplotlib.patches import Rectangle

# build a rectangle in axes coords
left, width = .25, .5
bottom, height = .25, .5
right = left + width
top = bottom + height
ax = plt.gca()
p = plt.Rectangle((left, bottom), width, height,
                  fill=False,
                  )
p.set_transform(ax.transAxes)
p.set_clip_on(False)
ax.add_patch(p)

```

```
ax.text(left, bottom, 'left top',
        horizontalalignment='left',
        verticalalignment='top',
        transform=ax.transAxes)

ax.text(left, bottom, 'left bottom',
        horizontalalignment='left',
        verticalalignment='bottom',
        transform=ax.transAxes)

ax.text(right, top, 'right bottom',
        horizontalalignment='right',
        verticalalignment='bottom',
        transform=ax.transAxes)

ax.text(right, top, 'right top',
        horizontalalignment='right',
        verticalalignment='top',
        transform=ax.transAxes)

ax.text(right, bottom, 'center top',
        horizontalalignment='center',
        verticalalignment='top',
        transform=ax.transAxes)

ax.text(left, 0.5*(bottom + top), 'right center',
        horizontalalignment='right',
        verticalalignment='center',
        rotation='vertical',
        transform=ax.transAxes)

ax.text(left, 0.5*(bottom + top), 'left center',
        horizontalalignment='left',
        verticalalignment='center',
        rotation='vertical',
        transform=ax.transAxes)

ax.text(0.5*(left + right), 0.5*(bottom + top), 'middle',
        horizontalalignment='center',
        verticalalignment='center',
        transform=ax.transAxes)

ax.text(right, 0.5*(bottom + top), 'centered',
        horizontalalignment='center',
        verticalalignment='center',
        rotation='vertical',
        transform=ax.transAxes)

ax.text(left, top, 'rotated\nwith newlines',
        horizontalalignment='center',
        verticalalignment='center',
```

```

        rotation=45,
        transform=ax.transAxes)

plt.axis('off')

plt.show()

```

Keywords: python, matplotlib, pylab, example, codex (see [Search examples](#))

99.5 pylab_examples example code: anchored_artists.py

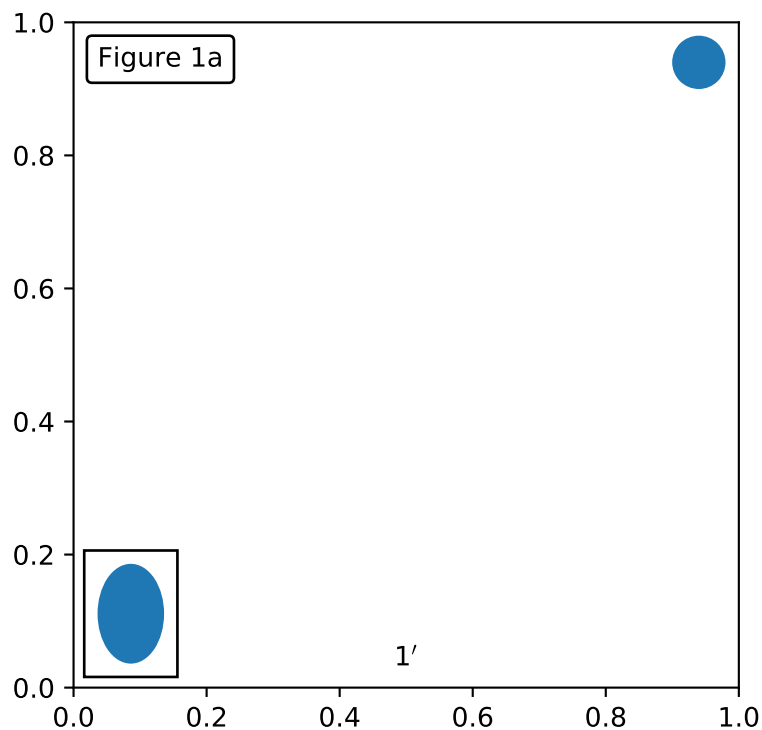

```

from matplotlib.patches import Rectangle, Ellipse

from matplotlib.offsetbox import AnchoredOffsetbox, AuxTransformBox, VPacker,\
    TextArea, DrawingArea

class AnchoredText(AnchoredOffsetbox):
    def __init__(self, s, loc, pad=0.4, borderpad=0.5, prop=None, frameon=True):

        self.txt = TextArea(s,
                            minimumdescent=False)

```

```

    super(AnchoredText, self).__init__(loc, pad=pad, borderpad=borderpad,
                                       child=self.txt,
                                       prop=prop,
                                       frameon=frameon)

class AnchoredSizeBar(AnchoredOffsetbox):
    def __init__(self, transform, size, label, loc,
                 pad=0.1, borderpad=0.1, sep=2, prop=None, frameon=True):
        """
        Draw a horizontal bar with the size in data coordinate of the give axes.
        A label will be drawn underneath (center-aligned).

        pad, borderpad in fraction of the legend font size (or prop)
        sep in points.
        """
        self.size_bar = AuxTransformBox(transform)
        self.size_bar.add_artist(Rectangle((0, 0), size, 0, fc="none", lw=1.0))

        self.txt_label = TextArea(label, minimumdescent=False)

        self._box = VPacker(children=[self.size_bar, self.txt_label],
                              align="center",
                              pad=0, sep=sep)

        AnchoredOffsetbox.__init__(self, loc, pad=pad, borderpad=borderpad,
                                   child=self._box,
                                   prop=prop,
                                   frameon=frameon)

class AnchoredEllipse(AnchoredOffsetbox):
    def __init__(self, transform, width, height, angle, loc,
                 pad=0.1, borderpad=0.1, prop=None, frameon=True):
        """
        Draw an ellipse the size in data coordinate of the give axes.

        pad, borderpad in fraction of the legend font size (or prop)
        """
        self._box = AuxTransformBox(transform)
        self.ellipse = Ellipse((0, 0), width, height, angle)
        self._box.add_artist(self.ellipse)

        AnchoredOffsetbox.__init__(self, loc, pad=pad, borderpad=borderpad,
                                   child=self._box,
                                   prop=prop,
                                   frameon=frameon)

class AnchoredDrawingArea(AnchoredOffsetbox):
    def __init__(self, width, height, xdescent, ydescent,
                 loc, pad=0.4, borderpad=0.5, prop=None, frameon=True):

```

```

self.da = DrawingArea(width, height, xdescent, ydescent)

super(AnchoredDrawingArea, self).__init__(loc, pad=pad, borderpad=borderpad,
                                          child=self.da,
                                          prop=None,
                                          frameon=frameon)

if __name__ == "__main__":

    import matplotlib.pyplot as plt

    ax = plt.gca()
    ax.set_aspect(1.)

    at = AnchoredText("Figure 1a",
                     loc=2, frameon=True)
    at.patch.set_boxstyle("round,pad=0.,rounding_size=0.2")
    ax.add_artist(at)

    from matplotlib.patches import Circle
    ada = AnchoredDrawingArea(20, 20, 0, 0,
                              loc=1, pad=0., frameon=False)
    p = Circle((10, 10), 10)
    ada.da.add_artist(p)
    ax.add_artist(ada)

    # draw an ellipse of width=0.1, height=0.15 in the data coordinate
    ae = AnchoredEllipse(ax.transData, width=0.1, height=0.15, angle=0.,
                        loc=3, pad=0.5, borderpad=0.4, frameon=True)

    ax.add_artist(ae)

    # draw a horizontal bar with length of 0.1 in Data coordinate
    # (ax.transData) with a label underneath.
    asb = AnchoredSizeBar(ax.transData,
                          0.1,
                          r"1${\prime}$",
                          loc=8,
                          pad=0.1, borderpad=0.5, sep=5,
                          frameon=False)

    ax.add_artist(asb)

    plt.draw()
    plt.show()

```

Keywords: python, matplotlib, pylab, example, codex (see [Search examples](#))

99.6 pylab_examples example code: animation_demo.py

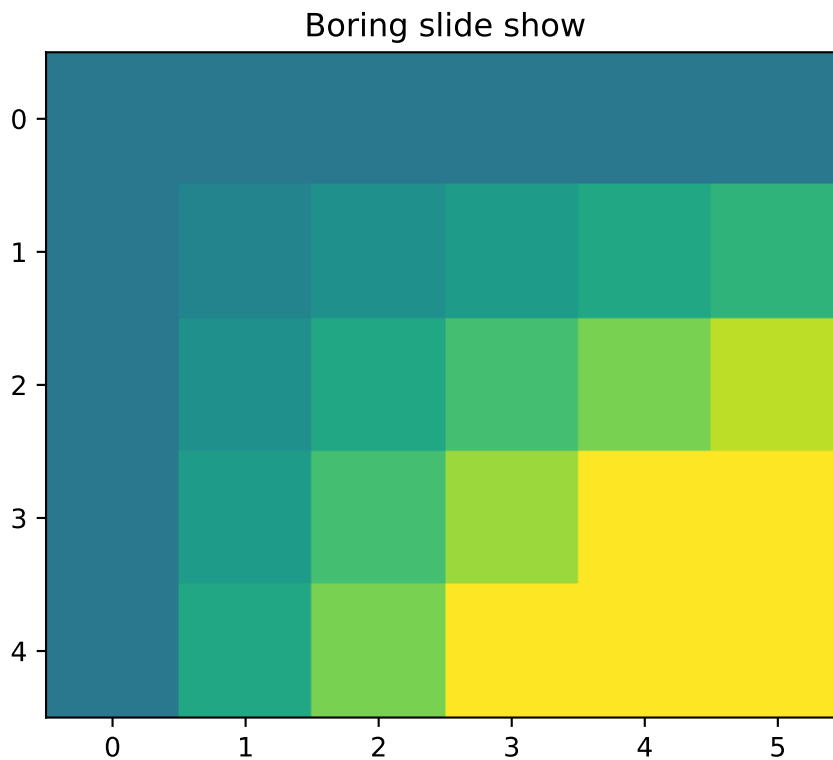

```

"""
Pyplot animation example.

The method shown here is only for very simple, low-performance
use. For more demanding applications, look at the animation
module and the examples that use it.
"""

import matplotlib.pyplot as plt
import numpy as np

x = np.arange(6)
y = np.arange(5)
z = x * y[:, np.newaxis]

for i in range(5):
    if i == 0:
        p = plt.imshow(z)
        fig = plt.gcf()
        plt.clim() # clamp the color limits
        plt.title("Boring slide show")
    else:

```

```
z = z + 2
p.set_data(z)

print("step", i)
plt.pause(0.5)
```

Keywords: python, matplotlib, pylab, example, codex (see [Search examples](#))

99.7 pylab_examples example code: annotation_demo.py

figure fraction

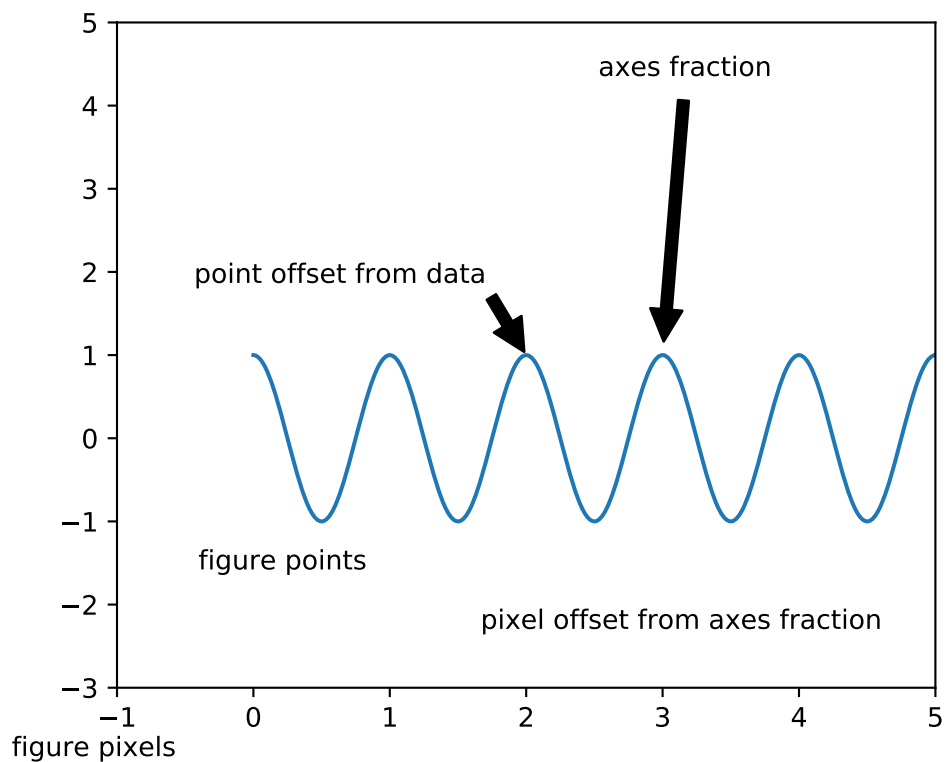

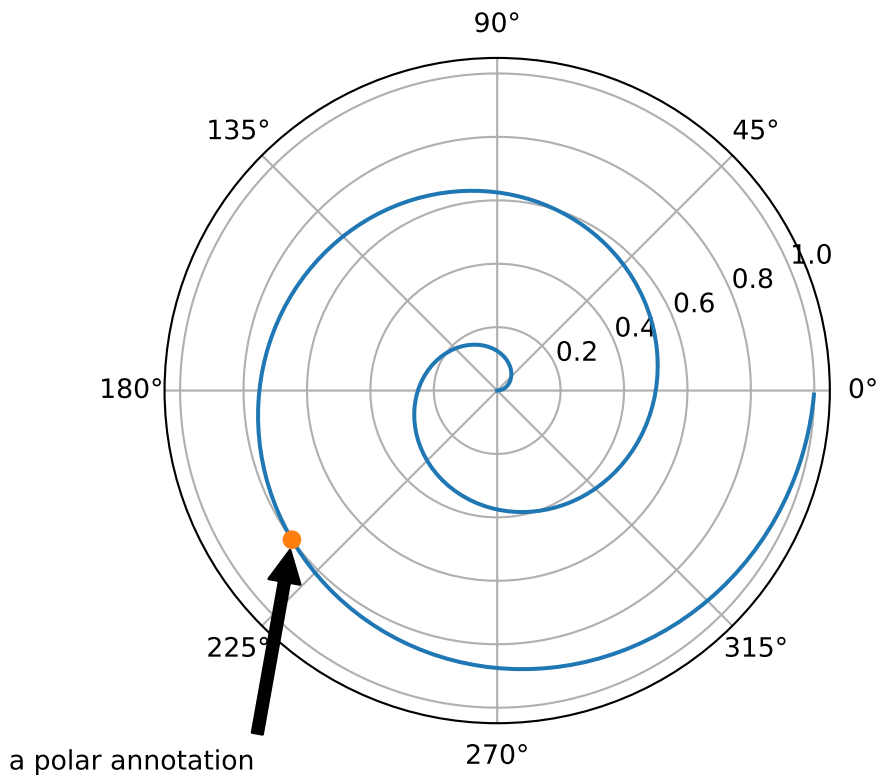

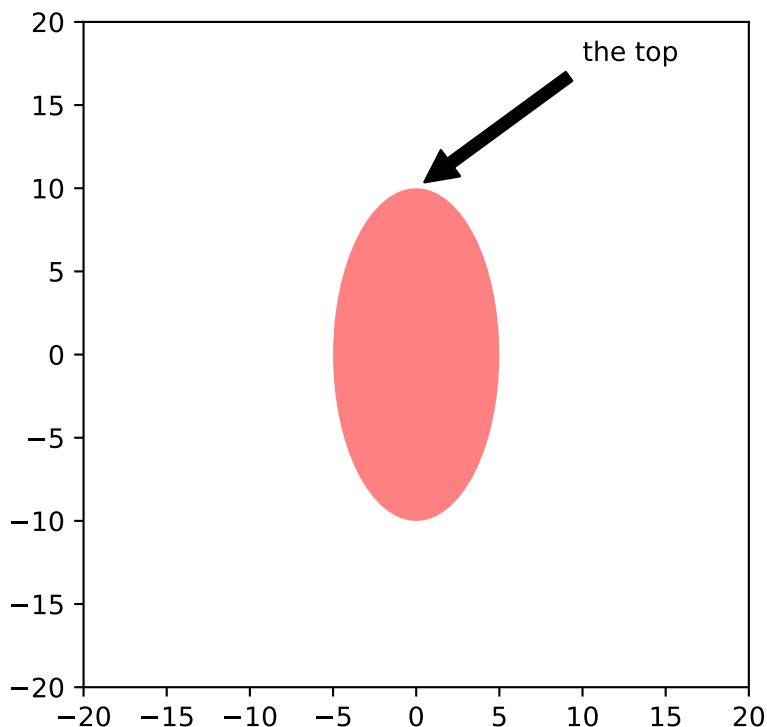

```
"""
```

Some examples of how to annotate points in figures. You specify an annotation point $xy=(x,y)$ and a text point $xytext=(x,y)$ for the annotated points and text location, respectively. Optionally, you can specify the coordinate system of xy and $xytext$ with one of the following strings for $xycoords$ and $textcoords$ (default is 'data')

```
'figure points' : points from the lower left corner of the figure
'figure pixels' : pixels from the lower left corner of the figure
'figure fraction' : 0,0 is lower left of figure and 1,1 is upper, right
'axes points' : points from lower left corner of axes
'axes pixels' : pixels from lower left corner of axes
'axes fraction' : 0,0 is lower left of axes and 1,1 is upper right
'offset points' : Specify an offset (in points) from the xy value
'offset pixels' : Specify an offset (in pixels) from the xy value
'data' : use the axes data coordinate system
```

Optionally, you can specify arrow properties which draws an arrow from the text to the annotated point by giving a dictionary of arrow properties

Valid keys are

```
width : the width of the arrow in points
frac : the fraction of the arrow length occupied by the head
```

```

        headwidth : the width of the base of the arrow head in points
        shrink : move the tip and base some percent away from the
                  annotated point and text
        any key for matplotlib.patches.polygon (e.g., facecolor)

For physical coordinate systems (points or pixels) the origin is the
(bottom, left) of the figure or axes.
"""

import matplotlib.pyplot as plt
from matplotlib.patches import Ellipse
import numpy as np

# If only one location is given, the text and xypoint being
# annotated are assumed to be the same
fig = plt.figure()
ax = fig.add_subplot(111, autoscale_on=False, xlim=(-1, 5), ylim=(-3, 5))

t = np.arange(0.0, 5.0, 0.01)
s = np.cos(2*np.pi*t)
line, = ax.plot(t, s)

ax.annotate('figure pixels',
            xy=(10, 10), xycoords='figure pixels')

ax.annotate('figure points',
            xy=(80, 80), xycoords='figure points')

ax.annotate('point offset from data',
            xy=(2, 1), xycoords='data',
            xytext=(-15, 25), textcoords='offset points',
            arrowprops=dict(facecolor='black', shrink=0.05),
            horizontalalignment='right', verticalalignment='bottom')

ax.annotate('axes fraction',
            xy=(3, 1), xycoords='data',
            xytext=(0.8, 0.95), textcoords='axes fraction',
            arrowprops=dict(facecolor='black', shrink=0.05),
            horizontalalignment='right', verticalalignment='top')

ax.annotate('figure fraction',
            xy=(.025, .975), xycoords='figure fraction',
            horizontalalignment='left', verticalalignment='top',
            fontsize=20)

# use negative points or pixels to specify from right, top -10, 10
# is 10 points to the left of the right side of the axes and 10
# points above the bottom
ax.annotate('pixel offset from axes fraction',
            xy=(1, 0), xycoords='axes fraction',
            xytext=(-20, 20), textcoords='offset pixels',

```

```

        horizontalalignment='right',
        verticalalignment='bottom')

# You can specify the xypoint and the xytext in different positions and
# coordinate systems, and optionally turn on a connecting line and mark
# the point with a marker. Annotations work on polar axes too.
# In the example below, the xy point is in native coordinates (xycoords
# defaults to 'data'). For a polar axes, this is in (theta, radius) space.
# The text in the example is placed in the fractional figure coordinate system.
# Text keyword args like horizontal and vertical alignment are respected.
fig = plt.figure()
ax = fig.add_subplot(111, projection='polar')
r = np.arange(0, 1, 0.001)
theta = 2*2*np.pi*r
line, = ax.plot(theta, r)

ind = 800
thisr, thistheta = r[ind], theta[ind]
ax.plot([thistheta], [thisr], 'o')
ax.annotate('a polar annotation',
            xy=(thistheta, thisr), # theta, radius
            xytext=(0.05, 0.05), # fraction, fraction
            textcoords='figure fraction',
            arrowprops=dict(facecolor='black', shrink=0.05),
            horizontalalignment='left',
            verticalalignment='bottom')

# You can also use polar notation on a cartesian axes. Here the native
# coordinate system ('data') is cartesian, so you need to specify the
# xycoords and textcoords as 'polar' if you want to use (theta, radius).

el = Ellipse((0, 0), 10, 20, facecolor='r', alpha=0.5)

fig = plt.figure()
ax = fig.add_subplot(111, aspect='equal')
ax.add_artist(el)
el.set_clip_box(ax.bbox)
ax.annotate('the top',
            xy=(np.pi/2., 10.), # theta, radius
            xytext=(np.pi/3, 20.), # theta, radius
            xycoords='polar',
            textcoords='polar',
            arrowprops=dict(facecolor='black', shrink=0.05),
            horizontalalignment='left',
            verticalalignment='bottom',
            clip_on=True) # clip to the axes bounding box

ax.set_xlim([-20, 20])
ax.set_ylim([-20, 20])

plt.show()

```

Keywords: python, matplotlib, pylab, example, codex (see [Search examples](#))

99.8 pylab_examples example code: annotation_demo2.py

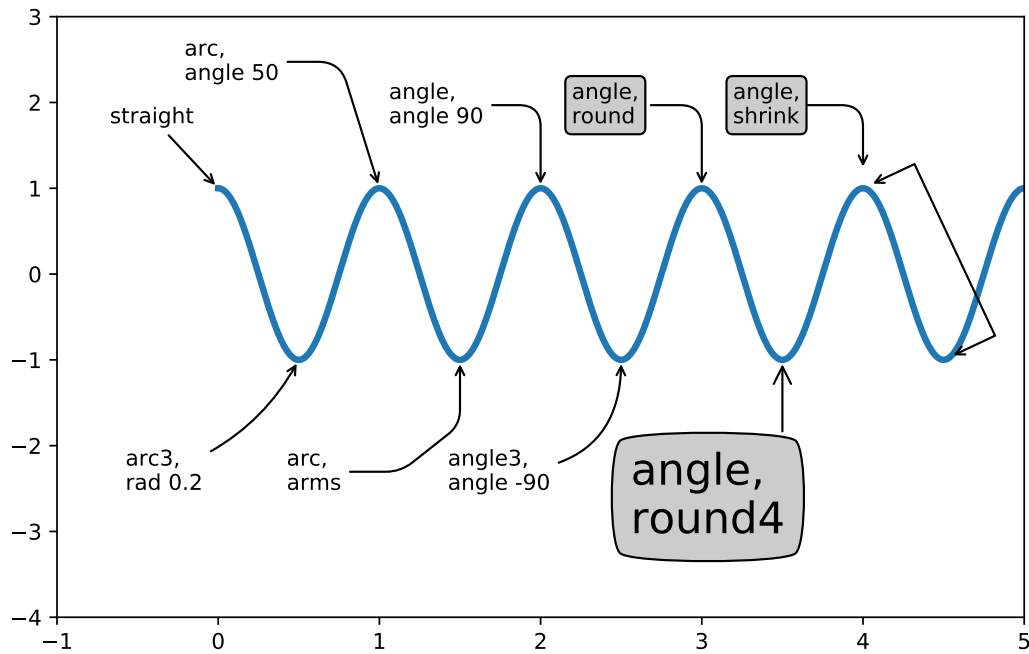

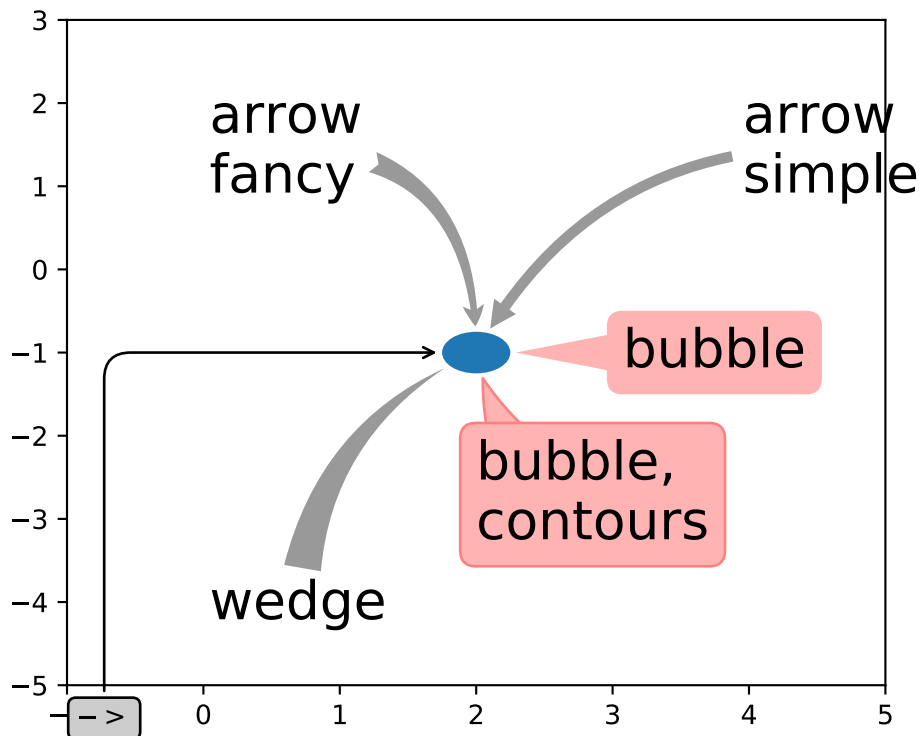

```

import matplotlib.pyplot as plt
from matplotlib.patches import Ellipse
import numpy as np

fig = plt.figure(1, figsize=(8, 5))
ax = fig.add_subplot(111, autoscale_on=False, xlim=(-1, 5), ylim=(-4, 3))

t = np.arange(0.0, 5.0, 0.01)
s = np.cos(2*np.pi*t)
line, = ax.plot(t, s, lw=3)

ax.annotate('straight',
            xy=(0, 1), xycoords='data',
            xytext=(-50, 30), textcoords='offset points',
            arrowprops=dict(arrowstyle="->"))

ax.annotate('arc3, \nrad 0.2',
            xy=(0.5, -1), xycoords='data',
            xytext=(-80, -60), textcoords='offset points',
            arrowprops=dict(arrowstyle="->",
                            connectionstyle="arc3,rad=.2"))

ax.annotate('arc, \nangle 50',
            xy=(1., 1), xycoords='data',
            xytext=(-90, 50), textcoords='offset points',

```



```

        arrowprops=dict(arrowstyle="->",
                        connectionstyle="arc,angleA=0,armA=50,rad=10"))

ax.annotate('arc,\narms',
            xy=(1.5, -1), xycoords='data',
            xytext=(-80, -60), textcoords='offset points',
            arrowprops=dict(arrowstyle="->",
                            connectionstyle="arc,angleA=0,armA=40,angleB=-90,armB=30,
->rad=7"))

ax.annotate('angle,\nangle 90',
            xy=(2., 1), xycoords='data',
            xytext=(-70, 30), textcoords='offset points',
            arrowprops=dict(arrowstyle="->",
                            connectionstyle="angle,angleA=0,angleB=90,rad=10"))

ax.annotate('angle3,\nangle -90',
            xy=(2.5, -1), xycoords='data',
            xytext=(-80, -60), textcoords='offset points',
            arrowprops=dict(arrowstyle="->",
                            connectionstyle="angle3,angleA=0,angleB=-90"))

ax.annotate('angle,\nround',
            xy=(3., 1), xycoords='data',
            xytext=(-60, 30), textcoords='offset points',
            bbox=dict(boxstyle="round", fc="0.8"),
            arrowprops=dict(arrowstyle="->",
                            connectionstyle="angle,angleA=0,angleB=90,rad=10"))

ax.annotate('angle,\nround4',
            xy=(3.5, -1), xycoords='data',
            xytext=(-70, -80), textcoords='offset points',
            size=20,
            bbox=dict(boxstyle="round4,pad=.5", fc="0.8"),
            arrowprops=dict(arrowstyle="->",
                            connectionstyle="angle,angleA=0,angleB=-90,rad=10"))

ax.annotate('angle,\nshrink',
            xy=(4., 1), xycoords='data',
            xytext=(-60, 30), textcoords='offset points',
            bbox=dict(boxstyle="round", fc="0.8"),
            arrowprops=dict(arrowstyle="->",
                            shrinkA=0, shrinkB=10,
                            connectionstyle="angle,angleA=0,angleB=90,rad=10"))

# You can pass an empty string to get only annotation arrows rendered
ann = ax.annotate('', xy=(4., 1.), xycoords='data',
                  xytext=(4.5, -1), textcoords='data',
                  arrowprops=dict(arrowstyle="<->",
                                  connectionstyle="bar",
                                  ec="k",
                                  shrinkA=5, shrinkB=5))

```

```

fig = plt.figure(2)
fig.clf()
ax = fig.add_subplot(111, autoscale_on=False, xlim=(-1, 5), ylim=(-5, 3))

el = Ellipse((2, -1), 0.5, 0.5)
ax.add_patch(el)

ax.annotate('$->$',
            xy=(2., -1), xycoords='data',
            xytext=(-150, -140), textcoords='offset points',
            bbox=dict(boxstyle="round", fc="0.8"),
            arrowprops=dict(arrowstyle="->",
                            patchB=el,
                            connectionstyle="angle,angleA=90,angleB=0,rad=10"))

ax.annotate('arrow\nfancy',
            xy=(2., -1), xycoords='data',
            xytext=(-100, 60), textcoords='offset points',
            size=20,
            # bbox=dict(boxstyle="round", fc="0.8"),
            arrowprops=dict(arrowstyle="fancy",
                            fc="0.6", ec="none",
                            patchB=el,
                            connectionstyle="angle3,angleA=0,angleB=-90"))

ax.annotate('arrow\nsimple',
            xy=(2., -1), xycoords='data',
            xytext=(100, 60), textcoords='offset points',
            size=20,
            # bbox=dict(boxstyle="round", fc="0.8"),
            arrowprops=dict(arrowstyle="simple",
                            fc="0.6", ec="none",
                            patchB=el,
                            connectionstyle="arc3,rad=0.3"))

ax.annotate('wedge',
            xy=(2., -1), xycoords='data',
            xytext=(-100, -100), textcoords='offset points',
            size=20,
            # bbox=dict(boxstyle="round", fc="0.8"),
            arrowprops=dict(arrowstyle="wedge,tail_width=0.7",
                            fc="0.6", ec="none",
                            patchB=el,
                            connectionstyle="arc3,rad=-0.3"))

ann = ax.annotate('bubble,\ncontours',
                  xy=(2., -1), xycoords='data',
                  xytext=(0, -70), textcoords='offset points',
                  size=20,
                  bbox=dict(boxstyle="round",
                            fc=(1.0, 0.7, 0.7),
                            ec=(1., .5, .5)),

```

```

arrowprops=dict(arrowstyle="wedge,tail_width=1.",
                 fc=(1.0, 0.7, 0.7), ec=(1., .5, .5),
                 patchA=None,
                 patchB=e1,
                 relpos=(0.2, 0.8),
                 connectionstyle="arc3,rad=-0.1"))

ann = ax.annotate('bubble',
                 xy=(2., -1), xycoords='data',
                 xytext=(55, 0), textcoords='offset points',
                 size=20, va="center",
                 bbox=dict(boxstyle="round", fc=(1.0, 0.7, 0.7), ec="none"),
                 arrowprops=dict(arrowstyle="wedge,tail_width=1.",
                                 fc=(1.0, 0.7, 0.7), ec="none",
                                 patchA=None,
                                 patchB=e1,
                                 relpos=(0.2, 0.5)))

plt.show()

```

Keywords: python, matplotlib, pylab, example, codex (see [Search examples](#))

99.9 pylab_examples example code: annotation_demo3.py

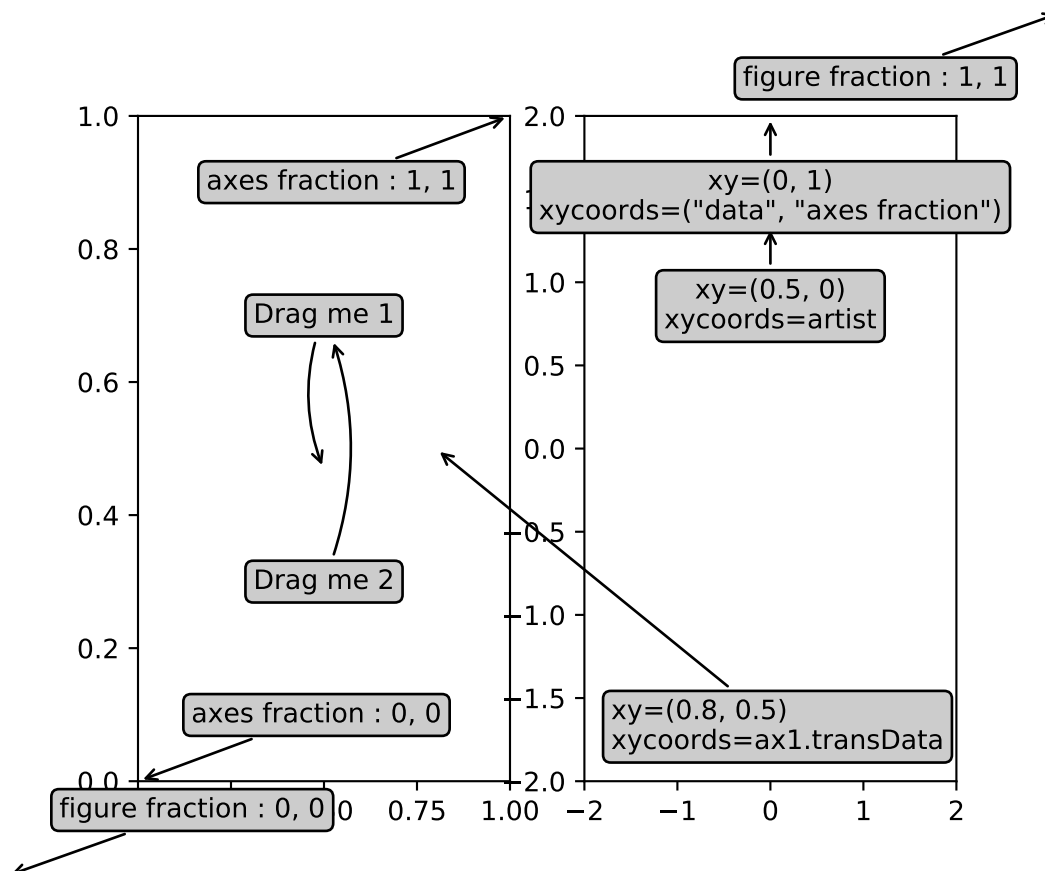

```

import matplotlib.pyplot as plt
from matplotlib.text import OffsetFrom

fig, (ax1, ax2) = plt.subplots(1, 2)

bbox_args = dict(boxstyle="round", fc="0.8")
arrow_args = dict(arrowstyle="->")

ax1.annotate('figure fraction : 0, 0', xy=(0, 0), xycoords='figure fraction',
             xytext=(20, 20), textcoords='offset points',
             ha="left", va="bottom",
             bbox=bbox_args,
             arrowprops=arrow_args)

ax1.annotate('figure fraction : 1, 1', xy=(1, 1), xycoords='figure fraction',
             xytext=(-20, -20), textcoords='offset points',
             ha="right", va="top",
             bbox=bbox_args,
             arrowprops=arrow_args)

ax1.annotate('axes fraction : 0, 0', xy=(0, 0), xycoords='axes fraction',
             xytext=(20, 20), textcoords='offset points',
             ha="left", va="bottom",
             bbox=bbox_args,
             arrowprops=arrow_args)

ax1.annotate('axes fraction : 1, 1', xy=(1, 1), xycoords='axes fraction',
             xytext=(-20, -20), textcoords='offset points',
             ha="right", va="top",
             bbox=bbox_args,
             arrowprops=arrow_args)

an1 = ax1.annotate('Drag me 1', xy=(.5, .7), xycoords='data',
                  #xytext=(.5, .7), textcoords='data',
                  ha="center", va="center",
                  bbox=bbox_args,
                  #arrowprops=arrow_args
                  )

an2 = ax1.annotate('Drag me 2', xy=(.5, .5), xycoords=an1,
                  xytext=(.5, .3), textcoords='axes fraction',
                  ha="center", va="center",
                  bbox=bbox_args,
                  arrowprops=dict(patchB=an1.get_bbox_patch(),
                                  connectionstyle="arc3,rad=0.2",
                                  **arrow_args))

an3 = ax1.annotate('', xy=(.5, .5), xycoords=an2,
                  xytext=(.5, .5), textcoords=an1,
                  ha="center", va="center",
                  bbox=bbox_args,

```

```
        arrowprops=dict(patchA=an1.get_bbox_patch(),
                        patchB=an2.get_bbox_patch(),
                        connectionstyle="arc3,rad=0.2",
                        **arrow_args))

t = ax2.annotate('xy=(0, 1)\nxycoords=("data", "axes fraction")',
                xy=(0, 1), xycoords=("data", 'axes fraction'),
                xytext=(0, -20), textcoords='offset points',
                ha="center", va="top",
                bbox=bbox_args,
                arrowprops=arrow_args)

ax2.annotate('xy=(0.5, 0)\nxycoords=artist',
            xy=(0.5, 0.), xycoords=t,
            xytext=(0, -20), textcoords='offset points',
            ha="center", va="top",
            bbox=bbox_args,
            arrowprops=arrow_args)

ax2.annotate('xy=(0.8, 0.5)\nxycoords=ax1.transData',
            xy=(0.8, 0.5), xycoords=ax1.transData,
            xytext=(10, 10),
            textcoords=OffsetFrom(ax2.bbox, (0, 0), "points"),
            ha="left", va="bottom",
            bbox=bbox_args,
            arrowprops=arrow_args)

ax2.set_xlim([-2, 2])
ax2.set_ylim([-2, 2])

an1.draggable()
an2.draggable()

plt.show()
```

Keywords: python, matplotlib, pylab, example, codex (see [Search examples](#))

99.10 pylab_examples example code: anscombe.py

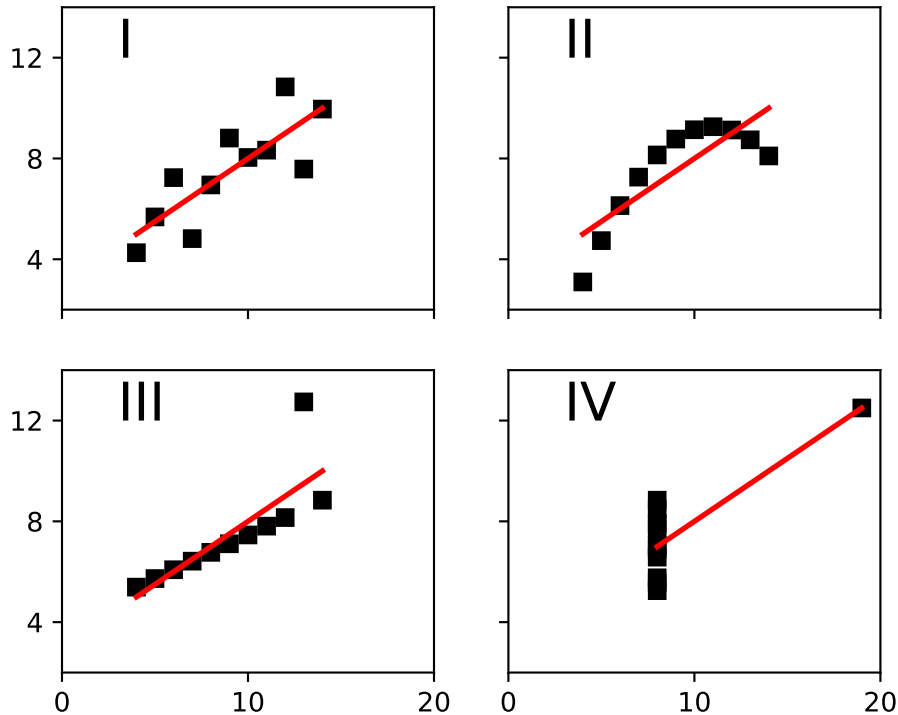

```

from __future__ import print_function
"""
Edward Tufte uses this example from Anscombe to show 4 datasets of x
and y that have the same mean, standard deviation, and regression
line, but which are qualitatively different.

matplotlib fun for a rainy day
"""

import matplotlib.pyplot as plt
import numpy as np

x = np.array([10, 8, 13, 9, 11, 14, 6, 4, 12, 7, 5])
y1 = np.array([8.04, 6.95, 7.58, 8.81, 8.33, 9.96, 7.24, 4.26, 10.84, 4.82, 5.68])
y2 = np.array([9.14, 8.14, 8.74, 8.77, 9.26, 8.10, 6.13, 3.10, 9.13, 7.26, 4.74])
y3 = np.array([7.46, 6.77, 12.74, 7.11, 7.81, 8.84, 6.08, 5.39, 8.15, 6.42, 5.73])
x4 = np.array([8, 8, 8, 8, 8, 8, 8, 19, 8, 8, 8])
y4 = np.array([6.58, 5.76, 7.71, 8.84, 8.47, 7.04, 5.25, 12.50, 5.56, 7.91, 6.89])

def fit(x):
    return 3 + 0.5*x

```

```

xfit = np.array([np.amin(x), np.amax(x)])

plt.subplot(221)
plt.plot(x, y1, 'ks', xfit, fit(xfit), 'r-', lw=2)
plt.axis([2, 20, 2, 14])
plt.setp(plt.gca(), xticklabels=[], yticks=(4, 8, 12), xticks=(0, 10, 20))
plt.text(3, 12, 'I', fontsize=20)

plt.subplot(222)
plt.plot(x, y2, 'ks', xfit, fit(xfit), 'r-', lw=2)
plt.axis([2, 20, 2, 14])
plt.setp(plt.gca(), xticklabels=[], yticks=(4, 8, 12), yticklabels=[], xticks=(0, 10, 20))
plt.text(3, 12, 'II', fontsize=20)

plt.subplot(223)
plt.plot(x, y3, 'ks', xfit, fit(xfit), 'r-', lw=2)
plt.axis([2, 20, 2, 14])
plt.text(3, 12, 'III', fontsize=20)
plt.setp(plt.gca(), yticks=(4, 8, 12), xticks=(0, 10, 20))

plt.subplot(224)

xfit = np.array([np.amin(x4), np.amax(x4)])
plt.plot(x4, y4, 'ks', xfit, fit(xfit), 'r-', lw=2)
plt.axis([2, 20, 2, 14])
plt.setp(plt.gca(), yticklabels=[], yticks=(4, 8, 12), xticks=(0, 10, 20))
plt.text(3, 12, 'IV', fontsize=20)

# verify the stats
pairs = (x, y1), (x, y2), (x, y3), (x4, y4)
for x, y in pairs:
    print('mean=%1.2f, std=%1.2f, r=%1.2f' % (np.mean(y), np.std(y), np.corrcoef(x, y)[0][1]))

plt.show()

```

Keywords: python, matplotlib, pylab, example, codex (see [Search examples](#))

99.11 pylab_examples example code: arctest.py

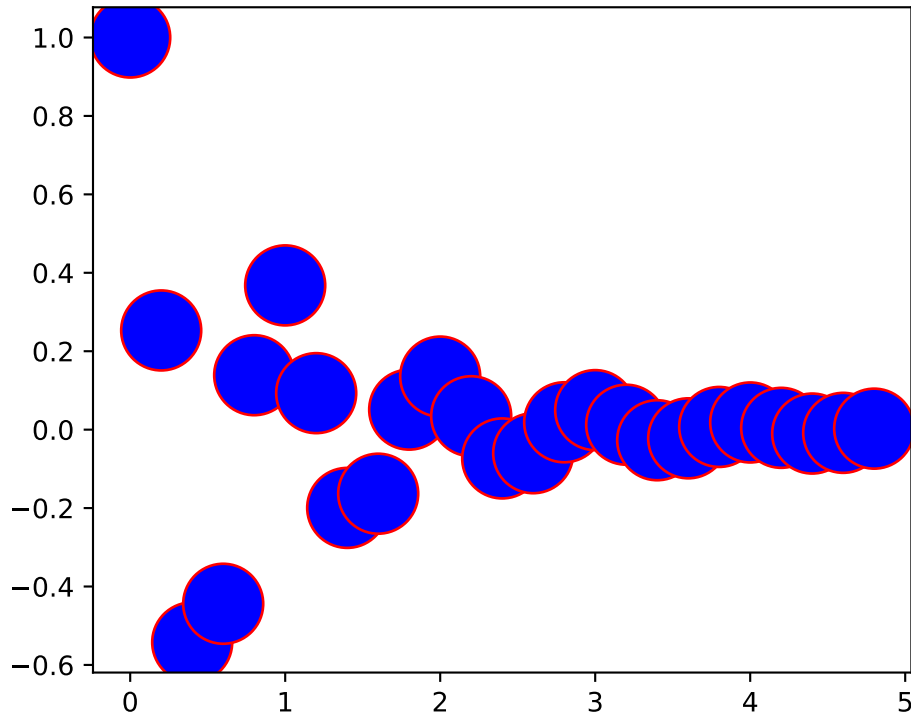

```
import matplotlib.pyplot as plt
import numpy as np

def f(t):
    'a damped exponential'
    s1 = np.cos(2 * np.pi * t)
    e1 = np.exp(-t)
    return s1 * e1

t1 = np.arange(0.0, 5.0, .2)

l = plt.plot(t1, f(t1), 'ro')
plt.setp(l, 'markersize', 30)
plt.setp(l, 'markerfacecolor', 'b')

plt.show()
```

Keywords: python, matplotlib, pylab, example, codex (see [Search examples](#))

99.12 pylab_examples example code: arrow_demo.py

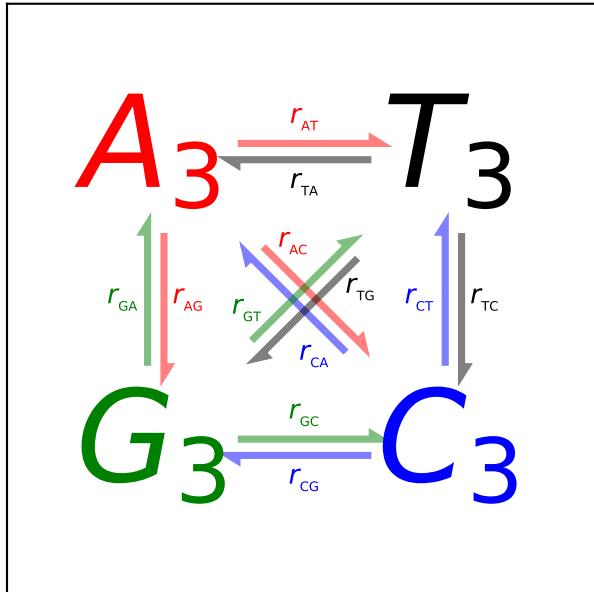

```

"""Arrow drawing example for the new fancy_arrow facilities.

Code contributed by: Rob Knight <rob@spot.colorado.edu>

usage:

    python arrow_demo.py realistic/full/sample/extreme

"""
import matplotlib.pyplot as plt
import numpy as np

rates_to_bases = {'r1': 'AT', 'r2': 'TA', 'r3': 'GA', 'r4': 'AG', 'r5': 'CA',
                  'r6': 'AC', 'r7': 'GT', 'r8': 'TG', 'r9': 'CT', 'r10': 'TC',
                  'r11': 'GC', 'r12': 'CG'}
numbered_bases_to_rates = dict([(v, k) for k, v in rates_to_bases.items()])
lettered_bases_to_rates = dict([(v, 'r' + v) for k, v in rates_to_bases.items()])

def add_dicts(d1, d2):
    """Adds two dicts and returns the result."""
    result = d1.copy()
    result.update(d2)
    return result

```

```

def make_arrow_plot(data, size=4, display='length', shape='right',
                    max_arrow_width=0.03, arrow_sep=0.02, alpha=0.5,
                    normalize_data=False, ec=None, labelcolor=None,
                    head_starts_at_zero=True, rate_labels=lettered_bases_to_rates,
                    **kwargs):
    """Makes an arrow plot.

    Parameters:

    data: dict with probabilities for the bases and pair transitions.
    size: size of the graph in inches.
    display: 'length', 'width', or 'alpha' for arrow property to change.
    shape: 'full', 'left', or 'right' for full or half arrows.
    max_arrow_width: maximum width of an arrow, data coordinates.
    arrow_sep: separation between arrows in a pair, data coordinates.
    alpha: maximum opacity of arrows, default 0.8.

    **kwargs can be anything allowed by a Arrow object, e.g.
    linewidth and edgecolor.
    """

    plt.xlim(-0.5, 1.5)
    plt.ylim(-0.5, 1.5)
    plt.gcf().set_size_inches(size, size)
    plt.xticks([])
    plt.yticks([])
    max_text_size = size*12
    min_text_size = size
    label_text_size = size*2.5
    text_params = {'ha': 'center', 'va': 'center', 'family': 'sans-serif',
                  'fontweight': 'bold'}
    r2 = np.sqrt(2)

    deltas = {
        'AT': (1, 0),
        'TA': (-1, 0),
        'GA': (0, 1),
        'AG': (0, -1),
        'CA': (-1/r2, 1/r2),
        'AC': (1/r2, -1/r2),
        'GT': (1/r2, 1/r2),
        'TG': (-1/r2, -1/r2),
        'CT': (0, 1),
        'TC': (0, -1),
        'GC': (1, 0),
        'CG': (-1, 0)
    }

    colors = {
        'AT': 'r',
        'TA': 'k',

```

```

    'GA': 'g',
    'AG': 'r',
    'CA': 'b',
    'AC': 'r',
    'GT': 'g',
    'TG': 'k',
    'CT': 'b',
    'TC': 'k',
    'GC': 'g',
    'CG': 'b'
}

label_positions = {
    'AT': 'center',
    'TA': 'center',
    'GA': 'center',
    'AG': 'center',
    'CA': 'left',
    'AC': 'left',
    'GT': 'left',
    'TG': 'left',
    'CT': 'center',
    'TC': 'center',
    'GC': 'center',
    'CG': 'center'
}

def do_fontsize(k):
    return float(np.clip(max_text_size*np.sqrt(data[k]),
                        min_text_size, max_text_size))

A = plt.text(0, 1, '$A_3$', color='r', size=do_fontsize('A'), **text_params)
T = plt.text(1, 1, '$T_3$', color='k', size=do_fontsize('T'), **text_params)
G = plt.text(0, 0, '$G_3$', color='g', size=do_fontsize('G'), **text_params)
C = plt.text(1, 0, '$C_3$', color='b', size=do_fontsize('C'), **text_params)

arrow_h_offset = 0.25 # data coordinates, empirically determined
max_arrow_length = 1 - 2*arrow_h_offset

max_arrow_width = max_arrow_width
max_head_width = 2.5*max_arrow_width
max_head_length = 2*max_arrow_width
arrow_params = {'length_includes_head': True, 'shape': shape,
                'head_starts_at_zero': head_starts_at_zero}
ax = plt.gca()
sf = 0.6 # max arrow size represents this in data coords

d = (r2/2 + arrow_h_offset - 0.5)/r2 # distance for diags
r2v = arrow_sep/r2 # offset for diags

# tuple of x, y for start position
positions = {
    'AT': (arrow_h_offset, 1 + arrow_sep),

```

```

'TA': (1 - arrow_h_offset, 1 - arrow_sep),
'GA': (-arrow_sep, arrow_h_offset),
'AG': (arrow_sep, 1 - arrow_h_offset),
'CA': (1 - d - r2v, d - r2v),
'AC': (d + r2v, 1 - d + r2v),
'GT': (d - r2v, d + r2v),
'TG': (1 - d + r2v, 1 - d - r2v),
'CT': (1 - arrow_sep, arrow_h_offset),
'TC': (1 + arrow_sep, 1 - arrow_h_offset),
'GC': (arrow_h_offset, arrow_sep),
'CG': (1 - arrow_h_offset, -arrow_sep),
}

if normalize_data:
    # find maximum value for rates, i.e. where keys are 2 chars long
    max_val = 0
    for k, v in data.items():
        if len(k) == 2:
            max_val = max(max_val, v)
    # divide rates by max val, multiply by arrow scale factor
    for k, v in data.items():
        data[k] = v/max_val*sf

def draw_arrow(pair, alpha=alpha, ec=ec, labelcolor=labelcolor):
    # set the length of the arrow
    if display == 'length':
        length = max_head_length + data[pair]/sf*(max_arrow_length -
            max_head_length)

    else:
        length = max_arrow_length
    # set the transparency of the arrow
    if display == 'alph':
        alpha = min(data[pair]/sf, alpha)
    else:
        alpha = alpha
    # set the width of the arrow
    if display == 'width':
        scale = data[pair]/sf
        width = max_arrow_width*scale
        head_width = max_head_width*scale
        head_length = max_head_length*scale
    else:
        width = max_arrow_width
        head_width = max_head_width
        head_length = max_head_length

    fc = colors[pair]
    ec = ec or fc

    x_scale, y_scale = deltas[pair]
    x_pos, y_pos = positions[pair]
    plt.arrow(x_pos, y_pos, x_scale*length, y_scale*length,
        fc=fc, ec=ec, alpha=alpha, width=width, head_width=head_width,

```

```

        head_length=head_length, **arrow_params)

# figure out coordinates for text
# if drawing relative to base: x and y are same as for arrow
# dx and dy are one arrow width left and up
# need to rotate based on direction of arrow, use x_scale and y_scale
# as sin x and cos x?
sx, cx = y_scale, x_scale

where = label_positions[pair]
if where == 'left':
    orig_position = 3*np.array([[max_arrow_width, max_arrow_width]])
elif where == 'absolute':
    orig_position = np.array([[max_arrow_length/2.0, 3*max_arrow_width]])
elif where == 'right':
    orig_position = np.array([[length - 3*max_arrow_width,
                               3*max_arrow_width]])

elif where == 'center':
    orig_position = np.array([[length/2.0, 3*max_arrow_width]])
else:
    raise ValueError("Got unknown position parameter %s" % where)

M = np.array([[cx, sx], [-sx, cx]])
coords = np.dot(orig_position, M) + [[x_pos, y_pos]]
x, y = np.ravel(coords)
orig_label = rate_labels[pair]
label = '$%s_{-\mathrm{%s}}$' % (orig_label[0], orig_label[1:])

plt.text(x, y, label, size=label_text_size, ha='center', va='center',
         color=labelcolor or fc)

for p in sorted(positions):
    draw_arrow(p)

# test data
all_on_max = dict([(i, 1) for i in 'TCAG'] +
                  [(i + j, 0.6) for i in 'TCAG' for j in 'TCAG'])

realistic_data = {
    'A': 0.4,
    'T': 0.3,
    'G': 0.5,
    'C': 0.2,
    'AT': 0.4,
    'AC': 0.3,
    'AG': 0.2,
    'TA': 0.2,
    'TC': 0.3,
    'TG': 0.4,
    'CT': 0.2,
    'CG': 0.3,
    'CA': 0.2,
    'GA': 0.1,

```

```
'GT': 0.4,
'GC': 0.1,
}

extreme_data = {
    'A': 0.75,
    'T': 0.10,
    'G': 0.10,
    'C': 0.05,
    'AT': 0.6,
    'AC': 0.3,
    'AG': 0.1,
    'TA': 0.02,
    'TC': 0.3,
    'TG': 0.01,
    'CT': 0.2,
    'CG': 0.5,
    'CA': 0.2,
    'GA': 0.1,
    'GT': 0.4,
    'GC': 0.2,
}

sample_data = {
    'A': 0.2137,
    'T': 0.3541,
    'G': 0.1946,
    'C': 0.2376,
    'AT': 0.0228,
    'AC': 0.0684,
    'AG': 0.2056,
    'TA': 0.0315,
    'TC': 0.0629,
    'TG': 0.0315,
    'CT': 0.1355,
    'CG': 0.0401,
    'CA': 0.0703,
    'GA': 0.1824,
    'GT': 0.0387,
    'GC': 0.1106,
}

if __name__ == '__main__':
    from sys import argv
    d = None
    if len(argv) > 1:
        if argv[1] == 'full':
            d = all_on_max
            scaled = False
        elif argv[1] == 'extreme':
            d = extreme_data
            scaled = False
```

```
    elif argv[1] == 'realistic':
        d = realistic_data
        scaled = False
    elif argv[1] == 'sample':
        d = sample_data
        scaled = True
if d is None:
    d = all_on_max
    scaled = False
if len(argv) > 2:
    display = argv[2]
else:
    display = 'length'

size = 4
plt.figure(figsize=(size, size))

make_arrow_plot(d, display=display, linewidth=0.001, edgecolor=None,
                normalize_data=scaled, head_starts_at_zero=True, size=size)

plt.draw()

plt.show()
```

Keywords: python, matplotlib, pylab, example, codex (see [Search examples](#))

99.13 pylab_examples example code: arrow_simple_demo.py

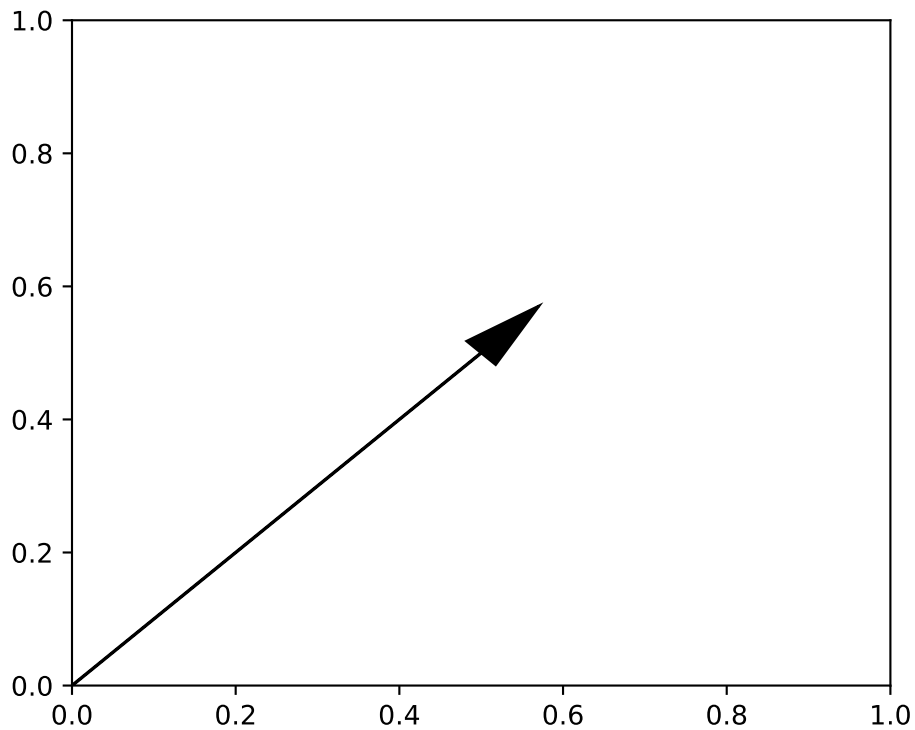

```
import matplotlib.pyplot as plt

ax = plt.axes()
ax.arrow(0, 0, 0.5, 0.5, head_width=0.05, head_length=0.1, fc='k', ec='k')
plt.show()
```

Keywords: python, matplotlib, pylab, example, codex (see [Search examples](#))

99.14 pylab_examples example code: aspect_loglog.py

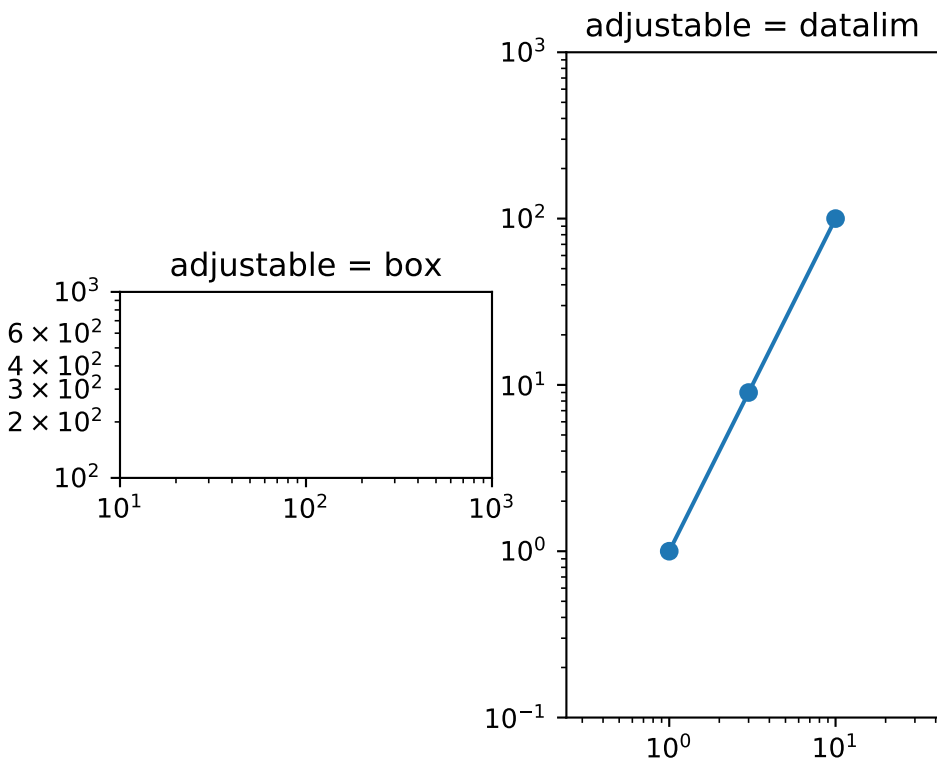

```
import matplotlib.pyplot as plt

fig, (ax1, ax2) = plt.subplots(1, 2)
ax1.set_xscale("log")
ax1.set_yscale("log")
ax1.set_xlim(1e1, 1e3)
ax1.set_ylim(1e2, 1e3)
ax1.set_aspect(1)
ax1.set_title("adjustable = box")

ax2.set_xscale("log")
ax2.set_yscale("log")
ax2.set_adjustable("datalim")
ax2.plot([1, 3, 10], [1, 9, 100], "o-")
ax2.set_xlim(1e-1, 1e2)
ax2.set_ylim(1e-1, 1e3)
ax2.set_aspect(1)
ax2.set_title("adjustable = datalim")

plt.draw()
plt.show()
```

Keywords: python, matplotlib, pylab, example, codex (see *Search examples*)

99.15 pylab_examples example code: axes_demo.py

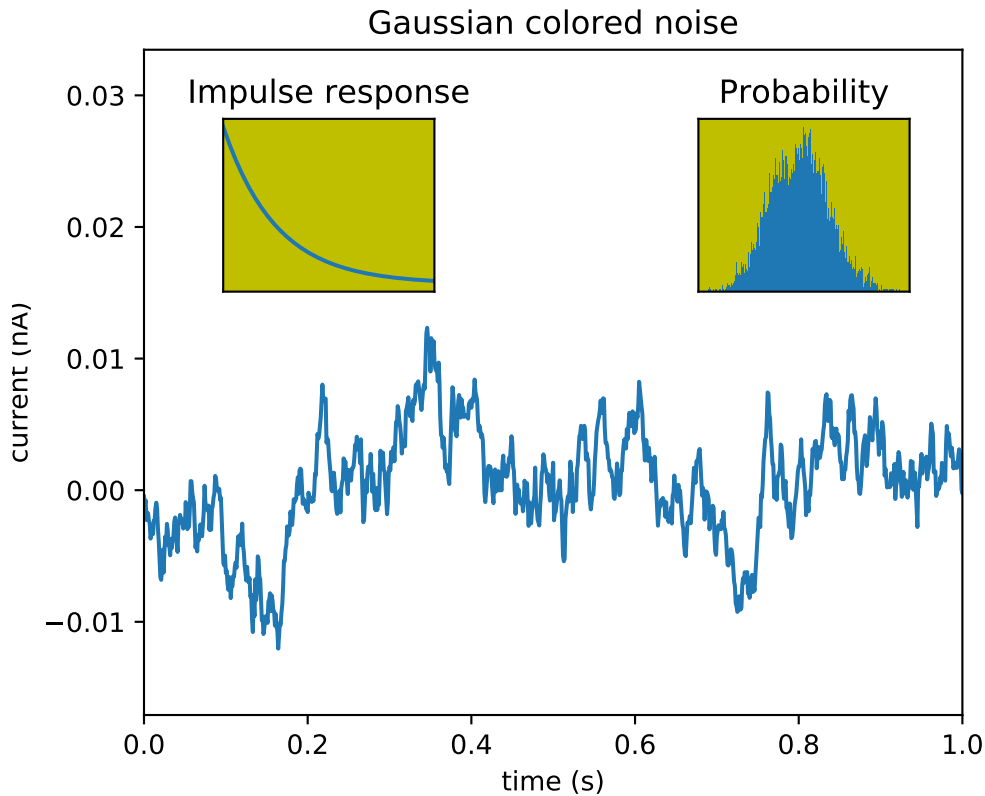

```
import matplotlib.pyplot as plt
import numpy as np

# create some data to use for the plot
dt = 0.001
t = np.arange(0.0, 10.0, dt)
r = np.exp(-t[:1000]/0.05)          # impulse response
x = np.random.randn(len(t))
s = np.convolve(x, r)[:len(x)]*dt # colored noise

# the main axes is subplot(111) by default
plt.plot(t, s)
plt.axis([0, 1, 1.1*np.amin(s), 2*np.amax(s)])
plt.xlabel('time (s)')
plt.ylabel('current (nA)')
plt.title('Gaussian colored noise')

# this is an inset axes over the main axes
a = plt.axes([.65, .6, .2, .2], facecolor='y')
```

```

n, bins, patches = plt.hist(s, 400, normed=1)
plt.title('Probability')
plt.xticks([])
plt.yticks([])

# this is another inset axes over the main axes
a = plt.axes([0.2, 0.6, .2, .2], facecolor='y')
plt.plot(t[:len(r)], r)
plt.title('Impulse response')
plt.xlim(0, 0.2)
plt.xticks([])
plt.yticks([])

plt.show()

```

Keywords: python, matplotlib, pylab, example, codex (see [Search examples](#))

99.16 pylab_examples example code: axes_props.py

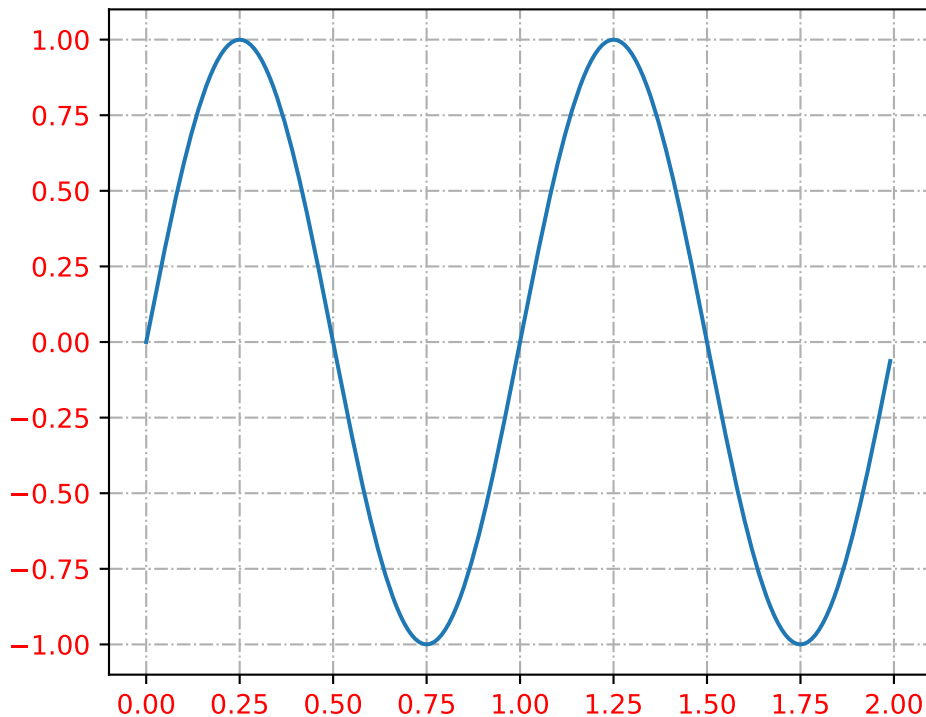

```

"""
You can control the axis tick and grid properties
"""

```

```
import matplotlib.pyplot as plt
import numpy as np

t = np.arange(0.0, 2.0, 0.01)
s = np.sin(2 * np.pi * t)
fig, ax = plt.subplots()
ax.plot(t, s)
ax.grid(True)

ticklines = ax.get_xticklines() + ax.get_yticklines()
gridlines = ax.get_xgridlines() + ax.get_ygridlines()
ticklabels = ax.get_xticklabels() + ax.get_yticklabels()

for line in ticklines:
    line.set_linewidth(3)

for line in gridlines:
    line.set_linestyle('-.')

for label in ticklabels:
    label.set_color('r')
    label.set_fontsize('medium')

plt.show()
```

Keywords: python, matplotlib, pylab, example, codex (see [Search examples](#))

99.17 pylab_examples example code: axes_zoom_effect.py

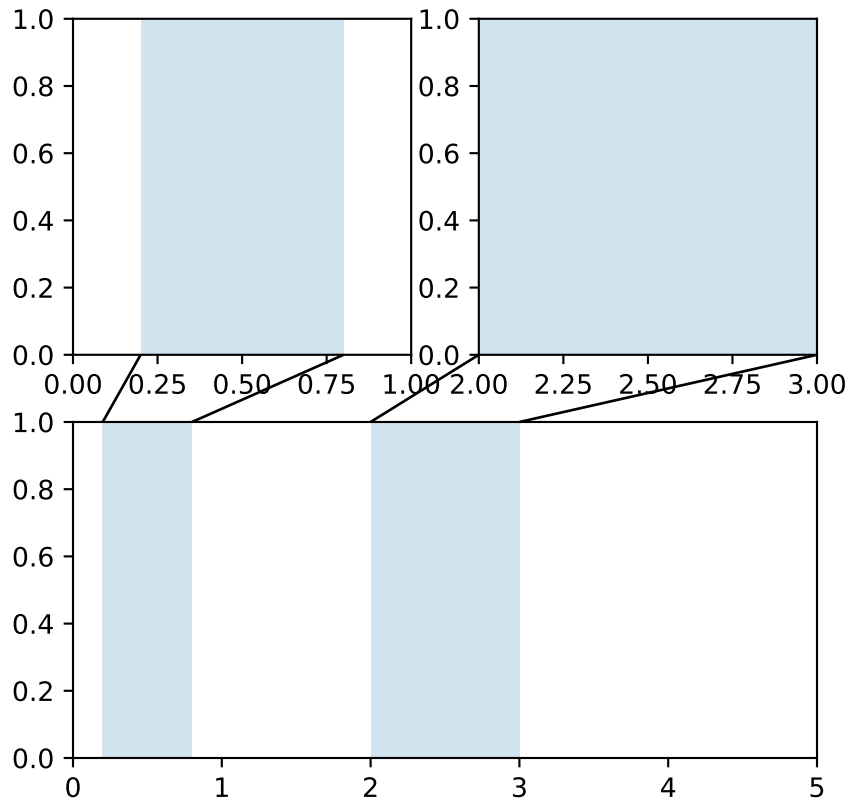

```

from matplotlib.transforms import Bbox, TransformedBbox, \
    blended_transform_factory

from mpl_toolkits.axes_grid1.inset_locator import BboxPatch, BboxConnector,\
    BboxConnectorPatch

def connect_bbox(bbox1, bbox2,
                 loc1a, loc2a, loc1b, loc2b,
                 prop_lines, prop_patches=None):
    if prop_patches is None:
        prop_patches = prop_lines.copy()
        prop_patches["alpha"] = prop_patches.get("alpha", 1)*0.2

    c1 = BboxConnector(bbox1, bbox2, loc1=loc1a, loc2=loc2a, **prop_lines)
    c1.set_clip_on(False)
    c2 = BboxConnector(bbox1, bbox2, loc1=loc1b, loc2=loc2b, **prop_lines)
    c2.set_clip_on(False)

```

```

bbox_patch1 = BboxPatch(bbox1, **prop_patches)
bbox_patch2 = BboxPatch(bbox2, **prop_patches)

p = BboxConnectorPatch(bbox1, bbox2,
                       # loc1a=3, loc2a=2, loc1b=4, loc2b=1,
                       loc1a=loc1a, loc2a=loc2a, loc1b=loc1b, loc2b=loc2b,
                       **prop_patches)
p.set_clip_on(False)

return c1, c2, bbox_patch1, bbox_patch2, p

def zoom_effect01(ax1, ax2, xmin, xmax, **kwargs):
    """
    ax1 : the main axes
    ax2 : the zoomed axes
    (xmin,xmax) : the limits of the colored area in both plot axes.

    connect ax1 & ax2. The x-range of (xmin, xmax) in both axes will
    be marked. The keywords parameters will be used to create
    patches.

    """

    trans1 = blended_transform_factory(ax1.transData, ax1.transAxes)
    trans2 = blended_transform_factory(ax2.transData, ax2.transAxes)

    bbox = Bbox.from_extents(xmin, 0, xmax, 1)

    mybbox1 = TransformedBbox(bbox, trans1)
    mybbox2 = TransformedBbox(bbox, trans2)

    prop_patches = kwargs.copy()
    prop_patches["ec"] = "none"
    prop_patches["alpha"] = 0.2

    c1, c2, bbox_patch1, bbox_patch2, p = \
        connect_bbox(mybbox1, mybbox2,
                    loc1a=3, loc2a=2, loc1b=4, loc2b=1,
                    prop_lines=kwargs, prop_patches=prop_patches)

    ax1.add_patch(bbox_patch1)
    ax2.add_patch(bbox_patch2)
    ax2.add_patch(c1)
    ax2.add_patch(c2)
    ax2.add_patch(p)

    return c1, c2, bbox_patch1, bbox_patch2, p

def zoom_effect02(ax1, ax2, **kwargs):
    """
    ax1 : the main axes

```

```
ax1 : the zoomed axes
```

```
Similar to zoom_effect01. The xmin & xmax will be taken from the
ax1.viewLim.
"""
```

```
tt = ax1.transScale + (ax1.transLimits + ax2.transAxes)
trans = blended_transform_factory(ax2.transData, tt)

mybbox1 = ax1.bbox
mybbox2 = TransformedBbox(ax1.viewLim, trans)

prop_patches = kwargs.copy()
prop_patches["ec"] = "none"
prop_patches["alpha"] = 0.2

c1, c2, bbox_patch1, bbox_patch2, p = \
    connect_bbox(mybbox1, mybbox2,
                 loc1a=3, loc2a=2, loc1b=4, loc2b=1,
                 prop_lines=kwargs, prop_patches=prop_patches)

ax1.add_patch(bbox_patch1)
ax2.add_patch(bbox_patch2)
ax2.add_patch(c1)
ax2.add_patch(c2)
ax2.add_patch(p)

return c1, c2, bbox_patch1, bbox_patch2, p
```

```
import matplotlib.pyplot as plt
```

```
plt.figure(1, figsize=(5, 5))
ax1 = plt.subplot(221)
ax2 = plt.subplot(212)
ax2.set_xlim(0, 1)
ax2.set_xlim(0, 5)
zoom_effect01(ax1, ax2, 0.2, 0.8)
```

```
ax1 = plt.subplot(222)
ax1.set_xlim(2, 3)
ax2.set_xlim(0, 5)
zoom_effect02(ax1, ax2)
```

```
plt.show()
```

Keywords: python, matplotlib, pylab, example, codex (see [Search examples](#))

99.18 pylab_examples example code: axhspan_demo.py

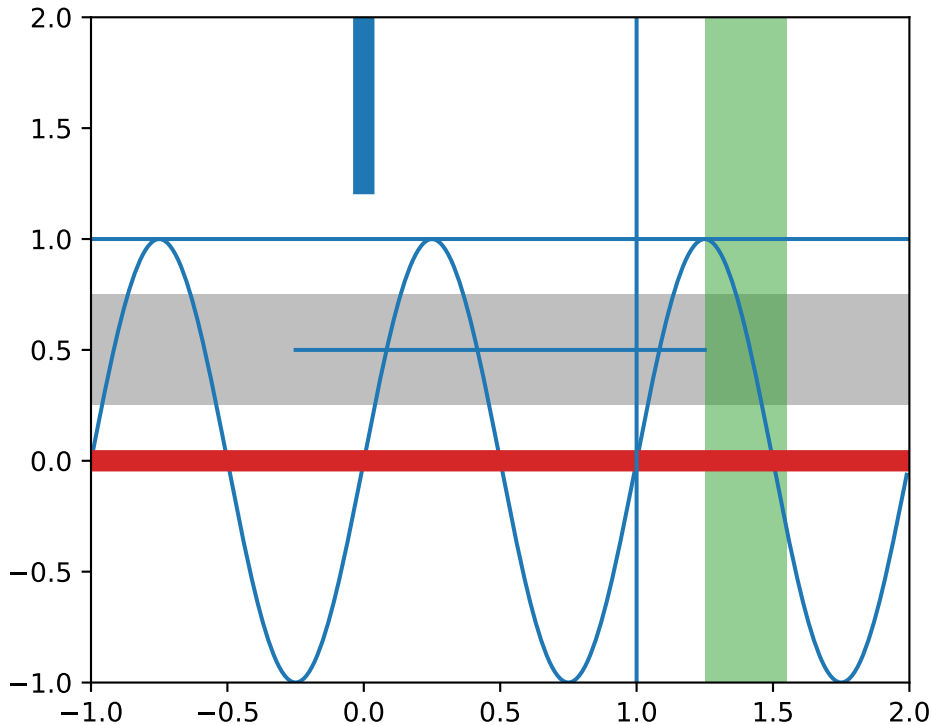

```
import numpy as np
import matplotlib.pyplot as plt

t = np.arange(-1, 2, .01)
s = np.sin(2*np.pi*t)

plt.plot(t, s)
# draw a thick red hline at y=0 that spans the xrange
l = plt.axhline(linewidth=8, color='#d62728')

# draw a default hline at y=1 that spans the xrange
l = plt.axhline(y=1)

# draw a default vline at x=1 that spans the yrange
l = plt.axvline(x=1)

# draw a thick blue vline at x=0 that spans the upper quadrant of
# the yrange
l = plt.axvline(x=0, ymin=0.75, linewidth=8, color='#1f77b4')

# draw a default hline at y=.5 that spans the middle half of
# the axes
```



```

l = plt.axhline(y=.5, xmin=0.25, xmax=0.75)

p = plt.axhspan(0.25, 0.75, facecolor='0.5', alpha=0.5)

p = plt.axvspan(1.25, 1.55, facecolor='#2ca02c', alpha=0.5)

plt.axis([-1, 2, -1, 2])

plt.show()

```

Keywords: python, matplotlib, pylab, example, codex (see [Search examples](#))

99.19 pylab_examples example code: axis_equal_demo.py

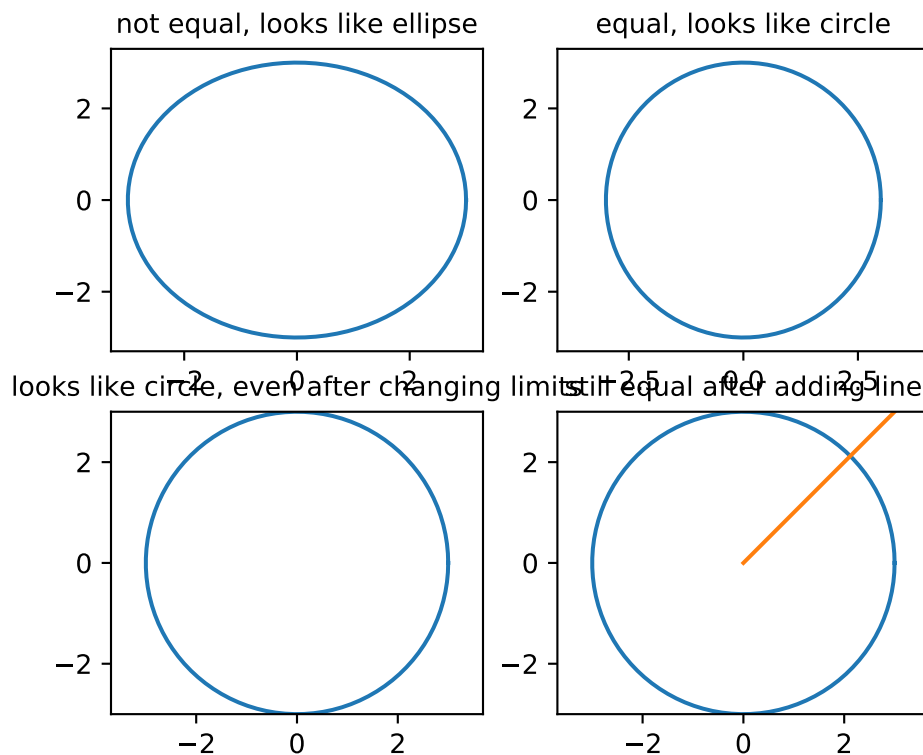

"This example is only interesting when ran in interactive mode"

```

import matplotlib.pyplot as plt
import numpy as np

# Plot circle or radius 3

```

```
an = np.linspace(0, 2*np.pi, 100)

plt.subplot(221)
plt.plot(3*np.cos(an), 3*np.sin(an))
plt.title('not equal, looks like ellipse', fontsize=10)

plt.subplot(222)
plt.plot(3*np.cos(an), 3*np.sin(an))
plt.axis('equal')
plt.title('equal, looks like circle', fontsize=10)

plt.subplot(223)
plt.plot(3*np.cos(an), 3*np.sin(an))
plt.axis('equal')
plt.axis([-3, 3, -3, 3])
plt.title('looks like circle, even after changing limits', fontsize=10)

plt.subplot(224)
plt.plot(3*np.cos(an), 3*np.sin(an))
plt.axis('equal')
plt.axis([-3, 3, -3, 3])
plt.plot([0, 4], [0, 4])
plt.title('still equal after adding line', fontsize=10)

plt.show()
```

Keywords: python, matplotlib, pylab, example, codex (see [Search examples](#))

99.20 pylab_examples example code: bar_stacked.py

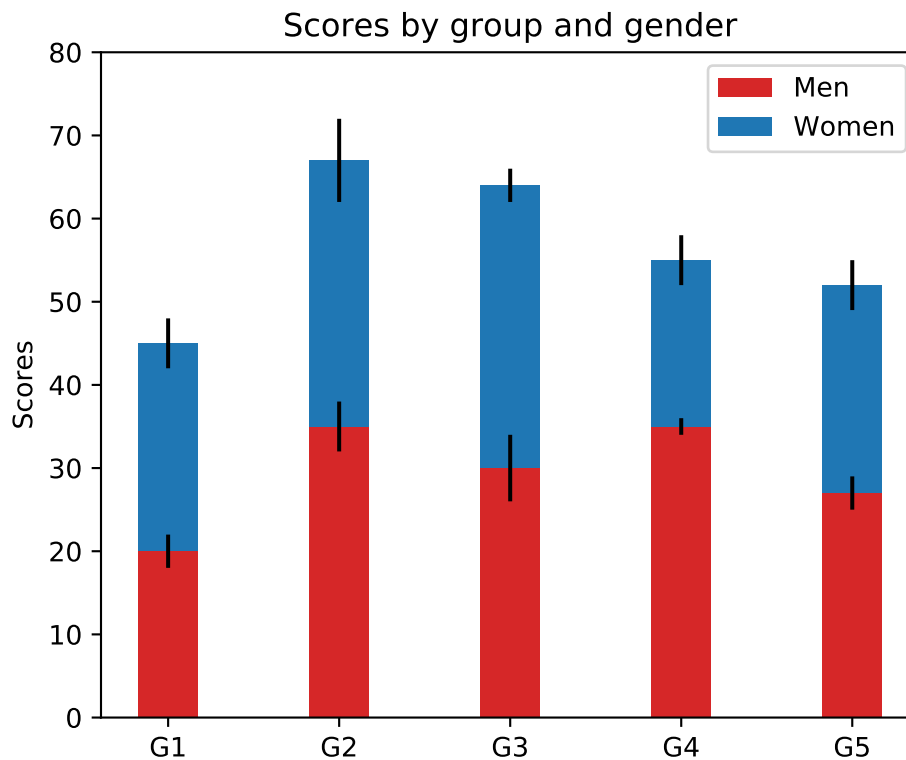

```
# a stacked bar plot with errorbars
import numpy as np
import matplotlib.pyplot as plt

N = 5
menMeans = (20, 35, 30, 35, 27)
womenMeans = (25, 32, 34, 20, 25)
menStd = (2, 3, 4, 1, 2)
womenStd = (3, 5, 2, 3, 3)
ind = np.arange(N) # the x locations for the groups
width = 0.35 # the width of the bars: can also be len(x) sequence

p1 = plt.bar(ind, menMeans, width, color='#d62728', yerr=menStd)
p2 = plt.bar(ind, womenMeans, width,
             bottom=menMeans, yerr=womenStd)

plt.ylabel('Scores')
plt.title('Scores by group and gender')
plt.xticks(ind, ('G1', 'G2', 'G3', 'G4', 'G5'))
plt.yticks(np.arange(0, 81, 10))
plt.legend((p1[0], p2[0]), ('Men', 'Women'))
```

```
plt.show()
```

Keywords: python, matplotlib, pylab, example, codex (see [Search examples](#))

99.21 pylab_examples example code: barb_demo.py

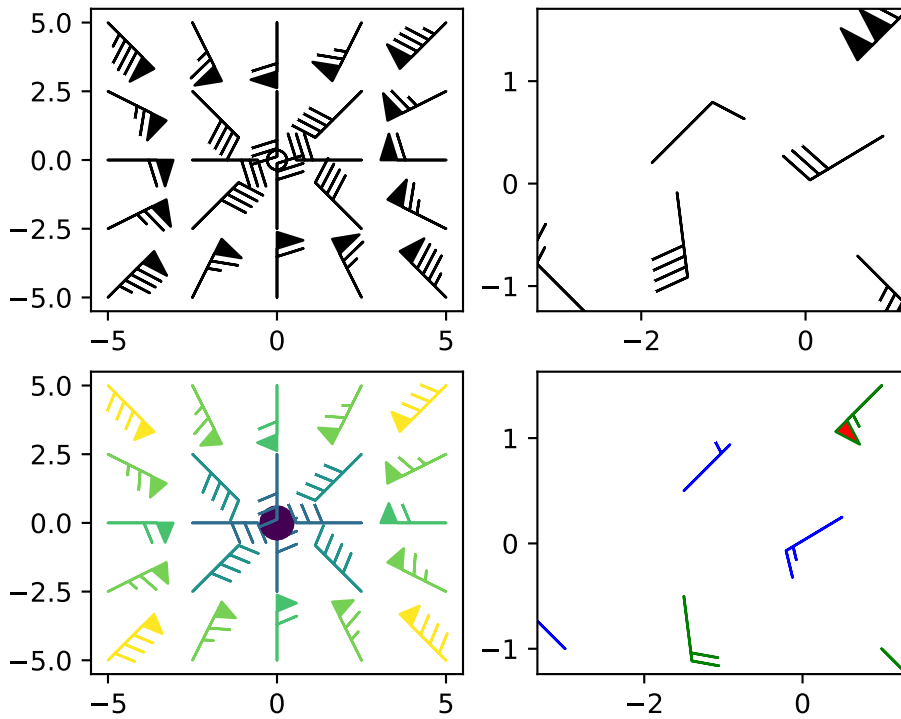

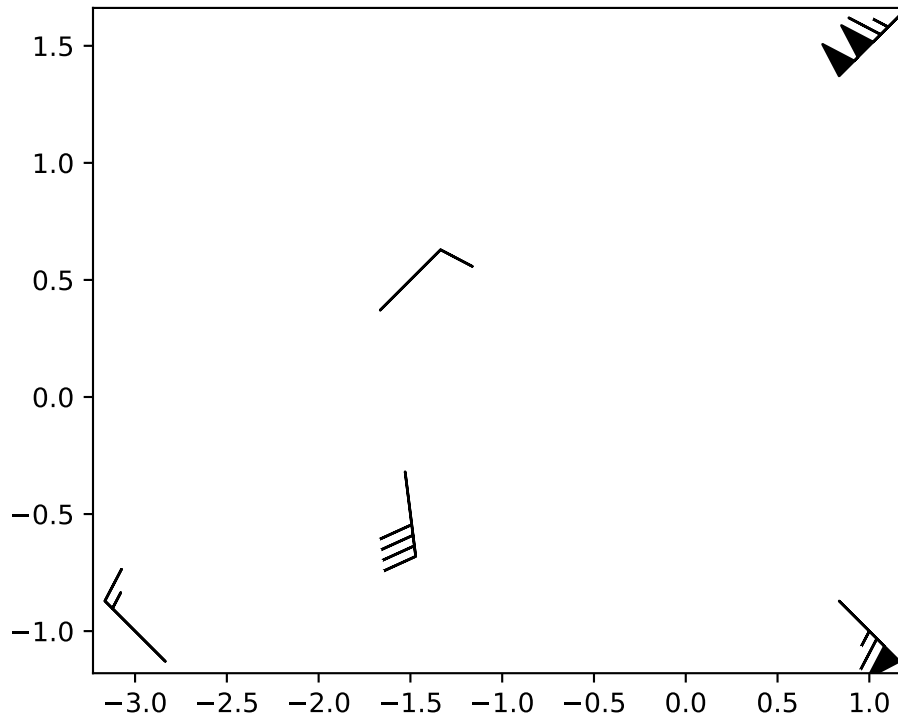

```

"""
Demonstration of wind barb plots
"""
import matplotlib.pyplot as plt
import numpy as np

x = np.linspace(-5, 5, 5)
X, Y = np.meshgrid(x, x)
U, V = 12*X, 12*Y

data = [(-1.5, .5, -6, -6),
        (1, -1, -46, 46),
        (-3, -1, 11, -11),
        (1, 1.5, 80, 80),
        (0.5, 0.25, 25, 15),
        (-1.5, -0.5, -5, 40)]

data = np.array(data, dtype=[('x', np.float32), ('y', np.float32),
                              ('u', np.float32), ('v', np.float32)])

# Default parameters, uniform grid
ax = plt.subplot(2, 2, 1)
ax.barbs(X, Y, U, V)

# Arbitrary set of vectors, make them longer and change the pivot point
#(point around which they're rotated) to be the middle

```

```
ax = plt.subplot(2, 2, 2)
ax.barbs(data['x'], data['y'], data['u'], data['v'], length=8, pivot='middle')

# Showing colormapping with uniform grid. Fill the circle for an empty barb,
# don't round the values, and change some of the size parameters
ax = plt.subplot(2, 2, 3)
ax.barbs(X, Y, U, V, np.sqrt(U*U + V*V), fill_empty=True, rounding=False,
         sizes=dict(emptybarb=0.25, spacing=0.2, height=0.3))

# Change colors as well as the increments for parts of the barbs
ax = plt.subplot(2, 2, 4)
ax.barbs(data['x'], data['y'], data['u'], data['v'], flagcolor='r',
         barbcolor=['b', 'g'], barb_increments=dict(half=10, full=20, flag=100),
         flip_barb=True)

# Masked arrays are also supported
masked_u = np.ma.masked_array(data['u'])
masked_u[4] = 1000 # Bad value that should not be plotted when masked
masked_u[4] = np.ma.masked

# Identical plot to panel 2 in the first figure, but with the point at
#(0.5, 0.25) missing (masked)
fig2 = plt.figure()
ax = fig2.add_subplot(1, 1, 1)
ax.barbs(data['x'], data['y'], masked_u, data['v'], length=8, pivot='middle')

plt.show()
```

Keywords: python, matplotlib, pylab, example, codex (see [Search examples](#))

99.22 pylab_examples example code: barchart_demo.py

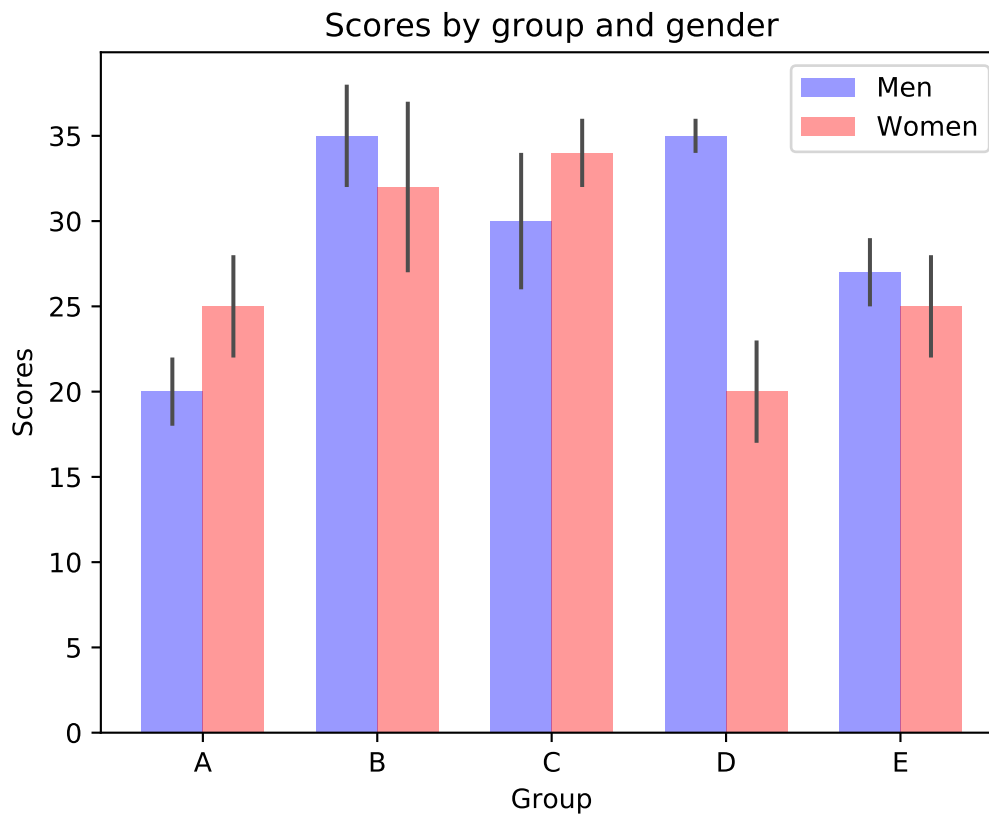

```

"""
Bar chart demo with pairs of bars grouped for easy comparison.
"""
import numpy as np
import matplotlib.pyplot as plt

n_groups = 5

means_men = (20, 35, 30, 35, 27)
std_men = (2, 3, 4, 1, 2)

means_women = (25, 32, 34, 20, 25)
std_women = (3, 5, 2, 3, 3)

fig, ax = plt.subplots()

index = np.arange(n_groups)
bar_width = 0.35

opacity = 0.4
error_config = {'ecolor': '0.3'}

```

```
rects1 = plt.bar(index, means_men, bar_width,
                 alpha=opacity,
                 color='b',
                 yerr=std_men,
                 error_kw=error_config,
                 label='Men')

rects2 = plt.bar(index + bar_width, means_women, bar_width,
                 alpha=opacity,
                 color='r',
                 yerr=std_women,
                 error_kw=error_config,
                 label='Women')

plt.xlabel('Group')
plt.ylabel('Scores')
plt.title('Scores by group and gender')
plt.xticks(index + bar_width / 2, ('A', 'B', 'C', 'D', 'E'))
plt.legend()

plt.tight_layout()
plt.show()
```

Keywords: python, matplotlib, pylab, example, codex (see [Search examples](#))

99.23 pylab_examples example code: barchart_demo2.py

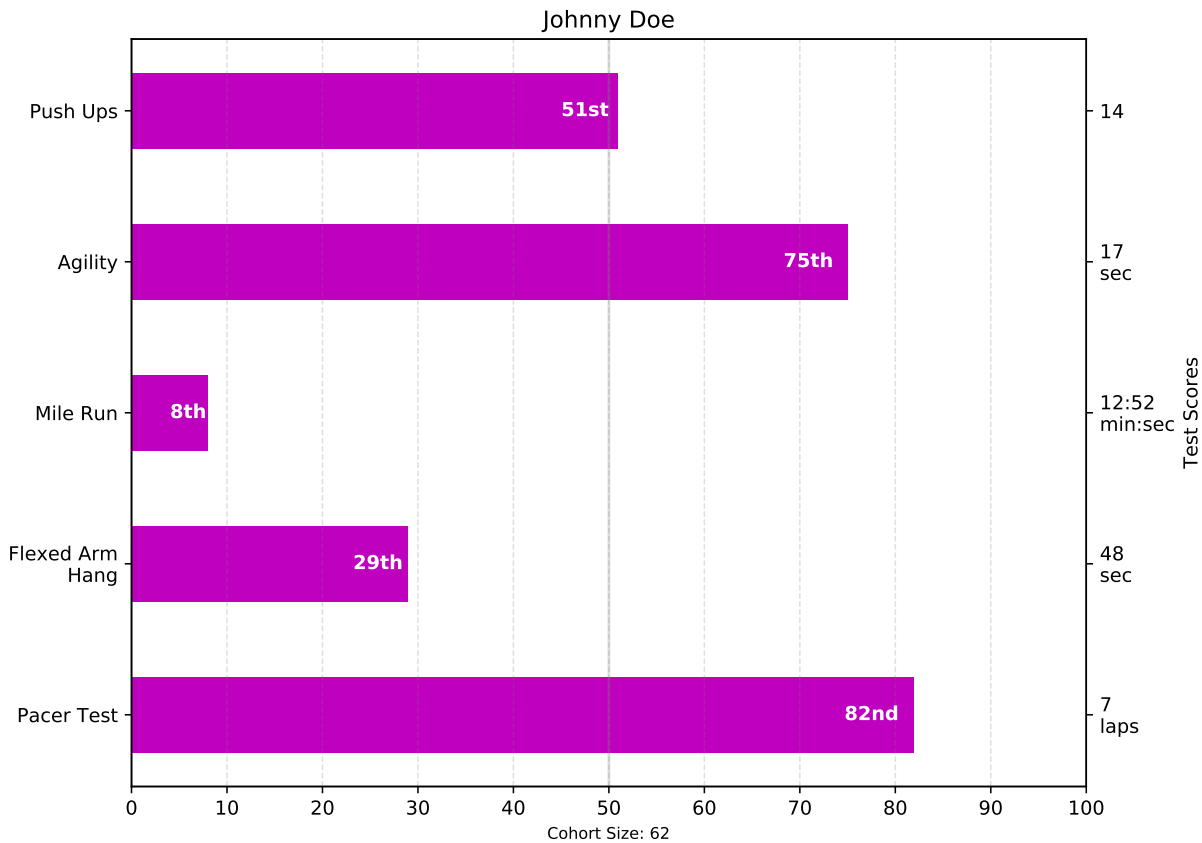

```

"""
Thanks Josh Hemann for the example

This examples comes from an application in which grade school gym
teachers wanted to be able to show parents how their child did across
a handful of fitness tests, and importantly, relative to how other
children did. To extract the plotting code for demo purposes, we'll
just make up some data for little Johnny Doe...

"""
import numpy as np
import matplotlib.pyplot as plt
from matplotlib.ticker import MaxNLocator
from collections import namedtuple

Student = namedtuple('Student', ['name', 'grade', 'gender'])
Score = namedtuple('Score', ['score', 'percentile'])

# GLOBAL CONSTANTS

```

```

testNames = ['Pacer Test', 'Flexed Arm\n Hang', 'Mile Run', 'Agility',
             'Push Ups']
testMeta = dict(zip(testNames, ['laps', 'sec', 'min:sec', 'sec', '']))

def attach_ordinal(num):
    """helper function to add ordinal string to integers

    1 -> 1st
    56 -> 56th
    """
    suffixes = dict((str(i), v) for i, v in
                    enumerate(['th', 'st', 'nd', 'rd', 'th',
                              'th', 'th', 'th', 'th', 'th']))

    v = str(num)
    # special case early teens
    if v in {'11', '12', '13'}:
        return v + 'th'
    return v + suffixes[v[-1]]

def format_score(scr, test):
    """
    Build up the score labels for the right Y-axis by first
    appending a carriage return to each string and then tacking on
    the appropriate meta information (i.e., 'laps' vs 'seconds'). We
    want the labels centered on the ticks, so if there is no meta
    info (like for pushups) then don't add the carriage return to
    the string
    """
    md = testMeta[test]
    if md:
        return '{0}\n{1}'.format(scr, md)
    else:
        return scr

def format_ycursor(y):
    y = int(y)
    if y < 0 or y >= len(testNames):
        return ''
    else:
        return testNames[y]

def plot_student_results(student, scores, cohort_size):
    # create the figure
    fig, ax1 = plt.subplots(figsize=(9, 7))
    fig.subplots_adjust(left=0.115, right=0.88)
    fig.canvas.set_window_title('Eldorado K-8 Fitness Chart')

    pos = np.arange(len(testNames))

```

```

rects = ax1.barh(pos, [scores[k].percentile for k in testNames],
                 align='center',
                 height=0.5, color='m',
                 tick_label=testNames)

ax1.set_title(student.name)

ax1.set_xlim([0, 100])
ax1.xaxis.set_major_locator(MaxNLocator(11))
ax1.xaxis.grid(True, linestyle='--', which='major',
              color='grey', alpha=.25)

# Plot a solid vertical gridline to highlight the median position
ax1.axvline(50, color='grey', alpha=0.25)
# set X-axis tick marks at the deciles
cohort_label = ax1.text(.5, -.07, 'Cohort Size: {0}'.format(cohort_size),
                       horizontalalignment='center', size='small',
                       transform=ax1.transAxes)

# Set the right-hand Y-axis ticks and labels
ax2 = ax1.twinx()

scoreLabels = [format_score(scores[k].score, k) for k in testNames]

# set the tick locations
ax2.set_yticks(pos)
# make sure that the limits are set equally on both yaxis so the
# ticks line up
ax2.set_ylim(ax1.get_ylim())

# set the tick labels
ax2.set_yticklabels(scoreLabels)

ax2.set_ylabel('Test Scores')

ax2.set_xlabel(('Percentile Ranking Across '
               '{grade} Grade {gender}s').format(
               grade=attach_ordinal(student.grade),
               gender=student.gender.title()))

rect_labels = []
# Lastly, write in the ranking inside each bar to aid in interpretation
for rect in rects:
    # Rectangle widths are already integer-valued but are floating
    # type, so it helps to remove the trailing decimal point and 0 by
    # converting width to int type
    width = int(rect.get_width())

    rankStr = attach_ordinal(width)
    # The bars aren't wide enough to print the ranking inside
    if (width < 5):
        # Shift the text to the right side of the right edge

```

```

        xloc = width + 1
        # Black against white background
        clr = 'black'
        align = 'left'
    else:
        # Shift the text to the left side of the right edge
        xloc = 0.98*width
        # White on magenta
        clr = 'white'
        align = 'right'

    # Center the text vertically in the bar
    yloc = rect.get_y() + rect.get_height()/2.0
    label = ax1.text(xloc, yloc, rankStr, horizontalalignment=align,
                    verticalalignment='center', color=clr, weight='bold',
                    clip_on=True)
    rect_labels.append(label)

# make the interactive mouse over give the bar title
ax2.format_ydata = format_ycursor
# return all of the artists created
return {'fig': fig,
        'ax': ax1,
        'ax_right': ax2,
        'bars': rects,
        'perc_labels': rect_labels,
        'cohort_label': cohort_label}

student = Student('Johnny Doe', 2, 'boy')
scores = dict(zip(testNames,
                 (Score(v, p) for v, p in
                  zip(['7', '48', '12:52', '17', '14'],
                      np.round(np.random.uniform(0, 1,
                                                  len(testNames))*100, 0))))))
cohort_size = 62 # The number of other 2nd grade boys

arts = plot_student_results(student, scores, cohort_size)
plt.show()

```

Keywords: python, matplotlib, pylab, example, codex (see [Search examples](#))

99.24 pylab_examples example code: barcode_demo.py

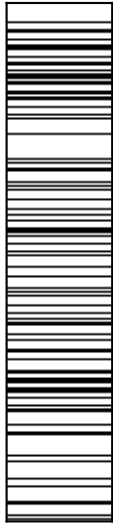

```
import matplotlib.pyplot as plt
import numpy as np

# the bar
x = np.where(np.random.rand(500) > 0.7, 1.0, 0.0)

axprops = dict(xticks=[], yticks=[])
barprops = dict(aspect='auto', cmap=plt.cm.binary, interpolation='nearest')

fig = plt.figure()

# a vertical barcode -- this is broken at present
x.shape = len(x), 1
ax = fig.add_axes([0.1, 0.3, 0.1, 0.6], **axprops)
ax.imshow(x, **barprops)

x = x.copy()
# a horizontal barcode
x.shape = 1, len(x)
ax = fig.add_axes([0.3, 0.1, 0.6, 0.1], **axprops)
ax.imshow(x, **barprops)
```

```
plt.show()
```

Keywords: python, matplotlib, pylab, example, codex (see [Search examples](#))

99.25 pylab_examples example code: boxplot_demo.py

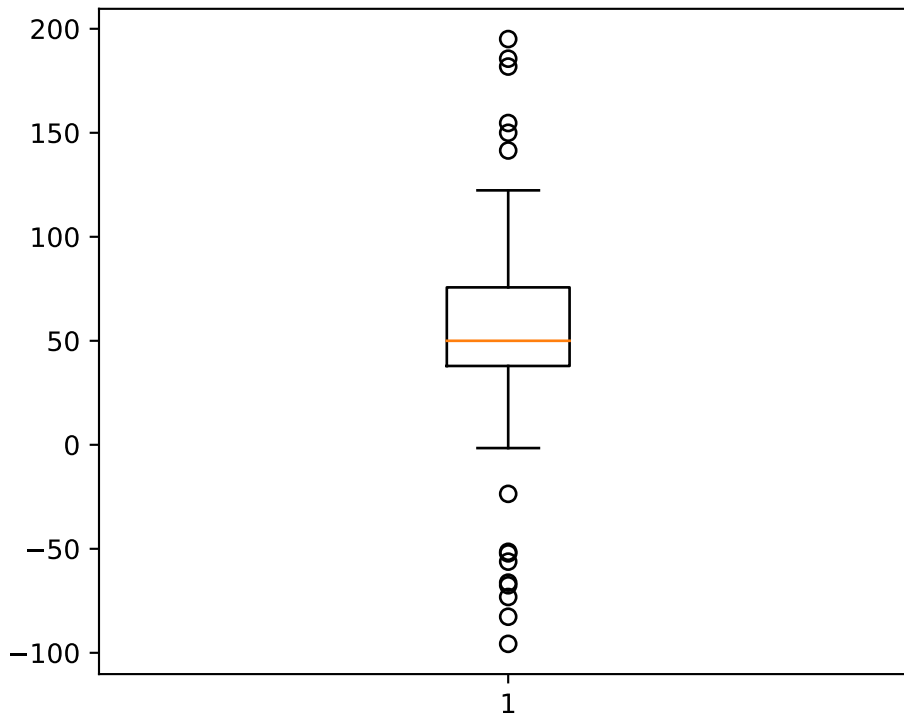

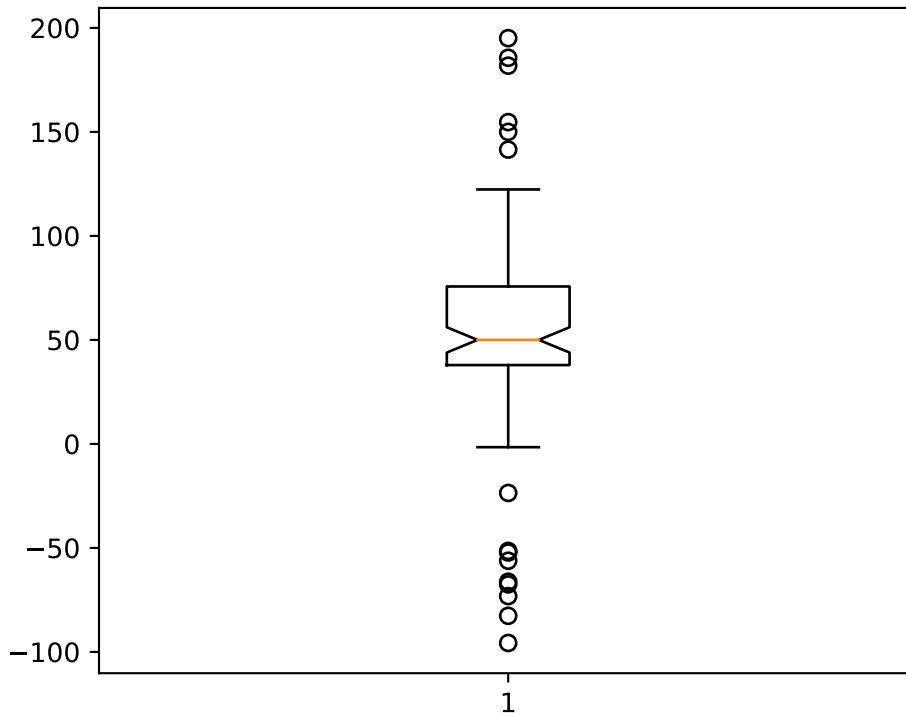

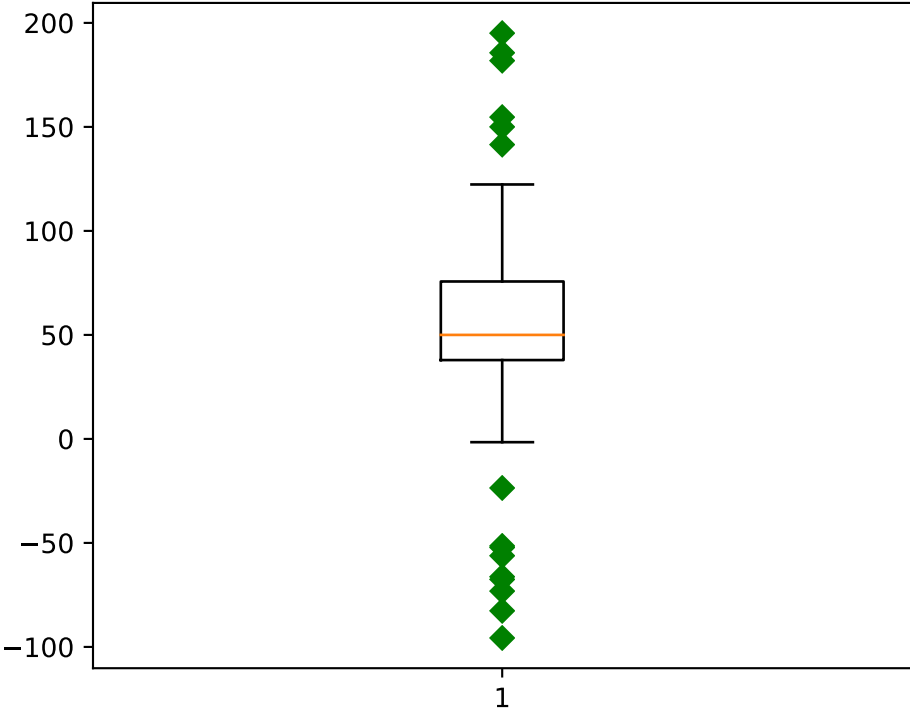

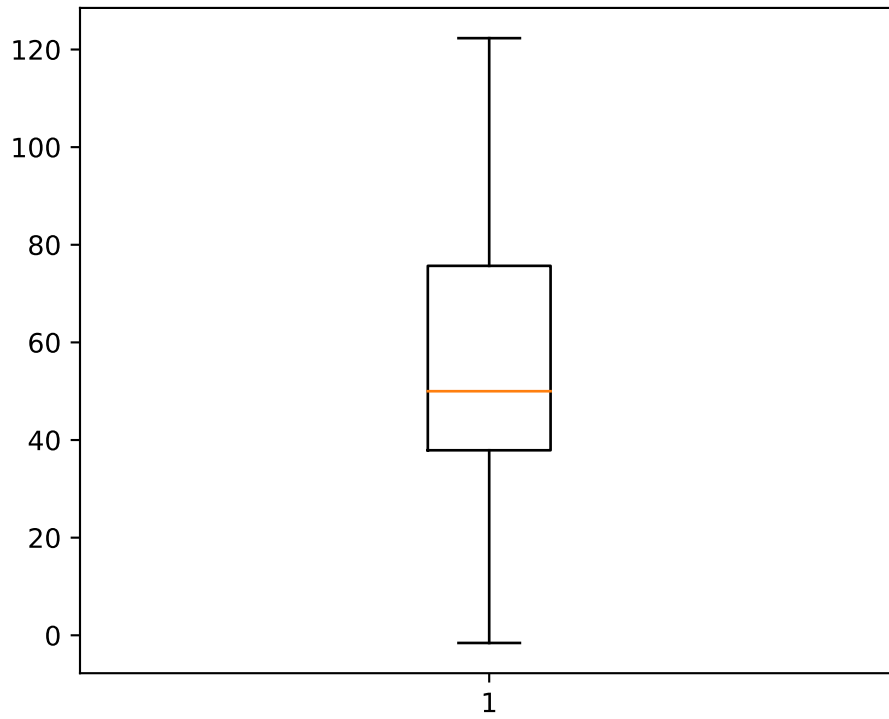

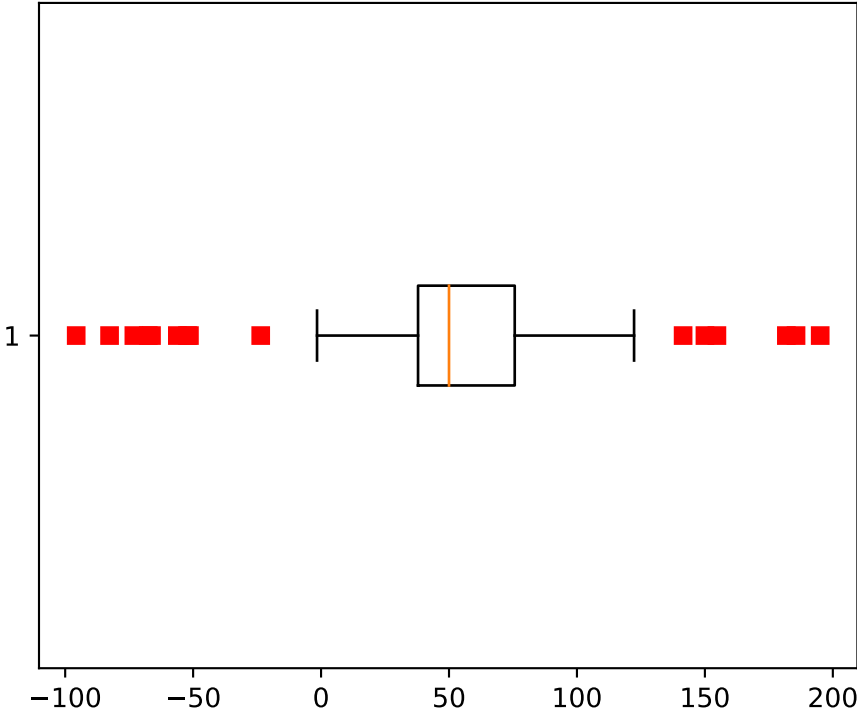

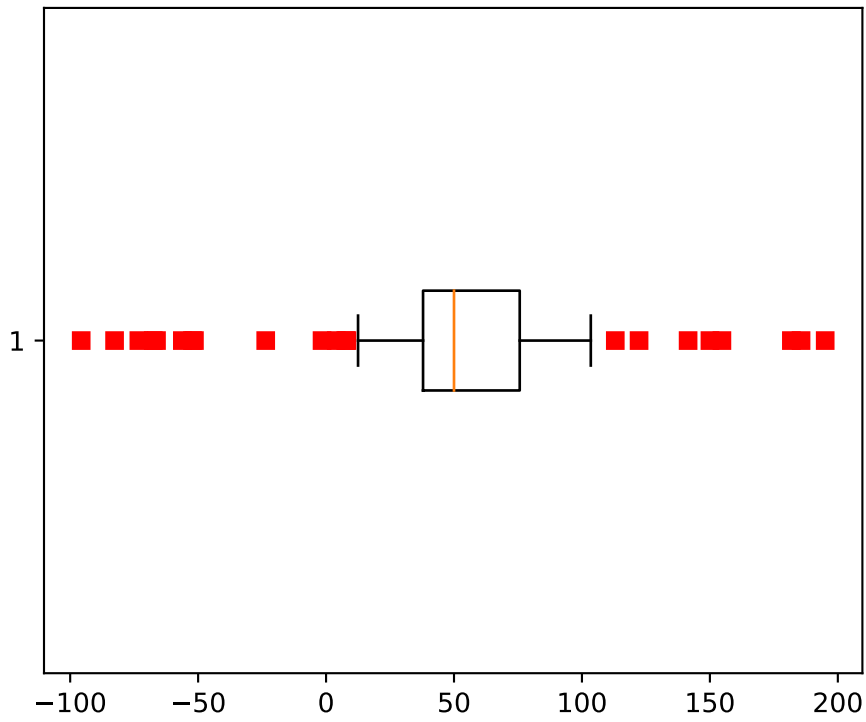

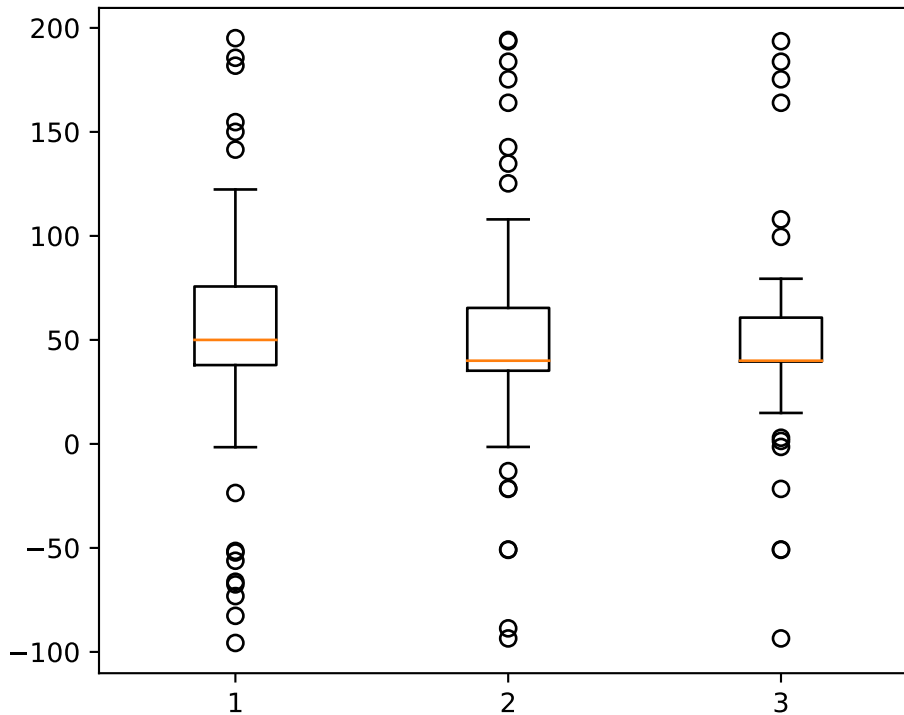

```

import matplotlib.pyplot as plt
import numpy as np

# fake up some data
spread = np.random.rand(50) * 100
center = np.ones(25) * 50
flier_high = np.random.rand(10) * 100 + 100
flier_low = np.random.rand(10) * -100
data = np.concatenate((spread, center, flier_high, flier_low), 0)

# basic plot
plt.boxplot(data)

# notched plot
plt.figure()
plt.boxplot(data, 1)

# change outlier point symbols
plt.figure()
plt.boxplot(data, 0, 'gD')

# don't show outlier points
plt.figure()
plt.boxplot(data, 0, '')

# horizontal boxes

```

```
plt.figure()
plt.boxplot(data, 0, 'rs', 0)

# change whisker length
plt.figure()
plt.boxplot(data, 0, 'rs', 0, 0.75)

# fake up some more data
spread = np.random.rand(50) * 100
center = np.ones(25) * 40
flier_high = np.random.rand(10) * 100 + 100
flier_low = np.random.rand(10) * -100
d2 = np.concatenate((spread, center, flier_high, flier_low), 0)
data.shape = (-1, 1)
d2.shape = (-1, 1)
# data = concatenate( (data, d2), 1 )
# Making a 2-D array only works if all the columns are the
# same length. If they are not, then use a list instead.
# This is actually more efficient because boxplot converts
# a 2-D array into a list of vectors internally anyway.
data = [data, d2, d2[:, :2, 0]]
# multiple box plots on one figure
plt.figure()
plt.boxplot(data)

plt.show()
```

Keywords: python, matplotlib, pylab, example, codex (see [Search examples](#))

99.26 pylab_examples example code: boxplot_demo2.py

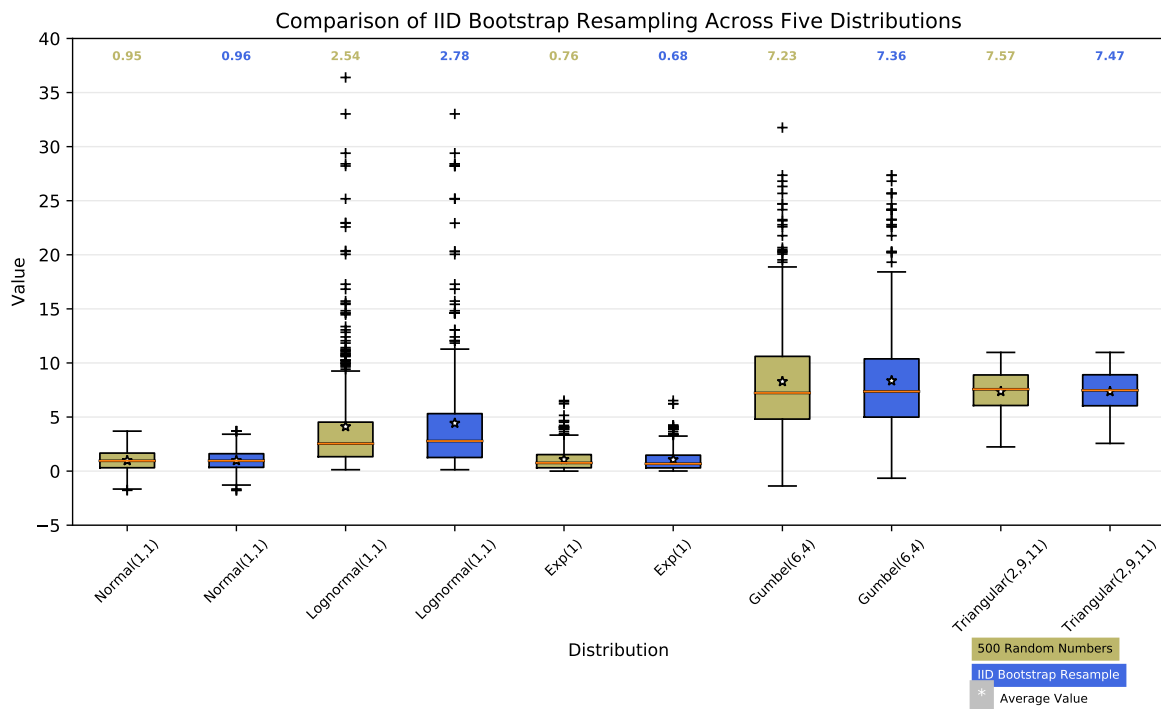

```

"""
Thanks Josh Hemann for the example
"""

import numpy as np
import matplotlib.pyplot as plt
from matplotlib.patches import Polygon

# Generate some data from five different probability distributions,
# each with different characteristics. We want to play with how an IID
# bootstrap resample of the data preserves the distributional
# properties of the original sample, and a boxplot is one visual tool
# to make this assessment
numDists = 5
randomDists = ['Normal(1,1)', 'Lognormal(1,1)', 'Exp(1)', 'Gumbel(6,4)',
               'Triangular(2,9,11)']

N = 500
np.random.seed(0)
norm = np.random.normal(1, 1, N)
logn = np.random.lognormal(1, 1, N)
expo = np.random.exponential(1, N)
gumb = np.random.gumbel(6, 4, N)
tria = np.random.triangular(2, 9, 11, N)

# Generate some random indices that we'll use to resample the original data

```

```

# arrays. For code brevity, just use the same random indices for each array
bootstrapIndices = np.random.random_integers(0, N - 1, N)
normBoot = norm[bootstrapIndices]
expoBoot = expo[bootstrapIndices]
gumbBoot = gumb[bootstrapIndices]
lognBoot = logn[bootstrapIndices]
triaBoot = tria[bootstrapIndices]

data = [norm, normBoot, logn, lognBoot, expo, expoBoot, gumb, gumbBoot,
        tria, triaBoot]

fig, ax1 = plt.subplots(figsize=(10, 6))
fig.canvas.set_window_title('A Boxplot Example')
plt.subplots_adjust(left=0.075, right=0.95, top=0.9, bottom=0.25)

bp = plt.boxplot(data, notch=0, sym='+', vert=1, whis=1.5)
plt.setp(bp['boxes'], color='black')
plt.setp(bp['whiskers'], color='black')
plt.setp(bp['fliers'], color='red', marker='+')

# Add a horizontal grid to the plot, but make it very light in color
# so we can use it for reading data values but not be distracting
ax1.yaxis.grid(True, linestyle='-', which='major', color='lightgrey',
              alpha=0.5)

# Hide these grid behind plot objects
ax1.set_axisbelow(True)
ax1.set_title('Comparison of IID Bootstrap Resampling Across Five Distributions')
ax1.set_xlabel('Distribution')
ax1.set_ylabel('Value')

# Now fill the boxes with desired colors
boxColors = ['darkkhaki', 'royalblue']
numBoxes = numDists*2
medians = list(range(numBoxes))
for i in range(numBoxes):
    box = bp['boxes'][i]
    boxX = []
    boxY = []
    for j in range(5):
        boxX.append(box.get_xdata()[j])
        boxY.append(box.get_ydata()[j])
    boxCoords = list(zip(boxX, boxY))
    # Alternate between Dark Khaki and Royal Blue
    k = i % 2
    boxPolygon = Polygon(boxCoords, facecolor=boxColors[k])
    ax1.add_patch(boxPolygon)
    # Now draw the median lines back over what we just filled in
    med = bp['medians'][i]
    medianX = []
    medianY = []
    for j in range(2):
        medianX.append(med.get_xdata()[j])

```

```

        medianY.append(med.get_ydata()[j])
        plt.plot(medianX, medianY, 'k')
        medians[i] = medianY[0]
    # Finally, overplot the sample averages, with horizontal alignment
    # in the center of each box
    plt.plot([np.average(med.get_xdata())], [np.average(data[i])],
             color='w', marker='*', markeredgcolor='k')

# Set the axes ranges and axes labels
ax1.set_xlim(0.5, numBoxes + 0.5)
top = 40
bottom = -5
ax1.set_ylim(bottom, top)
xtickNames = plt.setp(ax1, xticklabels=np.repeat(randomDists, 2))
plt.setp(xtickNames, rotation=45, fontsize=8)

# Due to the Y-axis scale being different across samples, it can be
# hard to compare differences in medians across the samples. Add upper
# X-axis tick labels with the sample medians to aid in comparison
# (just use two decimal places of precision)
pos = np.arange(numBoxes) + 1
upperLabels = [str(np.round(s, 2)) for s in medians]
weights = ['bold', 'semibold']
for tick, label in zip(range(numBoxes), ax1.get_xticklabels()):
    k = tick % 2
    ax1.text(pos[tick], top - (top*0.05), upperLabels[tick],
            horizontalalignment='center', size='x-small', weight=weights[k],
            color=boxColors[k])

# Finally, add a basic legend
plt.figtext(0.80, 0.08, str(N) + ' Random Numbers',
           backgroundcolor=boxColors[0], color='black', weight='roman',
           size='x-small')
plt.figtext(0.80, 0.045, 'IID Bootstrap Resample',
           backgroundcolor=boxColors[1],
           color='white', weight='roman', size='x-small')
plt.figtext(0.80, 0.015, '*', color='white', backgroundcolor='silver',
           weight='roman', size='medium')
plt.figtext(0.815, 0.013, ' Average Value', color='black', weight='roman',
           size='x-small')

plt.show()

```

Keywords: python, matplotlib, pylab, example, codex (see [Search examples](#))

99.27 pylab_examples example code: boxplot_demo3.py

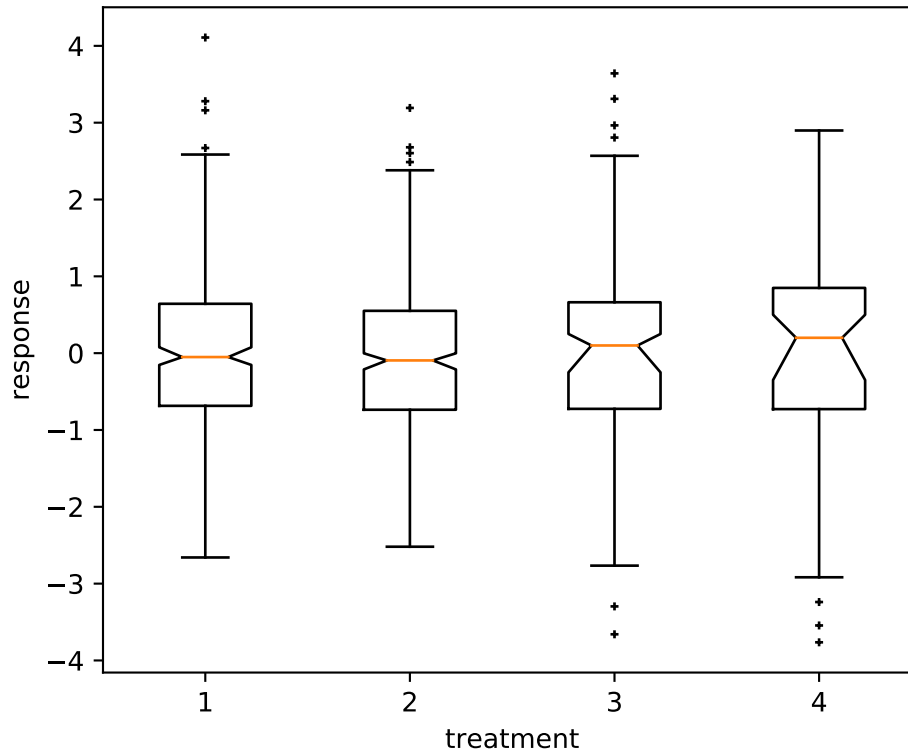

```
import matplotlib.pyplot as plt
import numpy as np

def fakeBootStrapper(n):
    """
    This is just a placeholder for the user's method of
    bootstrapping the median and its confidence intervals.

    Returns an arbitrary median and confidence intervals
    packed into a tuple
    """
    if n == 1:
        med = 0.1
        CI = (-0.25, 0.25)
    else:
        med = 0.2
        CI = (-0.35, 0.50)

    return med, CI
```

```
np.random.seed(2)
inc = 0.1
e1 = np.random.normal(0, 1, size=(500,))
e2 = np.random.normal(0, 1, size=(500,))
e3 = np.random.normal(0, 1 + inc, size=(500,))
e4 = np.random.normal(0, 1 + 2*inc, size=(500,))

treatments = [e1, e2, e3, e4]
med1, CI1 = fakeBootStrapper(1)
med2, CI2 = fakeBootStrapper(2)
medians = [None, None, med1, med2]
conf_intervals = [None, None, CI1, CI2]

fig, ax = plt.subplots()
pos = np.array(range(len(treatments))) + 1
bp = ax.boxplot(treatments, sym='k+', positions=pos,
               notch=1, bootstrap=5000,
               usermedians=medians,
               conf_intervals=conf_intervals)

ax.set_xlabel('treatment')
ax.set_ylabel('response')
plt.setp(bp['whiskers'], color='k', linestyle='-')
plt.setp(bp['fliers'], markersize=3.0)
plt.show()
```

Keywords: python, matplotlib, pylab, example, codex (see [Search examples](#))

99.28 pylab_examples example code: broken_axis.py

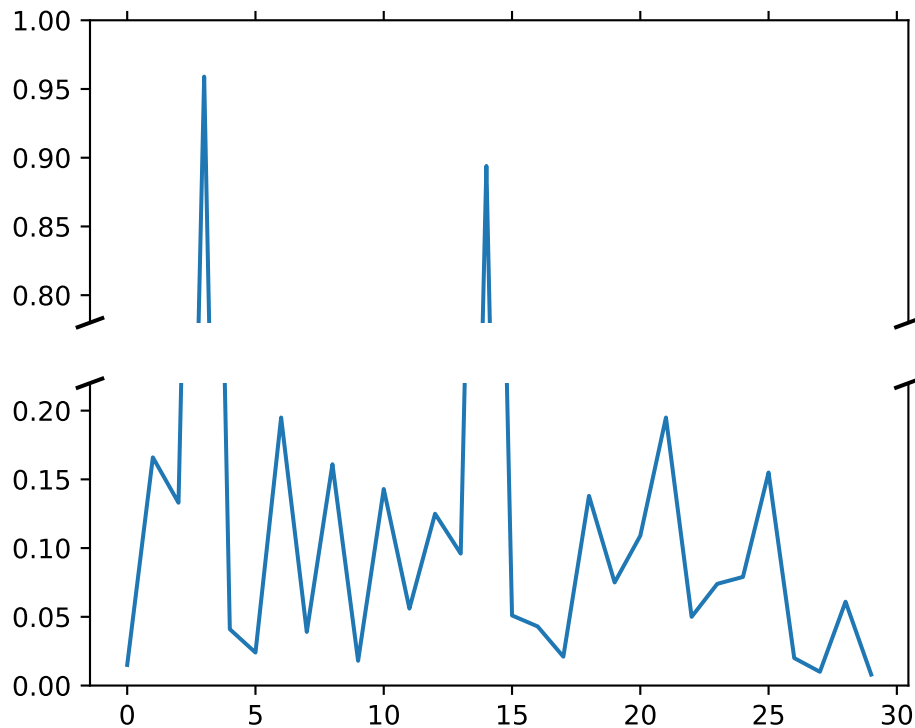

```

"""
Broken axis example, where the y-axis will have a portion cut out.
"""
import matplotlib.pyplot as plt
import numpy as np

# 30 points between [0, 0.2) originally made using np.random.rand(30)*.2
pts = np.array([
    0.015, 0.166, 0.133, 0.159, 0.041, 0.024, 0.195, 0.039, 0.161, 0.018,
    0.143, 0.056, 0.125, 0.096, 0.094, 0.051, 0.043, 0.021, 0.138, 0.075,
    0.109, 0.195, 0.050, 0.074, 0.079, 0.155, 0.020, 0.010, 0.061, 0.008])

# Now let's make two outlier points which are far away from everything.
pts[[3, 14]] += .8

# If we were to simply plot pts, we'd lose most of the interesting
# details due to the outliers. So let's 'break' or 'cut-out' the y-axis
# into two portions - use the top (ax) for the outliers, and the bottom
# (ax2) for the details of the majority of our data
f, (ax, ax2) = plt.subplots(2, 1, sharex=True)

```

```
# plot the same data on both axes
ax.plot(pts)
ax2.plot(pts)

# zoom-in / limit the view to different portions of the data
ax.set_ylim(.78, 1.) # outliers only
ax2.set_ylim(0, .22) # most of the data

# hide the spines between ax and ax2
ax.spines['bottom'].set_visible(False)
ax2.spines['top'].set_visible(False)
ax.xaxis.tick_top()
ax.tick_params(labeltop='off') # don't put tick labels at the top
ax2.xaxis.tick_bottom()

# This looks pretty good, and was fairly painless, but you can get that
# cut-out diagonal lines look with just a bit more work. The important
# thing to know here is that in axes coordinates, which are always
# between 0-1, spine endpoints are at these locations (0,0), (0,1),
# (1,0), and (1,1). Thus, we just need to put the diagonals in the
# appropriate corners of each of our axes, and so long as we use the
# right transform and disable clipping.

d = .015 # how big to make the diagonal lines in axes coordinates
# arguments to pass to plot, just so we don't keep repeating them
kwargs = dict(transform=ax.transAxes, color='k', clip_on=False)
ax.plot((-d, +d), (-d, +d), **kwargs) # top-left diagonal
ax.plot((1 - d, 1 + d), (-d, +d), **kwargs) # top-right diagonal

kwargs.update(transform=ax2.transAxes) # switch to the bottom axes
ax2.plot((-d, +d), (1 - d, 1 + d), **kwargs) # bottom-left diagonal
ax2.plot((1 - d, 1 + d), (1 - d, 1 + d), **kwargs) # bottom-right diagonal

# What's cool about this is that now if we vary the distance between
# ax and ax2 via f.subplots_adjust(hspace=...) or plt.subplot_tool(),
# the diagonal lines will move accordingly, and stay right at the tips
# of the spines they are 'breaking'

plt.show()
```

Keywords: python, matplotlib, pylab, example, codex (see [Search examples](#))

99.29 pylab_examples example code: broken_barh.py

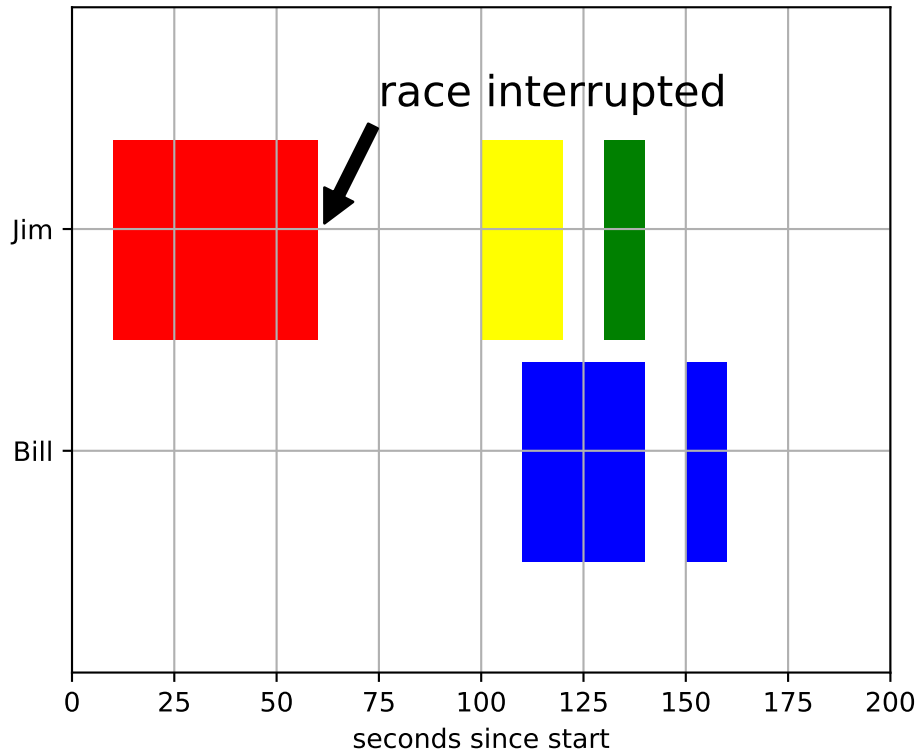

```

"""
Make a "broken" horizontal bar plot, i.e., one with gaps
"""
import matplotlib.pyplot as plt

fig, ax = plt.subplots()
ax.broken_barh([(110, 30), (150, 10)], (10, 9), facecolors='blue')
ax.broken_barh([(10, 50), (100, 20), (130, 10)], (20, 9),
               facecolors=('red', 'yellow', 'green'))
ax.set_ylim(5, 35)
ax.set_xlim(0, 200)
ax.set_xlabel('seconds since start')
ax.set_yticks([15, 25])
ax.set_yticklabels(['Bill', 'Jim'])
ax.grid(True)
ax.annotate('race interrupted', (61, 25),
           xytext=(0.8, 0.9), textcoords='axes fraction',
           arrowprops=dict(facecolor='black', shrink=0.05),
           fontsize=16,
           horizontalalignment='right', verticalalignment='top')

plt.show()

```

Keywords: python, matplotlib, pylab, example, codex (see *Search examples*)

99.30 pylab_examples example code: centered_ticklabels.py

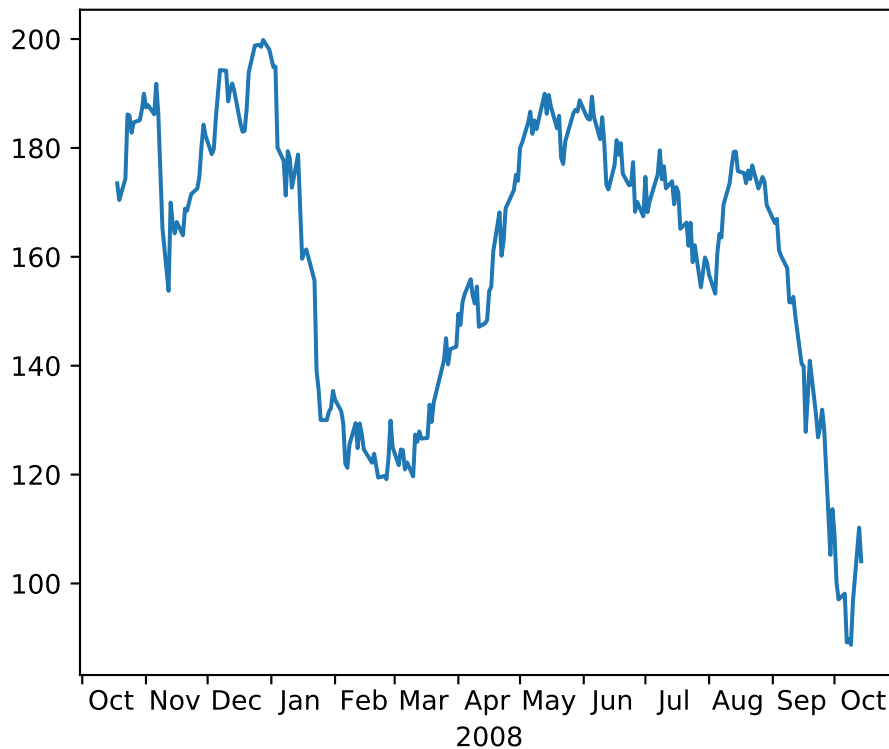

```
# sometimes it is nice to have ticklabels centered.  mpl currently
# associates a label with a tick, and the label can be aligned
# 'center', 'left', or 'right' using the horizontal alignment property:
#
#
#   for label in ax.xaxis.get_xticklabels():
#       label.set_horizontalalignment('right')
#
#
# but this doesn't help center the label between ticks.  One solution
# is to "face it".  Use the minor ticks to place a tick centered
# between the major ticks.  Here is an example that labels the months,
# centered between the ticks

import numpy as np
import matplotlib.cbook as cbook
import matplotlib.dates as dates
import matplotlib.ticker as ticker
import matplotlib.pyplot as plt
```

```
# load some financial data; apple's stock price
fh = cbook.get_sample_data('aapl.npy.gz')
try:
    # Python3 cannot load python2 .npy files with datetime(object) arrays
    # unless the encoding is set to bytes. However this option was
    # not added until numpy 1.10 so this example will only work with
    # python 2 or with numpy 1.10 and later.
    r = np.load(fh, encoding='bytes')
except TypeError:
    r = np.load(fh)
fh.close()
r = r[-250:] # get the last 250 days

fig, ax = plt.subplots()
ax.plot(r.date, r.adj_close)

ax.xaxis.set_major_locator(dates.MonthLocator())
ax.xaxis.set_minor_locator(dates.MonthLocator(bymonthday=15))

ax.xaxis.set_major_formatter(ticker.NullFormatter())
ax.xaxis.set_minor_formatter(dates.DateFormatter('%b'))

for tick in ax.xaxis.get_minor_ticks():
    tick.tick1line.set_markersize(0)
    tick.tick2line.set_markersize(0)
    tick.label1.set_horizontalalignment('center')

imid = len(r)//2
ax.set_xlabel(str(r.date[imid].year))
plt.show()
```

Keywords: python, matplotlib, pylab, example, codex (see [Search examples](#))

99.31 pylab_examples example code: cohere_demo.py

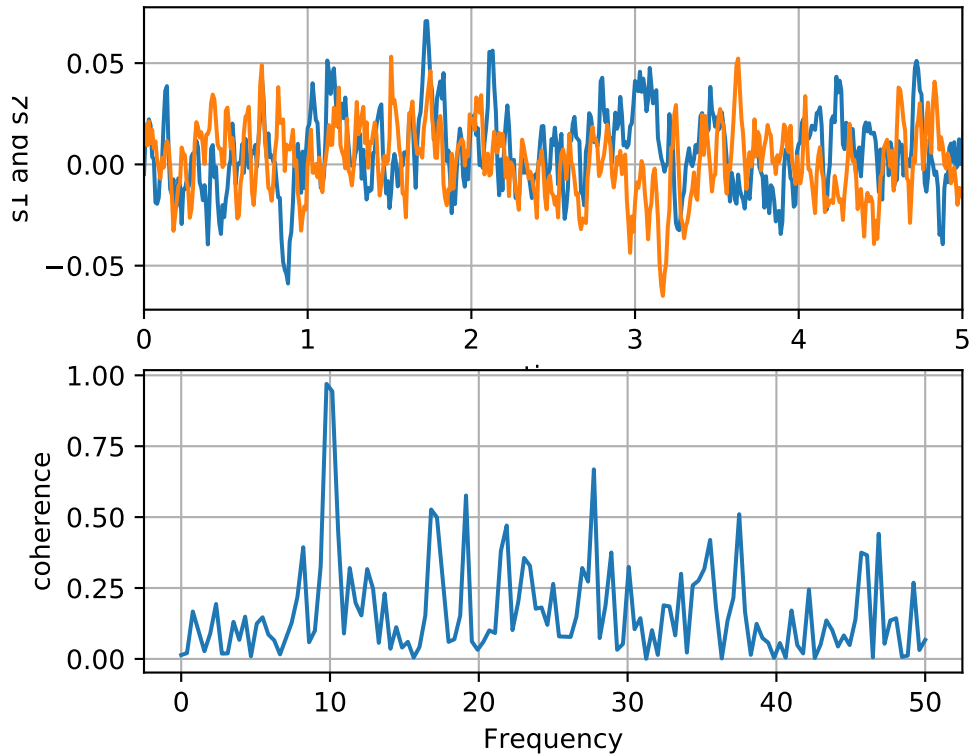

```

"""
Compute the coherence of two signals
"""
import numpy as np
import matplotlib.pyplot as plt

# make a little extra space between the subplots
plt.subplots_adjust(wspace=0.5)

dt = 0.01
t = np.arange(0, 30, dt)
nse1 = np.random.randn(len(t))           # white noise 1
nse2 = np.random.randn(len(t))           # white noise 2
r = np.exp(-t/0.05)

cnse1 = np.convolve(nse1, r, mode='same')*dt # colored noise 1
cnse2 = np.convolve(nse2, r, mode='same')*dt # colored noise 2

# two signals with a coherent part and a random part
s1 = 0.01*np.sin(2*np.pi*10*t) + cnse1
s2 = 0.01*np.sin(2*np.pi*10*t) + cnse2

```



```

plt.subplot(211)
plt.plot(t, s1, t, s2)
plt.xlim(0, 5)
plt.xlabel('time')
plt.ylabel('s1 and s2')
plt.grid(True)

plt.subplot(212)
cxy, f = plt.cohere(s1, s2, 256, 1./dt)
plt.ylabel('coherence')
plt.show()

```

Keywords: python, matplotlib, pylab, example, codex (see [Search examples](#))

99.32 pylab_examples example code: color_by_yvalue.py

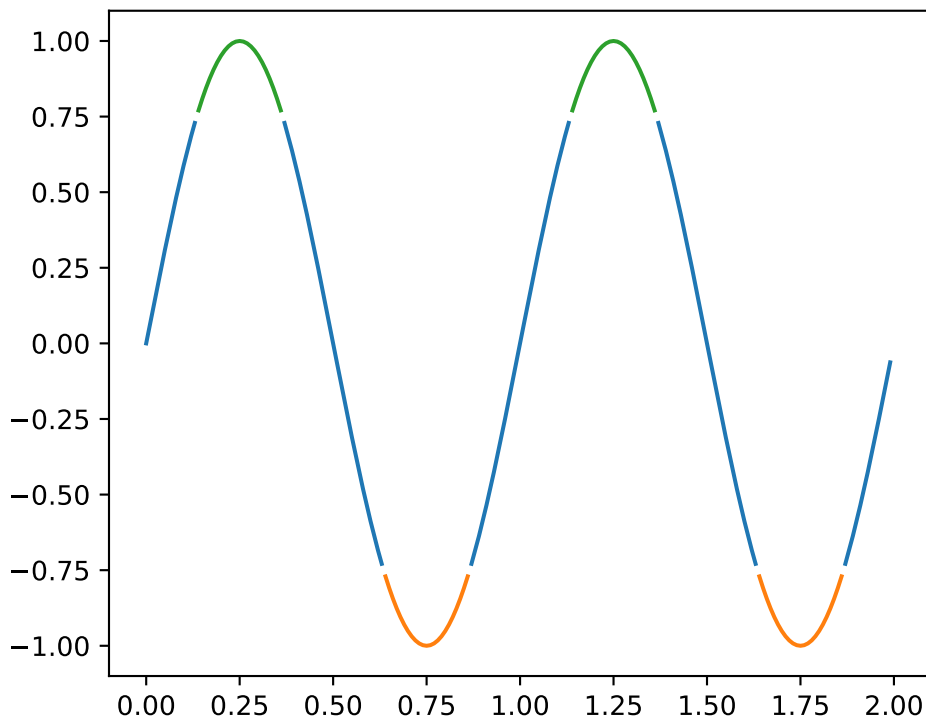

```

# use masked arrays to plot a line with different colors by y-value
import numpy as np
import matplotlib.pyplot as plt

t = np.arange(0.0, 2.0, 0.01)
s = np.sin(2*np.pi*t)

```

```
upper = 0.77
lower = -0.77

supper = np.ma.masked_where(s < upper, s)
slower = np.ma.masked_where(s > lower, s)
smiddle = np.ma.masked_where(np.logical_or(s < lower, s > upper), s)

plt.plot(t, smiddle, t, slower, t, supper)
plt.show()
```

Keywords: python, matplotlib, pylab, example, codex (see [Search examples](#))

99.33 pylab_examples example code: color_demo.py

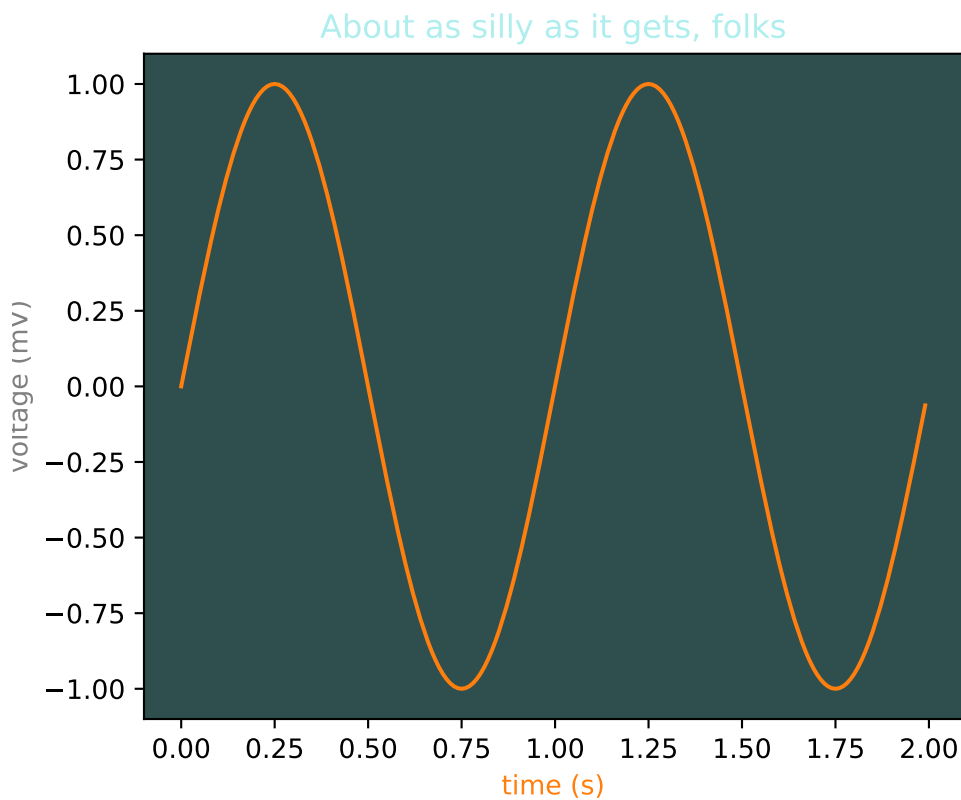

```
"""
matplotlib gives you 5 ways to specify colors,

1) as a single letter string, ala MATLAB

2) as an html style hex string or html color name
```

- 3) as an *R,G,B* tuple, where *R,G,B*, range from 0-1
- 4) as a string representing a floating point number from 0 to 1, corresponding to shades of gray.
- 5) as a special color "*Cn*", where *n* is a number 0-9 specifying the *n*th color in the currently active color cycle.

See `help(colors)` for more info.

```
"""
```

```
import matplotlib.pyplot as plt
import numpy as np
```

```
plt.subplot(111, facecolor='darkslategray')
#subplot(111, facecolor='#ababab')
t = np.arange(0.0, 2.0, 0.01)
s = np.sin(2*np.pi*t)
plt.plot(t, s, 'C1')
plt.xlabel('time (s)', color='C1')
plt.ylabel('voltage (mV)', color='0.5') # grayscale color
plt.title('About as silly as it gets, folks', color='#afeeee')
plt.show()
```

Keywords: python, matplotlib, pylab, example, codex (see [Search examples](#))

99.34 pylab_examples example code: colorbar_tick_labelling_demo.py

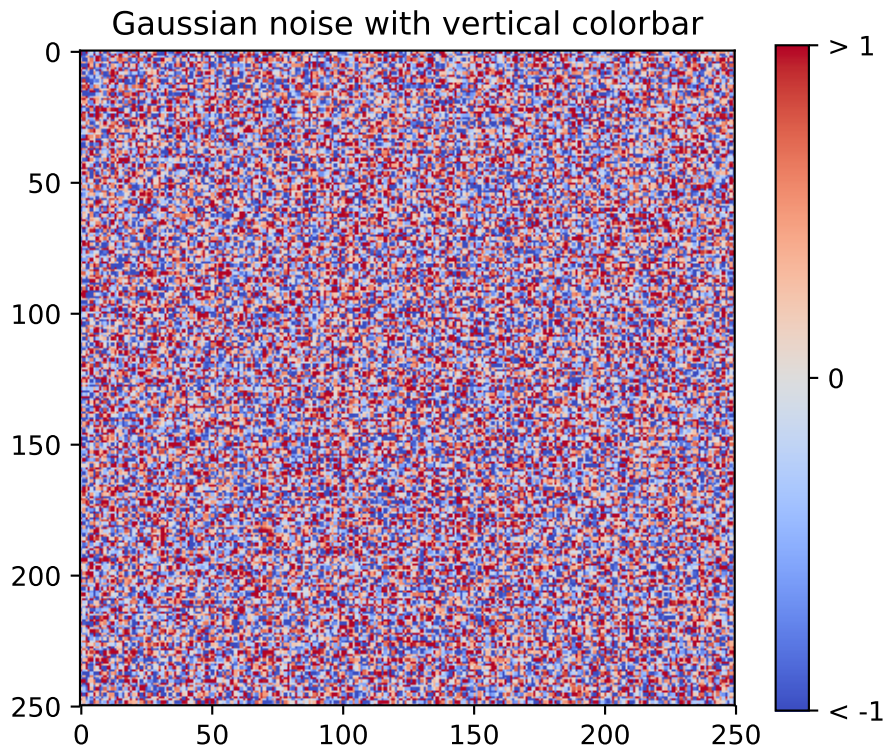

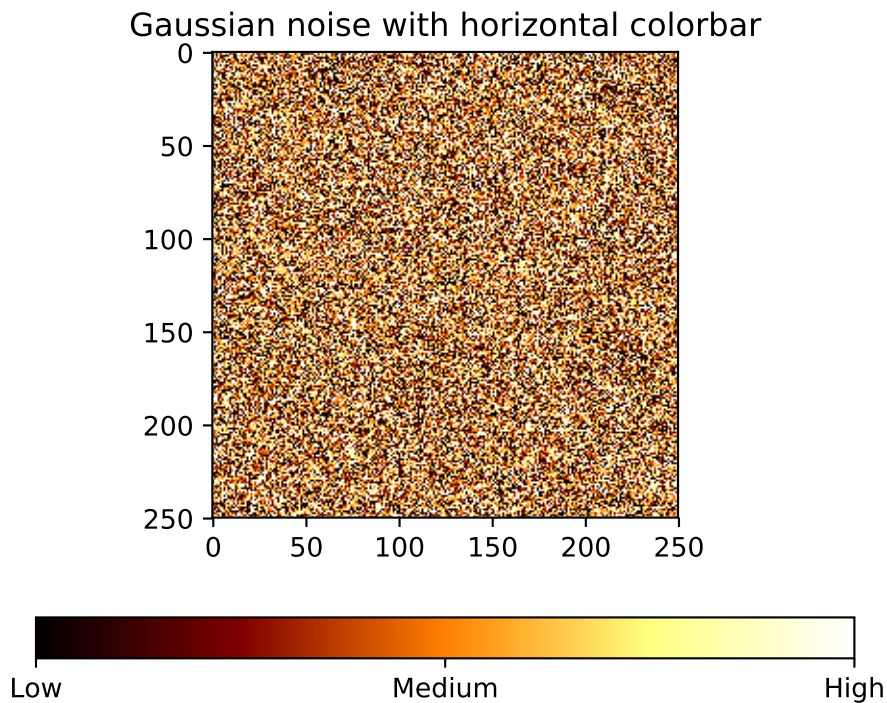

```

"""Produce custom labelling for a colorbar.

Contributed by Scott Sinclair
"""

import matplotlib.pyplot as plt
import numpy as np
from matplotlib import cm
from numpy.random import randn

# Make plot with vertical (default) colorbar
fig, ax = plt.subplots()

data = np.clip(randn(250, 250), -1, 1)

cax = ax.imshow(data, interpolation='nearest', cmap=cm.coolwarm)
ax.set_title('Gaussian noise with vertical colorbar')

# Add colorbar, make sure to specify tick locations to match desired ticklabels
cbar = fig.colorbar(cax, ticks=[-1, 0, 1])
cbar.ax.set_yticklabels(['< -1', '0', '> 1']) # vertically oriented colorbar

# Make plot with horizontal colorbar
fig, ax = plt.subplots()

data = np.clip(randn(250, 250), -1, 1)

```

```

cax = ax.imshow(data, interpolation='nearest', cmap=cm.afmhot)
ax.set_title('Gaussian noise with horizontal colorbar')

cbar = fig.colorbar(cax, ticks=[-1, 0, 1], orientation='horizontal')
cbar.ax.set_xticklabels(['Low', 'Medium', 'High']) # horizontal colorbar

plt.show()

```

Keywords: python, matplotlib, pylab, example, codex (see [Search examples](#))

99.35 pylab_examples example code: colours.py

[source code]

```

# -*- noplots -*-
"""
Some simple functions to generate colours.
"""
import numpy as np
from matplotlib import colors as mcolors

def pastel(colour, weight=2.4):
    """ Convert colour into a nice pastel shade """
    rgb = np.asarray(mcolors.to_rgba(colour)[:3])
    # scale colour
    maxc = max(rgb)
    if maxc < 1.0 and maxc > 0:
        # scale colour
        scale = 1.0 / maxc
        rgb = rgb * scale
    # now decrease saturation
    total = rgb.sum()
    slack = 0
    for x in rgb:
        slack += 1.0 - x

    # want to increase weight from total to weight
    # pick x s.t. slack * x == weight - total
    # x = (weight - total) / slack
    x = (weight - total) / slack

    rgb = [c + (x * (1.0 - c)) for c in rgb]

    return rgb

def get_colours(n):
    """ Return n pastel colours. """
    base = np.asarray([[1, 0, 0], [0, 1, 0], [0, 0, 1]])

```

```

if n <= 3:
    return base[0:n]

# how many new colours to we need to insert between
# red and green and between green and blue?
needed = (((n - 3) + 1) / 2, (n - 3) / 2)

colours = []
for start in (0, 1):
    for x in np.linspace(0, 1, needed[start] + 2):
        colours.append((base[start] * (1.0 - x)) +
                       (base[start + 1] * x))

return [pastel(c) for c in colours[0:n]]

```

Keywords: python, matplotlib, pylab, example, codex (see [Search examples](#))

99.36 pylab_examples example code: contour_corner_mask.py

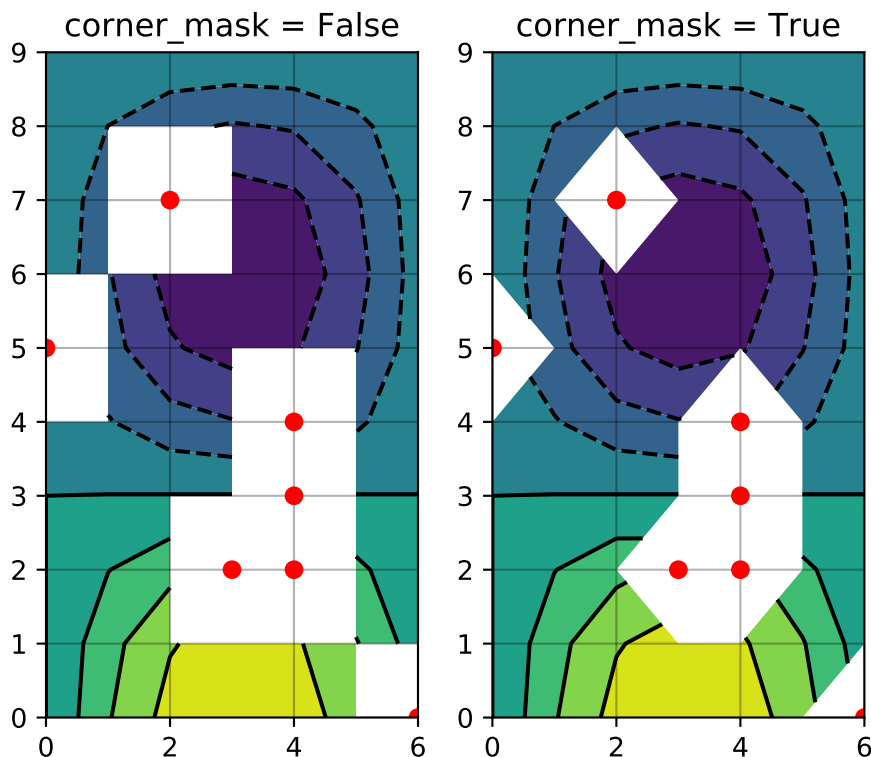

```

"""

```

```

Illustrate the difference between corner_mask=False and corner_mask=True

```

```
for masked contour plots.
"""
import matplotlib.pyplot as plt
import numpy as np

# Data to plot.
x, y = np.meshgrid(np.arange(7), np.arange(10))
z = np.sin(0.5*x)*np.cos(0.52*y)

# Mask various z values.
mask = np.zeros_like(z, dtype=np.bool)
mask[2, 3:5] = True
mask[3:5, 4] = True
mask[7, 2] = True
mask[5, 0] = True
mask[0, 6] = True
z = np.ma.array(z, mask=mask)

corner_masks = [False, True]
for i, corner_mask in enumerate(corner_masks):
    plt.subplot(1, 2, i+1)
    cs = plt.contourf(x, y, z, corner_mask=corner_mask)
    plt.contour(cs, colors='k')
    plt.title('corner_mask = {0}'.format(corner_mask))

# Plot grid.
plt.grid(c='k', ls='-', alpha=0.3)

# Indicate masked points with red circles.
plt.plot(np.ma.array(x, mask=~mask), y, 'ro')

plt.show()
```

Keywords: python, matplotlib, pylab, example, codex (see [Search examples](#))

99.37 pylab_examples example code: contour_demo.py

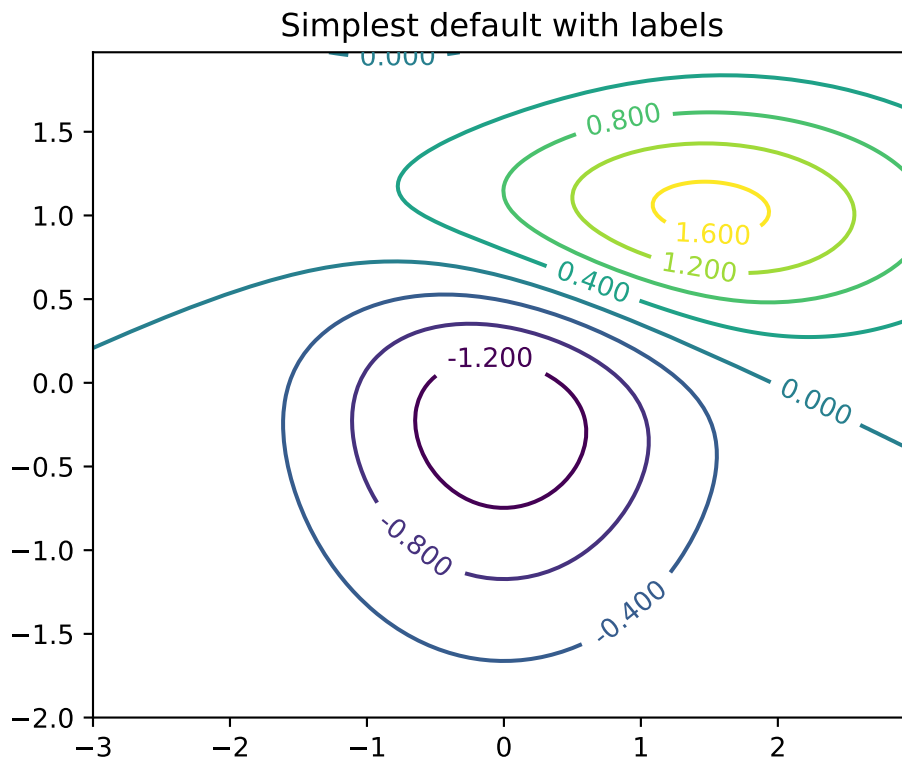

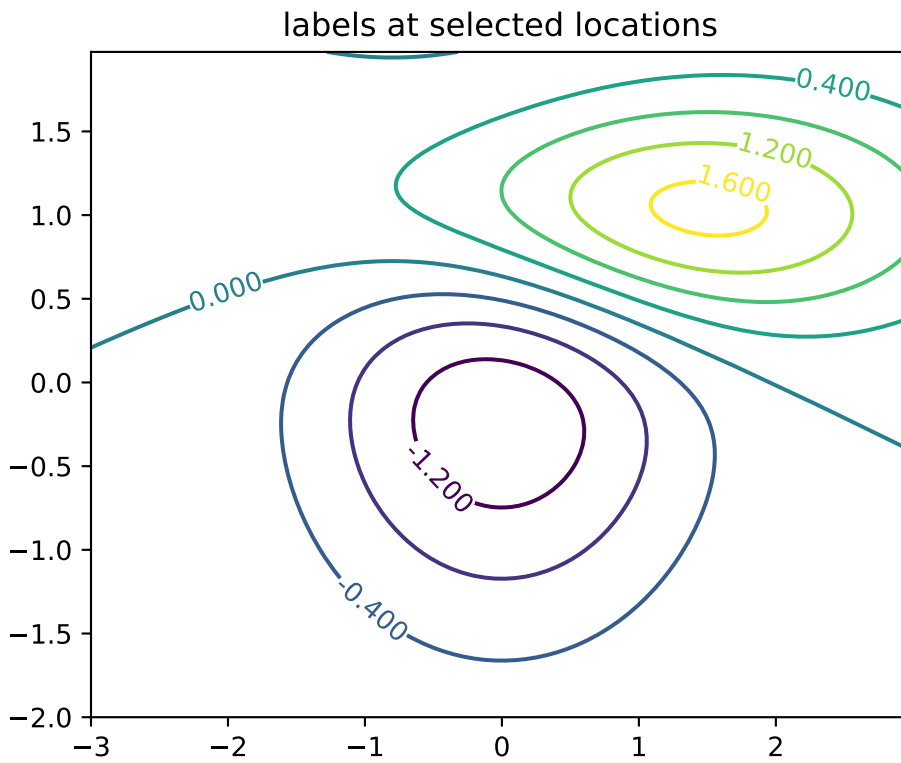

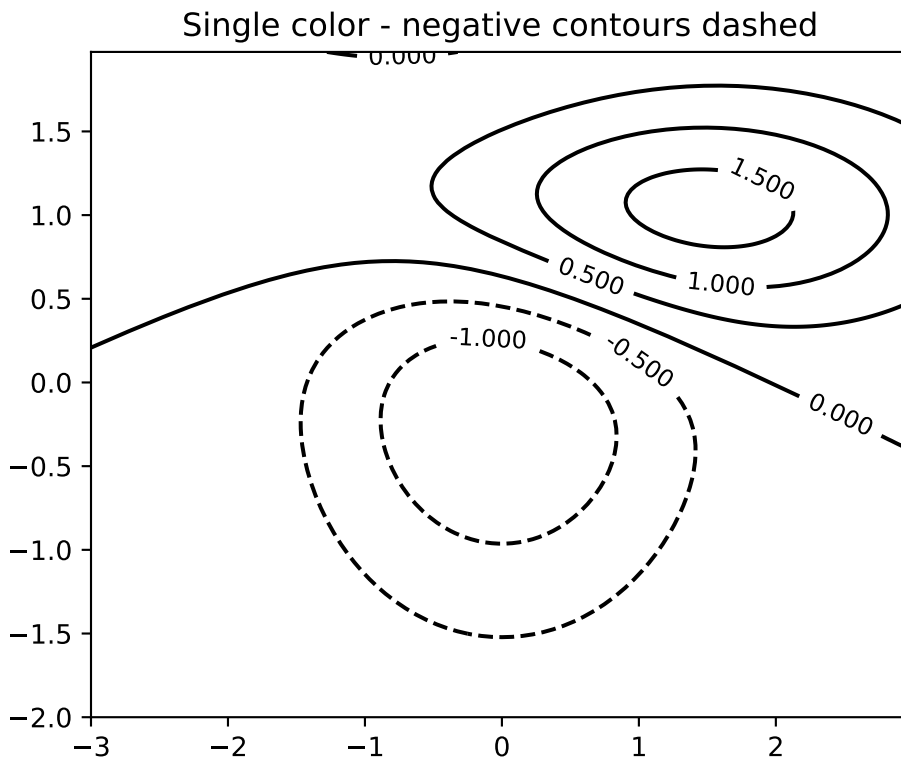

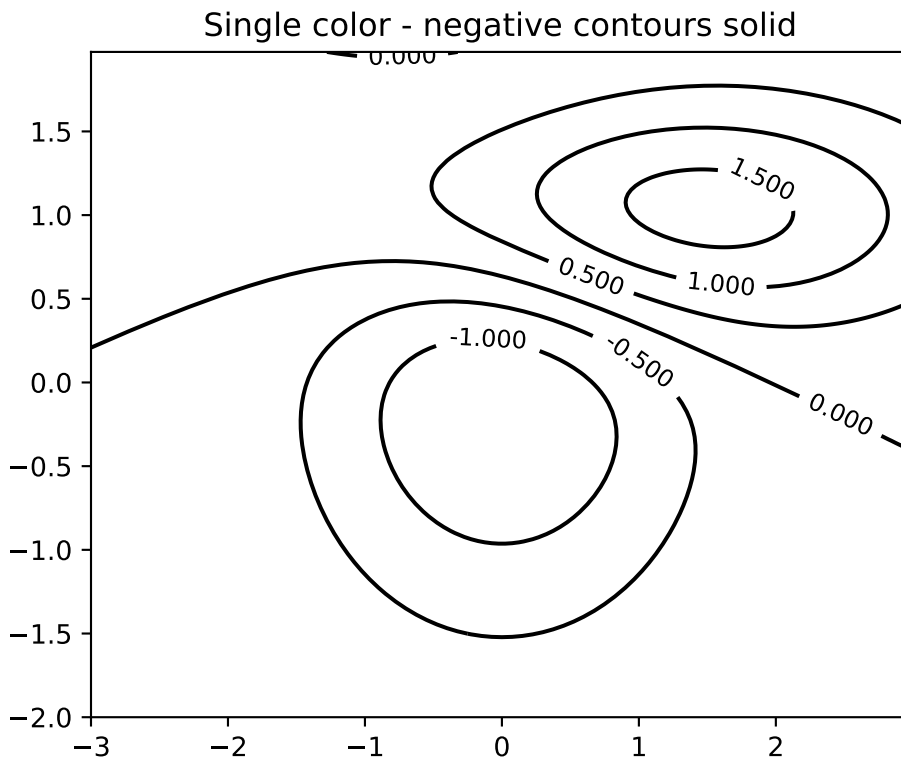

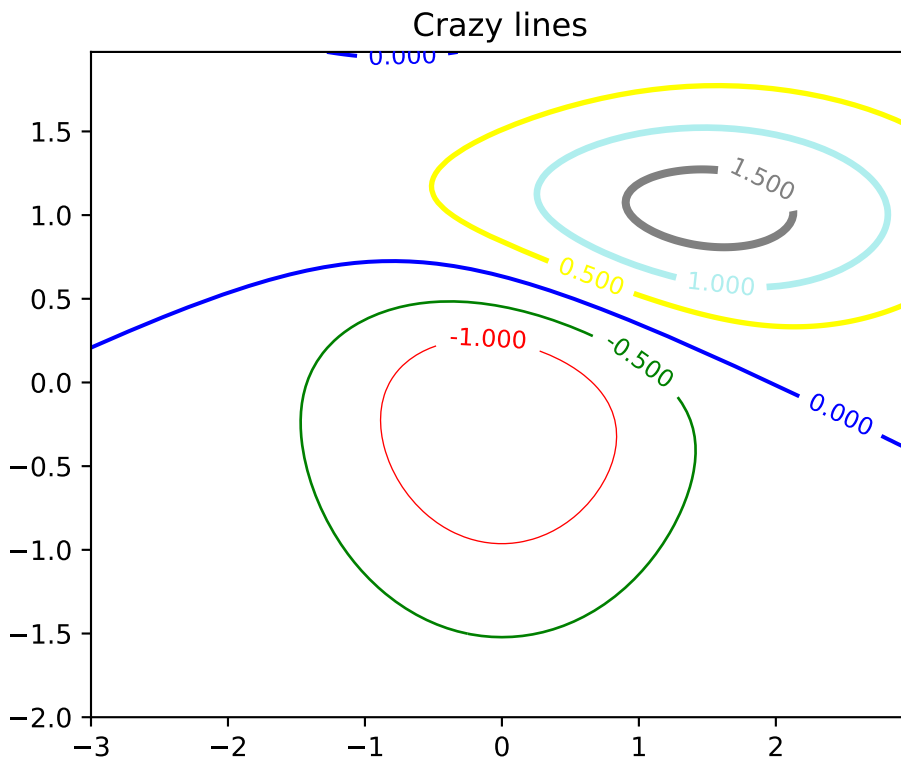

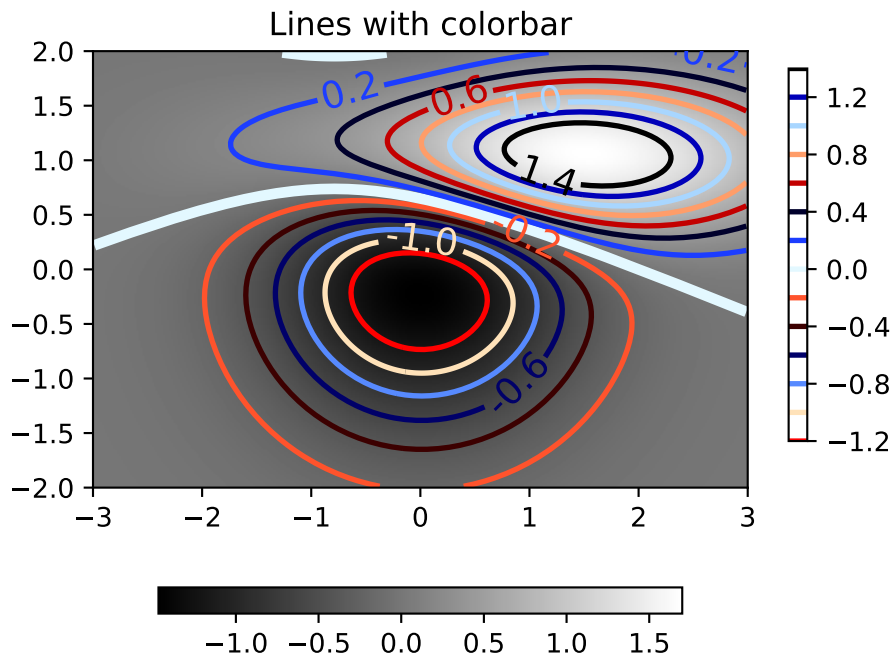

```

"""
Illustrate simple contour plotting, contours on an image with
a colorbar for the contours, and labelled contours.

See also contour_image.py.
"""
import matplotlib
import numpy as np
import matplotlib.cm as cm
import matplotlib.mlab as mlab
import matplotlib.pyplot as plt

matplotlib.rcParams['xtick.direction'] = 'out'
matplotlib.rcParams['ytick.direction'] = 'out'

delta = 0.025
x = np.arange(-3.0, 3.0, delta)
y = np.arange(-2.0, 2.0, delta)
X, Y = np.meshgrid(x, y)
Z1 = mlab.bivariate_normal(X, Y, 1.0, 1.0, 0.0, 0.0)
Z2 = mlab.bivariate_normal(X, Y, 1.5, 0.5, 1, 1)
# difference of Gaussians
Z = 10.0 * (Z2 - Z1)

# Create a simple contour plot with labels using default colors. The

```

```

# inline argument to clabel will control whether the labels are draw
# over the line segments of the contour, removing the lines beneath
# the label
plt.figure()
CS = plt.contour(X, Y, Z)
plt.clabel(CS, inline=1, fontsize=10)
plt.title('Simplest default with labels')

# contour labels can be placed manually by providing list of positions
# (in data coordinate). See ginput_manual_clabel.py for interactive
# placement.
plt.figure()
CS = plt.contour(X, Y, Z)
manual_locations = [(-1, -1.4), (-0.62, -0.7), (-2, 0.5), (1.7, 1.2), (2.0, 1.4), (2.4,
→1.7)]
plt.clabel(CS, inline=1, fontsize=10, manual=manual_locations)
plt.title('labels at selected locations')

# You can force all the contours to be the same color.
plt.figure()
CS = plt.contour(X, Y, Z, 6,
                 colors='k', # negative contours will be dashed by default
                 )
plt.clabel(CS, fontsize=9, inline=1)
plt.title('Single color - negative contours dashed')

# You can set negative contours to be solid instead of dashed:
matplotlib.rcParams['contour.negative_linestyle'] = 'solid'
plt.figure()
CS = plt.contour(X, Y, Z, 6,
                 colors='k', # negative contours will be dashed by default
                 )
plt.clabel(CS, fontsize=9, inline=1)
plt.title('Single color - negative contours solid')

# And you can manually specify the colors of the contour
plt.figure()
CS = plt.contour(X, Y, Z, 6,
                 linewidths=np.arange(.5, 4, .5),
                 colors=('r', 'green', 'blue', (1, 1, 0), '#afeeee', '0.5')
                 )
plt.clabel(CS, fontsize=9, inline=1)
plt.title('Crazy lines')

# Or you can use a colormap to specify the colors; the default
# colormap will be used for the contour lines
plt.figure()
im = plt.imshow(Z, interpolation='bilinear', origin='lower',
               cmap=cm.gray, extent=(-3, 3, -2, 2))

```

```
levels = np.arange(-1.2, 1.6, 0.2)
CS = plt.contour(Z, levels,
                 origin='lower',
                 linewidths=2,
                 extent=(-3, 3, -2, 2))

# Thicken the zero contour.
zc = CS.collections[6]
plt.setp(zc, linewidth=4)

plt.clabel(CS, levels[1::2], # label every second level
           inline=1,
           fmt='%1.1f',
           fontsize=14)

# make a colorbar for the contour lines
CB = plt.colorbar(CS, shrink=0.8, extend='both')

plt.title('Lines with colorbar')
#plt.hot() # Now change the colormap for the contour lines and colorbar
plt.flag()

# We can still add a colorbar for the image, too.
CBI = plt.colorbar(im, orientation='horizontal', shrink=0.8)

# This makes the original colorbar look a bit out of place,
# so let's improve its position.

l, b, w, h = plt.gca().get_position().bounds
ll, bb, ww, hh = CB.ax.get_position().bounds
CB.ax.set_position([ll, b + 0.1*h, ww, h*0.8])

plt.show()
```

Keywords: python, matplotlib, pylab, example, codex (see [Search examples](#))

99.38 pylab_examples example code: contour_image.py

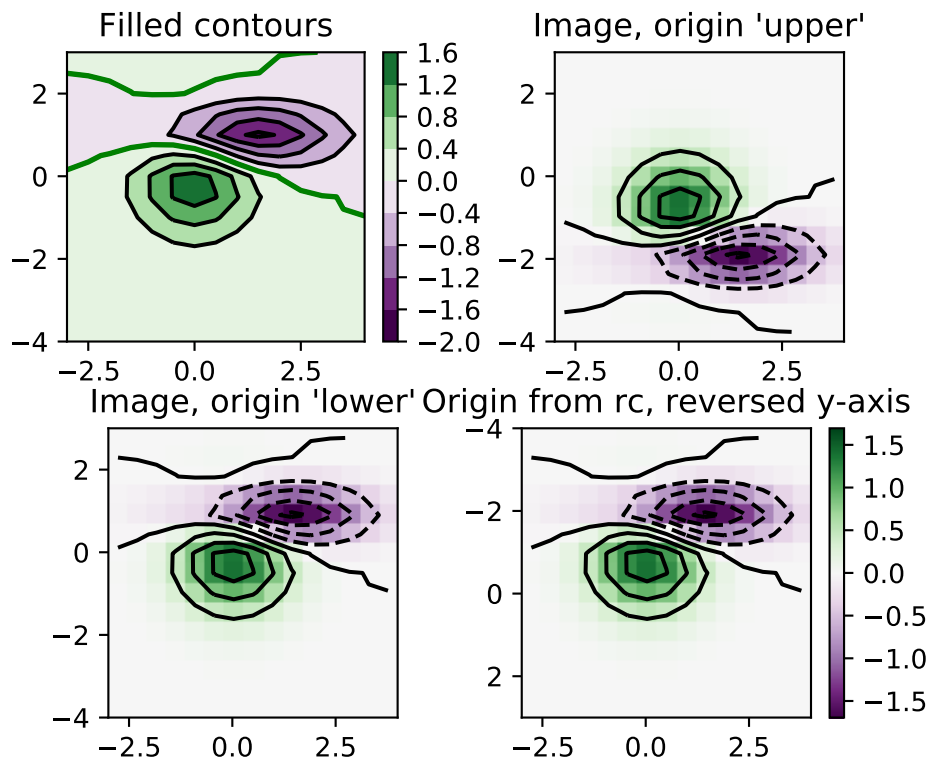

```

"""
Test combinations of contouring, filled contouring, and image plotting.
For contour labelling, see contour_demo.py.

The emphasis in this demo is on showing how to make contours register
correctly on images, and on how to get both of them oriented as
desired. In particular, note the usage of the "origin" and "extent"
keyword arguments to imshow and contour.
"""
import matplotlib.pyplot as plt
import numpy as np
from matplotlib import mlab, cm

# Default delta is large because that makes it fast, and it illustrates
# the correct registration between image and contours.
delta = 0.5

extent = (-3, 4, -4, 3)

x = np.arange(-3.0, 4.001, delta)
y = np.arange(-4.0, 3.001, delta)
X, Y = np.meshgrid(x, y)

```

```

Z1 = mlab.bivariate_normal(X, Y, 1.0, 1.0, 0.0, 0.0)
Z2 = mlab.bivariate_normal(X, Y, 1.5, 0.5, 1, 1)
Z = (Z1 - Z2) * 10

levels = np.arange(-2.0, 1.601, 0.4) # Boost the upper limit to avoid truncation errors.

norm = cm.colors.Normalize(vmax=abs(Z).max(), vmin=-abs(Z).max())
cmap = cm.PRGN

fig = plt.figure()
fig.subplots_adjust(hspace=0.3)

plt.subplot(2, 2, 1)

cset1 = plt.contourf(X, Y, Z, levels,
                    cmap=cm.get_cmap(cmap, len(levels) - 1),
                    norm=norm,
                    )
# It is not necessary, but for the colormap, we need only the
# number of levels minus 1. To avoid discretization error, use
# either this number or a large number such as the default (256).

# If we want lines as well as filled regions, we need to call
# contour separately; don't try to change the edgecolor or edgewidth
# of the polygons in the collections returned by contourf.
# Use levels output from previous call to guarantee they are the same.

cset2 = plt.contour(X, Y, Z, cset1.levels, colors='k')

# We don't really need dashed contour lines to indicate negative
# regions, so let's turn them off.

for c in cset2.collections:
    c.set_linestyle('solid')

# It is easier here to make a separate call to contour than
# to set up an array of colors and linewidths.
# We are making a thick green line as a zero contour.
# Specify the zero level as a tuple with only 0 in it.

cset3 = plt.contour(X, Y, Z, (0,), colors='g', linewidths=2)
plt.title('Filled contours')
plt.colorbar(cset1)

plt.subplot(2, 2, 2)

plt.imshow(Z, extent=extent, cmap=cmap, norm=norm)
v = plt.axis()
plt.contour(Z, levels, colors='k', origin='upper', extent=extent)
plt.axis(v)
plt.title("Image, origin 'upper'")

```

```
plt.subplot(2, 2, 3)

plt.imshow(Z, origin='lower', extent=extent, cmap=cmap, norm=norm)
v = plt.axis()
plt.contour(Z, levels, colors='k', origin='lower', extent=extent)
plt.axis(v)
plt.title("Image, origin 'lower'")

plt.subplot(2, 2, 4)

# We will use the interpolation "nearest" here to show the actual
# image pixels.
# Note that the contour lines don't extend to the edge of the box.
# This is intentional. The Z values are defined at the center of each
# image pixel (each color block on the following subplot), so the
# domain that is contoured does not extend beyond these pixel centers.
im = plt.imshow(Z, interpolation='nearest', extent=extent, cmap=cmap, norm=norm)
v = plt.axis()
plt.contour(Z, levels, colors='k', origin='image', extent=extent)
plt.axis(v)
ylim = plt.get(plt.gca(), 'ylim')
plt.setp(plt.gca(), ylim=ylim[::-1])
plt.title("Origin from rc, reversed y-axis")
plt.colorbar(im)

plt.show()
```

Keywords: python, matplotlib, pylab, example, codex (see [Search examples](#))

99.39 pylab_examples example code: contour_label_demo.py

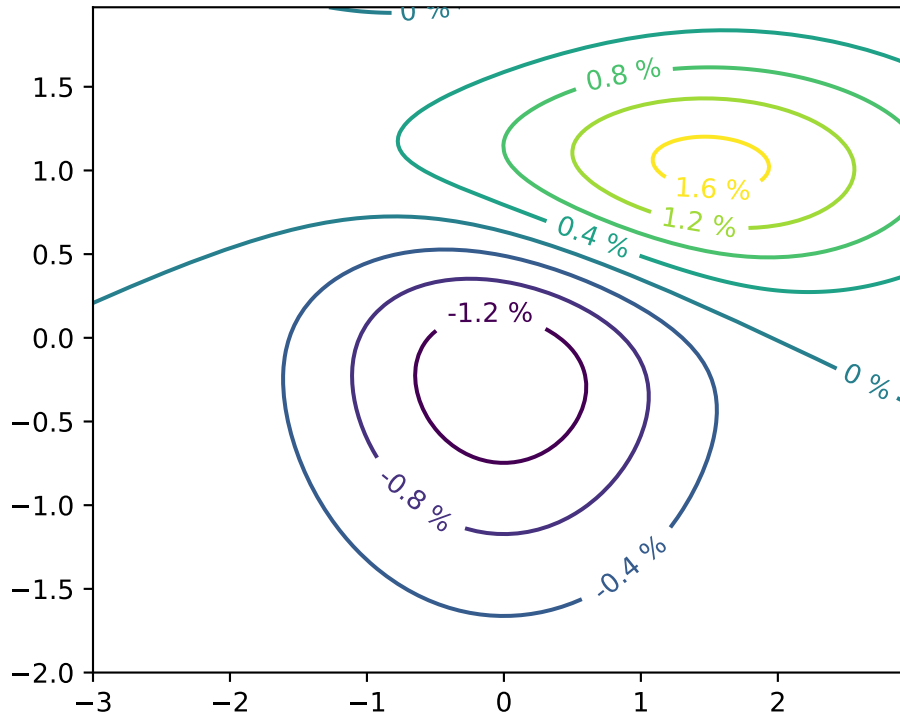

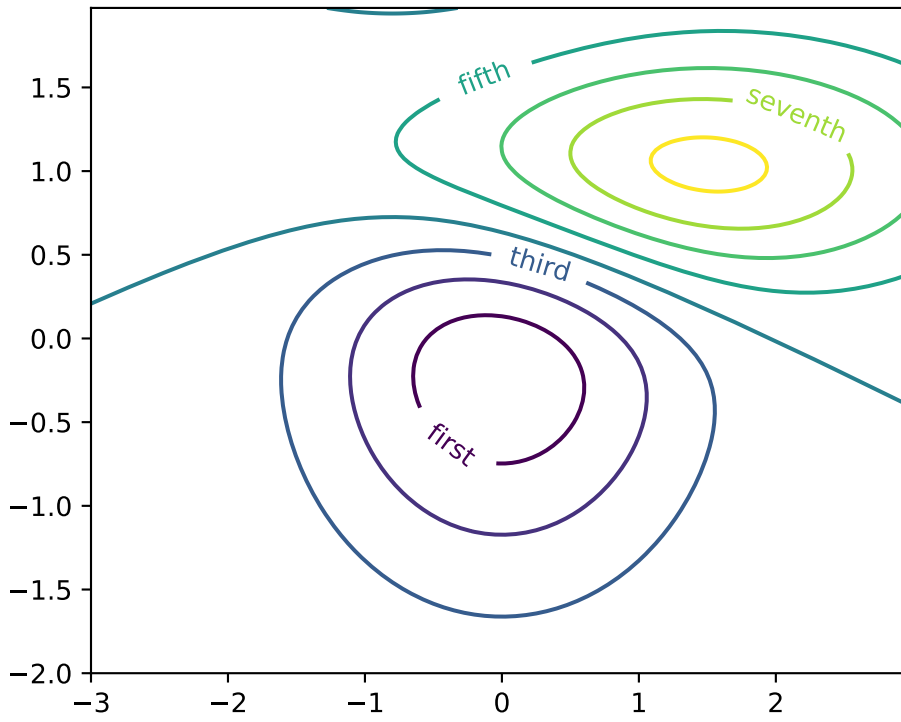

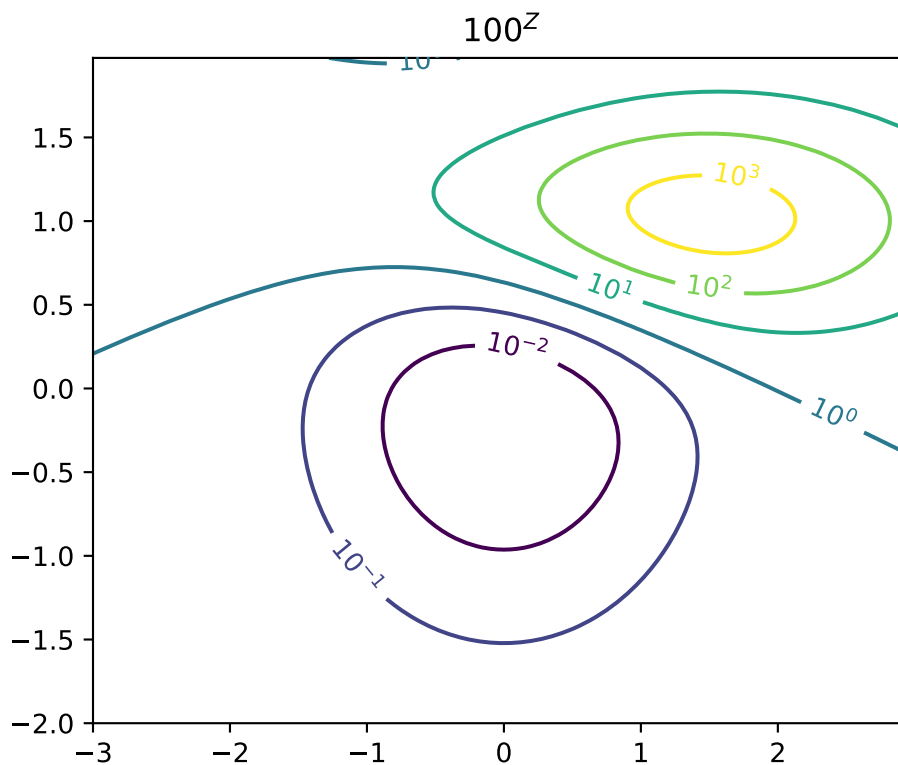

```

"""
Illustrate some of the more advanced things that one can do with
contour labels.

See also contour_demo.py.
"""
import matplotlib
import numpy as np
import matplotlib.cm as cm
import matplotlib.mlab as mlab
import matplotlib.ticker as ticker
import matplotlib.pyplot as plt

matplotlib.rcParams['xtick.direction'] = 'out'
matplotlib.rcParams['ytick.direction'] = 'out'

#####
# Define our surface
#####
delta = 0.025
x = np.arange(-3.0, 3.0, delta)
y = np.arange(-2.0, 2.0, delta)
X, Y = np.meshgrid(x, y)
Z1 = mlab.bivariate_normal(X, Y, 1.0, 1.0, 0.0, 0.0)
Z2 = mlab.bivariate_normal(X, Y, 1.5, 0.5, 1, 1)
# difference of Gaussians

```

```

Z = 10.0 * (Z2 - Z1)

#####
# Make contour labels using creative float classes
# Follows suggestion of Manuel Metz
#####
plt.figure()

# Basic contour plot
CS = plt.contour(X, Y, Z)

# Define a class that forces representation of float to look a certain way
# This remove trailing zero so '1.0' becomes '1'
class nf(float):
    def __repr__(self):
        str = '%.1f' % (self.__float__(),)
        if str[-1] == '0':
            return '%.0f' % self.__float__()
        else:
            return '%.1f' % self.__float__()

# Recast levels to new class
CS.levels = [nf(val) for val in CS.levels]

# Label levels with specially formatted floats
if plt.rcParams["text.usetex"]:
    fmt = r'%r \%'
else:
    fmt = '%r %%'
plt.clabel(CS, CS.levels, inline=True, fmt=fmt, fontsize=10)

#####
# Label contours with arbitrary strings using a
# dictionary
#####
plt.figure()

# Basic contour plot
CS = plt.contour(X, Y, Z)

fmt = {}
strs = ['first', 'second', 'third', 'fourth', 'fifth', 'sixth', 'seventh']
for l, s in zip(CS.levels, strs):
    fmt[l] = s

# Label every other level using strings
plt.clabel(CS, CS.levels[::2], inline=True, fmt=fmt, fontsize=10)

# Use a Formatter

plt.figure()

```

```
CS = plt.contour(X, Y, 100**Z, locator=plt.LogLocator())
fmt = ticker.LogFormatterMathtext()
fmt.create_dummy_axis()
plt.clabel(CS, CS.levels, fmt=fmt)
plt.title("$100^Z$")

plt.show()
```

Keywords: python, matplotlib, pylab, example, codex (see [Search examples](#))

99.40 pylab_examples example code: contourf_demo.py

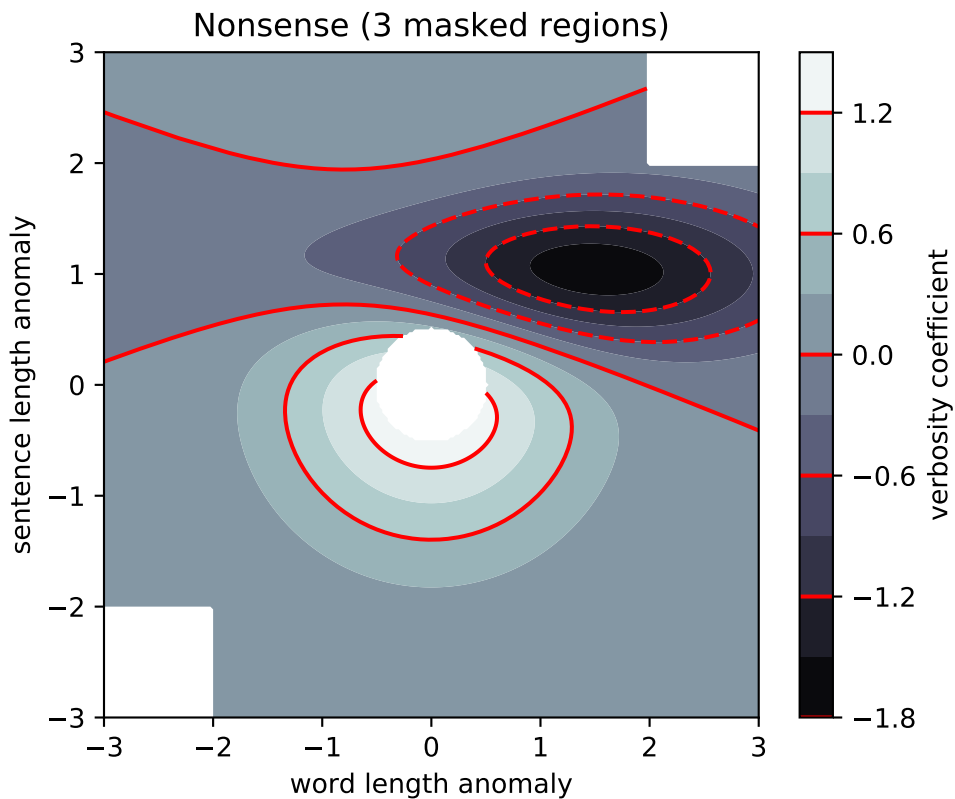

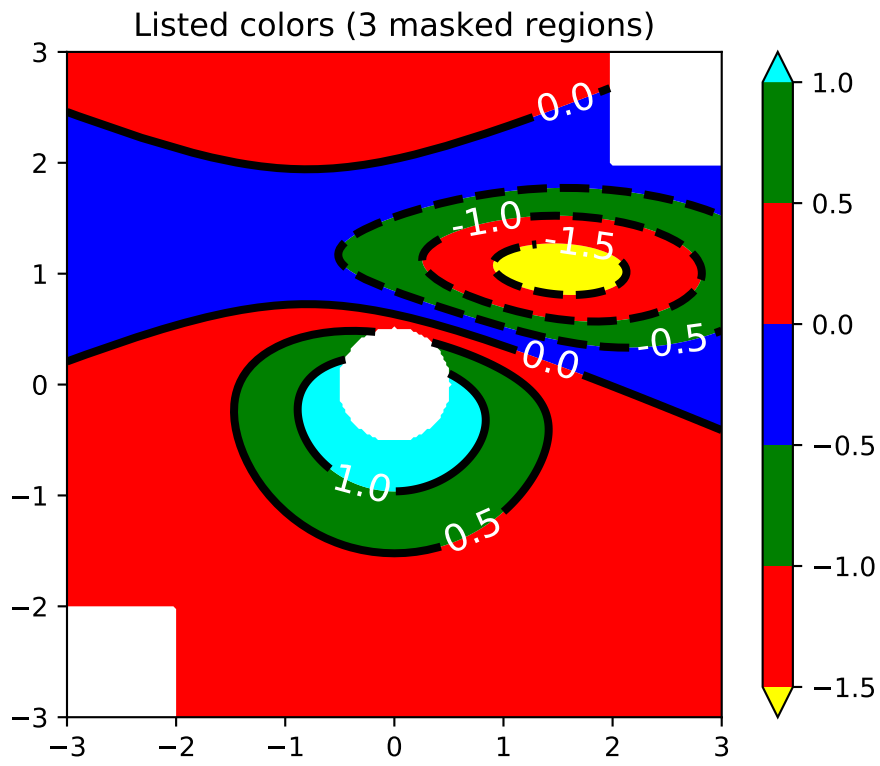

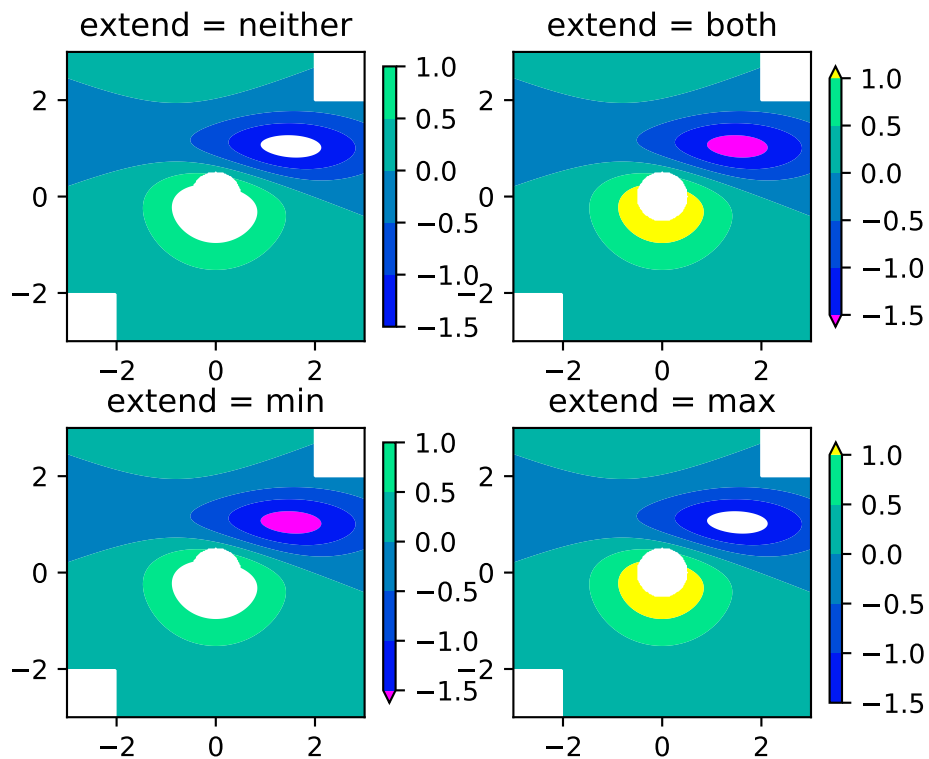

```

import numpy as np
import matplotlib.pyplot as plt

origin = 'lower'
#origin = 'upper'

delta = 0.025

x = y = np.arange(-3.0, 3.01, delta)
X, Y = np.meshgrid(x, y)
Z1 = plt.mlab.bivariate_normal(X, Y, 1.0, 1.0, 0.0, 0.0)
Z2 = plt.mlab.bivariate_normal(X, Y, 1.5, 0.5, 1, 1)
Z = 10 * (Z1 - Z2)

nr, nc = Z.shape

# put NaNs in one corner:
Z[-nr//6:, -nc//6:] = np.nan
# contourf will convert these to masked

Z = np.ma.array(Z)
# mask another corner:
Z[:nr//6, :nc//6] = np.ma.masked

# mask a circle in the middle:

```

```

interior = np.sqrt((X**2) + (Y**2)) < 0.5
Z[interior] = np.ma.masked

# We are using automatic selection of contour levels;
# this is usually not such a good idea, because they don't
# occur on nice boundaries, but we do it here for purposes
# of illustration.
CS = plt.contourf(X, Y, Z, 10,
                 #[-1, -0.1, 0, 0.1],
                 #alpha=0.5,
                 cmap=plt.cm.bone,
                 origin=origin)

# Note that in the following, we explicitly pass in a subset of
# the contour levels used for the filled contours. Alternatively,
# We could pass in additional levels to provide extra resolution,
# or leave out the levels kwarg to use all of the original levels.

CS2 = plt.contour(CS, levels=CS.levels[:,2],
                  colors='r',
                  origin=origin)

plt.title('Nonsense (3 masked regions)')
plt.xlabel('word length anomaly')
plt.ylabel('sentence length anomaly')

# Make a colorbar for the ContourSet returned by the contourf call.
cbar = plt.colorbar(CS)
cbar.ax.set_ylabel('verbosity coefficient')
# Add the contour line levels to the colorbar
cbar.add_lines(CS2)

plt.figure()

# Now make a contour plot with the levels specified,
# and with the colormap generated automatically from a list
# of colors.
levels = [-1.5, -1, -0.5, 0, 0.5, 1]
CS3 = plt.contourf(X, Y, Z, levels,
                  colors=('r', 'g', 'b'),
                  origin=origin,
                  extend='both')

# Our data range extends outside the range of levels; make
# data below the lowest contour level yellow, and above the
# highest level cyan:
CS3.cmap.set_under('yellow')
CS3.cmap.set_over('cyan')

CS4 = plt.contour(X, Y, Z, levels,
                  colors=('k',),
                  linewidths=(3,),
                  origin=origin)
plt.title('Listed colors (3 masked regions)')

```

```
plt.clabel(CS4, fmt='%2.1f', colors='w', fontsize=14)

# Notice that the colorbar command gets all the information it
# needs from the ContourSet object, CS3.
plt.colorbar(CS3)

# Illustrate all 4 possible "extend" settings:
extends = ["neither", "both", "min", "max"]
cmap = plt.cm.get_cmap("winter")
cmap.set_under("magenta")
cmap.set_over("yellow")
# Note: contouring simply excludes masked or nan regions, so
# instead of using the "bad" colormap value for them, it draws
# nothing at all in them. Therefore the following would have
# no effect:
# cmap.set_bad("red")

fig, axs = plt.subplots(2, 2)
fig.subplots_adjust(hspace=0.3)

for ax, extend in zip(axs.ravel(), extends):
    cs = ax.contourf(X, Y, Z, levels, cmap=cmap, extend=extend, origin=origin)
    fig.colorbar(cs, ax=ax, shrink=0.9)
    ax.set_title("extend = %s" % extend)
    ax.locator_params(nbins=4)

plt.show()
```

Keywords: python, matplotlib, pylab, example, codex (see [Search examples](#))

99.41 pylab_examples example code: contourf_hatching.py

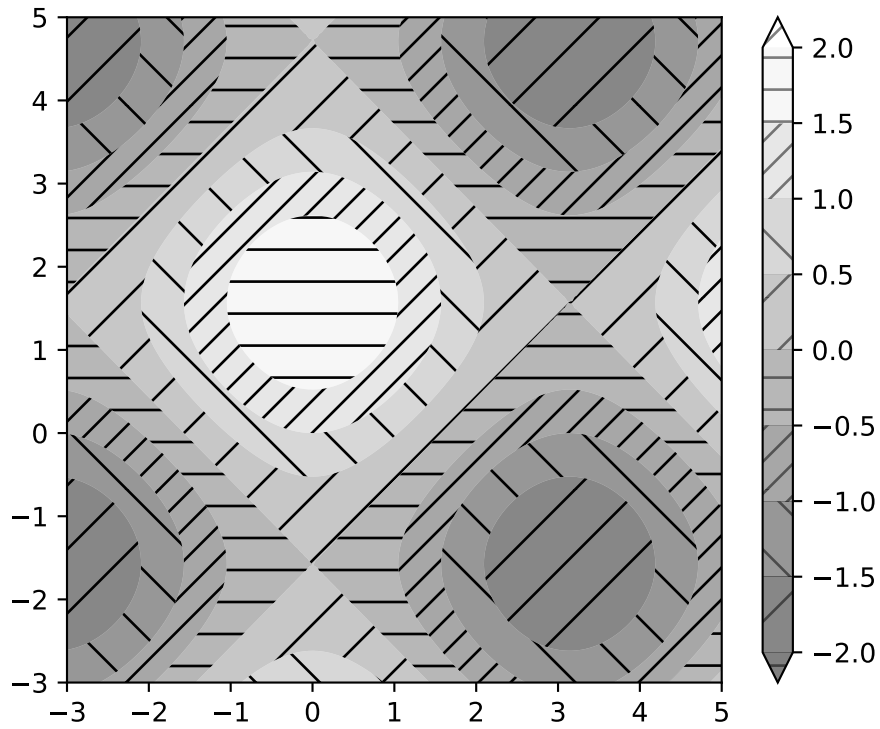

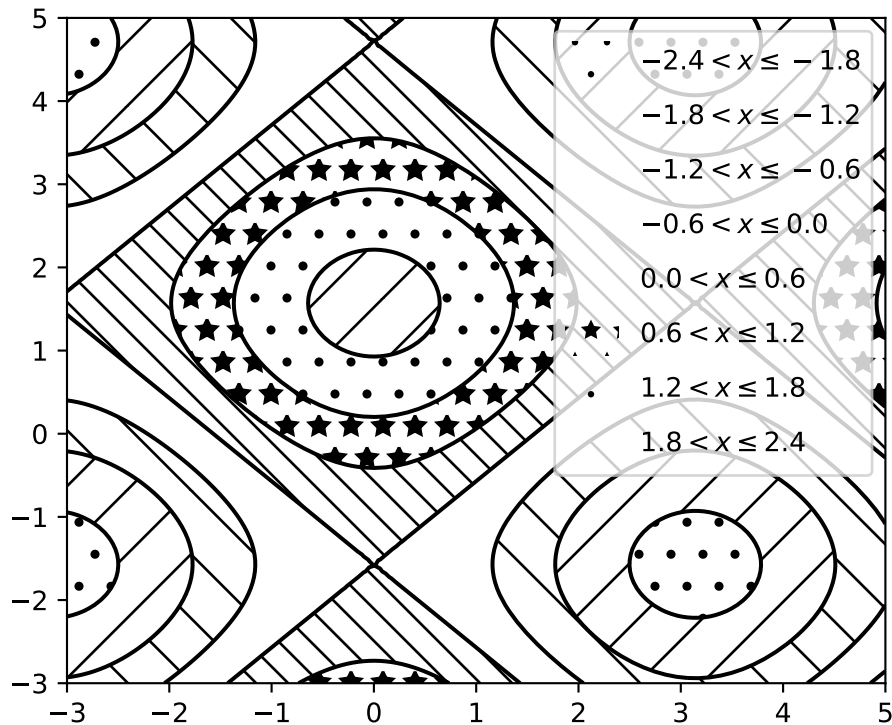

```

import matplotlib.pyplot as plt
import numpy as np

# invent some numbers, turning the x and y arrays into simple
# 2d arrays, which make combining them together easier.
x = np.linspace(-3, 5, 150).reshape(1, -1)
y = np.linspace(-3, 5, 120).reshape(-1, 1)
z = np.cos(x) + np.sin(y)

# we no longer need x and y to be 2 dimensional, so flatten them.
x, y = x.flatten(), y.flatten()

# -----
# |           Plot #1           |
# -----
# the simplest hatched plot with a colorbar
fig = plt.figure()
cs = plt.contourf(x, y, z, hatches=['-', '/', '\\', '\\/'],
                 cmap=plt.get_cmap('gray'),
                 extend='both', alpha=0.5
                 )
plt.colorbar()

```

```
# -----  
# |           Plot #2           |  
# -----  
# a plot of hatches without color with a legend  
plt.figure()  
n_levels = 6  
plt.contour(x, y, z, n_levels, colors='black', linestyle='-')  
cs = plt.contourf(x, y, z, n_levels, colors='none',  
                 hatches=['.', '/', '\\', None, '\\\\', '*'],  
                 extend='lower'  
                 )  
  
# create a legend for the contour set  
artists, labels = cs.legend_elements()  
plt.legend(artists, labels, handleheight=2)  
  
plt.show()
```

Keywords: python, matplotlib, pylab, example, codex (see [Search examples](#))

99.42 pylab_examples example code: coords_demo.py

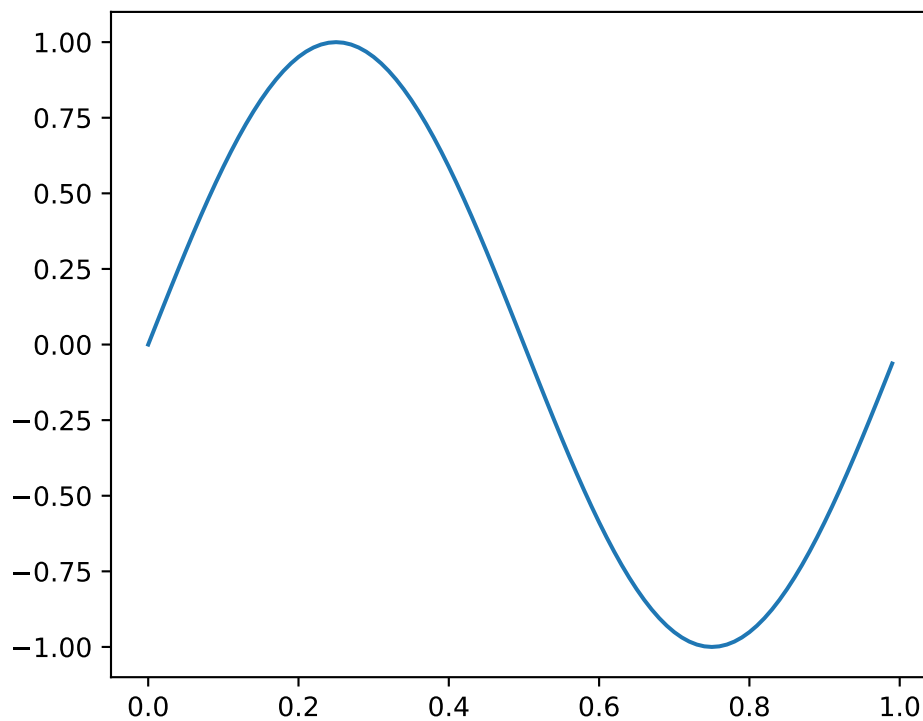

```
"""
An example of how to interact with the plotting canvas by connecting
to move and click events
"""
from __future__ import print_function
import sys
import matplotlib.pyplot as plt
import numpy as np

t = np.arange(0.0, 1.0, 0.01)
s = np.sin(2*np.pi*t)
fig, ax = plt.subplots()
ax.plot(t, s)

def on_move(event):
    # get the x and y pixel coords
    x, y = event.x, event.y

    if event.inaxes:
        ax = event.inaxes # the axes instance
        print('data coords %f %f' % (event.xdata, event.ydata))

def on_click(event):
    # get the x and y coords, flip y from top to bottom
    x, y = event.x, event.y
    if event.button == 1:
        if event.inaxes is not None:
            print('data coords %f %f' % (event.xdata, event.ydata))

binding_id = plt.connect('motion_notify_event', on_move)
plt.connect('button_press_event', on_click)

if "test_disconnect" in sys.argv:
    print("disconnecting console coordinate printout...")
    plt.disconnect(binding_id)

plt.show()
```

Keywords: python, matplotlib, pylab, example, codex (see [Search examples](#))

99.43 pylab_examples example code: coords_report.py

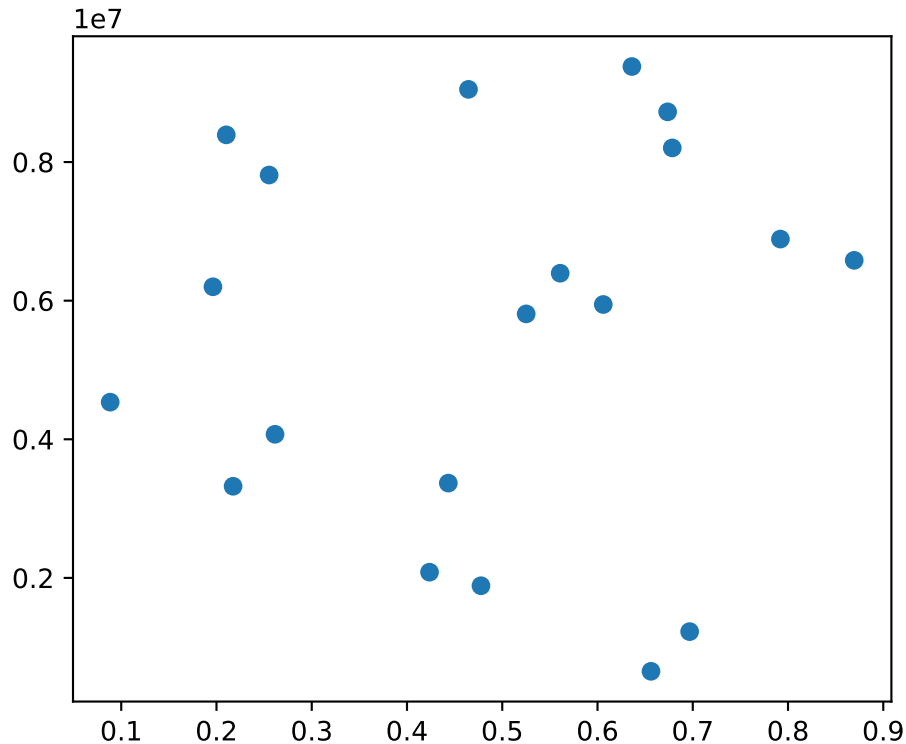

```
# override the default reporting of coords
```

```
import matplotlib.pyplot as plt
import numpy as np
```

```
def millions(x):
    return '%1.1fM' % (x*1e-6)
```

```
x = np.random.rand(20)
y = 1e7*np.random.rand(20)
```

```
fig, ax = plt.subplots()
ax.fmt_ydata = millions
plt.plot(x, y, 'o')
```

```
plt.show()
```

Keywords: python, matplotlib, pylab, example, codex (see [Search examples](#))

99.44 pylab_examples example code: csd_demo.py

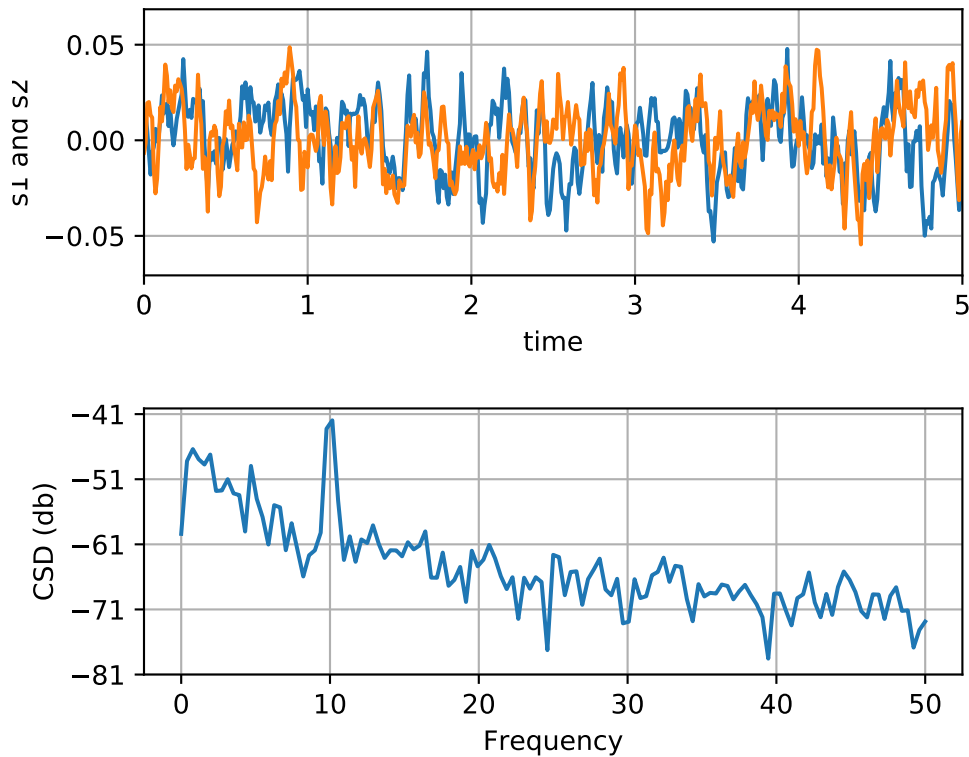

```

"""
Compute the cross spectral density of two signals
"""
import numpy as np
import matplotlib.pyplot as plt

fig, (ax1, ax2) = plt.subplots(2, 1)
# make a little extra space between the subplots
fig.subplots_adjust(hspace=0.5)

dt = 0.01
t = np.arange(0, 30, dt)
nse1 = np.random.randn(len(t))           # white noise 1
nse2 = np.random.randn(len(t))           # white noise 2
r = np.exp(-t/0.05)

cns1 = np.convolve(nse1, r, mode='same')*dt # colored noise 1
cns2 = np.convolve(nse2, r, mode='same')*dt # colored noise 2

# two signals with a coherent part and a random part
s1 = 0.01*np.sin(2*np.pi*10*t) + cns1

```

```
s2 = 0.01*np.sin(2*np.pi*10*t) + cns2

ax1.plot(t, s1, t, s2)
ax1.set_xlim(0, 5)
ax1.set_xlabel('time')
ax1.set_ylabel('s1 and s2')
ax1.grid(True)

cxy, f = ax2.csd(s1, s2, 256, 1./dt)
ax2.set_ylabel('CSD (db)')
plt.show()
```

Keywords: python, matplotlib, pylab, example, codex (see *Search examples*)

99.45 pylab_examples example code: cursor_demo.py

[source code]

```
# -*- noplots -*-

"""
This example shows how to use matplotlib to provide a data cursor. It
uses matplotlib to draw the cursor and may be a slow since this
requires redrawing the figure with every mouse move.

Faster cursoring is possible using native GUI drawing, as in
wxcursor_demo.py.

The mpldatacursor and mplcursors third-party packages can be used to achieve a
similar effect. See
https://github.com/joferkington/mpldatacursor
https://github.com/anntzer/mplcursors
"""
from __future__ import print_function
import matplotlib.pyplot as plt
import numpy as np

class Cursor(object):
    def __init__(self, ax):
        self.ax = ax
        self.lx = ax.axhline(color='k') # the horiz line
        self.ly = ax.axvline(color='k') # the vert line

        # text location in axes coords
        self.txt = ax.text(0.7, 0.9, '', transform=ax.transAxes)

    def mouse_move(self, event):
        if not event.inaxes:
            return
```

```

    x, y = event.xdata, event.ydata
    # update the line positions
    self.lx.set_ydata(y)
    self.ly.set_xdata(x)

    self.txt.set_text('x=%1.2f, y=%1.2f' % (x, y))
    plt.draw()

class SnaptoCursor(object):
    """
    Like Cursor but the crosshair snaps to the nearest x,y point
    For simplicity, I'm assuming x is sorted
    """

    def __init__(self, ax, x, y):
        self.ax = ax
        self.lx = ax.axhline(color='k') # the horiz line
        self.ly = ax.axvline(color='k') # the vert line
        self.x = x
        self.y = y
        # text location in axes coords
        self.txt = ax.text(0.7, 0.9, '', transform=ax.transAxes)

    def mouse_move(self, event):

        if not event.inaxes:
            return

        x, y = event.xdata, event.ydata

        indx = np.searchsorted(self.x, [x])[0]
        x = self.x[indx]
        y = self.y[indx]
        # update the line positions
        self.lx.set_ydata(y)
        self.ly.set_xdata(x)

        self.txt.set_text('x=%1.2f, y=%1.2f' % (x, y))
        print('x=%1.2f, y=%1.2f' % (x, y))
        plt.draw()

t = np.arange(0.0, 1.0, 0.01)
s = np.sin(2*2*np.pi*t)
fig, ax = plt.subplots()

#cursor = Cursor(ax)
cursor = SnaptoCursor(ax, t, s)
plt.connect('motion_notify_event', cursor.mouse_move)

ax.plot(t, s, 'o')
plt.axis([0, 1, -1, 1])
plt.show()

```

Keywords: python, matplotlib, pylab, example, codex (see [Search examples](#))

99.46 pylab_examples example code: custom_cmap.py

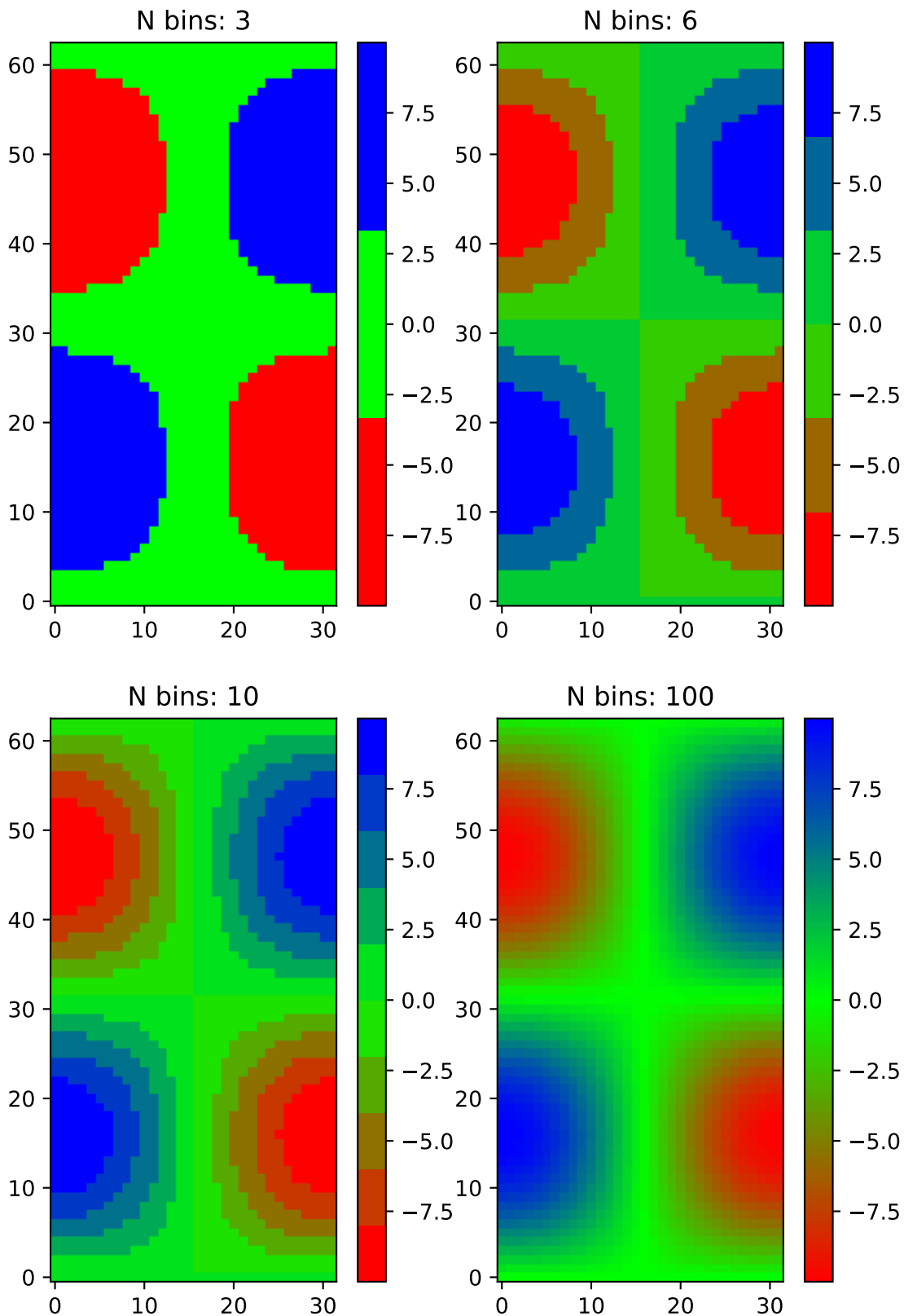

Custom Blue-Red colormaps

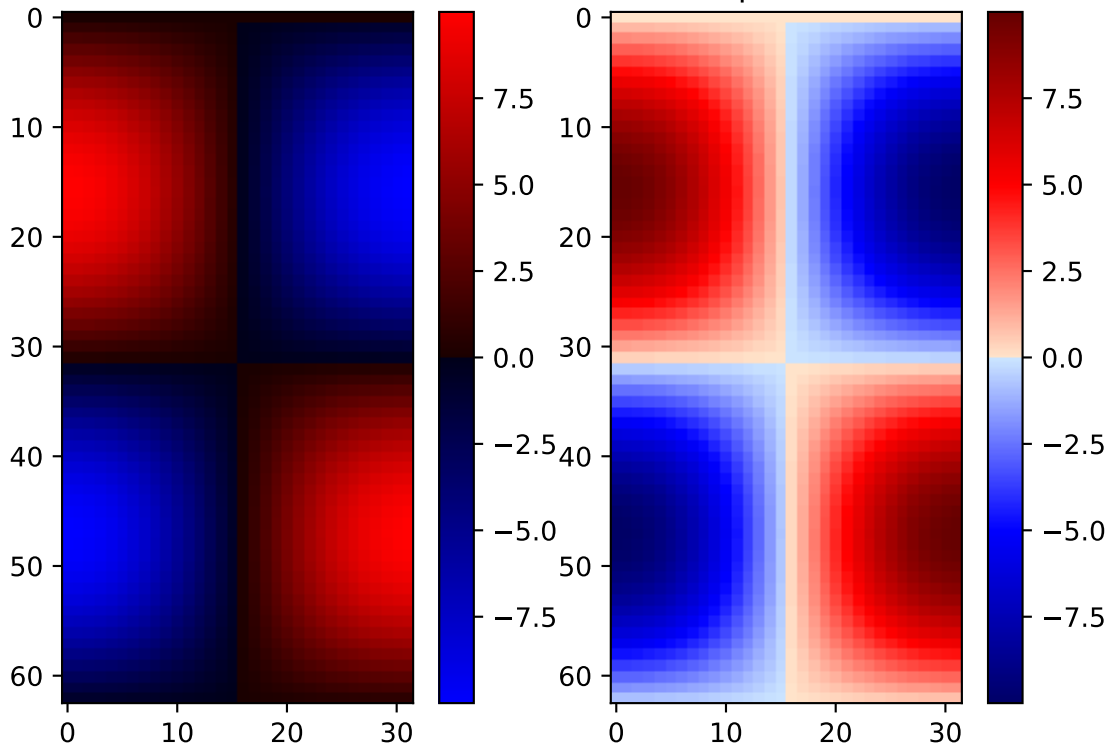

Varying alpha

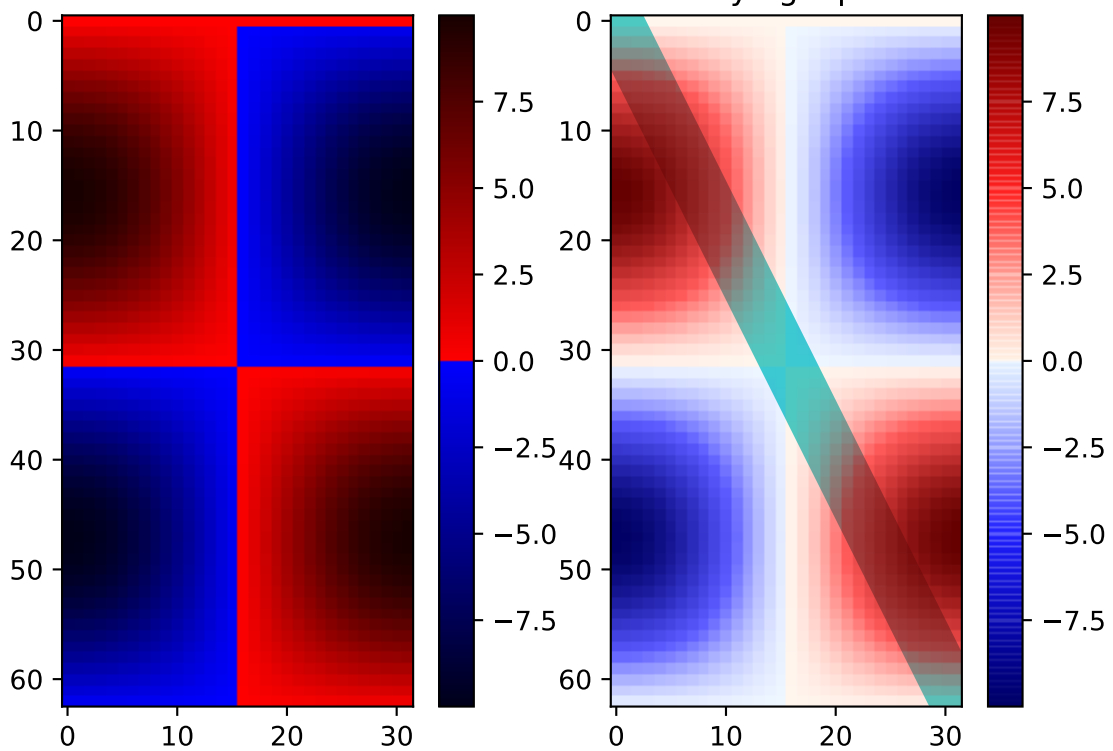

```

import numpy as np
import matplotlib.pyplot as plt
from matplotlib.colors import LinearSegmentedColormap

"""
Creating a colormap from a list of colors
-----
Creating a colormap from a list of colors can be done with the `from_list`
method of `LinearSegmentedColormap`. You must pass a list of RGB tuples that
define the mixture of colors from 0 to 1.

Creating custom colormaps
-----
It is also possible to create a custom mapping for a colormap. This is
accomplished by creating dictionary that specifies how the RGB channels
change from one end of the cmap to the other.

Example: suppose you want red to increase from 0 to 1 over the bottom
half, green to do the same over the middle half, and blue over the top
half. Then you would use:

cdict = {'red': ((0.0, 0.0, 0.0),
                (0.5, 1.0, 1.0),
                (1.0, 1.0, 1.0)),

         'green': ((0.0, 0.0, 0.0),
                  (0.25, 0.0, 0.0),
                  (0.75, 1.0, 1.0),
                  (1.0, 1.0, 1.0)),

         'blue': ((0.0, 0.0, 0.0),
                  (0.5, 0.0, 0.0),
                  (1.0, 1.0, 1.0))}

If, as in this example, there are no discontinuities in the r, g, and b
components, then it is quite simple: the second and third element of
each tuple, above, is the same--call it "y". The first element ("x")
defines interpolation intervals over the full range of 0 to 1, and it
must span that whole range. In other words, the values of x divide the
0-to-1 range into a set of segments, and y gives the end-point color
values for each segment.

Now consider the green. cdict['green'] is saying that for
0 <= x <= 0.25, y is zero; no green.
0.25 < x <= 0.75, y varies linearly from 0 to 1.
x > 0.75, y remains at 1, full green.

If there are discontinuities, then it is a little more complicated.
Label the 3 elements in each row in the cdict entry for a given color as
(x, y0, y1). Then for values of x between x[i] and x[i+1] the color
value is interpolated between y1[i] and y0[i+1].

```

Going back to the cookbook example, look at `cdict['red']`; because $y_0 \neq y_1$, it is saying that for x from 0 to 0.5, red increases from 0 to 1, but then it jumps down, so that for x from 0.5 to 1, red increases from 0.7 to 1. Green ramps from 0 to 1 as x goes from 0 to 0.5, then jumps back to 0, and ramps back to 1 as x goes from 0.5 to 1.

```
row i:   x  y0  y1
          /
          /
row i+1: x  y0  y1
```

Above is an attempt to show that for x in the range $x[i]$ to $x[i+1]$, the interpolation is between $y_1[i]$ and $y_0[i+1]$. So, $y_0[0]$ and $y_1[-1]$ are never used.

```
"""
# Make some illustrative fake data:

x = np.arange(0, np.pi, 0.1)
y = np.arange(0, 2*np.pi, 0.1)
X, Y = np.meshgrid(x, y)
Z = np.cos(X) * np.sin(Y) * 10

# --- Colormaps from a list ---

colors = [(1, 0, 0), (0, 1, 0), (0, 0, 1)] # R -> G -> B
n_bins = [3, 6, 10, 100] # Discretizes the interpolation into bins
cmap_name = 'my_list'
fig, axs = plt.subplots(2, 2, figsize=(6, 9))
fig.subplots_adjust(left=0.02, bottom=0.06, right=0.95, top=0.94, wspace=0.05)
for n_bin, ax in zip(n_bins, axs.ravel()):
    # Create the colormap
    cm = LinearSegmentedColormap.from_list(
        cmap_name, colors, N=n_bin)
    # Fewer bins will result in "coarser" colormap interpolation
    im = ax.imshow(Z, interpolation='nearest', origin='lower', cmap=cm)
    ax.set_title("N bins: %s" % n_bin)
    fig.colorbar(im, ax=ax)

# --- Custom colormaps ---

cdict1 = {'red': ((0.0, 0.0, 0.0),
                  (0.5, 0.0, 0.1),
                  (1.0, 1.0, 1.0)),

          'green': ((0.0, 0.0, 0.0),
                    (1.0, 0.0, 0.0)),

          'blue': ((0.0, 0.0, 1.0),
                   (0.5, 0.1, 0.0),
                   (1.0, 0.0, 0.0))
```

```

    }

cdict2 = {'red': ((0.0, 0.0, 0.0),
                 (0.5, 0.0, 1.0),
                 (1.0, 0.1, 1.0)),

          'green': ((0.0, 0.0, 0.0),
                   (1.0, 0.0, 0.0)),

          'blue': ((0.0, 0.0, 0.1),
                  (0.5, 1.0, 0.0),
                  (1.0, 0.0, 0.0))

          }

cdict3 = {'red': ((0.0, 0.0, 0.0),
                 (0.25, 0.0, 0.0),
                 (0.5, 0.8, 1.0),
                 (0.75, 1.0, 1.0),
                 (1.0, 0.4, 1.0)),

          'green': ((0.0, 0.0, 0.0),
                   (0.25, 0.0, 0.0),
                   (0.5, 0.9, 0.9),
                   (0.75, 0.0, 0.0),
                   (1.0, 0.0, 0.0)),

          'blue': ((0.0, 0.0, 0.4),
                  (0.25, 1.0, 1.0),
                  (0.5, 1.0, 0.8),
                  (0.75, 0.0, 0.0),
                  (1.0, 0.0, 0.0))

          }

# Make a modified version of cdict3 with some transparency
# in the middle of the range.
cdict4 = cdict3.copy()
cdict4['alpha'] = ((0.0, 1.0, 1.0),
                  # (0.25, 1.0, 1.0),
                  (0.5, 0.3, 0.3),
                  # (0.75, 1.0, 1.0),
                  (1.0, 1.0, 1.0))

# Now we will use this example to illustrate 3 ways of
# handling custom colormaps.
# First, the most direct and explicit:

blue_red1 = LinearSegmentedColormap('BlueRed1', cdict1)

# Second, create the map explicitly and register it.
# Like the first method, this method works with any kind
# of Colormap, not just
# a LinearSegmentedColormap:

```

```
blue_red2 = LinearSegmentedColormap('BlueRed2', cdict2)
plt.register_cmap(cmap=blue_red2)

# Third, for LinearSegmentedColormap only,
# leave everything to register_cmap:

plt.register_cmap(name='BlueRed3', data=cdict3) # optional lut kwarg
plt.register_cmap(name='BlueRedAlpha', data=cdict4)

# Make the figure:

fig, axs = plt.subplots(2, 2, figsize=(6, 9))
fig.subplots_adjust(left=0.02, bottom=0.06, right=0.95, top=0.94, wspace=0.05)

# Make 4 subplots:

im1 = axs[0, 0].imshow(Z, interpolation='nearest', cmap=blue_red1)
fig.colorbar(im1, ax=axs[0, 0])

cmap = plt.get_cmap('BlueRed2')
im2 = axs[1, 0].imshow(Z, interpolation='nearest', cmap=cmap)
fig.colorbar(im2, ax=axs[1, 0])

# Now we will set the third cmap as the default. One would
# not normally do this in the middle of a script like this;
# it is done here just to illustrate the method.

plt.rcParams['image.cmap'] = 'BlueRed3'

im3 = axs[0, 1].imshow(Z, interpolation='nearest')
fig.colorbar(im3, ax=axs[0, 1])
axs[0, 1].set_title("Alpha = 1")

# Or as yet another variation, we can replace the rcParams
# specification *before* the imshow with the following *after*
# imshow.
# This sets the new default *and* sets the colormap of the last
# image-like item plotted via pyplot, if any.
#

# Draw a line with low zorder so it will be behind the image.
axs[1, 1].plot([0, 10*np.pi], [0, 20*np.pi], color='c', lw=20, zorder=-1)

im4 = axs[1, 1].imshow(Z, interpolation='nearest')
fig.colorbar(im4, ax=axs[1, 1])

# Here it is: changing the colormap for the current image and its
# colorbar after they have been plotted.
im4.set_cmap('BlueRedAlpha')
axs[1, 1].set_title("Varying alpha")
#
```

```
fig.suptitle('Custom Blue-Red colormaps', fontsize=16)
plt.show()
```

Keywords: python, matplotlib, pylab, example, codex (see *Search examples*)

99.47 pylab_examples example code: custom_figure_class.py

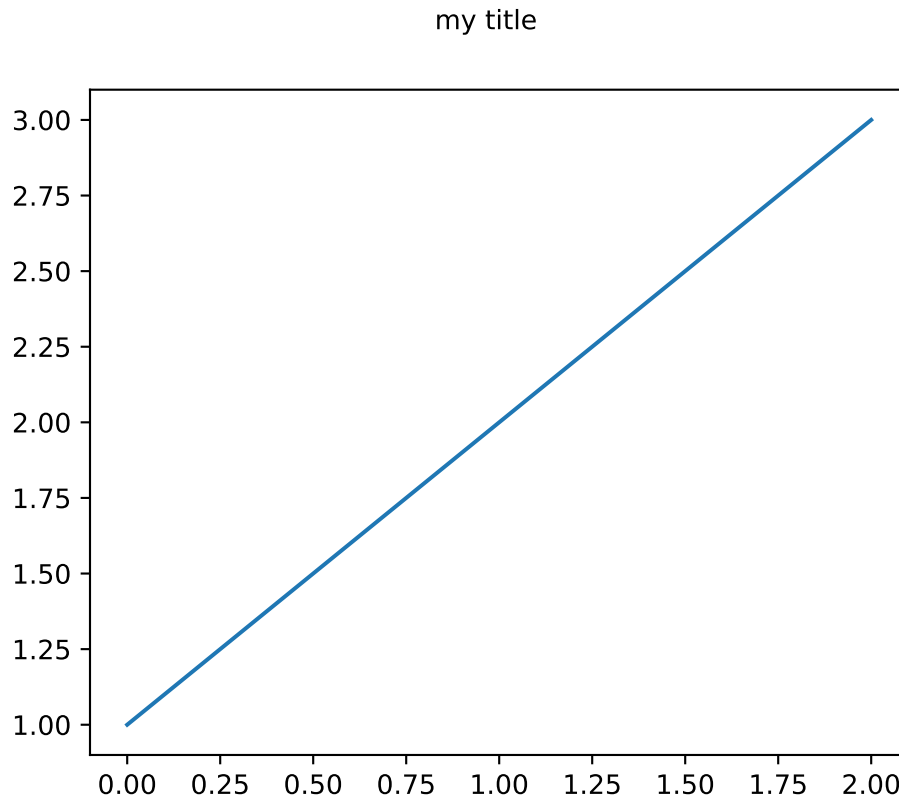

```
"""
You can pass a custom Figure constructor to figure if you want to derive from the
↳default Figure. This simple example creates a figure with a figure title
"""
from matplotlib.pyplot import figure, show
from matplotlib.figure import Figure

class MyFigure(Figure):
    def __init__(self, *args, **kwargs):
        """
        custom kwarg figtitle is a figure title
        """
        figtitle = kwargs.pop('figtitle', 'hi mom')
```

```
Figure.__init__(self, *args, **kwargs)
self.text(0.5, 0.95, figtitle, ha='center')

fig = figure(FigureClass=MyFigure, figtitle='my title')
ax = fig.add_subplot(111)
ax.plot([1, 2, 3])

show()
```

Keywords: python, matplotlib, pylab, example, codex (see *Search examples*)

99.48 pylab_examples example code: custom_ticker1.py

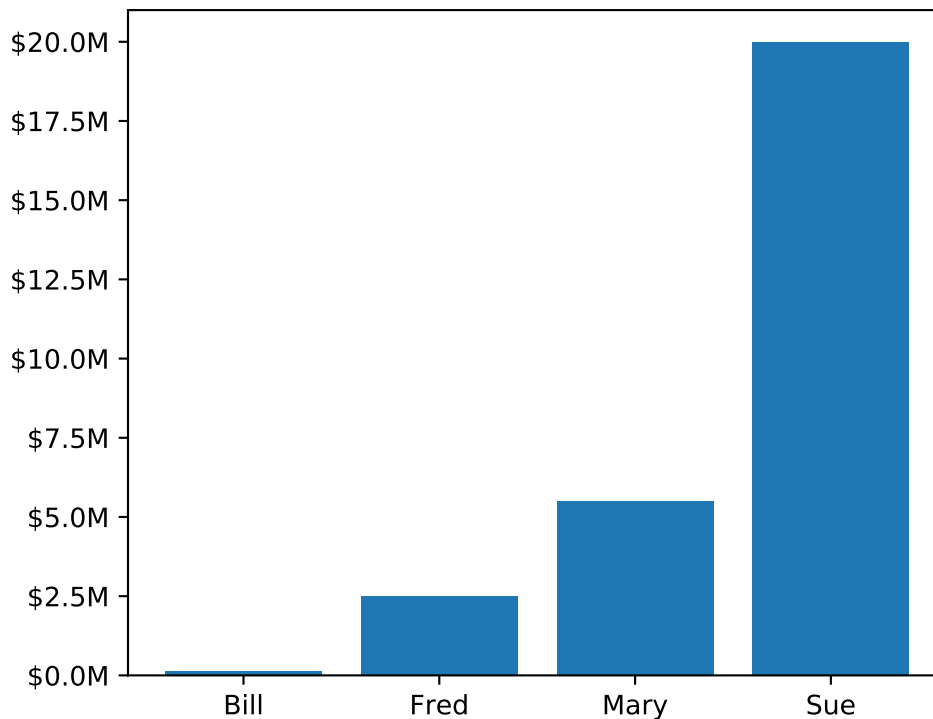

```
"""
The new ticker code was designed to explicitly support user customized
ticking. The documentation
http://matplotlib.org/matplotlib.ticker.html details this
process. That code defines a lot of preset tickers but was primarily
designed to be user extensible.
```

```
In this example a user defined function is used to format the ticks in
millions of dollars on the y axis
```

```
"""
from matplotlib.ticker import FuncFormatter
import matplotlib.pyplot as plt
import numpy as np

x = np.arange(4)
money = [1.5e5, 2.5e6, 5.5e6, 2.0e7]

def millions(x, pos):
    'The two args are the value and tick position'
    return '$%1.1fM' % (x*1e-6)

formatter = FuncFormatter(millions)

fig, ax = plt.subplots()
ax.yaxis.set_major_formatter(formatter)
plt.bar(x, money)
plt.xticks(x, ('Bill', 'Fred', 'Mary', 'Sue'))
plt.show()
```

Keywords: python, matplotlib, pylab, example, codex (see [Search examples](#))

99.49 pylab_examples example code: customize_rc.py

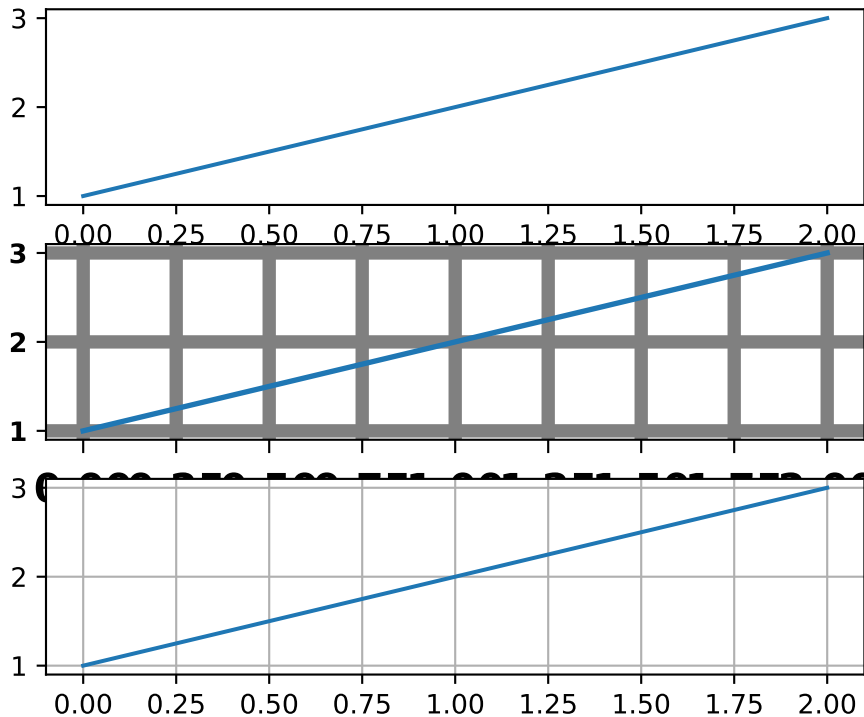

```

"""
I'm not trying to make a good looking figure here, but just to show
some examples of customizing rc params on the fly

If you like to work interactively, and need to create different sets
of defaults for figures (e.g., one set of defaults for publication, one
set for interactive exploration), you may want to define some
functions in a custom module that set the defaults, e.g.,

def set_pub():
    rc('font', weight='bold')      # bold fonts are easier to see
    rc('tick', labelsizes=15)     # tick labels bigger
    rc('lines', lw=1, color='k')  # thicker black lines (no budget for color!)
    rc('grid', c='0.5', ls='-', lw=0.5) # solid gray grid lines
    rc('savefig', dpi=300)        # higher res outputs

Then as you are working interactively, you just need to do

>>> set_pub()
>>> subplot(111)

```



```
>>> plot([1,2,3])
>>> savefig('myfig')
>>> rcdefaults() # restore the defaults

"""
import matplotlib.pyplot as plt

plt.subplot(311)
plt.plot([1, 2, 3])

# the axes attributes need to be set before the call to subplot
plt.rc('font', weight='bold')
plt.rc('xtick.major', size=5, pad=7)
plt.rc('xtick', labelsize=15)

# using aliases for color, linestyle and linewidth; gray, solid, thick
plt.rc('grid', c='0.5', ls='-', lw=5)
plt.rc('lines', lw=2, color='g')
plt.subplot(312)

plt.plot([1, 2, 3])
plt.grid(True)

plt.rcdefaults()
plt.subplot(313)
plt.plot([1, 2, 3])
plt.grid(True)
plt.show()
```

Keywords: python, matplotlib, pylab, example, codex (see [Search examples](#))

99.50 pylab_examples example code: dashpointlabel.py

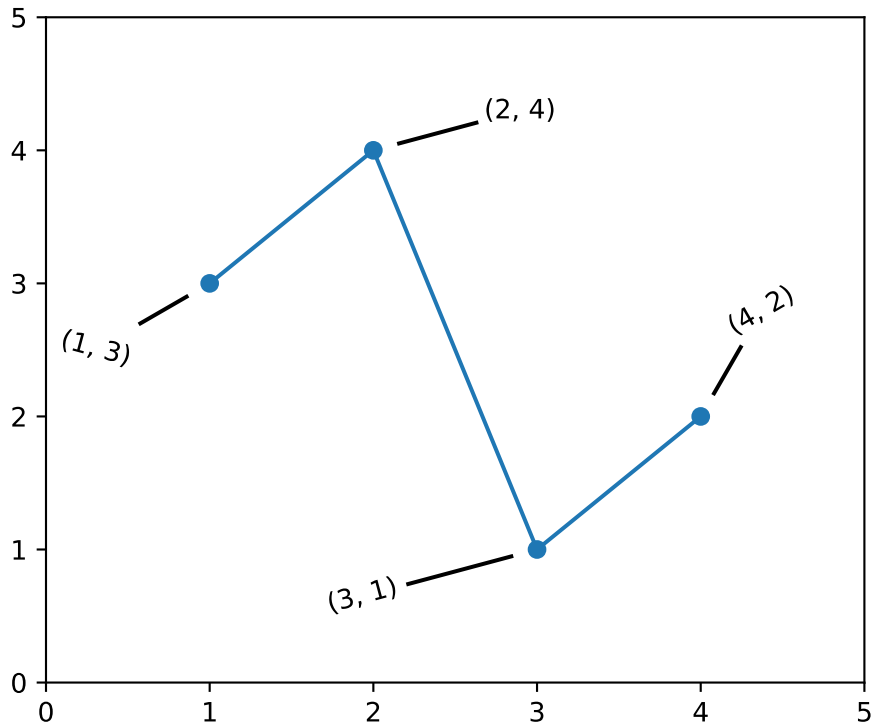

```
import matplotlib.pyplot as plt

DATA = ((1, 3),
        (2, 4),
        (3, 1),
        (4, 2))
# dash_style =
#   direction, length, (text)rotation, dashrotation, push
# (The parameters are varied to show their effects,
# not for visual appeal).
dash_style = (
    (0, 20, -15, 30, 10),
    (1, 30, 0, 15, 10),
    (0, 40, 15, 15, 10),
    (1, 20, 30, 60, 10),
)

fig, ax = plt.subplots()

(x, y) = zip(*DATA)
ax.plot(x, y, marker='o')
for i in range(len(DATA)):
```

```

(x, y) = DATA[i]
(dd, dl, r, dr, dp) = dash_style[i]
#print('dashlen call %d' % dl)
t = ax.text(x, y, str((x, y)), withdash=True,
           dashdirection=dd,
           dashlength=dl,
           rotation=r,
           dashrotation=dr,
           dashpush=dp,
           )

ax.set_xlim((0.0, 5.0))
ax.set_ylim((0.0, 5.0))

plt.show()

```

Keywords: python, matplotlib, pylab, example, codex (see [Search examples](#))

99.51 pylab_examples example code: date_demo_convert.py

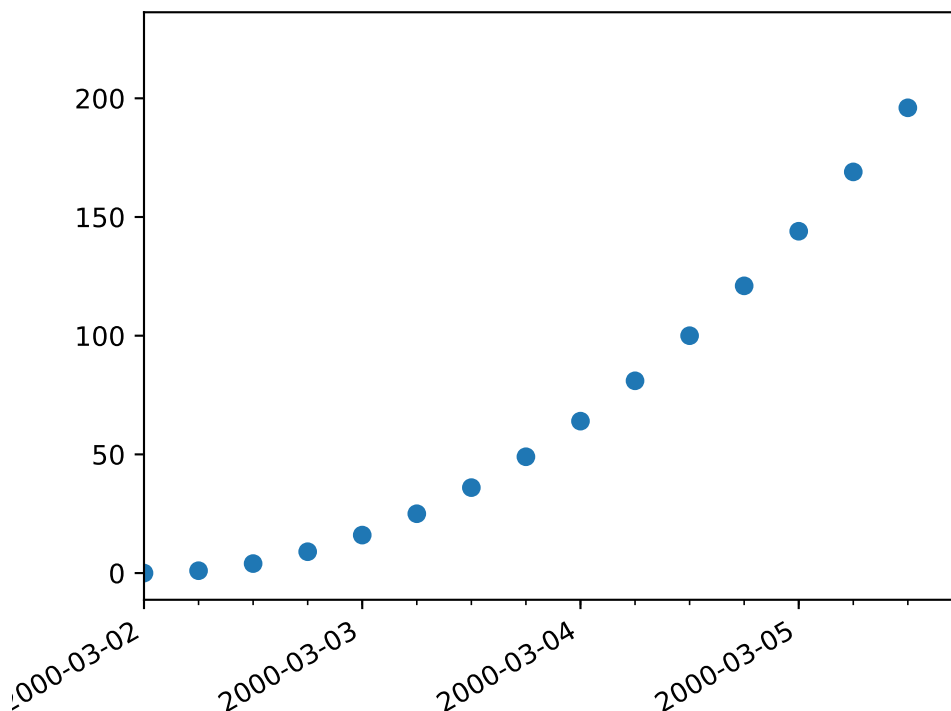

```

import datetime
import matplotlib.pyplot as plt

```

```
from matplotlib.dates import DayLocator, HourLocator, DateFormatter, drange
from numpy import arange

date1 = datetime.datetime(2000, 3, 2)
date2 = datetime.datetime(2000, 3, 6)
delta = datetime.timedelta(hours=6)
dates = drange(date1, date2, delta)

y = arange(len(dates)*1.0)

fig, ax = plt.subplots()
ax.plot_date(dates, y*y)

# this is superfluous, since the autoscaler should get it right, but
# use date2num and num2date to convert between dates and floats if
# you want; both date2num and num2date convert an instance or sequence
ax.set_xlim(dates[0], dates[-1])

# The hour locator takes the hour or sequence of hours you want to
# tick, not the base multiple

ax.xaxis.set_major_locator(DayLocator())
ax.xaxis.set_minor_locator(HourLocator(arange(0, 25, 6)))
ax.xaxis.set_major_formatter(DateFormatter('%Y-%m-%d'))

ax.fmt_xdata = DateFormatter('%Y-%m-%d %H:%M:%S')
fig.autofmt_xdate()

plt.show()
```

Keywords: python, matplotlib, pylab, example, codex (see [Search examples](#))

99.52 pylab_examples example code: date_demo_rrule.py

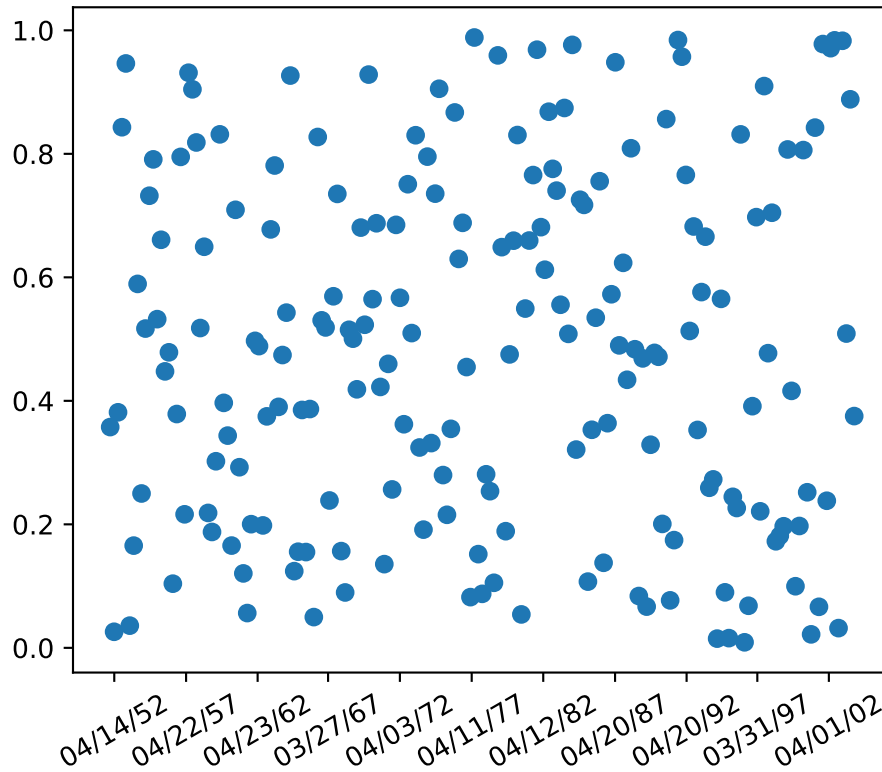

```

"""
Show how to use an rrule instance to make a custom date ticker - here
we put a tick mark on every 5th easter

See https://moin.conectiva.com.br/DateUtil for help with rrules
"""
import matplotlib.pyplot as plt
from matplotlib.dates import YEARLY, DateFormatter, rrulewrapper, RRuleLocator, drange
import numpy as np
import datetime

# tick every 5th easter
rule = rrulewrapper(YEARLY, byeaster=1, interval=5)
loc = RRuleLocator(rule)
formatter = DateFormatter('%m/%d/%y')
date1 = datetime.date(1952, 1, 1)
date2 = datetime.date(2004, 4, 12)
delta = datetime.timedelta(days=100)

dates = drange(date1, date2, delta)
s = np.random.rand(len(dates)) # make up some random y values

```

```

fig, ax = plt.subplots()
plt.plot_date(dates, s)
ax.xaxis.set_major_locator(loc)
ax.xaxis.set_major_formatter(formatter)
labels = ax.get_xticklabels()
plt.setp(labels, rotation=30, fontsize=10)

plt.show()

```

Keywords: python, matplotlib, pylab, example, codex (see *Search examples*)

99.53 pylab_examples example code: date_index_formatter.py

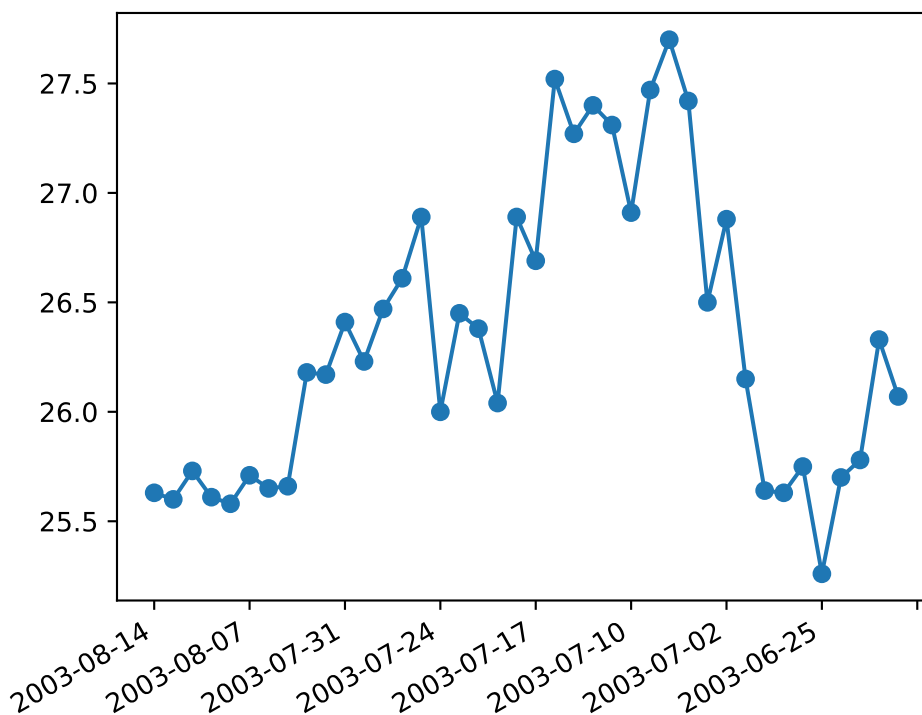

```

"""
When plotting daily data, a frequent request is to plot the data
ignoring skips, e.g., no extra spaces for weekends. This is particularly
common in financial time series, when you may have data for M-F and
not Sat, Sun and you don't want gaps in the x axis. The approach is
to simply use the integer index for the xdata and a custom tick
formatter to get the appropriate date string for a given index.
"""

```

```
from __future__ import print_function
import numpy as np
from matplotlib.mlab import csv2rec
import matplotlib.pyplot as plt
import matplotlib.cbook as cbook
from matplotlib.ticker import Formatter

datafile = cbook.get_sample_data('msft.csv', asfileobj=False)
print('loading %s' % datafile)
r = csv2rec(datafile)[-40:]

class MyFormatter(Formatter):
    def __init__(self, dates, fmt='%Y-%m-%d'):
        self.dates = dates
        self.fmt = fmt

    def __call__(self, x, pos=0):
        'Return the label for time x at position pos'
        ind = int(np.round(x))
        if ind >= len(self.dates) or ind < 0:
            return ''

        return self.dates[ind].strftime(self.fmt)

formatter = MyFormatter(r.date)

fig, ax = plt.subplots()
ax.xaxis.set_major_formatter(formatter)
ax.plot(np.arange(len(r)), r.close, 'o-')
fig.autofmt_xdate()
plt.show()
```

Keywords: python, matplotlib, pylab, example, codex (see [Search examples](#))

99.54 pylab_examples example code: demo_agg_filter.py

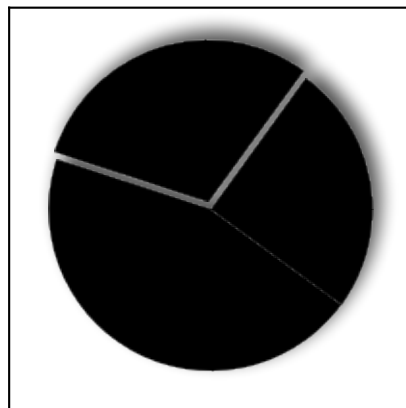
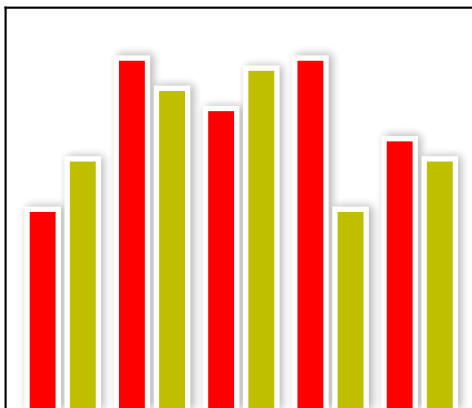
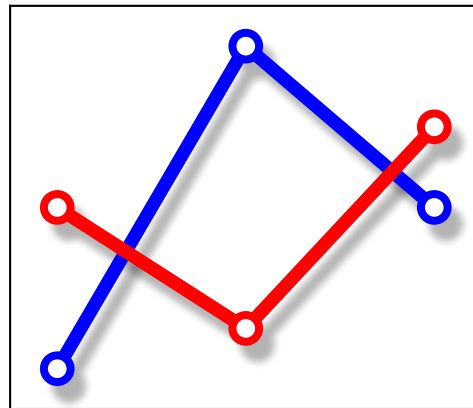
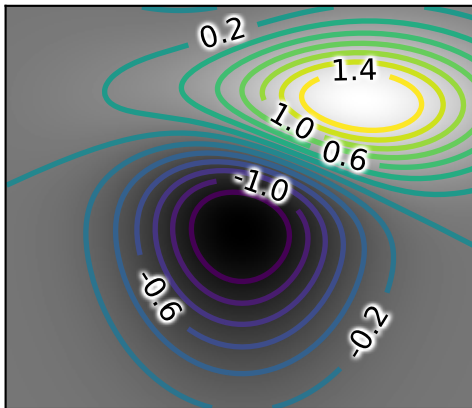

```
import matplotlib.pyplot as plt

import numpy as np
import matplotlib.cm as cm
import matplotlib.mlab as mlab

def smooth1d(x, window_len):
    # copied from http://www.scipy.org/Cookbook/SignalSmooth

    s = np.r_[2*x[0] - x[window_len:1:-1], x, 2*x[-1] - x[-1:-window_len:-1]]
    w = np.hanning(window_len)
    y = np.convolve(w/w.sum(), s, mode='same')
```



```

    return y[window_len-1:-window_len+1]

def smooth2d(A, sigma=3):

    window_len = max(int(sigma), 3)*2 + 1
    A1 = np.array([smooth1d(x, window_len) for x in np.asarray(A)])
    A2 = np.transpose(A1)
    A3 = np.array([smooth1d(x, window_len) for x in A2])
    A4 = np.transpose(A3)

    return A4

class BaseFilter(object):
    def prepare_image(self, src_image, dpi, pad):
        ny, nx, depth = src_image.shape
        #tgt_image = np.zeros([pad*2+ny, pad*2+nx, depth], dtype="d")
        padded_src = np.zeros([pad*2 + ny, pad*2 + nx, depth], dtype="d")
        padded_src[pad:-pad, pad:-pad, :] = src_image[:, :, :]

        return padded_src # , tgt_image

    def get_pad(self, dpi):
        return 0

    def __call__(self, im, dpi):
        pad = self.get_pad(dpi)
        padded_src = self.prepare_image(im, dpi, pad)
        tgt_image = self.process_image(padded_src, dpi)
        return tgt_image, -pad, -pad

class OffsetFilter(BaseFilter):
    def __init__(self, offsets=None):
        if offsets is None:
            self.offsets = (0, 0)
        else:
            self.offsets = offsets

    def get_pad(self, dpi):
        return int(max(*self.offsets)/72.*dpi)

    def process_image(self, padded_src, dpi):
        ox, oy = self.offsets
        a1 = np.roll(padded_src, int(ox/72.*dpi), axis=1)
        a2 = np.roll(a1, -int(oy/72.*dpi), axis=0)
        return a2

class GaussianFilter(BaseFilter):
    "simple gauss filter"

```

```

def __init__(self, sigma, alpha=0.5, color=None):
    self.sigma = sigma
    self.alpha = alpha
    if color is None:
        self.color = (0, 0, 0)
    else:
        self.color = color

def get_pad(self, dpi):
    return int(self.sigma*3/72.*dpi)

def process_image(self, padded_src, dpi):
    #offsetx, offsety = int(self.offsets[0]), int(self.offsets[1])
    tgt_image = np.zeros_like(padded_src)
    aa = smooth2d(padded_src[:, :, -1]*self.alpha,
                  self.sigma/72.*dpi)
    tgt_image[:, :, -1] = aa
    tgt_image[:, :, :-1] = self.color
    return tgt_image

class DropShadowFilter(BaseFilter):
    def __init__(self, sigma, alpha=0.3, color=None, offsets=None):
        self.gauss_filter = GaussianFilter(sigma, alpha, color)
        self.offset_filter = OffsetFilter(offsets)

    def get_pad(self, dpi):
        return max(self.gauss_filter.get_pad(dpi),
                   self.offset_filter.get_pad(dpi))

    def process_image(self, padded_src, dpi):
        t1 = self.gauss_filter.process_image(padded_src, dpi)
        t2 = self.offset_filter.process_image(t1, dpi)
        return t2

from matplotlib.colors import LightSource

class LightFilter(BaseFilter):
    "simple gauss filter"

    def __init__(self, sigma, fraction=0.5):
        self.gauss_filter = GaussianFilter(sigma, alpha=1)
        self.light_source = LightSource()
        self.fraction = fraction

    def get_pad(self, dpi):
        return self.gauss_filter.get_pad(dpi)

    def process_image(self, padded_src, dpi):
        t1 = self.gauss_filter.process_image(padded_src, dpi)
        elevation = t1[:, :, 3]

```

```

    rgb = padded_src[:, :, :3]

    rgb2 = self.light_source.shade_rgb(rgb, elevation,
                                       fraction=self.fraction)

    tgt = np.empty_like(padded_src)
    tgt[:, :, :3] = rgb2
    tgt[:, :, 3] = padded_src[:, :, 3]

    return tgt

class GrowFilter(BaseFilter):
    "enlarge the area"

    def __init__(self, pixels, color=None):
        self.pixels = pixels
        if color is None:
            self.color = (1, 1, 1)
        else:
            self.color = color

    def __call__(self, im, dpi):
        pad = self.pixels
        ny, nx, depth = im.shape
        new_im = np.empty([pad*2 + ny, pad*2 + nx, depth], dtype="d")
        alpha = new_im[:, :, 3]
        alpha.fill(0)
        alpha[pad:-pad, pad:-pad] = im[:, :, -1]
        alpha2 = np.clip(smooth2d(alpha, self.pixels/72.*dpi) * 5, 0, 1)
        new_im[:, :, -1] = alpha2
        new_im[:, :, :-1] = self.color
        offsetx, offsety = -pad, -pad

        return new_im, offsetx, offsety

from matplotlib.artist import Artist

class FilteredArtistList(Artist):
    """
    A simple container to draw filtered artist.
    """

    def __init__(self, artist_list, filter):
        self._artist_list = artist_list
        self._filter = filter
        Artist.__init__(self)

    def draw(self, renderer):
        renderer.start_rasterizing()
        renderer.start_filter()

```

```

    for a in self._artist_list:
        a.draw(renderer)
    renderer.stop_filter(self._filter)
    renderer.stop_rasterizing()

import matplotlib.transforms as mtransforms

def filtered_text(ax):
    # mostly copied from contour_demo.py

    # prepare image
    delta = 0.025
    x = np.arange(-3.0, 3.0, delta)
    y = np.arange(-2.0, 2.0, delta)
    X, Y = np.meshgrid(x, y)
    Z1 = mlab.bivariate_normal(X, Y, 1.0, 1.0, 0.0, 0.0)
    Z2 = mlab.bivariate_normal(X, Y, 1.5, 0.5, 1, 1)
    # difference of Gaussians
    Z = 10.0 * (Z2 - Z1)

    # draw
    im = ax.imshow(Z, interpolation='bilinear', origin='lower',
                  cmap=cm.gray, extent=(-3, 3, -2, 2))
    levels = np.arange(-1.2, 1.6, 0.2)
    CS = ax.contour(Z, levels,
                   origin='lower',
                   linewidths=2,
                   extent=(-3, 3, -2, 2))

    ax.set_aspect("auto")

    # contour label
    cl = ax.clabel(CS, levels[1::2], # label every second level
                  inline=1,
                  fmt='%1.1f',
                  fontsize=11)

    # change clable color to black
    from matplotlib.path_effects import Normal
    for t in cl:
        t.set_color("k")
        # to force TextPath (i.e., same font in all backends)
        t.set_path_effects([Normal()])

    # Add white glows to improve visibility of labels.
    white_glows = FilteredArtistList(cl, GrowFilter(3))
    ax.add_artist(white_glows)
    white_glows.set_zorder(cl[0].get_zorder() - 0.1)

    ax.xaxis.set_visible(False)
    ax.yaxis.set_visible(False)

```

```

def drop_shadow_line(ax):
    # copied from examples/misc/svg_filter_line.py

    # draw lines
    l1, = ax.plot([0.1, 0.5, 0.9], [0.1, 0.9, 0.5], "bo-",
                  mec="b", mfc="w", lw=5, mew=3, ms=10, label="Line 1")
    l2, = ax.plot([0.1, 0.5, 0.9], [0.5, 0.2, 0.7], "ro-",
                  mec="r", mfc="w", lw=5, mew=3, ms=10, label="Line 1")

    gauss = DropShadowFilter(4)

    for l in [l1, l2]:

        # draw shadows with same lines with slight offset.

        xx = l.get_xdata()
        yy = l.get_ydata()
        shadow, = ax.plot(xx, yy)
        shadow.update_from(l)

        # offset transform
        ot = mtransforms.offset_copy(l.get_transform(), ax.figure,
                                    x=4.0, y=-6.0, units='points')

        shadow.set_transform(ot)

        # adjust zorder of the shadow lines so that it is drawn below the
        # original lines
        shadow.set_zorder(l.get_zorder() - 0.5)
        shadow.set_agg_filter(gauss)
        shadow.set_rasterized(True) # to support mixed-mode renderers

    ax.set_xlim(0., 1.)
    ax.set_ylim(0., 1.)

    ax.xaxis.set_visible(False)
    ax.yaxis.set_visible(False)

def drop_shadow_patches(ax):
    # Copied from barchart_demo.py
    N = 5
    menMeans = (20, 35, 30, 35, 27)

    ind = np.arange(N) # the x locations for the groups
    width = 0.35 # the width of the bars

    rects1 = ax.bar(ind, menMeans, width, color='r', ec="w", lw=2)

    womenMeans = (25, 32, 34, 20, 25)
    rects2 = ax.bar(ind + width + 0.1, womenMeans, width, color='y', ec="w", lw=2)

```

```

#gauss = GaussianFilter(1.5, offsets=(1,1), )
gauss = DropShadowFilter(5, offsets=(1, 1), )
shadow = FilteredArtistList(rects1 + rects2, gauss)
ax.add_artist(shadow)
shadow.set_zorder(rects1[0].get_zorder() - 0.1)

ax.set_ylim(0, 40)

ax.xaxis.set_visible(False)
ax.yaxis.set_visible(False)

def light_filter_pie(ax):
    fracs = [15, 30, 45, 10]
    explode = (0, 0.05, 0, 0)
    pies = ax.pie(fracs, explode=explode)
    ax.patches.set_visible(True)

    light_filter = LightFilter(9)
    for p in pies[0]:
        p.set_agg_filter(light_filter)
        p.set_rasterized(True) # to support mixed-mode renderers
        p.set(ec="none",
              lw=2)

    gauss = DropShadowFilter(9, offsets=(3, 4), alpha=0.7)
    shadow = FilteredArtistList(pies[0], gauss)
    ax.add_artist(shadow)
    shadow.set_zorder(pies[0][0].get_zorder() - 0.1)

if 1:

    plt.figure(1, figsize=(6, 6))
    plt.subplots_adjust(left=0.05, right=0.95)

    ax = plt.subplot(221)
    filtered_text(ax)

    ax = plt.subplot(222)
    drop_shadow_line(ax)

    ax = plt.subplot(223)
    drop_shadow_patches(ax)

    ax = plt.subplot(224)
    ax.set_aspect(1)
    light_filter_pie(ax)
    ax.set_frame_on(True)

    plt.show()

```

Keywords: python, matplotlib, pylab, example, codex (see *Search examples*)

99.55 pylab_examples example code: demo_annotation_box.py

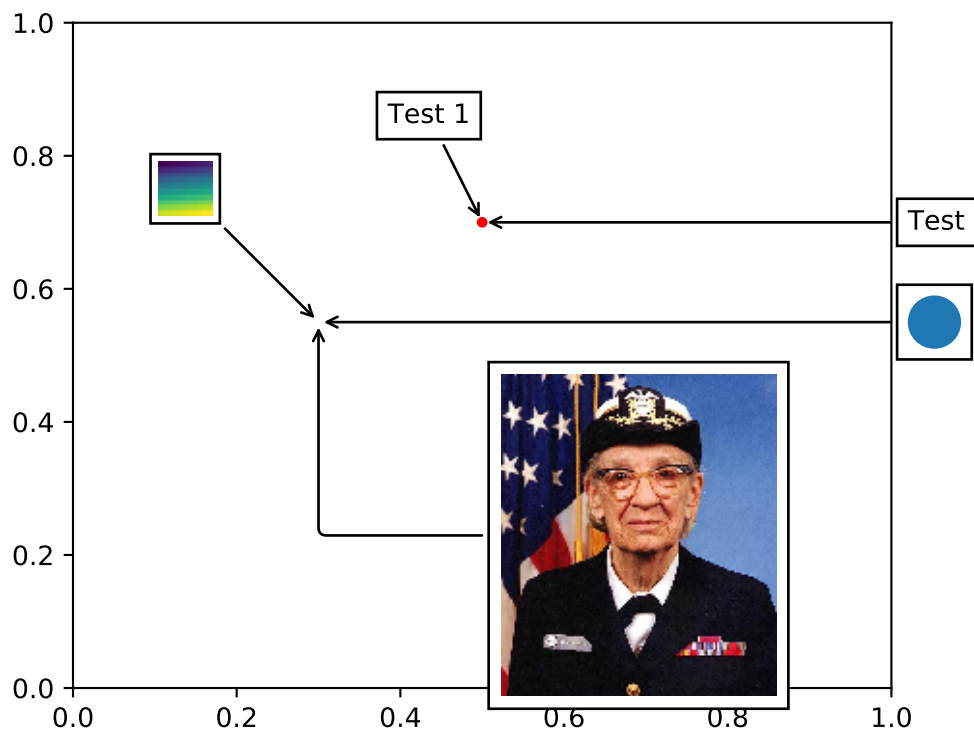

```
import matplotlib.pyplot as plt
import numpy as np

from matplotlib.patches import Circle
from matplotlib.offsetbox import (TextArea, DrawingArea, OffsetImage,
                                  AnnotationBbox)
from matplotlib.cbook import get_sample_data

if 1:
    fig, ax = plt.subplots()

    # Define a 1st position to annotate (display it with a marker)
    xy = (0.5, 0.7)
    ax.plot(xy[0], xy[1], ".r")

    # Annotate the 1st position with a text box ('Test 1')
    offsetbox = TextArea("Test 1", minimumdescent=False)
```

```
ab = AnnotationBbox(offsetbox, xy,
                    xybox=(-20, 40),
                    xycoords='data',
                    boxcoords="offset points",
                    arrowprops=dict(arrowstyle="->"))
ax.add_artist(ab)

# Annotate the 1st position with another text box ('Test')
offsetbox = TextArea("Test", minimumdescent=False)

ab = AnnotationBbox(offsetbox, xy,
                    xybox=(1.02, xy[1]),
                    xycoords='data',
                    boxcoords=("axes fraction", "data"),
                    box_alignment=(0., 0.5),
                    arrowprops=dict(arrowstyle="->"))
ax.add_artist(ab)

# Define a 2nd position to annotate (don't display with a marker this time)
xy = [0.3, 0.55]

# Annotate the 2nd position with a circle patch
da = DrawingArea(20, 20, 0, 0)
p = Circle((10, 10), 10)
da.add_artist(p)

ab = AnnotationBbox(da, xy,
                    xybox=(1.02, xy[1]),
                    xycoords='data',
                    boxcoords=("axes fraction", "data"),
                    box_alignment=(0., 0.5),
                    arrowprops=dict(arrowstyle="->"))

ax.add_artist(ab)

# Annotate the 2nd position with an image (a generated array of pixels)
arr = np.arange(100).reshape((10, 10))
im = OffsetImage(arr, zoom=2)
im.image.axes = ax

ab = AnnotationBbox(im, xy,
                    xybox=(-50., 50.),
                    xycoords='data',
                    boxcoords="offset points",
                    pad=0.3,
                    arrowprops=dict(arrowstyle="->"))

ax.add_artist(ab)

# Annotate the 2nd position with another image (a Grace Hopper portrait)
fn = get_sample_data("grace_hopper.png", asfileobj=False)
arr_img = plt.imread(fn, format='png')
```



```
imagebox = OffsetImage(arr_img, zoom=0.2)
imagebox.image.axes = ax

ab = AnnotationBbox(imagebox, xy,
                    xybox=(120., -80.),
                    xycoords='data',
                    boxcoords="offset points",
                    pad=0.5,
                    arrowprops=dict(
                        arrowstyle="->",
                        connectionstyle="angle,angleA=0,angleB=90,rad=3")
                    )

ax.add_artist(ab)

# Fix the display limits to see everything
ax.set_xlim(0, 1)
ax.set_ylim(0, 1)

plt.show()
```

Keywords: python, matplotlib, pylab, example, codex (see [Search examples](#))

99.56 pylab_examples example code: demo_bboximage.py

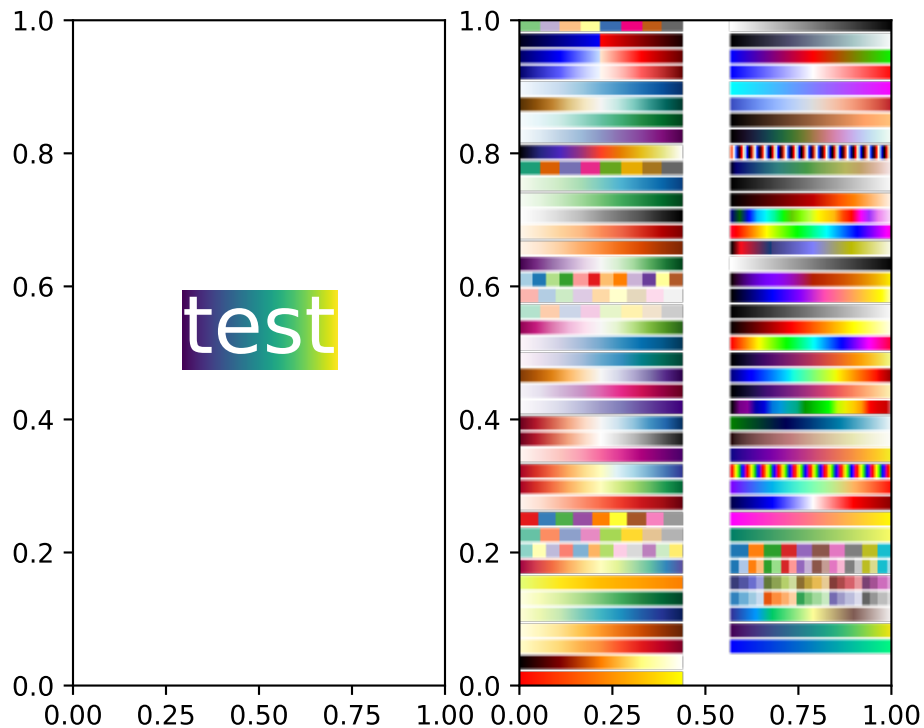

```

import matplotlib.pyplot as plt
import numpy as np
from matplotlib.image import BboxImage
from matplotlib.transforms import Bbox, TransformedBbox

if __name__ == "__main__":

    fig = plt.figure(1)
    ax = plt.subplot(121)

    txt = ax.text(0.5, 0.5, "test", size=30, ha="center", color="w")
    kwargs = dict()

    bbox_image = BboxImage(txt.get_window_extent,
                            norm=None,
                            origin=None,
                            clip_on=False,
                            **kwargs
                            )
    a = np.arange(256).reshape(1, 256)/256.
    bbox_image.set_data(a)
    ax.add_artist(bbox_image)

```

```

ax = plt.subplot(122)
a = np.linspace(0, 1, 256).reshape(1, -1)
a = np.vstack((a, a))

maps = sorted(
    m for m in plt.cm.cmap_d
    if not m.endswith("_r") and # Skip reversed colormaps.
    not m.startswith(('spectral', 'Vega')) # Skip deprecated colormaps.
)

#fig.subplots_adjust(top=0.99, bottom=0.01, left=0.2, right=0.99)

ncol = 2
nrow = len(maps)//ncol + 1

xpad_fraction = 0.3
dx = 1./(ncol + xpad_fraction*(ncol - 1))

ypad_fraction = 0.3
dy = 1./(nrow + ypad_fraction*(nrow - 1))

for i, m in enumerate(maps):
    ix, iy = divmod(i, nrow)
    #plt.figimage(a, 10, i*10, cmap=plt.get_cmap(m), origin='lower')
    bbox0 = Bbox.from_bounds(ix*dx*(1 + xpad_fraction),
                            1. - iy*dy*(1 + ypad_fraction) - dy,
                            dx, dy)
    bbox = TransformedBbox(bbox0, ax.transAxes)

    bbox_image = BboxImage(bbox,
                           cmap=plt.get_cmap(m),
                           norm=None,
                           origin=None,
                           **kwargs
                           )

    bbox_image.set_data(a)
    ax.add_artist(bbox_image)

plt.draw()
plt.show()

```

Keywords: python, matplotlib, pylab, example, codex (see [Search examples](#))

99.57 pylab_examples example code: demo_ribbon_box.py

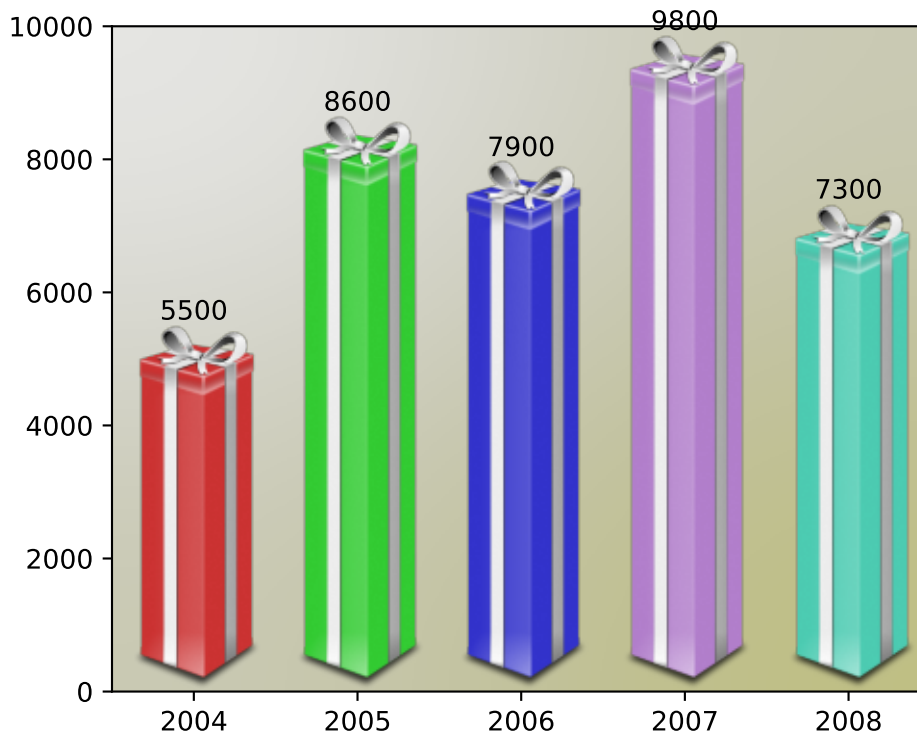

```
import matplotlib.pyplot as plt
import numpy as np
from matplotlib.image import BboxImage

from matplotlib._png import read_png
import matplotlib.colors
from matplotlib.cbook import get_sample_data

class RibbonBox(object):

    original_image = read_png(get_sample_data("Minduka_Present_Blue_Pack.png",
                                              asfileobj=False))

    cut_location = 70
    b_and_h = original_image[:, :, 2]
    color = original_image[:, :, 2] - original_image[:, :, 0]
    alpha = original_image[:, :, 3]
    nx = original_image.shape[1]

    def __init__(self, color):
        rgb = matplotlib.colors.to_rgba(color)[:3]
```

```

        im = np.empty(self.original_image.shape,
                      self.original_image.dtype)

        im[:, :, :3] = self.b_and_h[:, :, np.newaxis]
        im[:, :, :3] -= self.color[:, :, np.newaxis]*(1. - np.array(rgb))
        im[:, :, 3] = self.alpha

        self.im = im

    def get_stretched_image(self, stretch_factor):
        stretch_factor = max(stretch_factor, 1)
        ny, nx, nch = self.im.shape
        ny2 = int(ny*stretch_factor)

        stretched_image = np.empty((ny2, nx, nch),
                                   self.im.dtype)
        cut = self.im[self.cut_location, :, :]
        stretched_image[:, :, :] = cut
        stretched_image[:self.cut_location, :, :] = \
            self.im[:self.cut_location, :, :]
        stretched_image[-(ny - self.cut_location):, :, :] = \
            self.im[-(ny - self.cut_location):, :, :]

        self._cached_im = stretched_image
        return stretched_image

class RibbonBoxImage(BboxImage):
    zorder = 1

    def __init__(self, bbox, color,
                 cmap=None,
                 norm=None,
                 interpolation=None,
                 origin=None,
                 filternorm=1,
                 filterrad=4.0,
                 resample=False,
                 **kwargs
                 ):

        BboxImage.__init__(self, bbox,
                           cmap=cmap,
                           norm=norm,
                           interpolation=interpolation,
                           origin=origin,
                           filternorm=filternorm,
                           filterrad=filterrad,
                           resample=resample,
                           **kwargs
                           )

        self._ribbonbox = RibbonBox(color)

```

```

        self._cached_ny = None

    def draw(self, renderer, *args, **kwargs):

        bbox = self.get_window_extent(renderer)
        stretch_factor = bbox.height / bbox.width

        ny = int(stretch_factor*self._ribbonbox.nx)
        if self._cached_ny != ny:
            arr = self._ribbonbox.get_stretched_image(stretch_factor)
            self.set_array(arr)
            self._cached_ny = ny

        BboxImage.draw(self, renderer, *args, **kwargs)

if 1:
    from matplotlib.transforms import Bbox, TransformedBbox
    from matplotlib.ticker import ScalarFormatter

    fig, ax = plt.subplots()

    years = np.arange(2004, 2009)
    box_colors = [(0.8, 0.2, 0.2),
                  (0.2, 0.8, 0.2),
                  (0.2, 0.2, 0.8),
                  (0.7, 0.5, 0.8),
                  (0.3, 0.8, 0.7),
                  ]
    heights = np.random.random(years.shape) * 7000 + 3000

    fmt = ScalarFormatter(useOffset=False)
    ax.xaxis.set_major_formatter(fmt)

    for year, h, bc in zip(years, heights, box_colors):
        bbox0 = Bbox.from_extents(year - 0.4, 0., year + 0.4, h)
        bbox = TransformedBbox(bbox0, ax.transData)
        rb_patch = RibbonBoxImage(bbox, bc, interpolation="bicubic")

        ax.add_artist(rb_patch)

        ax.annotate(r"%d" % (int(h/100.)*100),
                    (year, h), va="bottom", ha="center")

    patch_gradient = BboxImage(ax.bbox,
                               interpolation="bicubic",
                               zorder=0.1,
                               )
    gradient = np.zeros((2, 2, 4), dtype=np.float)
    gradient[:, :, :3] = [1, 1, 0.]
    gradient[:, :, 3] = [[0.1, 0.3], [0.3, 0.5]] # alpha channel
    patch_gradient.set_array(gradient)
    ax.add_artist(patch_gradient)

```

```

ax.set_xlim(years[0] - 0.5, years[-1] + 0.5)
ax.set_ylim(0, 100000)

fig.savefig('ribbon_box.png')
plt.show()

```

Keywords: python, matplotlib, pylab, example, codex (see [Search examples](#))

99.58 pylab_examples example code: demo_text_path.py

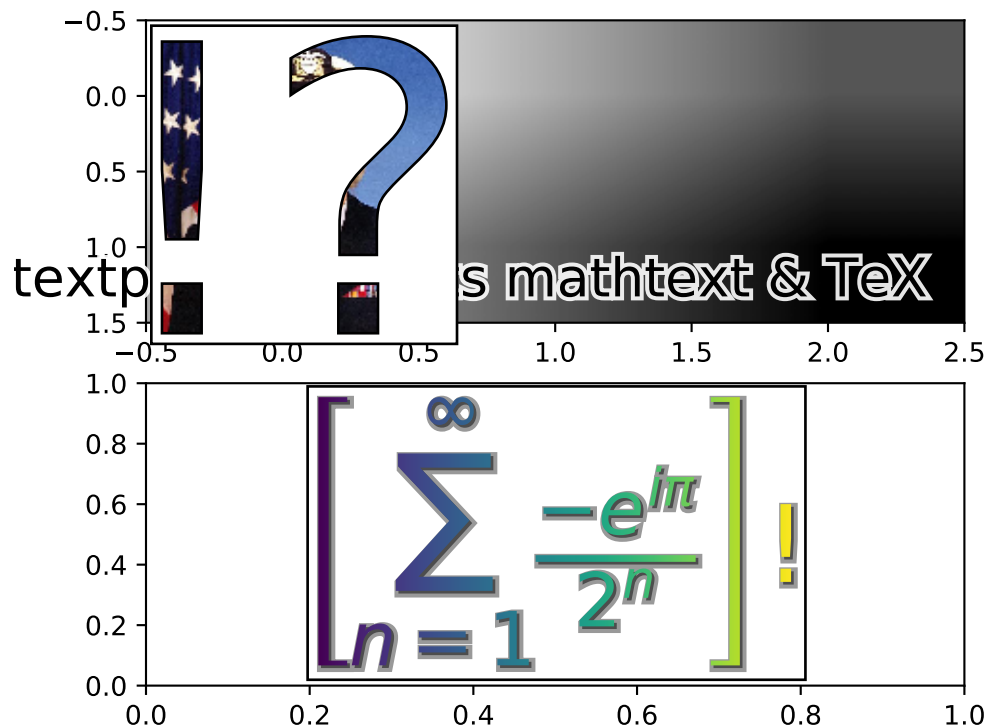

```

# -*- coding: utf-8 -*-

import matplotlib.pyplot as plt
from matplotlib.image import BboxImage
import numpy as np
from matplotlib.transforms import IdentityTransform

import matplotlib.patches as mpatches

from matplotlib.offsetbox import AnnotationBbox,\
    AnchoredOffsetbox, AuxTransformBox

```

```

from matplotlib.cbook import get_sample_data

from matplotlib.text import TextPath

class PathClippedImagePatch(mpatches.PathPatch):
    """
    The given image is used to draw the face of the patch. Internally,
    it uses BboxImage whose clippath set to the path of the patch.

    FIXME : The result is currently dpi dependent.
    """

    def __init__(self, path, bbox_image, **kwargs):
        mpatches.PathPatch.__init__(self, path, **kwargs)
        self._init_bbox_image(bbox_image)

    def set_facecolor(self, color):
        """simply ignore facecolor"""
        mpatches.PathPatch.set_facecolor(self, "none")

    def _init_bbox_image(self, im):

        bbox_image = BboxImage(self.get_window_extent,
                               norm=None,
                               origin=None,
                               )
        bbox_image.set_transform(IdentityTransform())

        bbox_image.set_data(im)
        self.bbox_image = bbox_image

    def draw(self, renderer=None):

        # the clip path must be updated every draw. any solution? -JJ
        self.bbox_image.set_clip_path(self._path, self.get_transform())
        self.bbox_image.draw(renderer)

        mpatches.PathPatch.draw(self, renderer)

if 1:

    usetex = plt.rcParams["text.usetex"]

    fig = plt.figure(1)

    # EXAMPLE 1

    ax = plt.subplot(211)

    from matplotlib._png import read_png

```



```

fn = get_sample_data("grace_hopper.png", asfileobj=False)
arr = read_png(fn)

text_path = TextPath((0, 0), "!", size=150)
p = PathClippedImagePatch(text_path, arr, ec="k",
                           transform=IdentityTransform())

#p.set_clip_on(False)

# make offset box
offsetbox = AuxTransformBox(IdentityTransform())
offsetbox.add_artist(p)

# make anchored offset box
ao = AnchoredOffsetbox(loc=2, child=offsetbox, frameon=True, borderpad=0.2)
ax.add_artist(ao)

# another text
from matplotlib.patches import PathPatch
if usetex:
    r = r"\mbox{textpath supports mathtext & \TeX}"
else:
    r = r"textpath supports mathtext & TeX"

text_path = TextPath((0, 0), r,
                     size=20, usetex=usetex)

p1 = PathPatch(text_path, ec="w", lw=3, fc="w", alpha=0.9,
               transform=IdentityTransform())
p2 = PathPatch(text_path, ec="none", fc="k",
               transform=IdentityTransform())

offsetbox2 = AuxTransformBox(IdentityTransform())
offsetbox2.add_artist(p1)
offsetbox2.add_artist(p2)

ab = AnnotationBbox(offsetbox2, (0.95, 0.05),
                    xycoords='axes fraction',
                    boxcoords="offset points",
                    box_alignment=(1., 0.),
                    frameon=False
                    )
ax.add_artist(ab)

ax.imshow([[0, 1, 2], [1, 2, 3]], cmap=plt.cm.gist_gray_r,
          interpolation="bilinear",
          aspect="auto")

# EXAMPLE 2

ax = plt.subplot(212)

arr = np.arange(256).reshape(1, 256)/256.

```

```
if usetex:
    s = r"\displaystyle\left[\sum_{n=1}^{\infty}\frac{-e^{i\pi}}{2^n}\right]$"
else:
    s = r"\left[\sum_{n=1}^{\infty}\frac{-e^{i\pi}}{2^n}\right]$"
text_path = TextPath((0, 0), s, size=40, usetex=usetex)
text_patch = PathClippedImagePatch(text_path, arr, ec="none",
                                   transform=IdentityTransform())

shadow1 = mpatches.Shadow(text_patch, 1, -1, props=dict(fc="none", ec="0.6", lw=3))
shadow2 = mpatches.Shadow(text_patch, 1, -1, props=dict(fc="0.3", ec="none"))

# make offset box
offsetbox = AuxTransformBox(IdentityTransform())
offsetbox.add_artist(shadow1)
offsetbox.add_artist(shadow2)
offsetbox.add_artist(text_patch)

# place the anchored offset box using AnnotationBbox
ab = AnnotationBbox(offsetbox, (0.5, 0.5),
                   xycoords='data',
                   boxcoords="offset points",
                   box_alignment=(0.5, 0.5),
                   )
#text_path.set_size(10)

ax.add_artist(ab)

ax.set_xlim(0, 1)
ax.set_ylim(0, 1)

plt.draw()
plt.show()
```

Keywords: python, matplotlib, pylab, example, codex (see [Search examples](#))

99.59 pylab_examples example code: demo_text_rotation_mode.py

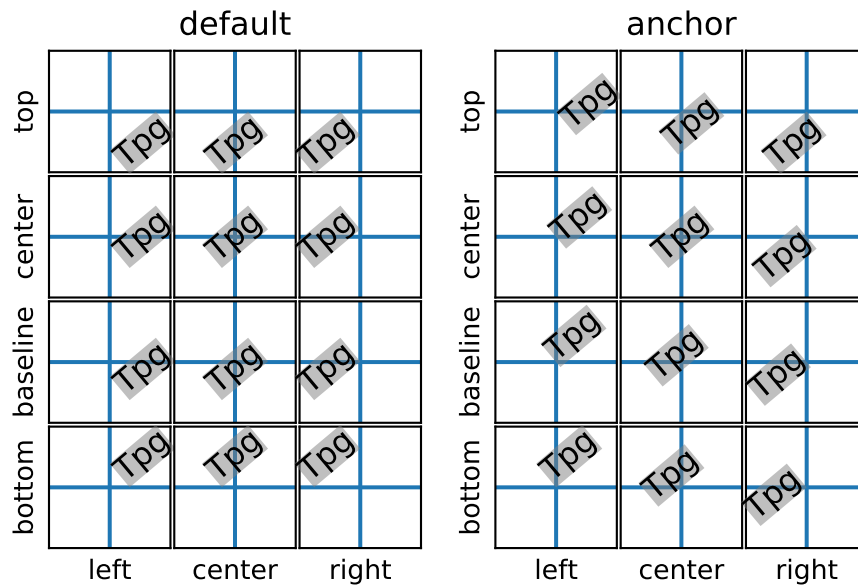

```

from mpl_toolkits.axes_grid1.axes_grid import ImageGrid

def test_rotation_mode(fig, mode, subplot_location):
    ha_list = "left center right".split()
    va_list = "top center baseline bottom".split()
    grid = ImageGrid(fig, subplot_location,
                     nrows_ncols=(len(va_list), len(ha_list)),
                     share_all=True, aspect=True,
                     #label_mode='1',
                     cbar_mode=None)

    for ha, ax in zip(ha_list, grid.axes_row[-1]):
        ax.axis["bottom"].label.set_text(ha)

    grid.axes_row[0][1].set_title(mode, size="large")

    for va, ax in zip(va_list, grid.axes_column[0]):
        ax.axis["left"].label.set_text(va)

    i = 0
    for va in va_list:
        for ha in ha_list:
            ax = grid[i]
            for axis in ax.axis.values():

```

```
        axis.toggle(ticks=False, ticklabels=False)

    ax.text(0.5, 0.5, "Tpg",
            size="large", rotation=40,
            bbox=dict(boxstyle="square,pad=0.",
                    ec="none", fc="0.5", alpha=0.5),
            ha=ha, va=va,
            rotation_mode=mode)
    ax.axvline(0.5)
    ax.axhline(0.5)
    i += 1

if 1:
    import matplotlib.pyplot as plt
    fig = plt.figure(1, figsize=(5.5, 4))
    fig.clf()

    test_rotation_mode(fig, "default", 121)
    test_rotation_mode(fig, "anchor", 122)
    plt.show()
```

Keywords: python, matplotlib, pylab, example, codex (see [Search examples](#))

99.60 pylab_examples example code: demo_tight_layout.py

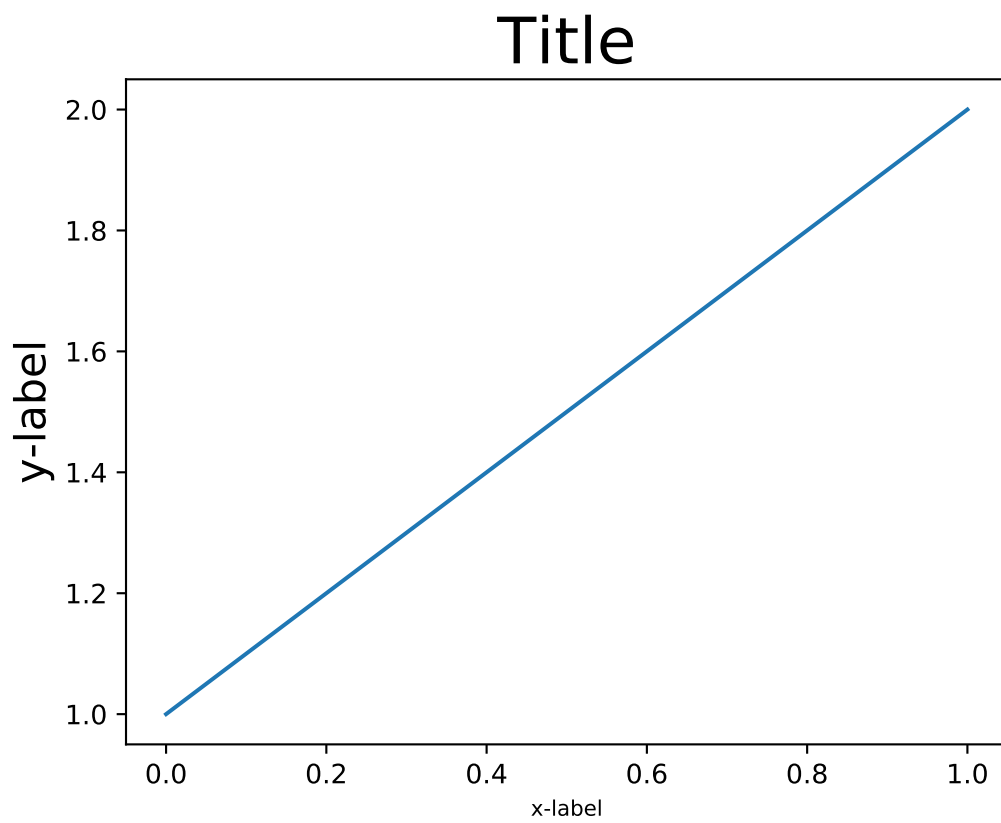

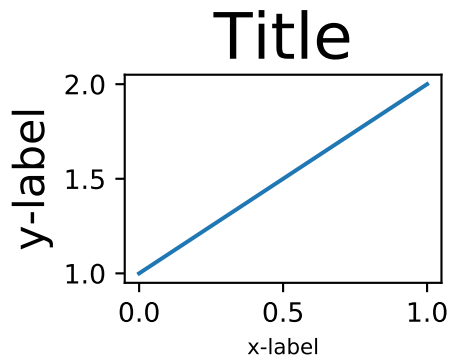
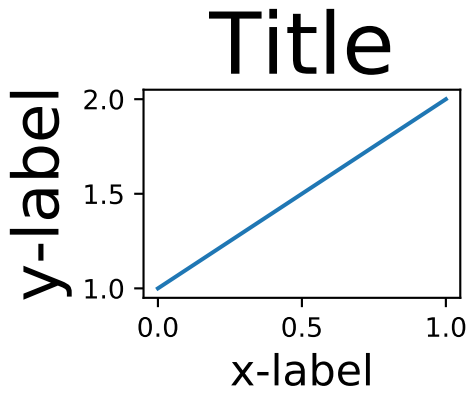
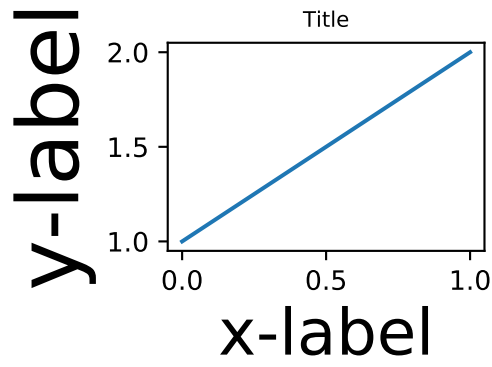
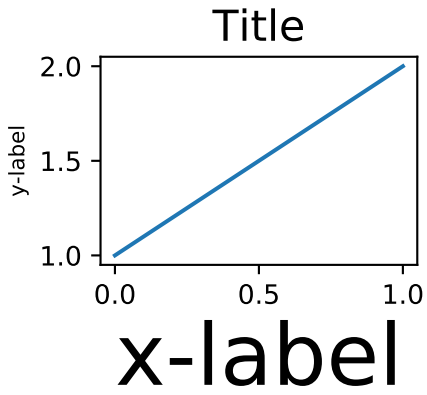

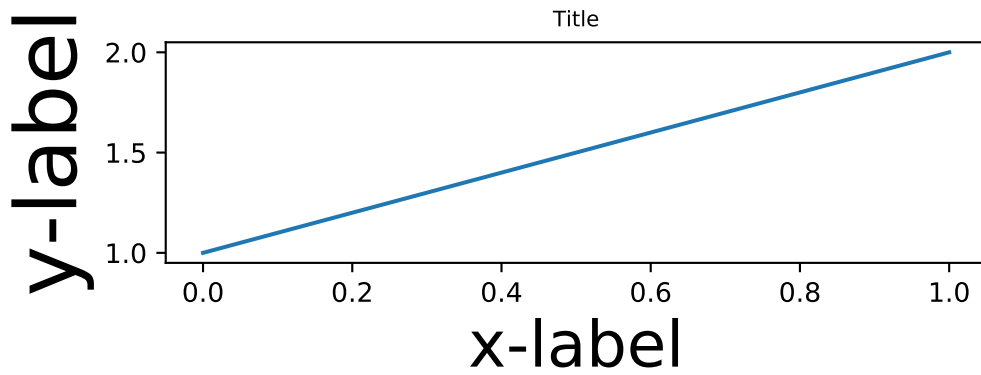
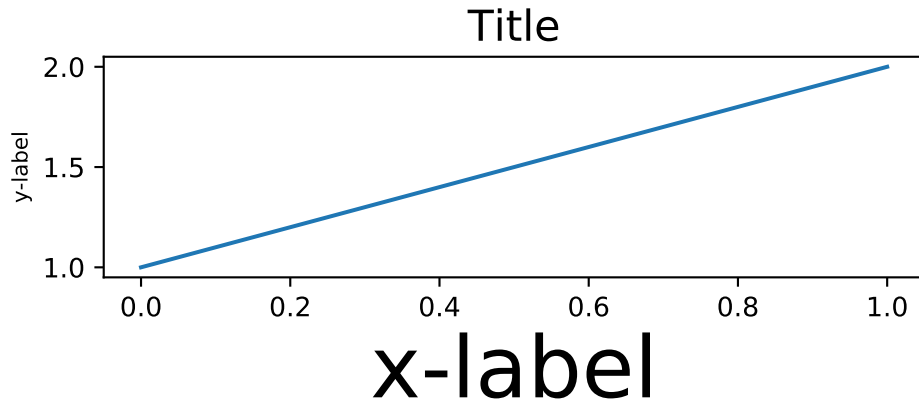

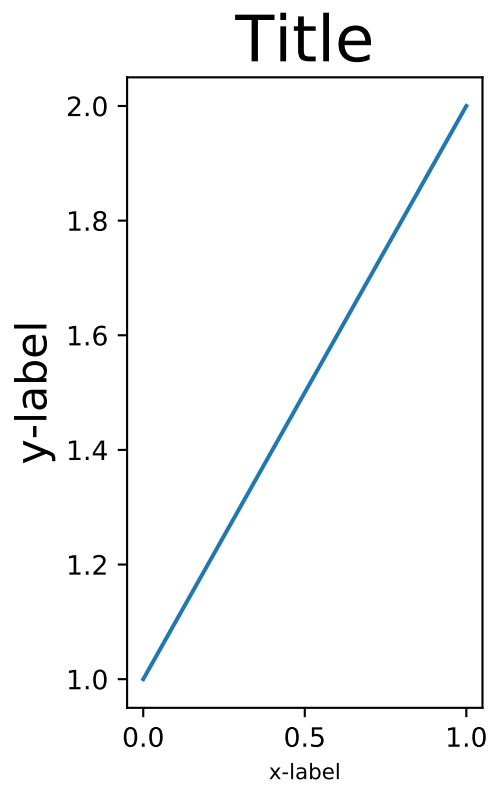
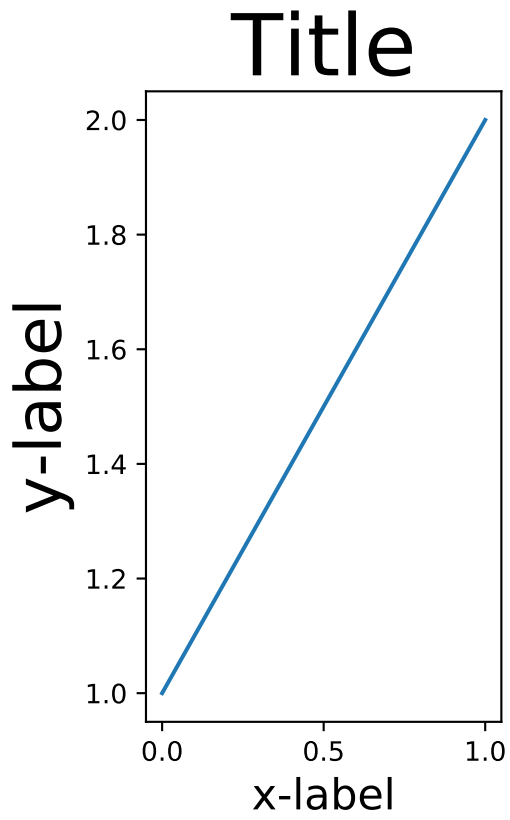

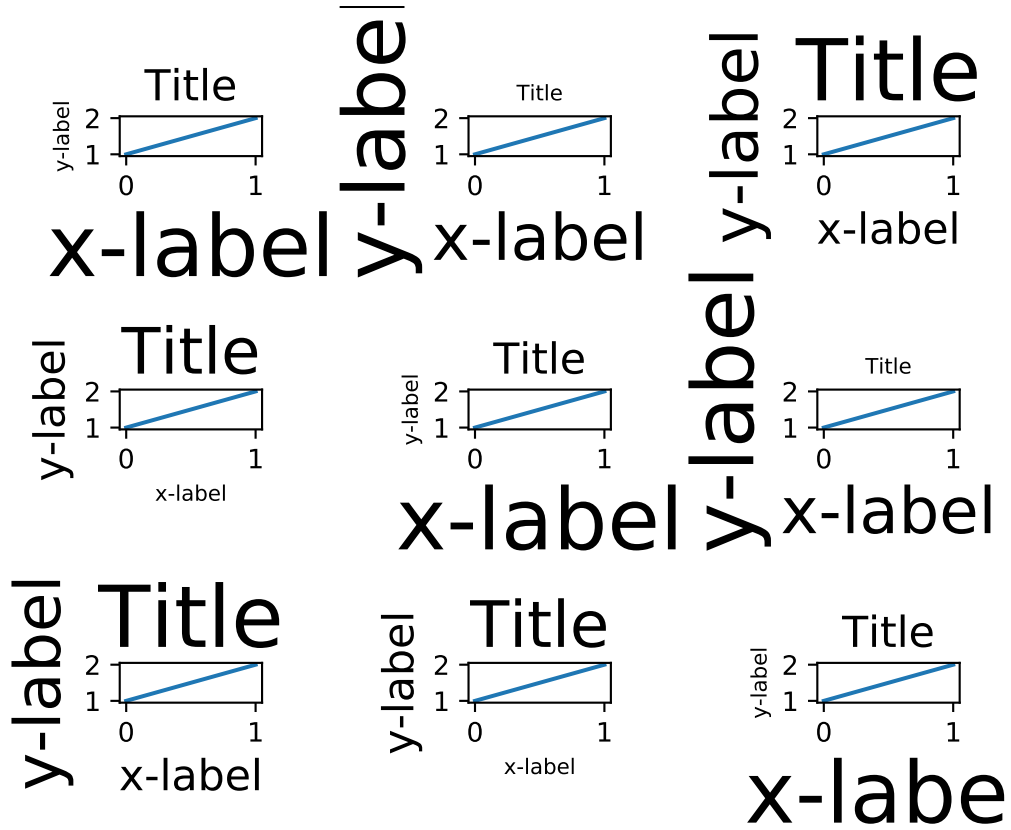

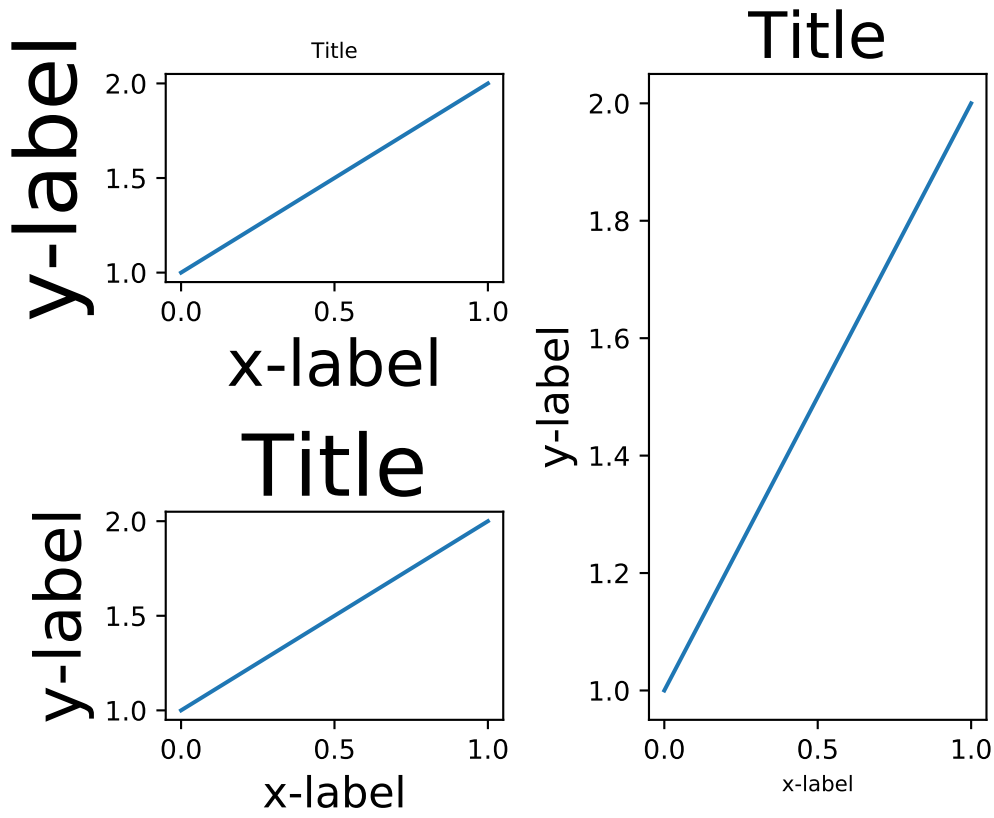

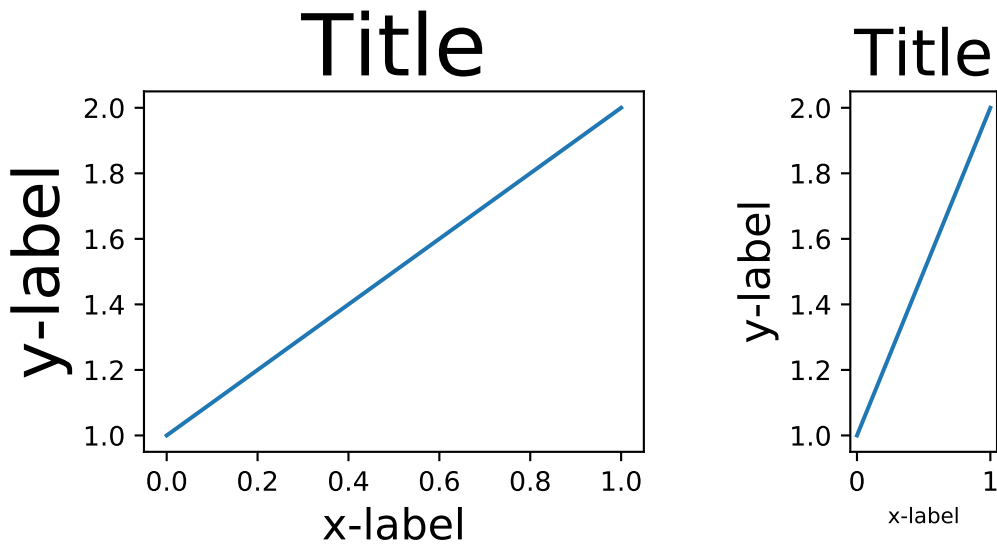
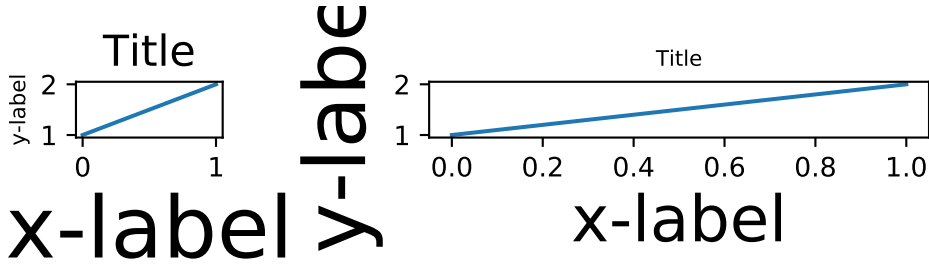

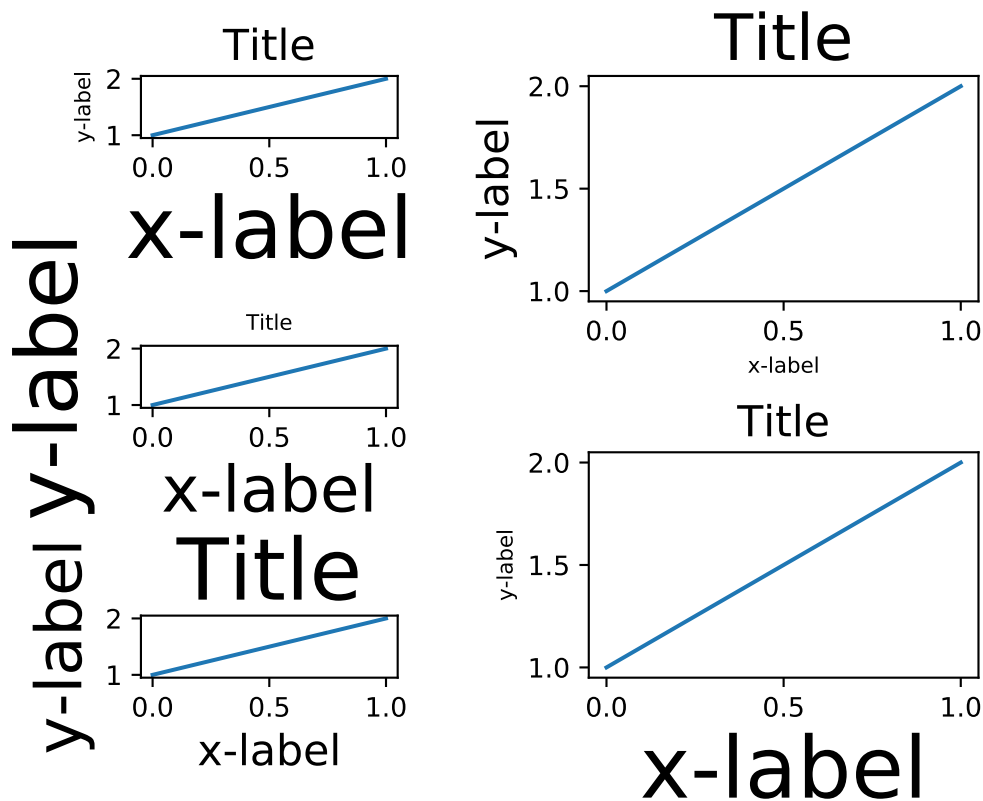

```

import matplotlib.pyplot as plt
import itertools
import warnings

fontsizes = itertools.cycle([8, 16, 24, 32])

def example_plot(ax):
    ax.plot([1, 2])
    ax.set_xlabel('x-label', fontsize=next(fontsizes))
    ax.set_ylabel('y-label', fontsize=next(fontsizes))
    ax.set_title('Title', fontsize=next(fontsizes))

fig, ax = plt.subplots()
example_plot(ax)
plt.tight_layout()

fig, ((ax1, ax2), (ax3, ax4)) = plt.subplots(nrows=2, ncols=2)
example_plot(ax1)
example_plot(ax2)
example_plot(ax3)
example_plot(ax4)
plt.tight_layout()

```

```
fig, (ax1, ax2) = plt.subplots(nrows=2, ncols=1)
example_plot(ax1)
example_plot(ax2)
plt.tight_layout()

fig, (ax1, ax2) = plt.subplots(nrows=1, ncols=2)
example_plot(ax1)
example_plot(ax2)
plt.tight_layout()

fig, axes = plt.subplots(nrows=3, ncols=3)
for row in axes:
    for ax in row:
        example_plot(ax)
plt.tight_layout()

fig = plt.figure()

ax1 = plt.subplot(221)
ax2 = plt.subplot(223)
ax3 = plt.subplot(122)

example_plot(ax1)
example_plot(ax2)
example_plot(ax3)

plt.tight_layout()

fig = plt.figure()

ax1 = plt.subplot2grid((3, 3), (0, 0))
ax2 = plt.subplot2grid((3, 3), (0, 1), colspan=2)
ax3 = plt.subplot2grid((3, 3), (1, 0), colspan=2, rowspan=2)
ax4 = plt.subplot2grid((3, 3), (1, 2), rowspan=2)

example_plot(ax1)
example_plot(ax2)
example_plot(ax3)
example_plot(ax4)

plt.tight_layout()

plt.show()

fig = plt.figure()

import matplotlib.gridspec as gridspec

gs1 = gridspec.GridSpec(3, 1)
ax1 = fig.add_subplot(gs1[0])
```

```
ax2 = fig.add_subplot(gs1[1])
ax3 = fig.add_subplot(gs1[2])

example_plot(ax1)
example_plot(ax2)
example_plot(ax3)

with warnings.catch_warnings():
    warnings.simplefilter("ignore", UserWarning)
    # This raises warnings since tight layout cannot
    # handle gridspec automatically. We are going to
    # do that manually so we can filter the warning.
    gs1.tight_layout(fig, rect=[None, None, 0.45, None])

gs2 = gridspec.GridSpec(2, 1)
ax4 = fig.add_subplot(gs2[0])
ax5 = fig.add_subplot(gs2[1])

example_plot(ax4)
example_plot(ax5)

with warnings.catch_warnings():
    # This raises warnings since tight layout cannot
    # handle gridspec automatically. We are going to
    # do that manually so we can filter the warning.
    warnings.simplefilter("ignore", UserWarning)
    gs2.tight_layout(fig, rect=[0.45, None, None, None])

# now match the top and bottom of two gridspecs.
top = min(gs1.top, gs2.top)
bottom = max(gs1.bottom, gs2.bottom)

gs1.update(top=top, bottom=bottom)
gs2.update(top=top, bottom=bottom)

plt.show()
```

Keywords: python, matplotlib, pylab, example, codex (see [Search examples](#))

99.61 pylab_examples example code: dolphin.py

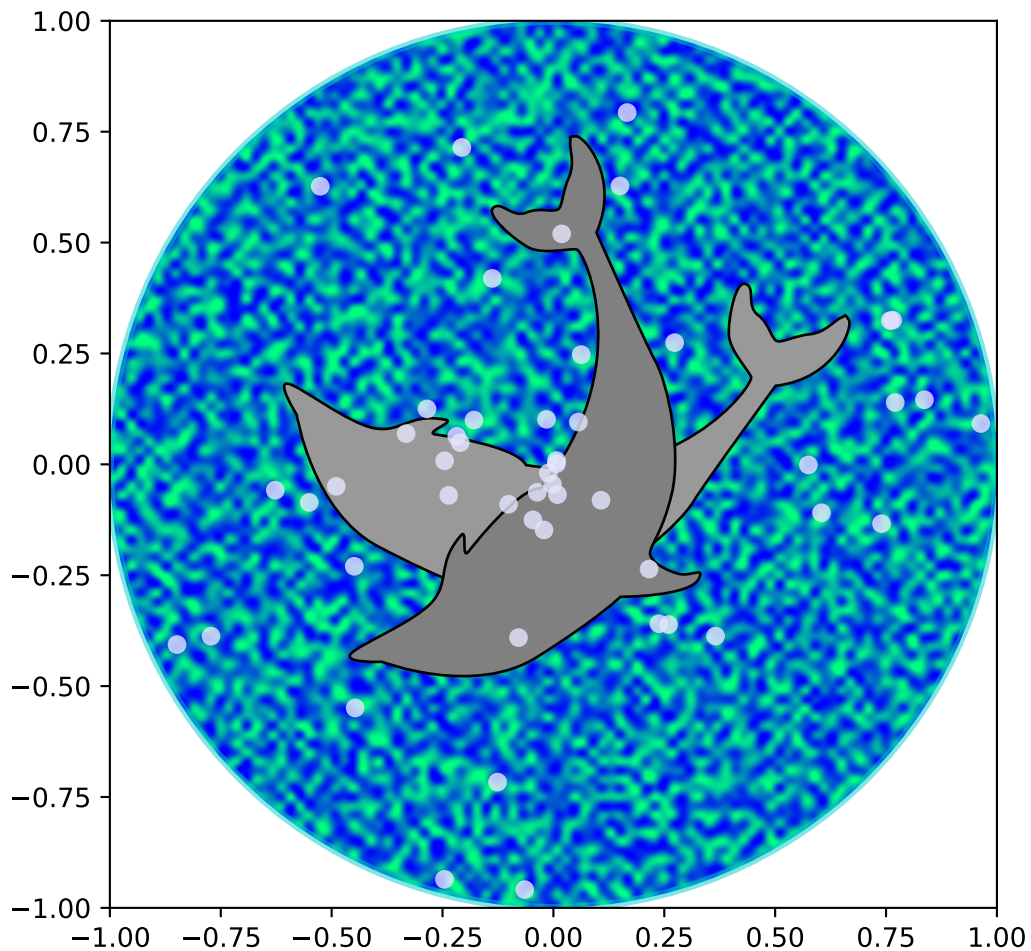

```
import matplotlib.cm as cm
import matplotlib.pyplot as plt
from matplotlib.patches import Circle, PathPatch
from matplotlib.path import Path
from matplotlib.transforms import Affine2D
import numpy as np

r = np.random.rand(50)
t = np.random.rand(50) * np.pi * 2.0
x = r * np.cos(t)
y = r * np.sin(t)
```

```

fig, ax = plt.subplots(figsize=(6, 6))
circle = Circle((0, 0), 1, facecolor='none',
                edgecolor=(0, 0.8, 0.8), linewidth=3, alpha=0.5)
ax.add_patch(circle)

im = plt.imshow(np.random.random((100, 100)),
                origin='lower', cmap=cm.winter,
                interpolation='spline36',
                extent=[-1, 1, -1, 1])
im.set_clip_path(circle)

plt.plot(x, y, 'o', color=(0.9, 0.9, 1.0), alpha=0.8)

# Dolphin from OpenClipart library by Andy Fitzsimon
# <cc:License rdf:about="http://web.resource.org/cc/PublicDomain">
# <cc:permits rdf:resource="http://web.resource.org/cc/Reproduction"/>
# <cc:permits rdf:resource="http://web.resource.org/cc/Distribution"/>
# <cc:permits rdf:resource="http://web.resource.org/cc/DerivativeWorks"/>
# </cc:License>

dolphin = """
M -0.59739425,160.18173 C -0.62740401,160.18885 -0.57867129,160.11183
-0.57867129,160.11183 C -0.57867129,160.11183 -0.5438361,159.89315
-0.39514638,159.81496 C -0.24645668,159.73678 -0.18316813,159.71981
-0.18316813,159.71981 C -0.18316813,159.71981 -0.10322971,159.58124
-0.057804323,159.58725 C -0.029723983,159.58913 -0.061841603,159.60356
-0.071265813,159.62815 C -0.080250183,159.65325 -0.082918513,159.70554
-0.061841203,159.71248 C -0.040763903,159.7194 -0.0066711426,159.71091
0.077336307,159.73612 C 0.16879567,159.76377 0.28380306,159.86448
0.31516668,159.91533 C 0.3465303,159.96618 0.5011127,160.1771
0.5011127,160.1771 C 0.63668998,160.19238 0.67763022,160.31259
0.66556395,160.32668 C 0.65339985,160.34212 0.66350443,160.33642
0.64907098,160.33088 C 0.63463742,160.32533 0.61309688,160.297
0.5789627,160.29339 C 0.54348657,160.28968 0.52329693,160.27674
0.50728856,160.27737 C 0.49060916,160.27795 0.48965803,160.31565
0.46114204,160.33673 C 0.43329696,160.35786 0.4570711,160.39871
0.43309565,160.40685 C 0.4105108,160.41442 0.39416631,160.33027
0.3954995,160.2935 C 0.39683269,160.25672 0.43807996,160.21522
0.44567915,160.19734 C 0.45327833,160.17946 0.27946869,159.9424
-0.061852613,159.99845 C -0.083965233,160.0427 -0.26176109,160.06683
-0.26176109,160.06683 C -0.30127962,160.07028 -0.21167141,160.09731
-0.24649368,160.1011 C -0.32642366,160.11569 -0.34521187,160.06895
-0.40622293,160.0819 C -0.467234,160.09485 -0.56738444,160.17461
-0.59739425,160.18173
"""

vertices = []
codes = []
parts = dolphin.split()
i = 0
code_map = {
    'M': (Path.MOVETO, 1),
    'C': (Path.CURVE4, 3),
}

```



```
'L': (Path.LINETO, 1)
}

while i < len(parts):
    code = parts[i]
    path_code, npoints = code_map[code]
    codes.extend([path_code] * npoints)
    vertices.extend([[float(x) for x in y.split(',')] for y in
                    parts[i + 1:i + npoints + 1]])
    i += npoints + 1
vertices = np.array(vertices, np.float)
vertices[:, 1] -= 160

dolphin_path = Path(vertices, codes)
dolphin_patch = PathPatch(dolphin_path, facecolor=(0.6, 0.6, 0.6),
                          edgecolor=(0.0, 0.0, 0.0))
ax.add_patch(dolphin_patch)

vertices = Affine2D().rotate_deg(60).transform(vertices)
dolphin_path2 = Path(vertices, codes)
dolphin_patch2 = PathPatch(dolphin_path2, facecolor=(0.5, 0.5, 0.5),
                           edgecolor=(0.0, 0.0, 0.0))
ax.add_patch(dolphin_patch2)

plt.show()
```

Keywords: python, matplotlib, pylab, example, codex (see [Search examples](#))

99.62 pylab_examples example code: ellipse_collection.py

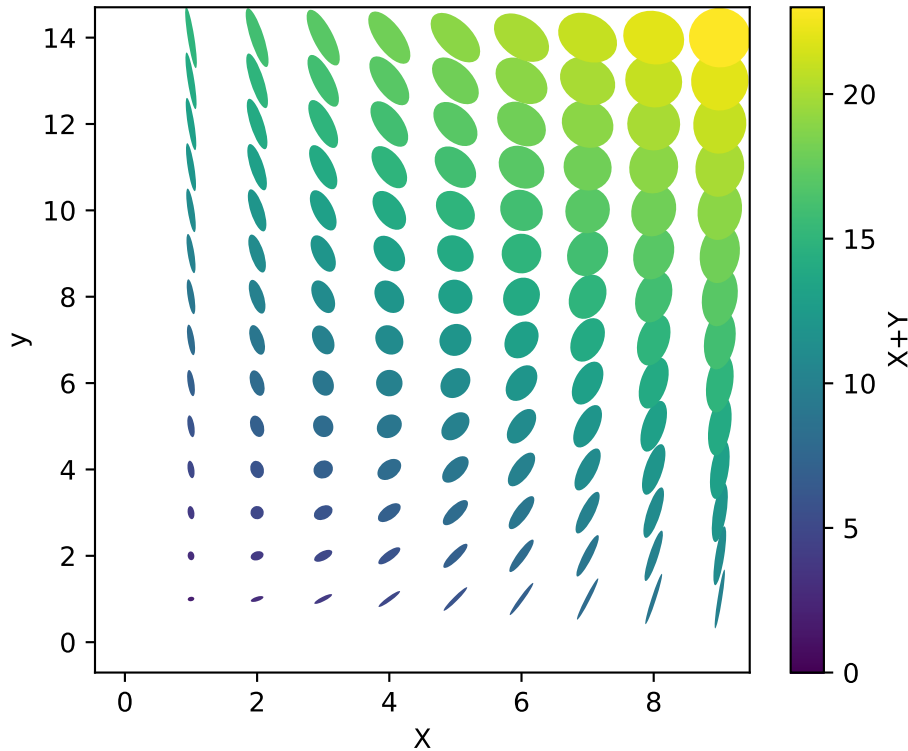

```

import matplotlib.pyplot as plt
import numpy as np
from matplotlib.collections import EllipseCollection

x = np.arange(10)
y = np.arange(15)
X, Y = np.meshgrid(x, y)

XY = np.hstack((X.ravel()[:, np.newaxis], Y.ravel()[:, np.newaxis]))

ww = X/10.0
hh = Y/15.0
aa = X*9

fig, ax = plt.subplots()

ec = EllipseCollection(ww, hh, aa, units='x', offsets=XY,
                      transOffset=ax.transData)
ec.set_array((X + Y).ravel())
ax.add_collection(ec)
ax.autoscale_view()

```

```
ax.set_xlabel('X')
ax.set_ylabel('y')
cbar = plt.colorbar(ec)
cbar.set_label('X+Y')
plt.show()
```

Keywords: python, matplotlib, pylab, example, codex (see *Search examples*)

99.63 pylab_examples example code: ellipse_demo.py

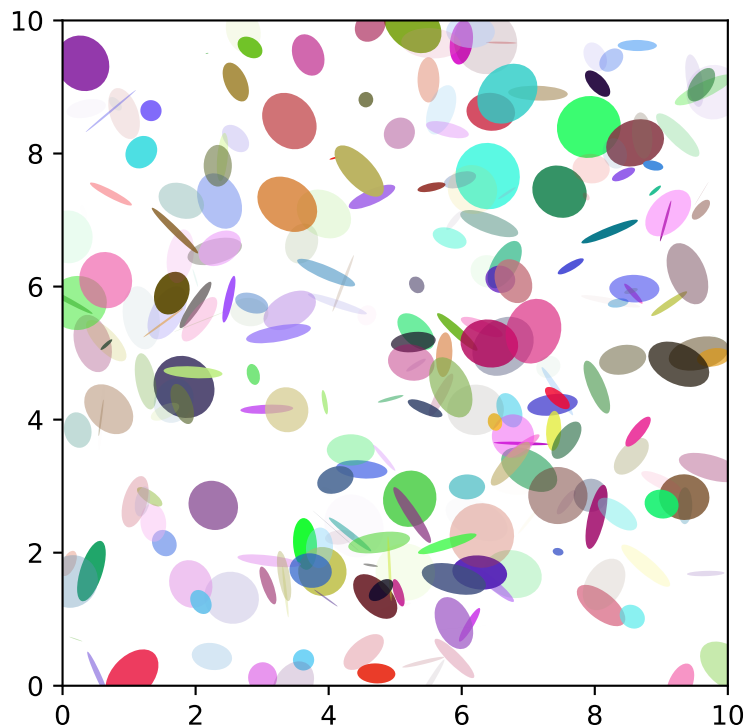

```
import matplotlib.pyplot as plt
import numpy.random as rnd
from matplotlib.patches import Ellipse

NUM = 250

ells = [Ellipse(xy=rnd.rand(2)*10, width=rnd.rand(), height=rnd.rand(), angle=rnd.
    ↪rand()*360)
        for i in range(NUM)]

fig = plt.figure(0)
ax = fig.add_subplot(111, aspect='equal')
```

```
for e in ells:
    ax.add_artist(e)
    e.set_clip_box(ax.bbox)
    e.set_alpha(rnd.rand())
    e.set_facecolor(rnd.rand(3))

ax.set_xlim(0, 10)
ax.set_ylim(0, 10)

plt.show()
```

Keywords: python, matplotlib, pylab, example, codex (see [Search examples](#))

99.64 pylab_examples example code: ellipse_rotated.py

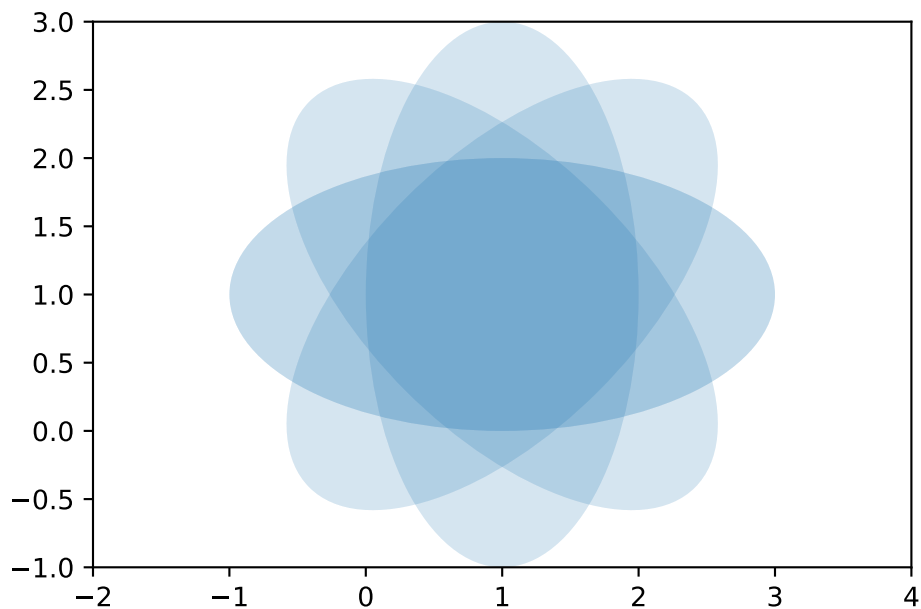

```
import matplotlib.pyplot as plt
import numpy as np
from matplotlib.patches import Ellipse

delta = 45.0 # degrees
angles = np.arange(0, 360 + delta, delta)
```

```
ells = [Ellipse((1, 1), 4, 2, a) for a in angles]

a = plt.subplot(111, aspect='equal')

for e in ells:
    e.set_clip_box(a.bbox)
    e.set_alpha(0.1)
    a.add_artist(e)

plt.xlim(-2, 4)
plt.ylim(-1, 3)

plt.show()
```

Keywords: python, matplotlib, pylab, example, codex (see [Search examples](#))

99.65 pylab_examples example code: equal_aspect_ratio.py

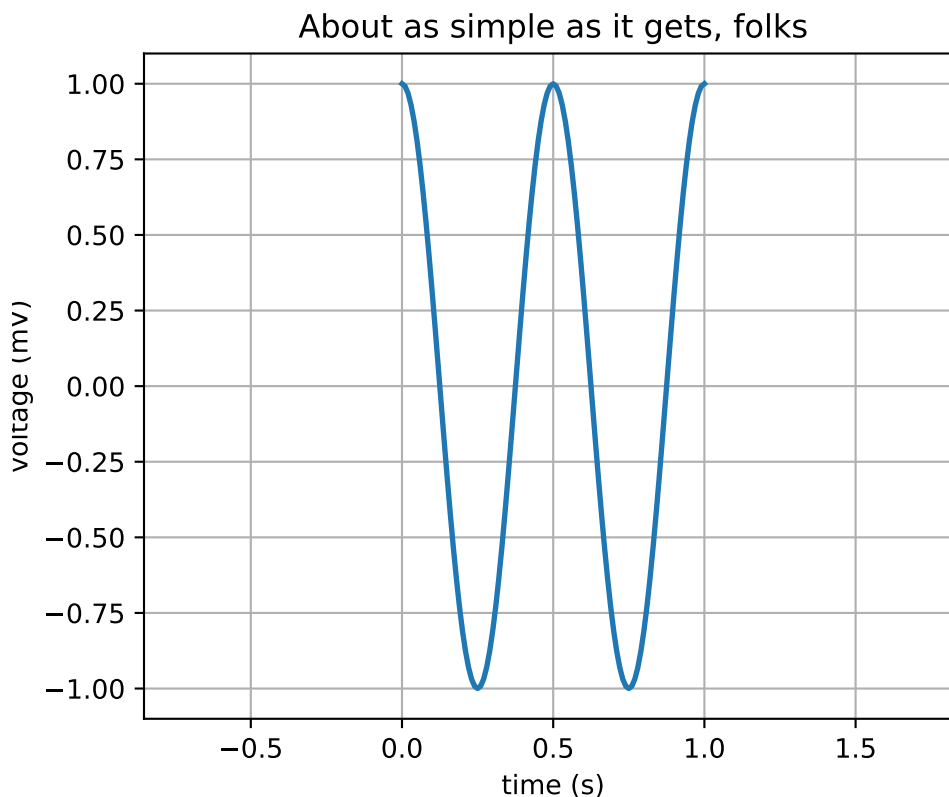

```
"""
Example: simple line plot.
Show how to make a plot that has equal aspect ratio
"""
```

```
import matplotlib.pyplot as plt
import numpy as np

t = np.arange(0.0, 1.0 + 0.01, 0.01)
s = np.cos(2*2*np.pi*t)
plt.plot(t, s, '-', lw=2)

plt.xlabel('time (s)')
plt.ylabel('voltage (mV)')
plt.title('About as simple as it gets, folks')
plt.grid(True)

plt.axes().set_aspect('equal', 'datalim')

plt.show()
```

Keywords: python, matplotlib, pylab, example, codex (see [Search examples](#))

99.66 pylab_examples example code: errorbar_limits.py

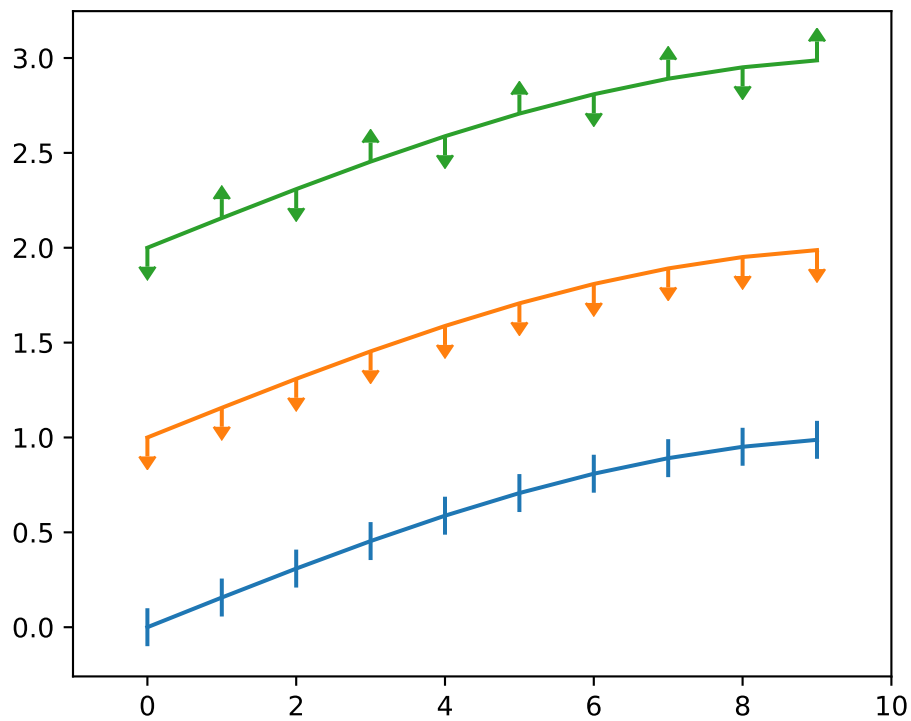

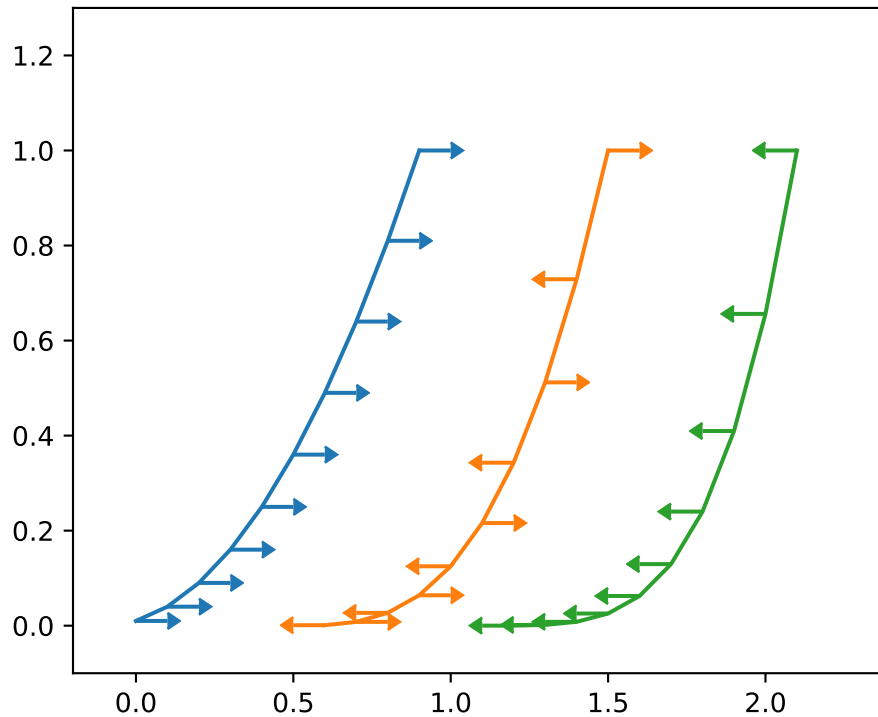

```

"""
Illustration of upper and lower limit symbols on errorbars
"""

import numpy as np
import matplotlib.pyplot as plt

fig = plt.figure(0)
x = np.arange(10.0)
y = np.sin(np.arange(10.0)/20.0*np.pi)

plt.errorbar(x, y, yerr=0.1)

y = np.sin(np.arange(10.0)/20.0*np.pi) + 1
plt.errorbar(x, y, yerr=0.1, uplims=True)

y = np.sin(np.arange(10.0)/20.0*np.pi) + 2
upperlimits = np.array([1, 0]*5)
lowerlimits = np.array([0, 1]*5)
plt.errorbar(x, y, yerr=0.1, uplims=upperlimits, lolims=lowerlimits)

plt.xlim(-1, 10)

fig = plt.figure(1)
x = np.arange(10.0)/10.0
y = (x + 0.1)**2

```

```

plt.errorbar(x, y, xerr=0.1, xlolims=True)
y = (x + 0.1)**3

plt.errorbar(x + 0.6, y, xerr=0.1, xuplims=upperlimits, xlolims=lowerlimits)

y = (x + 0.1)**4
plt.errorbar(x + 1.2, y, xerr=0.1, xuplims=True)

plt.xlim(-0.2, 2.4)
plt.ylim(-0.1, 1.3)

plt.show()

```

Keywords: python, matplotlib, pylab, example, codex (see [Search examples](#))

99.67 pylab_examples example code: errorbar_subsample.py

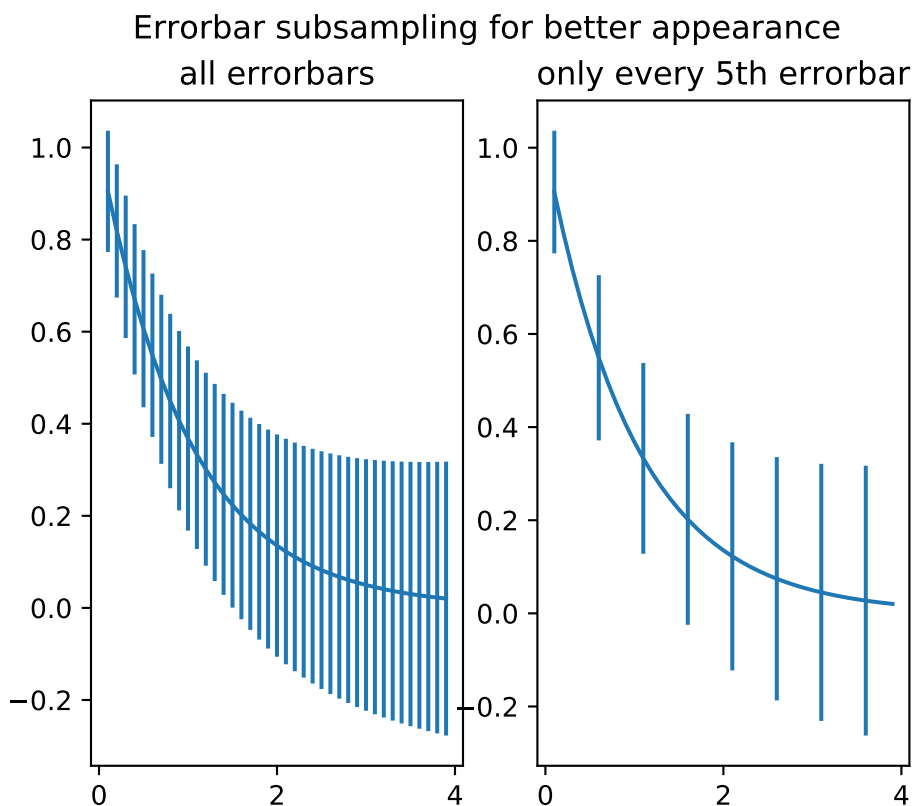

```

"""
Demo for the errorevery keyword to show data full accuracy data plots with
few errorbars.
"""

```



```
import numpy as np
import matplotlib.pyplot as plt

# example data
x = np.arange(0.1, 4, 0.1)
y = np.exp(-x)

# example variable error bar values
yerr = 0.1 + 0.1*np.sqrt(x)

# Now switch to a more OO interface to exercise more features.
fig, axs = plt.subplots(nrows=1, ncols=2, sharex=True)
ax = axs[0]
ax.errorbar(x, y, yerr=yerr)
ax.set_title('all errorbars')

ax = axs[1]
ax.errorbar(x, y, yerr=yerr, errorevery=5)
ax.set_title('only every 5th errorbar')

fig.suptitle('Errorbar subsampling for better appearance')

plt.show()
```

Keywords: python, matplotlib, pylab, example, codex (see [Search examples](#))

99.68 pylab_examples example code: eventcollection_demo.py

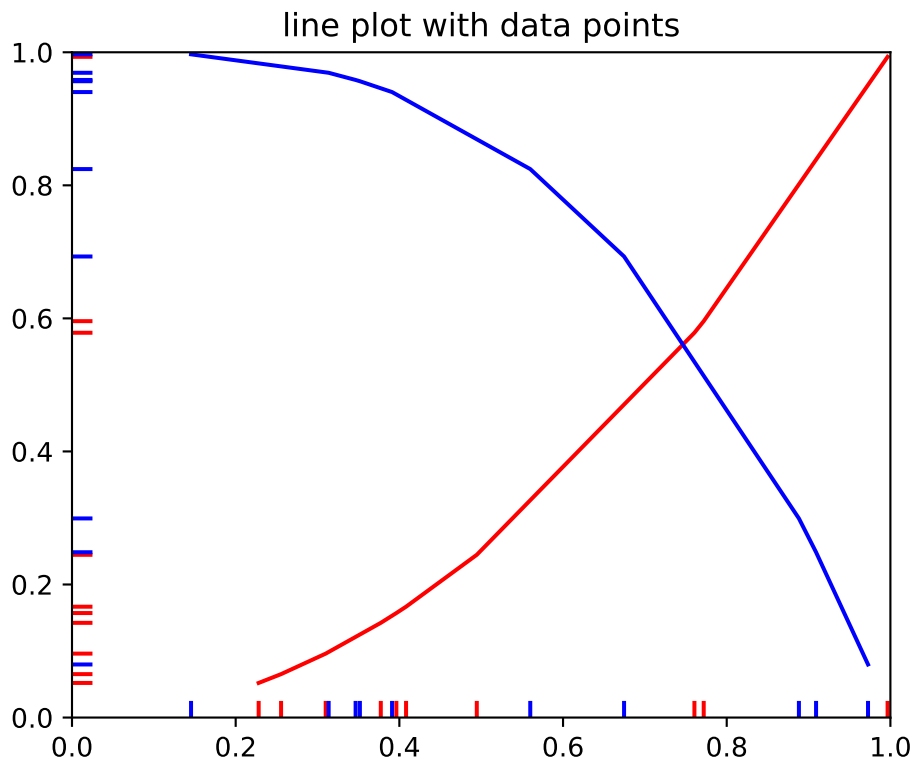

```

"""
Plot two curves, then use EventCollections to mark the locations of the x
and y data points on the respective axes for each curve
"""

import matplotlib.pyplot as plt
from matplotlib.collections import EventCollection
import numpy as np

# create random data
np.random.seed(50)
xdata = np.random.random([2, 10])

# split the data into two parts
xdata1 = xdata[0, :]
xdata2 = xdata[1, :]

# sort the data so it makes clean curves
xdata1.sort()
xdata2.sort()

# create some y data points

```

```
ydata1 = xdata1 ** 2
ydata2 = 1 - xdata2 ** 3

# plot the data
fig = plt.figure()
ax = fig.add_subplot(1, 1, 1)
ax.plot(xdata1, ydata1, 'r', xdata2, ydata2, 'b')

# create the events marking the x data points
xevents1 = EventCollection(xdata1, color=[1, 0, 0], linelength=0.05)
xevents2 = EventCollection(xdata2, color=[0, 0, 1], linelength=0.05)

# create the events marking the y data points
yevents1 = EventCollection(ydata1, color=[1, 0, 0], linelength=0.05,
                           orientation='vertical')
yevents2 = EventCollection(ydata2, color=[0, 0, 1], linelength=0.05,
                           orientation='vertical')

# add the events to the axis
ax.add_collection(xevents1)
ax.add_collection(xevents2)
ax.add_collection(yevents1)
ax.add_collection(yevents2)

# set the limits
ax.set_xlim([0, 1])
ax.set_ylim([0, 1])

ax.set_title('line plot with data points')

# display the plot
plt.show()
```

Keywords: python, matplotlib, pylab, example, codex (see [Search examples](#))

99.69 pylab_examples example code: eventplot_demo.py

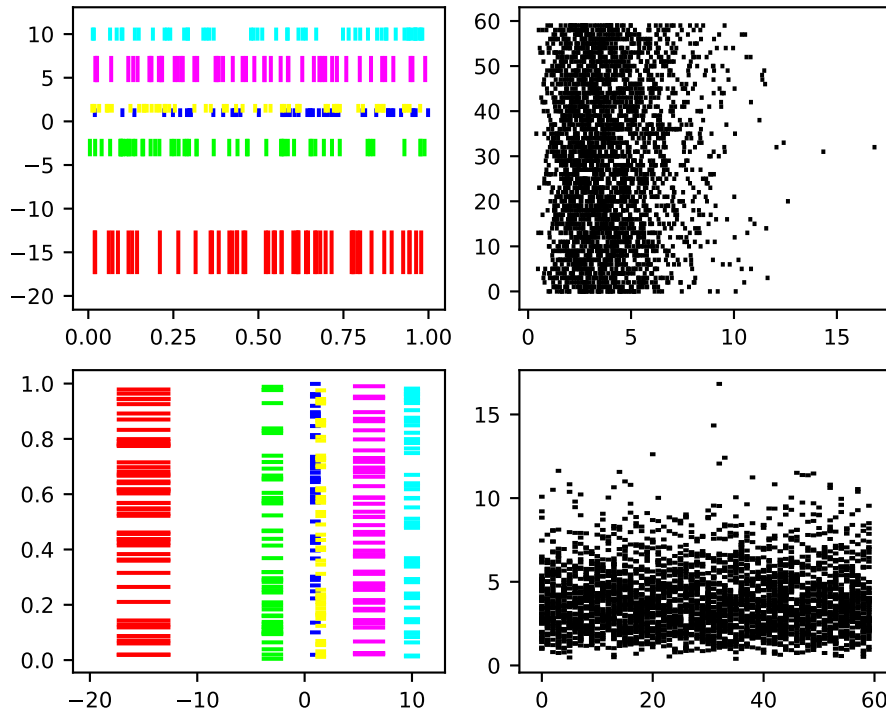

```

"""
An eventplot showing sequences of events with various line properties.
The plot is shown in both horizontal and vertical orientations.
"""

import matplotlib.pyplot as plt
import numpy as np
import matplotlib
matplotlib.rcParams['font.size'] = 8.0

# set the random seed
np.random.seed(0)

# create random data
data1 = np.random.random([6, 50])

# set different colors for each set of positions
colors1 = np.array([[1, 0, 0],
                   [0, 1, 0],
                   [0, 0, 1],
                   [1, 1, 0],
                   [1, 0, 1],

```

```
[0, 1, 1]])

# set different line properties for each set of positions
# note that some overlap
lineoffsets1 = np.array([-15, -3, 1, 1.5, 6, 10])
linelengths1 = [5, 2, 1, 1, 3, 1.5]

fig = plt.figure()

# create a horizontal plot
ax1 = fig.add_subplot(221)
ax1.eventplot(data1, colors=colors1, lineoffsets=lineoffsets1,
              linelengths=linelengths1)

# create a vertical plot
ax2 = fig.add_subplot(223)
ax2.eventplot(data1, colors=colors1, lineoffsets=lineoffsets1,
              linelengths=linelengths1, orientation='vertical')

# create another set of random data.
# the gamma distribution is only used fo aesthetic purposes
data2 = np.random.gamma(4, size=[60, 50])

# use individual values for the parameters this time
# these values will be used for all data sets (except lineoffsets2, which
# sets the increment between each data set in this usage)
colors2 = [[0, 0, 0]]
lineoffsets2 = 1
linelengths2 = 1

# create a horizontal plot
ax1 = fig.add_subplot(222)
ax1.eventplot(data2, colors=colors2, lineoffsets=lineoffsets2,
              linelengths=linelengths2)

# create a vertical plot
ax2 = fig.add_subplot(224)
ax2.eventplot(data2, colors=colors2, lineoffsets=lineoffsets2,
              linelengths=linelengths2, orientation='vertical')

plt.show()
```

Keywords: python, matplotlib, pylab, example, codex (see [Search examples](#))

99.70 pylab_examples example code: fancyarrow_demo.py

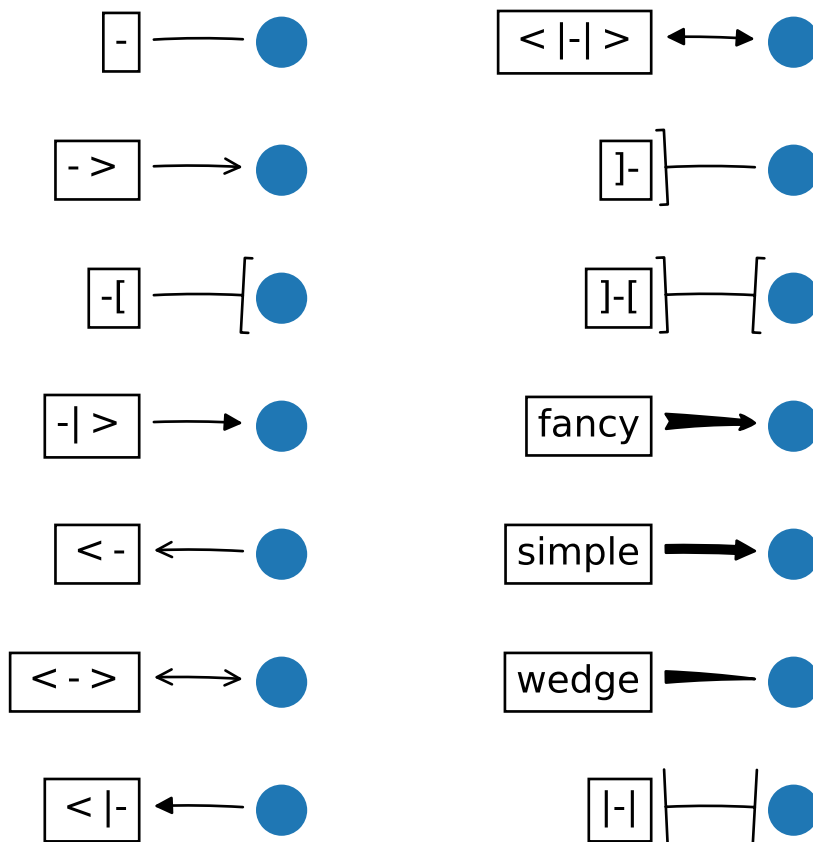

```

import matplotlib.patches as mpatches
import matplotlib.pyplot as plt

styles = mpatches.ArrowStyle.get_styles()

ncol = 2
nrow = (len(styles) + 1) // ncol
figheight = (nrow + 0.5)
fig1 = plt.figure(1, (4.*ncol/1.5, figheight/1.5))
fontsize = 0.2 * 70

ax = fig1.add_axes([0, 0, 1, 1], frameon=False, aspect=1.)

ax.set_xlim(0, 4*ncol)
ax.set_ylim(0, figheight)

def to_texstring(s):

```

```

s = s.replace("<", r"$<$")
s = s.replace(">", r"$>$")
s = s.replace("|", r"$|$")
return s

for i, (stylename, styleclass) in enumerate(sorted(styles.items())):
    x = 3.2 + (i//nrow)*4
    y = (figheight - 0.7 - i % nrow) # /figheight
    p = mpatches.Circle((x, y), 0.2)
    ax.add_patch(p)

    ax.annotate(to_texstring(stylename), (x, y),
               (x - 1.2, y),
               #xycoords="figure fraction", textcoords="figure fraction",
               ha="right", va="center",
               size=fontsize,
               arrowprops=dict(arrowstyle=stylename,
                               patchB=p,
                               shrinkA=5,
                               shrinkB=5,
                               fc="k", ec="k",
                               connectionstyle="arc3,rad=-0.05",
                               ),
               bbox=dict(boxstyle="square", fc="w"))

ax.xaxis.set_visible(False)
ax.yaxis.set_visible(False)

plt.draw()
plt.show()

```

Keywords: python, matplotlib, pylab, example, codex (see [Search examples](#))

99.71 pylab_examples example code: fancybox_demo.py

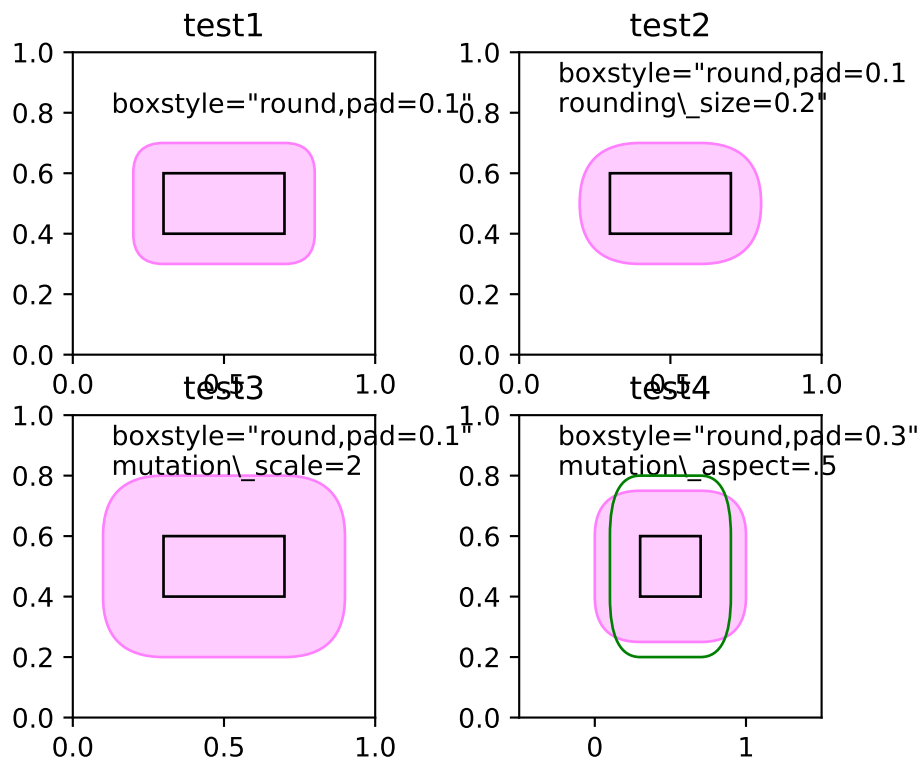

```

import matplotlib.pyplot as plt
import matplotlib.transforms as mtransforms
from matplotlib.patches import FancyBboxPatch

# Bbox object around which the fancy box will be drawn.
bb = mtransforms.Bbox([[0.3, 0.4], [0.7, 0.6]])

def draw_bbox(ax, bb):
    # boxstyle=square with pad=0, i.e. bbox itself.
    p_bbox = FancyBboxPatch((bb.xmin, bb.ymin),
                            abs(bb.width), abs(bb.height),
                            boxstyle="square, pad=0.",
                            ec="k", fc="none", zorder=10.,
                            )
    ax.add_patch(p_bbox)

def test1(ax):
    # a fancy box with round corners. pad=0.1

```



```

p_fancy = FancyBboxPatch((bb.xmin, bb.ymin),
                        abs(bb.width), abs(bb.height),
                        boxstyle="round,pad=0.1",
                        fc=(1., .8, 1.),
                        ec=(1., 0.5, 1.))

ax.add_patch(p_fancy)

ax.text(0.1, 0.8,
       r' boxstyle="round,pad=0.1"',
       size=10, transform=ax.transAxes)

# draws control points for the fancy box.
#l = p_fancy.get_path().vertices
#ax.plot(l[:,0], l[:,1], ".")

# draw the original bbox in black
draw_bbox(ax, bb)

def test2(ax):

    # bbox=round has two optional argument. pad and rounding_size.
    # They can be set during the initialization.
    p_fancy = FancyBboxPatch((bb.xmin, bb.ymin),
                            abs(bb.width), abs(bb.height),
                            boxstyle="round,pad=0.1",
                            fc=(1., .8, 1.),
                            ec=(1., 0.5, 1.))

    ax.add_patch(p_fancy)

    # boxstyle and its argument can be later modified with
    # set_boxstyle method. Note that the old attributes are simply
    # forgotten even if the boxstyle name is same.

    p_fancy.set_boxstyle("round,pad=0.1, rounding_size=0.2")
    # or
    #p_fancy.set_boxstyle("round", pad=0.1, rounding_size=0.2)

    ax.text(0.1, 0.8,
           ' boxstyle="round,pad=0.1\n rounding\_size=0.2"',
           size=10, transform=ax.transAxes)

    # draws control points for the fancy box.
    #l = p_fancy.get_path().vertices
    #ax.plot(l[:,0], l[:,1], ".")

    draw_bbox(ax, bb)

def test3(ax):

```

```

# mutation_scale determine overall scale of the mutation,
# i.e. both pad and rounding_size is scaled according to this
# value.
p_fancy = FancyBboxPatch((bb.xmin, bb.ymin),
                          abs(bb.width), abs(bb.height),
                          boxstyle="round,pad=0.1",
                          mutation_scale=2.,
                          fc=(1., .8, 1.),
                          ec=(1., 0.5, 1.))

ax.add_patch(p_fancy)

ax.text(0.1, 0.8,
        ' boxstyle="round,pad=0.1"\n mutation\\_scale=2',
        size=10, transform=ax.transAxes)

# draws control points for the fancy box.
#l = p_fancy.get_path().vertices
#ax.plot(l[:,0], l[:,1], ".")

draw_bbox(ax, bb)

```

```
def test4(ax):
```

```

# When the aspect ratio of the axes is not 1, the fancy box may
# not be what you expected (green)

p_fancy = FancyBboxPatch((bb.xmin, bb.ymin),
                          abs(bb.width), abs(bb.height),
                          boxstyle="round,pad=0.2",
                          fc="none",
                          ec=(0., .5, 0.), zorder=4)

ax.add_patch(p_fancy)

# You can compensate this by setting the mutation_aspect (pink).
p_fancy = FancyBboxPatch((bb.xmin, bb.ymin),
                          abs(bb.width), abs(bb.height),
                          boxstyle="round,pad=0.3",
                          mutation_aspect=.5,
                          fc=(1., 0.8, 1.),
                          ec=(1., 0.5, 1.))

ax.add_patch(p_fancy)

ax.text(0.1, 0.8,
        ' boxstyle="round,pad=0.3"\n mutation\\_aspect=.5',
        size=10, transform=ax.transAxes)

draw_bbox(ax, bb)

```

```
def test_all():
    plt.clf()

    ax = plt.subplot(2, 2, 1)
    test1(ax)
    ax.set_xlim(0., 1.)
    ax.set_ylim(0., 1.)
    ax.set_title("test1")
    ax.set_aspect(1.)

    ax = plt.subplot(2, 2, 2)
    ax.set_title("test2")
    test2(ax)
    ax.set_xlim(0., 1.)
    ax.set_ylim(0., 1.)
    ax.set_aspect(1.)

    ax = plt.subplot(2, 2, 3)
    ax.set_title("test3")
    test3(ax)
    ax.set_xlim(0., 1.)
    ax.set_ylim(0., 1.)
    ax.set_aspect(1)

    ax = plt.subplot(2, 2, 4)
    ax.set_title("test4")
    test4(ax)
    ax.set_xlim(-0.5, 1.5)
    ax.set_ylim(0., 1.)
    ax.set_aspect(2.)

    plt.draw()
    plt.show()

test_all()
```

Keywords: python, matplotlib, pylab, example, codex (see [Search examples](#))

99.72 pylab_examples example code: fancybox_demo2.py

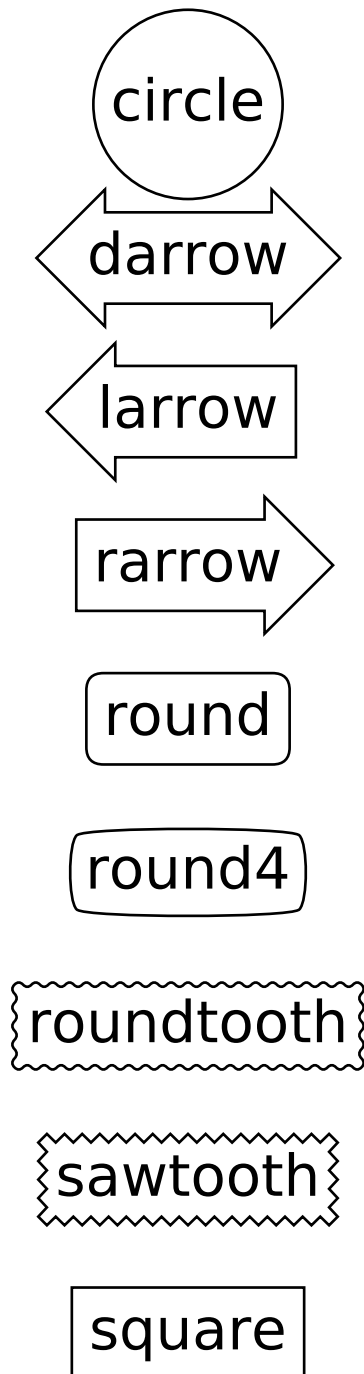

```
import matplotlib.patches as mpatch
import matplotlib.pyplot as plt

styles = mpatch.BoxStyle.get_styles()
```

```

spacing = 1.2

figheight = (spacing * len(styles) + .5)
fig1 = plt.figure(1, (4/1.5, figheight/1.5))
fontsize = 0.3 * 72

for i, stylename in enumerate(sorted(styles.keys())):
    fig1.text(0.5, (spacing * (float(len(styles)) - i) - 0.5)/figheight, stylename,
             ha="center",
             size=fontsize,
             transform=fig1.transFigure,
             bbox=dict(boxstyle=stylename, fc="w", ec="k"))

plt.draw()
plt.show()

```

Keywords: python, matplotlib, pylab, example, codex (see [Search examples](#))

99.73 pylab_examples example code: fancytextbox_demo.py

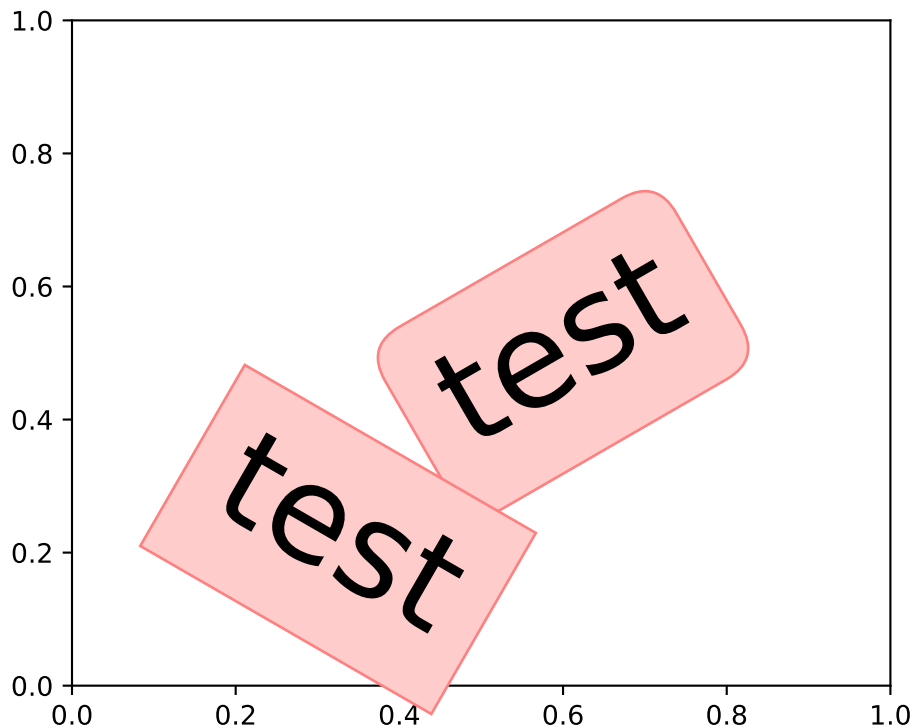

```

import matplotlib.pyplot as plt

plt.text(0.6, 0.5, "test", size=50, rotation=30.,

```

```
        ha="center", va="center",
        bbox=dict(boxstyle="round",
                  ec=(1., 0.5, 0.5),
                  fc=(1., 0.8, 0.8),
                  )
    )

plt.text(0.5, 0.4, "test", size=50, rotation=-30.,
        ha="right", va="top",
        bbox=dict(boxstyle="square",
                  ec=(1., 0.5, 0.5),
                  fc=(1., 0.8, 0.8),
                  )
        )

plt.draw()
plt.show()
```

Keywords: python, matplotlib, pylab, example, codex (see [Search examples](#))

99.74 pylab_examples example code: figimage_demo.py

```

"""
This illustrates placing images directly in the figure, with no axes.
"""
import numpy as np
import matplotlib
import matplotlib.cm as cm
import matplotlib.pyplot as plt

fig = plt.figure()
Z = np.arange(10000.0)
Z.shape = 100, 100
Z[:, 50:] = 1.

im1 = plt.figimage(Z, xo=50, yo=0, origin='lower')
im2 = plt.figimage(Z, xo=100, yo=100, alpha=.8, origin='lower')

plt.show()

```

Keywords: python, matplotlib, pylab, example, codex (see [Search examples](#))

99.75 pylab_examples example code: figlegend_demo.py

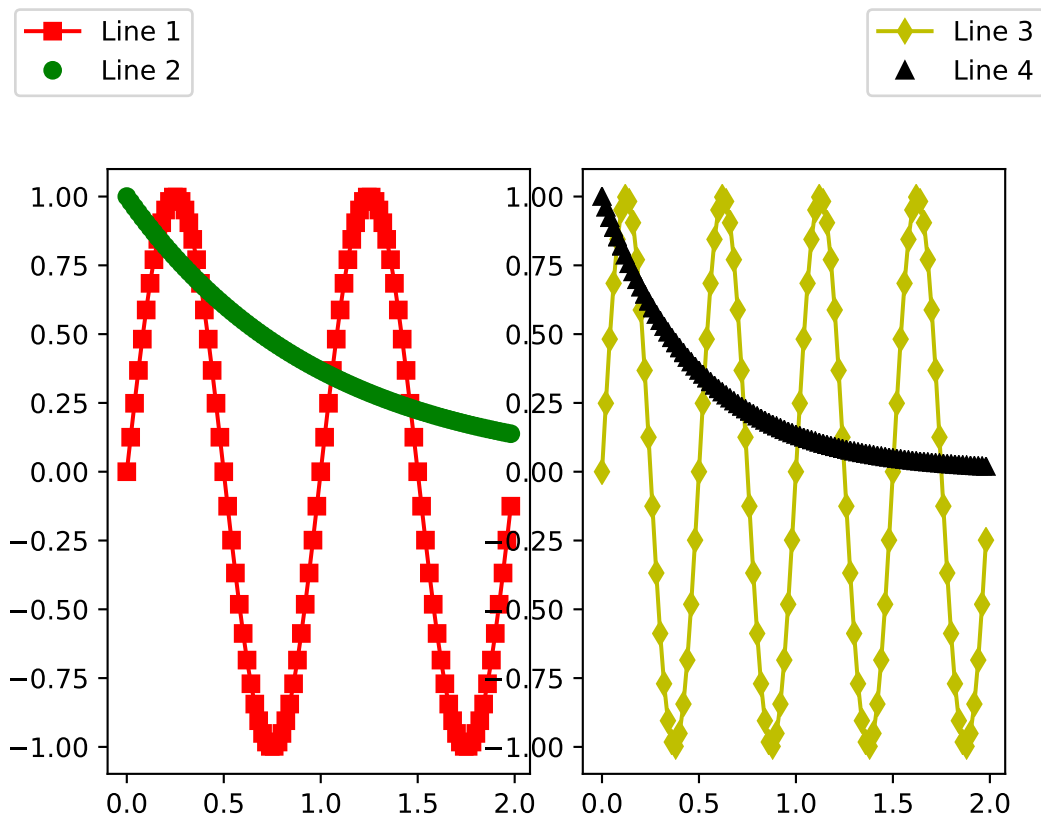

```

import numpy as np
import matplotlib.pyplot as plt

fig = plt.figure()
ax1 = fig.add_axes([0.1, 0.1, 0.4, 0.7])
ax2 = fig.add_axes([0.55, 0.1, 0.4, 0.7])

x = np.arange(0.0, 2.0, 0.02)
y1 = np.sin(2*np.pi*x)
y2 = np.exp(-x)
l1, l2 = ax1.plot(x, y1, 'rs-', x, y2, 'go')

y3 = np.sin(4*np.pi*x)
y4 = np.exp(-2*x)
l3, l4 = ax2.plot(x, y3, 'yd-', x, y4, 'k^')

fig.legend((l1, l2), ('Line 1', 'Line 2'), 'upper left')
fig.legend((l3, l4), ('Line 3', 'Line 4'), 'upper right')
plt.show()

```

Keywords: python, matplotlib, pylab, example, codex (see [Search examples](#))

99.76 pylab_examples example code: figure_title.py

This is a somewhat long figure title

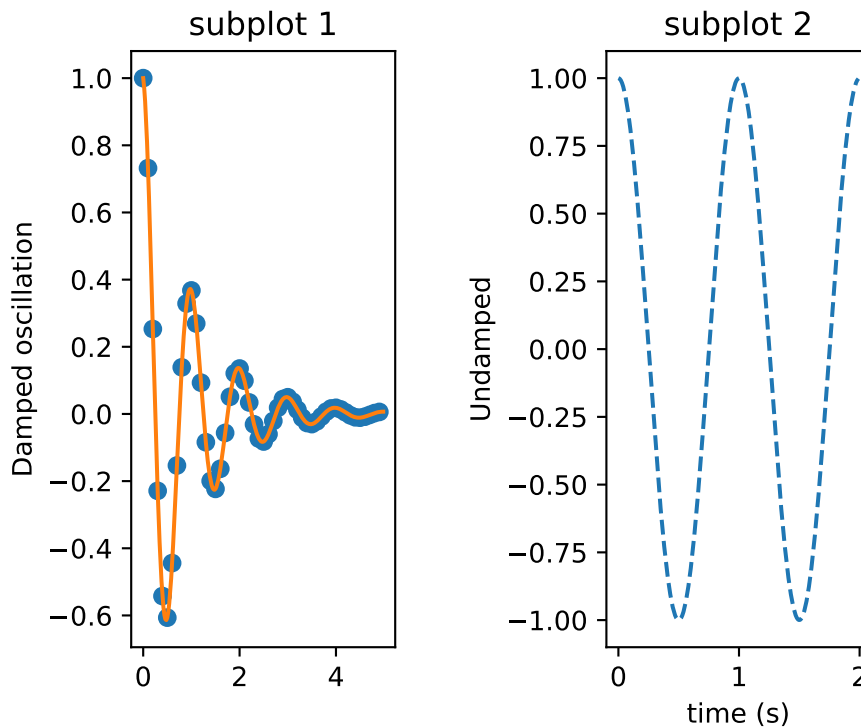

```
from matplotlib.font_manager import FontProperties
import matplotlib.pyplot as plt
import numpy as np

def f(t):
    s1 = np.cos(2*np.pi*t)
    e1 = np.exp(-t)
    return s1 * e1

t1 = np.arange(0.0, 5.0, 0.1)
t2 = np.arange(0.0, 5.0, 0.02)
t3 = np.arange(0.0, 2.0, 0.01)

plt.subplot(121)
plt.plot(t1, f(t1), 'o', t2, f(t2), '-')
plt.title('subplot 1')
plt.ylabel('Damped oscillation')
plt.suptitle('This is a somewhat long figure title', fontsize=16)

plt.subplot(122)
plt.plot(t3, np.cos(2*np.pi*t3), '--')
plt.xlabel('time (s)')
plt.title('subplot 2')
plt.ylabel('Undamped')

plt.subplots_adjust(left=0.2, wspace=0.8, top=0.8)

plt.show()
```

Keywords: python, matplotlib, pylab, example, codex (see [Search examples](#))

99.77 pylab_examples example code: fill_between_demo.py

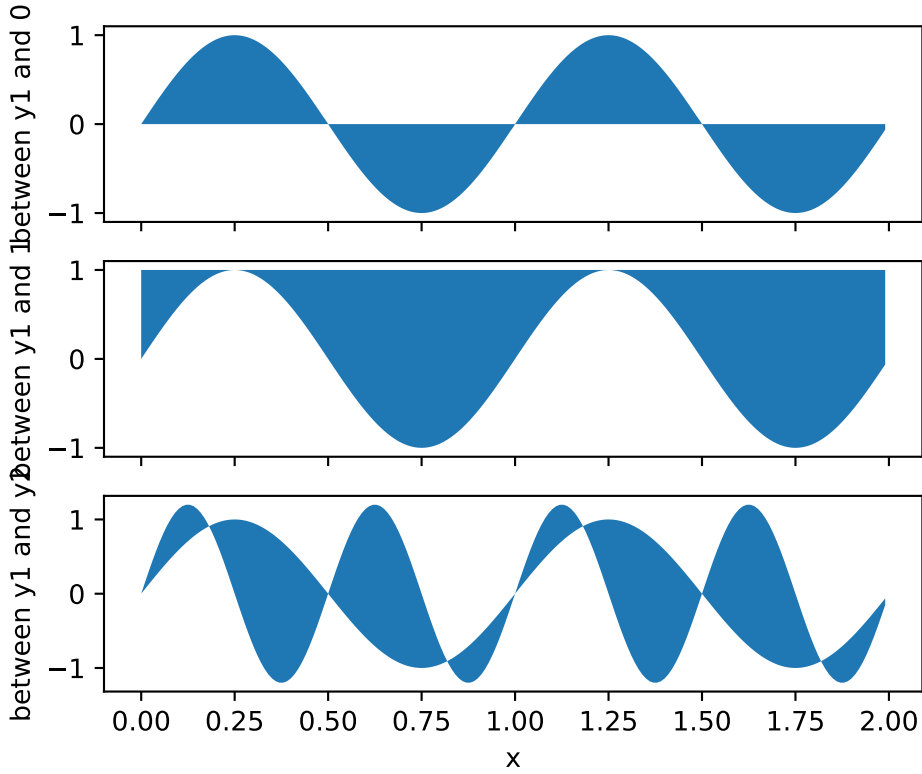

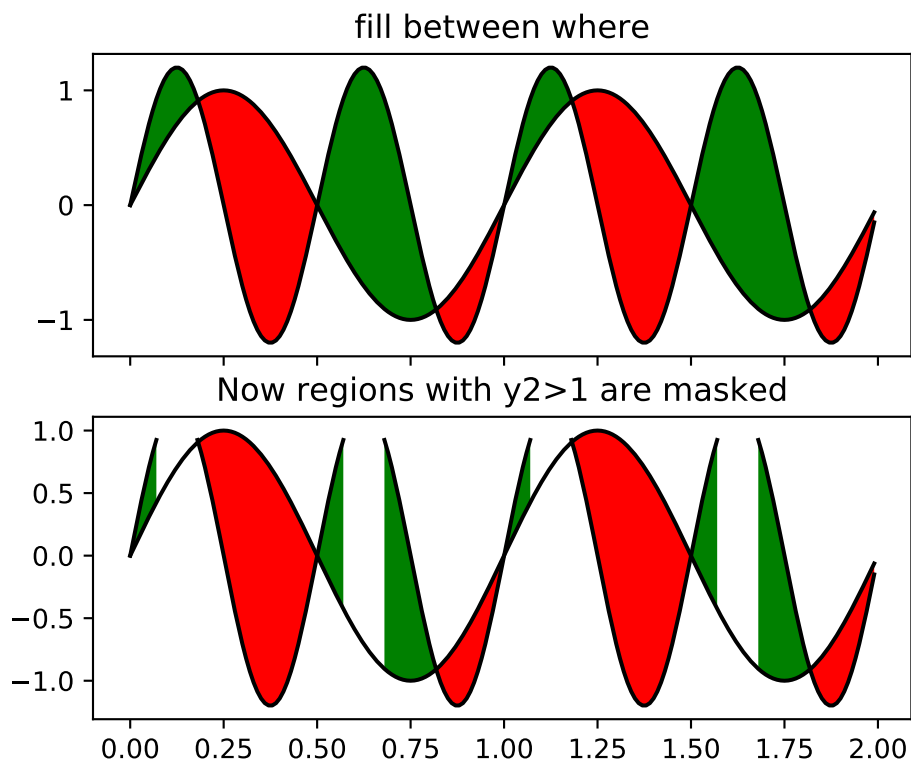

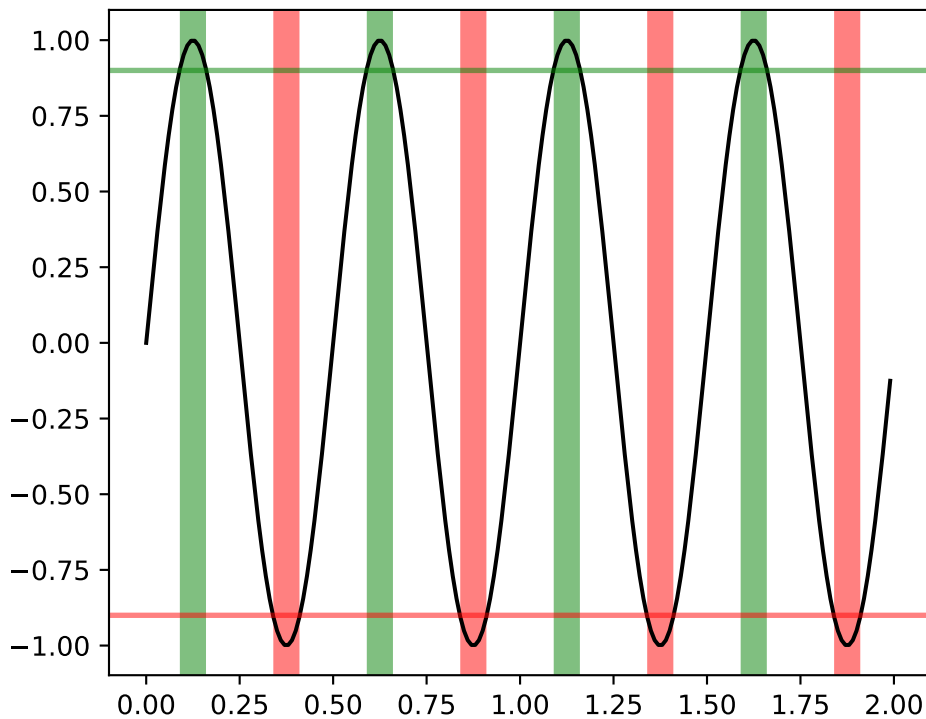

```

import matplotlib.pyplot as plt
import numpy as np

x = np.arange(0.0, 2, 0.01)
y1 = np.sin(2*np.pi*x)
y2 = 1.2*np.sin(4*np.pi*x)

fig, (ax1, ax2, ax3) = plt.subplots(3, 1, sharex=True)

ax1.fill_between(x, 0, y1)
ax1.set_ylabel('between y1 and 0')

ax2.fill_between(x, y1, 1)
ax2.set_ylabel('between y1 and 1')

ax3.fill_between(x, y1, y2)
ax3.set_ylabel('between y1 and y2')
ax3.set_xlabel('x')

# now fill between y1 and y2 where a logical condition is met. Note
# this is different than calling
# fill_between(x[where], y1[where], y2[where])
# because of edge effects over multiple contiguous regions.
fig, (ax, ax1) = plt.subplots(2, 1, sharex=True)
ax.plot(x, y1, x, y2, color='black')
ax.fill_between(x, y1, y2, where=y2 >= y1, facecolor='green', interpolate=True)

```

```
ax.fill_between(x, y1, y2, where=y2 <= y1, facecolor='red', interpolate=True)
ax.set_title('fill between where')

# Test support for masked arrays.
y2 = np.ma.masked_greater(y2, 1.0)
ax1.plot(x, y1, x, y2, color='black')
ax1.fill_between(x, y1, y2, where=y2 >= y1, facecolor='green', interpolate=True)
ax1.fill_between(x, y1, y2, where=y2 <= y1, facecolor='red', interpolate=True)
ax1.set_title('Now regions with y2>1 are masked')

# This example illustrates a problem; because of the data
# gridding, there are undesired unfilled triangles at the crossover
# points. A brute-force solution would be to interpolate all
# arrays to a very fine grid before plotting.

# show how to use transforms to create axes spans where a certain condition is satisfied
fig, ax = plt.subplots()
y = np.sin(4*np.pi*x)
ax.plot(x, y, color='black')

# use the data coordinates for the x-axis and the axes coordinates for the y-axis
import matplotlib.transforms as mtransforms
trans = mtransforms.blended_transform_factory(ax.transData, ax.transAxes)
theta = 0.9
ax.axhline(theta, color='green', lw=2, alpha=0.5)
ax.axhline(-theta, color='red', lw=2, alpha=0.5)
ax.fill_between(x, 0, 1, where=y > theta, facecolor='green', alpha=0.5, transform=trans)
ax.fill_between(x, 0, 1, where=y < -theta, facecolor='red', alpha=0.5, transform=trans)

plt.show()
```

Keywords: python, matplotlib, pylab, example, codex (see [Search examples](#))

99.78 pylab_examples example code: fill_betweenx_demo.py

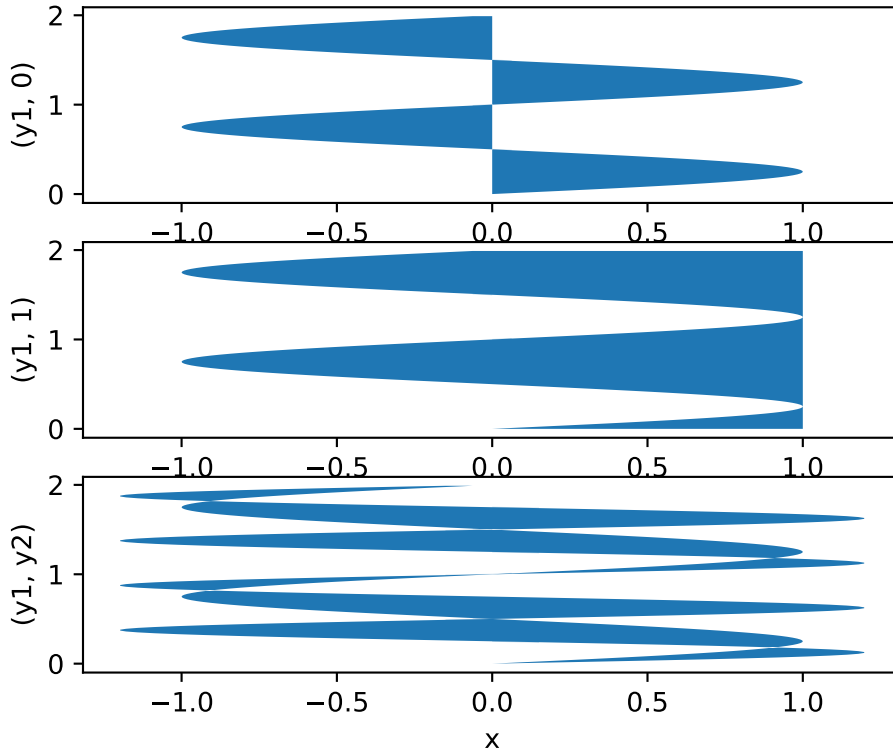

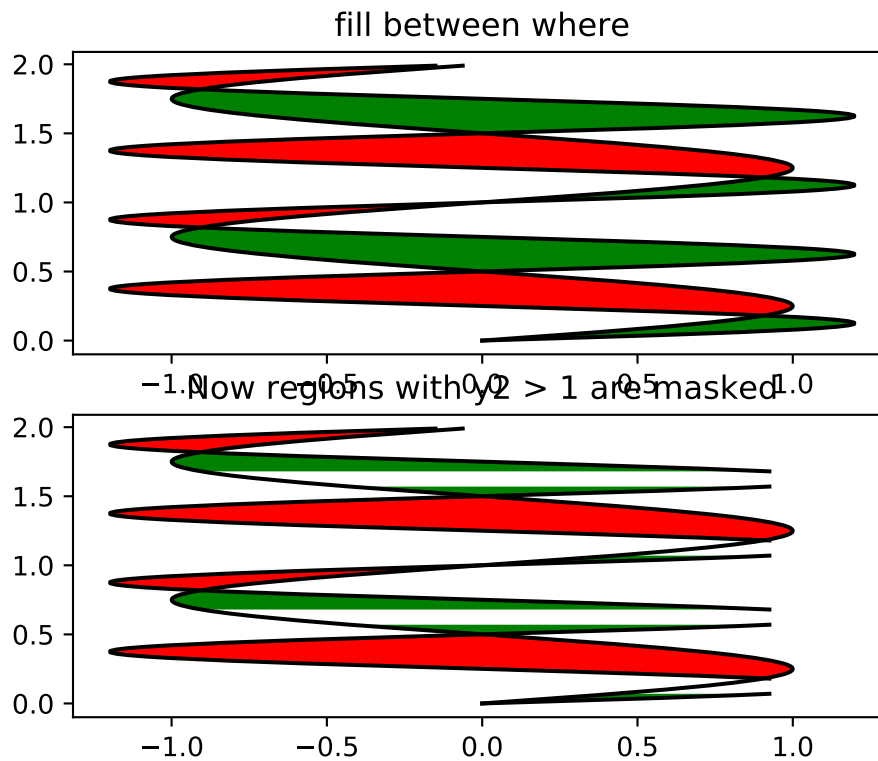

```

"""
Copy of fill_between.py but using fill_betweenx() instead.
"""
import matplotlib.mlab as mlab
from matplotlib.pyplot import figure, show
import numpy as np

x = np.arange(0.0, 2, 0.01)
y1 = np.sin(2*np.pi*x)
y2 = 1.2*np.sin(4*np.pi*x)

fig = figure()
ax1 = fig.add_subplot(311)
ax2 = fig.add_subplot(312, sharex=ax1)
ax3 = fig.add_subplot(313, sharex=ax1)

ax1.fill_betweenx(x, 0, y1)
ax1.set_ylabel('(y1, 0)')

ax2.fill_betweenx(x, y1, 1)
ax2.set_ylabel('(y1, 1)')

ax3.fill_betweenx(x, y1, y2)
ax3.set_ylabel('(y1, y2)')
ax3.set_xlabel('x')

```

```
# now fill between y1 and y2 where a logical condition is met. Note
# this is different than calling
# fill_between(x[where], y1[where],y2[where]
# because of edge effects over multiple contiguous regions.
fig = figure()
ax = fig.add_subplot(211)
ax.plot(y1, x, y2, x, color='black')
ax.fill_betweenx(x, y1, y2, where=y2 >= y1, facecolor='green')
ax.fill_betweenx(x, y1, y2, where=y2 <= y1, facecolor='red')
ax.set_title('fill between where')

# Test support for masked arrays.
y2 = np.ma.masked_greater(y2, 1.0)
ax1 = fig.add_subplot(212, sharex=ax)
ax1.plot(y1, x, y2, x, color='black')
ax1.fill_betweenx(x, y1, y2, where=y2 >= y1, facecolor='green')
ax1.fill_betweenx(x, y1, y2, where=y2 <= y1, facecolor='red')
ax1.set_title('Now regions with y2 > 1 are masked')

# This example illustrates a problem; because of the data
# gridding, there are undesired unfilled triangles at the crossover
# points. A brute-force solution would be to interpolate all
# arrays to a very fine grid before plotting.

show()
```

Keywords: python, matplotlib, pylab, example, codex (see [Search examples](#))

99.79 pylab_examples example code: fill_spiral.py

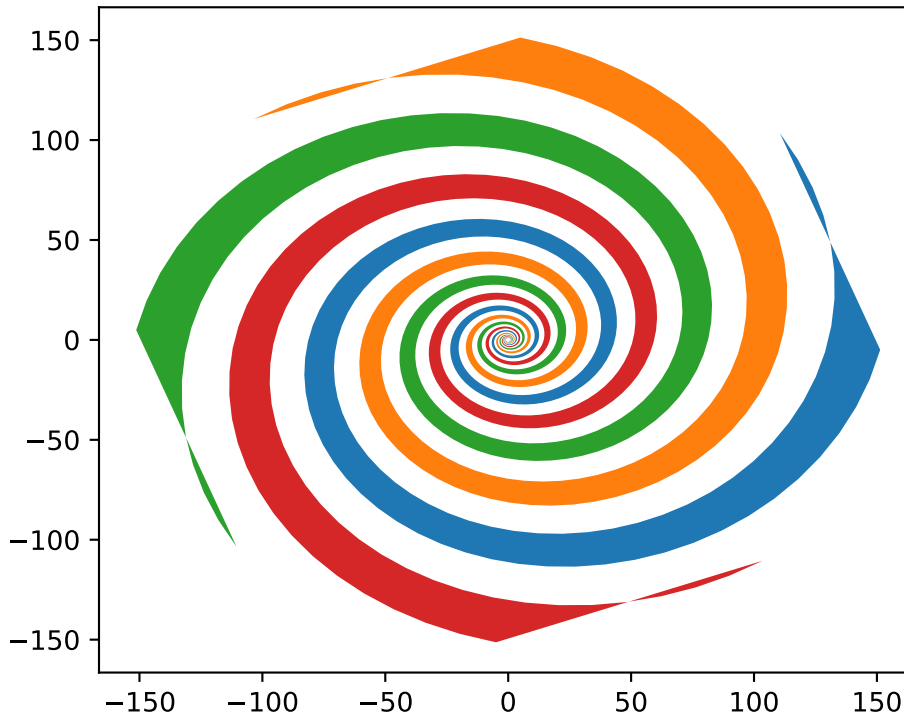

```
import matplotlib.pyplot as plt
import numpy as np

theta = np.arange(0, 8*np.pi, 0.1)
a = 1
b = .2

for dt in np.arange(0, 2*np.pi, np.pi/2.0):

    x = a*np.cos(theta + dt)*np.exp(b*theta)
    y = a*np.sin(theta + dt)*np.exp(b*theta)

    dt = dt + np.pi/4.0

    x2 = a*np.cos(theta + dt)*np.exp(b*theta)
    y2 = a*np.sin(theta + dt)*np.exp(b*theta)

    xf = np.concatenate((x, x2[::-1]))
    yf = np.concatenate((y, y2[::-1]))

    p1 = plt.fill(xf, yf)
```

```
plt.show()
```

Keywords: python, matplotlib, pylab, example, codex (see *Search examples*)

99.80 pylab_examples example code: findobj_demo.py

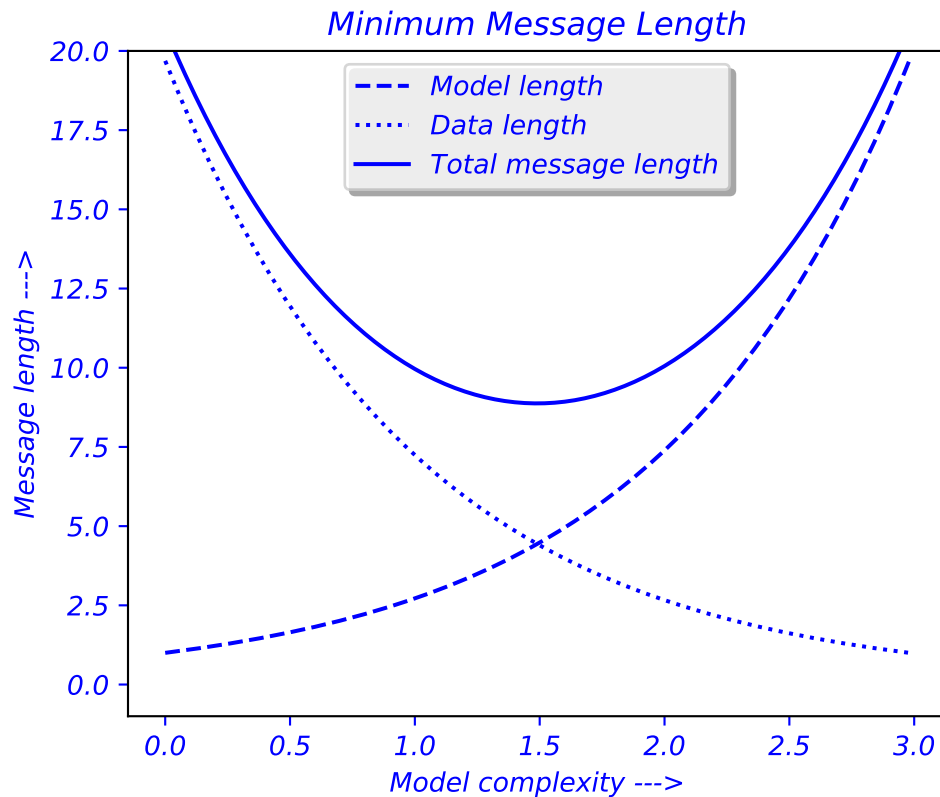

```

"""
Recursively find all objects that match some criteria
"""
import numpy as np
import matplotlib.pyplot as plt
import matplotlib.text as text

a = np.arange(0, 3, .02)
b = np.arange(0, 3, .02)
c = np.exp(a)
d = c[::-1]

fig, ax = plt.subplots()
plt.plot(a, c, 'k--', a, d, 'k:', a, c + d, 'k')
plt.legend(('Model length', 'Data length', 'Total message length'),
          loc='upper center', shadow=True)

```

```

plt.ylim([-1, 20])
plt.grid(False)
plt.xlabel('Model complexity --->')
plt.ylabel('Message length --->')
plt.title('Minimum Message Length')

# match on arbitrary function
def myfunc(x):
    return hasattr(x, 'set_color') and not hasattr(x, 'set_facecolor')

for o in fig.findobj(myfunc):
    o.set_color('blue')

# match on class instances
for o in fig.findobj(text.Text):
    o.set_fontstyle('italic')

plt.show()

```

Keywords: python, matplotlib, pylab, example, codex (see *Search examples*)

99.81 pylab_examples example code: font_table_ttf.py

[source code]

```

# -*- noplots -*-
"""
matplotlib has support for FreeType fonts. Here's a little example
using the 'table' command to build a font table that shows the glyphs
by character code.

Usage python font_table_ttf.py somefile.ttf
"""

import sys
import os

import matplotlib
from matplotlib.ft2font import FT2Font
from matplotlib.font_manager import FontProperties
import matplotlib.pyplot as plt

import six
from six import unichr

# the font table grid

labelc = ['0', '1', '2', '3', '4', '5', '6', '7', '8', '9',
          'A', 'B', 'C', 'D', 'E', 'F']

```

```

labelr = ['00', '10', '20', '30', '40', '50', '60', '70', '80', '90',
          'A0', 'B0', 'C0', 'D0', 'E0', 'F0']

if len(sys.argv) > 1:
    fontname = sys.argv[1]
else:
    fontname = os.path.join(matplotlib.get_data_path(),
                            'fonts', 'ttf', 'DejaVuSans.ttf')

font = FT2Font(fontname)
codes = list(font.get_charmap().items())
codes.sort()

# a 16,16 array of character strings
chars = [['' for c in range(16)] for r in range(16)]
colors = [[(0.95, 0.95, 0.95) for c in range(16)] for r in range(16)]

plt.figure(figsize=(8, 4), dpi=120)
for ccode, glyphind in codes:
    if ccode >= 256:
        continue
    r, c = divmod(ccode, 16)
    s = unichr(ccode)
    chars[r][c] = s

lightgrn = (0.5, 0.8, 0.5)
plt.title(fontname)
tab = plt.table(cellText=chars,
                rowLabels=labelr,
                colLabels=labelc,
                rowColours=[lightgrn]*16,
                colColours=[lightgrn]*16,
                cellColours=colors,
                cellLoc='center',
                loc='upper left')

for key, cell in tab.get_celld().items():
    row, col = key
    if row > 0 and col > 0:
        cell.set_text_props(fontproperties=FontProperties(fname=fontname))
plt.axis('off')
plt.show()

```

Keywords: python, matplotlib, pylab, example, codex (see [Search examples](#))

99.82 pylab_examples example code: fonts_demo.py

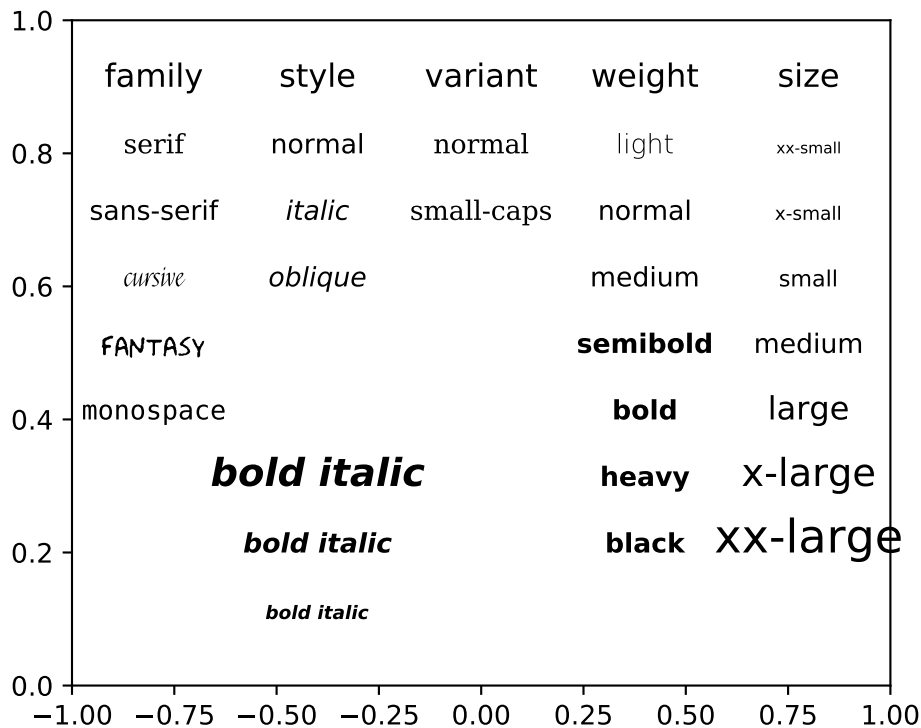

```

"""
Show how to set custom font properties.

For interactive users, you can also use kwargs to the text command,
which requires less typing. See examples/fonts_demo_kw.py
"""
from matplotlib.font_manager import FontProperties
import matplotlib.pyplot as plt

plt.subplot(111, facecolor='w')

font0 = FontProperties()
alignment = {'horizontalalignment': 'center', 'verticalalignment': 'baseline'}
# Show family options

families = ['serif', 'sans-serif', 'cursive', 'fantasy', 'monospace']

font1 = font0.copy()
font1.set_size('large')

t = plt.text(-0.8, 0.9, 'family', fontproperties=font1,
             **alignment)

```

```
yp = [0.8, 0.7, 0.6, 0.5, 0.4, 0.3, 0.2]

for k, family in enumerate(families):
    font = font0.copy()
    font.set_family(family)
    t = plt.text(-0.8, yp[k], family, fontproperties=font,
                **alignment)

# Show style options

styles = ['normal', 'italic', 'oblique']

t = plt.text(-0.4, 0.9, 'style', fontproperties=font1,
            **alignment)

for k, style in enumerate(styles):
    font = font0.copy()
    font.set_family('sans-serif')
    font.set_style(style)
    t = plt.text(-0.4, yp[k], style, fontproperties=font,
                **alignment)

# Show variant options

variants = ['normal', 'small-caps']

t = plt.text(0.0, 0.9, 'variant', fontproperties=font1,
            **alignment)

for k, variant in enumerate(variants):
    font = font0.copy()
    font.set_family('serif')
    font.set_variant(variant)
    t = plt.text(0.0, yp[k], variant, fontproperties=font,
                **alignment)

# Show weight options

weights = ['light', 'normal', 'medium', 'semibold', 'bold', 'heavy', 'black']

t = plt.text(0.4, 0.9, 'weight', fontproperties=font1,
            **alignment)

for k, weight in enumerate(weights):
    font = font0.copy()
    font.set_weight(weight)
    t = plt.text(0.4, yp[k], weight, fontproperties=font,
                **alignment)

# Show size options

sizes = ['xx-small', 'x-small', 'small', 'medium', 'large',
```

```
    'x-large', 'xx-large']

t = plt.text(0.8, 0.9, 'size', fontproperties=font1,
            **alignment)

for k, size in enumerate(sizes):
    font = font0.copy()
    font.set_size(size)
    t = plt.text(0.8, yp[k], size, fontproperties=font,
                **alignment)

# Show bold italic

font = font0.copy()
font.set_style('italic')
font.set_weight('bold')
font.set_size('x-small')
t = plt.text(-0.4, 0.1, 'bold italic', fontproperties=font,
            **alignment)

font = font0.copy()
font.set_style('italic')
font.set_weight('bold')
font.set_size('medium')
t = plt.text(-0.4, 0.2, 'bold italic', fontproperties=font,
            **alignment)

font = font0.copy()
font.set_style('italic')
font.set_weight('bold')
font.set_size('x-large')
t = plt.text(-0.4, 0.3, 'bold italic', fontproperties=font,
            **alignment)

plt.axis([-1, 1, 0, 1])

plt.show()
```

Keywords: python, matplotlib, pylab, example, codex (see [Search examples](#))

99.83 pylab_examples example code: fonts_demo_kw.py

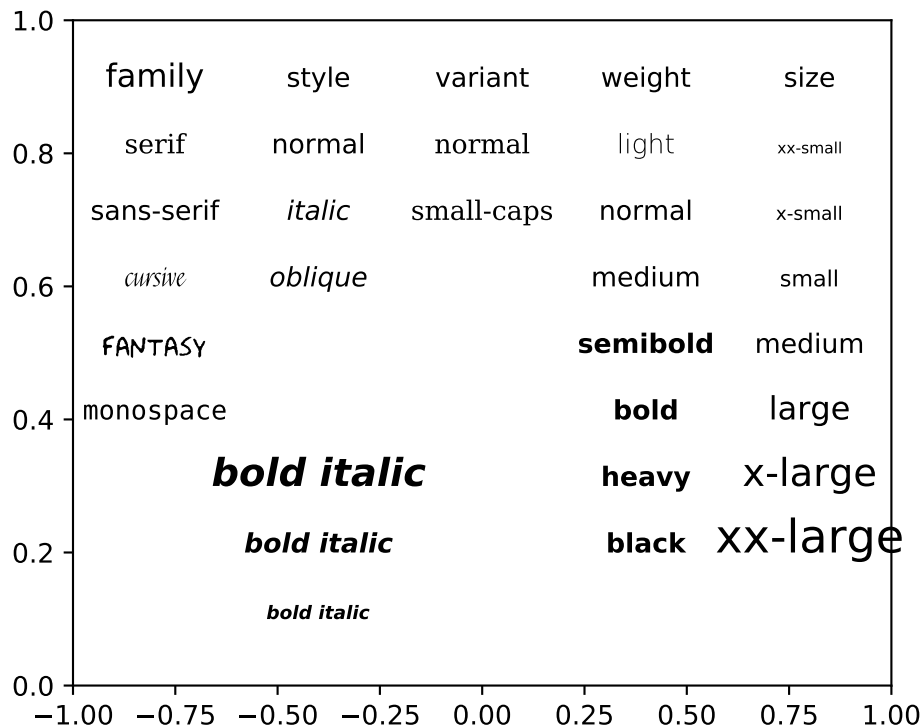

```

"""
Same as fonts_demo using kwargs.  If you prefer a more pythonic, OO
style of coding, see examples/fonts_demo.py.
"""

from matplotlib.font_manager import FontProperties
import matplotlib.pyplot as plt
import numpy as np

plt.subplot(111, facecolor='w')
alignment = {'horizontalalignment': 'center', 'verticalalignment': 'baseline'}

# Show family options

families = ['serif', 'sans-serif', 'cursive', 'fantasy', 'monospace']

t = plt.text(-0.8, 0.9, 'family', size='large', **alignment)

yp = [0.8, 0.7, 0.6, 0.5, 0.4, 0.3, 0.2]

for k, family in enumerate(families):
    t = plt.text(-0.8, yp[k], family, family=family, **alignment)

```



```
# Show style options

styles = ['normal', 'italic', 'oblique']

t = plt.text(-0.4, 0.9, 'style', **alignment)

for k, style in enumerate(styles):
    t = plt.text(-0.4, yp[k], style, family='sans-serif', style=style,
                **alignment)

# Show variant options

variants = ['normal', 'small-caps']

t = plt.text(0.0, 0.9, 'variant', **alignment)

for k, variant in enumerate(variants):
    t = plt.text(0.0, yp[k], variant, family='serif', variant=variant,
                **alignment)

# Show weight options

weights = ['light', 'normal', 'medium', 'semibold', 'bold', 'heavy', 'black']

t = plt.text(0.4, 0.9, 'weight', **alignment)

for k, weight in enumerate(weights):
    t = plt.text(0.4, yp[k], weight, weight=weight,
                **alignment)

# Show size options

sizes = ['xx-small', 'x-small', 'small', 'medium', 'large',
        'x-large', 'xx-large']

t = plt.text(0.8, 0.9, 'size', **alignment)

for k, size in enumerate(sizes):
    t = plt.text(0.8, yp[k], size, size=size,
                **alignment)

x = -0.4
# Show bold italic
t = plt.text(x, 0.1, 'bold italic', style='italic',
            weight='bold', size='x-small',
            **alignment)

t = plt.text(x, 0.2, 'bold italic',
            style='italic', weight='bold', size='medium',
            **alignment)

t = plt.text(x, 0.3, 'bold italic',
```

```

        style='italic', weight='bold', size='x-large',
        **alignment)

plt.axis([-1, 1, 0, 1])

plt.show()

```

Keywords: python, matplotlib, pylab, example, codex (see *Search examples*)

99.84 pylab_examples example code: ganged_plots.py

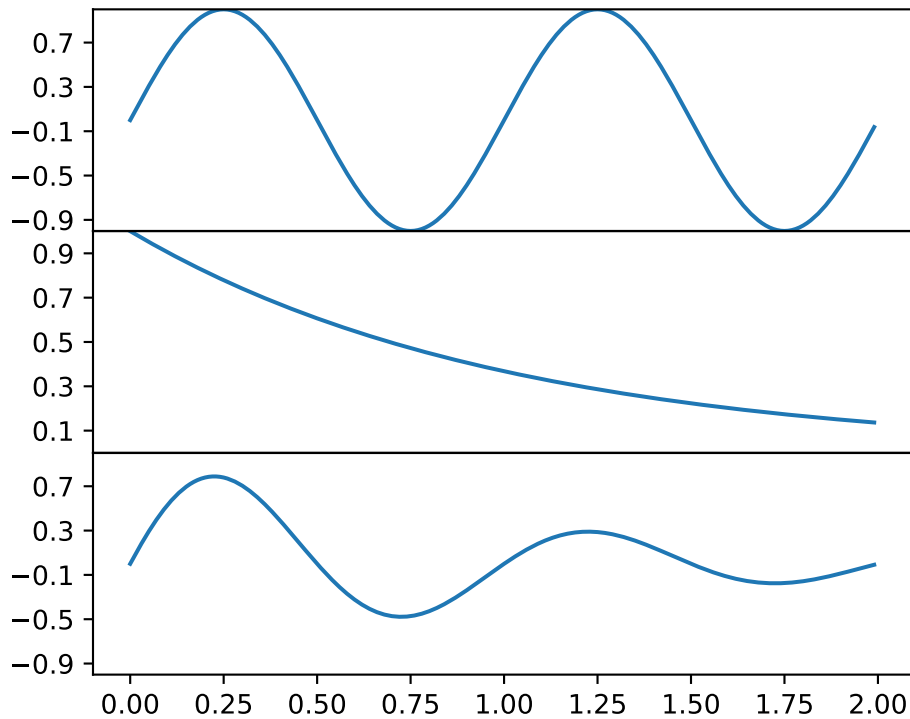

```

"""
To create plots that share a common axes (visually) you can set the
hspace between the subplots close to zero (do not use zero itself).
Normally you'll want to turn off the tick labels on all but one of the
axes.

In this example the plots share a common xaxis but you can follow the
same logic to supply a common y axis.
"""
import matplotlib.pyplot as plt
import numpy as np

```

```
t = np.arange(0.0, 2.0, 0.01)

s1 = np.sin(2*np.pi*t)
s2 = np.exp(-t)
s3 = s1*s2

# axes rect in relative 0,1 coords left, bottom, width, height. Turn
# off xtick labels on all but the lower plot

f = plt.figure()
plt.subplots_adjust(hspace=0.001)

ax1 = plt.subplot(311)
ax1.plot(t, s1)
plt.yticks(np.arange(-0.9, 1.0, 0.4))
plt.ylim(-1, 1)

ax2 = plt.subplot(312, sharex=ax1)
ax2.plot(t, s2)
plt.yticks(np.arange(0.1, 1.0, 0.2))
plt.ylim(0, 1)

ax3 = plt.subplot(313, sharex=ax1)
ax3.plot(t, s3)
plt.yticks(np.arange(-0.9, 1.0, 0.4))
plt.ylim(-1, 1)

xticklabels = ax1.get_xticklabels() + ax2.get_xticklabels()
plt.setp(xticklabels, visible=False)

plt.show()
```

Keywords: python, matplotlib, pylab, example, codex (see [Search examples](#))

99.85 pylab_examples example code: geo_demo.py

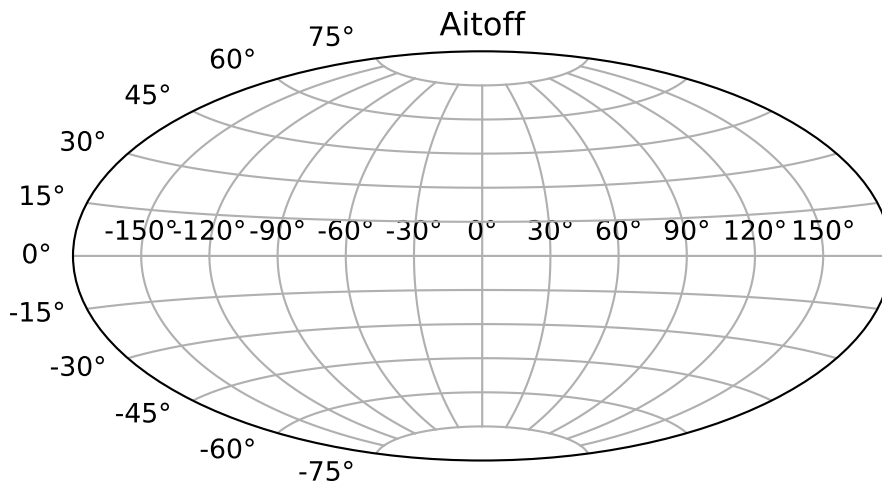

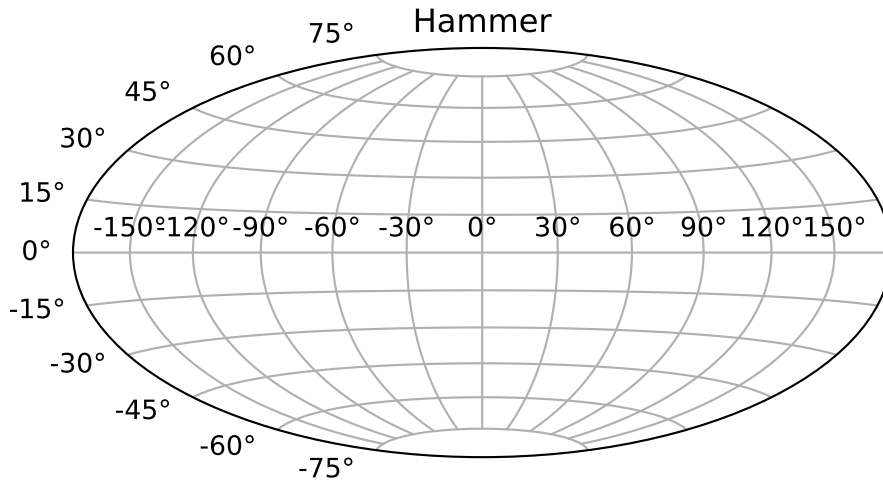

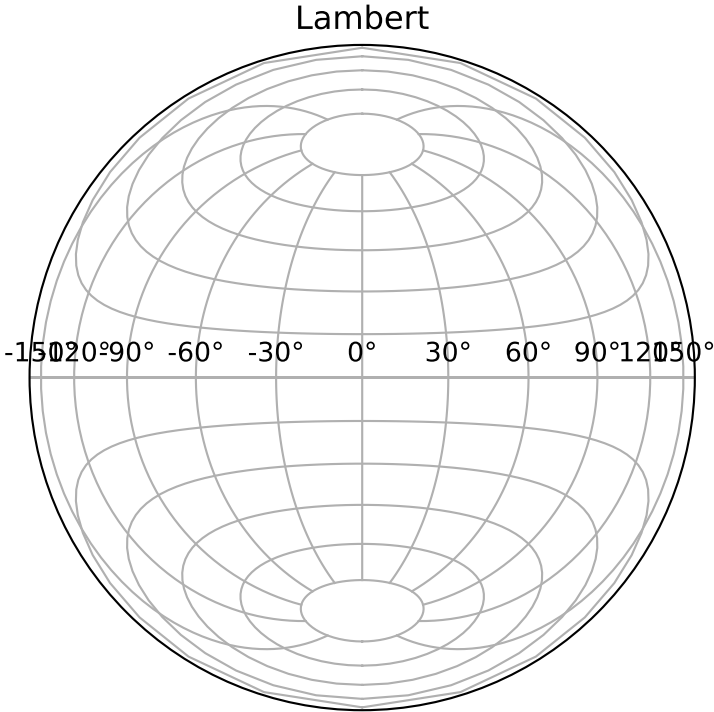

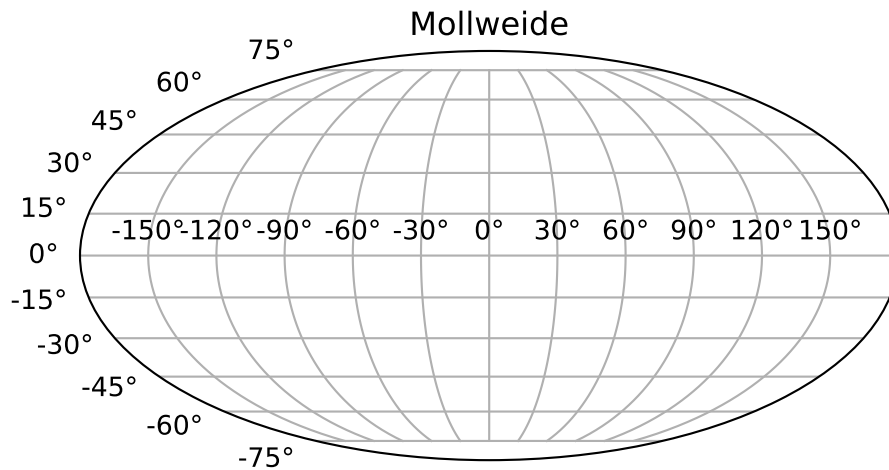

```
import matplotlib.pyplot as plt

plt.figure()
plt.subplot(111, projection="aitoff")
plt.title("Aitoff")
plt.grid(True)

plt.figure()
plt.subplot(111, projection="hammer")
plt.title("Hammer")
plt.grid(True)

plt.figure()
plt.subplot(111, projection="lambert")
plt.title("Lambert")
plt.grid(True)

plt.figure()
plt.subplot(111, projection="mollweide")
plt.title("Mollweide")
plt.grid(True)

plt.show()
```

Keywords: python, matplotlib, pylab, example, codex (see [Search examples](#))

99.86 pylab_examples example code: ginput_demo.py

[source code]

```
# -*- noplots -*-

from __future__ import print_function

import matplotlib.pyplot as plt
import numpy as np
t = np.arange(10)
plt.plot(t, np.sin(t))
print("Please click")
x = plt.ginput(3)
print("clicked", x)
plt.show()
```

Keywords: python, matplotlib, pylab, example, codex (see *Search examples*)

99.87 pylab_examples example code: ginput_manual_clabel.py

[source code]

```
# -*- noplots -*-

from __future__ import print_function
"""
This provides examples of uses of interactive functions, such as ginput,
waitforbuttonpress and manual clabel placement.

This script must be run interactively using a backend that has a
graphical user interface (for example, using GTKAgg backend, but not
PS backend).

See also ginput_demo.py
"""
import time
import matplotlib
import numpy as np
import matplotlib.cm as cm
import matplotlib.mlab as mlab
import matplotlib.pyplot as plt

def tellme(s):
    print(s)
    plt.title(s, fontsize=16)
    plt.draw()

#####
# Define a triangle by clicking three points
```



```
#####
plt.clf()
plt.axis([-1., 1., -1., 1.])
plt.setp(plt.gca(), autoscale_on=False)

tellme('You will define a triangle, click to begin')

plt.waitforbuttonpress()

happy = False
while not happy:
    pts = []
    while len(pts) < 3:
        tellme('Select 3 corners with mouse')
        pts = np.asarray(plt.ginput(3, timeout=-1))
        if len(pts) < 3:
            tellme('Too few points, starting over')
            time.sleep(1) # Wait a second

    ph = plt.fill(pts[:, 0], pts[:, 1], 'r', lw=2)

    tellme('Happy? Key click for yes, mouse click for no')

    happy = plt.waitforbuttonpress()

    # Get rid of fill
    if not happy:
        for p in ph:
            p.remove()

#####
# Now contour according to distance from triangle
# corners - just an example
#####

# Define a nice function of distance from individual pts
def f(x, y, pts):
    z = np.zeros_like(x)
    for p in pts:
        z = z + 1/(np.sqrt((x - p[0])**2 + (y - p[1])**2))
    return 1/z

X, Y = np.meshgrid(np.linspace(-1, 1, 51), np.linspace(-1, 1, 51))
Z = f(X, Y, pts)

CS = plt.contour(X, Y, Z, 20)

tellme('Use mouse to select contour label locations, middle button to finish')
CL = plt.clabel(CS, manual=True)

#####
# Now do a zoom
```

```
#####  
tellme('Now do a nested zoom, click to begin')  
plt.waitforbuttonpress()  
  
happy = False  
while not happy:  
    tellme('Select two corners of zoom, middle mouse button to finish')  
    pts = np.asarray(plt.ginput(2, timeout=-1))  
  
    happy = len(pts) < 2  
    if happy:  
        break  
  
    pts = np.sort(pts, axis=0)  
    plt.axis(pts.T.ravel())  
  
tellme('All Done!')  
plt.show()
```

Keywords: python, matplotlib, pylab, example, codex (see [Search examples](#))

99.88 pylab_examples example code: gradient_bar.py

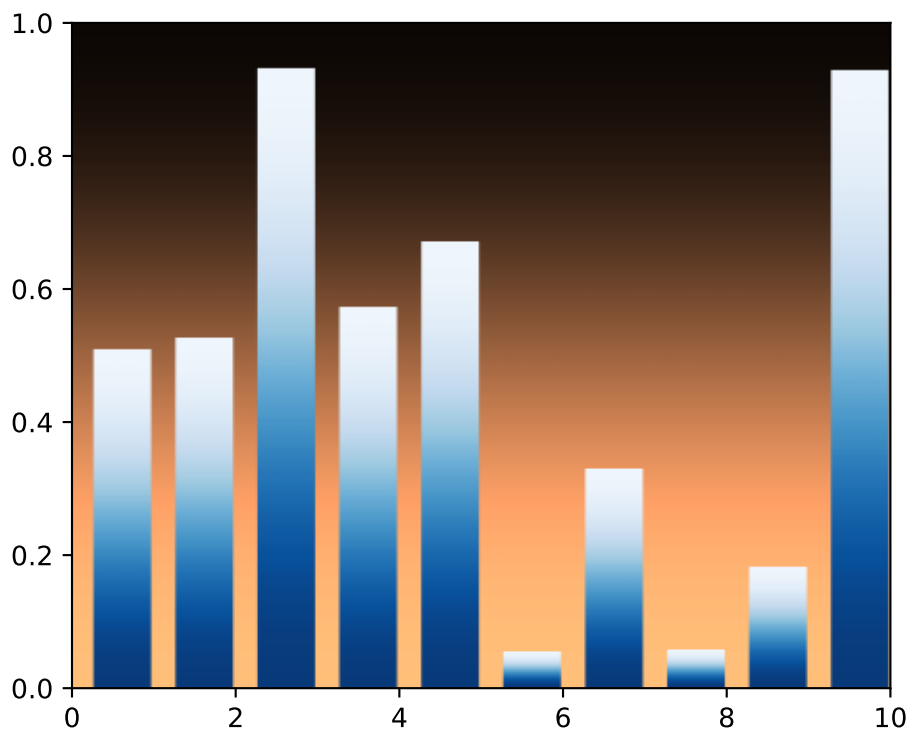

```
from matplotlib.pyplot import figure, show, cm
from numpy import arange
from numpy.random import rand

def gbar(ax, x, y, width=0.5, bottom=0):
    X = [[.6, .6], [.7, .7]]
    for left, top in zip(x, y):
        right = left + width
        ax.imshow(X, interpolation='bicubic', cmap=cm.Blues,
                  extent=(left, right, bottom, top), alpha=1)

fig = figure()

xmin, xmax = xlim = 0, 10
ymin, ymax = ylim = 0, 1
ax = fig.add_subplot(111, xlim=xlim, ylim=ylim,
                     autoscale_on=False)
X = [[.6, .6], [.7, .7]]

ax.imshow(X, interpolation='bicubic', cmap=cm.copper,
          extent=(xmin, xmax, ymin, ymax), alpha=1)

N = 10
x = arange(N) + 0.25
y = rand(N)
gbar(ax, x, y, width=0.7)
ax.set_aspect('auto')
show()
```

Keywords: python, matplotlib, pylab, example, codex (see [Search examples](#))

99.89 pylab_examples example code: griddata_demo.py

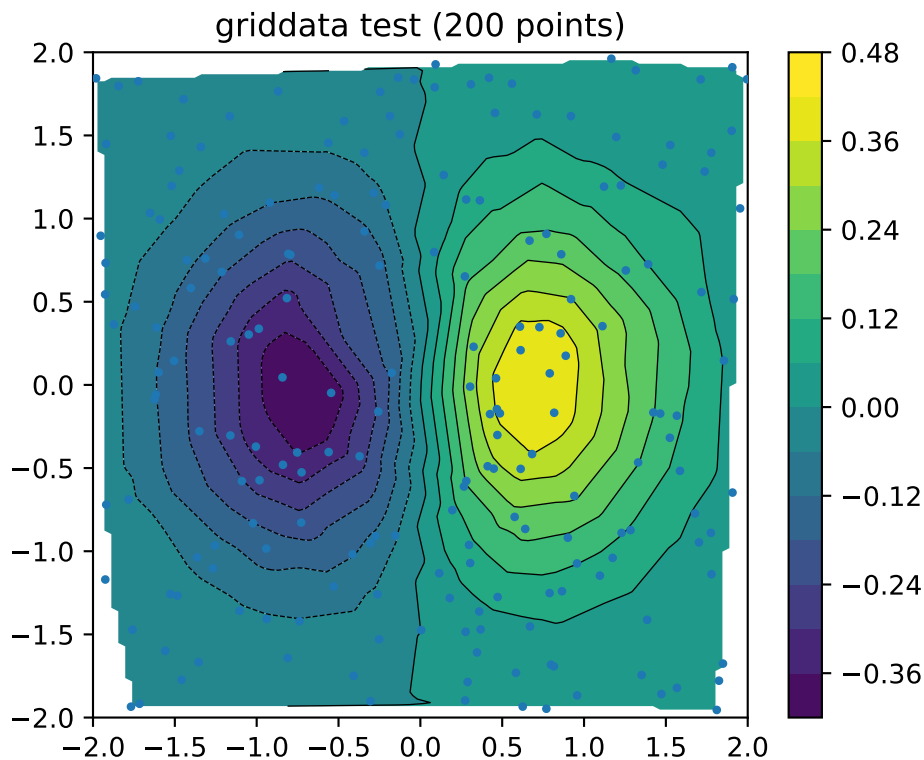

```

from numpy.random import uniform, seed
from matplotlib.mlab import griddata
import matplotlib.pyplot as plt
import numpy as np
# make up data.
#npts = int(raw_input('enter # of random points to plot:'))
seed(0)
npts = 200
x = uniform(-2, 2, npts)
y = uniform(-2, 2, npts)
z = x*np.exp(-x**2 - y**2)
# define grid.
xi = np.linspace(-2.1, 2.1, 100)
yi = np.linspace(-2.1, 2.1, 200)
# grid the data.
zi = griddata(x, y, z, xi, yi, interp='linear')
# contour the gridded data, plotting dots at the nonuniform data points.
CS = plt.contour(xi, yi, zi, 15, linewidths=0.5, colors='k')
CS = plt.contourf(xi, yi, zi, 15,
                  vmax=abs(zi).max(), vmin=-abs(zi).max())
plt.colorbar() # draw colorbar
# plot data points.

```

```
plt.scatter(x, y, marker='o', s=5, zorder=10)
plt.xlim(-2, 2)
plt.ylim(-2, 2)
plt.title('griddata test (%d points)' % npts)
plt.show()
```

Keywords: python, matplotlib, pylab, example, codex (see [Search examples](#))

99.90 pylab_examples example code: hatch_demo.py

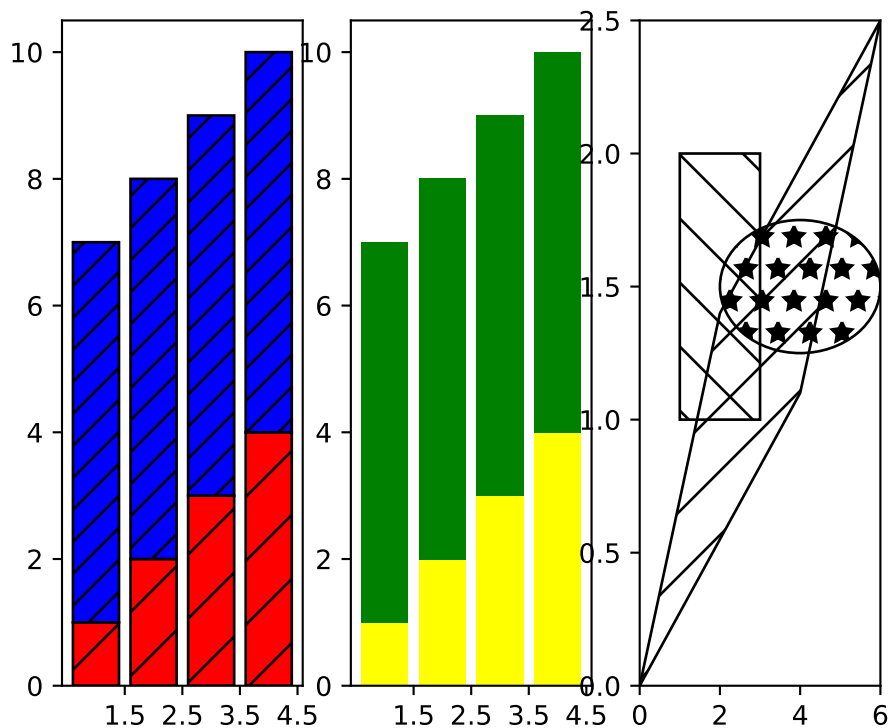

```
"""
Hatching (pattern filled polygons) is supported currently in the PS,
PDF, SVG and Agg backends only.
"""
import matplotlib.pyplot as plt
from matplotlib.patches import Ellipse, Polygon

fig = plt.figure()
ax1 = fig.add_subplot(131)
ax1.bar(range(1, 5), range(1, 5), color='red', edgecolor='black', hatch="//")
ax1.bar(range(1, 5), [6] * 4, bottom=range(1, 5), color='blue', edgecolor='black', hatch=
  ↪'//')
```

```

ax1.set_xticks([1.5, 2.5, 3.5, 4.5])

ax2 = fig.add_subplot(132)
bars = ax2.bar(range(1, 5), range(1, 5), color='yellow', ecolor='black') + \
    ax2.bar(range(1, 5), [6] * 4, bottom=range(1, 5), color='green', ecolor='black')
ax2.set_xticks([1.5, 2.5, 3.5, 4.5])

patterns = ('-', '+', 'x', '\\\\', '*', 'o', '0', '.')
for bar, pattern in zip(bars, patterns):
    bar.set_hatch(pattern)

ax3 = fig.add_subplot(133)
ax3.fill([1, 3, 3, 1], [1, 1, 2, 2], fill=False, hatch='\\\\')
ax3.add_patch(Ellipse((4, 1.5), 4, 0.5, fill=False, hatch='*'))
ax3.add_patch(Polygon([[0, 0], [4, 1.1], [6, 2.5], [2, 1.4]], closed=True,
                      fill=False, hatch='/'))
ax3.set_xlim((0, 6))
ax3.set_ylim((0, 2.5))

plt.show()

```

Keywords: python, matplotlib, pylab, example, codex (see [Search examples](#))

99.91 pylab_examples example code: hexbin_demo.py

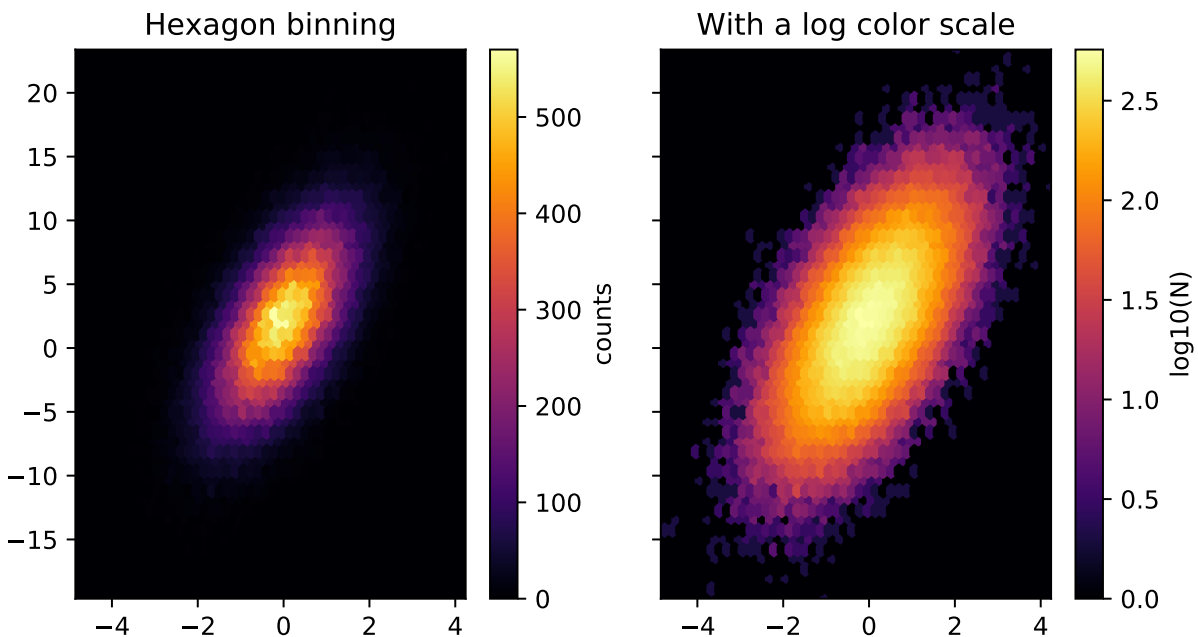

```

"""
hexbin is an axes method or pyplot function that is essentially

```

```
a pcolor of a 2-D histogram with hexagonal cells. It can be
much more informative than a scatter plot; in the first subplot
below, try substituting 'scatter' for 'hexbin'.
"""
```

```
import numpy as np
import matplotlib.pyplot as plt

np.random.seed(0)
n = 100000
x = np.random.standard_normal(n)
y = 2.0 + 3.0 * x + 4.0 * np.random.standard_normal(n)
xmin = x.min()
xmax = x.max()
ymin = y.min()
ymax = y.max()

fig, axs = plt.subplots(ncols=2, sharey=True, figsize=(7, 4))
fig.subplots_adjust(hspace=0.5, left=0.07, right=0.93)
ax = axs[0]
hb = ax.hexbin(x, y, gridsize=50, cmap='inferno')
ax.axis([xmin, xmax, ymin, ymax])
ax.set_title("Hexagon binning")
cb = fig.colorbar(hb, ax=ax)
cb.set_label('counts')

ax = axs[1]
hb = ax.hexbin(x, y, gridsize=50, bins='log', cmap='inferno')
ax.axis([xmin, xmax, ymin, ymax])
ax.set_title("With a log color scale")
cb = fig.colorbar(hb, ax=ax)
cb.set_label('log10(N)')

plt.show()
```

Keywords: python, matplotlib, pylab, example, codex (see [Search examples](#))

99.92 pylab_examples example code: hexbin_demo2.py

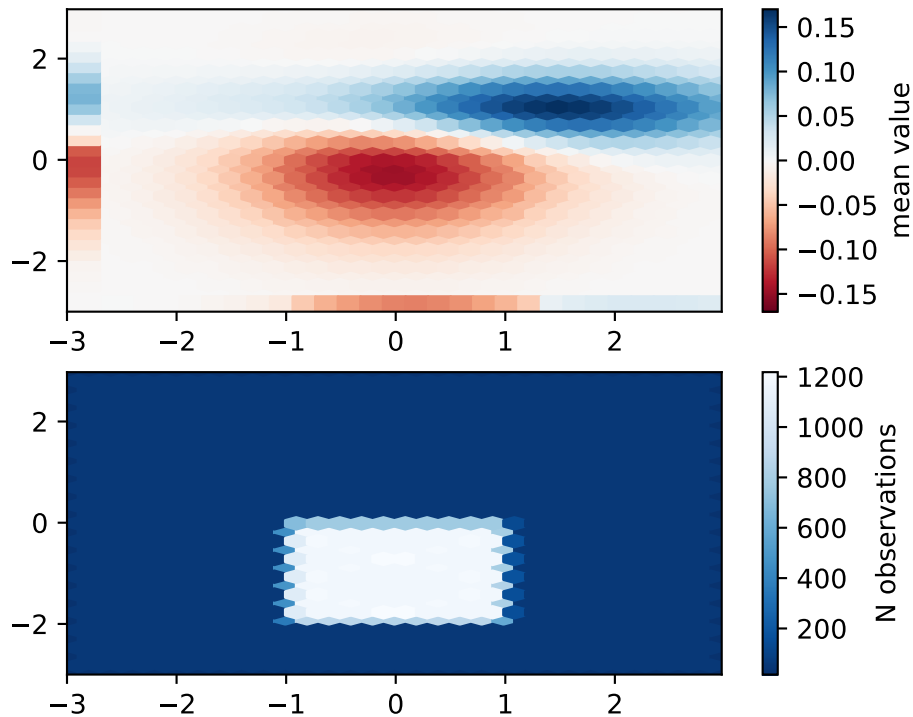

```

"""
hexbin is an axes method or pyplot function that is essentially a
pcolor of a 2-D histogram with hexagonal cells.
"""

import numpy as np
import matplotlib.pyplot as plt
import matplotlib.mlab as mlab

delta = 0.025
x = y = np.arange(-3.0, 3.0, delta)
X, Y = np.meshgrid(x, y)
Z1 = mlab.bivariate_normal(X, Y, 1.0, 1.0, 0.0, 0.0)
Z2 = mlab.bivariate_normal(X, Y, 1.5, 0.5, 1, 1)
Z = Z2 - Z1 # difference of Gaussians

x = X.ravel()
y = Y.ravel()
z = Z.ravel()

if 1:
    # make some points 20 times more common than others, but same mean

```



```
xcond = (-1 < x) & (x < 1)
ycond = (-2 < y) & (y < 0)
cond = xcond & ycond
xnew = x[cond]
ynew = y[cond]
znew = z[cond]
for i in range(20):
    x = np.hstack((x, xnew))
    y = np.hstack((y, ynew))
    z = np.hstack((z, znew))

xmin = x.min()
xmax = x.max()
ymin = y.min()
ymax = y.max()

gridsize = 30

plt.subplot(211)
plt.hexbin(x, y, C=z, gridsize=gridsize, marginals=True, cmap=plt.cm.RdBu,
           vmax=abs(z).max(), vmin=-abs(z).max())
plt.axis([xmin, xmax, ymin, ymax])
cb = plt.colorbar()
cb.set_label('mean value')

plt.subplot(212)
plt.hexbin(x, y, gridsize=gridsize, cmap=plt.cm.Blues_r)
plt.axis([xmin, xmax, ymin, ymax])
cb = plt.colorbar()
cb.set_label('N observations')

plt.show()
```

Keywords: python, matplotlib, pylab, example, codex (see [Search examples](#))

99.93 pylab_examples example code: hist2d_demo.py

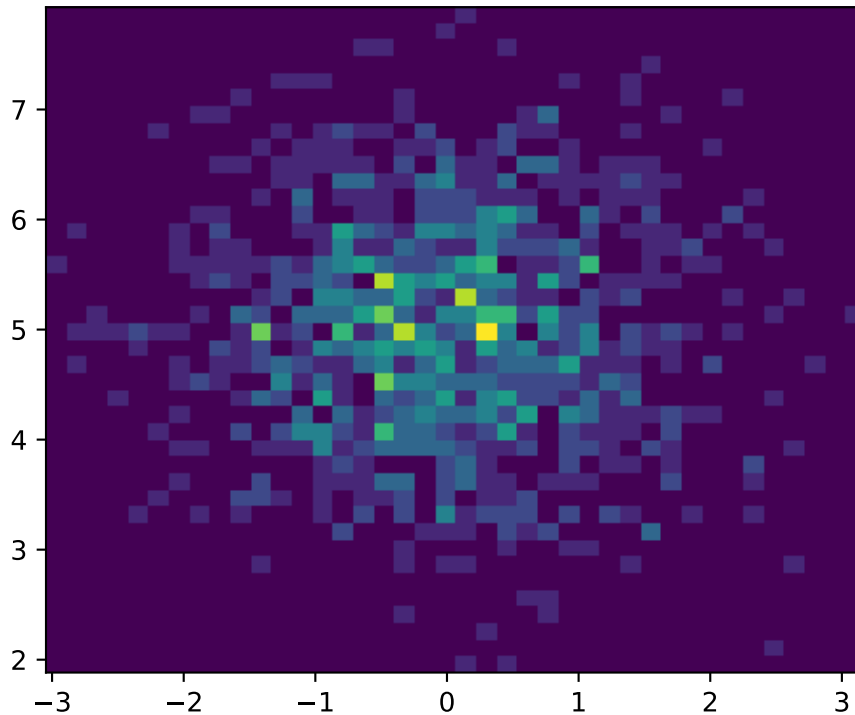

```
import matplotlib.pyplot as plt
import numpy as np
x = np.random.randn(1000)
y = np.random.randn(1000) + 5

# normal distribution center at x=0 and y=5
plt.hist2d(x, y, bins=40)
plt.show()
```

Keywords: python, matplotlib, pylab, example, codex (see [Search examples](#))

99.94 pylab_examples example code: hist2d_log_demo.py

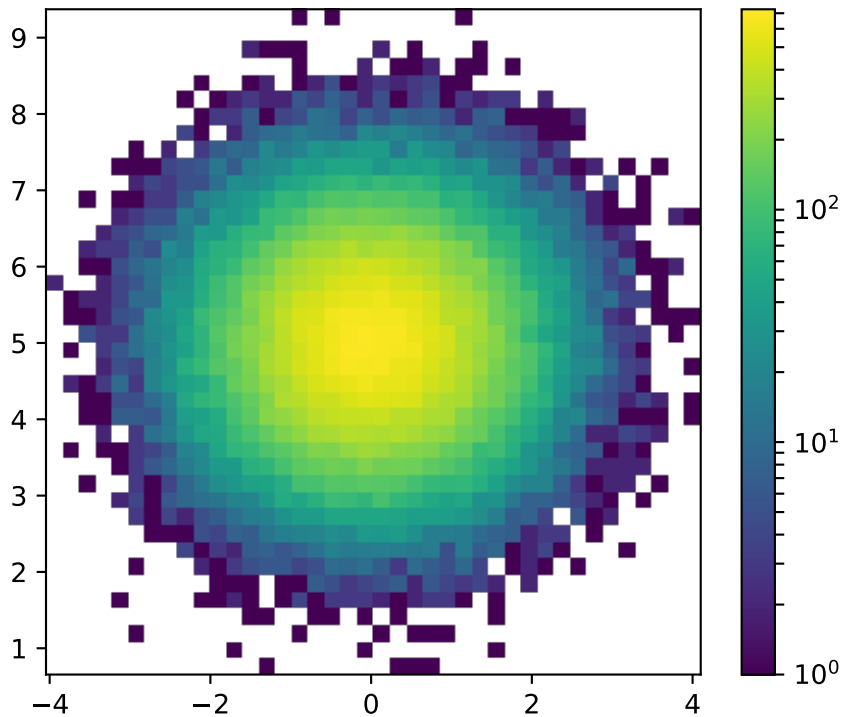

```
from matplotlib.colors import LogNorm
import matplotlib.pyplot as plt
import numpy as np

# normal distribution center at x=0 and y=5
x = np.random.randn(100000)
y = np.random.randn(100000) + 5

plt.hist2d(x, y, bins=40, norm=LogNorm())
plt.colorbar()
plt.show()
```

Keywords: python, matplotlib, pylab, example, codex (see [Search examples](#))

99.95 pylab_examples example code: hist_colormapped.py

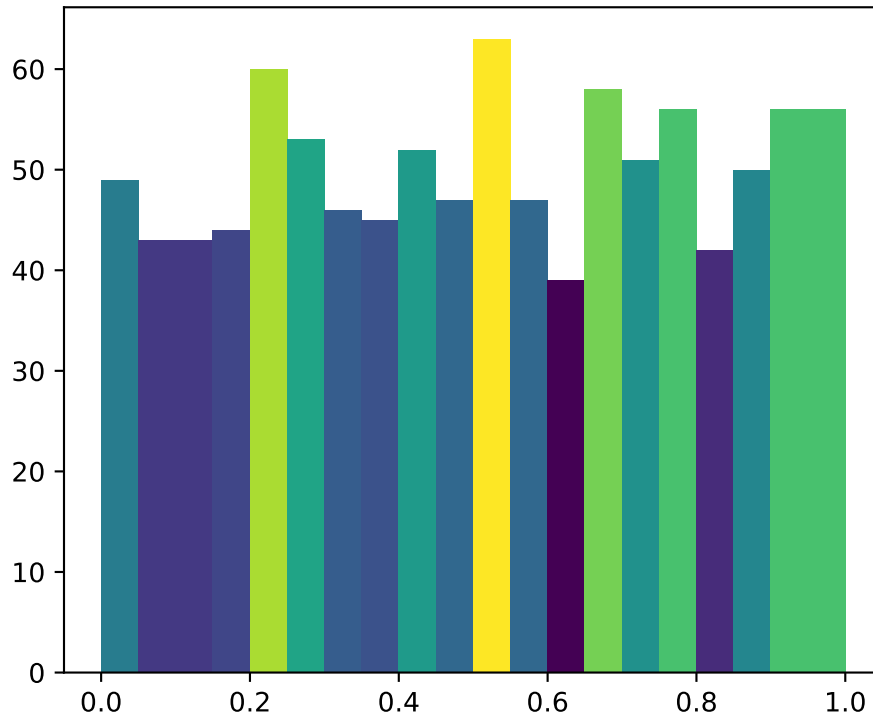

```
import numpy as np
import matplotlib.pyplot as plt
import matplotlib.cm as cm
import matplotlib.colors as colors

fig, ax = plt.subplots()
Ntotal = 1000
N, bins, patches = ax.hist(np.random.rand(Ntotal), 20)

# I'll color code by height, but you could use any scalar

# we need to normalize the data to 0..1 for the full
# range of the colormap
frac = N.astype(float)/N.max()
norm = colors.Normalize(frac.min(), frac.max())

for thisfrac, thispatch in zip(frac, patches):
    color = cm.viridis(norm(thisfrac))
    thispatch.set_facecolor(color)
```

```
plt.show()
```

Keywords: python, matplotlib, pylab, example, codex (see [Search examples](#))

99.96 pylab_examples example code: histogram_percent_demo.py

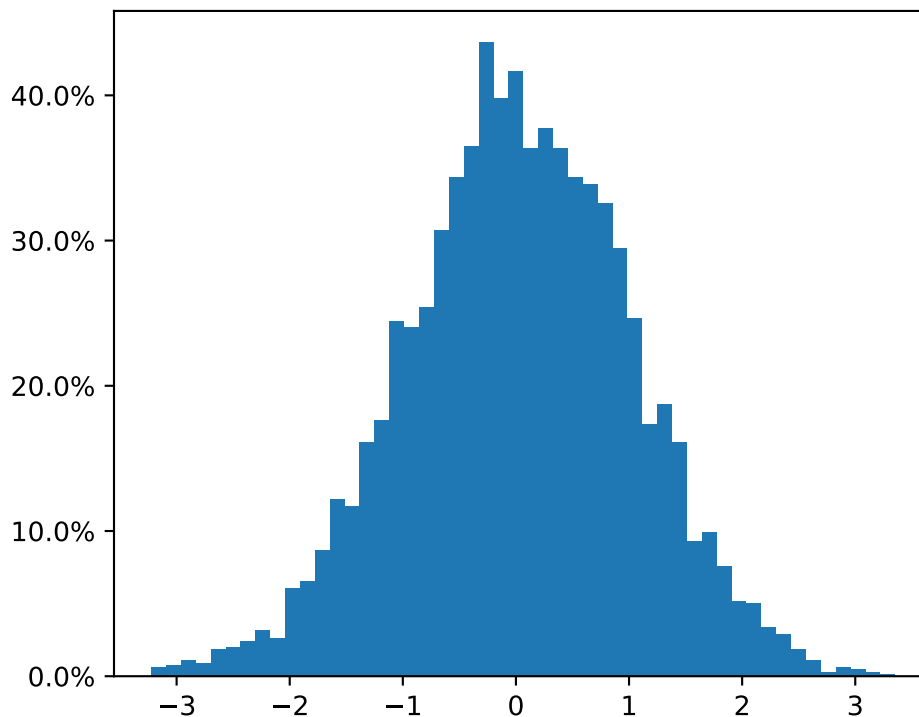

```
import matplotlib
from numpy.random import randn
import matplotlib.pyplot as plt
from matplotlib.ticker import FuncFormatter

def to_percent(y, position):
    # Ignore the passed in position. This has the effect of scaling the default
    # tick locations.
    s = str(100 * y)

    # The percent symbol needs escaping in latex
    if matplotlib.rcParams['text.usetex'] is True:
        return s + r'\%'
    else:
        return s + '%'
```

```

x = randn(5000)

# Make a normed histogram. It'll be multiplied by 100 later.
plt.hist(x, bins=50, normed=True)

# Create the formatter using the function to_percent. This multiplies all the
# default labels by 100, making them all percentages
formatter = FuncFormatter(to_percent)

# Set the formatter
plt.gca().yaxis.set_major_formatter(formatter)

plt.show()

```

Keywords: python, matplotlib, pylab, example, codex (see *Search examples*)

99.97 pylab_examples example code: hyperlinks.py

[source code]

```

# -*- noplots -*-

"""
This example demonstrates how to set a hyperlinks on various kinds of elements.

This currently only works with the SVG backend.
"""

import numpy as np
import matplotlib.cm as cm
import matplotlib.mlab as mlab
import matplotlib.pyplot as plt

f = plt.figure()
s = plt.scatter([1, 2, 3], [4, 5, 6])
s.set_urls(['http://www.bbc.co.uk/news', 'http://www.google.com', None])
f.canvas.print_figure('scatter.svg')

f = plt.figure()
delta = 0.025
x = y = np.arange(-3.0, 3.0, delta)
X, Y = np.meshgrid(x, y)
Z1 = mlab.bivariate_normal(X, Y, 1.0, 1.0, 0.0, 0.0)
Z2 = mlab.bivariate_normal(X, Y, 1.5, 0.5, 1, 1)
Z = Z2 - Z1 # difference of Gaussians

im = plt.imshow(Z, interpolation='bilinear', cmap=cm.gray,
                origin='lower', extent=[-3, 3, -3, 3])

im.set_url('http://www.google.com')

```

```
f.canvas.print_figure('image.svg')
```

Keywords: python, matplotlib, pylab, example, codex (see [Search examples](#))

99.98 pylab_examples example code: image_clip_path.py

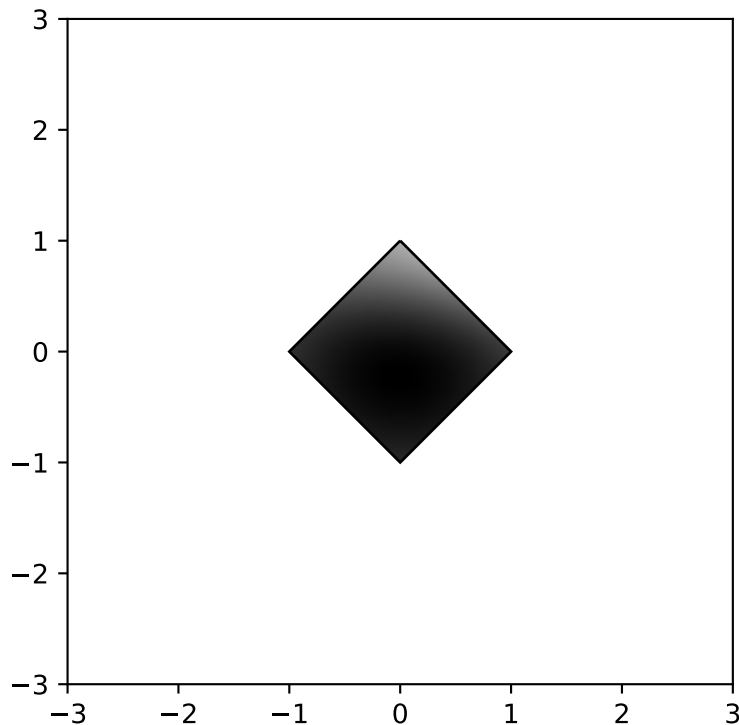

```
import numpy as np
import matplotlib.cm as cm
import matplotlib.mlab as mlab
import matplotlib.pyplot as plt
from matplotlib.path import Path
from matplotlib.patches import PathPatch

delta = 0.025
x = y = np.arange(-3.0, 3.0, delta)
X, Y = np.meshgrid(x, y)
Z1 = mlab.bivariate_normal(X, Y, 1.0, 1.0, 0.0, 0.0)
Z2 = mlab.bivariate_normal(X, Y, 1.5, 0.5, 1, 1)
Z = Z2 - Z1 # difference of Gaussians

path = Path([[0, 1], [1, 0], [0, -1], [-1, 0], [0, 1]])
patch = PathPatch(path, facecolor='none')
```

```
plt.gca().add_patch(patch)

im = plt.imshow(Z, interpolation='bilinear', cmap=cm.gray,
                origin='lower', extent=[-3, 3, -3, 3],
                clip_path=patch, clip_on=True)
im.set_clip_path(patch)

plt.show()
```

Keywords: python, matplotlib, pylab, example, codex (see [Search examples](#))

99.99 pylab_examples example code: image_demo.py

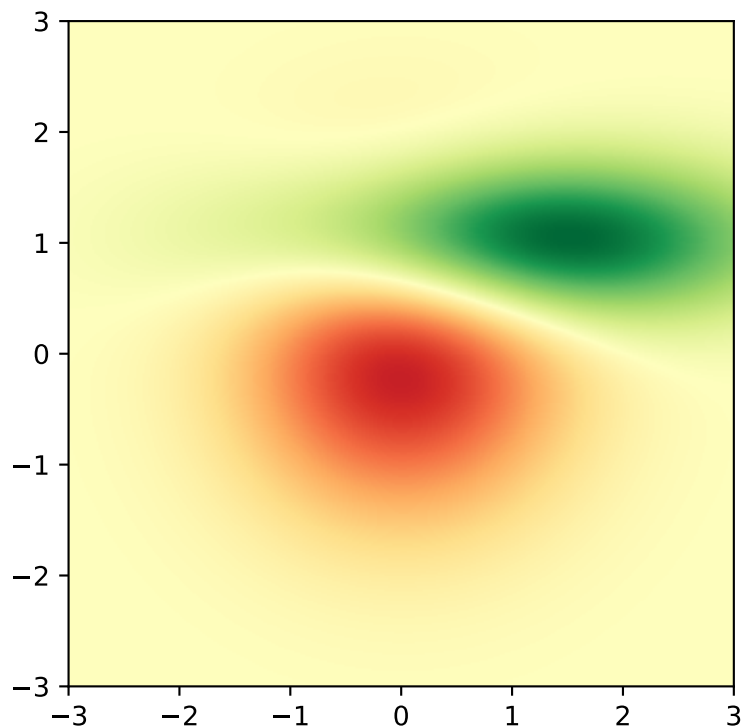

```
import numpy as np
import matplotlib.cm as cm
import matplotlib.mlab as mlab
import matplotlib.pyplot as plt

delta = 0.025
x = y = np.arange(-3.0, 3.0, delta)
X, Y = np.meshgrid(x, y)
Z1 = mlab.bivariate_normal(X, Y, 1.0, 1.0, 0.0, 0.0)
```



```

Z2 = mlab.bivariate_normal(X, Y, 1.5, 0.5, 1, 1)
Z = Z2 - Z1 # difference of Gaussians

im = plt.imshow(Z, interpolation='bilinear', cmap=cm.RdYlGn,
                origin='lower', extent=[-3, 3, -3, 3],
                vmax=abs(Z).max(), vmin=-abs(Z).max())

plt.show()

```

Keywords: python, matplotlib, pylab, example, codex (see [Search examples](#))

99.100 pylab_examples example code: image_demo2.py

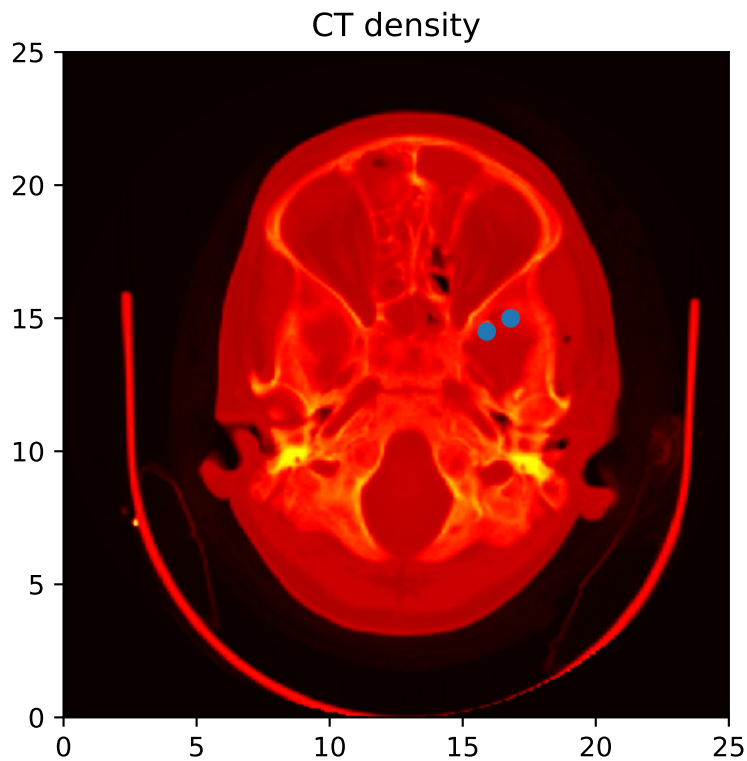

```

from __future__ import print_function
import matplotlib.pyplot as plt
import numpy as np
import matplotlib.cbook as cbook

w, h = 512, 512

datafile = cbook.get_sample_data('ct.raw.gz', asfileobj=True)
s = datafile.read()

```

```
A = np.fromstring(s, np.uint16).astype(float)
A *= 1.0 / max(A)
A.shape = w, h

extent = (0, 25, 0, 25)
im = plt.imshow(A, cmap=plt.cm.hot, origin='upper', extent=extent)

markers = [(15.9, 14.5), (16.8, 15)]
x, y = zip(*markers)
plt.plot(x, y, 'o')

plt.title('CT density')

plt.show()
```

Keywords: python, matplotlib, pylab, example, codex (see [Search examples](#))

99.101 pylab_examples example code: image_interp.py

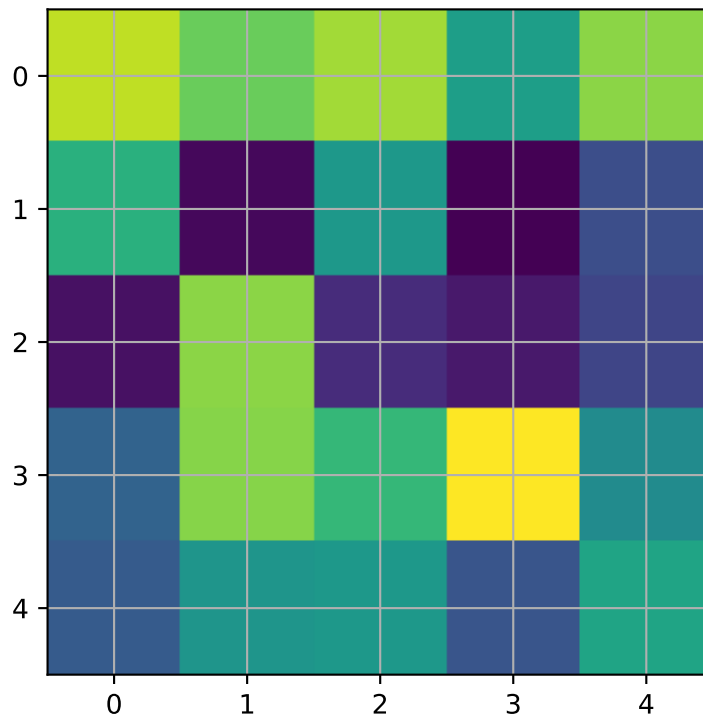

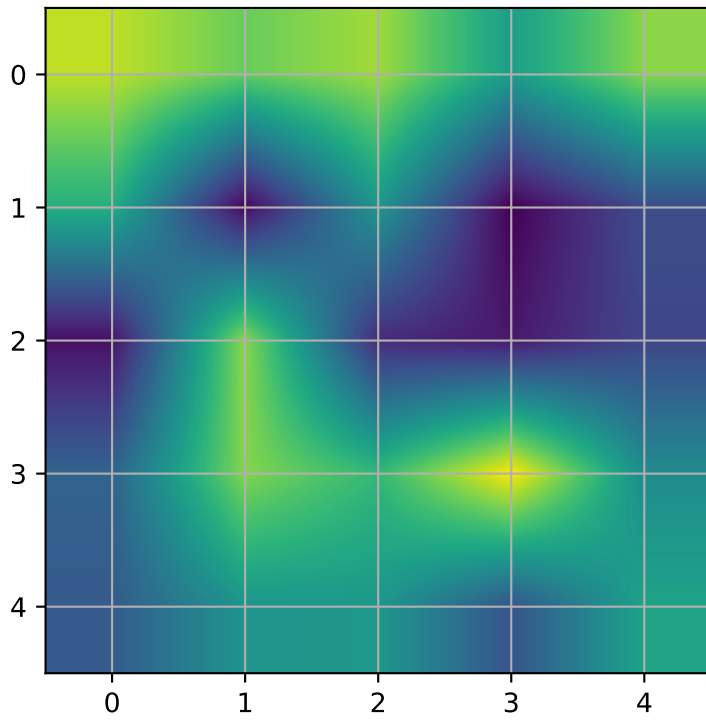

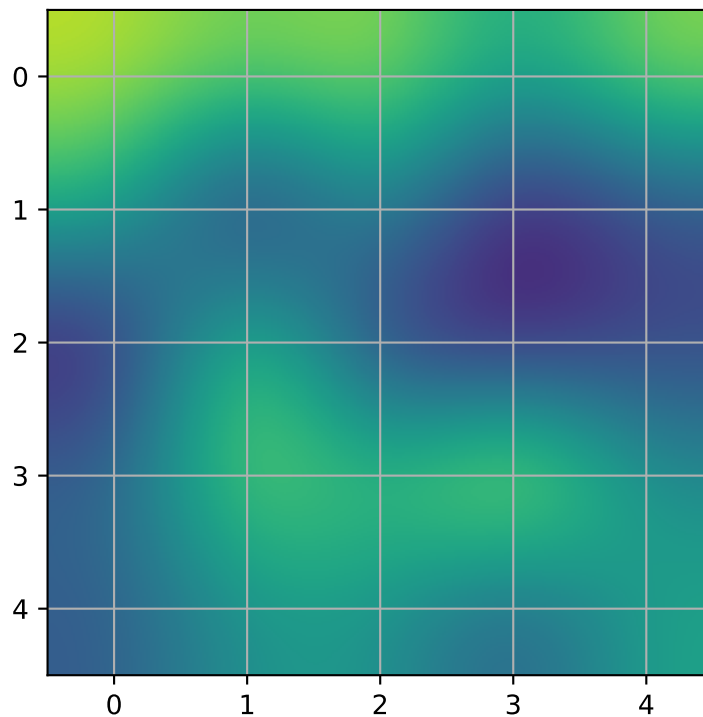

```
"""
```

The same (small) array, interpolated with three different interpolation methods.

The center of the pixel at $A[i,j]$ is plotted at $i+0.5, j+0.5$. If you are using `interpolation='nearest'`, the region bounded by (i,j) and $(i+1,j+1)$ will have the same color. If you are using `interpolation='bilinear'`, the pixel center will have the same color as it does with `nearest`, but other pixels will be interpolated between the neighboring pixels.

Earlier versions of matplotlib (<0.63) tried to hide the edge effects from you by setting the view limits so that they would not be visible. A recent bugfix in `antigrain`, and a new implementation in the `matplotlib._image` module which takes advantage of this fix, no longer makes this necessary. To prevent edge effects, when doing interpolation, the `matplotlib._image` module now pads the input array with identical pixels around the edge. e.g., if you have a 5x5 array with colors a-y as below

```
a b c d e
f g h i j
k l m n o
p q r s t
u v w x y
```

the `_image` module creates the padded array,

```
a a b c d e e
a a b c d e e
f f g h i j j
k k l m n o o
p p q r s t t
o u v w x y y
o u v w x y y
```

does the interpolation/resizing, and then extracts the central region. This allows you to plot the full range of your array w/o edge effects, and for example to layer multiple images of different sizes over one another with different interpolation methods - see [examples/layer_images.py](#). It also implies a performance hit, as this new temporary, padded array must be created. Sophisticated interpolation also implies a performance hit, so if you need maximal performance or have very large images, `interpolation='nearest'` is suggested.

```
"""
import matplotlib.pyplot as plt
import numpy as np

A = np.random.rand(5, 5)
plt.figure(1)
plt.imshow(A, interpolation='nearest')
plt.grid(True)

plt.figure(2)
plt.imshow(A, interpolation='bilinear')
plt.grid(True)

plt.figure(3)
plt.imshow(A, interpolation='bicubic')
plt.grid(True)

plt.show()
```

Keywords: python, matplotlib, pylab, example, codex (see [Search examples](#))

99.102 pylab_examples example code: image_masked.py

imshow, with out-of-range and masked data

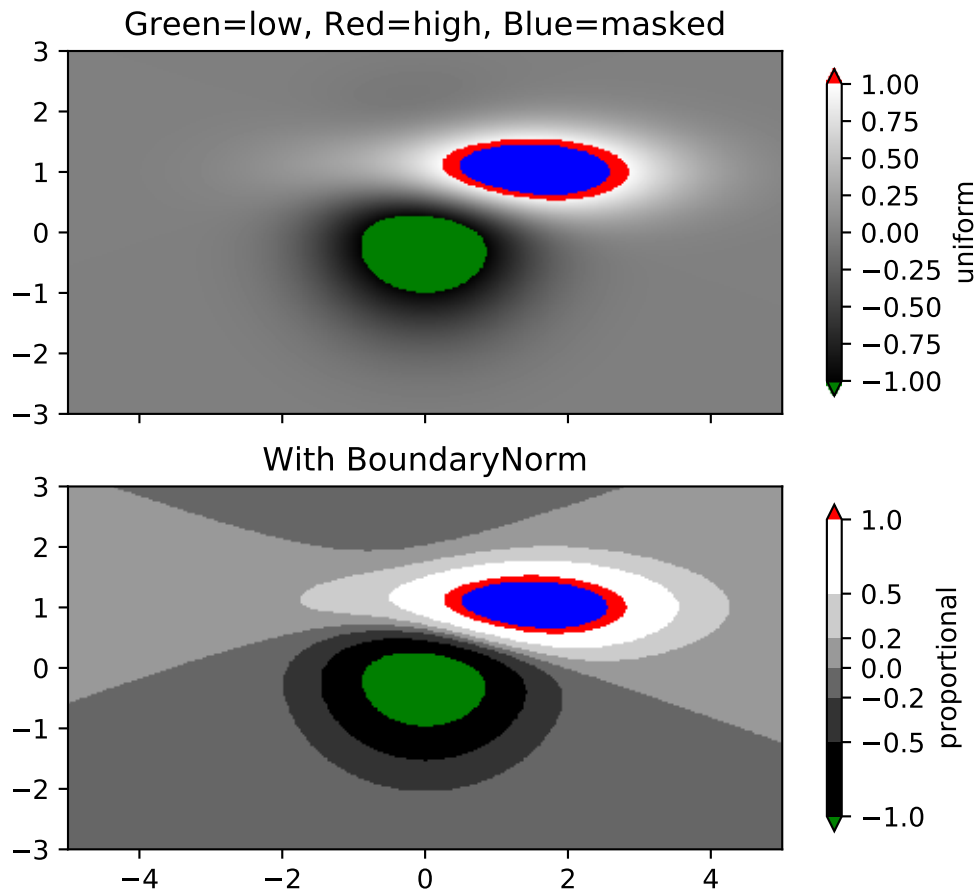

```

"""
imshow with masked array input and out-of-range colors.

The second subplot illustrates the use of BoundaryNorm to
get a filled contour effect.
"""
from copy import copy

import numpy as np
import matplotlib.pyplot as plt
import matplotlib.colors as colors
import matplotlib.mlab as mlab

# compute some interesting data
x0, x1 = -5, 5
y0, y1 = -3, 3
x = np.linspace(x0, x1, 500)

```

```

y = np.linspace(y0, y1, 500)
X, Y = np.meshgrid(x, y)
Z1 = mlab.bivariate_normal(X, Y, 1.0, 1.0, 0.0, 0.0)
Z2 = mlab.bivariate_normal(X, Y, 1.5, 0.5, 1, 1)
Z = 10*(Z2 - Z1) # difference of Gaussians

# Set up a colormap:
# use copy so that we do not mutate the global colormap instance
palette = copy(plt.cm.gray)
palette.set_over('r', 1.0)
palette.set_under('g', 1.0)
palette.set_bad('b', 1.0)
# Alternatively, we could use
# palette.set_bad(alpha = 0.0)
# to make the bad region transparent. This is the default.
# If you comment out all the palette.set* lines, you will see
# all the defaults; under and over will be colored with the
# first and last colors in the palette, respectively.
Zm = np.ma.masked_where(Z > 1.2, Z)

# By setting vmin and vmax in the norm, we establish the
# range to which the regular palette color scale is applied.
# Anything above that range is colored based on palette.set_over, etc.

# set up the axes
fig, (ax1, ax2) = plt.subplots(nrows=2, figsize=(6, 5.4))

# plot using 'continuous' color map
im = ax1.imshow(Zm, interpolation='bilinear',
                cmap=palette,
                norm=colors.Normalize(vmin=-1.0, vmax=1.0),
                aspect='auto',
                origin='lower',
                extent=[x0, x1, y0, y1])
ax1.set_title('Green=low, Red=high, Blue=masked')
cbar = fig.colorbar(im, extend='both', shrink=0.9, ax=ax1)
cbar.set_label('uniform')
for ticklabel in ax1.xaxis.get_ticklabels():
    ticklabel.set_visible(False)

# Plot using a small number of colors, with unevenly spaced boundaries.
im = ax2.imshow(Zm, interpolation='nearest',
                cmap=palette,
                norm=colors.BoundaryNorm([-1, -0.5, -0.2, 0, 0.2, 0.5, 1],
                                         ncolors=palette.N),
                aspect='auto',
                origin='lower',
                extent=[x0, x1, y0, y1])
ax2.set_title('With BoundaryNorm')
cbar = fig.colorbar(im, extend='both', spacing='proportional',
                    shrink=0.9, ax=ax2)
cbar.set_label('proportional')

```

```
fig.suptitle('imshow, with out-of-range and masked data')
plt.show()
```

Keywords: python, matplotlib, pylab, example, codex (see [Search examples](#))

99.103 pylab_examples example code: image_nonuniform.py

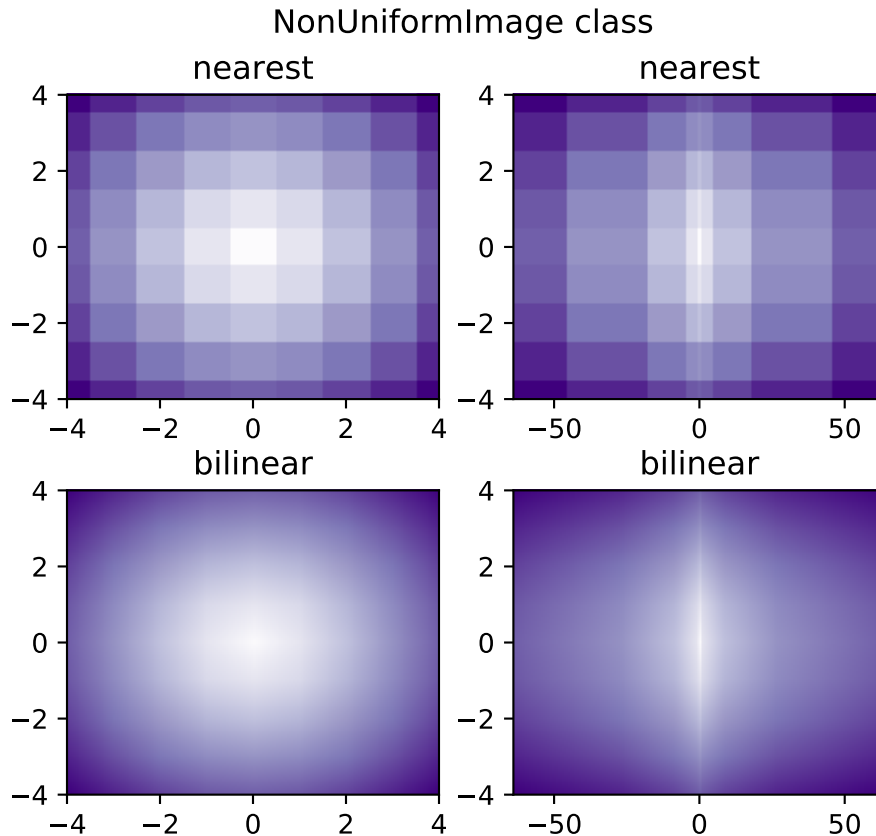

```
"""
This illustrates the NonUniformImage class. It is not
available via an Axes method but it is easily added to an
Axes instance as shown here.
"""
```

```
import numpy as np
import matplotlib.pyplot as plt
from matplotlib.image import NonUniformImage
from matplotlib import cm

interp = 'nearest'

# Linear x array for cell centers:
x = np.linspace(-4, 4, 9)
```



```

# Highly nonlinear x array:
x2 = x**3

y = np.linspace(-4, 4, 9)

z = np.sqrt(x[np.newaxis, :]**2 + y[:, np.newaxis]**2)

fig, axs = plt.subplots(nrows=2, ncols=2)
fig.subplots_adjust(bottom=0.07, hspace=0.3)
fig.suptitle('NonUniformImage class', fontsize='large')
ax = axs[0, 0]
im = NonUniformImage(ax, interpolation=interp, extent=(-4, 4, -4, 4),
                      cmap=cm.Purples)
im.set_data(x, y, z)
ax.images.append(im)
ax.set_xlim(-4, 4)
ax.set_ylim(-4, 4)
ax.set_title(interp)

ax = axs[0, 1]
im = NonUniformImage(ax, interpolation=interp, extent=(-64, 64, -4, 4),
                      cmap=cm.Purples)
im.set_data(x2, y, z)
ax.images.append(im)
ax.set_xlim(-64, 64)
ax.set_ylim(-4, 4)
ax.set_title(interp)

interp = 'bilinear'

ax = axs[1, 0]
im = NonUniformImage(ax, interpolation=interp, extent=(-4, 4, -4, 4),
                      cmap=cm.Purples)
im.set_data(x, y, z)
ax.images.append(im)
ax.set_xlim(-4, 4)
ax.set_ylim(-4, 4)
ax.set_title(interp)

ax = axs[1, 1]
im = NonUniformImage(ax, interpolation=interp, extent=(-64, 64, -4, 4),
                      cmap=cm.Purples)
im.set_data(x2, y, z)
ax.images.append(im)
ax.set_xlim(-64, 64)
ax.set_ylim(-4, 4)
ax.set_title(interp)

plt.show()

```

Keywords: python, matplotlib, pylab, example, codex (see [Search examples](#))

99.104 pylab_examples example code: image_origin.py

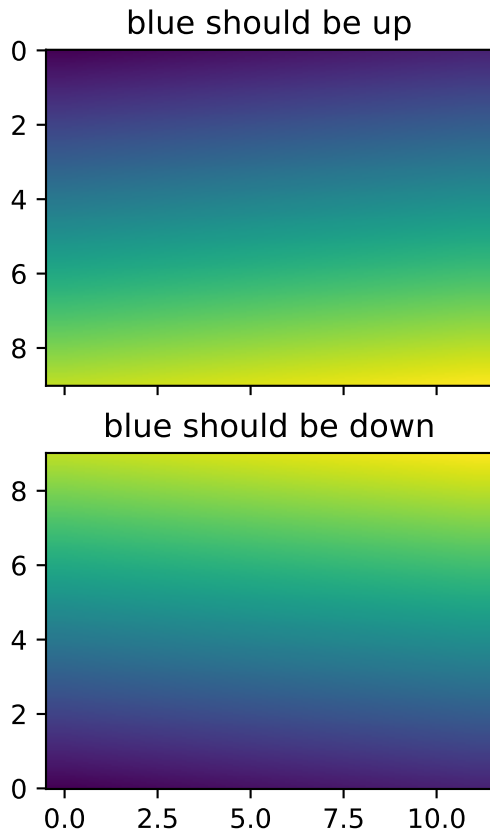

```
"""
You can specify whether images should be plotted with the array origin
x[0,0] in the upper left or upper right by using the origin parameter.
You can also control the default by setting image.origin in your
matplotlibrc file; see http://matplotlib.org/matplotlibrc
"""
import matplotlib.pyplot as plt
import numpy as np

x = np.arange(120)
x.shape = (10, 12)

interp = 'bilinear'
fig, axs = plt.subplots(nrows=2, sharex=True, figsize=(3, 5))
axs[0].set_title('blue should be up')
axs[0].imshow(x, origin='upper', interpolation=interp)

axs[1].set_title('blue should be down')
axs[1].imshow(x, origin='lower', interpolation=interp)
```

```
plt.show()
```

Keywords: python, matplotlib, pylab, example, codex (see [Search examples](#))

99.105 pylab_examples example code: image_slices_viewer.py

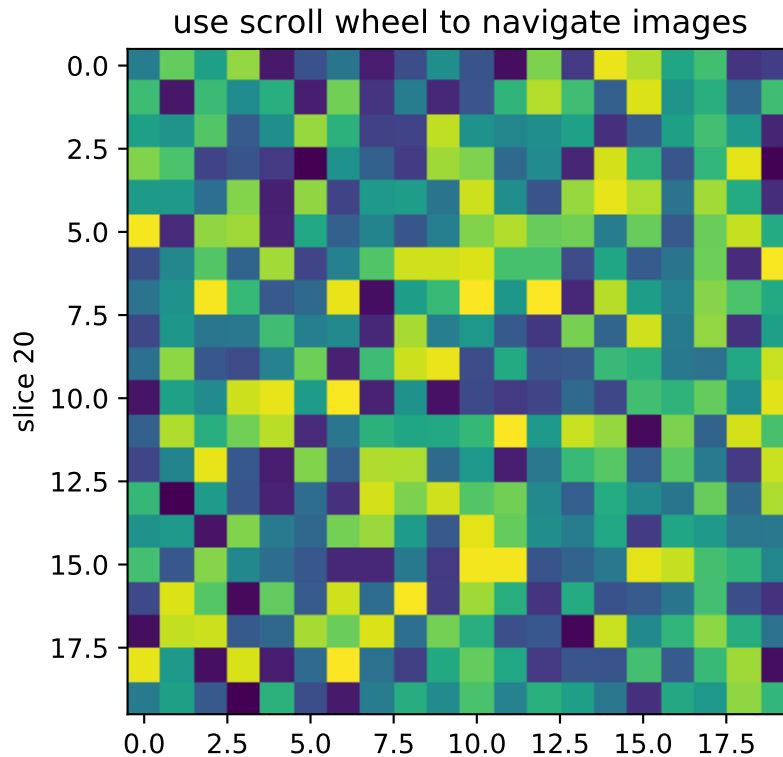

```
from __future__ import print_function
import numpy
import matplotlib.pyplot as plt

class IndexTracker(object):
    def __init__(self, ax, X):
        self.ax = ax
        ax.set_title('use scroll wheel to navigate images')

        self.X = X
        rows, cols, self.slices = X.shape
        self.ind = self.slices//2

        self.im = ax.imshow(self.X[:, :, self.ind])
        self.update()
```

```
def onscroll(self, event):
    print("%s %s" % (event.button, event.step))
    if event.button == 'up':
        self.ind = numpy.clip(self.ind + 1, 0, self.slices - 1)
    else:
        self.ind = numpy.clip(self.ind - 1, 0, self.slices - 1)
    self.update()

def update(self):
    self.im.set_data(self.X[:, :, self.ind])
    ax.set_ylabel('slice %s' % self.ind)
    self.im.axes.figure.canvas.draw()

fig, ax = plt.subplots(1, 1)

X = numpy.random.rand(20, 20, 40)

tracker = IndexTracker(ax, X)

fig.canvas.mpl_connect('scroll_event', tracker.onscroll)
plt.show()
```

Keywords: python, matplotlib, pylab, example, codex (see [Search examples](#))

99.106 pylab_examples example code: interp_demo.py

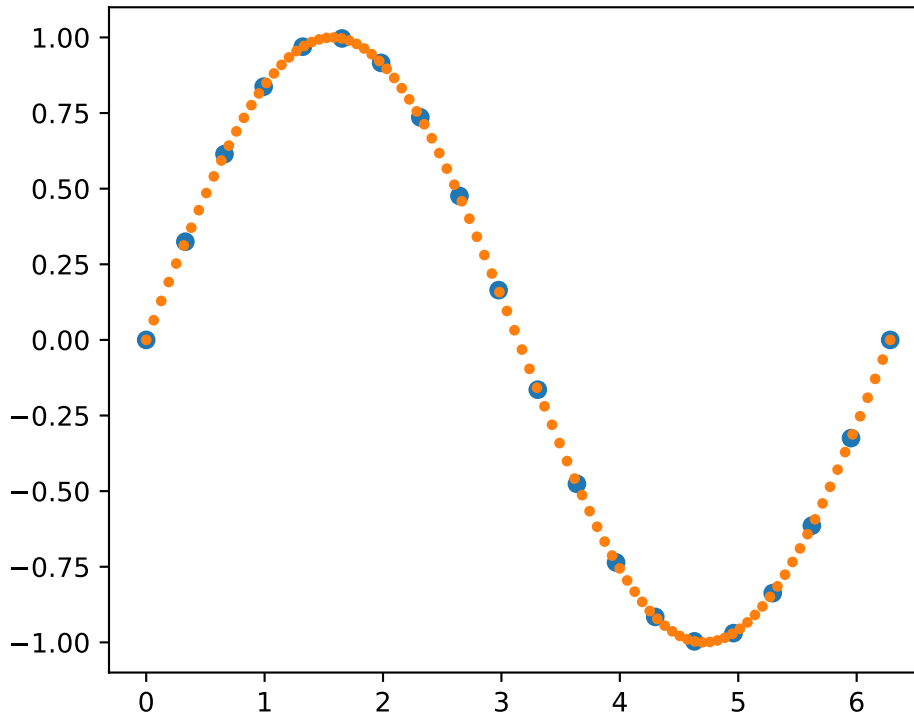

```
import matplotlib.pyplot as plt
from numpy import pi, sin, linspace
from matplotlib.mlab import stineman_interp

x = linspace(0, 2*pi, 20)
y = sin(x)
yp = None
xi = linspace(x[0], x[-1], 100)
yi = stineman_interp(xi, x, y, yp)

fig, ax = plt.subplots()
ax.plot(x, y, 'o', xi, yi, '.')
plt.show()
```

Keywords: python, matplotlib, pylab, example, codex (see [Search examples](#))

99.107 pylab_examples example code: invert_axes.py

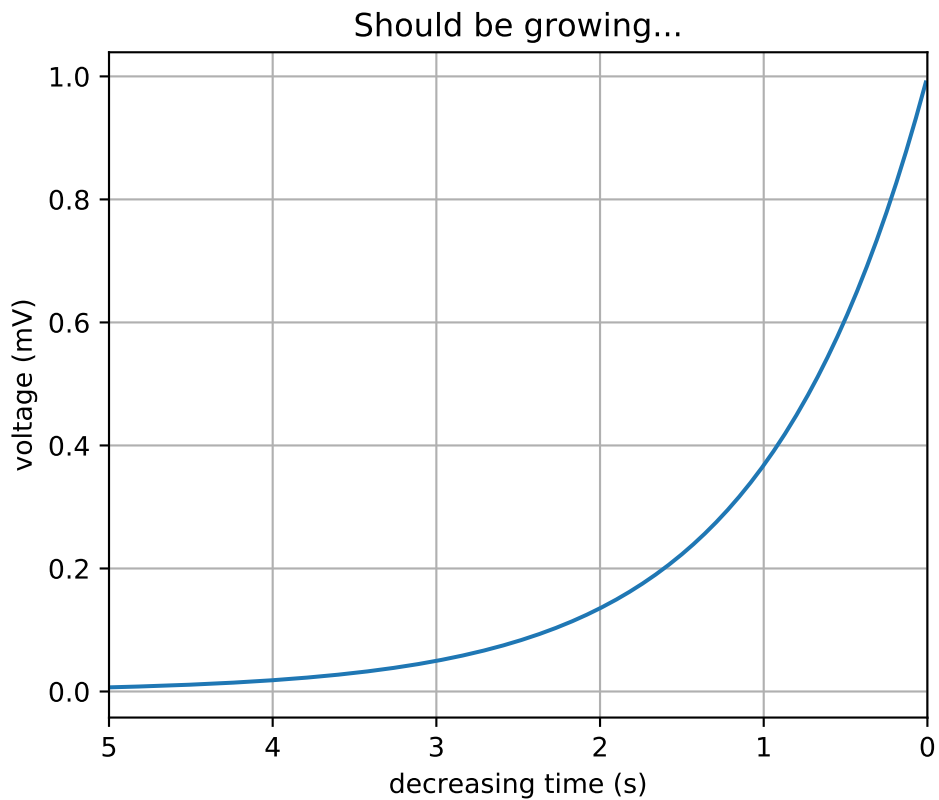

```
"""
You can use decreasing axes by flipping the normal order of the axis
limits
"""

import matplotlib.pyplot as plt
import numpy as np

t = np.arange(0.01, 5.0, 0.01)
s = np.exp(-t)
plt.plot(t, s)

plt.xlim(5, 0) # decreasing time

plt.xlabel('decreasing time (s)')
plt.ylabel('voltage (mV)')
plt.title('Should be growing...')
plt.grid(True)

plt.show()
```

Keywords: python, matplotlib, pylab, example, codex (see [Search examples](#))

99.108 pylab_examples example code: layer_images.py

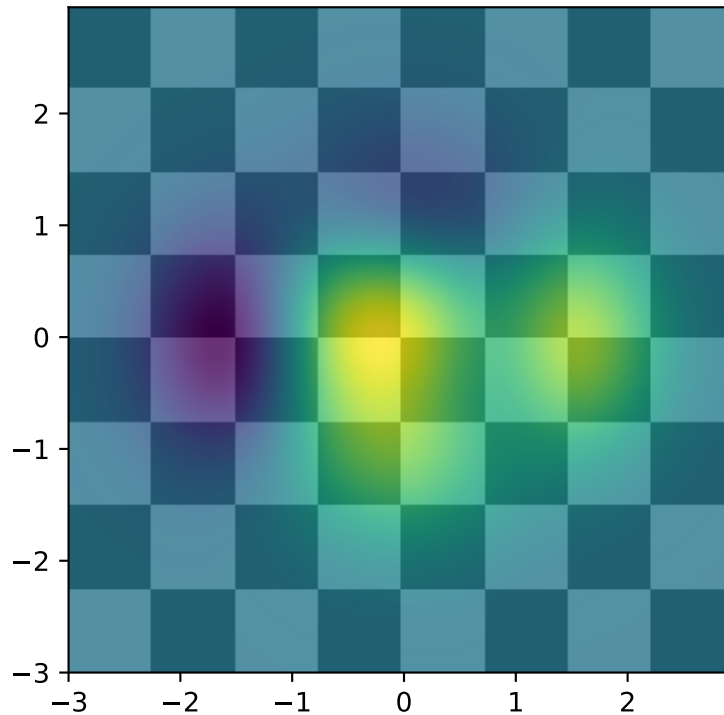

```

"""
Layer images above one another using alpha blending
"""
from __future__ import division
import matplotlib.pyplot as plt
import numpy as np

def func3(x, y):
    return (1 - x/2 + x**5 + y**3)*np.exp(-(x**2 + y**2))

# make these smaller to increase the resolution
dx, dy = 0.05, 0.05

x = np.arange(-3.0, 3.0, dx)
y = np.arange(-3.0, 3.0, dy)
X, Y = np.meshgrid(x, y)

# when layering multiple images, the images need to have the same
# extent. This does not mean they need to have the same shape, but
# they both need to render to the same coordinate system determined by
# xmin, xmax, ymin, ymax. Note if you use different interpolations

```

```

# for the images their apparent extent could be different due to
# interpolation edge effects

xmin, xmax, ymin, ymax = np.amin(x), np.amax(x), np.amin(y), np.amax(y)
extent = xmin, xmax, ymin, ymax
fig = plt.figure(frameon=False)

Z1 = np.array(((0, 1)*4 + [1, 0]*4)*4)
Z1.shape = (8, 8) # chessboard
im1 = plt.imshow(Z1, cmap=plt.cm.gray, interpolation='nearest',
                 extent=extent)

Z2 = func3(X, Y)

im2 = plt.imshow(Z2, cmap=plt.cm.viridis, alpha=.9, interpolation='bilinear',
                 extent=extent)

plt.show()

```

Keywords: python, matplotlib, pylab, example, codex (see [Search examples](#))

99.109 pylab_examples example code: leftventricle_bulleye.py

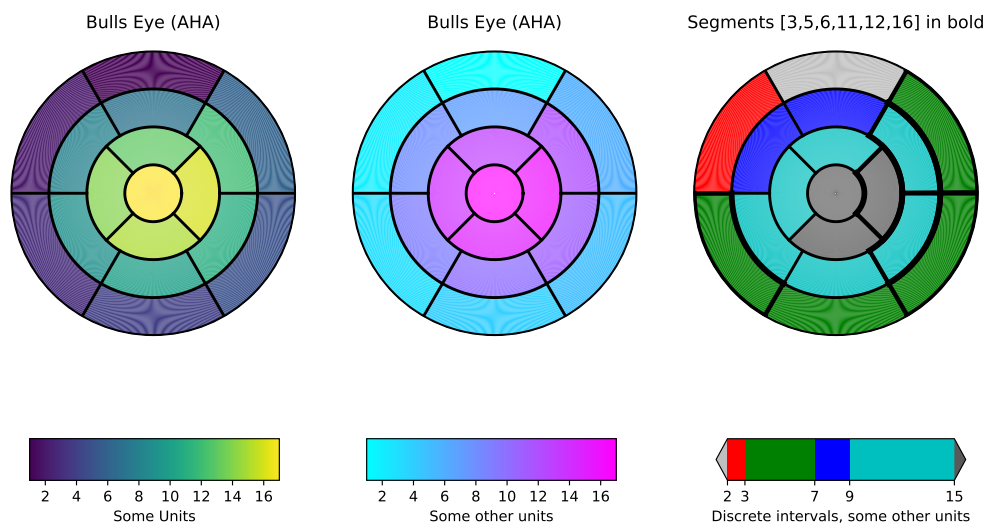

```

"""
This example demonstrates how to create the 17 segment model for the left
ventricle recommended by the American Heart Association (AHA).
"""

import numpy as np
import matplotlib as mpl
import matplotlib.pyplot as plt

def bullseye_plot(ax, data, segBold=None, cmap=None, norm=None):
    """
    Bullseye representation for the left ventricle.

    Parameters
    -----
    ax : axes
    data : list of int and float
        The intensity values for each of the 17 segments
    segBold: list of int, optional
        A list with the segments to highlight
    cmap : ColorMap or None, optional
        Optional argument to set the desired colormap
    norm : Normalize or None, optional
        Optional argument to normalize data into the [0.0, 1.0] range

    Notes
    -----
    This function create the 17 segment model for the left ventricle according
    to the American Heart Association (AHA) [1]_

    References
    -----
    .. [1] M. D. Cerqueira, N. J. Weissman, V. Dilsizian, A. K. Jacobs,
        S. Kaul, W. K. Laskey, D. J. Pennell, J. A. Rumberger, T. Ryan,
        and M. S. Verani, "Standardized myocardial segmentation and
        nomenclature for tomographic imaging of the heart",
        Circulation, vol. 105, no. 4, pp. 539-542, 2002.
    """
    if segBold is None:
        segBold = []

    linewidth = 2
    data = np.array(data).ravel()

    if cmap is None:
        cmap = plt.cm.viridis

    if norm is None:
        norm = mpl.colors.Normalize(vmin=data.min(), vmax=data.max())

    theta = np.linspace(0, 2*np.pi, 768)

```

```

r = np.linspace(0.2, 1, 4)

# Create the bound for the segment 17
for i in range(r.shape[0]):
    ax.plot(theta, np.repeat(r[i], theta.shape), '-k', lw=linewidth)

# Create the bounds for the segments 1-12
for i in range(6):
    theta_i = i*60*np.pi/180
    ax.plot([theta_i, theta_i], [r[1], 1], '-k', lw=linewidth)

# Create the bounds for the segments 13-16
for i in range(4):
    theta_i = i*90*np.pi/180 - 45*np.pi/180
    ax.plot([theta_i, theta_i], [r[0], r[1]], '-k', lw=linewidth)

# Fill the segments 1-6
r0 = r[2:4]
r0 = np.repeat(r0[:, np.newaxis], 128, axis=1).T
for i in range(6):
    # First segment start at 60 degrees
    theta0 = theta[i*128:i*128+128] + 60*np.pi/180
    theta0 = np.repeat(theta0[:, np.newaxis], 2, axis=1)
    z = np.ones((128, 2))*data[i]
    ax.pcolormesh(theta0, r0, z, cmap=cmap, norm=norm)
    if i+1 in segBold:
        ax.plot(theta0, r0, '-k', lw=linewidth+2)
        ax.plot(theta0[0], [r[2], r[3]], '-k', lw=linewidth+1)
        ax.plot(theta0[-1], [r[2], r[3]], '-k', lw=linewidth+1)

# Fill the segments 7-12
r0 = r[1:3]
r0 = np.repeat(r0[:, np.newaxis], 128, axis=1).T
for i in range(6):
    # First segment start at 60 degrees
    theta0 = theta[i*128:i*128+128] + 60*np.pi/180
    theta0 = np.repeat(theta0[:, np.newaxis], 2, axis=1)
    z = np.ones((128, 2))*data[i+6]
    ax.pcolormesh(theta0, r0, z, cmap=cmap, norm=norm)
    if i+7 in segBold:
        ax.plot(theta0, r0, '-k', lw=linewidth+2)
        ax.plot(theta0[0], [r[1], r[2]], '-k', lw=linewidth+1)
        ax.plot(theta0[-1], [r[1], r[2]], '-k', lw=linewidth+1)

# Fill the segments 13-16
r0 = r[0:2]
r0 = np.repeat(r0[:, np.newaxis], 192, axis=1).T
for i in range(4):
    # First segment start at 45 degrees
    theta0 = theta[i*192:i*192+192] + 45*np.pi/180
    theta0 = np.repeat(theta0[:, np.newaxis], 2, axis=1)
    z = np.ones((192, 2))*data[i+12]
    ax.pcolormesh(theta0, r0, z, cmap=cmap, norm=norm)

```

```

    if i+13 in segBold:
        ax.plot(theta0, r0, '-k', lw=linewidth+2)
        ax.plot(theta0[0], [r[0], r[1]], '-k', lw=linewidth+1)
        ax.plot(theta0[-1], [r[0], r[1]], '-k', lw=linewidth+1)

    # Fill the segments 17
    if data.size == 17:
        r0 = np.array([0, r[0]])
        r0 = np.repeat(r0[:, np.newaxis], theta.size, axis=1).T
        theta0 = np.repeat(theta[:, np.newaxis], 2, axis=1)
        z = np.ones((theta.size, 2))*data[16]
        ax.pcolormesh(theta0, r0, z, cmap=cmap, norm=norm)
        if 17 in segBold:
            ax.plot(theta0, r0, '-k', lw=linewidth+2)

    ax.set_ylim([0, 1])
    ax.set_yticklabels([])
    ax.set_xticklabels([])

# Create the fake data
data = np.array(range(17)) + 1

# Make a figure and axes with dimensions as desired.
fig, ax = plt.subplots(figsize=(12, 8), nrows=1, ncols=3,
                        subplot_kw=dict(projection='polar'))
fig.canvas.set_window_title('Left Ventricle Bulls Eyes (AHA)')

# Create the axis for the colorbars
ax1 = fig.add_axes([0.14, 0.15, 0.2, 0.05])
ax2 = fig.add_axes([0.41, 0.15, 0.2, 0.05])
ax3 = fig.add_axes([0.69, 0.15, 0.2, 0.05])

# Set the colormap and norm to correspond to the data for which
# the colorbar will be used.
cmap = mpl.cm.viridis
norm = mpl.colors.Normalize(vmin=1, vmax=17)

# ColorbarBase derives from ScalarMappable and puts a colorbar
# in a specified axes, so it has everything needed for a
# standalone colorbar. There are many more kwargs, but the
# following gives a basic continuous colorbar with ticks
# and labels.
cb1 = mpl.colorbar.ColorbarBase(ax1, cmap=cmap, norm=norm,
                                orientation='horizontal')
cb1.set_label('Some Units')

# Set the colormap and norm to correspond to the data for which
# the colorbar will be used.
cmap2 = mpl.cm.cool

```

```

norm2 = mpl.colors.Normalize(vmin=1, vmax=17)

# ColorbarBase derives from ScalarMappable and puts a colorbar
# in a specified axes, so it has everything needed for a
# standalone colorbar. There are many more kwargs, but the
# following gives a basic continuous colorbar with ticks
# and labels.
cb2 = mpl.colorbar.ColorbarBase(ax12, cmap=cmap2, norm=norm2,
                                orientation='horizontal')
cb2.set_label('Some other units')

# The second example illustrates the use of a ListedColormap, a
# BoundaryNorm, and extended ends to show the "over" and "under"
# value colors.
cmap3 = mpl.colors.ListedColormap(['r', 'g', 'b', 'c'])
cmap3.set_over('0.35')
cmap3.set_under('0.75')

# If a ListedColormap is used, the length of the bounds array must be
# one greater than the length of the color list. The bounds must be
# monotonically increasing.
bounds = [2, 3, 7, 9, 15]
norm3 = mpl.colors.BoundaryNorm(bounds, cmap3.N)
cb3 = mpl.colorbar.ColorbarBase(ax13, cmap=cmap3, norm=norm3,
                                # to use 'extend', you must
                                # specify two extra boundaries:
                                boundaries=[0]+bounds+[18],
                                extend='both',
                                ticks=bounds, # optional
                                spacing='proportional',
                                orientation='horizontal')
cb3.set_label('Discrete intervals, some other units')

# Create the 17 segment model
bullseye_plot(ax[0], data, cmap=cmap, norm=norm)
ax[0].set_title('Bulls Eye (AHA)')

bullseye_plot(ax[1], data, cmap=cmap2, norm=norm2)
ax[1].set_title('Bulls Eye (AHA)')

bullseye_plot(ax[2], data, segBold=[3, 5, 6, 11, 12, 16],
              cmap=cmap3, norm=norm3)
ax[2].set_title('Segments [3,5,6,11,12,16] in bold')

plt.show()

```

Keywords: python, matplotlib, pylab, example, codex (see [Search examples](#))

99.110 pylab_examples example code: legend_demo2.py

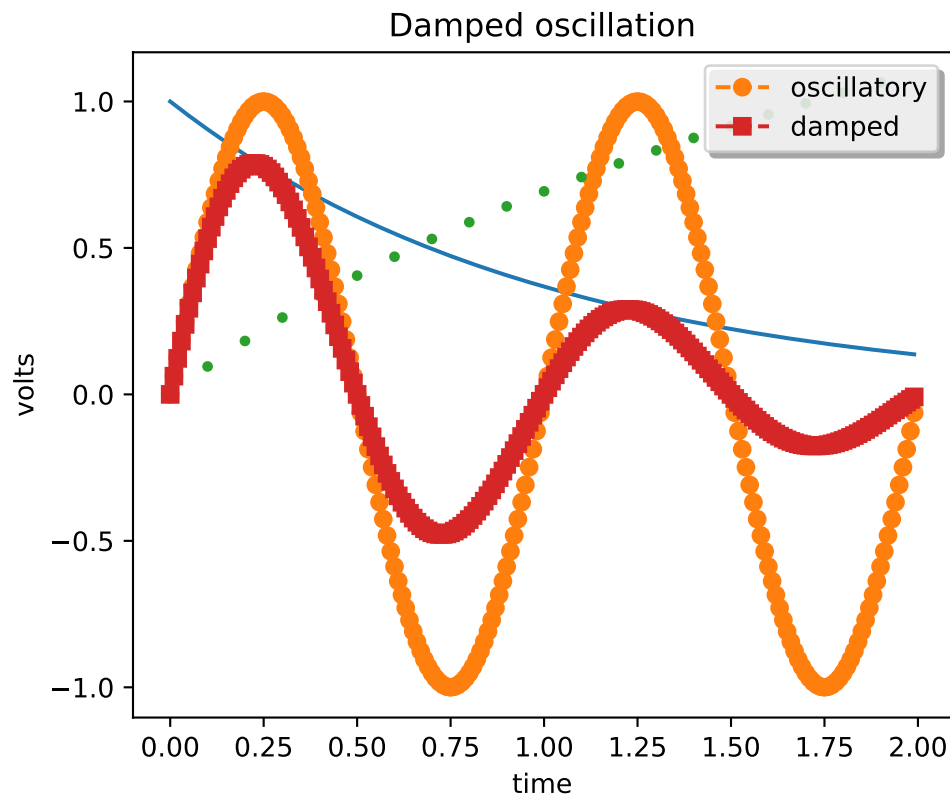

```
# Make a legend for specific lines.
import matplotlib.pyplot as plt
import numpy as np

t1 = np.arange(0.0, 2.0, 0.1)
t2 = np.arange(0.0, 2.0, 0.01)

# note that plot returns a list of lines. The "l1, = plot" usage
# extracts the first element of the list into l1 using tuple
# unpacking. So l1 is a Line2D instance, not a sequence of lines
l1, = plt.plot(t2, np.exp(-t2))
l2, l3 = plt.plot(t2, np.sin(2 * np.pi * t2), '--o', t1, np.log(1 + t1), '.')
l4, = plt.plot(t2, np.exp(-t2) * np.sin(2 * np.pi * t2), 's-.')

plt.legend((l2, l4), ('oscillatory', 'damped'), loc='upper right', shadow=True)
plt.xlabel('time')
plt.ylabel('volts')
plt.title('Damped oscillation')
plt.show()
```

Keywords: python, matplotlib, pylab, example, codex (see [Search examples](#))

99.111 pylab_examples example code: legend_demo3.py

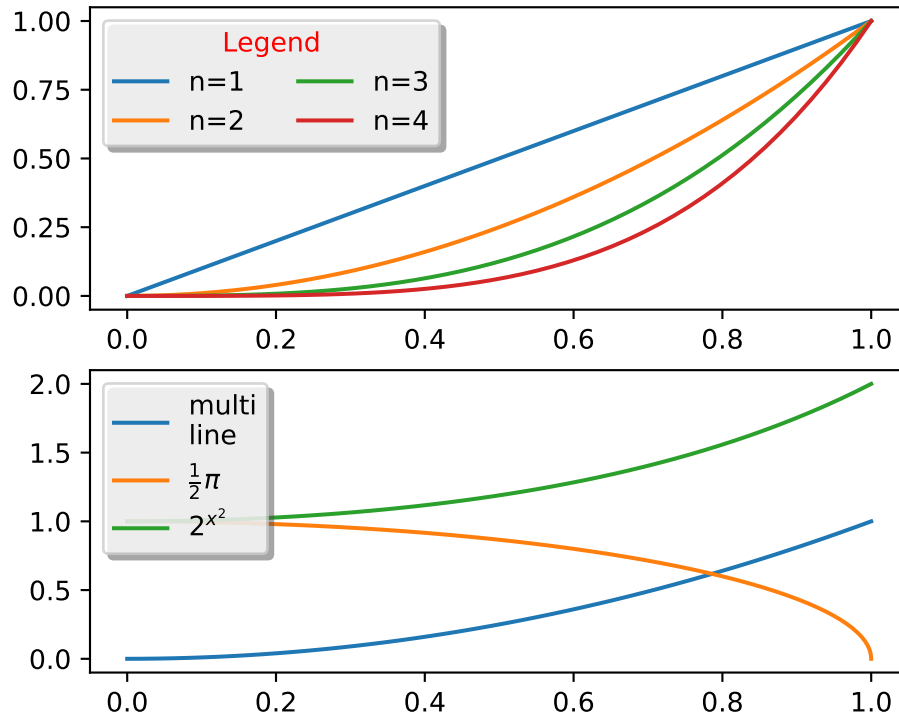

```
import matplotlib.pyplot as plt
import numpy as np

x = np.linspace(0, 1)

# Plot the lines y=x**n for n=1..4.
ax = plt.subplot(2, 1, 1)
for n in range(1, 5):
    plt.plot(x, x**n, label="n={0}".format(n))
plt.legend(loc="upper left", bbox_to_anchor=[0, 1],
          ncol=2, shadow=True, title="Legend", fancybox=True)
ax.get_legend().get_title().set_color("red")

# Demonstrate some more complex labels.
ax = plt.subplot(2, 1, 2)
plt.plot(x, x**2, label="multi\nline")
half_pi = np.linspace(0, np.pi / 2)
plt.plot(np.sin(half_pi), np.cos(half_pi), label=r"\frac{1}{2}\pi")
plt.plot(x, 2**(x**2), label="$2^{x^2}$")
plt.legend(shadow=True, fancybox=True)

plt.show()
```

Keywords: python, matplotlib, pylab, example, codex (see [Search examples](#))

99.112 pylab_examples example code: legend_demo4.py

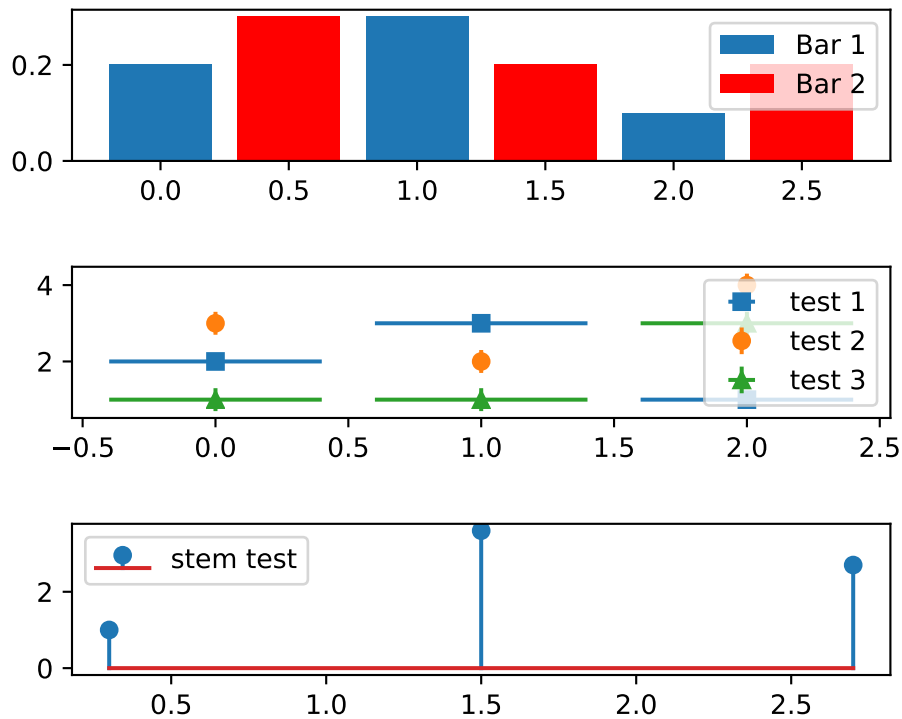

```
import matplotlib.pyplot as plt

fig, axes = plt.subplots(3, 1)
top_ax, middle_ax, bottom_ax = axes

top_ax.bar([0, 1, 2], [0.2, 0.3, 0.1], width=0.4, label="Bar 1",
           align="center")
top_ax.bar([0.5, 1.5, 2.5], [0.3, 0.2, 0.2], color="red", width=0.4,
           label="Bar 2", align="center")
top_ax.legend()

middle_ax.errorbar([0, 1, 2], [2, 3, 1], xerr=0.4, fmt="s", label="test 1")
middle_ax.errorbar([0, 1, 2], [3, 2, 4], yerr=0.3, fmt="o", label="test 2")
middle_ax.errorbar([0, 1, 2], [1, 1, 3], xerr=0.4, yerr=0.3, fmt="^",
                  label="test 3")
middle_ax.legend()

bottom_ax.stem([0.3, 1.5, 2.7], [1, 3.6, 2.7], label="stem test")
bottom_ax.legend()
```

```
plt.subplots_adjust(hspace=0.7)
plt.show()
```

Keywords: python, matplotlib, pylab, example, codex (see *Search examples*)

99.113 pylab_examples example code: legend_demo5.py

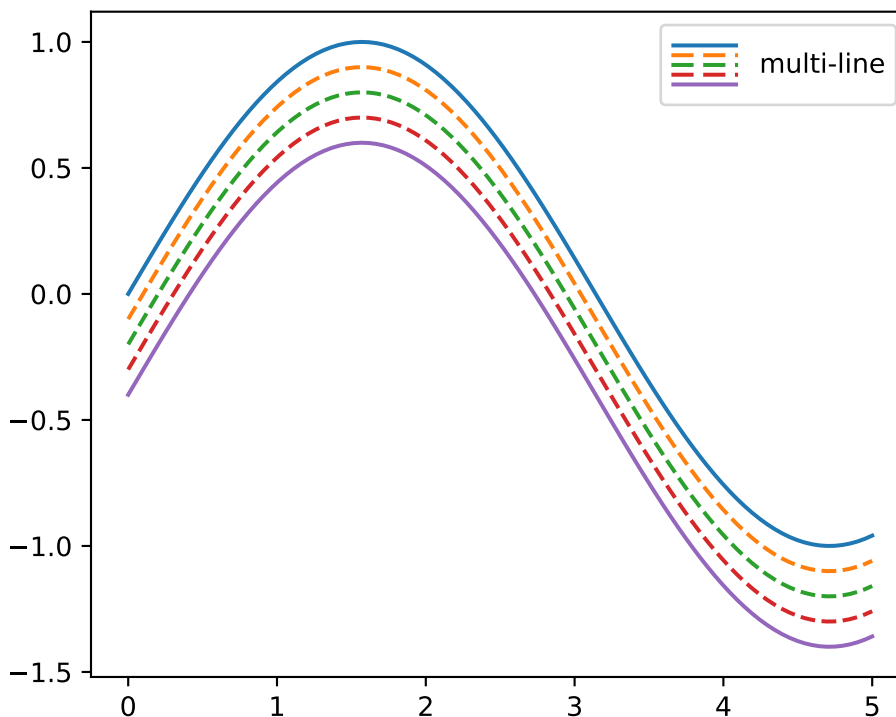

```
from __future__ import (absolute_import, division,
                        print_function, unicode_literals)
import six
from matplotlib import pyplot as plt
import numpy as np
from matplotlib.legend_handler import HandlerLineCollection
import matplotlib.collections as mcol
from matplotlib.lines import Line2D

class HandlerDashedLines(HandlerLineCollection):
    """
    Custom Handler for LineCollection instances.
    """
```



```

def create_artists(self, legend, orig_handle,
                  xdescent, ydescent, width, height, fontsize, trans):
    # figure out how many lines there are
    numlines = len(orig_handle.get_segments())
    xdata, xdata_marker = self.get_xdata(legend, xdescent, ydescent,
                                         width, height, fontsize)

    leglines = []
    # divide the vertical space where the lines will go
    # into equal parts based on the number of lines
    ydata = ((height) / (numlines + 1)) * np.ones(xdata.shape, float)
    # for each line, create the line at the proper location
    # and set the dash pattern
    for i in range(numlines):
        legline = Line2D(xdata, ydata * (numlines - i) - ydescent)
        self.update_prop(legline, orig_handle, legend)
        # set color, dash pattern, and linewidth to that
        # of the lines in linecollection
        try:
            color = orig_handle.get_colors()[i]
        except IndexError:
            color = orig_handle.get_colors()[0]
        try:
            dashes = orig_handle.get_dashes()[i]
        except IndexError:
            dashes = orig_handle.get_dashes()[0]
        try:
            lw = orig_handle.get_linewidths()[i]
        except IndexError:
            lw = orig_handle.get_linewidths()[0]
        if dashes[0] is not None:
            legline.set_dashes(dashes[1])
        legline.set_color(color)
        legline.set_transform(trans)
        legline.set_linewidth(lw)
        leglines.append(legline)
    return leglines

x = np.linspace(0, 5, 100)

plt.figure()
colors = plt.rcParams['axes.prop_cycle'].by_key()['color'][:5]
styles = ['solid', 'dashed', 'dashed', 'dashed', 'solid']
lines = []
for i, color, style in zip(range(5), colors, styles):
    plt.plot(x, np.sin(x) - .1 * i, c=color, ls=style)

# make proxy artists
# make list of one line -- doesn't matter what the coordinates are
line = [[(0, 0)]]
# set up the proxy artist
lc = mcol.LineCollection(5 * line, linestyle=styles, colors=colors)
# create the legend

```

```
plt.legend([lc], ['multi-line'], handler_map={type(lc): HandlerDashedLines()},
           handlelength=2.5, handleheight=3)

plt.show()
```

Keywords: python, matplotlib, pylab, example, codex (see *Search examples*)

99.114 pylab_examples example code: line_collection.py

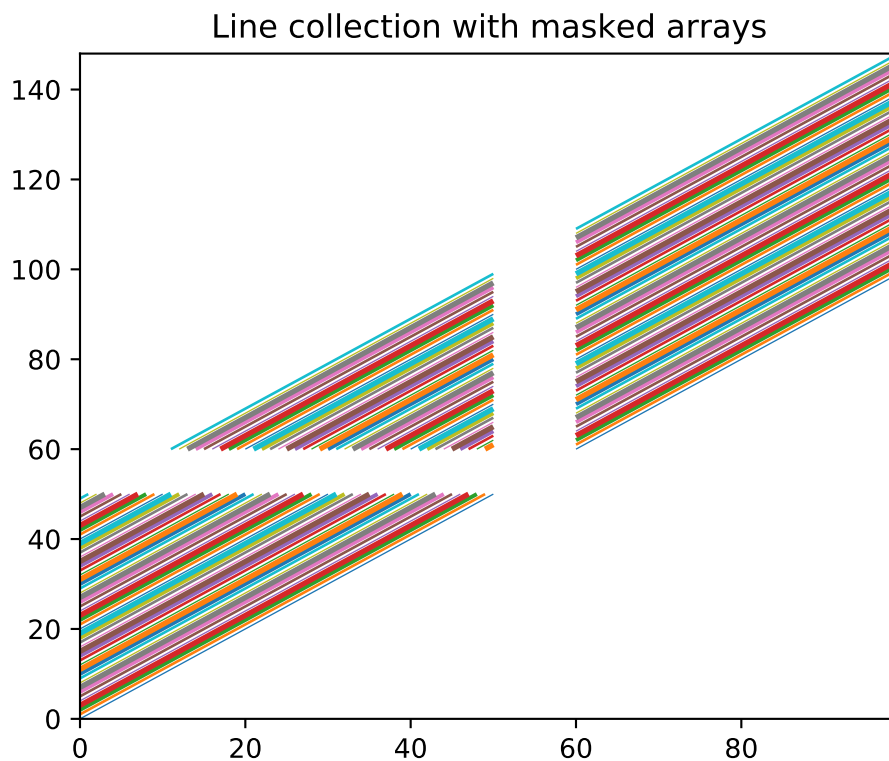

```
import matplotlib.pyplot as plt
from matplotlib.collections import LineCollection
from matplotlib import colors as mcolors

import numpy as np

# In order to efficiently plot many lines in a single set of axes,
# Matplotlib has the ability to add the lines all at once. Here is a
# simple example showing how it is done.

x = np.arange(100)
# Here are many sets of y to plot vs x
ys = x[:50, np.newaxis] + x[np.newaxis, :]
```

```
segs = np.zeros((50, 100, 2), float)
segs[:, :, 1] = ys
segs[:, :, 0] = x

# Mask some values to test masked array support:
segs = np.ma.masked_where((segs > 50) & (segs < 60), segs)

# We need to set the plot limits.
ax = plt.axes()
ax.set_xlim(x.min(), x.max())
ax.set_ylim(ys.min(), ys.max())

# colors is sequence of rgba tuples
# linestyle is a string or dash tuple. Legal string values are
#     solid/dashed/dashdot/dotted. The dash tuple is (offset, onoffseq)
#     where onoffseq is an even length tuple of on and off ink in points.
#     If linestyle is omitted, 'solid' is used
# See matplotlib.collections.LineCollection for more information
colors = [mcolors.to_rgba(c)
          for c in plt.rcParams['axes.prop_cycle'].by_key()['color']]

line_segments = LineCollection(segs, linewidths=(0.5, 1, 1.5, 2),
                              colors=colors, linestyle='solid')
ax.add_collection(line_segments)
ax.set_title('Line collection with masked arrays')
plt.show()
```

Keywords: python, matplotlib, pylab, example, codex (see [Search examples](#))

99.115 pylab_examples example code: line_collection2.py

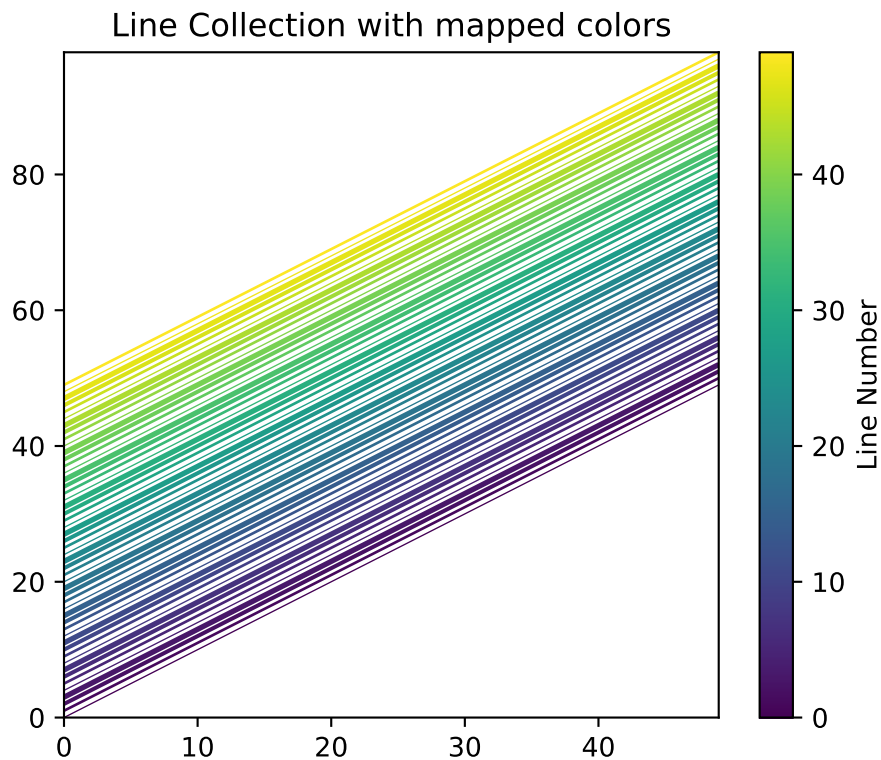

```
import matplotlib.pyplot as plt
import numpy as np
from matplotlib.collections import LineCollection

# In order to efficiently plot many lines in a single set of axes,
# Matplotlib has the ability to add the lines all at once. Here is a
# simple example showing how it is done.

N = 50
x = np.arange(N)
# Here are many sets of y to plot vs x
ys = [x + i for i in x]

# We need to set the plot limits, they will not autoscale
ax = plt.axes()
ax.set_xlim((np.amin(x), np.amax(x)))
ax.set_ylim((np.amin(np.amin(ys)), np.amax(np.amax(ys))))

# colors is sequence of rgba tuples
# linestyle is a string or dash tuple. Legal string values are
#     solid/dashed/dashdot/dotted. The dash tuple is (offset, onoffseq)
#     where onoffseq is an even length tuple of on and off ink in points.
```

```

#         If linestyle is omitted, 'solid' is used
# See matplotlib.collections.LineCollection for more information

# Make a sequence of x,y pairs
line_segments = LineCollection([list(zip(x, y)) for y in ys],
                               linewidths=(0.5, 1, 1.5, 2),
                               linestyles='solid')

line_segments.set_array(x)
ax.add_collection(line_segments)
fig = plt.gcf()
axcb = fig.colorbar(line_segments)
axcb.set_label('Line Number')
ax.set_title('Line Collection with mapped colors')
plt.sci(line_segments) # This allows interactive changing of the colormap.
plt.show()

```

Keywords: python, matplotlib, pylab, example, codex (see [Search examples](#))

99.116 pylab_examples example code: load_converter.py

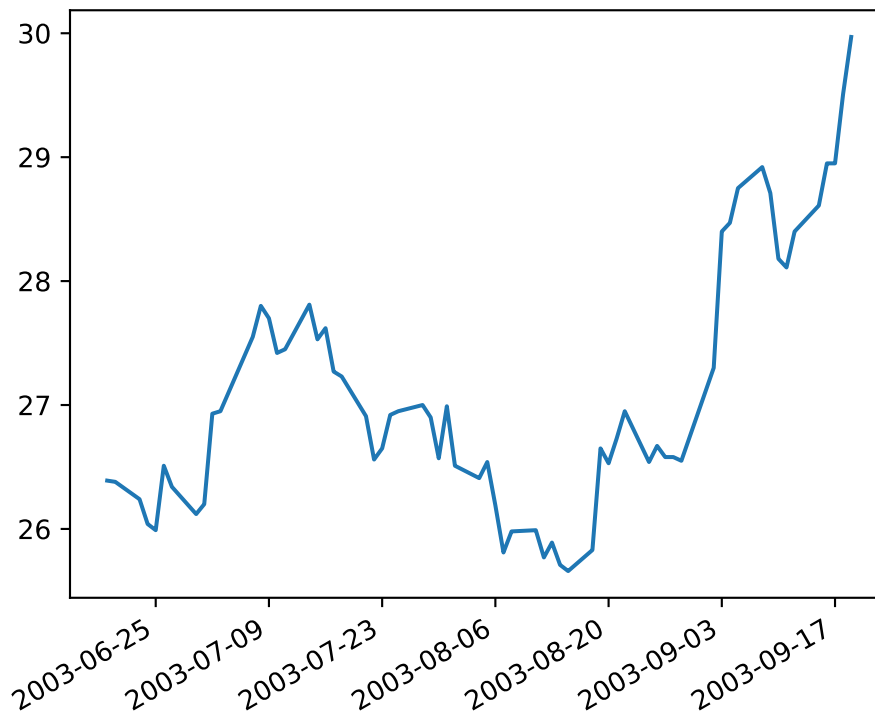

```

from __future__ import print_function
import numpy as np

```

```
import matplotlib.pyplot as plt
import matplotlib.cbook as cbook
import matplotlib.dates as mdates
from matplotlib.dates import bytespdate2num

datafile = cbook.get_sample_data('msft.csv', asfileobj=False)
print('loading', datafile)

dates, closes = np.loadtxt(datafile, delimiter=',',
                           converters={0: bytespdate2num('%d-%b-%y')},
                           skiprows=1, usecols=(0, 2), unpack=True)

fig = plt.figure()
ax = fig.add_subplot(111)
ax.plot_date(dates, closes, '-')
fig.autofmt_xdate()
plt.show()
```

Keywords: python, matplotlib, pylab, example, codex (see [Search examples](#))

99.117 pylab_examples example code: loadrec.py

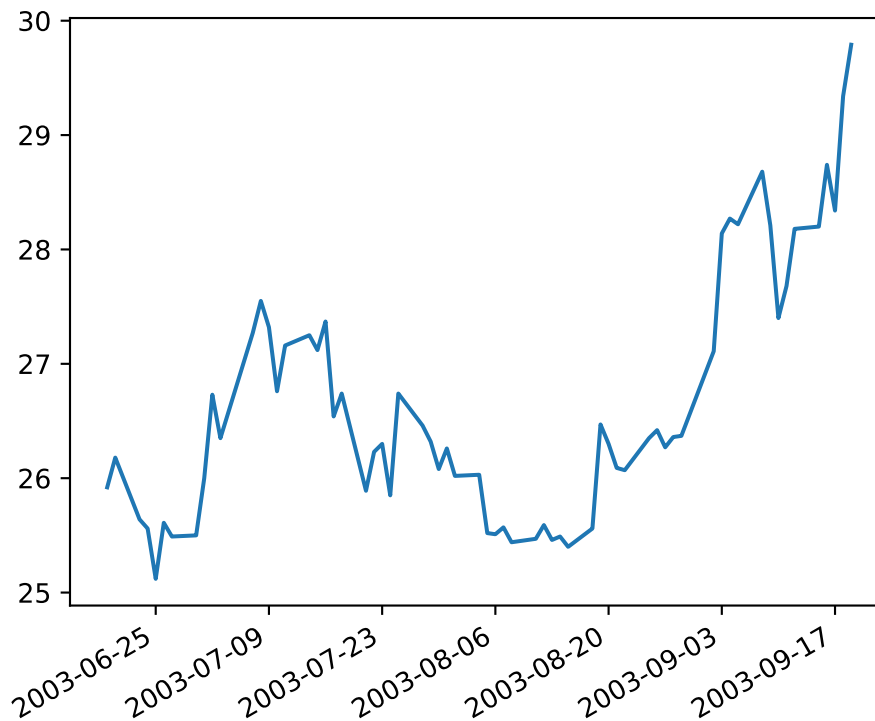

```
from __future__ import print_function
from matplotlib import mlab
import matplotlib.pyplot as plt
import matplotlib.cbook as cbook

datafile = cbook.get_sample_data('msft.csv', asfileobj=False)
print('loading', datafile)
a = mlab.csv2rec(datafile)
a.sort()
print(a.dtype)

fig = plt.figure()
ax = fig.add_subplot(111)
ax.plot(a.date, a.adj_close, '-')
fig.autofmt_xdate()

# if you have xlwt installed, you can output excel
try:
    import mpl_toolkits.exceltools as exceltools
    exceltools.rec2excel(a, 'test.xls')
except ImportError:
    pass
plt.show()
```

Keywords: python, matplotlib, pylab, example, codex (see [Search examples](#))

99.118 pylab_examples example code: log_bar.py

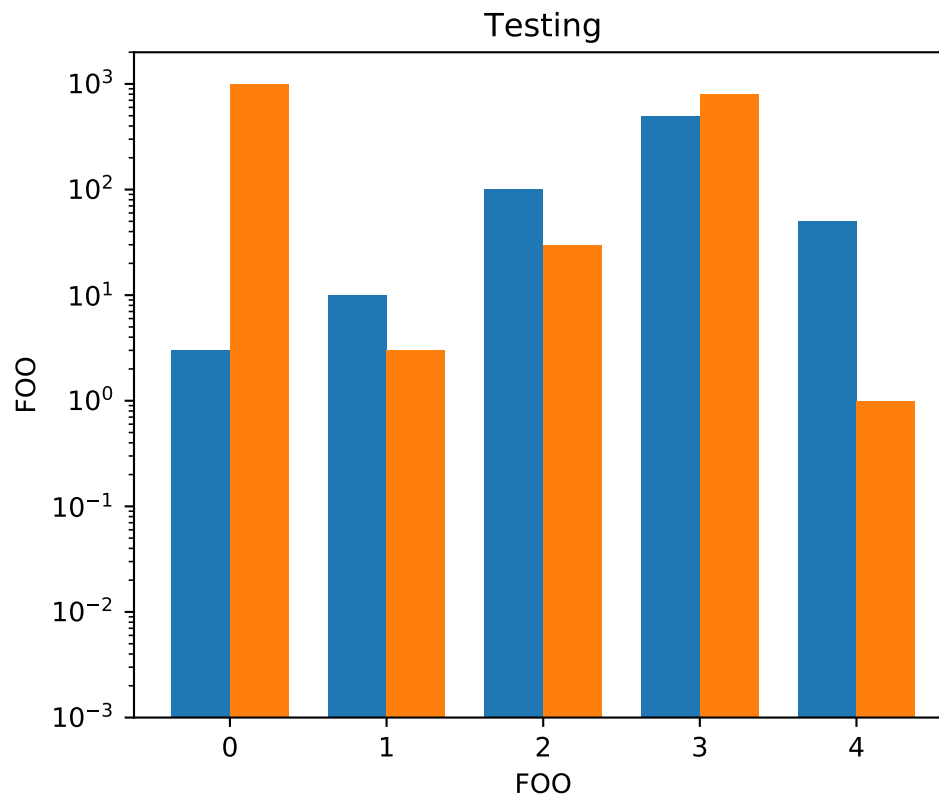

```
import matplotlib.pyplot as plt
import numpy as np

data = ((3, 1000), (10, 3), (100, 30), (500, 800), (50, 1))

plt.xlabel("FOO")
plt.ylabel("FOO")
plt.title("Testing")
plt.yscale('log')

dim = len(data[0])
w = 0.75
dimw = w / dim

x = np.arange(len(data))
for i in range(len(data[0])):
    y = [d[i] for d in data]
    b = plt.bar(x + i * dimw, y, dimw, bottom=0.001)

plt.xticks(x + dimw / 2, map(str, x))

plt.show()
```

Keywords: python, matplotlib, pylab, example, codex (see [Search examples](#))

99.119 pylab_examples example code: log_demo.py

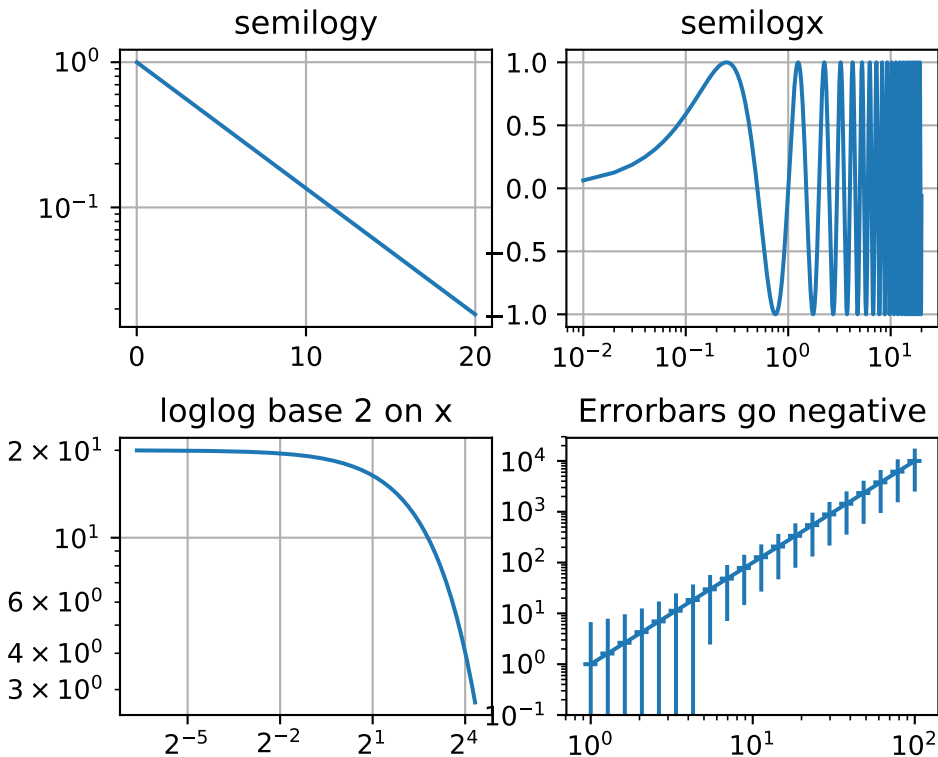

```
import numpy as np
import matplotlib.pyplot as plt

plt.subplots_adjust(hspace=0.4)
t = np.arange(0.01, 20.0, 0.01)

# log y axis
plt.subplot(221)
plt.semilogy(t, np.exp(-t/5.0))
plt.title('semilogy')
plt.grid(True)

# log x axis
plt.subplot(222)
plt.semilogx(t, np.sin(2*np.pi*t))
plt.title('semilogx')
plt.grid(True)

# log x and y axis
```

```
plt.subplot(223)
plt.loglog(t, 20*np.exp(-t/10.0), basex=2)
plt.grid(True)
plt.title('loglog base 2 on x')

# with errorbars: clip non-positive values
ax = plt.subplot(224)
ax.set_xscale("log", nonposx='clip')
ax.set_yscale("log", nonposy='clip')

x = 10.0**np.linspace(0.0, 2.0, 20)
y = x**2.0
plt.errorbar(x, y, xerr=0.1*x, yerr=5.0 + 0.75*y)
ax.set_ylim(ymin=0.1)
ax.set_title('Errorbars go negative')

plt.show()
```

Keywords: python, matplotlib, pylab, example, codex (see [Search examples](#))

99.120 pylab_examples example code: log_test.py

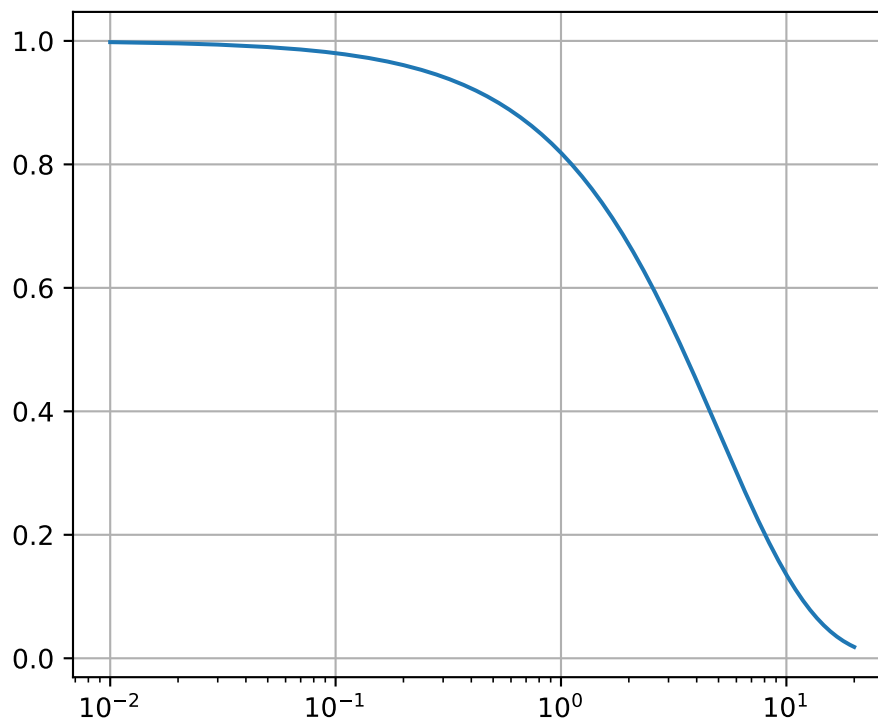

```
import matplotlib.pyplot as plt
import numpy as np

dt = 0.01
t = np.arange(dt, 20.0, dt)

plt.semilogx(t, np.exp(-t/5.0))
plt.grid(True)

plt.show()
```

Keywords: python, matplotlib, pylab, example, codex (see *Search examples*)

99.121 pylab_examples example code: logo.py



```
# This file generates an old version of the matplotlib logo

from __future__ import print_function
# Above import not necessary for Python 3 onwards. Recommend taking this
# out in examples in the future, since we should all move to Python 3.
import matplotlib.pyplot as plt
import numpy as np
import matplotlib.cbook as cbook

# convert data to mV
datafile = cbook.get_sample_data('membrane.dat', asfileobj=False)
print('loading', datafile)

x = 1000 * 0.1 * np.fromstring(open(datafile, 'rb').read(), np.float32)
# 0.0005 is the sample interval
t = 0.0005 * np.arange(len(x))
plt.figure(1, figsize=(7, 1), dpi=100)
ax = plt.subplot(111, facecolor='y')
plt.plot(t, x)
plt.text(0.5, 0.5, 'matplotlib', color='r',
         fontsize=40, fontname=['Courier', 'DejaVu Sans Mono'],
         horizontalalignment='center',
         verticalalignment='center',
         transform=ax.transAxes,
         )
plt.axis([1, 1.72, -60, 10])
plt.gca().set_xticklabels([])
plt.gca().set_yticklabels([])
```

```
plt.show()
```

Keywords: python, matplotlib, pylab, example, codex (see *Search examples*)

99.122 pylab_examples example code: major_minor_demo1.py

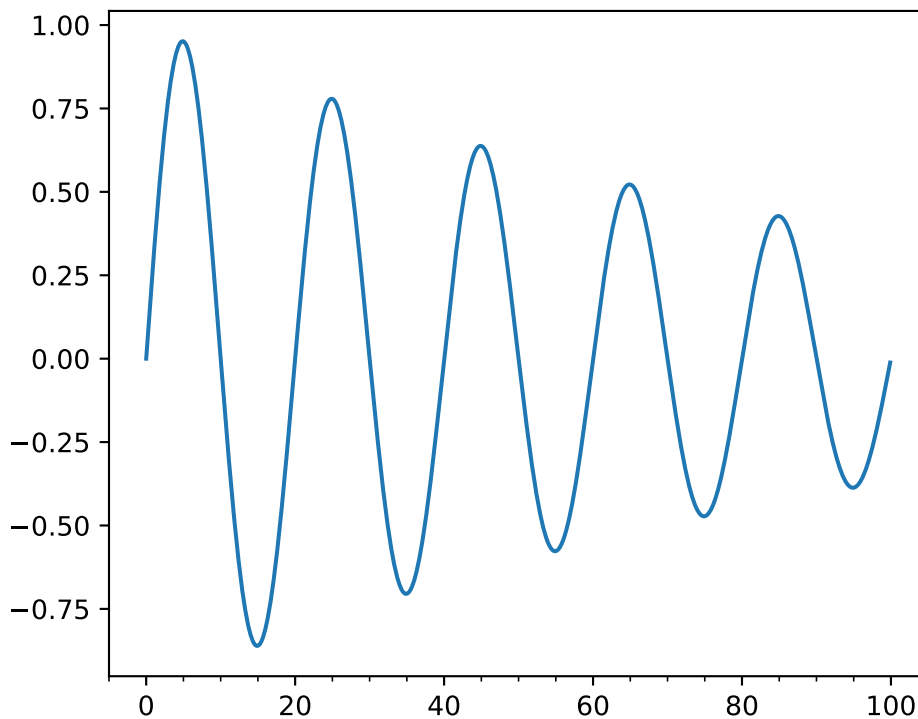

```
"""  
Demonstrate how to use major and minor tickers.  
  
The two relevant userland classes are Locators and Formatters.  
Locators determine where the ticks are and formatters control the  
formatting of ticks.  
  
Minor ticks are off by default (NullLocator and NullFormatter). You  
can turn minor ticks on w/o labels by setting the minor locator. You  
can also turn labeling on for the minor ticker by setting the minor  
formatter  
  
Make a plot with major ticks that are multiples of 20 and minor ticks  
that are multiples of 5. Label major ticks with %d formatting but  
don't label minor ticks
```

The `MultipleLocator` ticker class is used to place ticks on multiples of some base. The `FormatStrFormatter` uses a string format string (e.g., `%d` or `%1.2f` or `%1.1f cm`) to format the tick

The `pyplot` interface `grid` command changes the grid settings of the major ticks of the `y` and `x` axis together. If you want to control the grid of the minor ticks for a given axis, use for example

```
ax.xaxis.grid(True, which='minor')
```

Note, you should not use the same locator between different `Axis` because the locator stores references to the `Axis` data and view limits

```
"""
```

```
import matplotlib.pyplot as plt
import numpy as np
from matplotlib.ticker import MultipleLocator, FormatStrFormatter

majorLocator = MultipleLocator(20)
majorFormatter = FormatStrFormatter('%d')
minorLocator = MultipleLocator(5)

t = np.arange(0.0, 100.0, 0.1)
s = np.sin(0.1*np.pi*t)*np.exp(-t*0.01)

fig, ax = plt.subplots()
plt.plot(t, s)

ax.xaxis.set_major_locator(majorLocator)
ax.xaxis.set_major_formatter(majorFormatter)

# for the minor ticks, use no labels; default NullFormatter
ax.xaxis.set_minor_locator(minorLocator)

plt.show()
```

Keywords: python, matplotlib, pylab, example, codex (see [Search examples](#))

99.123 pylab_examples example code: major_minor_demo2.py

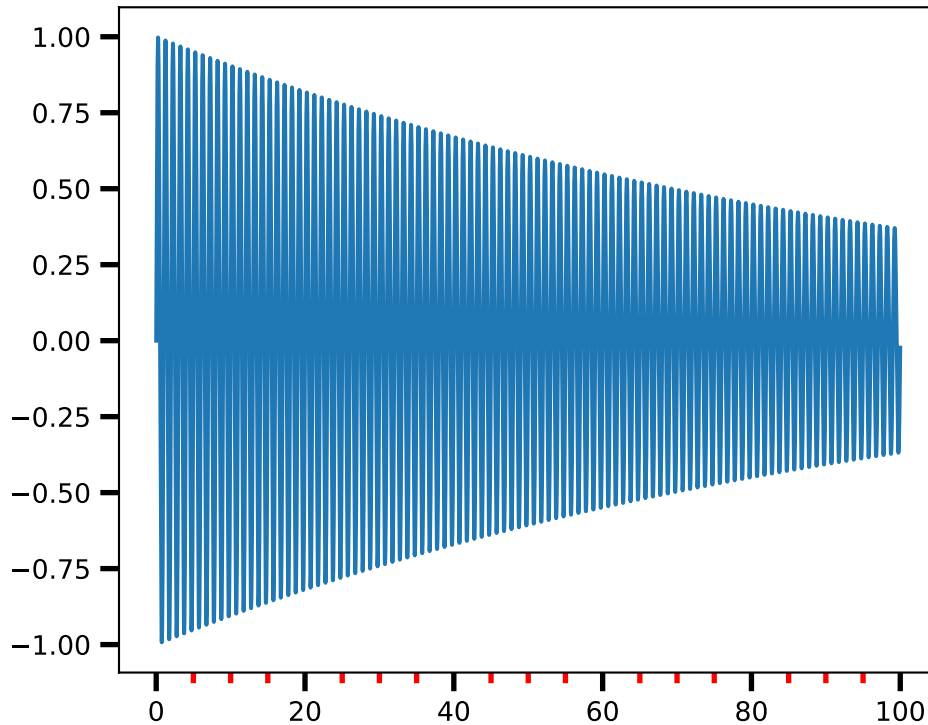

```
"""
Automatic tick selection for major and minor ticks.

Use interactive pan and zoom to see how the tick intervals
change. There will be either 4 or 5 minor tick intervals
per major interval, depending on the major interval.
"""

import numpy as np
import matplotlib.pyplot as plt
from matplotlib.ticker import AutoMinorLocator

# One can supply an argument to AutoMinorLocator to
# specify a fixed number of minor intervals per major interval, e.g.:
# minorLocator = AutoMinorLocator(2)
# would lead to a single minor tick between major ticks.

minorLocator = AutoMinorLocator()

t = np.arange(0.0, 100.0, 0.01)
s = np.sin(2*np.pi*t)*np.exp(-t*0.01)
```

```

fig, ax = plt.subplots()
plt.plot(t, s)

ax.xaxis.set_minor_locator(minorLocator)

plt.tick_params(which='both', width=2)
plt.tick_params(which='major', length=7)
plt.tick_params(which='minor', length=4, color='r')

plt.show()

```

Keywords: python, matplotlib, pylab, example, codex (see *Search examples*)

99.124 pylab_examples example code: manual_axis.py

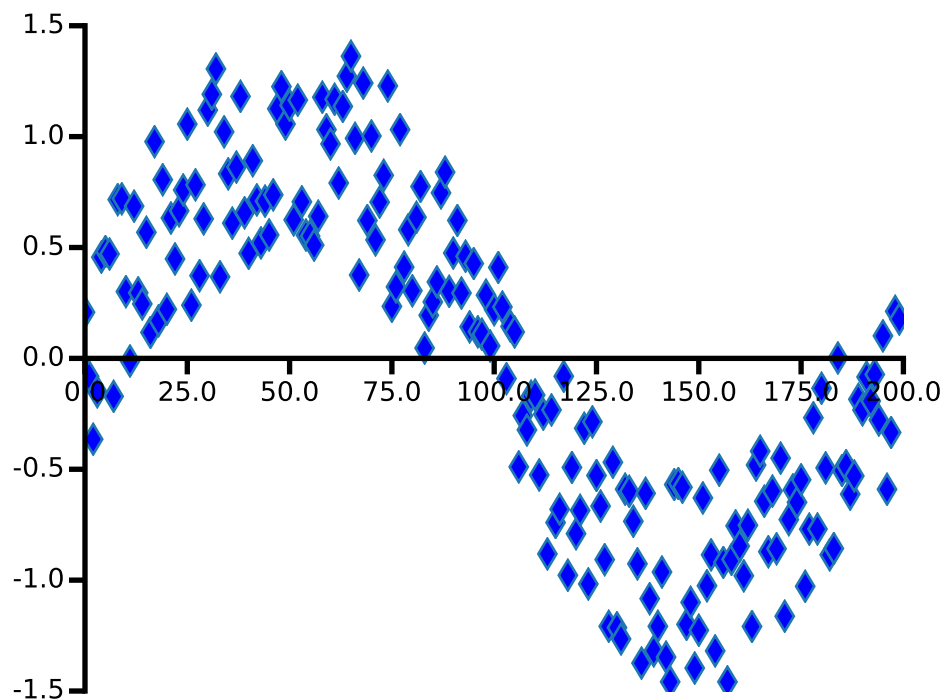

```

"""
The techniques here are no longer required with the new support for
spines in matplotlib -- see
http://matplotlib.org/examples/pylab\_examples/spine\_placement\_demo.html.

This example should be considered deprecated and is left just for demo

```

```

purposes for folks wanting to make a pseudo-axis
"""

import numpy as np
import matplotlib.pyplot as plt
import matplotlib.lines as lines

def make_xaxis(ax, yloc, offset=0.05, **props):
    xmin, xmax = ax.get_xlim()
    locs = [loc for loc in ax.xaxis.get_majorticklocs()
            if loc >= xmin and loc <= xmax]
    tickline, = ax.plot(locs, [yloc]*len(locs), linestyle='',
                        marker=lines.TICKDOWN, **props)
    axline, = ax.plot([xmin, xmax], [yloc, yloc], **props)
    tickline.set_clip_on(False)
    axline.set_clip_on(False)
    for loc in locs:
        ax.text(loc, yloc - offset, '%1.1f' % loc,
               horizontalalignment='center',
               verticalalignment='top')

def make_yaxis(ax, xloc=0, offset=0.05, **props):
    ymin, ymax = ax.get_ylim()
    locs = [loc for loc in ax.yaxis.get_majorticklocs()
            if loc >= ymin and loc <= ymax]
    tickline, = ax.plot([xloc]*len(locs), locs, linestyle='',
                        marker=lines.TICKLEFT, **props)
    axline, = ax.plot([xloc, xloc], [ymin, ymax], **props)
    tickline.set_clip_on(False)
    axline.set_clip_on(False)

    for loc in locs:
        ax.text(xloc - offset, loc, '%1.1f' % loc,
               verticalalignment='center',
               horizontalalignment='right')

props = dict(color='black', linewidth=2, markeredgewidth=2)
x = np.arange(200.)
y = np.sin(2*np.pi*x/200.) + np.random.rand(200) - 0.5
fig = plt.figure(facecolor='white')
ax = fig.add_subplot(111, frame_on=False)
ax.axison = False
ax.plot(x, y, 'd', markersize=8, markerfacecolor='blue')
ax.set_xlim(0, 200)
ax.set_ylim(-1.5, 1.5)
make_xaxis(ax, 0, offset=0.1, **props)
make_yaxis(ax, 0, offset=5, **props)

plt.show()

```

Keywords: python, matplotlib, pylab, example, codex (see [Search examples](#))

99.125 pylab_examples example code: marker_path.py

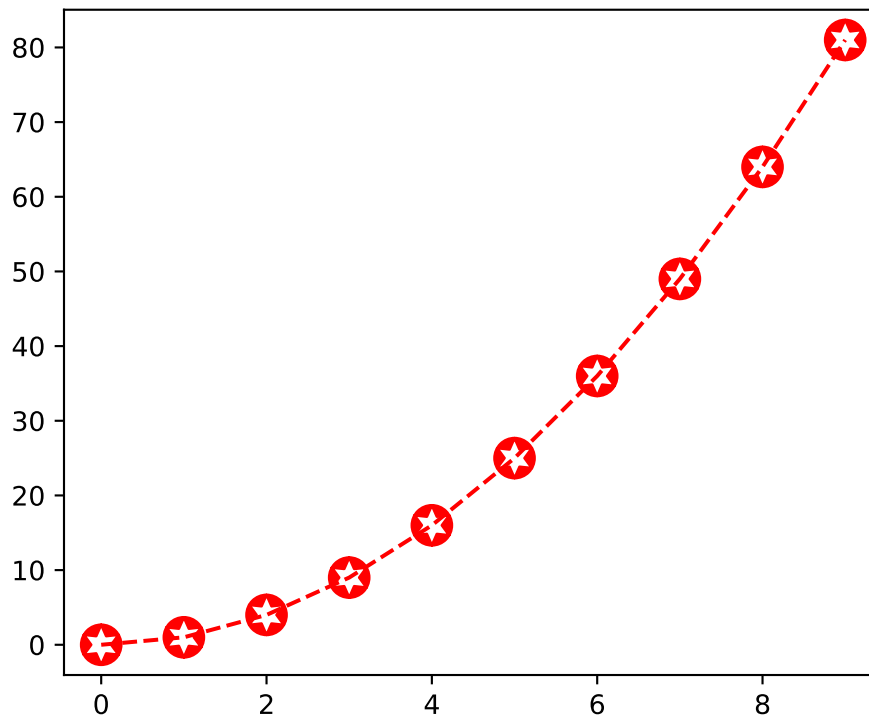

```
import matplotlib.pyplot as plt
import matplotlib.path as mpath
import numpy as np

star = mpath.Path.unit_regular_star(6)
circle = mpath.Path.unit_circle()
# concatenate the circle with an internal cutout of the star
verts = np.concatenate([circle.vertices, star.vertices[::-1, ...]])
codes = np.concatenate([circle.codes, star.codes])
cut_star = mpath.Path(verts, codes)

plt.plot(np.arange(10)**2, '--r', marker=cut_star, markersize=15)

plt.show()
```

Keywords: python, matplotlib, pylab, example, codex (see [Search examples](#))

99.126 pylab_examples example code: markevery_demo.py

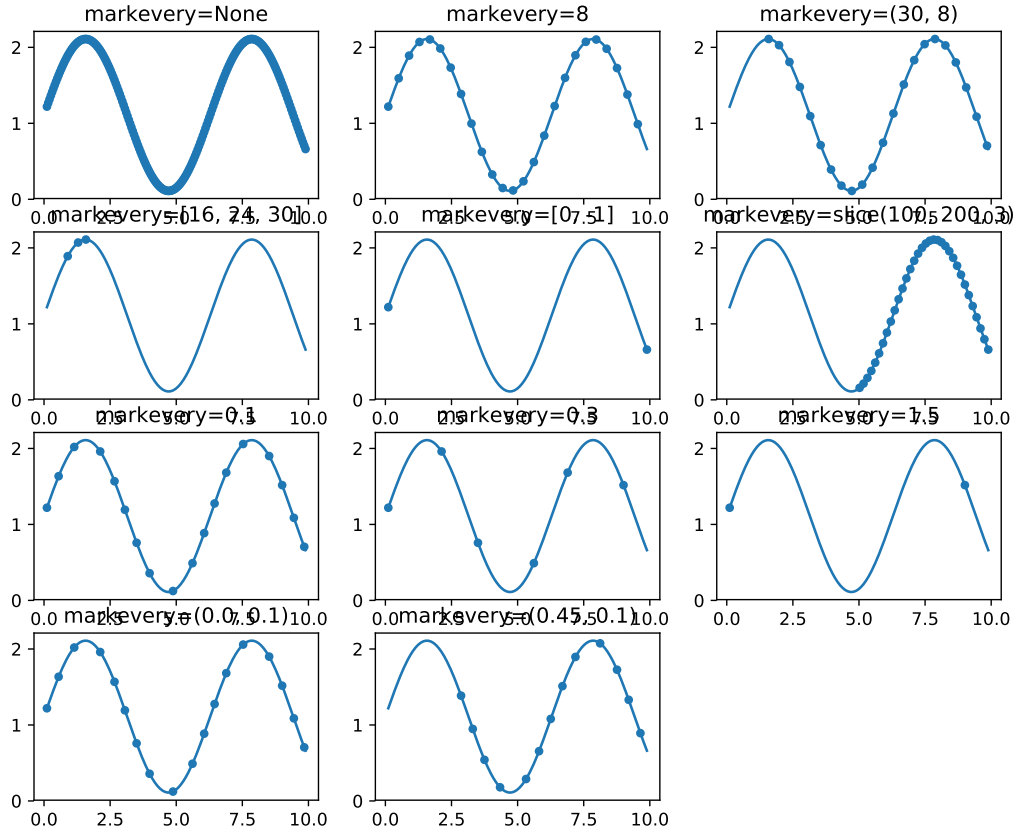

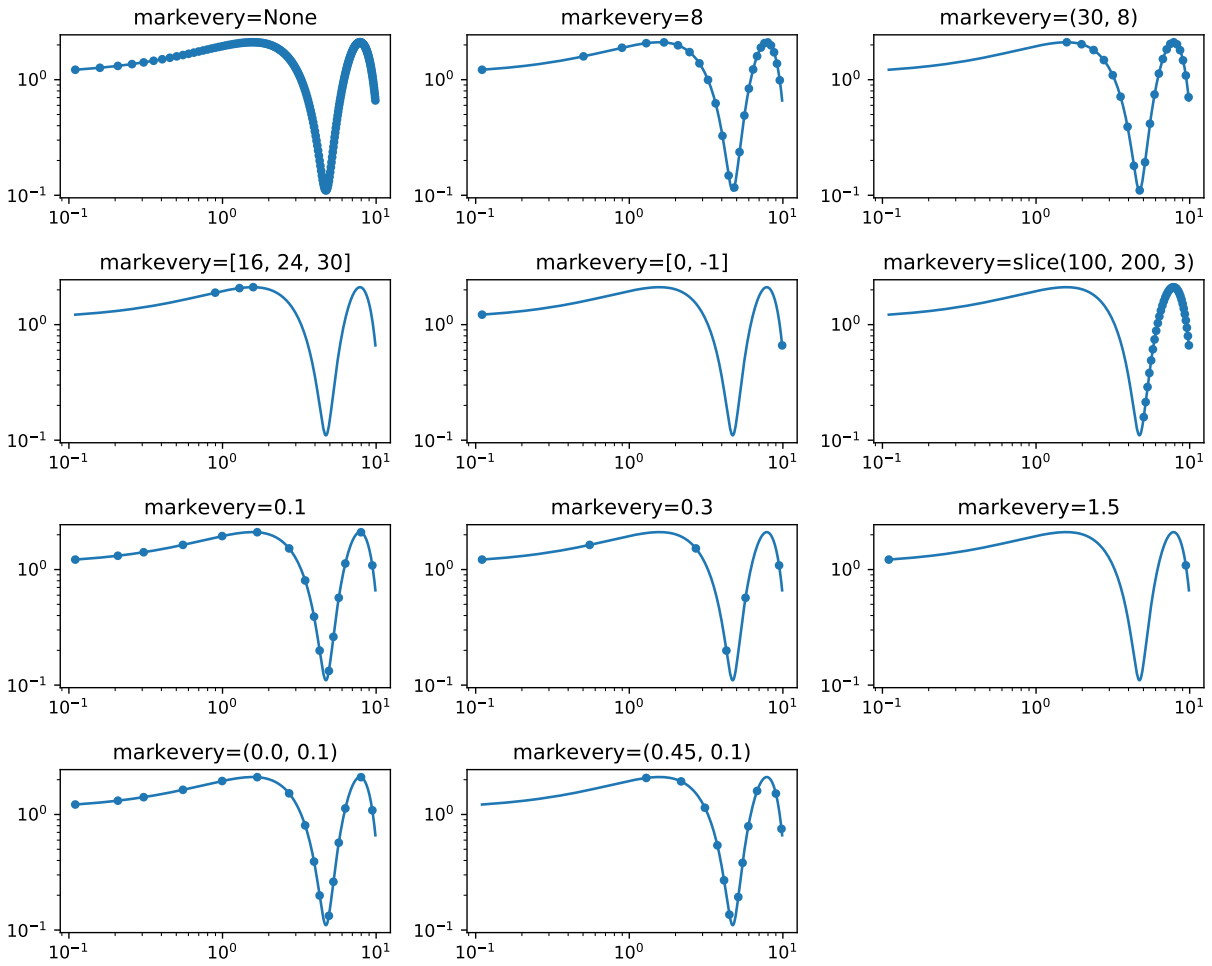

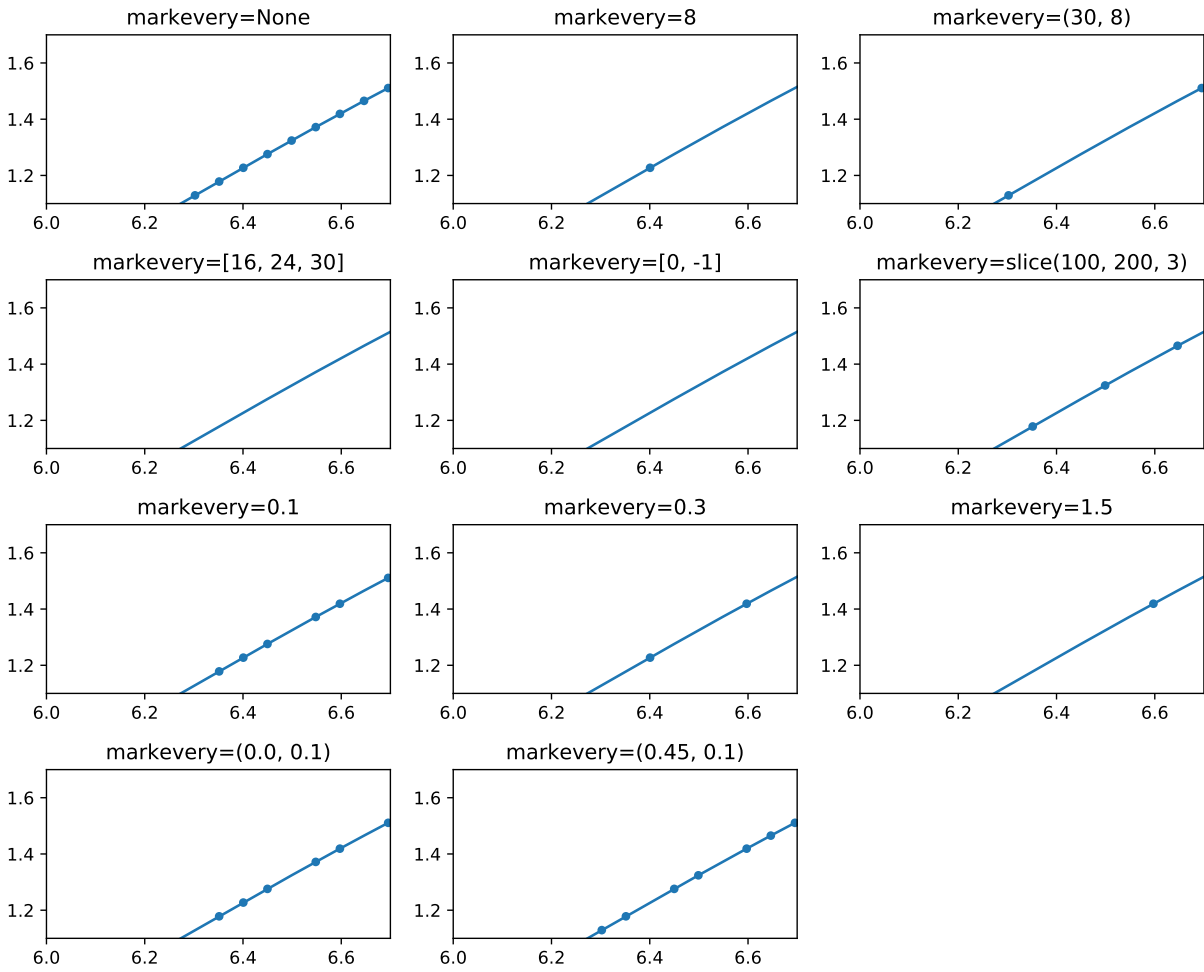

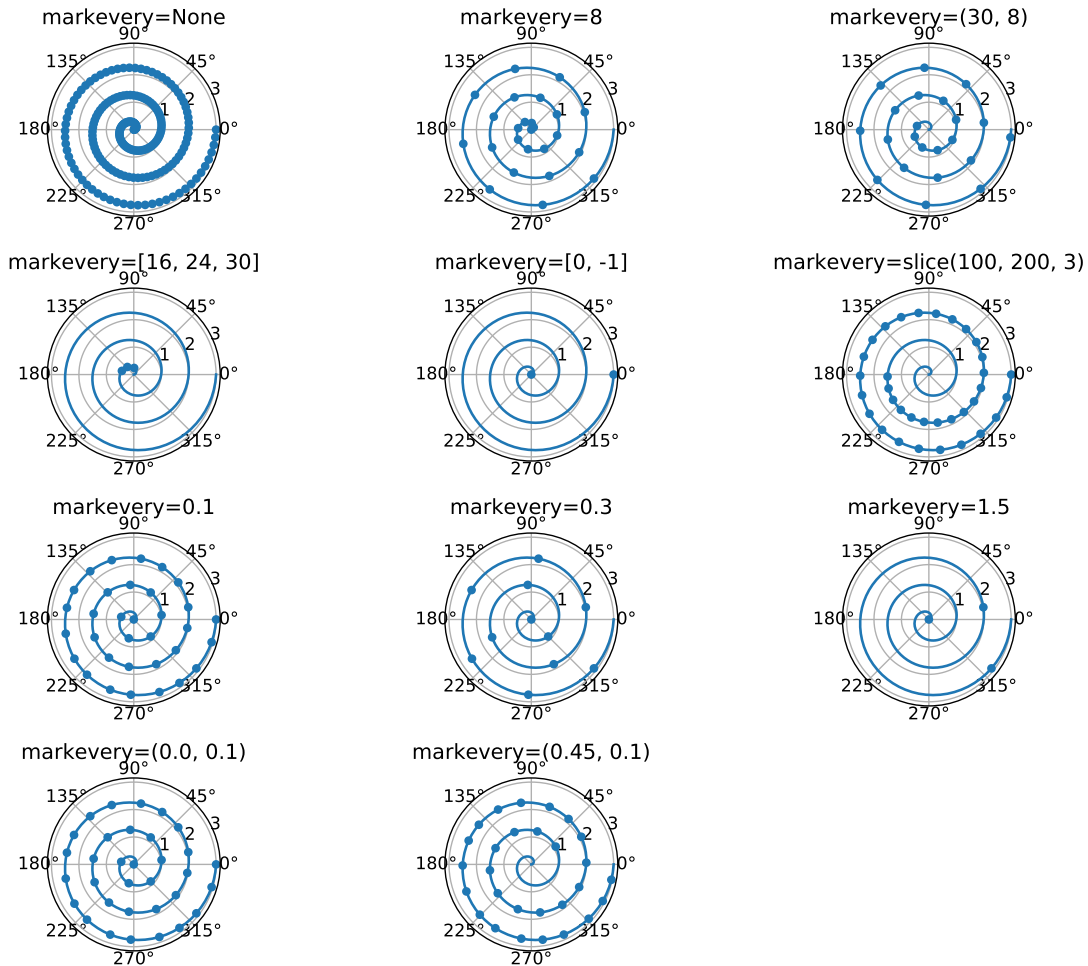

```
"""
```

This example demonstrates the various options for showing a marker at a subset of data points using the `markevery` property of a `Line2D` object.

Integer arguments are fairly intuitive. e.g. `markevery=5` will plot every 5th marker starting from the first data point.

Float arguments allow markers to be spaced at approximately equal distances along the line. The theoretical distance along the line between markers is determined by multiplying the display-coordinate distance of the axes bounding-box diagonal by the value of `markevery`. The data points closest to the theoretical distances will be shown.

A slice or list/array can also be used with `markevery` to specify the markers to show.

```
"""
```

```
from __future__ import division
import numpy as np
import matplotlib.pyplot as plt
```

```

import matplotlib.gridspec as gridspec

# define a list of markevery cases to plot
cases = [None,
         8,
         (30, 8),
         [16, 24, 30], [0, -1],
         slice(100, 200, 3),
         0.1, 0.3, 1.5,
         (0.0, 0.1), (0.45, 0.1)]

# define the figure size and grid layout properties
figsize = (10, 8)
cols = 3
gs = gridspec.GridSpec(len(cases) // cols + 1, cols)

# define the data for cartesian plots
delta = 0.11
x = np.linspace(0, 10 - 2 * delta, 200) + delta
y = np.sin(x) + 1.0 + delta

# plot each markevery case for linear x and y scales
fig1 = plt.figure(num=1, figsize=figsize)
ax = []
for i, case in enumerate(cases):
    row = (i // cols)
    col = i % cols
    ax.append(fig1.add_subplot(gs[row, col]))
    ax[-1].set_title('markevery=%s' % str(case))
    ax[-1].plot(x, y, 'o', ls='-', ms=4, markevery=case)
fig1.tight_layout()

# plot each markevery case for log x and y scales
fig2 = plt.figure(num=2, figsize=figsize)
axlog = []
for i, case in enumerate(cases):
    row = (i // cols)
    col = i % cols
    axlog.append(fig2.add_subplot(gs[row, col]))
    axlog[-1].set_title('markevery=%s' % str(case))
    axlog[-1].set_xscale('log')
    axlog[-1].set_yscale('log')
    axlog[-1].plot(x, y, 'o', ls='-', ms=4, markevery=case)
fig2.tight_layout()

# plot each markevery case for linear x and y scales but zoomed in
# note the behaviour when zoomed in. When a start marker offset is specified
# it is always interpreted with respect to the first data point which might be
# different to the first visible data point.
fig3 = plt.figure(num=3, figsize=figsize)
axzoom = []
for i, case in enumerate(cases):
    row = (i // cols)

```

```
col = i % cols
axzoom.append(fig3.add_subplot(gs[row, col]))
axzoom[-1].set_title('markevery=%s' % str(case))
axzoom[-1].plot(x, y, 'o', ls='-', ms=4, markevery=case)
axzoom[-1].set_xlim((6, 6.7))
axzoom[-1].set_ylim((1.1, 1.7))
fig3.tight_layout()

# define data for polar plots
r = np.linspace(0, 3.0, 200)
theta = 2 * np.pi * r

# plot each markevery case for polar plots
fig4 = plt.figure(num=4, figsize=figsize)
axpolar = []
for i, case in enumerate(cases):
    row = (i // cols)
    col = i % cols
    axpolar.append(fig4.add_subplot(gs[row, col], projection='polar'))
    axpolar[-1].set_title('markevery=%s' % str(case))
    axpolar[-1].plot(theta, r, 'o', ls='-', ms=4, markevery=case)
fig4.tight_layout()

plt.show()
```

Keywords: python, matplotlib, pylab, example, codex (see [Search examples](#))

99.127 pylab_examples example code: masked_demo.py

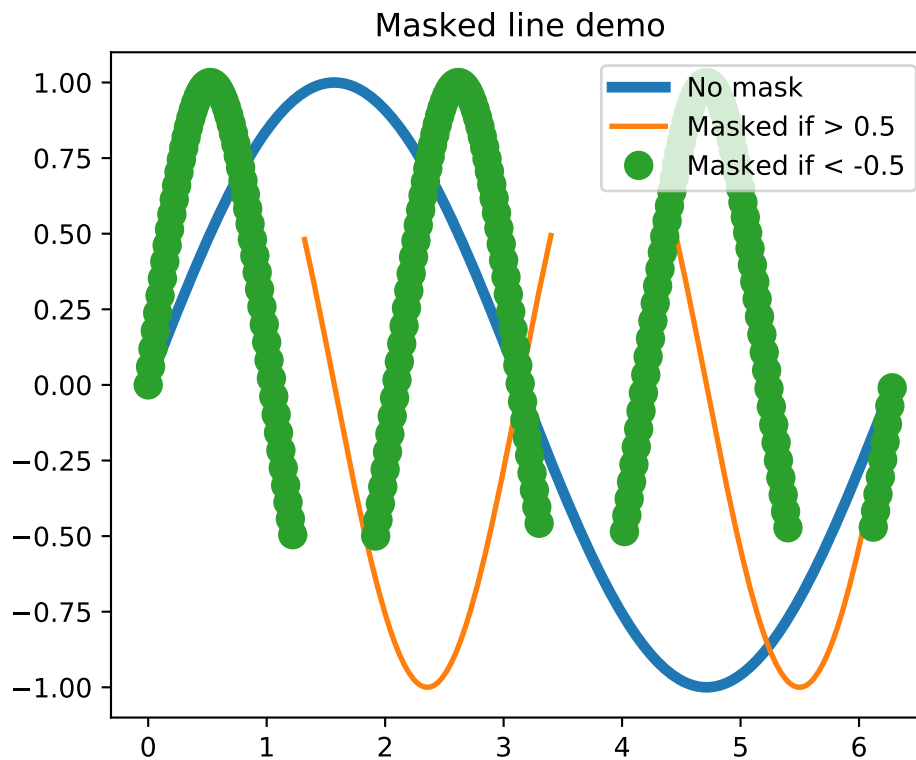

```

"""
Plot lines with points masked out.

This would typically be used with gappy data, to
break the line at the data gaps.
"""

import matplotlib.pyplot as plt
import numpy as np

x = np.arange(0, 2*np.pi, 0.02)
y = np.sin(x)
y1 = np.sin(2*x)
y2 = np.sin(3*x)
ym1 = np.ma.masked_where(y1 > 0.5, y1)
ym2 = np.ma.masked_where(y2 < -0.5, y2)

lines = plt.plot(x, y, x, ym1, x, ym2, 'o')
plt.setp(lines[0], linewidth=4)
plt.setp(lines[1], linewidth=2)
plt.setp(lines[2], markersize=10)

```



```
plt.legend(('No mask', 'Masked if > 0.5', 'Masked if < -0.5'),
          loc='upper right')
plt.title('Masked line demo')
plt.show()
```

Keywords: python, matplotlib, pylab, example, codex (see [Search examples](#))

99.128 pylab_examples example code: mathtext_demo.py

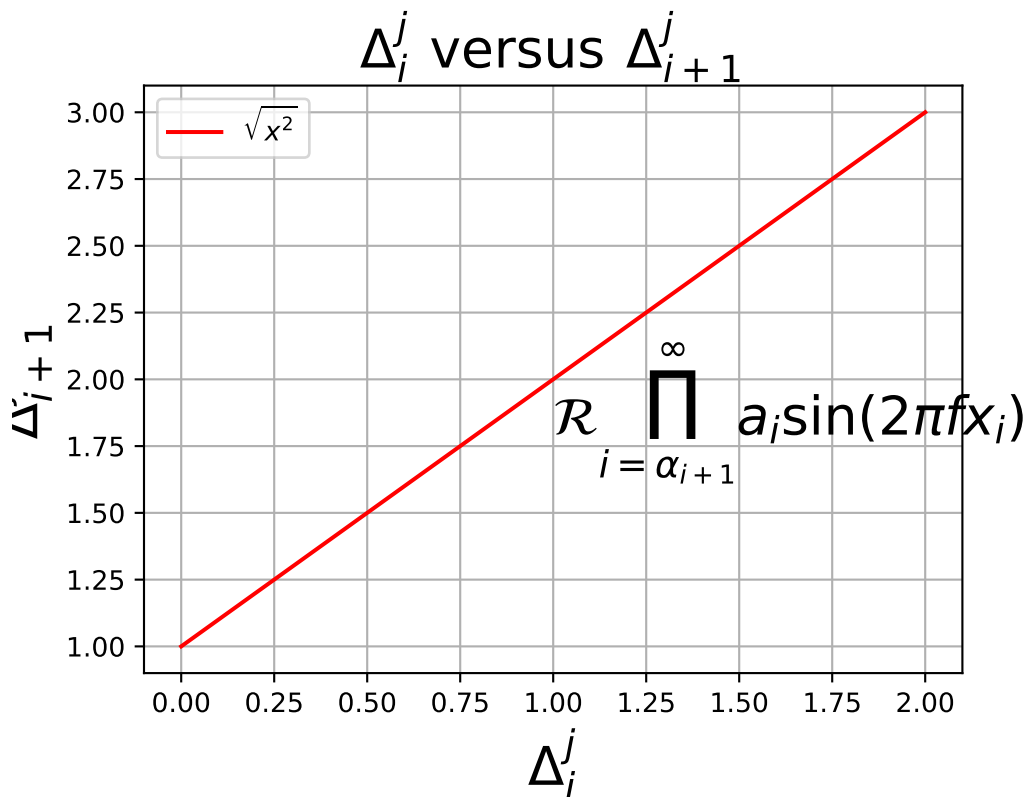

```
"""
Use matplotlib's internal LaTeX parser and layout engine. For true
latex rendering, see the text.usetex option
"""
import numpy as np
from matplotlib.pyplot import figure, show

fig = figure()
fig.subplots_adjust(bottom=0.2)

ax = fig.add_subplot(111)
ax.plot([1, 2, 3], 'r')
x = np.arange(0.0, 3.0, 0.1)
```

```
ax.grid(True)
ax.set_xlabel(r'$\Delta_i^j$', fontsize=20)
ax.set_ylabel(r'$\Delta_{i+1}^j$', fontsize=20)
tex = r'$\mathcal{R}\prod_{i=\alpha_{i+1}}^{\infty} a_i \sin(2 \pi f x_i)$'

ax.text(1, 1.6, tex, fontsize=20, va='bottom')

ax.legend([r'$\sqrt{x^2}$'])

ax.set_title(r'$\Delta_i^j \ \text{\hspace{0.4} \mathrm{versus} \hspace{0.4} } \Delta_{i+1}^j$',
↪ fontsize=20)

show()
```

Keywords: python, matplotlib, pylab, example, codex (see [Search examples](#))

99.129 pylab_examples example code: mathtext_examples.py

Matplotlib's math rendering engine

$$W_{\delta_1 \rho_1 \sigma_2}^{3\beta} = U_{\delta_1 \rho_1}^{3\beta} + \frac{1}{8\pi^2} \int_{\alpha_2}^{\alpha_2'} d\alpha_2' \left[\frac{U_{\delta_1 \rho_1}^{2\beta} - \alpha_2' U_{\rho_1 \sigma_2}^{1\beta}}{U_{\rho_1 \sigma_2}^{0\beta}} \right]$$

Subscripts and superscripts:

$$\alpha_i > \beta_i, \alpha_{i+1}^j = \sin(2\pi f_j t_i) e^{-5t_i/\tau}, \dots$$

Fractions, binomials and stacked numbers:

$$\frac{3}{4}, \binom{3}{4}, \frac{3}{4}, \left(\frac{5 - \frac{1}{x}}{4}\right), \dots$$

Radicals:

$$\sqrt{2}, \sqrt[3]{x}, \dots$$

Fonts:

Roman , *Italic* , Typewriter or *CALLIGRAPHY*

Accents:

á, ā, ă, à, ä, ù, â, ã, ẽ, \widehat{xyz} , \widetilde{xyz} , ...

Greek, Hebrew:

$\alpha, \beta, \chi, \delta, \lambda, \mu, \Delta, \Gamma, \Omega, \Phi, \Pi, \Upsilon, \nabla, \aleph, \beth, \daleth, \gimel,$

Delimiters, functions and Symbols:

$\sqcup, \int, \oint, \prod, \sum, \log, \sin, \approx, \oplus, \star, \alpha, \infty, \partial, \Re,$

```

"""
Selected features of Matplotlib's math rendering engine.
"""
from __future__ import print_function
import matplotlib.pyplot as plt
import os
import sys

```

```

import re
import gc

# Selection of features following "Writing mathematical expressions" tutorial
mathtext_titles = {
    0: "Header demo",
    1: "Subscripts and superscripts",
    2: "Fractions, binomials and stacked numbers",
    3: "Radicals",
    4: "Fonts",
    5: "Accents",
    6: "Greek, Hebrew",
    7: "Delimiters, functions and Symbols"}
n_lines = len(mathtext_titles)

# Randomly picked examples
mathext_demos = {
    0: r"$W^{\{3\beta\}_{\{\delta_1 \rho_1 \sigma_2\}} = "
      r"U^{\{3\beta\}_{\{\delta_1 \rho_1\}} + \frac{1}{8} \pi^2 "
      r"\int^{\{\alpha_2\}_{\{\alpha_2\}} d \alpha^{\prime_2} \left[\frac{ "
      r"U^{\{2\beta\}_{\{\delta_1 \rho_1\}} - \alpha^{\prime_2} U^{\{1\beta\}_{ "
      r"\{\rho_1 \sigma_2\}} \{U^{\{0\beta\}_{\{\rho_1 \sigma_2\}}}\right]$",

    1: r"$\alpha_i > \beta_i, \ "
      r"\alpha_{i+1}^j = \{\rm sin\}(2\pi f_j t_i) e^{\{-5 t_i/\tau\}}, \ "
      r"\ldots$",

    2: r"$\frac{3}{4}, \ \binom{3}{4}, \ \stackrel{3}{4}, \ "
      r"\left(\frac{5 - \frac{1}{x}}{4}\right), \ \ldots$",

    3: r"$\sqrt{2}, \ \sqrt[3]{x}, \ \ldots$",

    4: r"$\mathrm{Roman} \ , \ \mathit{Italic} \ , \ \mathtt{Typewriter} \ \ "
      r"\mathrm{or} \ \mathcal{CALLIGRAPHY}$",

    5: r"$\acute{a}, \ \bar{a}, \ \breve{a}, \ \dot{a}, \ \ddot{a}, \ \grave{a}, \ \ "
      r"\hat{a}, \ \tilde{a}, \ \vec{a}, \ \widehat{xyz}, \ \widetilde{xyz}, \ \ "
      r"\ldots$",

    6: r"$\alpha, \ \beta, \ \chi, \ \delta, \ \lambda, \ \mu, \ \ "
      r"\Delta, \ \Gamma, \ \Omega, \ \Phi, \ \Pi, \ \Upsilon, \ \nabla, \ \ "
      r"\aleph, \ \beth, \ \daleth, \ \gimel, \ \ldots$",

    7: r"$\coprod, \ \int, \ \oint, \ \prod, \ \sum, \ \ "
      r"\log, \ \sin, \ \approx, \ \oplus, \ \star, \ \varpropto, \ \ "
      r"\infty, \ \partial, \ \Re, \ \leftrightsquigarrow, \ \ldots$"}

def doall():
    # Colors used in mpl online documentation.
    mpl_blue_rvb = (191./255., 209./256., 212./255.)
    mpl_orange_rvb = (202/255., 121/256., 0./255.)
    mpl_grey_rvb = (51./255., 51./255., 51./255.)

```

```

# Creating figure and axis.
plt.figure(figsize=(6, 7))
plt.axes([0.01, 0.01, 0.98, 0.90], facecolor="white", frameon=True)
plt.gca().set_xlim(0., 1.)
plt.gca().set_ylim(0., 1.)
plt.gca().set_title("Matplotlib's math rendering engine",
                    color=mpl_grey_rvb, fontsize=14, weight='bold')
plt.gca().set_xticklabels("", visible=False)
plt.gca().set_yticklabels("", visible=False)

# Gap between lines in axes coords
line_axesfrac = (1. / (n_lines))

# Plotting header demonstration formula
full_demo = mathtext_demos[0]
plt.annotate(full_demo,
             xy=(0.5, 1. - 0.59*line_axesfrac),
             xycoords='data', color=mpl_orange_rvb, ha='center',
             fontsize=20)

# Plotting features demonstration formulae
for i_line in range(1, n_lines):
    baseline = 1. - (i_line)*line_axesfrac
    baseline_next = baseline - line_axesfrac*1.
    title = mathtext_titles[i_line] + ":"
    fill_color = ['white', mpl_blue_rvb][i_line % 2]
    plt.fill_between([0., 1.], [baseline, baseline],
                    [baseline_next, baseline_next],
                    color=fill_color, alpha=0.5)
    plt.annotate(title,
                xy=(0.07, baseline - 0.3*line_axesfrac),
                xycoords='data', color=mpl_grey_rvb, weight='bold')
    demo = mathtext_demos[i_line]
    plt.annotate(demo,
                xy=(0.05, baseline - 0.75*line_axesfrac),
                xycoords='data', color=mpl_grey_rvb,
                fontsize=16)

for i in range(n_lines):
    s = mathtext_demos[i]
    print(i, s)
plt.show()

if '--latex' in sys.argv:
    # Run: python mathtext_examples.py --latex
    # Need amsmath and amssymb packages.
    fd = open("mathtext_examples.ltx", "w")
    fd.write("\\documentclass{article}\n")
    fd.write("\\usepackage{amsmath, amssymb}\n")
    fd.write("\\begin{document}\n")
    fd.write("\\begin{enumerate}\n")

```

```

for i in range(n_lines):
    s = mathext_demos[i]
    s = re.sub(r"(?!\\)\$", "$$", s)
    fd.write("\\item %s\n" % s)

fd.write("\\end{enumerate}\n")
fd.write("\\end{document}\n")
fd.close()

os.system("pdflatex mathtext_examples.ltx")
else:
    doall()

```

Keywords: python, matplotlib, pylab, example, codex (see [Search examples](#))

99.130 pylab_examples example code: matshow.py

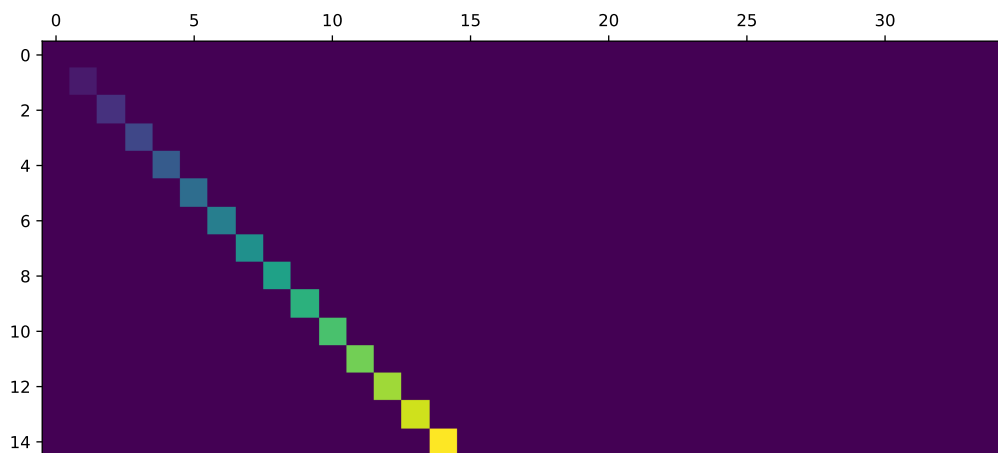

```

"""Simple matshow() example."""
import matplotlib.pyplot as plt
import numpy as np

def samplemat(dims):
    """Make a matrix with all zeros and increasing elements on the diagonal"""
    aa = np.zeros(dims)
    for i in range(min(dims)):
        aa[i, i] = i
    return aa

# Display matrix
plt.matshow(samplemat((15, 35)))

```

```
plt.show()
```

Keywords: python, matplotlib, pylab, example, codex (see [Search examples](#))

99.131 pylab_examples example code: mri_demo.py



```
"""Displays an MRI image."""  
  
import matplotlib.pyplot as plt  
import matplotlib.cbook as cbook  
import matplotlib.cm as cm  
import numpy as np  
  
fig, ax = plt.subplots(num="MRI_demo")  
  
# Data are 256x256 16 bit integers  
dfile = cbook.get_sample_data('s1045.ima.gz')  
im = np.fromstring(dfile.read(), np.uint16).astype(float)  
im.shape = (256, 256)  
dfile.close()
```

```
ax.imshow(im, cmap=cm.gray)
ax.axis('off')

plt.show()
```

Keywords: python, matplotlib, pylab, example, codex (see *Search examples*)

99.132 pylab_examples example code: mri_with_eeg.py

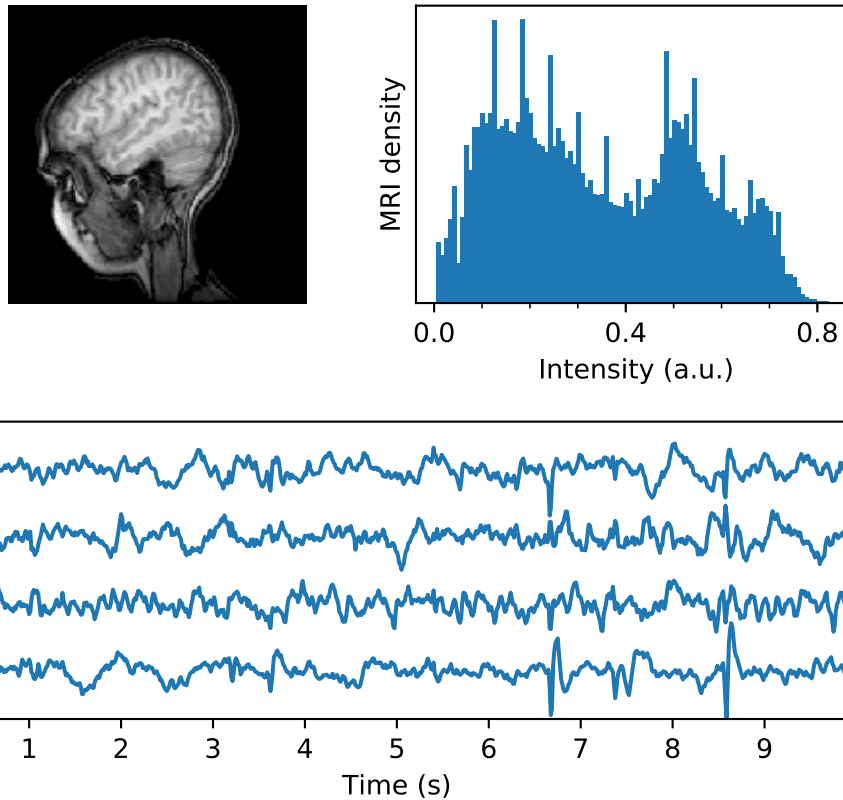

```
"""Displays a set of subplots with an MRI image, its intensity histogram and
some EEG traces.
"""
```

```
from __future__ import division, print_function

import numpy as np
import matplotlib.pyplot as plt
import matplotlib.colorbar as cbook
import matplotlib.cm as cm

from matplotlib.collections import LineCollection
from matplotlib.ticker import MultipleLocator
```



```

fig = plt.figure("MRI_with_EEG")

# Load the MRI data (256x256 16 bit integers)
dfile = cbook.get_sample_data('s1045.ima.gz')
im = np.fromstring(dfile.read(), np.uint16).astype(float)
im.shape = (256, 256)
dfile.close()

# Plot the MRI image
ax0 = fig.add_subplot(2, 2, 1)
ax0.imshow(im, cmap=cm.gray)
ax0.axis('off')

# Plot the histogram of MRI intensity
ax1 = fig.add_subplot(2, 2, 2)
im = np.ravel(im)
im = im[np.nonzero(im)] # Ignore the background
im = im / (2**16 - 1) # Normalize
ax1.hist(im, bins=100)
ax1.xaxis.set_major_locator(MultipleLocator(0.4))
ax1.minorticks_on()
ax1.set_yticks([])
ax1.set_xlabel('Intensity (a.u.)')
ax1.set_ylabel('MRI density')

# Load the EEG data
numSamples, numRows = 800, 4
eegfile = cbook.get_sample_data('eeg.dat', asfileobj=False)
print('Loading EEG %s' % eegfile)
data = np.fromfile(eegfile, dtype=float)
data.shape = (numSamples, numRows)
t = 10.0 * np.arange(numSamples) / numSamples

# Plot the EEG
ticklocs = []
ax2 = fig.add_subplot(2, 1, 2)
ax2.set_xlim(0, 10)
ax2.set_xticks(np.arange(10))
dmin = data.min()
dmax = data.max()
dr = (dmax - dmin) * 0.7 # Crowd them a bit.
y0 = dmin
y1 = (numRows - 1) * dr + dmax
ax2.set_ylim(y0, y1)

segs = []
for i in range(numRows):
    segs.append(np.hstack((t[:, np.newaxis], data[:, i, np.newaxis])))
    ticklocs.append(i * dr)

offsets = np.zeros((numRows, 2), dtype=float)
offsets[:, 1] = ticklocs

```

```

lines = LineCollection(segs, offsets=offsets, transOffset=None)
ax2.add_collection(lines)

# Set the yticks to use axes coordinates on the y axis
ax2.set_yticks(ticklocs)
ax2.set_yticklabels(['PG3', 'PG5', 'PG7', 'PG9'])

ax2.set_xlabel('Time (s)')

plt.tight_layout()
plt.show()

```

Keywords: python, matplotlib, pylab, example, codex (see *Search examples*)

99.133 pylab_examples example code: multi_image.py

Multiple images

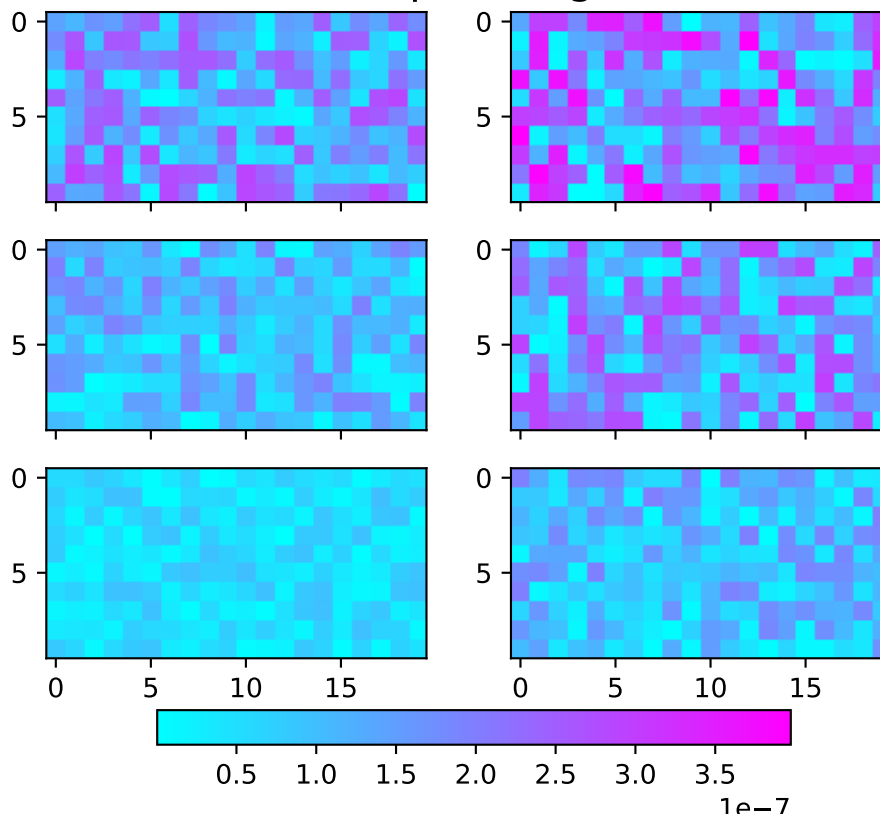

```

'''
Make a set of images with a single colormap, norm, and colorbar.

It also illustrates colorbar tick labelling with a multiplier.
'''

```

```

"""
from matplotlib.pyplot import figure, show, axes, sci
from matplotlib import cm, colors
from matplotlib.font_manager import FontProperties
from numpy import amin, amax, ravel
from numpy.random import rand

Nr = 3
Nc = 2

fig = figure()
cmap = cm.cool

figtitle = 'Multiple images'
t = fig.text(0.5, 0.95, figtitle,
            horizontalalignment='center',
            fontproperties=FontProperties(size=16))

cax = fig.add_axes([0.2, 0.08, 0.6, 0.04])

w = 0.4
h = 0.22
ax = []
images = []
vmin = 1e40
vmax = -1e40
for i in range(Nr):
    for j in range(Nc):
        pos = [0.075 + j*1.1*w, 0.18 + i*1.2*h, w, h]
        a = fig.add_axes(pos)
        if i > 0:
            a.set_xticklabels([])
            # Make some fake data with a range that varies
            # somewhat from one plot to the next.
            data = ((1 + i + j)/10.0)*rand(10, 20)*1e-6
            dd = ravel(data)
            # Manually find the min and max of all colors for
            # use in setting the color scale.
            vmin = min(vmin, amin(dd))
            vmax = max(vmax, amax(dd))
            images.append(a.imshow(data, cmap=cmap))

        ax.append(a)

# Set the first image as the master, with all the others
# observing it for changes in cmap or norm.

class ImageFollower(object):
    'update image in response to changes in clim or cmap on another image'

    def __init__(self, follower):

```

```
self.follower = follower

def __call__(self, leader):
    self.follower.set_cmap(leader.get_cmap())
    self.follower.set_clim(leader.get_clim())

norm = colors.Normalize(vmin=vmin, vmax=vmax)
for i, im in enumerate(images):
    im.set_norm(norm)
    if i > 0:
        images[0].callbacksSM.connect('changed', ImageFollower(im))

# The colorbar is also based on this master image.
fig.colorbar(images[0], cax, orientation='horizontal')

# We need the following only if we want to run this interactively and
# modify the colormap:

axes(ax[0]) # Return the current axes to the first one,
sci(images[0]) # because the current image must be in current axes.

show()
```

Keywords: python, matplotlib, pylab, example, codex (see *Search examples*)

99.134 pylab_examples example code: multicolored_line.py

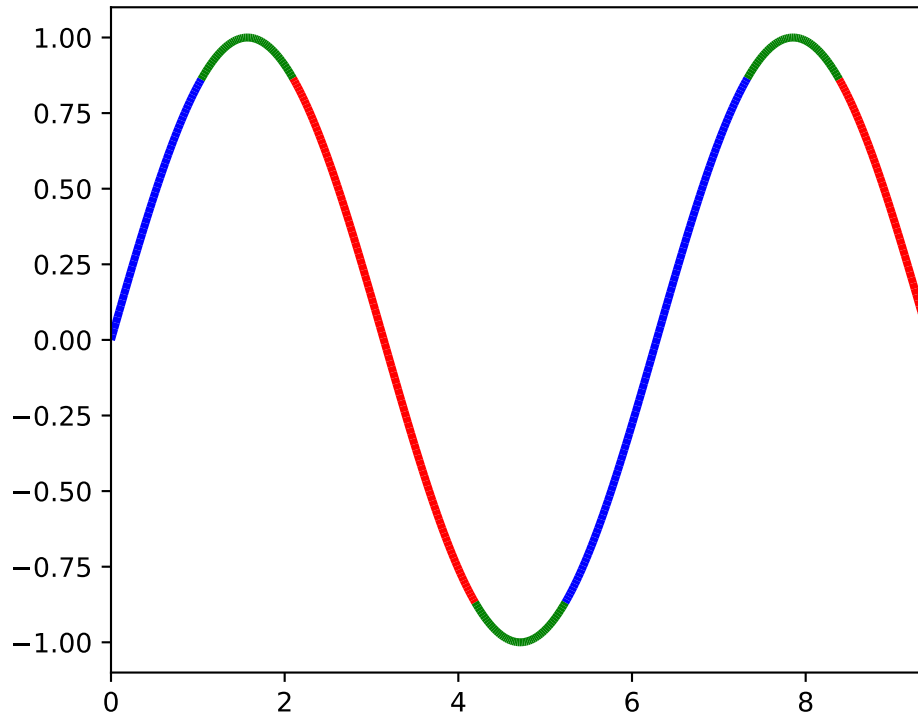

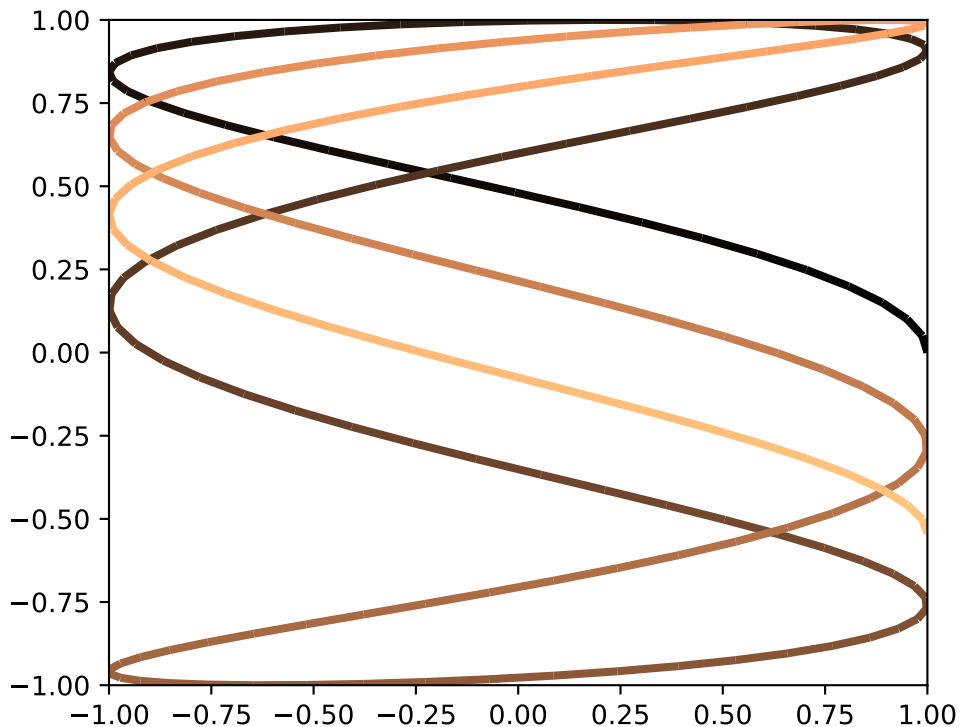

```

"""
Color parts of a line based on its properties, e.g., slope.
"""

import numpy as np
import matplotlib.pyplot as plt
from matplotlib.collections import LineCollection
from matplotlib.colors import ListedColormap, BoundaryNorm

x = np.linspace(0, 3 * np.pi, 500)
y = np.sin(x)
z = np.cos(0.5 * (x[:-1] + x[1:])) # first derivative

# Create a colormap for red, green and blue and a norm to color
# f' < -0.5 red, f' > 0.5 blue, and the rest green
cmap = ListedColormap(['r', 'g', 'b'])
norm = BoundaryNorm([-1, -0.5, 0.5, 1], cmap.N)

# Create a set of line segments so that we can color them individually
# This creates the points as a N x 1 x 2 array so that we can stack points
# together easily to get the segments. The segments array for line collection
# needs to be numlines x points per line x 2 (x and y)
points = np.array([x, y]).T.reshape(-1, 1, 2)
segments = np.concatenate([points[:-1], points[1:]], axis=1)

# Create the line collection object, setting the colormapping parameters.

```

```
# Have to set the actual values used for colormapping separately.
lc = LineCollection(segments, cmap=cmap, norm=norm)
lc.set_array(z)
lc.set_linewidth(3)

fig1 = plt.figure()
plt.gca().add_collection(lc)
plt.xlim(x.min(), x.max())
plt.ylim(-1.1, 1.1)

# Now do a second plot coloring the curve using a continuous colormap
t = np.linspace(0, 10, 200)
x = np.cos(np.pi * t)
y = np.sin(t)
points = np.array([x, y]).T.reshape(-1, 1, 2)
segments = np.concatenate([points[:-1], points[1:]], axis=1)

lc = LineCollection(segments, cmap=plt.get_cmap('copper'),
                   norm=plt.Normalize(0, 10))
lc.set_array(t)
lc.set_linewidth(3)

fig2 = plt.figure()
plt.gca().add_collection(lc)
plt.xlim(-1, 1)
plt.ylim(-1, 1)
plt.show()
```

Keywords: python, matplotlib, pylab, example, codex (see [Search examples](#))

99.135 pylab_examples example code: multiline.py

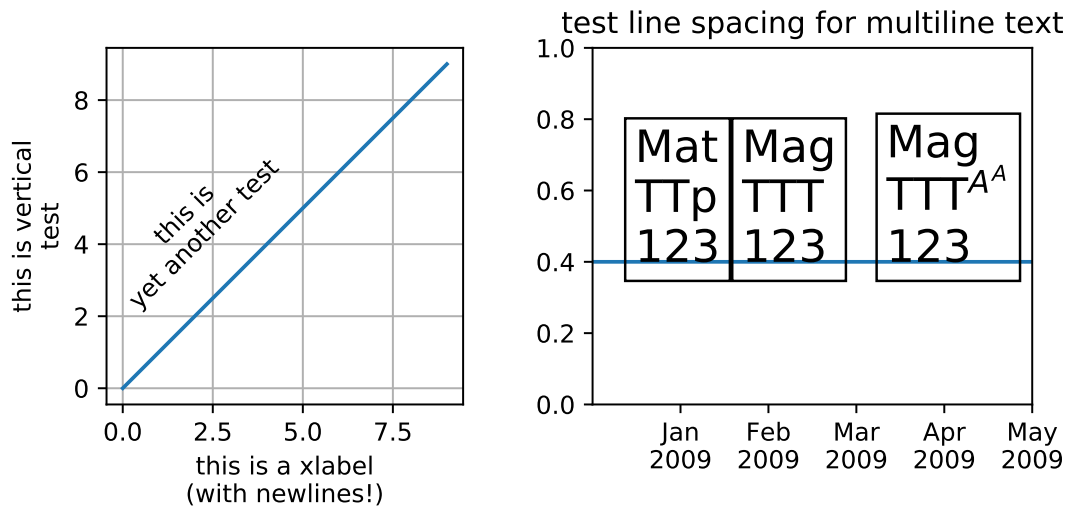

```
import matplotlib.pyplot as plt
import numpy as np

plt.figure(figsize=(7, 4))
ax = plt.subplot(121)
ax.set_aspect(1)
plt.plot(np.arange(10))
plt.xlabel('this is a xlabel\n(with newlines!)')
plt.ylabel('this is vertical\ntest', multialignment='center')
plt.text(2, 7, 'this is\nyet another test',
         rotation=45,
         horizontalalignment='center',
         verticalalignment='top',
         multialignment='center')

plt.grid(True)

plt.subplot(122)

plt.text(0.29, 0.4, "Mat\nTTp\n123", size=18,
         va="baseline", ha="right", multialignment="left",
         bbox=dict(fc="none"))

plt.text(0.34, 0.4, "Mag\nTTT\n123", size=18,
         va="baseline", ha="left", multialignment="left",
         bbox=dict(fc="none"))
```



```
plt.text(0.95, 0.4, "Mag\nTTT${A^A}$\n123", size=18,
        va="baseline", ha="right", multialignment="left",
        bbox=dict(fc="none"))

plt.xticks([0.2, 0.4, 0.6, 0.8, 1.],
           ["Jan\n2009", "Feb\n2009", "Mar\n2009", "Apr\n2009", "May\n2009"])

plt.axhline(0.4)
plt.title("test line spacing for multiline text")

plt.subplots_adjust(bottom=0.25, top=0.75)
plt.draw()
plt.show()
```

Keywords: python, matplotlib, pylab, example, codex (see *Search examples*)

99.136 pylab_examples example code: multipage_pdf.py

```
"""
This is a demo of creating a pdf file with several pages,
as well as adding metadata and annotations to pdf files.
"""

import datetime
import numpy as np
from matplotlib.backends.backend_pdf import PdfPages
import matplotlib.pyplot as plt

# Create the PdfPages object to which we will save the pages:
# The with statement makes sure that the PdfPages object is closed properly at
# the end of the block, even if an Exception occurs.
with PdfPages('multipage_pdf.pdf') as pdf:
    plt.figure(figsize=(3, 3))
    plt.plot(range(7), [3, 1, 4, 1, 5, 9, 2], 'r-o')
    plt.title('Page One')
    pdf.savefig() # saves the current figure into a pdf page
    plt.close()

    plt.rc('text', usetex=True)
    plt.figure(figsize=(8, 6))
    x = np.arange(0, 5, 0.1)
    plt.plot(x, np.sin(x), 'b-')
    plt.title('Page Two')
    pdf.attach_note("plot of sin(x)") # you can add a pdf note to
    # attach metadata to a page

    pdf.savefig()
    plt.close()

    plt.rc('text', usetex=False)
    fig = plt.figure(figsize=(4, 5))
    plt.plot(x, x*x, 'ko')
```

```
plt.title('Page Three')
pdf.savefig(fig) # or you can pass a Figure object to pdf.savefig
plt.close()

# We can also set the file's metadata via the PdfPages object:
d = pdf.infodict()
d['Title'] = 'Multipage PDF Example'
d['Author'] = u'Jouni K. Sepp\xe4nen'
d['Subject'] = 'How to create a multipage pdf file and set its metadata'
d['Keywords'] = 'PdfPages multipage keywords author title subject'
d['CreationDate'] = datetime.datetime(2009, 11, 13)
d['ModDate'] = datetime.datetime.today()
```

Keywords: python, matplotlib, pylab, example, codex (see [Search examples](#))

99.137 pylab_examples example code: multiple_figs_demo.py

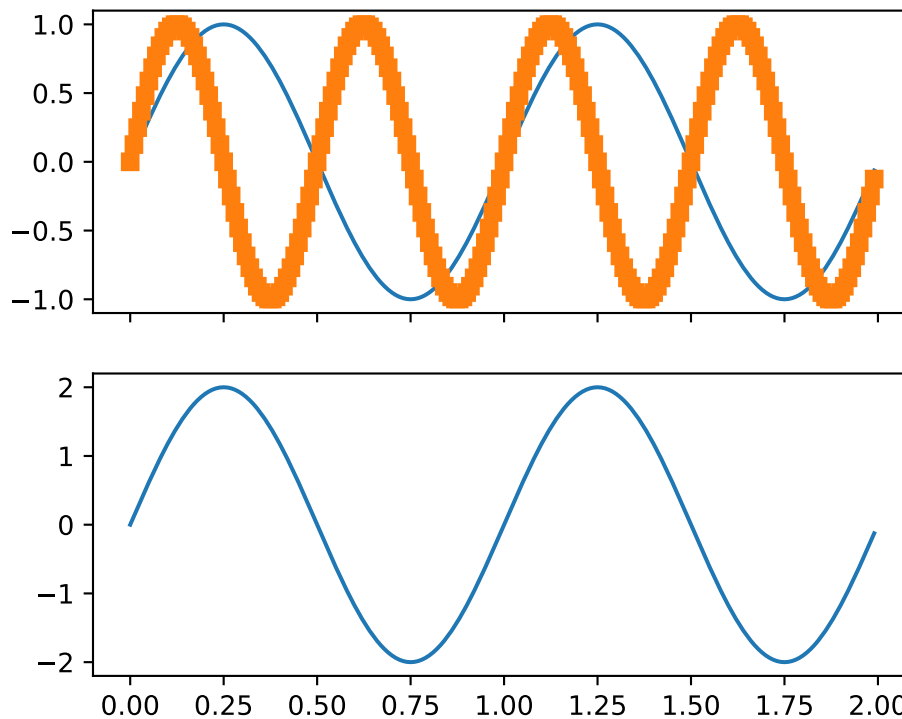

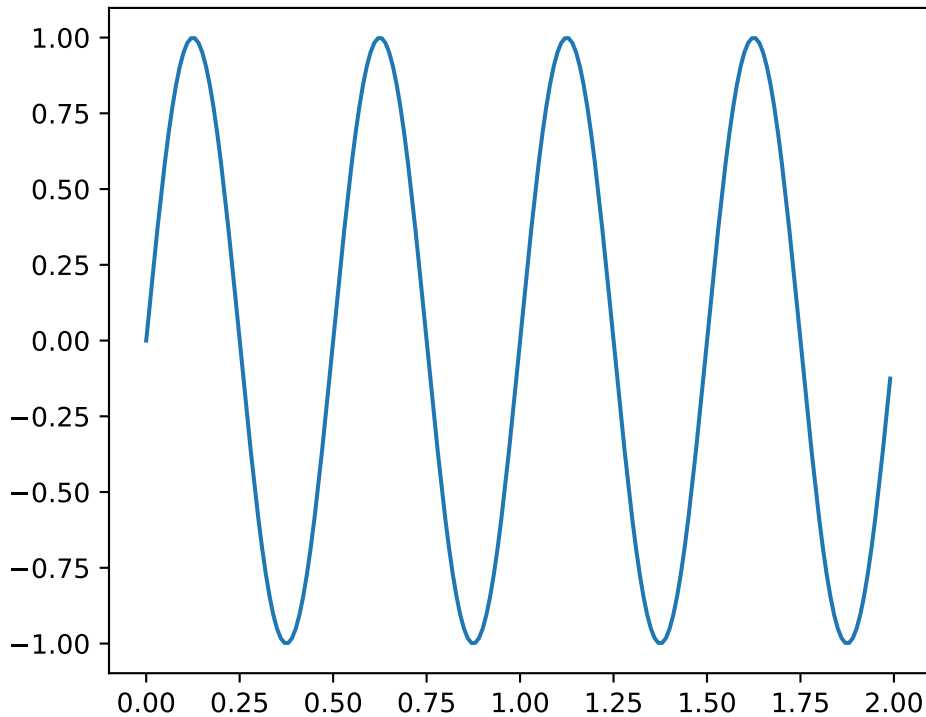

```
# Working with multiple figure windows and subplots
import matplotlib.pyplot as plt
import numpy as np

t = np.arange(0.0, 2.0, 0.01)
s1 = np.sin(2*np.pi*t)
s2 = np.sin(4*np.pi*t)

plt.figure(1)
plt.subplot(211)
plt.plot(t, s1)
plt.subplot(212)
plt.plot(t, 2*s1)

plt.figure(2)
plt.plot(t, s2)

# now switch back to figure 1 and make some changes
plt.figure(1)
plt.subplot(211)
plt.plot(t, s2, 's')
ax = plt.gca()
ax.set_xticklabels([])

plt.show()
```

Keywords: python, matplotlib, pylab, example, codex (see *Search examples*)

99.138 pylab_examples example code: multiple_yaxis_with_spines.py

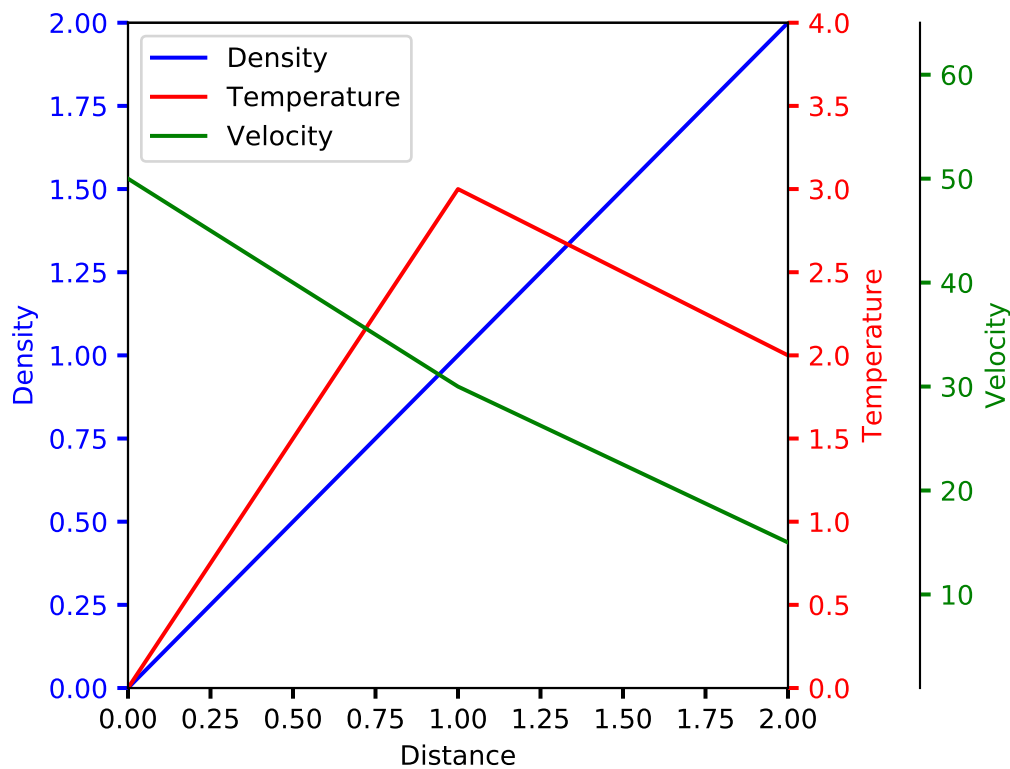

```
import matplotlib.pyplot as plt

def make_patch_spines_invisible(ax):
    ax.set_frame_on(True)
    ax.patch.set_visible(False)
    for sp in ax.spines.values():
        sp.set_visible(False)

fig, host = plt.subplots()
fig.subplots_adjust(right=0.75)

par1 = host.twinx()
par2 = host.twinx()

# Offset the right spine of par2. The ticks and label have already been
# placed on the right by twinx above.
par2.spines["right"].set_position(("axes", 1.2))
# Having been created by twinx, par2 has its frame off, so the line of its
```

```
# detached spine is invisible. First, activate the frame but make the patch
# and spines invisible.
make_patch_spines_invisible(par2)
# Second, show the right spine.
par2.spines["right"].set_visible(True)

p1, = host.plot([0, 1, 2], [0, 1, 2], "b-", label="Density")
p2, = par1.plot([0, 1, 2], [0, 3, 2], "r-", label="Temperature")
p3, = par2.plot([0, 1, 2], [50, 30, 15], "g-", label="Velocity")

host.set_xlim(0, 2)
host.set_ylim(0, 2)
par1.set_ylim(0, 4)
par2.set_ylim(1, 65)

host.set_xlabel("Distance")
host.set_ylabel("Density")
par1.set_ylabel("Temperature")
par2.set_ylabel("Velocity")

host.yaxis.label.set_color(p1.get_color())
par1.yaxis.label.set_color(p2.get_color())
par2.yaxis.label.set_color(p3.get_color())

tkw = dict(size=4, width=1.5)
host.tick_params(axis='y', colors=p1.get_color(), **tkw)
par1.tick_params(axis='y', colors=p2.get_color(), **tkw)
par2.tick_params(axis='y', colors=p3.get_color(), **tkw)
host.tick_params(axis='x', **tkw)

lines = [p1, p2, p3]

host.legend(lines, [l.get_label() for l in lines])

plt.show()
```

Keywords: python, matplotlib, pylab, example, codex (see [Search examples](#))

99.139 pylab_examples example code: nan_test.py

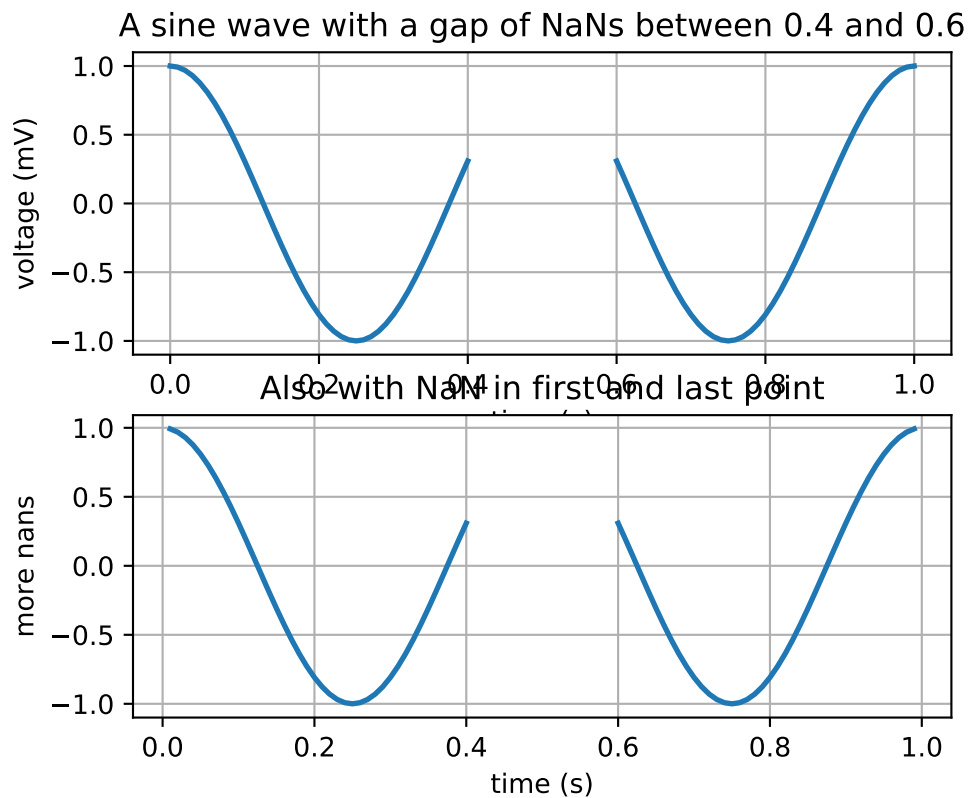

```

"""
Example: simple line plots with NaNs inserted.
"""
import numpy as np
import matplotlib.pyplot as plt

t = np.arange(0.0, 1.0 + 0.01, 0.01)
s = np.cos(2 * 2 * np.pi * t)
t[41:60] = np.nan

plt.subplot(2, 1, 1)
plt.plot(t, s, '-', lw=2)

plt.xlabel('time (s)')
plt.ylabel('voltage (mV)')
plt.title('A sine wave with a gap of NaNs between 0.4 and 0.6')
plt.grid(True)

plt.subplot(2, 1, 2)
t[0] = np.nan
t[-1] = np.nan
plt.plot(t, s, '-', lw=2)

```

```
plt.title('Also with NaN in first and last point')

plt.xlabel('time (s)')
plt.ylabel('more nans')
plt.grid(True)

plt.show()
```

Keywords: python, matplotlib, pylab, example, codex (see [Search examples](#))

99.140 pylab_examples example code: newscalarformatter_demo.py

The old formatter

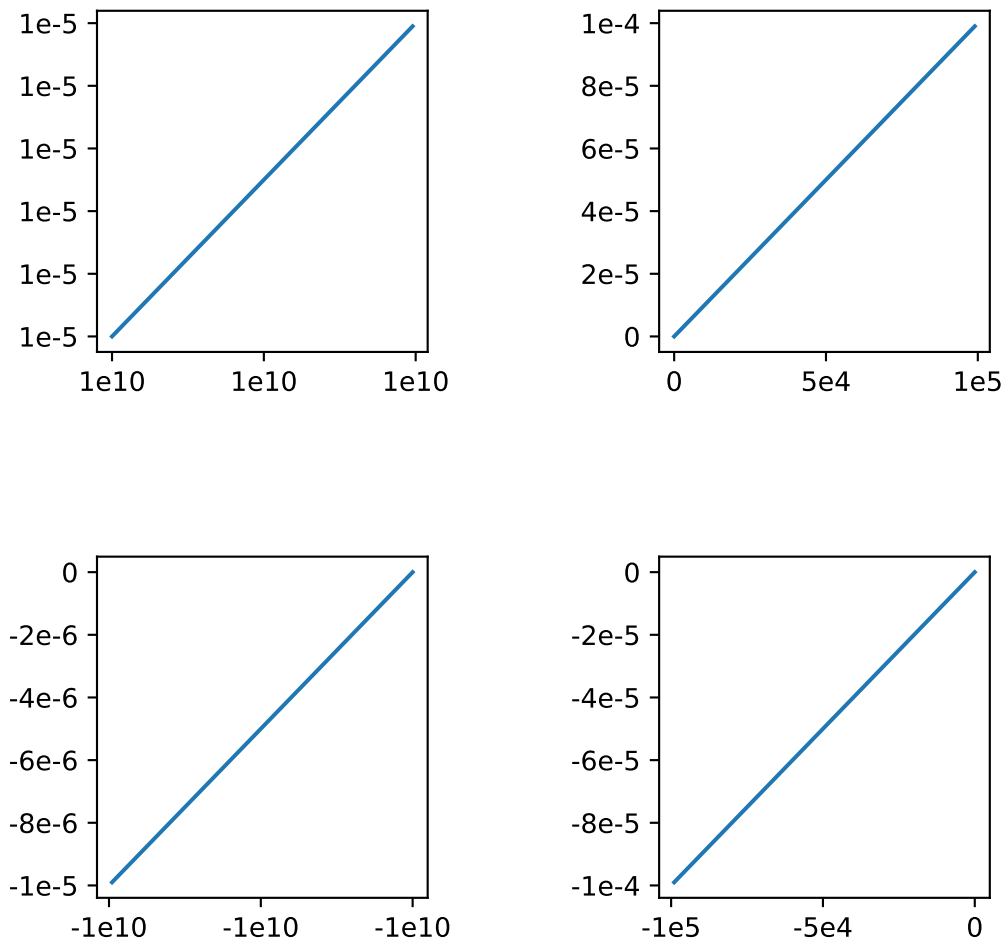

The new formatter, default settings

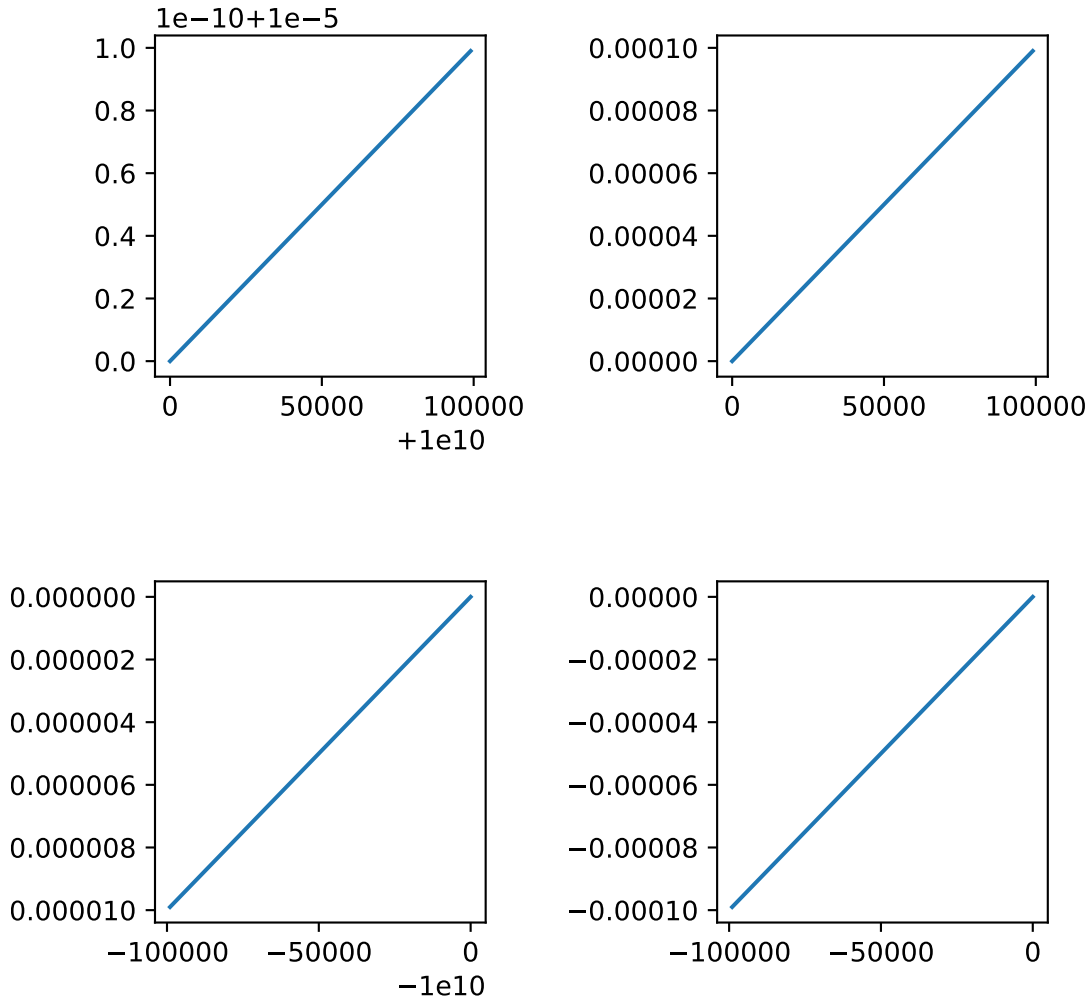

The new formatter, no numerical offset

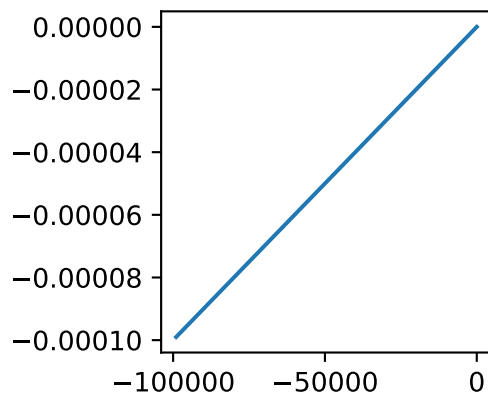
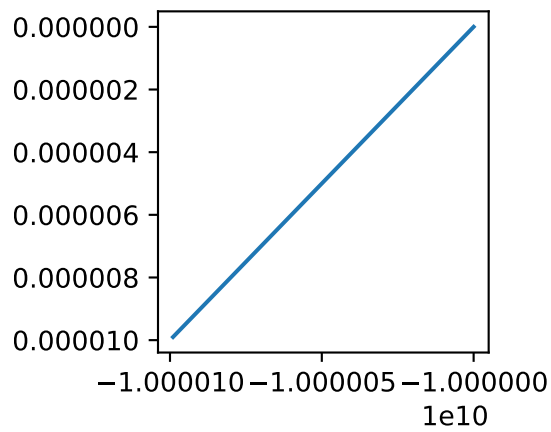
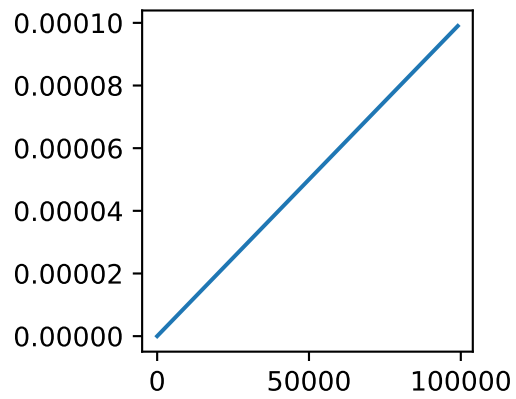
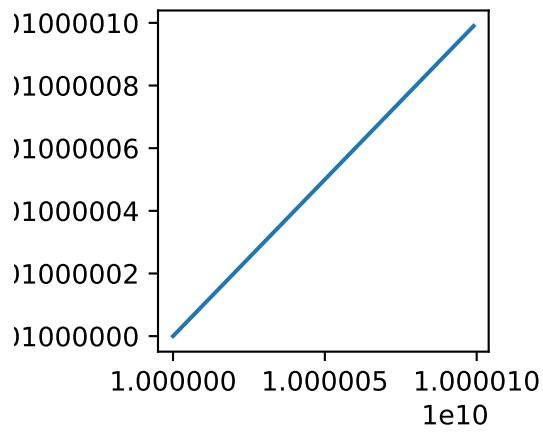

The new formatter, with mathtext

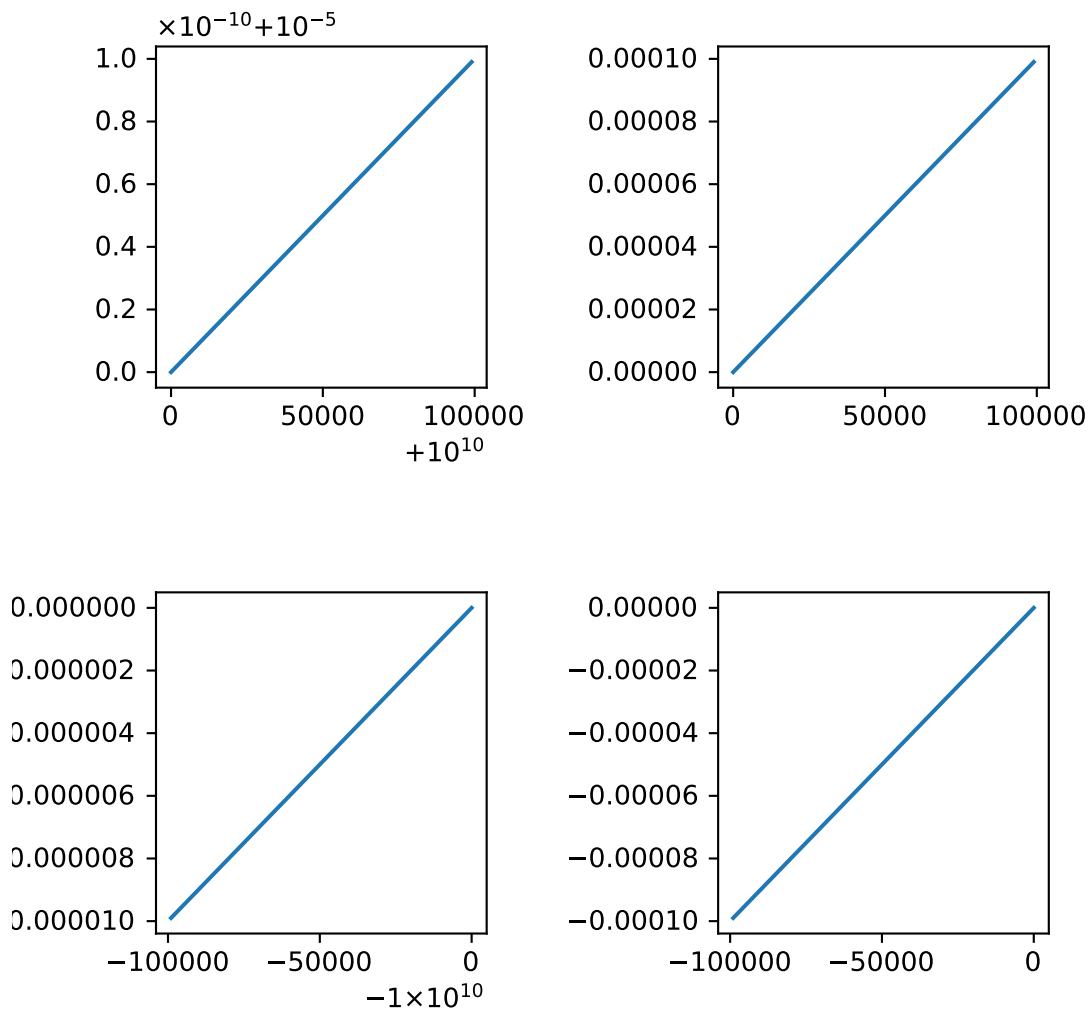

```
import matplotlib.pyplot as plt
import numpy as np
from matplotlib.ticker import OldScalarFormatter, ScalarFormatter

# Example 1
x = np.arange(0, 1, .01)
fig, [[ax1, ax2], [ax3, ax4]] = plt.subplots(2, 2, figsize=(6, 6))
fig.text(0.5, 0.975, 'The old formatter',
        horizontalalignment='center', verticalalignment='top')
ax1.plot(x * 1e5 + 1e10, x * 1e-10 + 1e-5)
ax1.xaxis.set_major_formatter(OldScalarFormatter())
ax1.yaxis.set_major_formatter(OldScalarFormatter())

ax2.plot(x * 1e5, x * 1e-4)
ax2.xaxis.set_major_formatter(OldScalarFormatter())
ax2.yaxis.set_major_formatter(OldScalarFormatter())
```

```

ax3.plot(-x * 1e5 - 1e10, -x * 1e-5 - 1e-10)
ax3.xaxis.set_major_formatter(OldScalarFormatter())
ax3.yaxis.set_major_formatter(OldScalarFormatter())

ax4.plot(-x * 1e5, -x * 1e-4)
ax4.xaxis.set_major_formatter(OldScalarFormatter())
ax4.yaxis.set_major_formatter(OldScalarFormatter())

fig.subplots_adjust(wspace=0.7, hspace=0.6)

# Example 2
x = np.arange(0, 1, .01)
fig, [[ax1, ax2], [ax3, ax4]] = plt.subplots(2, 2, figsize=(6, 6))
fig.text(0.5, 0.975, 'The new formatter, default settings',
         horizontalalignment='center',
         verticalalignment='top')

ax1.plot(x * 1e5 + 1e10, x * 1e-10 + 1e-5)
ax1.xaxis.set_major_formatter(ScalarFormatter())
ax1.yaxis.set_major_formatter(ScalarFormatter())

ax2.plot(x * 1e5, x * 1e-4)
ax2.xaxis.set_major_formatter(ScalarFormatter())
ax2.yaxis.set_major_formatter(ScalarFormatter())

ax3.plot(-x * 1e5 - 1e10, -x * 1e-5 - 1e-10)
ax3.xaxis.set_major_formatter(ScalarFormatter())
ax3.yaxis.set_major_formatter(ScalarFormatter())

ax4.plot(-x * 1e5, -x * 1e-4)
ax4.xaxis.set_major_formatter(ScalarFormatter())
ax4.yaxis.set_major_formatter(ScalarFormatter())

fig.subplots_adjust(wspace=0.7, hspace=0.6)

# Example 3
x = np.arange(0, 1, .01)
fig, [[ax1, ax2], [ax3, ax4]] = plt.subplots(2, 2, figsize=(6, 6))
fig.text(0.5, 0.975, 'The new formatter, no numerical offset',
         horizontalalignment='center',
         verticalalignment='top')

ax1.plot(x * 1e5 + 1e10, x * 1e-10 + 1e-5)
ax1.xaxis.set_major_formatter(ScalarFormatter(useOffset=False))
ax1.yaxis.set_major_formatter(ScalarFormatter(useOffset=False))

ax2.plot(x * 1e5, x * 1e-4)
ax2.xaxis.set_major_formatter(ScalarFormatter(useOffset=False))
ax2.yaxis.set_major_formatter(ScalarFormatter(useOffset=False))

ax3.plot(-x * 1e5 - 1e10, -x * 1e-5 - 1e-10)
ax3.xaxis.set_major_formatter(ScalarFormatter(useOffset=False))

```

```
ax3.yaxis.set_major_formatter(ScalarFormatter(useOffset=False))

ax4.plot(-x * 1e5, -x * 1e-4)
ax4.xaxis.set_major_formatter(ScalarFormatter(useOffset=False))
ax4.yaxis.set_major_formatter(ScalarFormatter(useOffset=False))

fig.subplots_adjust(wspace=0.7, hspace=0.6)

# Example 4
x = np.arange(0, 1, .01)
fig, [[ax1, ax2], [ax3, ax4]] = plt.subplots(2, 2, figsize=(6, 6))
fig.text(0.5, 0.975, 'The new formatter, with mathtext',
         horizontalalignment='center',
         verticalalignment='top')

ax1.plot(x * 1e5 + 1e10, x * 1e-10 + 1e-5)
ax1.xaxis.set_major_formatter(ScalarFormatter(useMathText=True))
ax1.yaxis.set_major_formatter(ScalarFormatter(useMathText=True))

ax2.plot(x * 1e5, x * 1e-4)
ax2.xaxis.set_major_formatter(ScalarFormatter(useMathText=True))
ax2.yaxis.set_major_formatter(ScalarFormatter(useMathText=True))

ax3.plot(-x * 1e5 - 1e10, -x * 1e-5 - 1e-10)
ax3.xaxis.set_major_formatter(ScalarFormatter(useMathText=True))
ax3.yaxis.set_major_formatter(ScalarFormatter(useMathText=True))

ax4.plot(-x * 1e5, -x * 1e-4)
ax4.xaxis.set_major_formatter(ScalarFormatter(useMathText=True))
ax4.yaxis.set_major_formatter(ScalarFormatter(useMathText=True))

fig.subplots_adjust(wspace=0.7, hspace=0.6)

plt.show()
```

Keywords: python, matplotlib, pylab, example, codex (see [Search examples](#))

99.141 pylab_examples example code: patheffect_demo.py

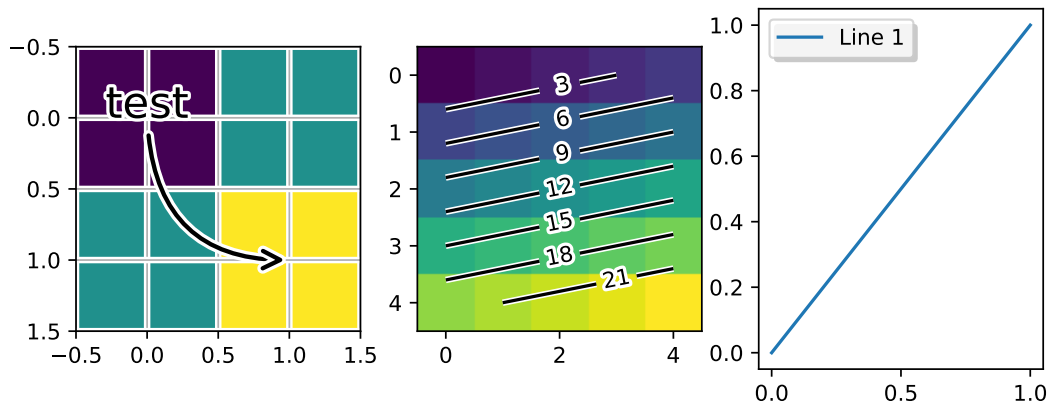

```

import matplotlib.pyplot as plt
import matplotlib.patheffects as PathEffects
import numpy as np

if 1:
    plt.figure(1, figsize=(8, 3))
    ax1 = plt.subplot(131)
    ax1.imshow([[1, 2], [2, 3]])
    txt = ax1.annotate("test", (1., 1.), (0., 0),
                      arrowprops=dict(arrowstyle="->",
                                      connectionstyle="angle3", lw=2),
                      size=20, ha="center", path_effects=[PathEffects.
->withStroke(linewidth=3,
->foreground="w")])
    txt.arrow_patch.set_path_effects([
        PathEffects.Stroke(linewidth=5, foreground="w"),
        PathEffects.Normal()])

    ax1.grid(True, linestyle="-")

    pe = [PathEffects.withStroke(linewidth=3,
                                foreground="w")]
    for l in ax1.get_xgridlines() + ax1.get_ygridlines():
        l.set_path_effects(pe)

    ax2 = plt.subplot(132)
    arr = np.arange(25).reshape((5, 5))
    ax2.imshow(arr)
    cntr = ax2.contour(arr, colors="k")

    plt.setp(cntr.collections, path_effects=[
        PathEffects.withStroke(linewidth=3, foreground="w")])

    clb1s = ax2.clabel(cntr, fmt="%2.0f", use_clabeltext=True)

```

```
plt.setp(clbls, path_effects=[
    PathEffects.withStroke(linewidth=3, foreground="w")])

# shadow as a path effect
ax3 = plt.subplot(133)
p1, = ax3.plot([0, 1], [0, 1])
leg = ax3.legend([p1], ["Line 1"], fancybox=True, loc=2)
leg.legendPatch.set_path_effects([PathEffects.withSimplePatchShadow()])

plt.show()
```

Keywords: python, matplotlib, pylab, example, codex (see [Search examples](#))

99.142 pylab_examples example code: pcolor_demo.py

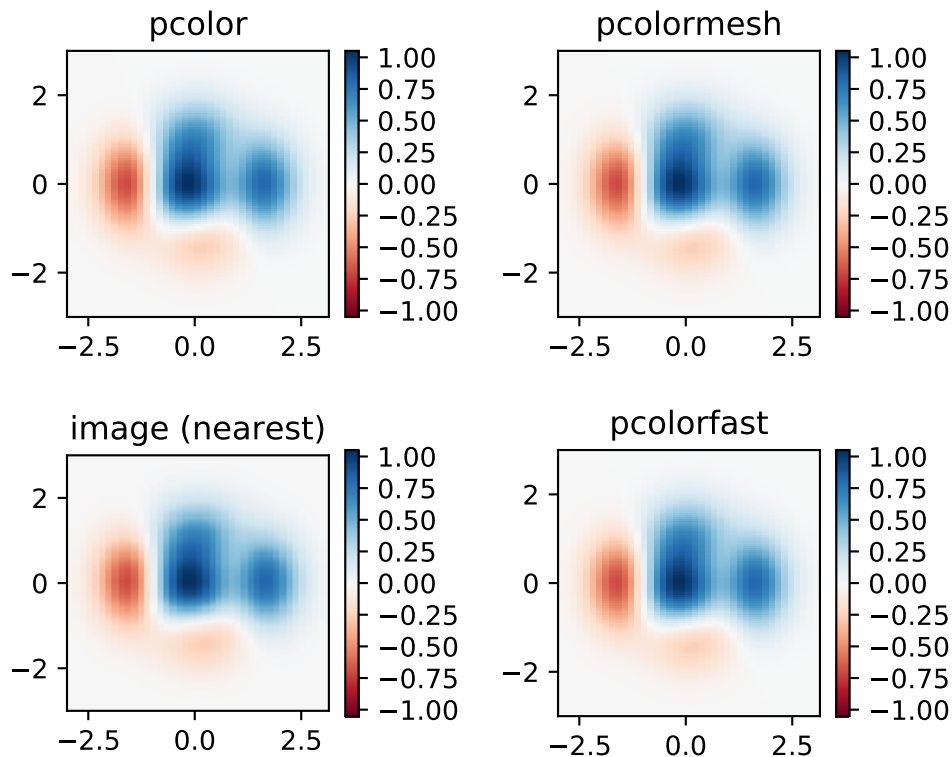

```
"""
Demonstrates similarities between pcolor, pcolormesh, imshow and pcolorfast
for drawing quadrilateral grids.
"""
import matplotlib.pyplot as plt
import numpy as np
```

```

# make these smaller to increase the resolution
dx, dy = 0.15, 0.05

# generate 2 2d grids for the x & y bounds
y, x = np.mgrid[slice(-3, 3 + dy, dy),
                slice(-3, 3 + dx, dx)]
z = (1 - x / 2. + x ** 5 + y ** 3) * np.exp(-x ** 2 - y ** 2)
# x and y are bounds, so z should be the value *inside* those bounds.
# Therefore, remove the last value from the z array.
z = z[:-1, :-1]
z_min, z_max = -np.abs(z).max(), np.abs(z).max()

plt.subplot(2, 2, 1)
plt.pcolor(x, y, z, cmap='RdBu', vmin=z_min, vmax=z_max)
plt.title('pcolor')
# set the limits of the plot to the limits of the data
plt.axis([x.min(), x.max(), y.min(), y.max()])
plt.colorbar()

plt.subplot(2, 2, 2)
plt.pcolormesh(x, y, z, cmap='RdBu', vmin=z_min, vmax=z_max)
plt.title('pcolormesh')
# set the limits of the plot to the limits of the data
plt.axis([x.min(), x.max(), y.min(), y.max()])
plt.colorbar()

plt.subplot(2, 2, 3)
plt.imshow(z, cmap='RdBu', vmin=z_min, vmax=z_max,
           extent=[x.min(), x.max(), y.min(), y.max()],
           interpolation='nearest', origin='lower')
plt.title('image (nearest)')
plt.colorbar()

ax = plt.subplot(2, 2, 4)
ax.pcolorfast(x, y, z, cmap='RdBu', vmin=z_min, vmax=z_max)
plt.title('pcolorfast')
plt.colorbar()

plt.subplots_adjust(wspace=0.5, hspace=0.5)

plt.show()

```

Keywords: python, matplotlib, pylab, example, codex (see [Search examples](#))

99.143 pylab_examples example code: pcolor_log.py

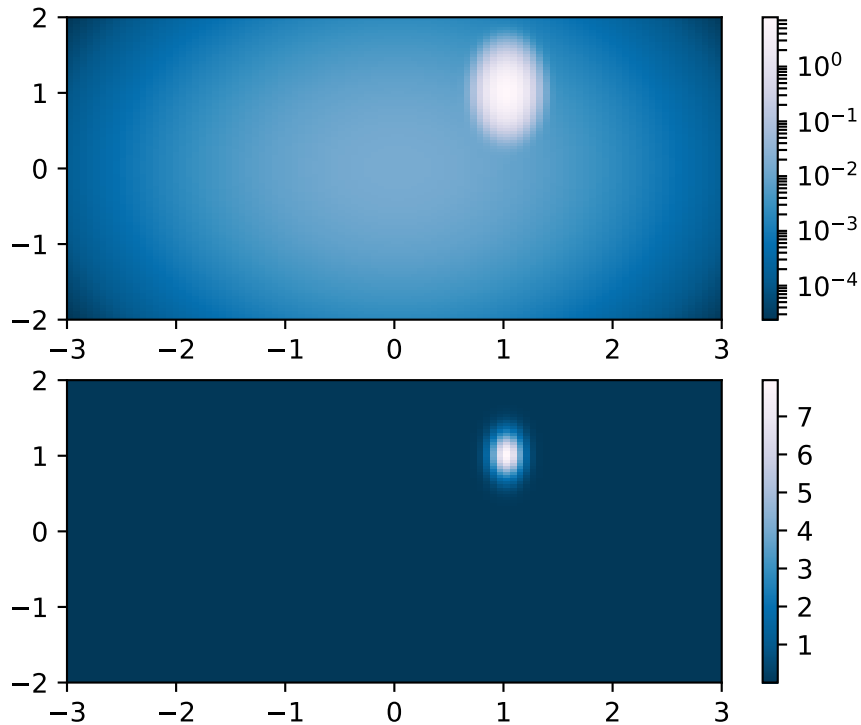

```
import matplotlib.pyplot as plt
from matplotlib.colors import LogNorm
import numpy as np
from matplotlib.mlab import bivariate_normal

N = 100
X, Y = np.mgrid[-3:3:complex(0, N), -2:2:complex(0, N)]

# A low hump with a spike coming out of the top right.
# Needs to have z/colour axis on a log scale so we see both hump and spike.
# linear scale only shows the spike.
Z1 = bivariate_normal(X, Y, 0.1, 0.2, 1.0, 1.0) + 0.1 * bivariate_normal(X, Y, 1.0, 1.0,
    -0.0, 0.0)

plt.subplot(2, 1, 1)
plt.pcolor(X, Y, Z1, norm=LogNorm(vmin=Z1.min(), vmax=Z1.max()), cmap='PuBu_r')
plt.colorbar()

plt.subplot(2, 1, 2)
plt.pcolor(X, Y, Z1, cmap='PuBu_r')
plt.colorbar()
```



```
plt.show()
```

Keywords: python, matplotlib, pylab, example, codex (see [Search examples](#))

99.144 pylab_examples example code: pcolor_small.py

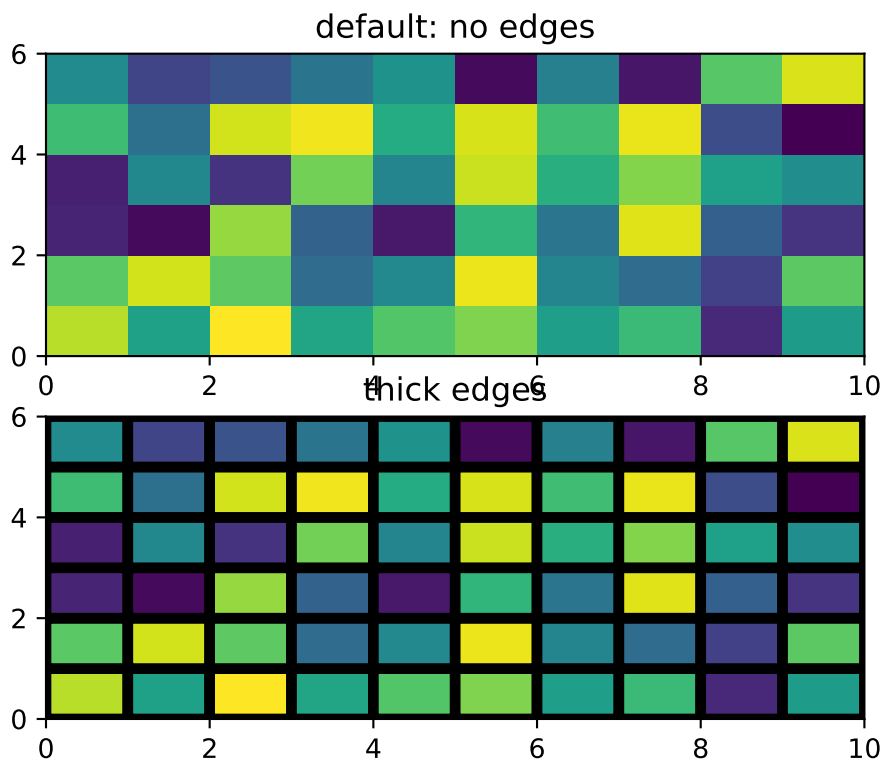

```
import matplotlib.pyplot as plt
from numpy.random import rand

Z = rand(6, 10)

plt.subplot(2, 1, 1)
c = plt.pcolor(Z)
plt.title('default: no edges')

plt.subplot(2, 1, 2)
c = plt.pcolor(Z, edgecolors='k', linewidths=4)
plt.title('thick edges')

plt.show()
```

Keywords: python, matplotlib, pylab, example, codex (see *Search examples*)

99.145 pylab_examples example code: pie_demo2.py

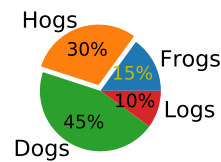
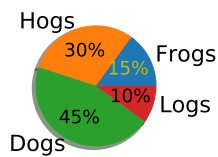
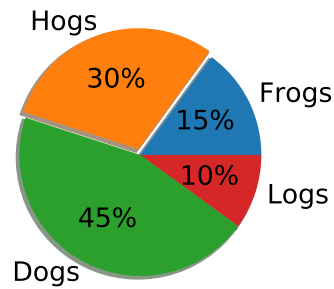
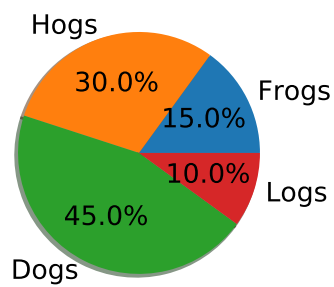

```
"""  
Make a pie charts of varying size - see  
http://matplotlib.org/api/pyplot\_api.html#matplotlib.pyplot.pie for the docstring.
```

```
This example shows a basic pie charts with labels optional features,  
like autolabeling the percentage, offsetting a slice with "explode"  
and adding a shadow, in different sizes.
```

```
"""  
import matplotlib.pyplot as plt  
from matplotlib.gridspec import GridSpec  
  
# Some data  
  
labels = 'Frogs', 'Hogs', 'Dogs', 'Logs'  
fracs = [15, 30, 45, 10]  
  
explode = (0, 0.05, 0, 0)
```

```
# Make square figures and axes

the_grid = GridSpec(2, 2)

plt.subplot(the_grid[0, 0], aspect=1)

plt.pie(frac, labels=labels, autopct='%1.1f%%', shadow=True)

plt.subplot(the_grid[0, 1], aspect=1)

plt.pie(frac, explode=explode, labels=labels, autopct='%0f%%', shadow=True)

plt.subplot(the_grid[1, 0], aspect=1)

patches, texts, autotexts = plt.pie(frac, labels=labels,
                                     autopct='%0f%%',
                                     shadow=True, radius=0.5)

# Make the labels on the small plot easier to read.
for t in texts:
    t.set_size('smaller')
for t in autotexts:
    t.set_size('x-small')
autotexts[0].set_color('y')

plt.subplot(the_grid[1, 1], aspect=1)

# Turn off shadow for tiny plot with exploded slice.
patches, texts, autotexts = plt.pie(frac, explode=explode,
                                     labels=labels, autopct='%0f%%',
                                     shadow=False, radius=0.5)

for t in texts:
    t.set_size('smaller')
for t in autotexts:
    t.set_size('x-small')
autotexts[0].set_color('y')

plt.show()
```

Keywords: python, matplotlib, pylab, example, codex (see [Search examples](#))

99.146 pylab_examples example code: plotfile_demo.py

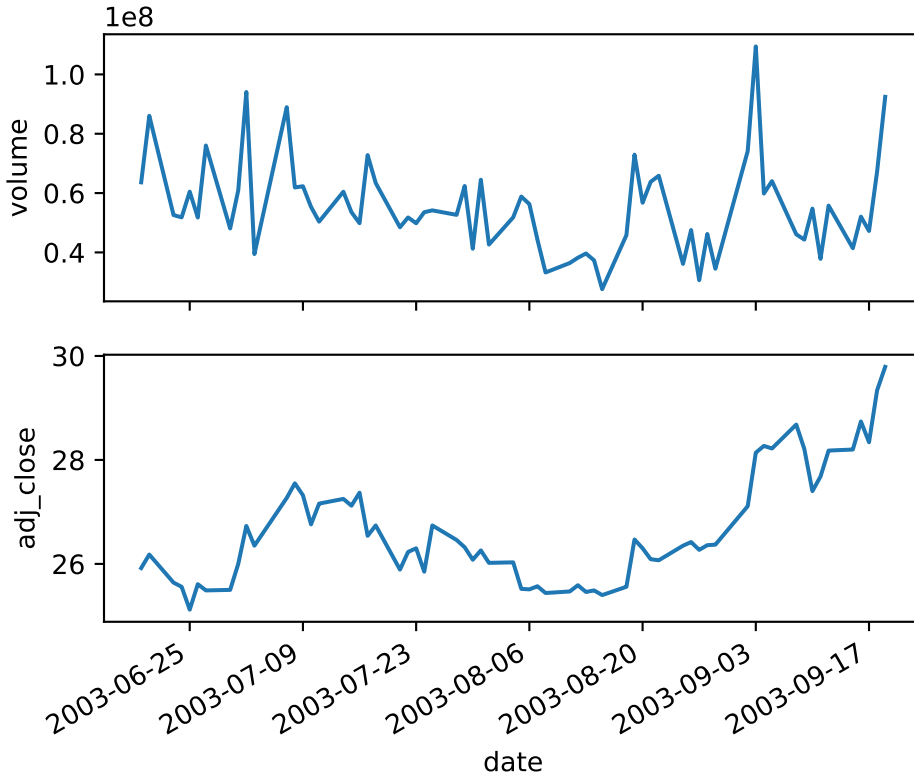

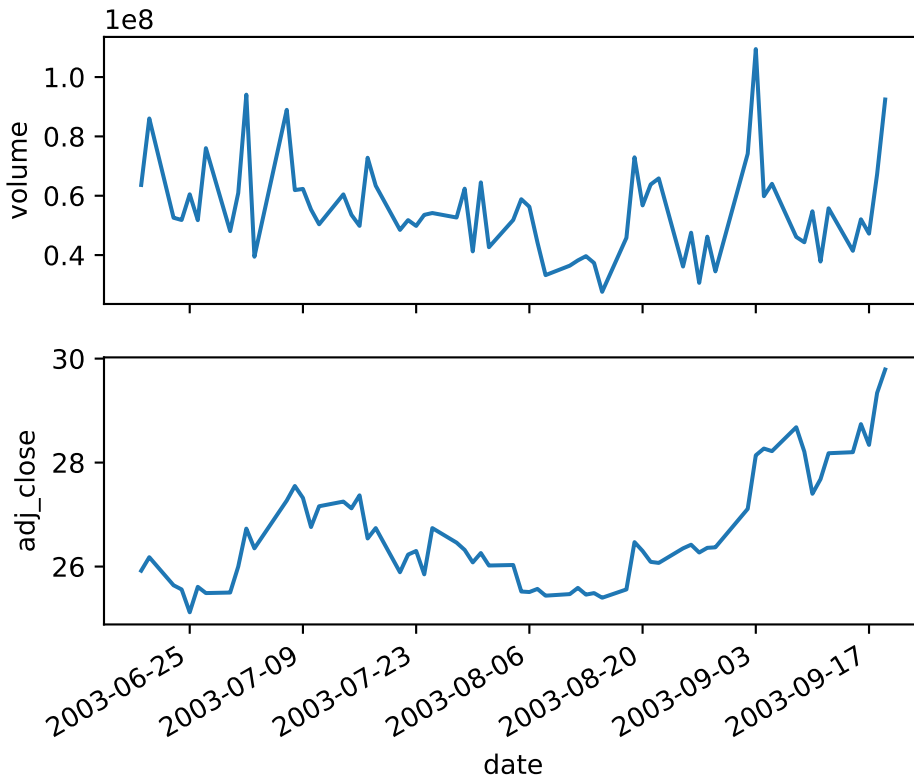

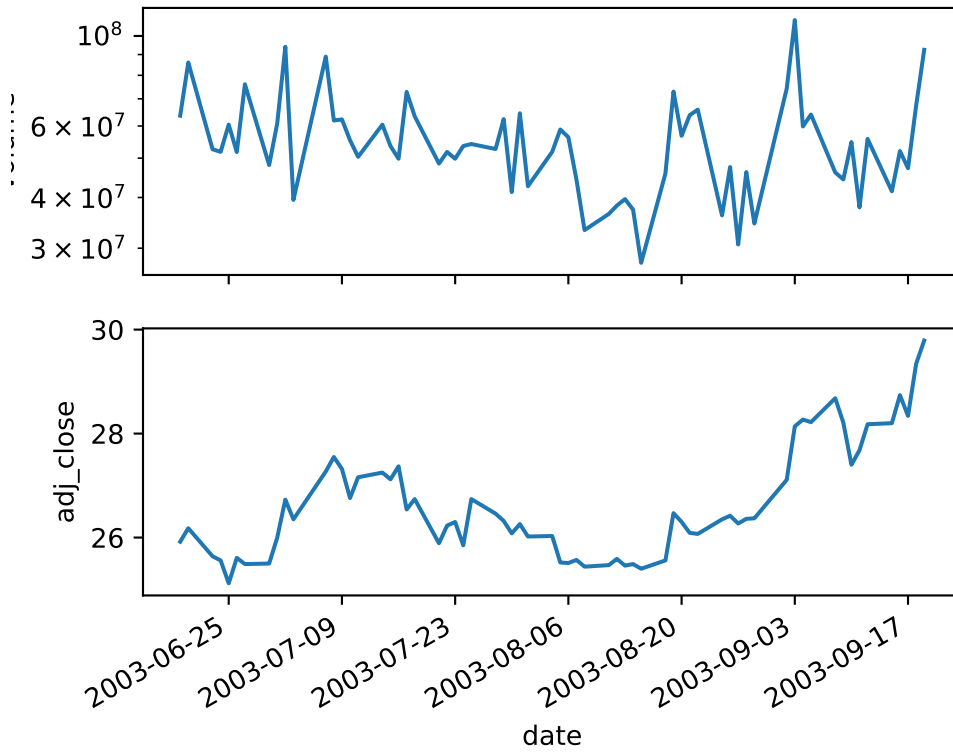

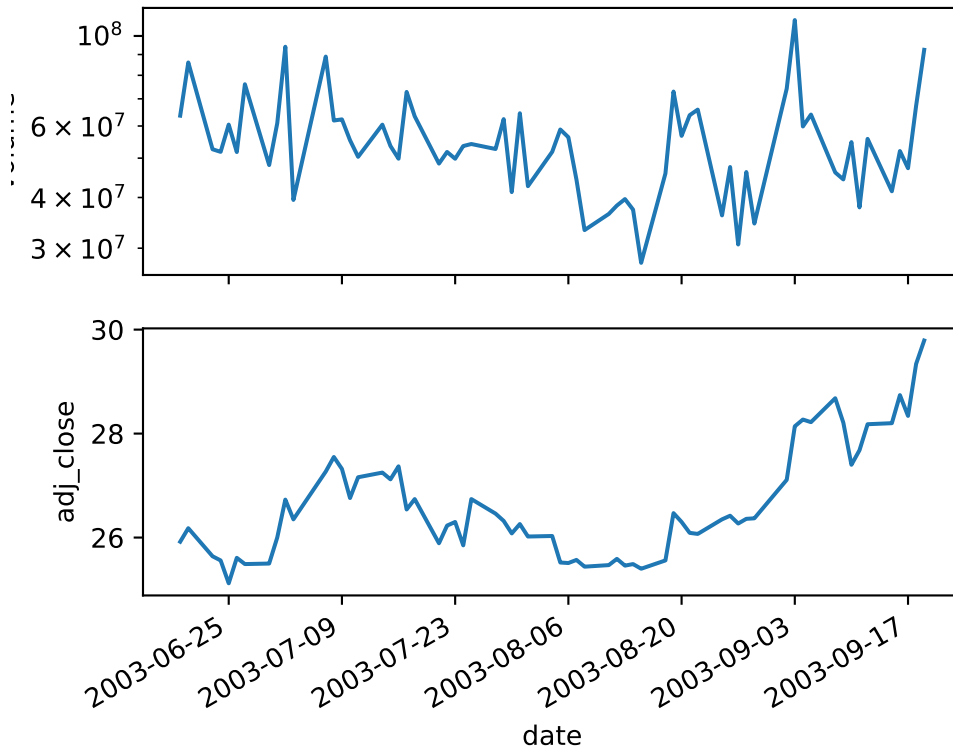



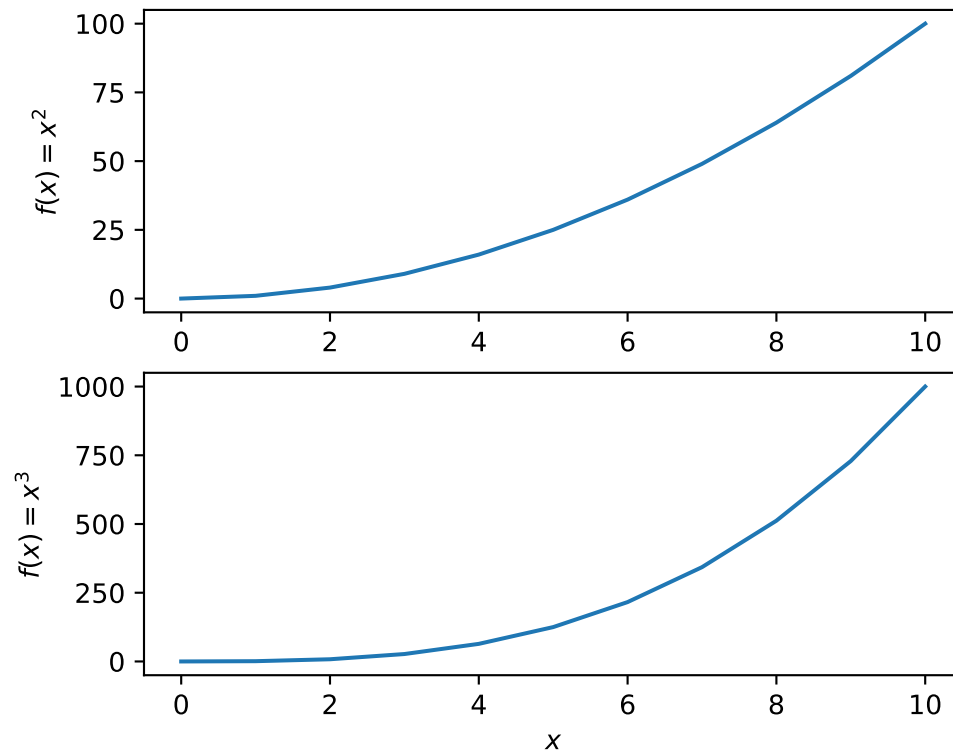

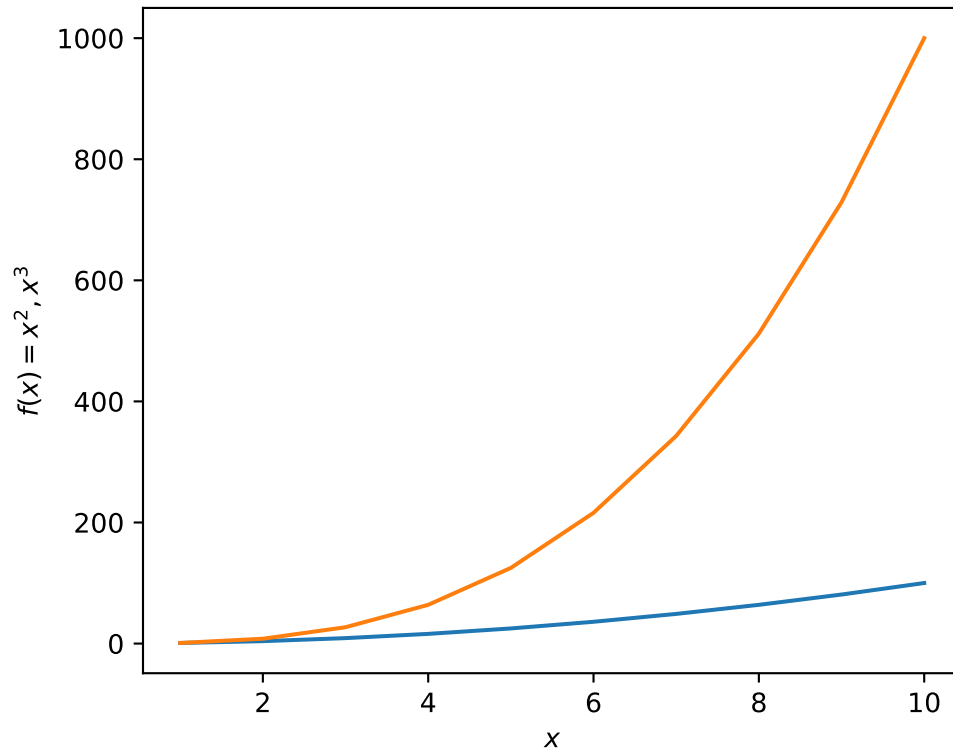

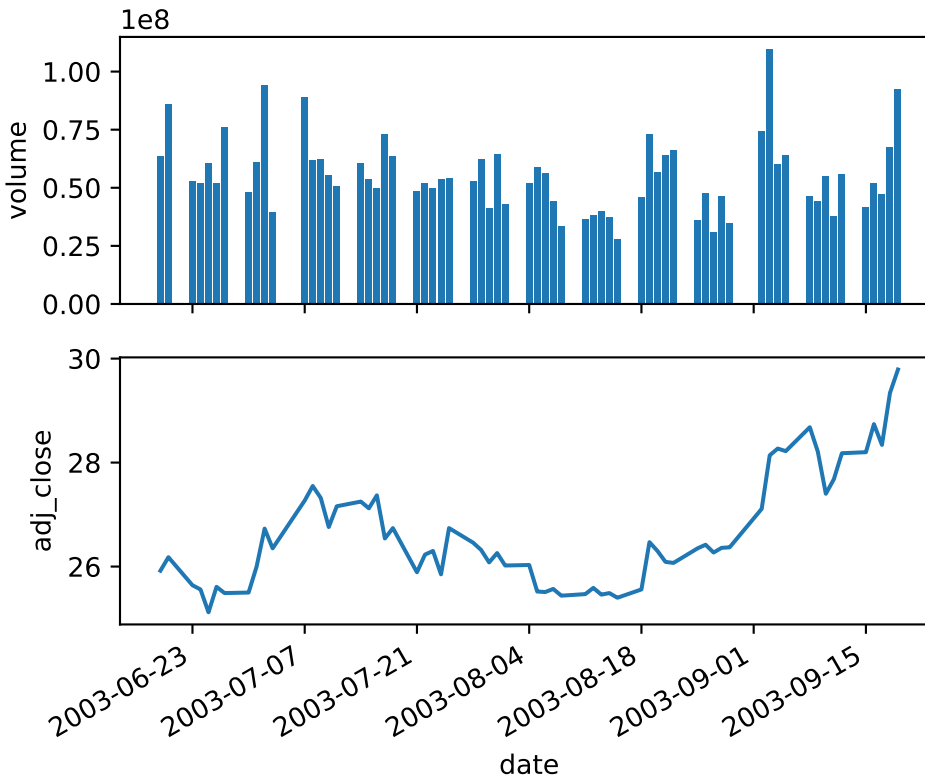

```

import matplotlib.pyplot as plt
import numpy as np

import matplotlib.cbook as cbook

fname = cbook.get_sample_data('msft.csv', asfileobj=False)
fname2 = cbook.get_sample_data('data_x_x2_x3.csv', asfileobj=False)

# test 1; use ints
plt.plotfile(fname, (0, 5, 6))

# test 2; use names
plt.plotfile(fname, ('date', 'volume', 'adj_close'))

# test 3; use semilogy for volume
plt.plotfile(fname, ('date', 'volume', 'adj_close'),
              plotfuncs={'volume': 'semilogy'})

# test 4; use semilogy for volume
plt.plotfile(fname, (0, 5, 6), plotfuncs={5: 'semilogy'})

# test 5; single subplot
plt.plotfile(fname, ('date', 'open', 'high', 'low', 'close'), subplots=False)

# test 6; labeling, if no names in csv-file
plt.plotfile(fname2, cols=(0, 1, 2), delimiter=' ',

```

```

names=['$x$', '$f(x)=x^2$', '$f(x)=x^3$'])

# test 7; more than one file per figure--illustrated here with a single file
plt.plotfile(fname2, cols=(0, 1), delimiter=' ')
plt.plotfile(fname2, cols=(0, 2), newfig=False,
             delimiter=' ') # use current figure
plt.xlabel(r'$x$')
plt.ylabel(r'$f(x) = x^2, x^3$')

# test 8; use bar for volume
plt.plotfile(fname, (0, 5, 6), plotfuncs={5: 'bar'})

plt.show()

```

Keywords: python, matplotlib, pylab, example, codex (see [Search examples](#))

99.147 pylab_examples example code: polar_demo.py

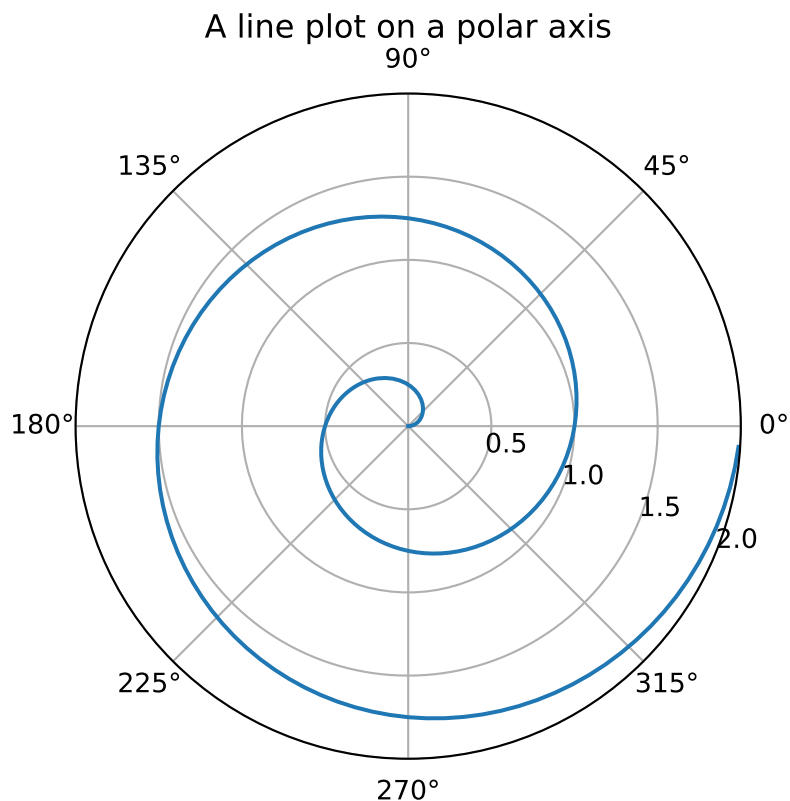

```

"""
Demo of a line plot on a polar axis.
"""
import numpy as np

```

```
import matplotlib.pyplot as plt

r = np.arange(0, 2, 0.01)
theta = 2 * np.pi * r

ax = plt.subplot(111, projection='polar')
ax.plot(theta, r)
ax.set_rmax(2)
ax.set_rticks([0.5, 1, 1.5, 2]) # less radial ticks
ax.set_rlabel_position(-22.5) # get radial labels away from plotted line
ax.grid(True)

ax.set_title("A line plot on a polar axis", va='bottom')
plt.show()
```

Keywords: python, matplotlib, pylab, example, codex (see [Search examples](#))

99.148 pylab_examples example code: polar_legend.py

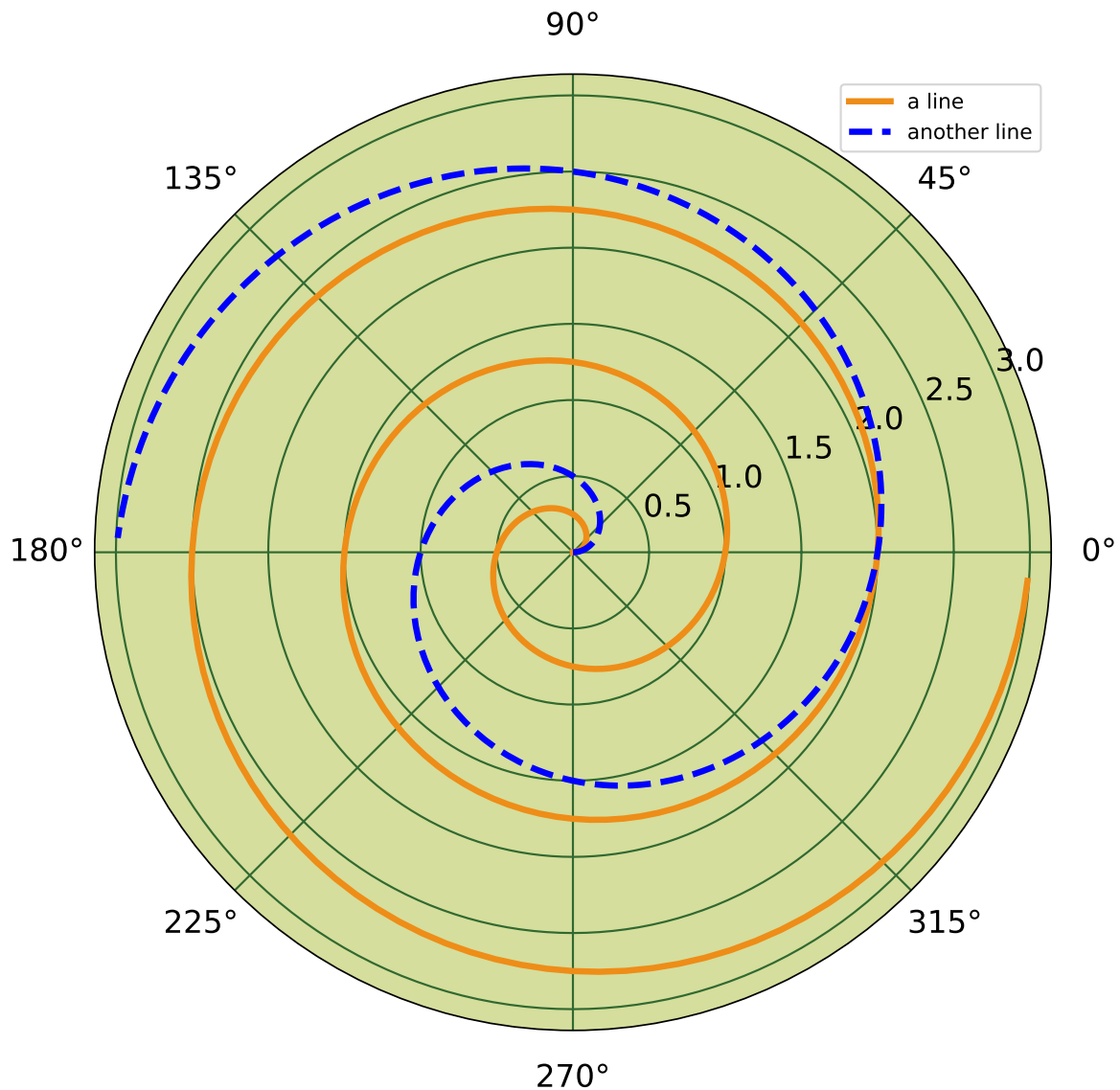

```
import numpy as np
from matplotlib.pyplot import figure, show, rc

# radar green, solid grid lines
rc('grid', color='#316931', linewidth=1, linestyle='-')
rc('xtick', labelsizes=15)
rc('ytick', labelsizes=15)

# force square figure and square axes looks better for polar, IMO
fig = figure(figsize=(8, 8))
```

```
ax = fig.add_axes([0.1, 0.1, 0.8, 0.8],
                  projection='polar', facecolor='#d5de9c')

r = np.arange(0, 3.0, 0.01)
theta = 2*np.pi*r
ax.plot(theta, r, color='#ee8d18', lw=3, label='a line')
ax.plot(0.5*theta, r, color='blue', ls='--', lw=3, label='another line')
ax.legend()

show()
```

Keywords: python, matplotlib, pylab, example, codex (see [Search examples](#))

99.149 pylab_examples example code: print_stdout.py

[source code]

```
# -*- noplots -*-
# print png to standard out
# usage: python print_stdout.py > somefile.png

import sys
import matplotlib
matplotlib.use('Agg')
import matplotlib.pyplot as plt

plt.plot([1, 2, 3])

if sys.version_info[0] >= 3:
    plt.savefig(sys.stdout.buffer)
else:
    plt.savefig(sys.stdout)
```

Keywords: python, matplotlib, pylab, example, codex (see [Search examples](#))

99.150 pylab_examples example code: psd_demo.py

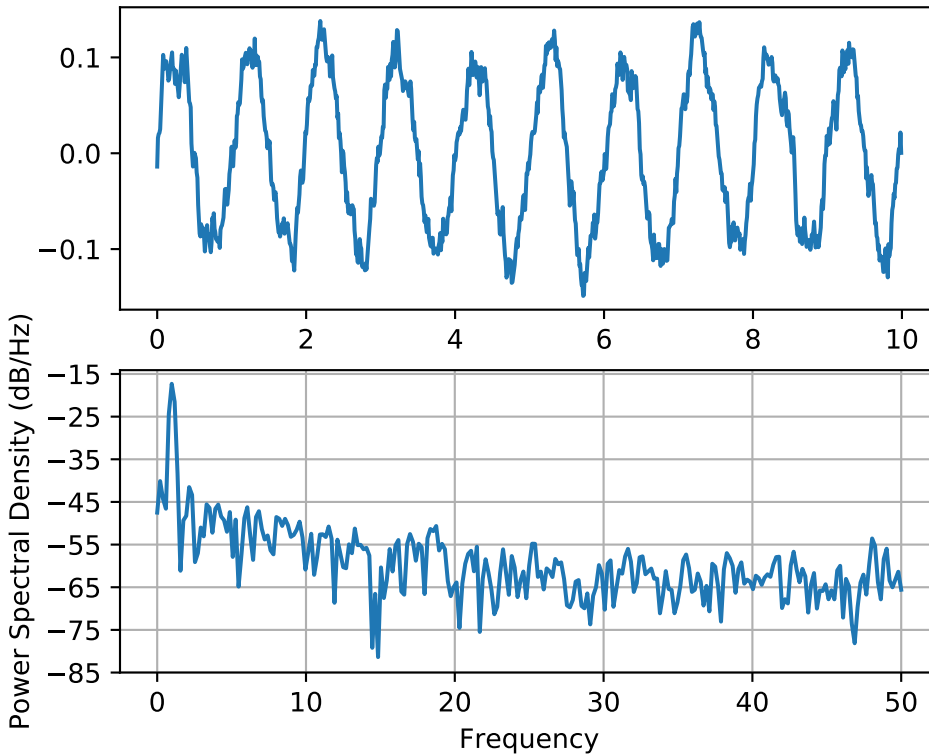

```
import matplotlib.pyplot as plt
import numpy as np

dt = 0.01
t = np.arange(0, 10, dt)
nse = np.random.randn(len(t))
r = np.exp(-t/0.05)

cnse = np.convolve(nse, r)*dt
cnse = cnse[:len(t)]
s = 0.1*np.sin(2*np.pi*t) + cnse

plt.subplot(211)
plt.plot(t, s)
plt.subplot(212)
plt.psd(s, 512, 1/dt)

plt.show()

"""
% compare with MATLAB
dt = 0.01;
```



```

t = [0:dt:10];
nse = randn(size(t));
r = exp(-t/0.05);
cnse = conv(nse, r)*dt;
cnse = cnse(1:length(t));
s = 0.1*sin(2*pi*t) + cnse;

subplot(211)
plot(t,s)
subplot(212)
psd(s, 512, 1/dt)

""""

```

Keywords: python, matplotlib, pylab, example, codex (see [Search examples](#))

99.151 pylab_examples example code: psd_demo2.py

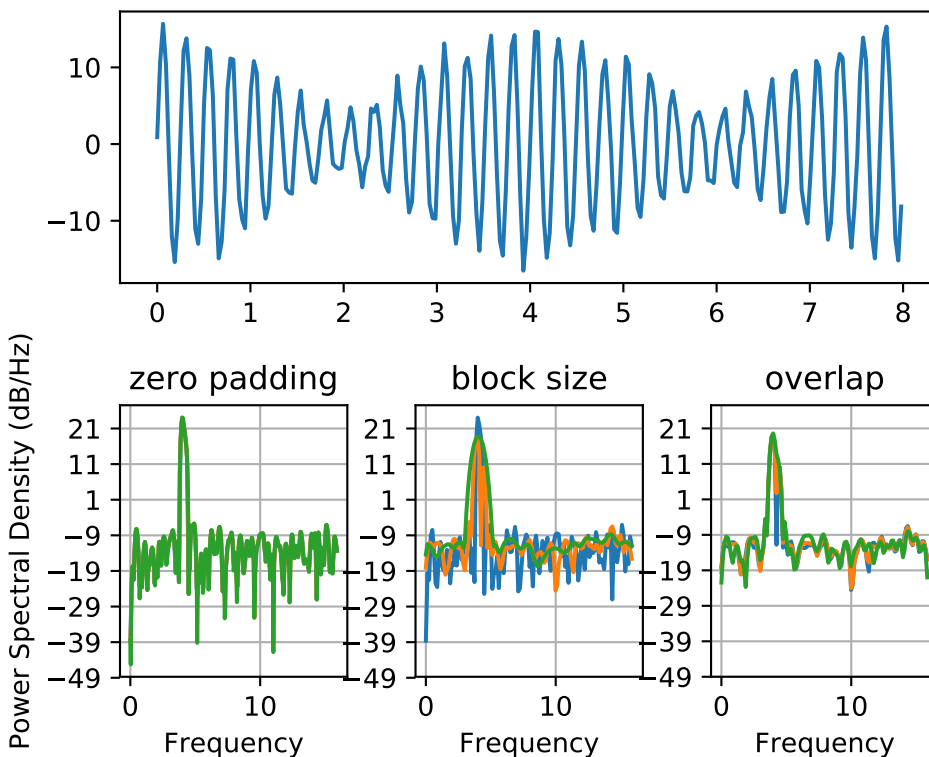

```

# This example shows the effects of some of the different PSD parameters
import numpy as np
import matplotlib.pyplot as plt

```

```
dt = np.pi / 100.
fs = 1. / dt
t = np.arange(0, 8, dt)
y = 10. * np.sin(2 * np.pi * 4 * t) + 5. * np.sin(2 * np.pi * 4.25 * t)
y = y + np.random.randn(*t.shape)

# Plot the raw time series
fig = plt.figure()
fig.subplots_adjust(hspace=0.45, wspace=0.3)
ax = fig.add_subplot(2, 1, 1)
ax.plot(t, y)

# Plot the PSD with different amounts of zero padding. This uses the entire
# time series at once
ax2 = fig.add_subplot(2, 3, 4)
ax2.psd(y, NFFT=len(t), pad_to=len(t), Fs=fs)
ax2.psd(y, NFFT=len(t), pad_to=len(t)*2, Fs=fs)
ax2.psd(y, NFFT=len(t), pad_to=len(t)*4, Fs=fs)
plt.title('zero padding')

# Plot the PSD with different block sizes, Zero pad to the length of the
# original data sequence.
ax3 = fig.add_subplot(2, 3, 5, sharex=ax2, sharey=ax2)
ax3.psd(y, NFFT=len(t), pad_to=len(t), Fs=fs)
ax3.psd(y, NFFT=len(t)//2, pad_to=len(t), Fs=fs)
ax3.psd(y, NFFT=len(t)//4, pad_to=len(t), Fs=fs)
ax3.set_ylabel('')
plt.title('block size')

# Plot the PSD with different amounts of overlap between blocks
ax4 = fig.add_subplot(2, 3, 6, sharex=ax2, sharey=ax2)
ax4.psd(y, NFFT=len(t)//2, pad_to=len(t), noverlap=0, Fs=fs)
ax4.psd(y, NFFT=len(t)//2, pad_to=len(t), noverlap=int(0.05*len(t)/2.), Fs=fs)
ax4.psd(y, NFFT=len(t)//2, pad_to=len(t), noverlap=int(0.2*len(t)/2.), Fs=fs)
ax4.set_ylabel('')
plt.title('overlap')

plt.show()
```

Keywords: python, matplotlib, pylab, example, codex (see [Search examples](#))

99.152 pylab_examples example code: psd_demo3.py

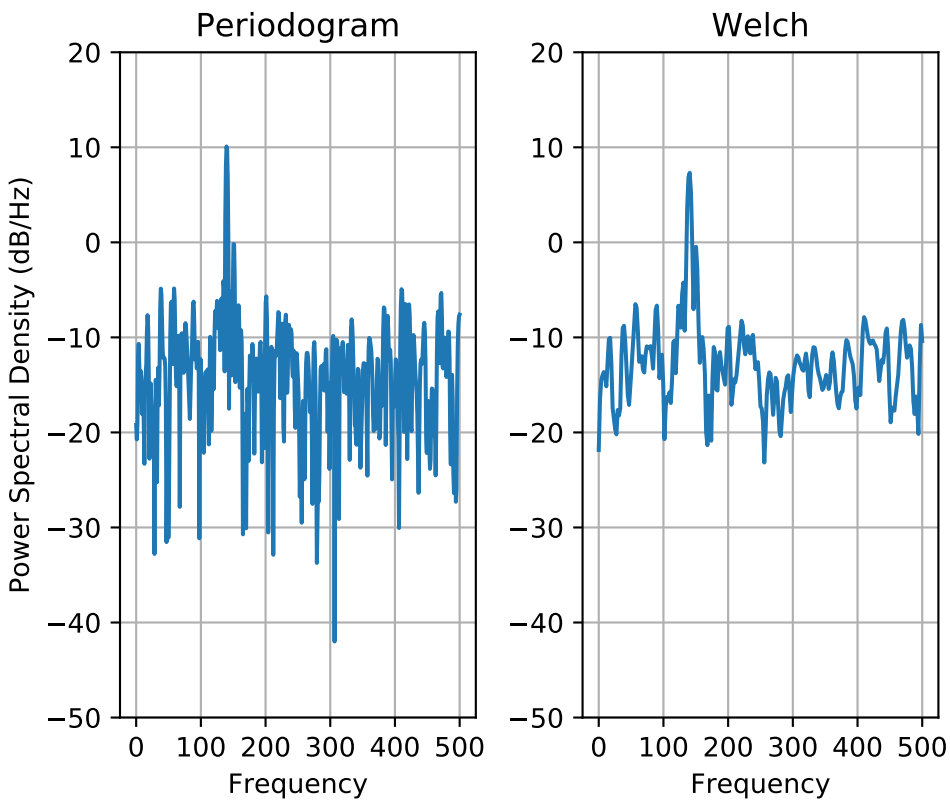

"""This is a ported version of a MATLAB example from the signal processing toolbox that showed some difference at one time between Matplotlib's and MATLAB's scaling of the PSD.

"""

```
import numpy as np
import matplotlib.pyplot as plt
import matplotlib.mlab as mlab

prng = np.random.RandomState(123456) # to ensure reproducibility

fs = 1000
t = np.linspace(0, 0.3, 301)
A = np.array([2, 8]).reshape(-1, 1)
f = np.array([150, 140]).reshape(-1, 1)
xn = (A * np.sin(2 * np.pi * f * t)).sum(axis=0) + 5 * prng.randn(*t.shape)

fig, (ax0, ax1) = plt.subplots(ncols=2)

fig.subplots_adjust(hspace=0.45, wspace=0.3)
yticks = np.arange(-50, 30, 10)
```

```
yrange = (yticks[0], yticks[-1])
xticks = np.arange(0, 550, 100)

ax0.psd(xn, NFFT=301, Fs=fs, window=mlab.window_none, pad_to=1024,
        scale_by_freq=True)
ax0.set_title('Periodogram')
ax0.set_yticks(yticks)
ax0.set_xticks(xticks)
ax0.grid(True)
ax0.set_ylim(yrange)

ax1.psd(xn, NFFT=150, Fs=fs, window=mlab.window_none, pad_to=512, noverlap=75,
        scale_by_freq=True)
ax1.set_title('Welch')
ax1.set_xticks(xticks)
ax1.set_yticks(yticks)
ax1.set_ylabel('') # overwrite the y-label added by `psd`
ax1.grid(True)
ax1.set_ylim(yrange)

plt.show()
```

Keywords: python, matplotlib, pylab, example, codex (see [Search examples](#))

99.153 pylab_examples example code: psd_demo_complex.py

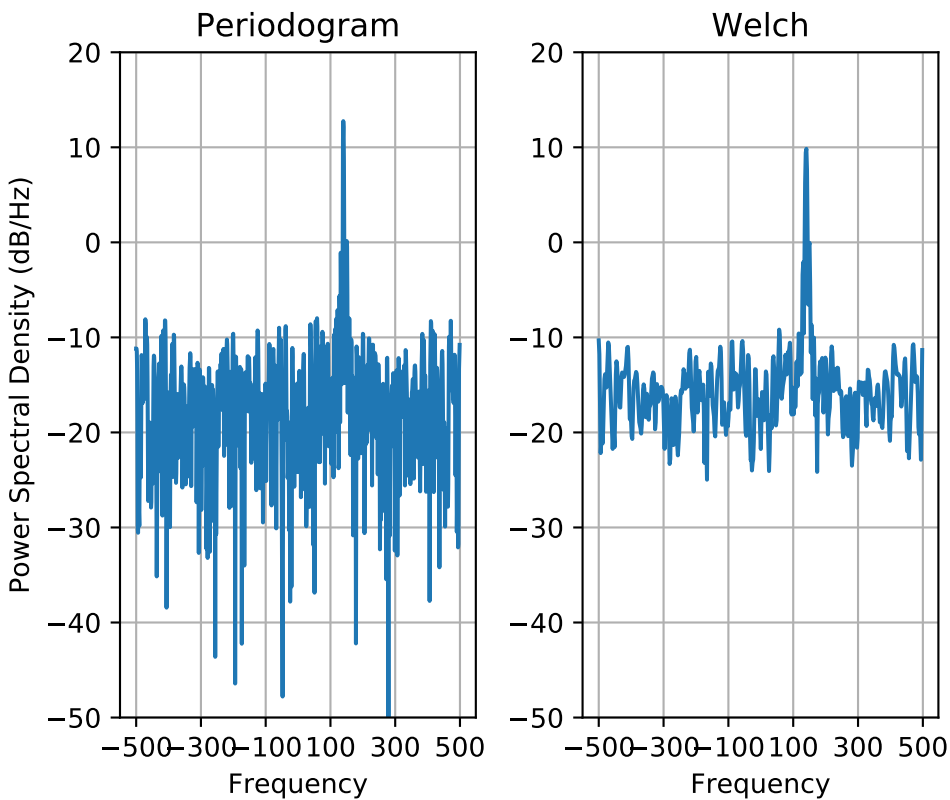

"""This is a ported version of a MATLAB example from the signal processing toolbox that showed some difference at one time between Matplotlib's and MATLAB's scaling of the PSD.

This differs from psd_demo3.py in that this uses a complex signal, so we can see that complex PSD's work properly

"""

```
import numpy as np
import matplotlib.pyplot as plt
import matplotlib.mlab as mlab

prng = np.random.RandomState(123456) # to ensure reproducibility

fs = 1000
t = np.linspace(0, 0.3, 301)
A = np.array([2, 8]).reshape(-1, 1)
f = np.array([150, 140]).reshape(-1, 1)
xn = (A * np.exp(2j * np.pi * f * t)).sum(axis=0) + 5 * prng.randn(*t.shape)

fig, (ax0, ax1) = plt.subplots(ncols=2)
```

```
fig.subplots_adjust(hspace=0.45, wspace=0.3)
yticks = np.arange(-50, 30, 10)
yrange = (yticks[0], yticks[-1])
xticks = np.arange(-500, 550, 200)

ax0.psd(xn, NFFT=301, Fs=fs, window=mlab.window_none, pad_to=1024,
        scale_by_freq=True)
ax0.set_title('Periodogram')
ax0.set_yticks(yticks)
ax0.set_xticks(xticks)
ax0.grid(True)
ax0.set_ylim(yrange)

ax1.psd(xn, NFFT=150, Fs=fs, window=mlab.window_none, pad_to=512, noverlap=75,
        scale_by_freq=True)
ax1.set_title('Welch')
ax1.set_xticks(xticks)
ax1.set_yticks(yticks)
ax1.set_ylabel('') # overwrite the y-label added by `psd`
ax1.grid(True)
ax1.set_ylim(yrange)

plt.show()
```

Keywords: python, matplotlib, pylab, example, codex (see [Search examples](#))

99.154 pylab_examples example code: pythonic_matplotlib.py

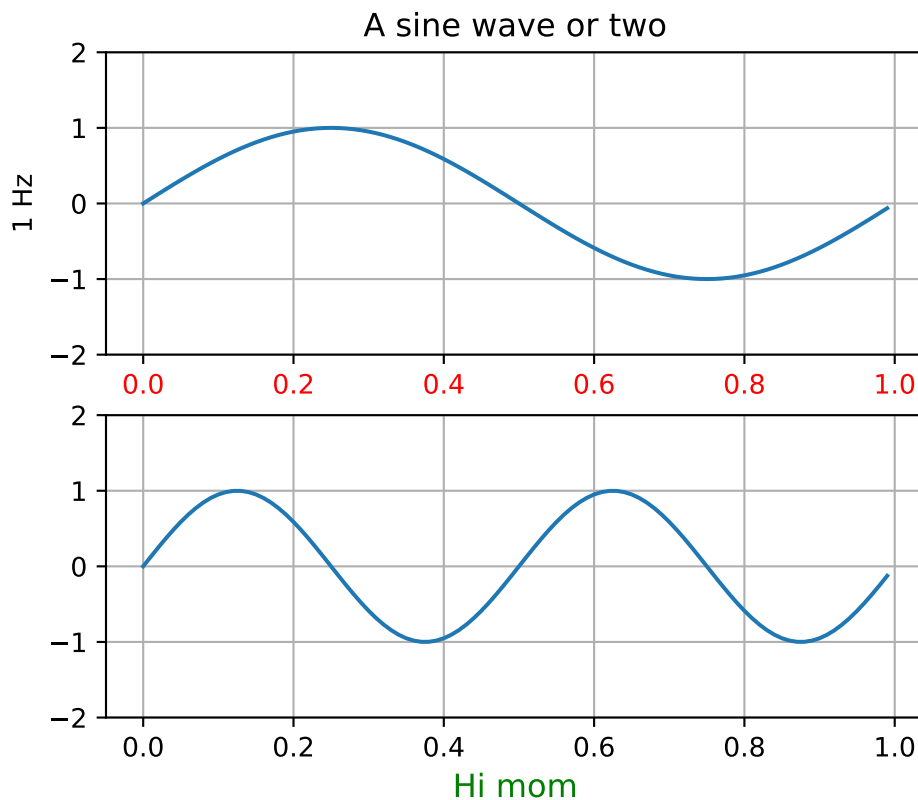

```
"""
```

Some people prefer to write more pythonic, object-oriented code rather than use the pyplot interface to matplotlib. This example shows you how.

Unless you are an application developer, I recommend using part of the pyplot interface, particularly the figure, close, subplot, axes, and show commands. These hide a lot of complexity from you that you don't need to see in normal figure creation, like instantiating DPI instances, managing the bounding boxes of the figure elements, creating and realizing GUI windows and embedding figures in them.

If you are an application developer and want to embed matplotlib in your application, follow the lead of examples/embedding_in_wx.py, examples/embedding_in_gtk.py or examples/embedding_in_tk.py. In this case you will want to control the creation of all your figures, embedding them in application windows, etc.

If you are a web application developer, you may want to use the example in webapp_demo.py, which shows how to use the backend agg figure canvas directly, with none of the globals (current figure,

current axes) that are present in the pyplot interface. Note that there is no reason why the pyplot interface won't work for web application developers, however.

If you see an example in the examples dir written in pyplot interface, and you want to emulate that using the true python method calls, there is an easy mapping. Many of those examples use 'set' to control figure properties. Here's how to map those commands onto instance methods

The syntax of set is

```
plt.setp(object or sequence, somestring, attribute)
```

if called with an object, set calls

```
object.set_somestring(attribute)
```

if called with a sequence, set does

```
for object in sequence:
    object.set_somestring(attribute)
```

So for your example, if a is your axes object, you can do

```
a.set_xticklabels([])
a.set_yticklabels([])
a.set_xticks([])
a.set_yticks([])
"""

from matplotlib.pyplot import figure, show
from numpy import arange, sin, pi

t = arange(0.0, 1.0, 0.01)

fig = figure(1)

ax1 = fig.add_subplot(211)
ax1.plot(t, sin(2*pi*t))
ax1.grid(True)
ax1.set_ylim((-2, 2))
ax1.set_ylabel('1 Hz')
ax1.set_title('A sine wave or two')

for label in ax1.get_xticklabels():
    label.set_color('r')

ax2 = fig.add_subplot(212)
ax2.plot(t, sin(2*2*pi*t))
ax2.grid(True)
```



```

ax2.set_ylim((-2, 2))
l = ax2.set_xlabel('Hi mom')
l.set_color('g')
l.set_fontsize('large')

show()

```

Keywords: python, matplotlib, pylab, example, codex (see [Search examples](#))

99.155 pylab_examples example code: quadmesh_demo.py

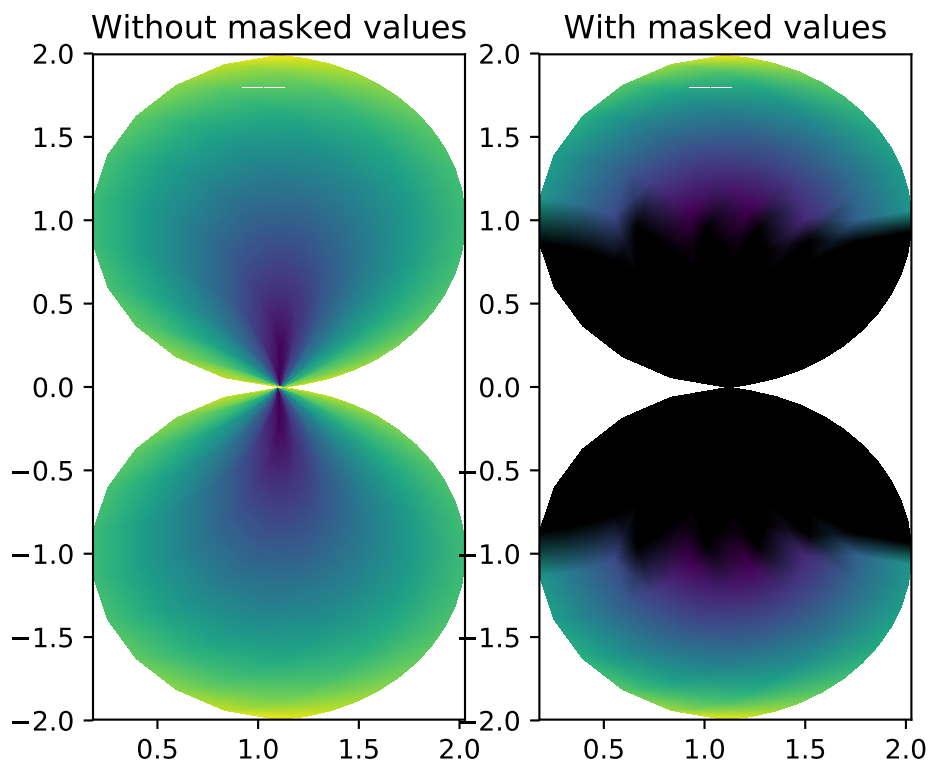

```

"""
pcolormesh uses a QuadMesh, a faster generalization of pcolor, but
with some restrictions.

This demo illustrates a bug in quadmesh with masked data.
"""

import numpy as np
from matplotlib.pyplot import figure, show, savefig
from matplotlib import cm, colors
from numpy import ma

```

```
n = 12
x = np.linspace(-1.5, 1.5, n)
y = np.linspace(-1.5, 1.5, n*2)
X, Y = np.meshgrid(x, y)
Qx = np.cos(Y) - np.cos(X)
Qz = np.sin(Y) + np.sin(X)
Qx = (Qx + 1.1)
Z = np.sqrt(X**2 + Y**2)/5
Z = (Z - Z.min()) / (Z.max() - Z.min())

# The color array can include masked values:
Zm = ma.masked_where(np.fabs(Qz) < 0.5*np.amax(Qz), Z)

fig = figure()
ax = fig.add_subplot(121)
ax.pcolormesh(Qx, Qz, Z, shading='gouraud')
ax.set_title('Without masked values')

ax = fig.add_subplot(122)
# You can control the color of the masked region:
# cmap = cm.RdBu
# cmap.set_bad('y', 1.0)
# ax.pcolormesh(Qx, Qz, Zm, cmap=cmap)
# Or use the default, which is transparent:
col = ax.pcolormesh(Qx, Qz, Zm, shading='gouraud')
ax.set_title('With masked values')

show()
```

Keywords: python, matplotlib, pylab, example, codex (see [Search examples](#))

99.156 pylab_examples example code: quiver_demo.py

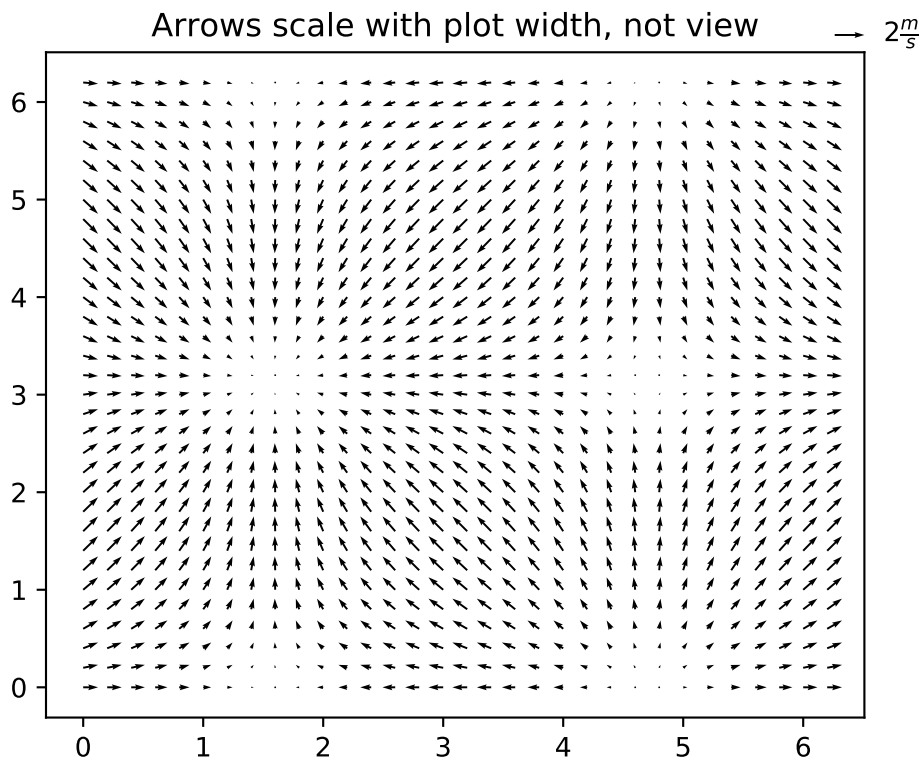



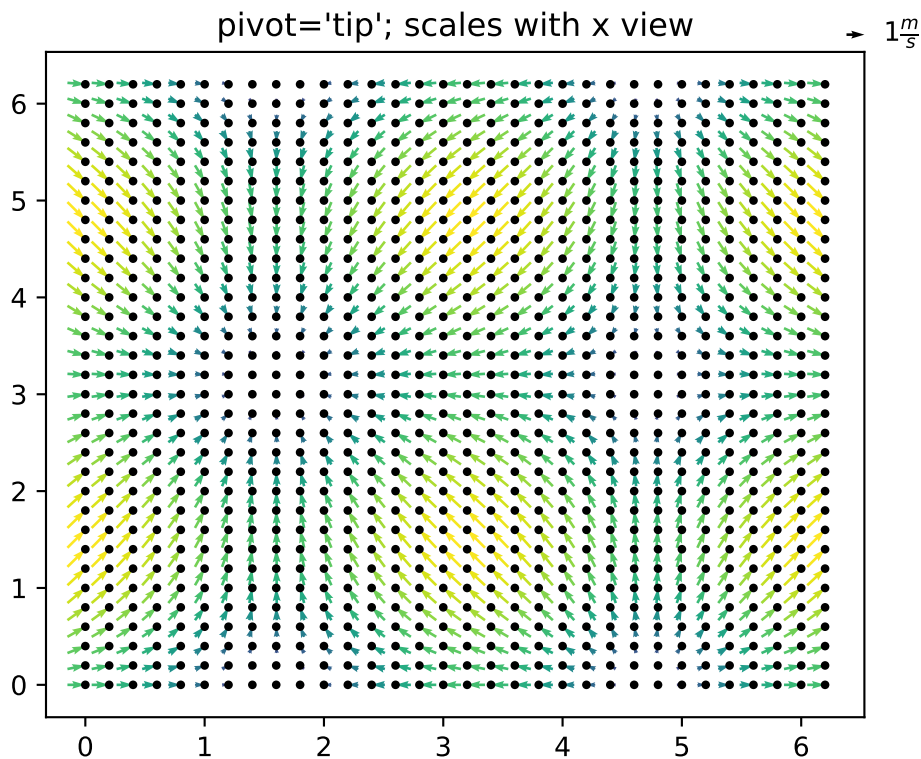

```

"""
=====
Demonstration of advanced quiver and quiverkey functions
=====

Known problem: the plot autoscaling does not take into account
the arrows, so those on the boundaries are often out of the picture.
This is not an easy problem to solve in a perfectly general way.
The workaround is to manually expand the axes.
"""
import matplotlib.pyplot as plt
import numpy as np
from numpy import ma

X, Y = np.meshgrid(np.arange(0, 2 * np.pi, .2), np.arange(0, 2 * np.pi, .2))
U = np.cos(X)
V = np.sin(Y)

plt.figure()
plt.title('Arrows scale with plot width, not view')
Q = plt.quiver(X, Y, U, V, units='width')
qk = plt.quiverkey(Q, 0.9, 0.9, 2, r'$2 \frac{m}{s}$', labelpos='E',
                  coordinates='figure')

plt.figure()
plt.title("pivot='mid'; every third arrow; units='inches'")

```

```

Q = plt.quiver(X[:, :3], Y[:, :3], U[:, :3], V[:, :3],
              pivot='mid', units='inches')
qk = plt.quiverkey(Q, 0.9, 0.9, 1, r'$1 \frac{m}{s}$', labelpos='E',
                  coordinates='figure')
plt.scatter(X[:, :3], Y[:, :3], color='r', s=5)

plt.figure()
plt.title("pivot='tip'; scales with x view")
M = np.hypot(U, V)
Q = plt.quiver(X, Y, U, V, M, units='x', pivot='tip', width=0.022,
              scale=1 / 0.15)
qk = plt.quiverkey(Q, 0.9, 0.9, 1, r'$1 \frac{m}{s}$', labelpos='E',
                  coordinates='figure')
plt.scatter(X, Y, color='k', s=5)

plt.show()

```

Keywords: python, matplotlib, pylab, example, codex (see [Search examples](#))

99.157 pylab_examples example code: quiver_simple_demo.py

→ Quiver key, length = 10

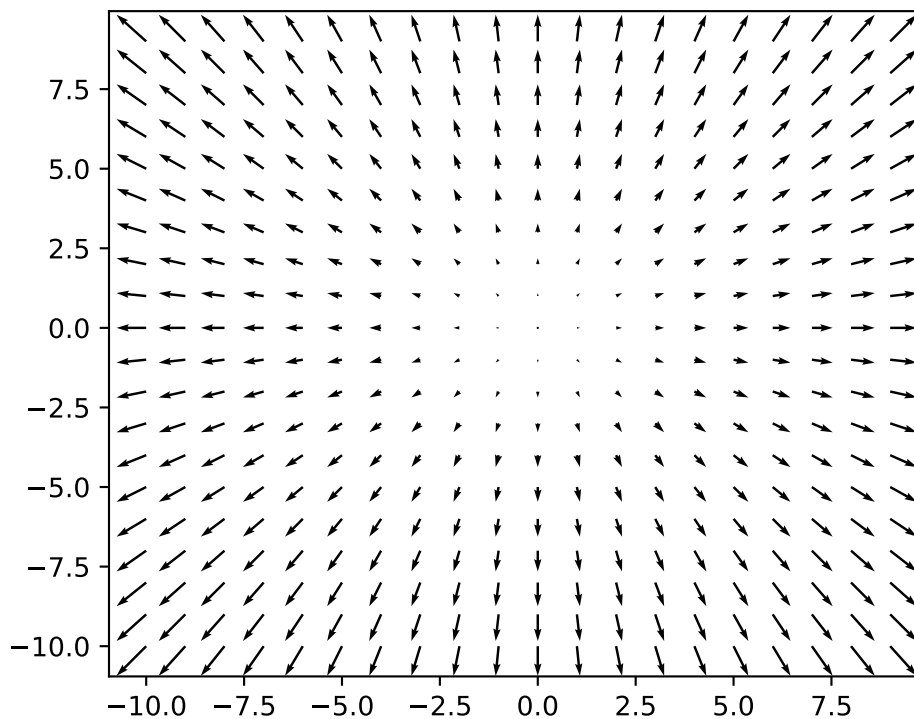

```

"""
=====
A simple example of a quiver plot with a quiverkey
=====
"""
import matplotlib.pyplot as plt
import numpy as np

X = np.arange(-10, 10, 1)
Y = np.arange(-10, 10, 1)
U, V = np.meshgrid(X, Y)

fig, ax = plt.subplots()
q = ax.quiver(X, Y, U, V)
ax.quiverkey(q, X=0.3, Y=1.1, U=10,
             label='Quiver key, length = 10', labelpos='E')

plt.show()

```

Keywords: python, matplotlib, pylab, example, codex (see [Search examples](#))

99.158 pylab_examples example code: scatter_custom_symbol.py

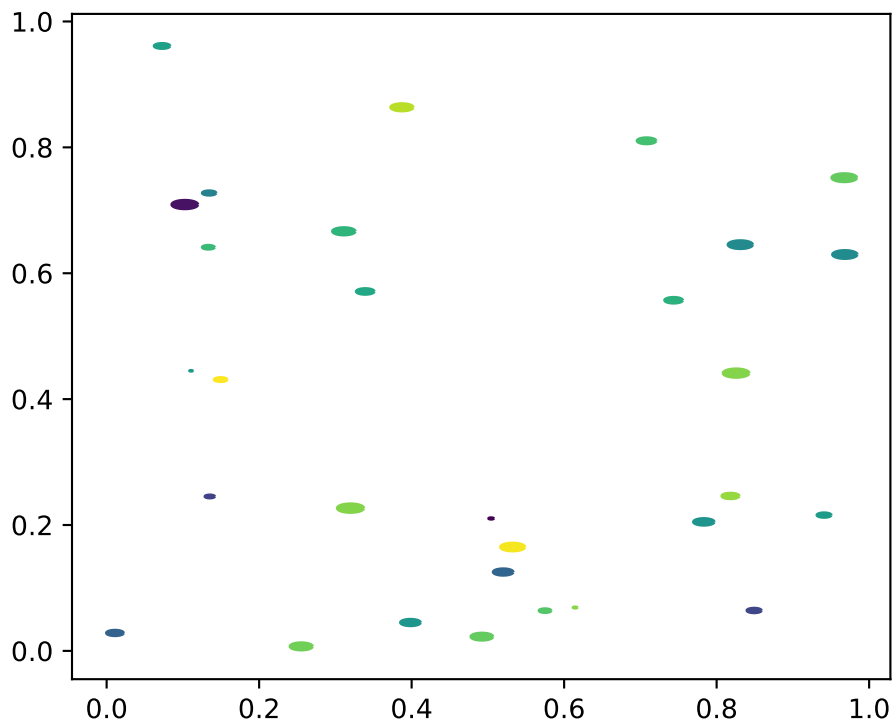

```
import matplotlib.pyplot as plt
from numpy import arange, pi, cos, sin
from numpy.random import rand

# unit area ellipse
rx, ry = 3., 1.
area = rx * ry * pi
theta = arange(0, 2*pi + 0.01, 0.1)
verts = list(zip(rx/area*cos(theta), ry/area*sin(theta)))

x, y, s, c = rand(4, 30)
s *= 10**2.

fig, ax = plt.subplots()
ax.scatter(x, y, s, c, marker=None, verts=verts)

plt.show()
```

Keywords: python, matplotlib, pylab, example, codex (see [Search examples](#))

99.159 pylab_examples example code: scatter_demo2.py

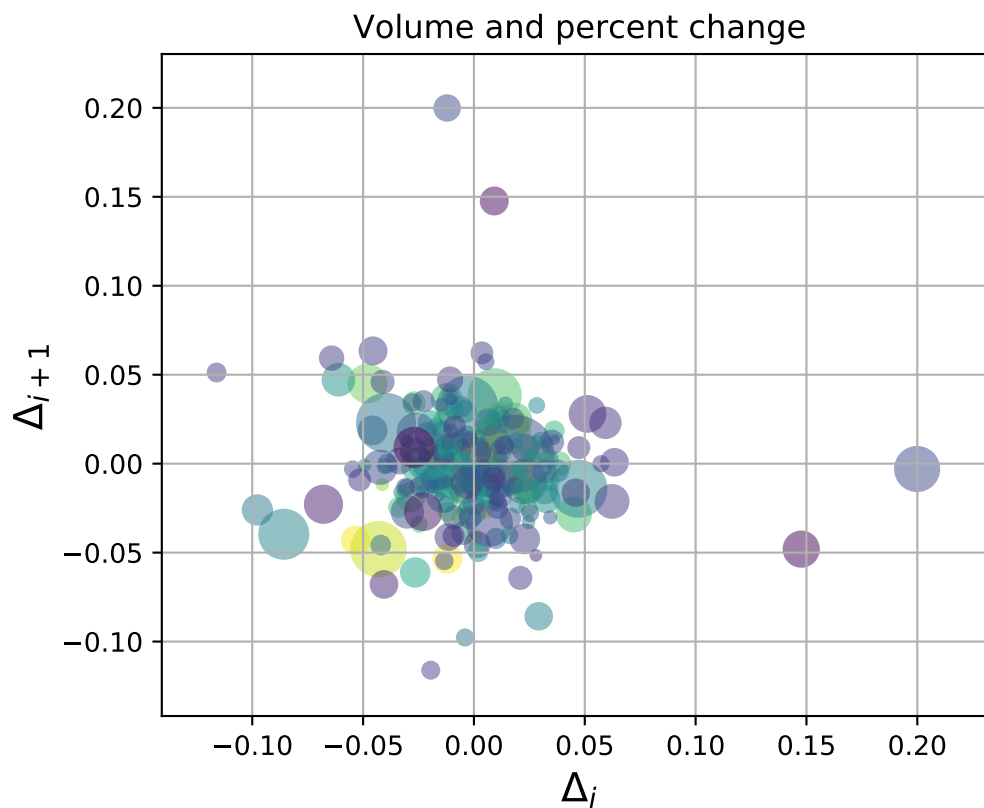

```

"""
Demo of scatter plot with varying marker colors and sizes.
"""
import numpy as np
import matplotlib.pyplot as plt
import matplotlib.cbook as cbook

# Load a numpy record array from yahoo csv data with fields date,
# open, close, volume, adj_close from the mpl-data/example directory.
# The record array stores python datetime.date as an object array in
# the date column
datafile = cbook.get_sample_data('goog.npy')
try:
    # Python3 cannot load python2 .npy files with datetime(object) arrays
    # unless the encoding is set to bytes. However this option was
    # not added until numpy 1.10 so this example will only work with
    # python 2 or with numpy 1.10 and later
    price_data = np.load(datafile, encoding='bytes').view(np.recarray)
except TypeError:
    price_data = np.load(datafile).view(np.recarray)
price_data = price_data[-250:] # get the most recent 250 trading days

delta1 = np.diff(price_data.adj_close)/price_data.adj_close[:-1]

# Marker size in units of points^2
volume = (15 * price_data.volume[:-2] / price_data.volume[0])**2
close = 0.003 * price_data.close[:-2] / 0.003 * price_data.open[:-2]

fig, ax = plt.subplots()
ax.scatter(delta1[:-1], delta1[1:], c=close, s=volume, alpha=0.5)

ax.set_xlabel(r'$\Delta_i$', fontsize=15)
ax.set_ylabel(r'$\Delta_{i+1}$', fontsize=15)
ax.set_title('Volume and percent change')

ax.grid(True)
fig.tight_layout()

plt.show()

```

Keywords: python, matplotlib, pylab, example, codex (see [Search examples](#))

99.160 pylab_examples example code: scatter_hist.py

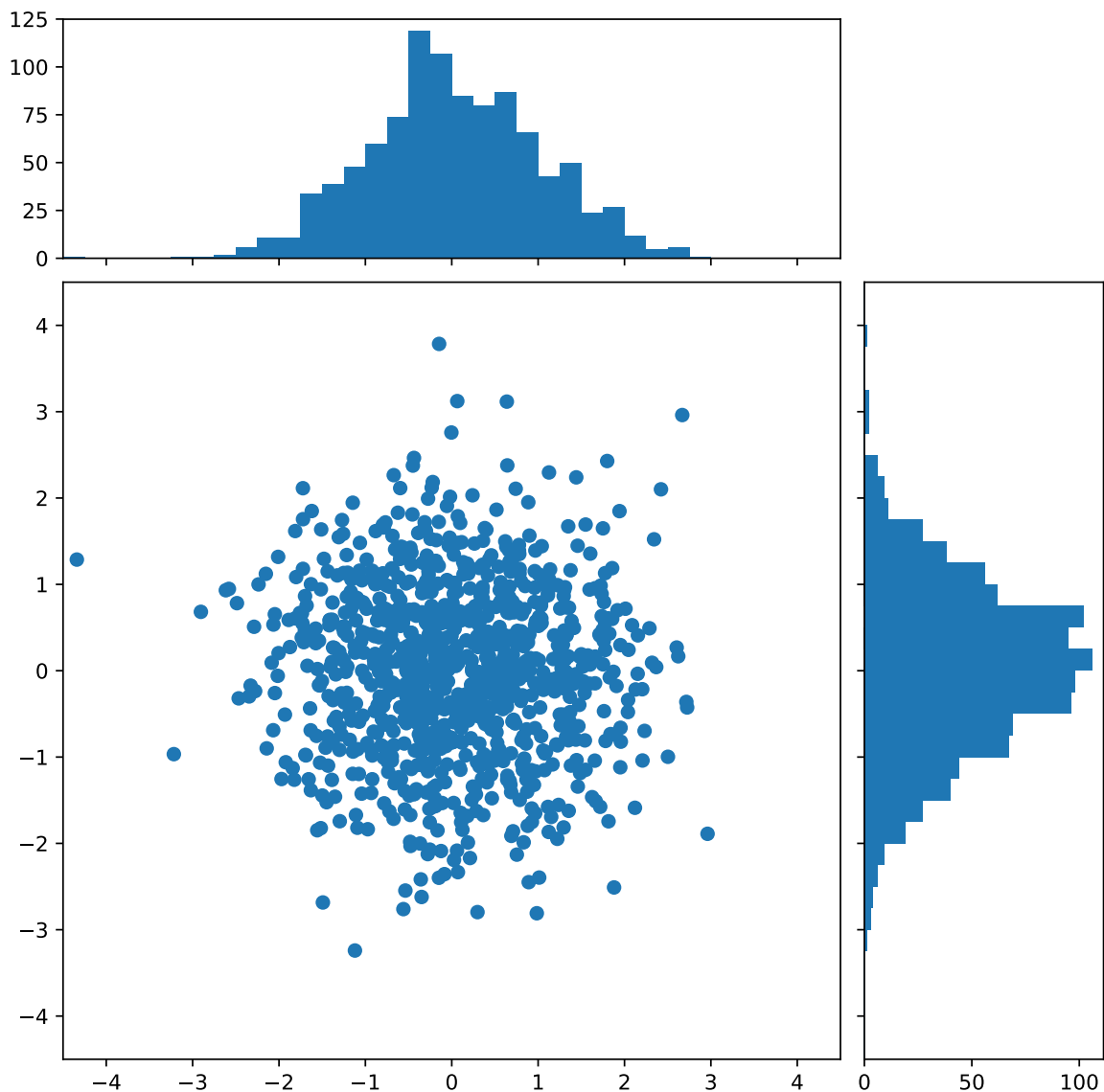

```
import numpy as np
import matplotlib.pyplot as plt
from matplotlib.ticker import NullFormatter

# the random data
x = np.random.randn(1000)
y = np.random.randn(1000)

nullfmt = NullFormatter()          # no labels
```

```
# definitions for the axes
left, width = 0.1, 0.65
bottom, height = 0.1, 0.65
bottom_h = left_h = left + width + 0.02

rect_scatter = [left, bottom, width, height]
rect_histx = [left, bottom_h, width, 0.2]
rect_histy = [left_h, bottom, 0.2, height]

# start with a rectangular Figure
plt.figure(1, figsize=(8, 8))

axScatter = plt.axes(rect_scatter)
axHistx = plt.axes(rect_histx)
axHisty = plt.axes(rect_histy)

# no labels
axHistx.xaxis.set_major_formatter(nullfmt)
axHisty.yaxis.set_major_formatter(nullfmt)

# the scatter plot:
axScatter.scatter(x, y)

# now determine nice limits by hand:
binwidth = 0.25
xymax = np.max([np.max(np.fabs(x)), np.max(np.fabs(y))])
lim = (int(xymax/binwidth) + 1) * binwidth

axScatter.set_xlim((-lim, lim))
axScatter.set_ylim((-lim, lim))

bins = np.arange(-lim, lim + binwidth, binwidth)
axHistx.hist(x, bins=bins)
axHisty.hist(y, bins=bins, orientation='horizontal')

axHistx.set_xlim(axScatter.get_xlim())
axHisty.set_ylim(axScatter.get_ylim())

plt.show()
```

Keywords: python, matplotlib, pylab, example, codex (see [Search examples](#))

99.161 pylab_examples example code: scatter_masked.py

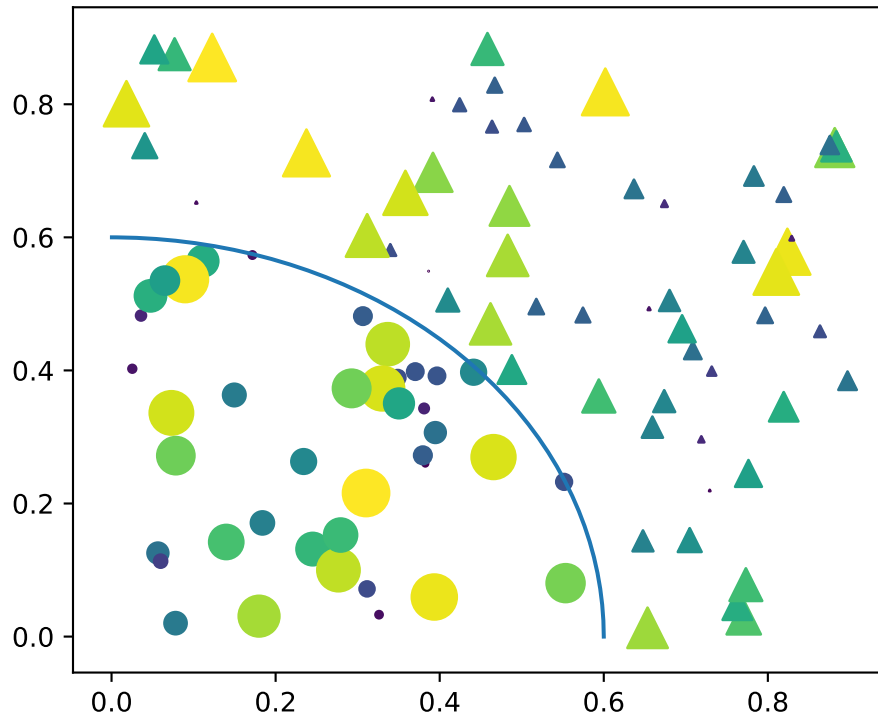

```
import matplotlib.pyplot as plt
import numpy as np

N = 100
r0 = 0.6
x = 0.9*np.random.rand(N)
y = 0.9*np.random.rand(N)
area = np.pi*(10 * np.random.rand(N))**2 # 0 to 10 point radii
c = np.sqrt(area)
r = np.sqrt(x*x + y*y)
area1 = np.ma.masked_where(r < r0, area)
area2 = np.ma.masked_where(r >= r0, area)
plt.scatter(x, y, s=area1, marker='^', c=c)
plt.scatter(x, y, s=area2, marker='o', c=c)
# Show the boundary between the regions:
theta = np.arange(0, np.pi/2, 0.01)
plt.plot(r0*np.cos(theta), r0*np.sin(theta))

plt.show()
```

Keywords: python, matplotlib, pylab, example, codex (see [Search examples](#))

99.162 pylab_examples example code: scatter_profile.py

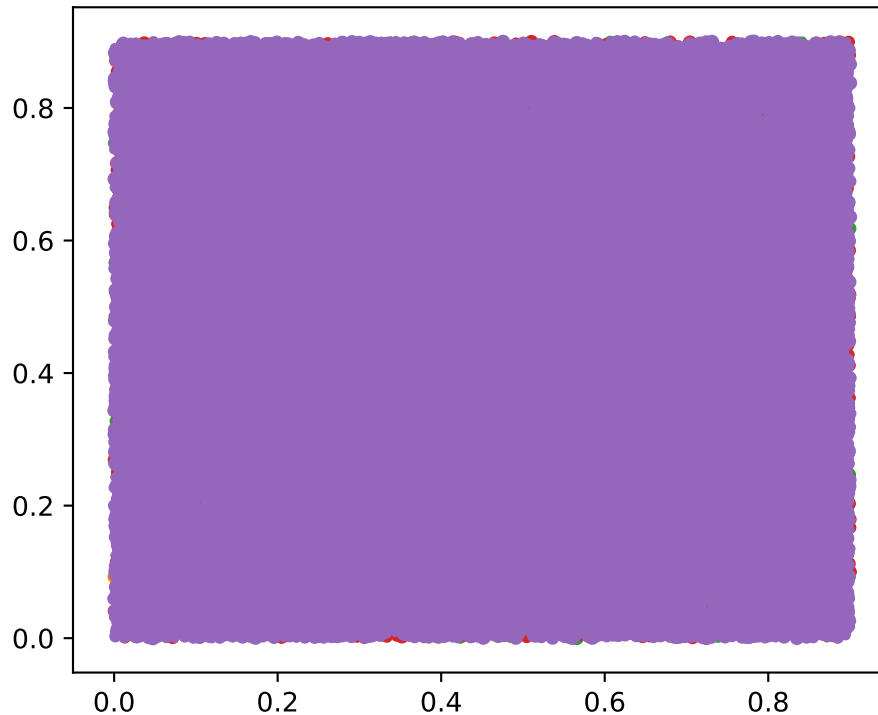

```

"""
N      Classic      Base renderer      Ext renderer
20     0.22         0.14              0.14
100    0.16         0.14              0.13
1000   0.45         0.26              0.17
10000  3.30         1.31              0.53
50000  19.30        6.53              1.98
"""
from __future__ import print_function # only needed for python 2.x
import matplotlib.pyplot as plt
import numpy as np

import time

for N in (20, 100, 1000, 10000, 50000):
    tstart = time.time()
    x = 0.9*np.random.rand(N)
    y = 0.9*np.random.rand(N)
    s = 20*np.random.rand(N)
    plt.scatter(x, y, s)
    print('%d symbols in %1.2f s' % (N, time.time() - tstart))

```

Keywords: python, matplotlib, pylab, example, codex (see [Search examples](#))

99.163 pylab_examples example code: scatter_star_poly.py

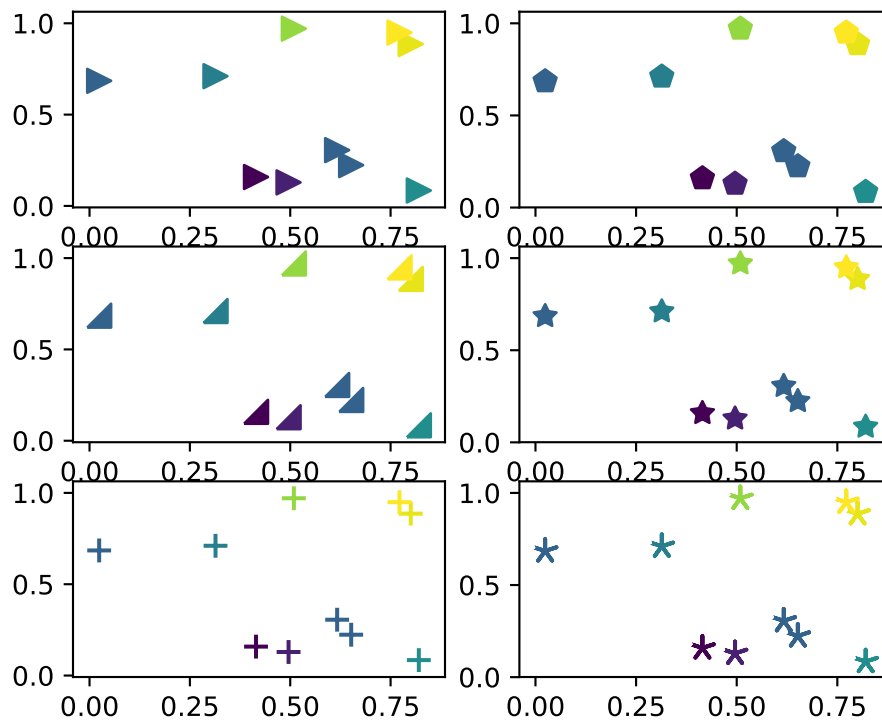

```
import numpy as np
import matplotlib.pyplot as plt

x = np.random.rand(10)
y = np.random.rand(10)
z = np.sqrt(x**2 + y**2)

plt.subplot(321)
plt.scatter(x, y, s=80, c=z, marker=">")

plt.subplot(322)
plt.scatter(x, y, s=80, c=z, marker=(5, 0))

verts = list(zip([-1., 1., 1., -1.], [-1., -1., 1., -1.]))
plt.subplot(323)
plt.scatter(x, y, s=80, c=z, marker=(verts, 0))
# equivalent:
#plt.scatter(x,y,s=80, c=z, marker=None, verts=verts)
```

```

plt.subplot(324)
plt.scatter(x, y, s=80, c=z, marker=(5, 1))

plt.subplot(325)
plt.scatter(x, y, s=80, c=z, marker='+')

plt.subplot(326)
plt.scatter(x, y, s=80, c=z, marker=(5, 2))

plt.show()

```

Keywords: python, matplotlib, pylab, example, codex (see [Search examples](#))

99.164 pylab_examples example code: scatter_symbol.py

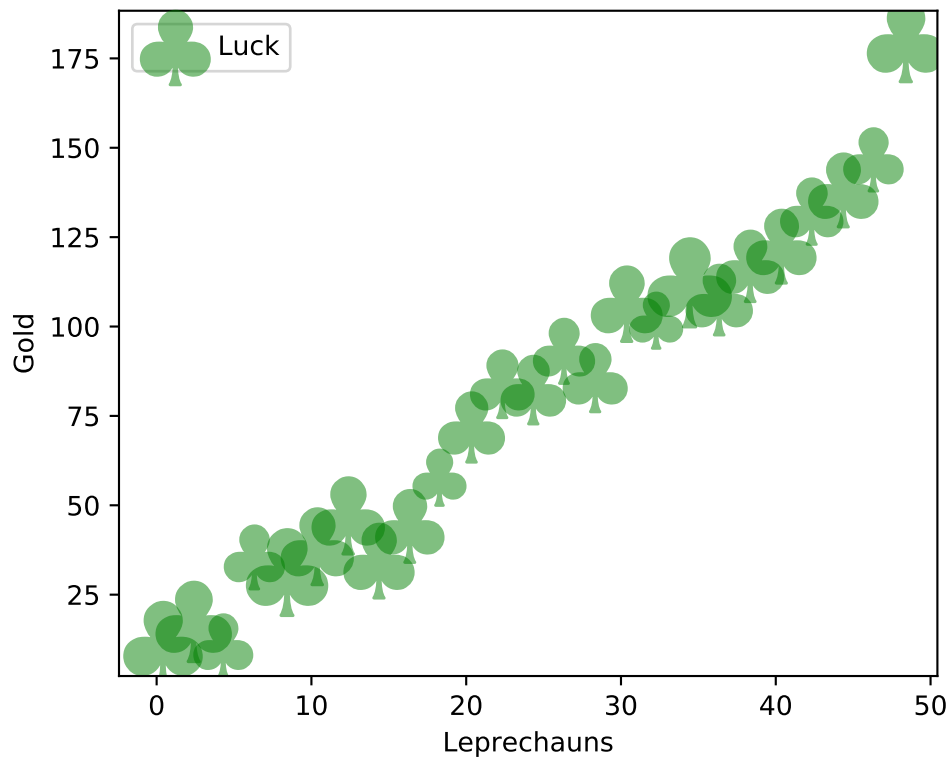

```

from matplotlib import pyplot as plt
import numpy as np
import matplotlib

x = np.arange(0.0, 50.0, 2.0)
y = x ** 1.3 + np.random.rand(*x.shape) * 30.0

```

```
s = np.random.rand(*x.shape) * 800 + 500

plt.scatter(x, y, s, c="g", alpha=0.5, marker=r'\clubsuit$',
            label="Luck")
plt.xlabel("Leprechauns")
plt.ylabel("Gold")
plt.legend(loc=2)
plt.show()
```

Keywords: python, matplotlib, pylab, example, codex (see *Search examples*)

99.165 pylab_examples example code: set_and_get.py

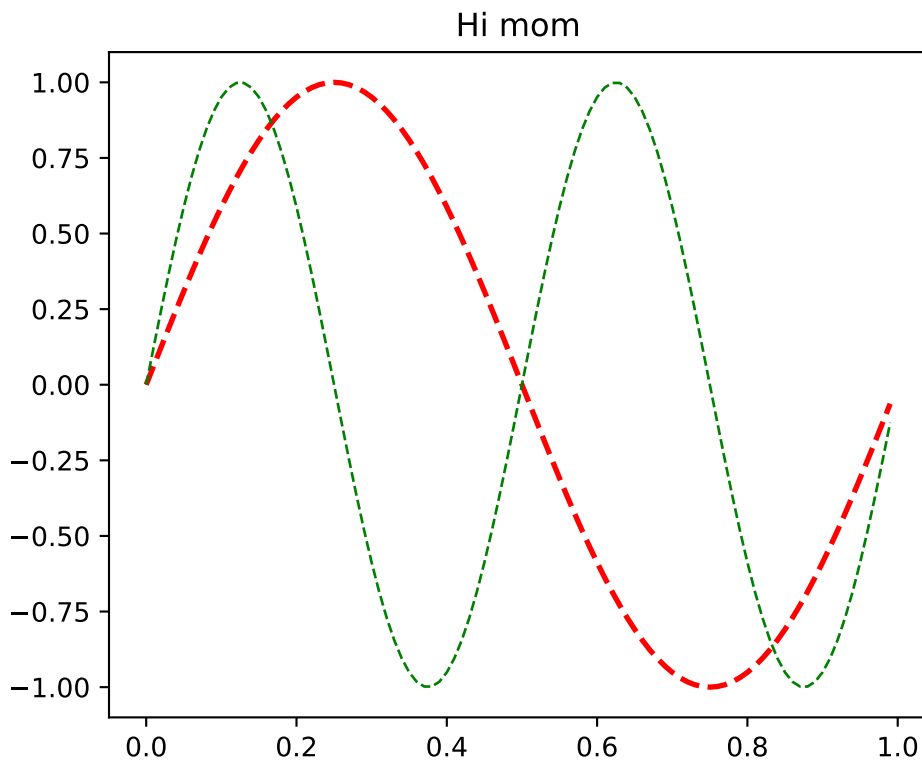

```
"""
```

The pyplot interface allows you to use `setp` and `getp` to set and get object properties, as well as to do introspection on the object

set:

To set the linestyle of a line to be dashed, you can do

```
>>> line, = plt.plot([1,2,3])
```



```
>>> plt.setp(line, linestyle='--')
```

If you want to know the valid types of arguments, you can provide the name of the property you want to set without a value

```
>>> plt.setp(line, 'linestyle')
linestyle: [ '-' | '--' | '-.' | ':' | 'steps' | 'None' ]
```

If you want to see all the properties that can be set, and their possible values, you can do

```
>>> plt.setp(line)
```

set operates on a single instance or a list of instances. If you are in query mode introspecting the possible values, only the first instance in the sequence is used. When actually setting values, all the instances will be set. e.g., suppose you have a list of two lines, the following will make both lines thicker and red

```
>>> x = np.arange(0,1.0,0.01)
>>> y1 = np.sin(2*np.pi*x)
>>> y2 = np.sin(4*np.pi*x)
>>> lines = plt.plot(x, y1, x, y2)
>>> plt.setp(lines, linewidth=2, color='r')
```

get:

get returns the value of a given attribute. You can use get to query the value of a single attribute

```
>>> plt.getp(line, 'linewidth')
0.5
```

or all the attribute/value pairs

```
>>> plt.getp(line)
aa = True
alpha = 1.0
antialiased = True
c = b
clip_on = True
color = b
... long listing skipped ...
```

Aliases:

To reduce keystrokes in interactive mode, a number of properties have short aliases, e.g., 'lw' for 'linewidth' and 'mec' for 'markeredgecolor'. When calling set or get in introspection mode, these properties will be listed as 'fullname or aliasname', as in

```
"""  
  
from __future__ import print_function  
  
import matplotlib.pyplot as plt  
import numpy as np  
  
x = np.arange(0, 1.0, 0.01)  
y1 = np.sin(2*np.pi*x)  
y2 = np.sin(4*np.pi*x)  
lines = plt.plot(x, y1, x, y2)  
l1, l2 = lines  
plt.setp(lines, linestyle='--') # set both to dashed  
plt.setp(l1, linewidth=2, color='r') # line1 is thick and red  
plt.setp(l2, linewidth=1, color='g') # line2 is thinner and green  
  
print('Line setters')  
plt.setp(l1)  
print('Line getters')  
plt.getp(l1)  
  
print('Rectangle setters')  
plt.setp(plt.gca().patch)  
print('Rectangle getters')  
plt.getp(plt.gca().patch)  
  
t = plt.title('Hi mom')  
print('Text setters')  
plt.setp(t)  
print('Text getters')  
plt.getp(t)  
  
plt.show()
```

Keywords: python, matplotlib, pylab, example, codex (see [Search examples](#))

99.166 pylab_examples example code: shading_example.py

HSV Blending Looks Best with Smooth Surfaces

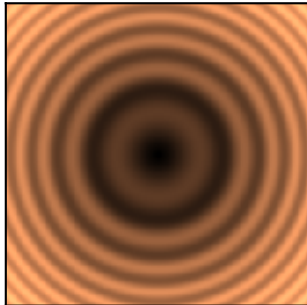

Colormapped Data

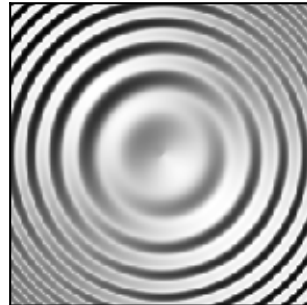

Illumination Intensity

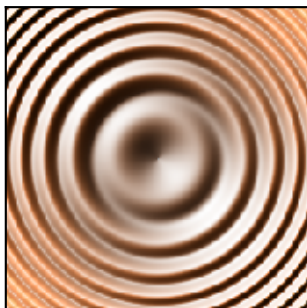

Blend Mode: "hsv" (default)

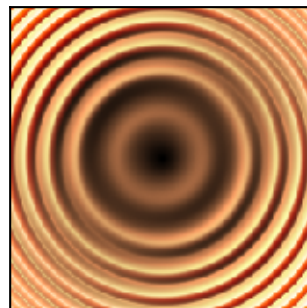

Blend Mode: "overlay"

Overlay Blending Looks Best with Rough Surfaces

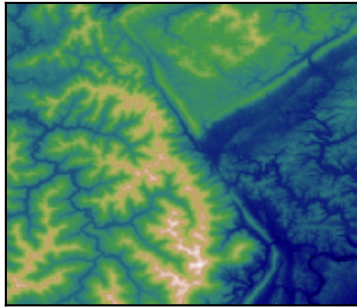

Colormapped Data

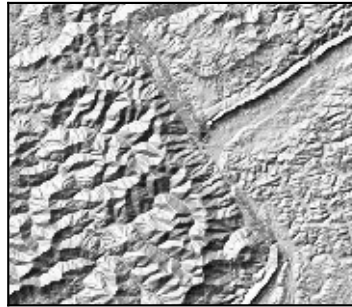

Illumination Intensity

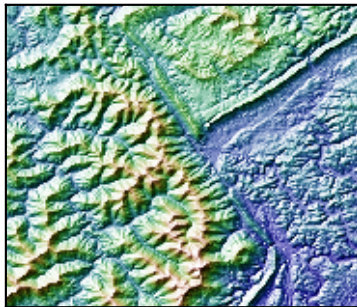

Blend Mode: "hsv" (default)

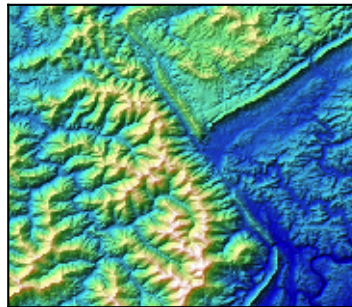

Blend Mode: "overlay"

```

import numpy as np
import matplotlib.pyplot as plt
from matplotlib.colors import LightSource
from matplotlib.cbook import get_sample_data

# Example showing how to make shaded relief plots
# like Mathematica
# (http://reference.wolfram.com/mathematica/ref/ReliefPlot.html)
# or Generic Mapping Tools
# (http://gmt.soest.hawaii.edu/gmt/doc/gmt/html/GMT_Docs/node145.html)

def main():
    # Test data
    x, y = np.mgrid[-5:5:0.05, -5:5:0.05]
    z = 5 * (np.sqrt(x**2 + y**2) + np.sin(x**2 + y**2))

    filename = get_sample_data('jacksboro_fault_dem.npz', asfileobj=False)
    with np.load(filename) as dem:
        elev = dem['elevation']

    fig = compare(z, plt.cm.copper)
    fig.suptitle('HSV Blending Looks Best with Smooth Surfaces', y=0.95)

    fig = compare(elev, plt.cm.gist_earth, ve=0.05)
    fig.suptitle('Overlay Blending Looks Best with Rough Surfaces', y=0.95)

```

```
plt.show()

def compare(z, cmap, ve=1):
    # Create subplots and hide ticks
    fig, axes = plt.subplots(ncols=2, nrows=2)
    for ax in axes.flat:
        ax.set(xticks=[], yticks=[])

    # Illuminate the scene from the northwest
    ls = LightSource(azdeg=315, altdeg=45)

    axes[0, 0].imshow(z, cmap=cmap)
    axes[0, 0].set(xlabel='Colormapped Data')

    axes[0, 1].imshow(ls.hillshade(z, vert_exag=ve), cmap='gray')
    axes[0, 1].set(xlabel='Illumination Intensity')

    rgb = ls.shade(z, cmap=cmap, vert_exag=ve, blend_mode='hsv')
    axes[1, 0].imshow(rgb)
    axes[1, 0].set(xlabel='Blend Mode: "hsv" (default)')

    rgb = ls.shade(z, cmap=cmap, vert_exag=ve, blend_mode='overlay')
    axes[1, 1].imshow(rgb)
    axes[1, 1].set(xlabel='Blend Mode: "overlay"')

    return fig

if __name__ == '__main__':
    main()
```

Keywords: python, matplotlib, pylab, example, codex (see [Search examples](#))

99.167 pylab_examples example code: shared_axis_across_figures.py

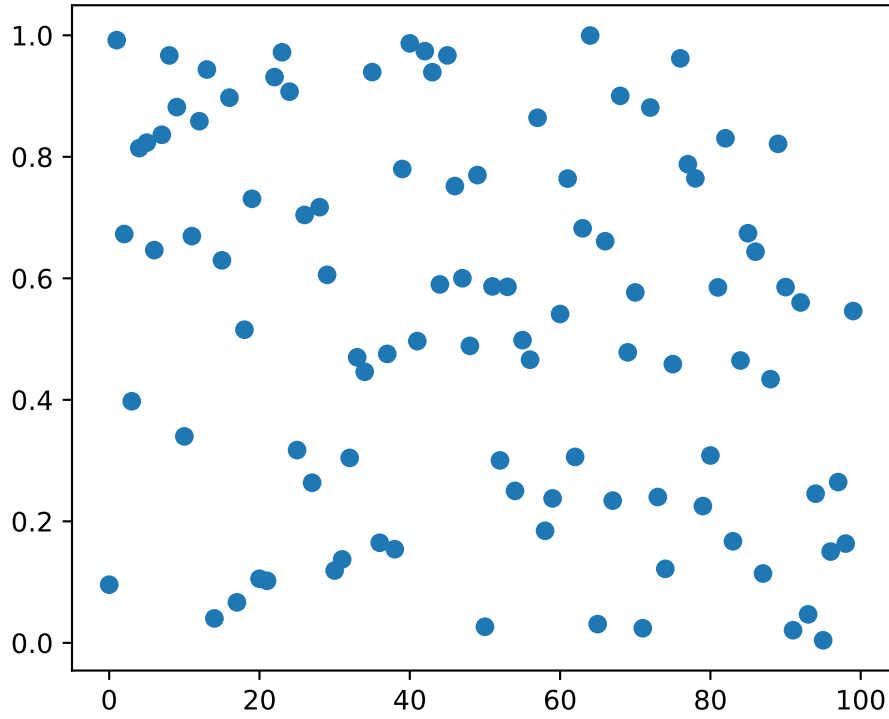

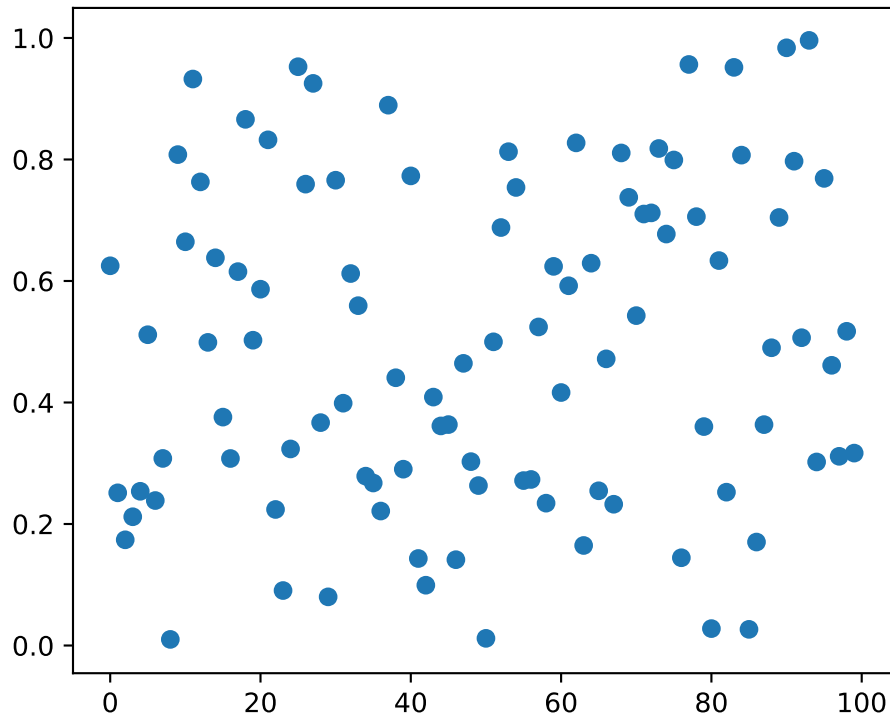

```

"""
connect the data limits on the axes in one figure with the axes in
another. This is not the right way to do this for two axes in the
same figure -- use the sharex and sharey property in that case
"""
import numpy as np
import matplotlib.pyplot as plt

fig1 = plt.figure()
fig2 = plt.figure()

ax1 = fig1.add_subplot(111)
ax2 = fig2.add_subplot(111, sharex=ax1, sharey=ax1)

ax1.plot(np.random.rand(100), 'o')
ax2.plot(np.random.rand(100), 'o')

# In the latest release, it is no longer necessary to do anything
# special to share axes across figures:

# ax1.sharex_foreign(ax2)
# ax2.sharex_foreign(ax1)

# ax1.sharey_foreign(ax2)
# ax2.sharey_foreign(ax1)

```

```
plt.show()
```

Keywords: python, matplotlib, pylab, example, codex (see *Search examples*)

99.168 pylab_examples example code: shared_axis_demo.py

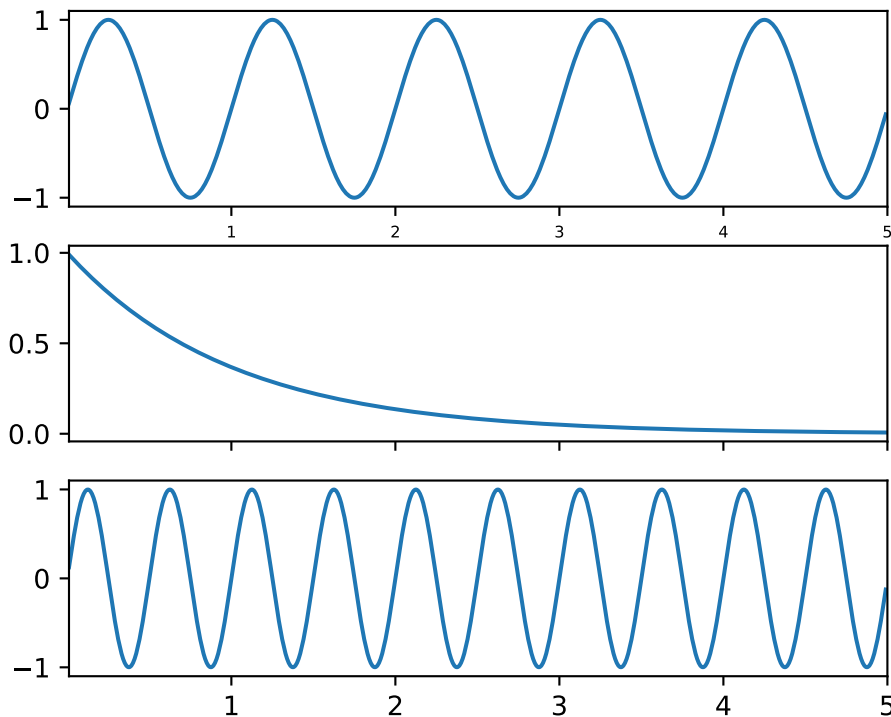

```
"""
```

You can share the x or y axis limits for one axis with another by passing an axes instance as a sharex or sharey kwarg.

Changing the axis limits on one axes will be reflected automatically in the other, and vice-versa, so when you navigate with the toolbar the axes will follow each other on their shared axes. Ditto for changes in the axis scaling (e.g., log vs linear). However, it is possible to have differences in tick labeling, e.g., you can selectively turn off the tick labels on one axes.

The example below shows how to customize the tick labels on the various axes. Shared axes share the tick locator, tick formatter, view limits, and transformation (e.g., log, linear). But the ticklabels themselves do not share properties. This is a feature and not a bug, because you may want to make the tick labels smaller on the upper

axes, e.g., in the example below.

If you want to turn off the ticklabels for a given axes (e.g., on `subplot(211)` or `subplot(212)`, you cannot do the standard trick

```
setp(ax2, xticklabels=[])
```

because this changes the tick Formatter, which is shared among all axes. But you can alter the visibility of the labels, which is a property

```
setp(ax2.get_xticklabels(), visible=False)
```

```
"""
```

```
import matplotlib.pyplot as plt
import numpy as np
```

```
t = np.arange(0.01, 5.0, 0.01)
s1 = np.sin(2*np.pi*t)
s2 = np.exp(-t)
s3 = np.sin(4*np.pi*t)
```

```
ax1 = plt.subplot(311)
plt.plot(t, s1)
plt.setp(ax1.get_xticklabels(), fontsize=6)
```

```
# share x only
ax2 = plt.subplot(312, sharex=ax1)
plt.plot(t, s2)
# make these tick labels invisible
plt.setp(ax2.get_xticklabels(), visible=False)
```

```
# share x and y
ax3 = plt.subplot(313, sharex=ax1, sharey=ax1)
plt.plot(t, s3)
plt.xlim(0.01, 5.0)
plt.show()
```

Keywords: python, matplotlib, pylab, example, codex (see [Search examples](#))

99.169 pylab_examples example code: simple_plot.py

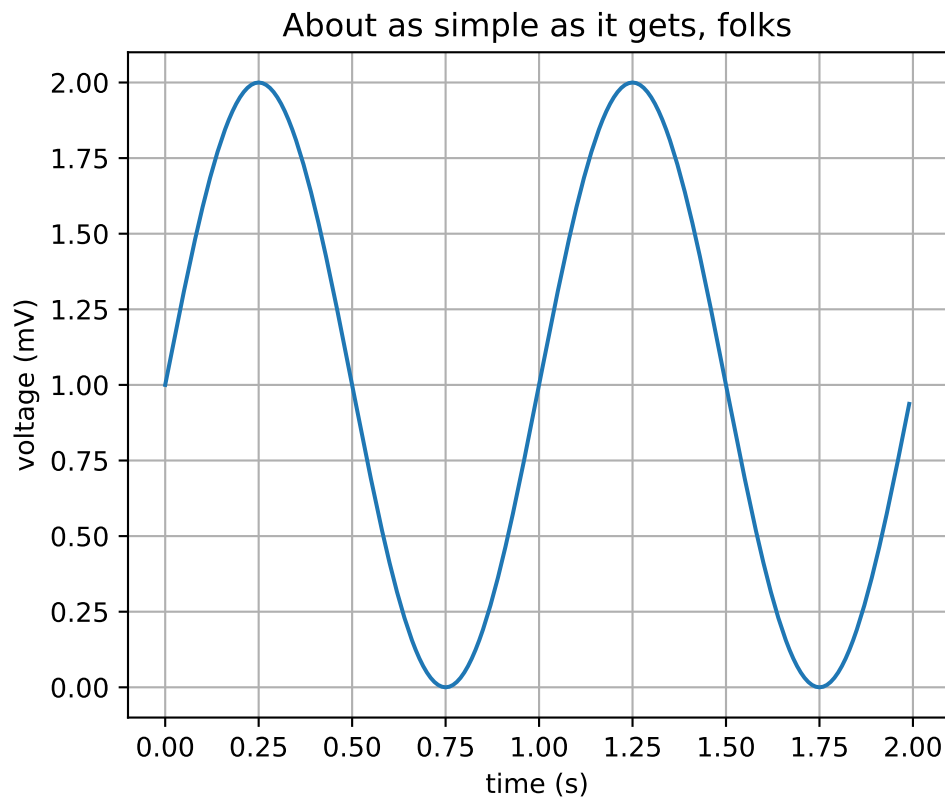

```
import matplotlib.pyplot as plt
import numpy as np

t = np.arange(0.0, 2.0, 0.01)
s = 1 + np.sin(2*np.pi*t)
plt.plot(t, s)

plt.xlabel('time (s)')
plt.ylabel('voltage (mV)')
plt.title('About as simple as it gets, folks')
plt.grid(True)
plt.savefig("test.png")
plt.show()
```

Keywords: python, matplotlib, pylab, example, codex (see [Search examples](#))

99.170 pylab_examples example code: specgram_demo.py

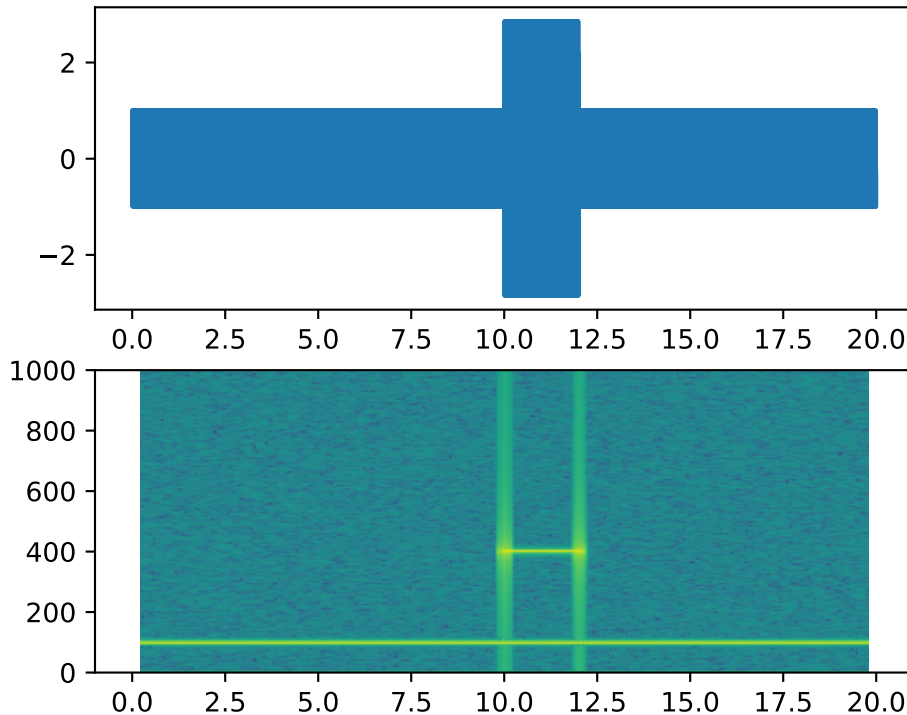

```

import matplotlib.pyplot as plt
import numpy as np

dt = 0.0005
t = np.arange(0.0, 20.0, dt)
s1 = np.sin(2*np.pi*100*t)
s2 = 2*np.sin(2*np.pi*400*t)

# create a transient "chirp"
mask = np.where(np.logical_and(t > 10, t < 12), 1.0, 0.0)
s2 = s2 * mask

# add some noise into the mix
nse = 0.01*np.random.random(size=len(t))

x = s1 + s2 + nse # the signal
NFFT = 1024      # the length of the windowing segments
Fs = int(1.0/dt) # the sampling frequency

# Pxx is the segments x freqs array of instantaneous power, freqs is
# the frequency vector, bins are the centers of the time bins in which
# the power is computed, and im is the matplotlib.image.AxesImage

```

```
# instance

ax1 = plt.subplot(211)
plt.plot(t, x)
plt.subplot(212, sharex=ax1)
Pxx, freqs, bins, im = plt.specgram(x, NFFT=NFFT, Fs=Fs, noverlap=900)
plt.show()
```

Keywords: python, matplotlib, pylab, example, codex (see [Search examples](#))

99.171 pylab_examples example code: spectrum_demo.py

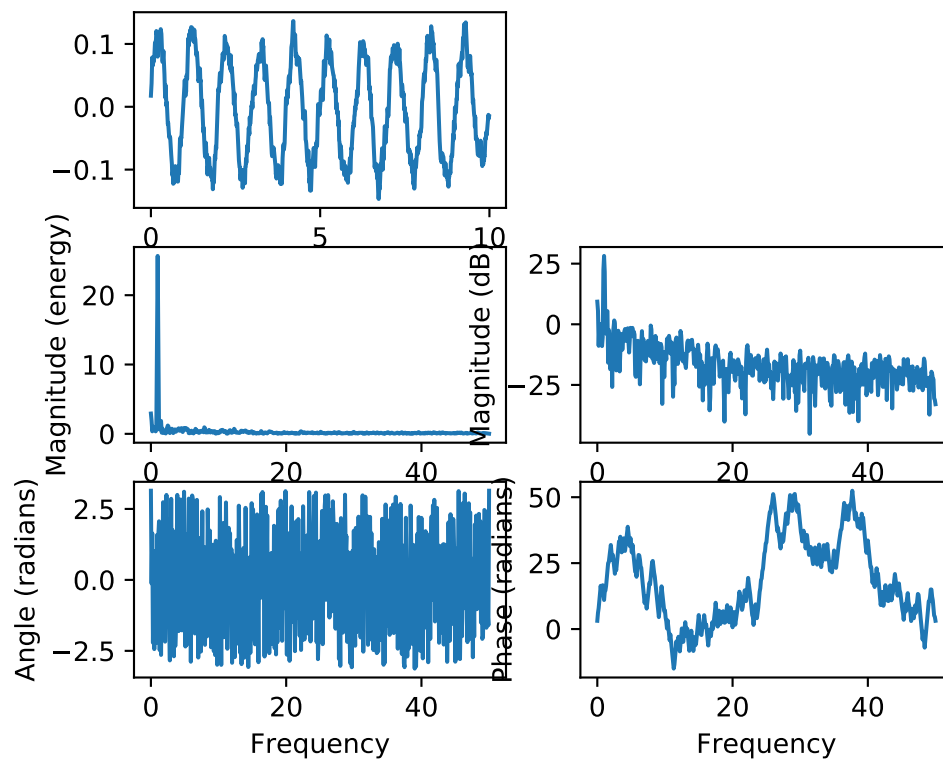

```
import matplotlib.pyplot as plt
import numpy as np

np.random.seed(0)

dt = 0.01
Fs = 1/dt
t = np.arange(0, 10, dt)
nse = np.random.randn(len(t))
```

```
r = np.exp(-t/0.05)

cnse = np.convolve(nse, r)*dt
cnse = cnse[:len(t)]
s = 0.1*np.sin(2*np.pi*t) + cnse

plt.subplot(3, 2, 1)
plt.plot(t, s)

plt.subplot(3, 2, 3)
plt.magnitude_spectrum(s, Fs=Fs)

plt.subplot(3, 2, 4)
plt.magnitude_spectrum(s, Fs=Fs, scale='dB')

plt.subplot(3, 2, 5)
plt.angle_spectrum(s, Fs=Fs)

plt.subplot(3, 2, 6)
plt.phase_spectrum(s, Fs=Fs)

plt.show()
```

Keywords: python, matplotlib, pylab, example, codex (see [Search examples](#))

99.172 pylab_examples example code: spine_placement_demo.py

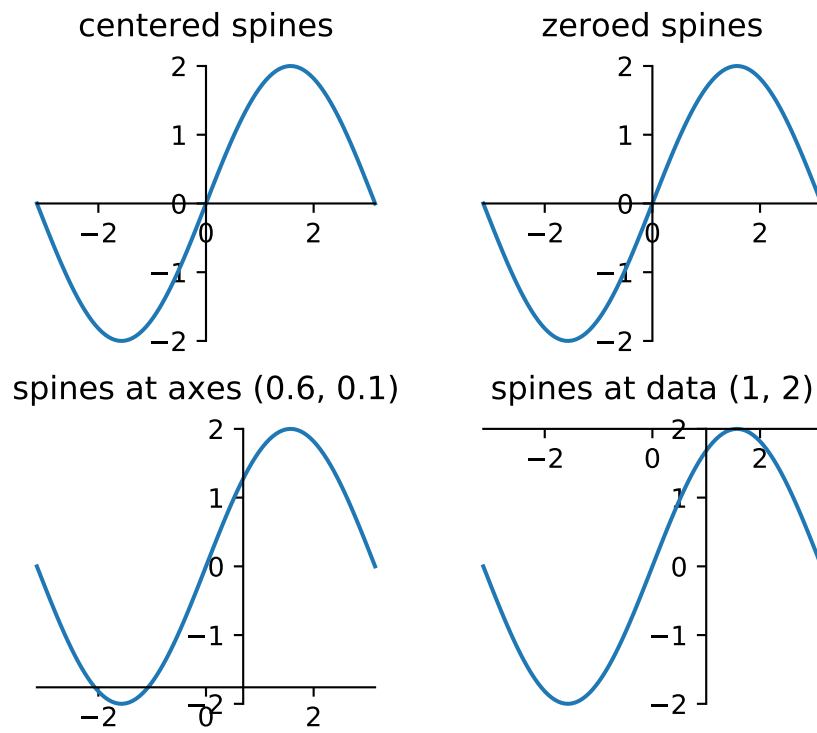

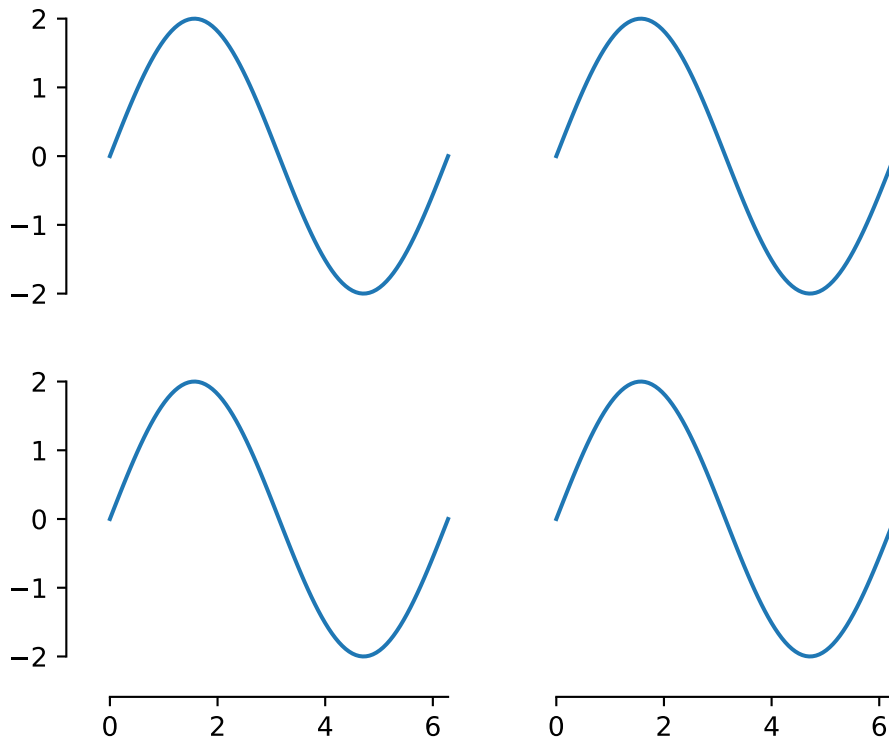

```

import numpy as np
import matplotlib.pyplot as plt

fig = plt.figure()
x = np.linspace(-np.pi, np.pi, 100)
y = 2*np.sin(x)

ax = fig.add_subplot(2, 2, 1)
ax.set_title('centered spines')
ax.plot(x, y)
ax.spines['left'].set_position('center')
ax.spines['right'].set_color('none')
ax.spines['bottom'].set_position('center')
ax.spines['top'].set_color('none')
ax.spines['left'].set_smart_bounds(True)
ax.spines['bottom'].set_smart_bounds(True)
ax.xaxis.set_ticks_position('bottom')
ax.yaxis.set_ticks_position('left')

ax = fig.add_subplot(2, 2, 2)
ax.set_title('zeroed spines')
ax.plot(x, y)
ax.spines['left'].set_position('zero')
ax.spines['right'].set_color('none')
ax.spines['bottom'].set_position('zero')

```

```

ax.spines['top'].set_color('none')
ax.spines['left'].set_smart_bounds(True)
ax.spines['bottom'].set_smart_bounds(True)
ax.xaxis.set_ticks_position('bottom')
ax.yaxis.set_ticks_position('left')

ax = fig.add_subplot(2, 2, 3)
ax.set_title('spines at axes (0.6, 0.1)')
ax.plot(x, y)
ax.spines['left'].set_position(('axes', 0.6))
ax.spines['right'].set_color('none')
ax.spines['bottom'].set_position(('axes', 0.1))
ax.spines['top'].set_color('none')
ax.spines['left'].set_smart_bounds(True)
ax.spines['bottom'].set_smart_bounds(True)
ax.xaxis.set_ticks_position('bottom')
ax.yaxis.set_ticks_position('left')

ax = fig.add_subplot(2, 2, 4)
ax.set_title('spines at data (1, 2)')
ax.plot(x, y)
ax.spines['left'].set_position(('data', 1))
ax.spines['right'].set_color('none')
ax.spines['bottom'].set_position(('data', 2))
ax.spines['top'].set_color('none')
ax.spines['left'].set_smart_bounds(True)
ax.spines['bottom'].set_smart_bounds(True)
ax.xaxis.set_ticks_position('bottom')
ax.yaxis.set_ticks_position('left')
# -----

def adjust_spines(ax, spines):
    for loc, spine in ax.spines.items():
        if loc in spines:
            spine.set_position(('outward', 10)) # outward by 10 points
            spine.set_smart_bounds(True)
        else:
            spine.set_color('none') # don't draw spine

    # turn off ticks where there is no spine
    if 'left' in spines:
        ax.yaxis.set_ticks_position('left')
    else:
        # no yaxis ticks
        ax.yaxis.set_ticks([])

    if 'bottom' in spines:
        ax.xaxis.set_ticks_position('bottom')
    else:
        # no xaxis ticks
        ax.xaxis.set_ticks([])

```



```
fig = plt.figure()

x = np.linspace(0, 2*np.pi, 100)
y = 2*np.sin(x)

ax = fig.add_subplot(2, 2, 1)
ax.plot(x, y, clip_on=False)
adjust_spines(ax, ['left'])

ax = fig.add_subplot(2, 2, 2)
ax.plot(x, y, clip_on=False)
adjust_spines(ax, [])

ax = fig.add_subplot(2, 2, 3)
ax.plot(x, y, clip_on=False)
adjust_spines(ax, ['left', 'bottom'])

ax = fig.add_subplot(2, 2, 4)
ax.plot(x, y, clip_on=False)
adjust_spines(ax, ['bottom'])

plt.show()
```

Keywords: python, matplotlib, pylab, example, codex (see [Search examples](#))

99.173 pylab_examples example code: spy_demos.py

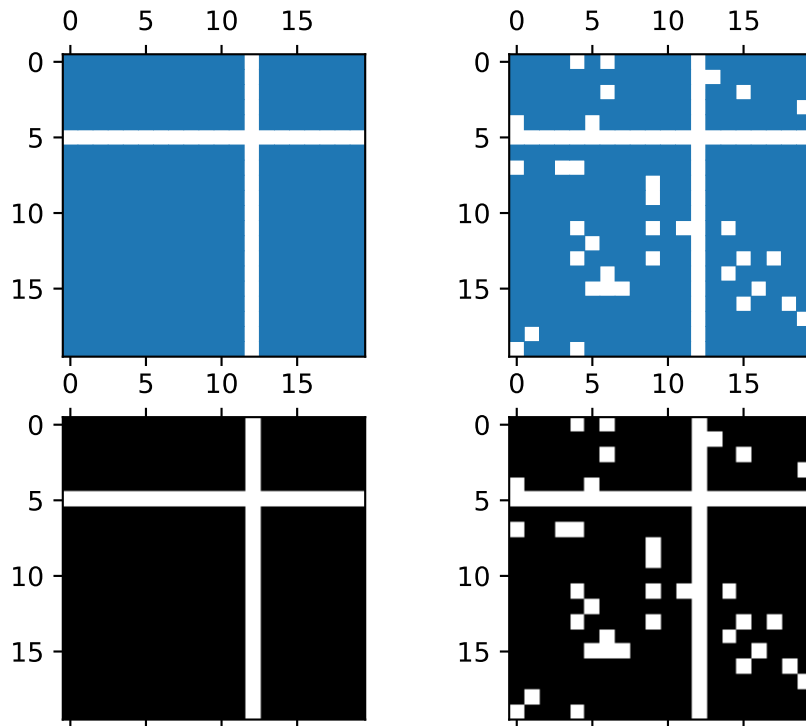

```

"""
Plot the sparsity pattern of arrays
"""

from matplotlib.pyplot import figure, show
import numpy

fig = figure()
ax1 = fig.add_subplot(221)
ax2 = fig.add_subplot(222)
ax3 = fig.add_subplot(223)
ax4 = fig.add_subplot(224)

x = numpy.random.randn(20, 20)
x[5] = 0.
x[:, 12] = 0.

ax1.spy(x, markersize=5)
ax2.spy(x, precision=0.1, markersize=5)

ax3.spy(x)
ax4.spy(x, precision=0.1)

```

```
show()
```

Keywords: python, matplotlib, pylab, example, codex (see [Search examples](#))

99.174 pylab_examples example code: stackplot_demo.py

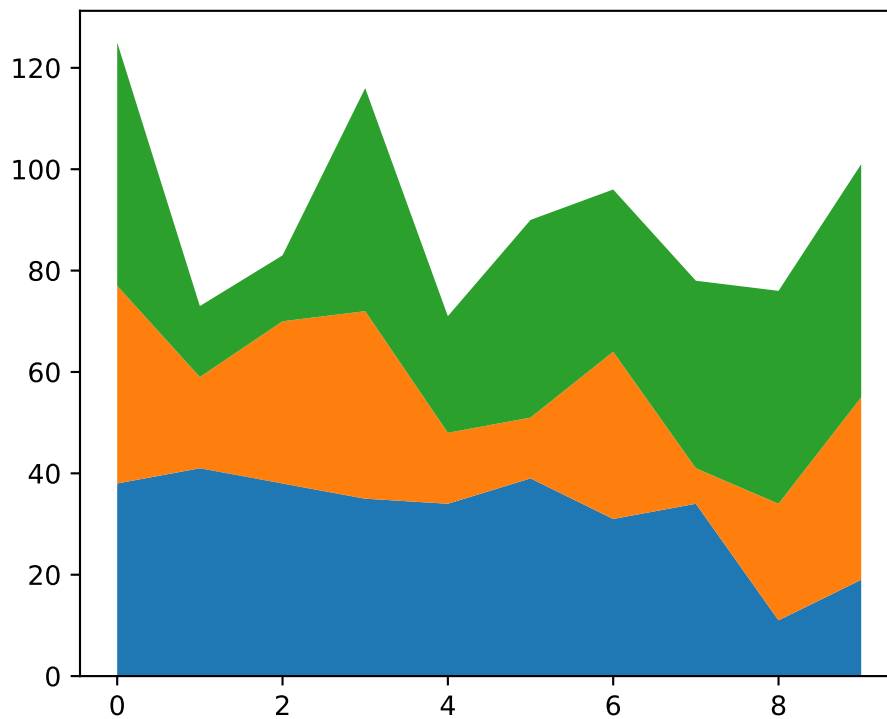

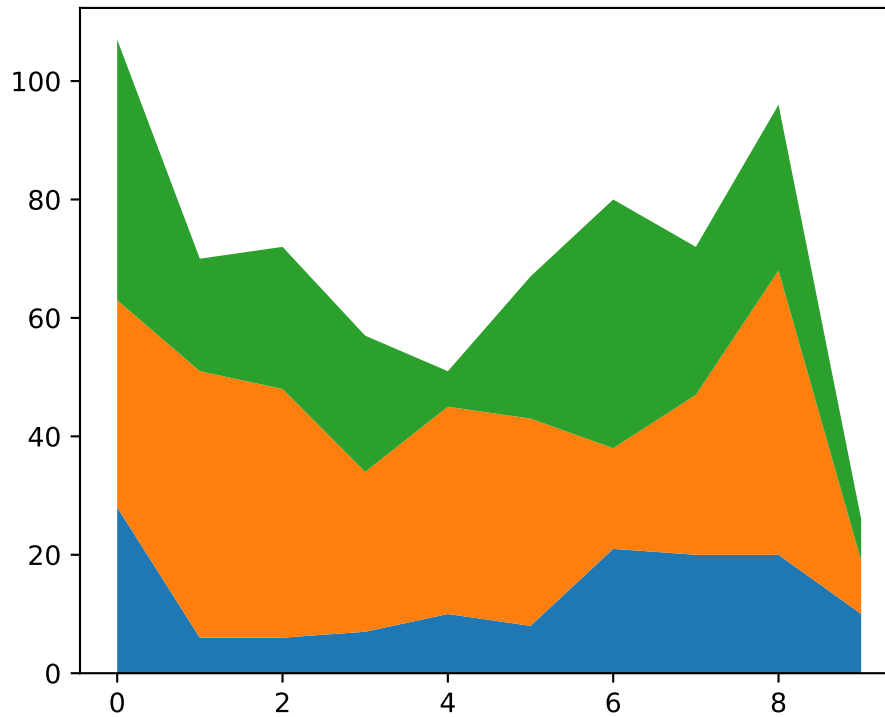

```
import numpy as np
import matplotlib.pyplot as plt

def fnx():
    return np.random.randint(5, 50, 10)

y = np.row_stack((fnx(), fnx(), fnx()))
x = np.arange(10)

y1, y2, y3 = fnx(), fnx(), fnx()

fig, ax = plt.subplots()
ax.stackplot(x, y)
plt.show()

fig, ax = plt.subplots()
ax.stackplot(x, y1, y2, y3)
plt.show()
```

Keywords: python, matplotlib, pylab, example, codex (see [Search examples](#))

99.175 pylab_examples example code: stackplot_demo2.py

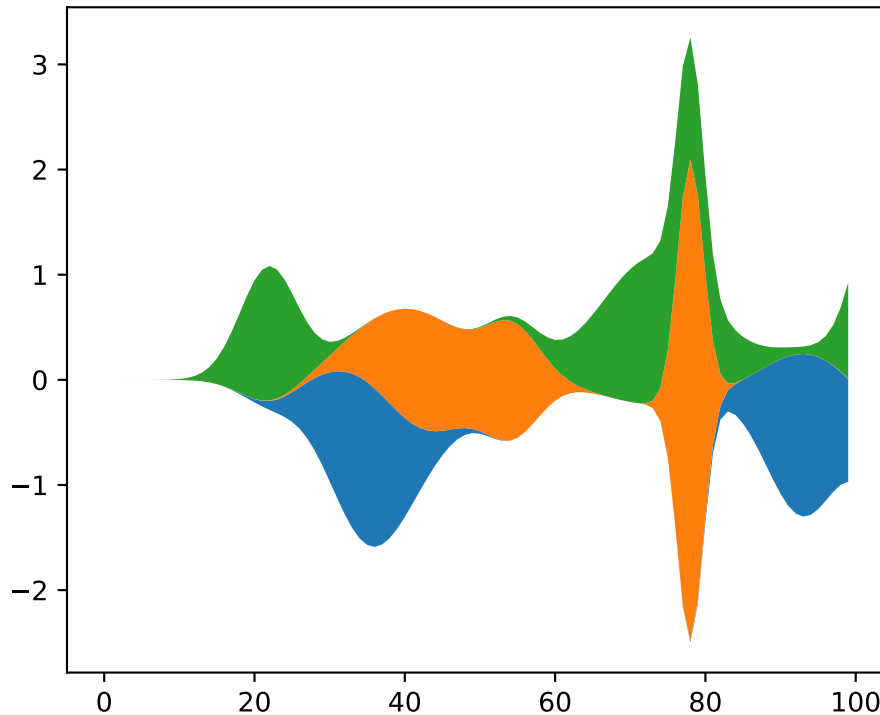

```
import numpy as np
import matplotlib.pyplot as plt

np.random.seed(0)

def layers(n, m):
    """
    Return *n* random Gaussian mixtures, each of length *m*.
    """
    def bump(a):
        x = 1 / (.1 + np.random.random())
        y = 2 * np.random.random() - .5
        z = 10 / (.1 + np.random.random())
        for i in range(m):
            w = (i / float(m) - y) * z
            a[i] += x * np.exp(-w * w)
    a = np.zeros((m, n))
    for i in range(n):
        for j in range(5):
            bump(a[:, i])
    return a
```

```
d = layers(3, 100)

plt.subplots()
plt.stackplot(range(100), d.T, baseline='wiggle')
plt.show()
```

Keywords: python, matplotlib, pylab, example, codex (see [Search examples](#))

99.176 pylab_examples example code: stem_plot.py

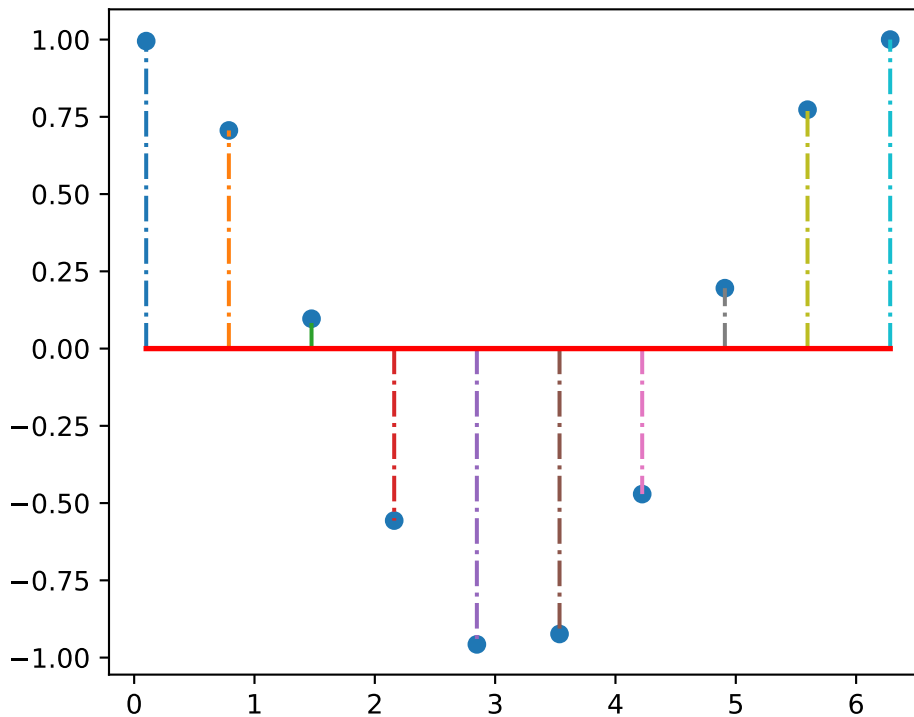

```
import matplotlib.pyplot as plt
import numpy as np

x = np.linspace(0.1, 2*np.pi, 10)
markerline, stemlines, baseline = plt.stem(x, np.cos(x), '-.')
plt.setp(baseline, 'color', 'r', 'linewidth', 2)

plt.show()
```

Keywords: python, matplotlib, pylab, example, codex (see [Search examples](#))

99.177 pylab_examples example code: step_demo.py

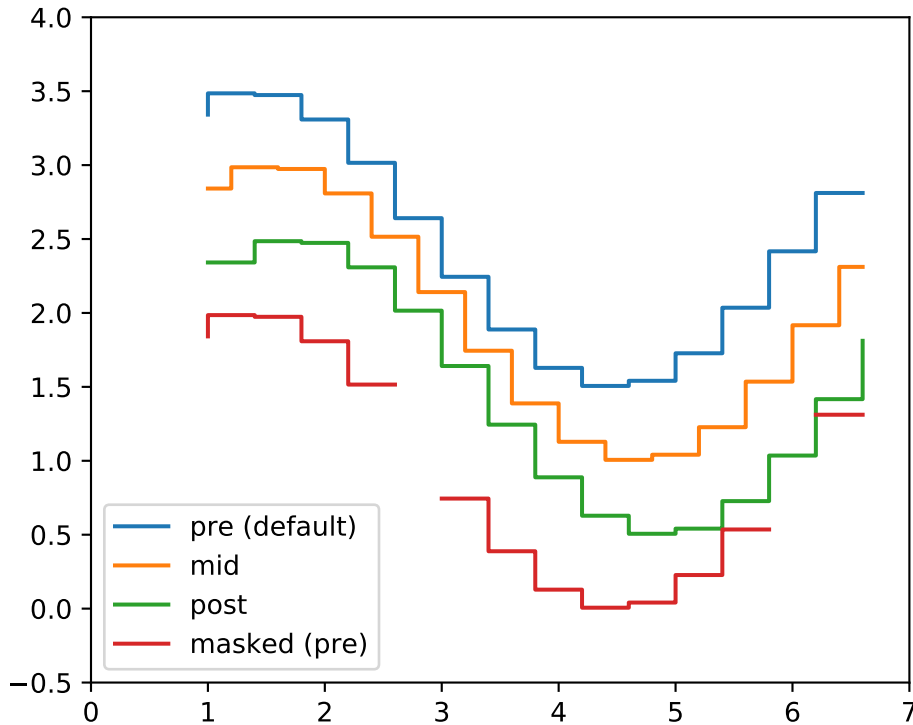

```
import numpy as np
from numpy import ma
import matplotlib.pyplot as plt

x = np.arange(1, 7, 0.4)
y0 = np.sin(x)
y = y0.copy() + 2.5

plt.step(x, y, label='pre (default)')

y -= 0.5
plt.step(x, y, where='mid', label='mid')

y += 0.5
plt.step(x, y, where='post', label='post')

y = ma.masked_where((y0 > -0.15) & (y0 < 0.15), y - 0.5)
plt.step(x, y, label='masked (pre)')

plt.legend()

plt.xlim(0, 7)
```

```
plt.ylim(-0.5, 4)
plt.show()
```

Keywords: python, matplotlib, pylab, example, codex (see [Search examples](#))

99.178 pylab_examples example code: stix_fonts_demo.py



```

from __future__ import unicode_literals

import os
import sys
import re
import gc
import matplotlib.pyplot as plt
import numpy as np

stests = [
    r'$\mathrm{\mathcircled{123}}$',
    r' \mathbf{\mathcircled{123}}$',
    r'$\mathsf{Sans \Omega} \mathrm{\mathsf{Sans \Omega}}$',
    r' \mathbf{\mathsf{Sans \Omega}}$',
    r'$\mathtt{Monospace}$',
    r'$\mathcal{CALLIGRAPHIC}$',
    r'$\mathbb{Blackboard \pi}$',
    r'$\mathrm{\mathbb{Blackboard \pi}}$',
    r'$\mathbf{\mathbb{Blackboard \pi}}$',
    r'$\mathfrak{Fraktur} \mathbf{\mathfrak{Fraktur}}$',
    r'$\mathscr{Script}$']

if sys.maxunicode > 0xffff:
    s = r'Direct Unicode: $\u23ce \mathrm{\ue0f2 \U0001D538}$'

def doall():
    tests = stests

    plt.figure(figsize=(8, (len(tests) * 1) + 2))
    plt.plot([0, 0], 'r')
    plt.grid(False)
    plt.axis([0, 3, -len(tests), 0])
    plt.yticks(np.arange(len(tests)) * -1)
    for i, s in enumerate(tests):
        plt.text(0.1, -i, s, fontsize=32)

    plt.savefig('stix_fonts_example')
    plt.show()

if '--latex' in sys.argv:
    fd = open("stix_fonts_examples.ltx", "w")
    fd.write("\documentclass{article}\n")
    fd.write("\begin{document}\n")
    fd.write("\begin{enumerate}\n")

    for i, s in enumerate(stests):
        s = re.sub(r"(?!\\)\$", "$$", s)
        fd.write("\item %s\n" % s)

    fd.write("\end{enumerate}\n")
    fd.write("\end{document}\n")

```

```

fd.close()

os.system("pdflatex stix_fonts_examples.ltx")
else:
doall()

```

Keywords: python, matplotlib, pylab, example, codex (see [Search examples](#))

99.179 pylab_examples example code: subplot_demo.py

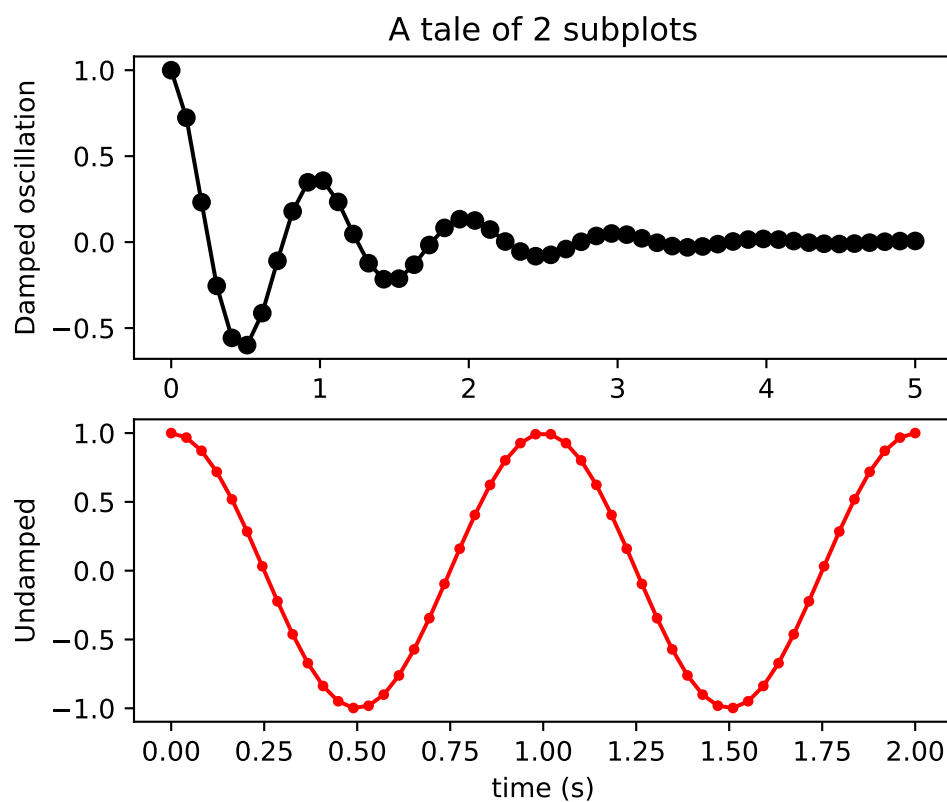

```

"""
Simple demo with multiple subplots.
"""
import numpy as np
import matplotlib.pyplot as plt

x1 = np.linspace(0.0, 5.0)
x2 = np.linspace(0.0, 2.0)

y1 = np.cos(2 * np.pi * x1) * np.exp(-x1)
y2 = np.cos(2 * np.pi * x2)

```

```
plt.subplot(2, 1, 1)
plt.plot(x1, y1, 'ko-')
plt.title('A tale of 2 subplots')
plt.ylabel('Damped oscillation')

plt.subplot(2, 1, 2)
plt.plot(x2, y2, 'r.-')
plt.xlabel('time (s)')
plt.ylabel('Undamped')

plt.show()
```

Keywords: python, matplotlib, pylab, example, codex (see [Search examples](#))

99.180 pylab_examples example code: subplot_toolbar.py

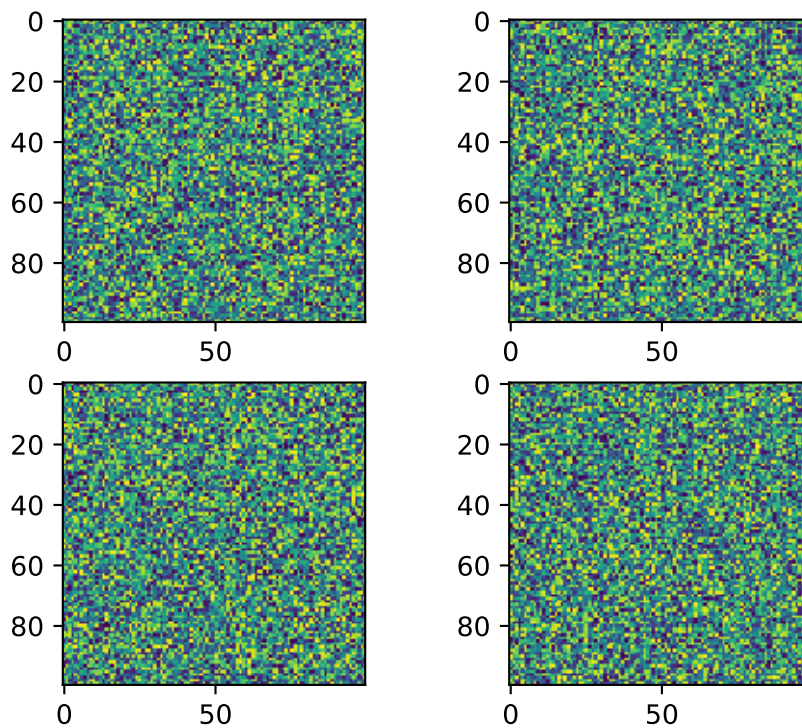

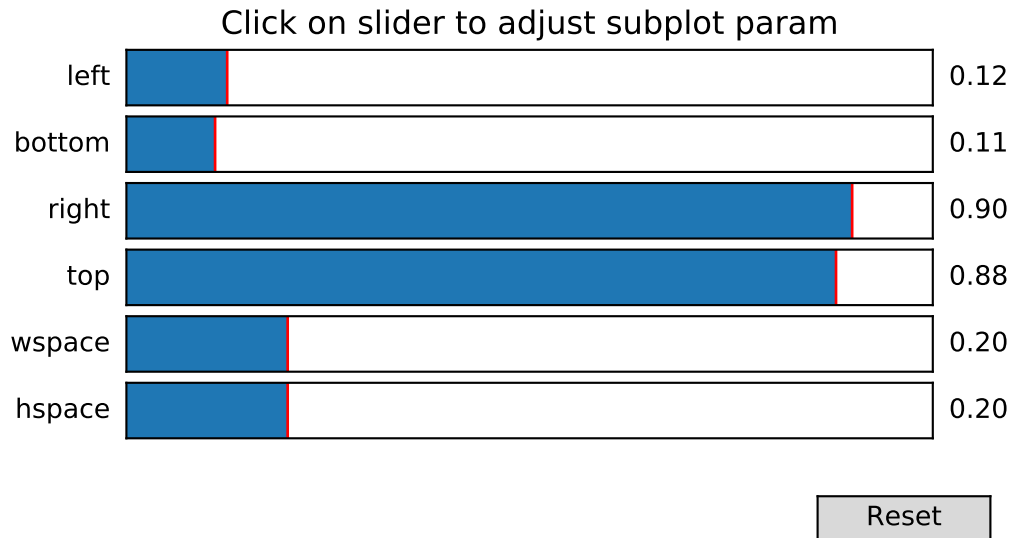

```
import matplotlib.pyplot as plt
import numpy.random as rnd

fig = plt.figure()
plt.subplot(221)
plt.imshow(rnd.random((100, 100)))
plt.subplot(222)
plt.imshow(rnd.random((100, 100)))
plt.subplot(223)
plt.imshow(rnd.random((100, 100)))
plt.subplot(224)
plt.imshow(rnd.random((100, 100)))

plt.subplot_tool()
plt.show()
```

Keywords: python, matplotlib, pylab, example, codex (see [Search examples](#))

99.181 pylab_examples example code: subplots_adjust.py

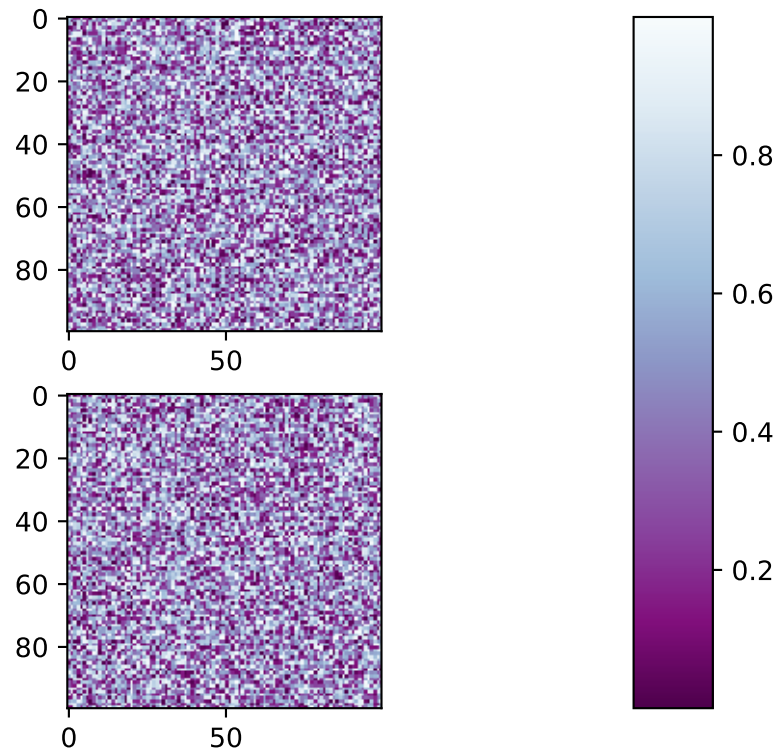

```
import matplotlib.pyplot as plt
import numpy as np

plt.subplot(211)
plt.imshow(np.random.random((100, 100)), cmap=plt.cm.BuPu_r)
plt.subplot(212)
plt.imshow(np.random.random((100, 100)), cmap=plt.cm.BuPu_r)

plt.subplots_adjust(bottom=0.1, right=0.8, top=0.9)
cax = plt.axes([0.85, 0.1, 0.075, 0.8])
plt.colorbar(cax=cax)
plt.show()
```

Keywords: python, matplotlib, pylab, example, codex (see [Search examples](#))

99.182 pylab_examples example code: subplots_demo.py

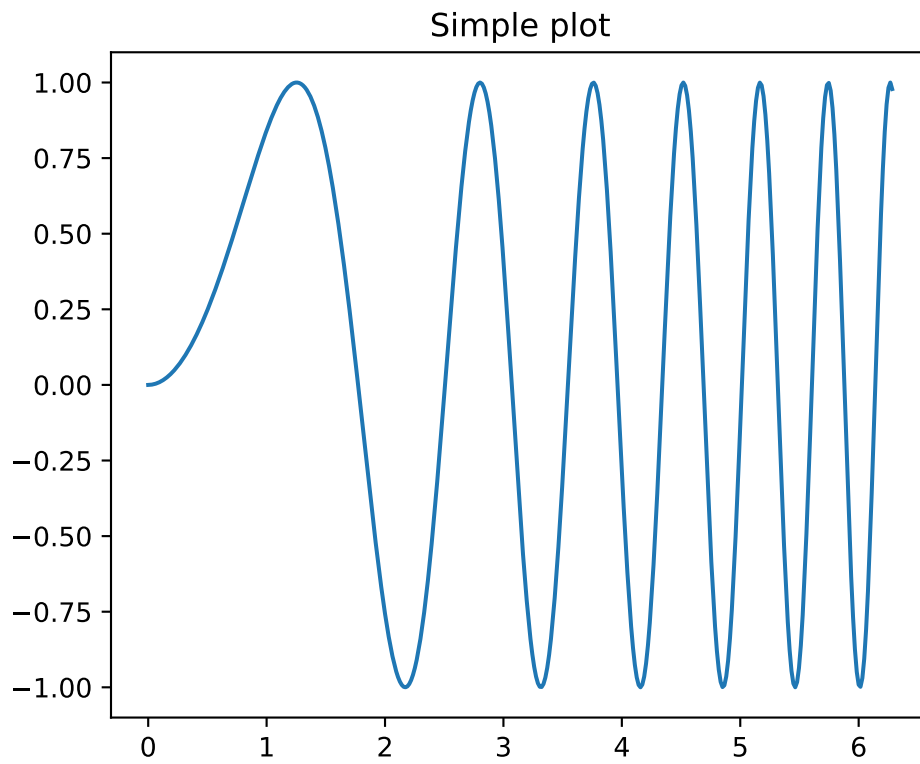

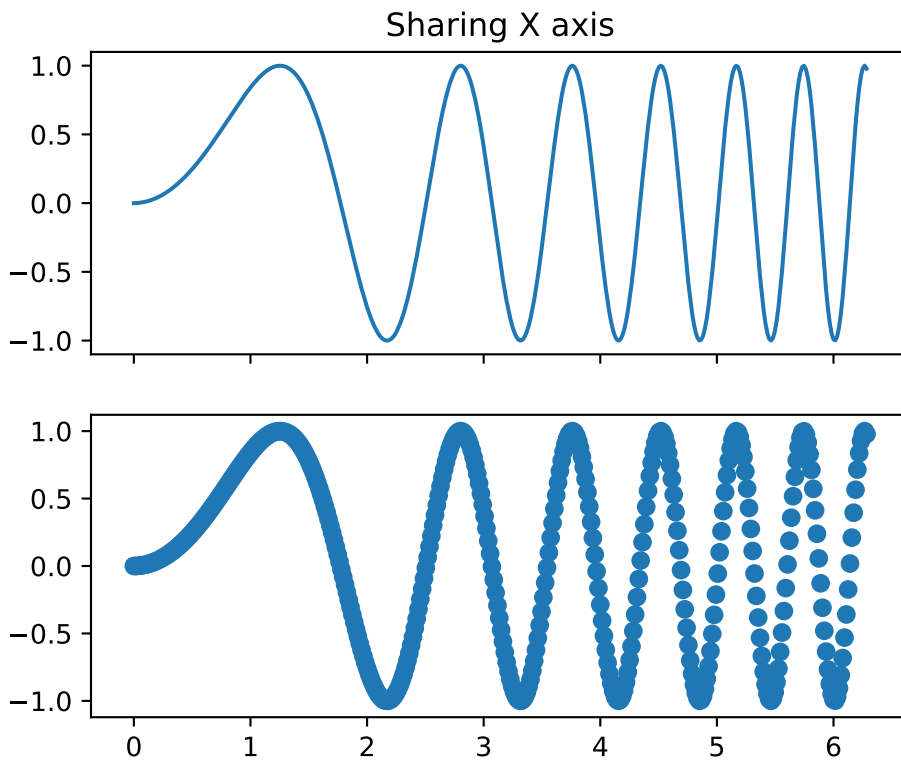

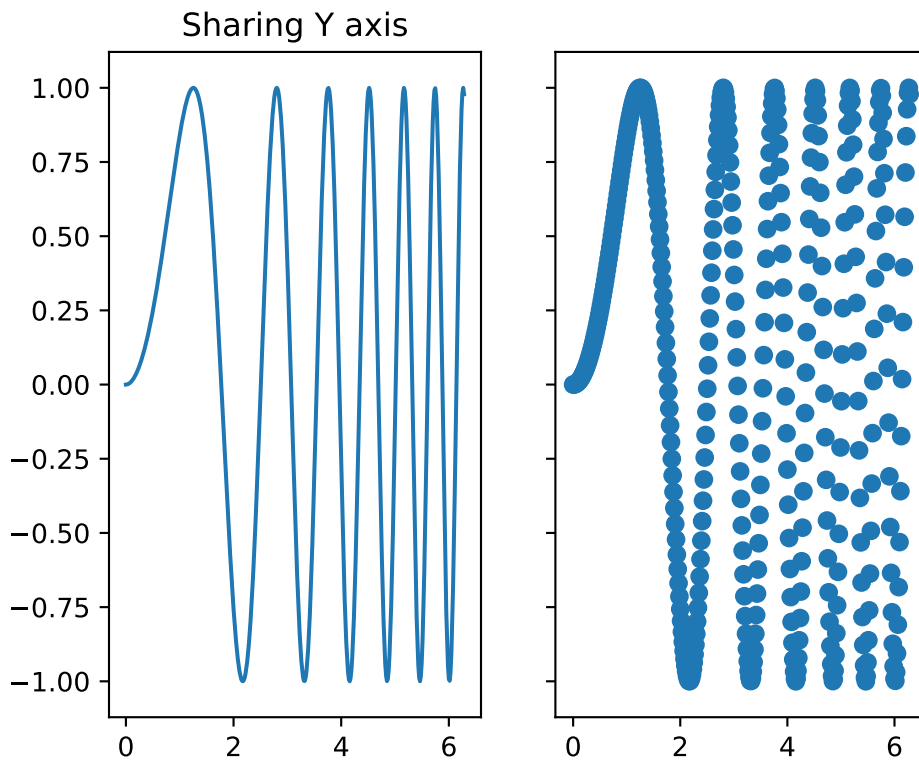

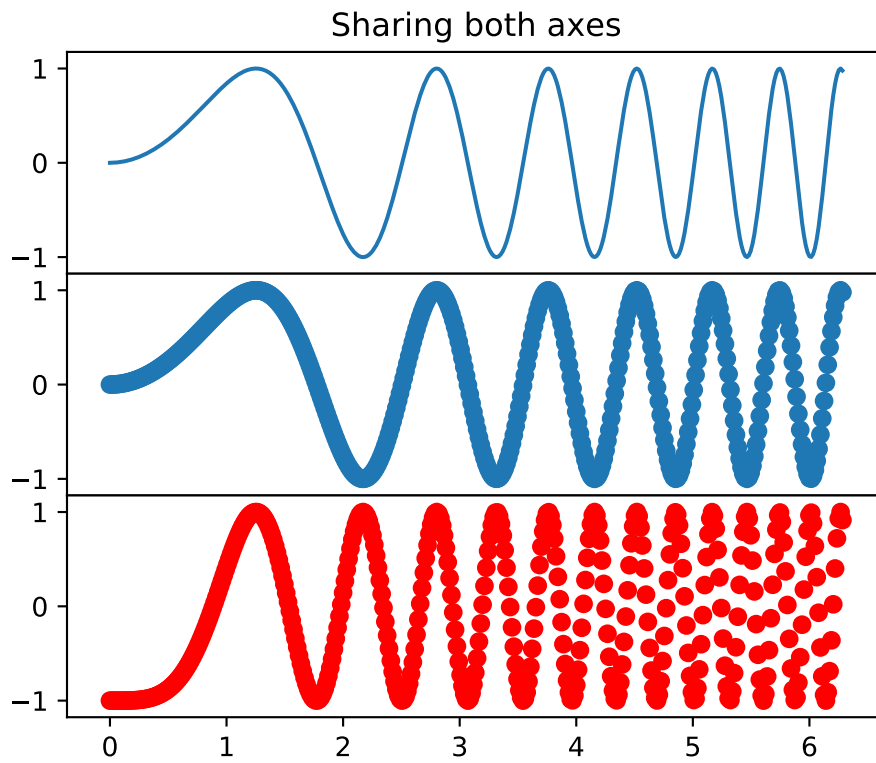

Sharing x per column, y per row

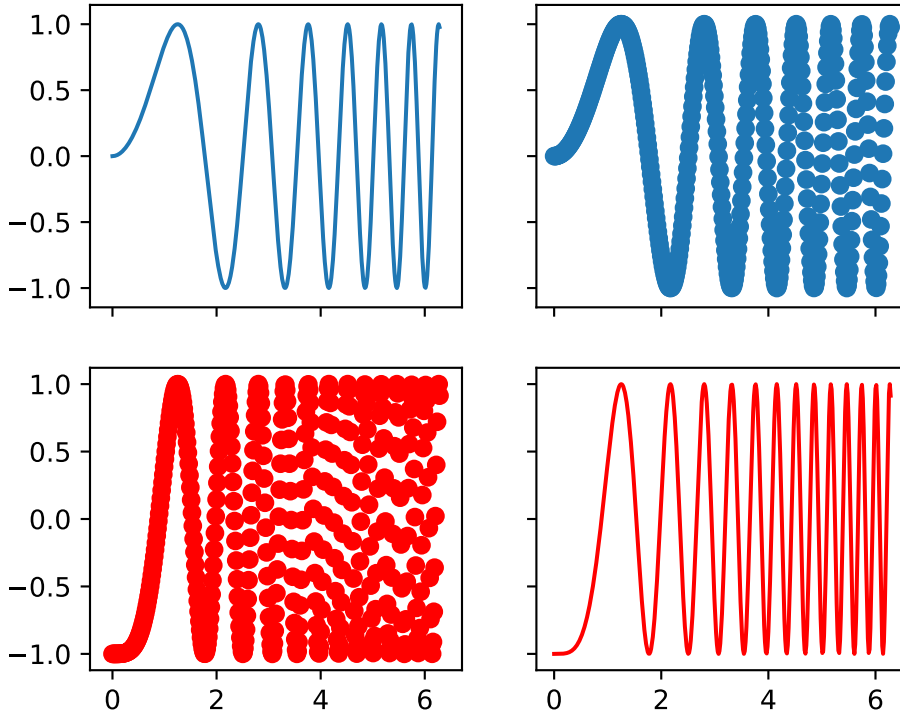

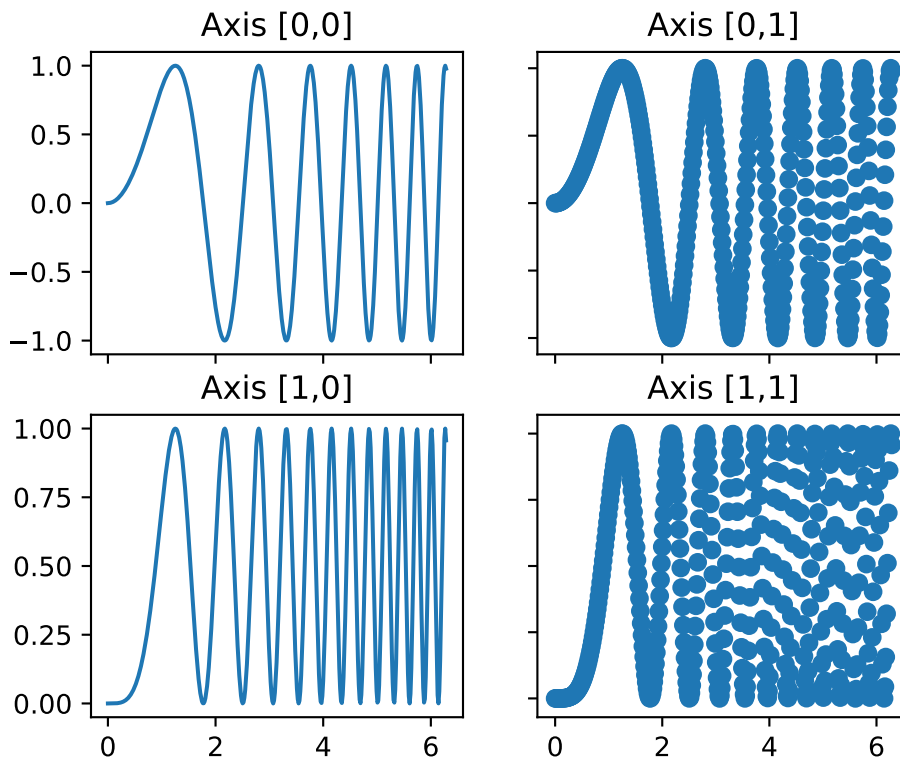

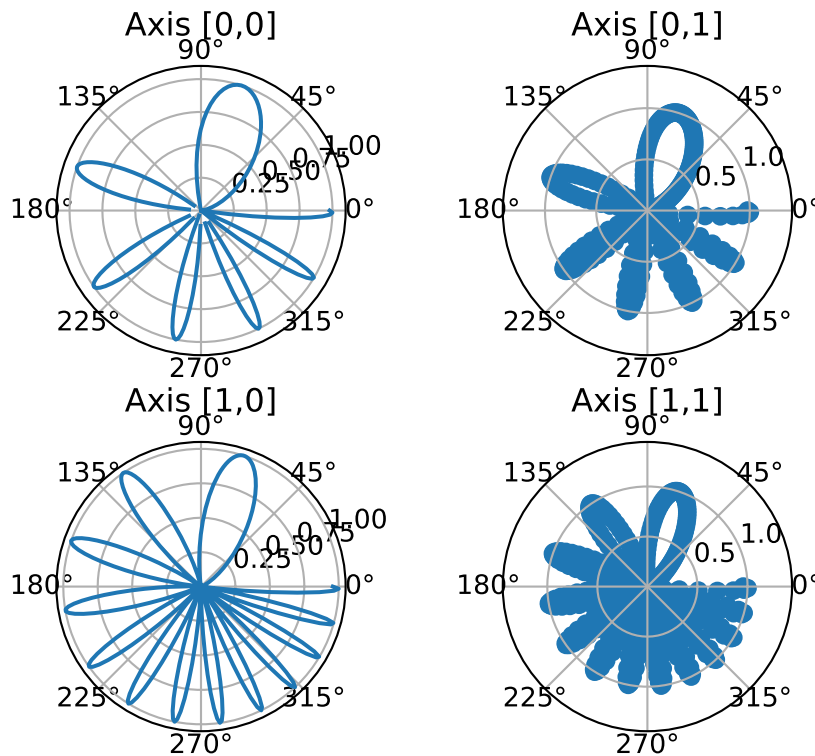

```
"""Examples illustrating the use of plt.subplots().
```

This function creates a figure and a grid of subplots with a single call, while providing reasonable control over how the individual plots are created. For very refined tuning of subplot creation, you can still use `add_subplot()` directly on a new figure.

```
"""
```

```
import matplotlib.pyplot as plt
import numpy as np

# Simple data to display in various forms
x = np.linspace(0, 2 * np.pi, 400)
y = np.sin(x ** 2)

plt.close('all')

# Just a figure and one subplot
f, ax = plt.subplots()
ax.plot(x, y)
ax.set_title('Simple plot')

# Two subplots, the axes array is 1-d
f, axarr = plt.subplots(2, sharex=True)
axarr[0].plot(x, y)
axarr[0].set_title('Sharing X axis')
```

```

axarr[1].scatter(x, y)

# Two subplots, unpack the axes array immediately
f, (ax1, ax2) = plt.subplots(1, 2, sharey=True)
ax1.plot(x, y)
ax1.set_title('Sharing Y axis')
ax2.scatter(x, y)

# Three subplots sharing both x/y axes
f, (ax1, ax2, ax3) = plt.subplots(3, sharex=True, sharey=True)
ax1.plot(x, y)
ax1.set_title('Sharing both axes')
ax2.scatter(x, y)
ax3.scatter(x, 2 * y ** 2 - 1, color='r')
# Fine-tune figure; make subplots close to each other and hide x ticks for
# all but bottom plot.
f.subplots_adjust(hspace=0)
plt.setp([a.get_xticklabels() for a in f.axes[:-1]], visible=False)

# row and column sharing
f, ((ax1, ax2), (ax3, ax4)) = plt.subplots(2, 2, sharex='col', sharey='row')
ax1.plot(x, y)
ax1.set_title('Sharing x per column, y per row')
ax2.scatter(x, y)
ax3.scatter(x, 2 * y ** 2 - 1, color='r')
ax4.plot(x, 2 * y ** 2 - 1, color='r')

# Four axes, returned as a 2-d array
f, axarr = plt.subplots(2, 2)
axarr[0, 0].plot(x, y)
axarr[0, 0].set_title('Axis [0,0]')
axarr[0, 1].scatter(x, y)
axarr[0, 1].set_title('Axis [0,1]')
axarr[1, 0].plot(x, y ** 2)
axarr[1, 0].set_title('Axis [1,0]')
axarr[1, 1].scatter(x, y ** 2)
axarr[1, 1].set_title('Axis [1,1]')
# Fine-tune figure; hide x ticks for top plots and y ticks for right plots
plt.setp([a.get_xticklabels() for a in axarr[0, :]], visible=False)
plt.setp([a.get_yticklabels() for a in axarr[:, 1]], visible=False)

# Four polar axes
f, axarr = plt.subplots(2, 2, subplot_kw=dict(projection='polar'))
axarr[0, 0].plot(x, y)
axarr[0, 0].set_title('Axis [0,0]')
axarr[0, 1].scatter(x, y)
axarr[0, 1].set_title('Axis [0,1]')
axarr[1, 0].plot(x, y ** 2)
axarr[1, 0].set_title('Axis [1,0]')
axarr[1, 1].scatter(x, y ** 2)
axarr[1, 1].set_title('Axis [1,1]')
# Fine-tune figure; make subplots farther from each other.
f.subplots_adjust(hspace=0.3)

```

```
plt.show()
```

Keywords: python, matplotlib, pylab, example, codex (see [Search examples](#))

99.183 pylab_examples example code: symlog_demo.py

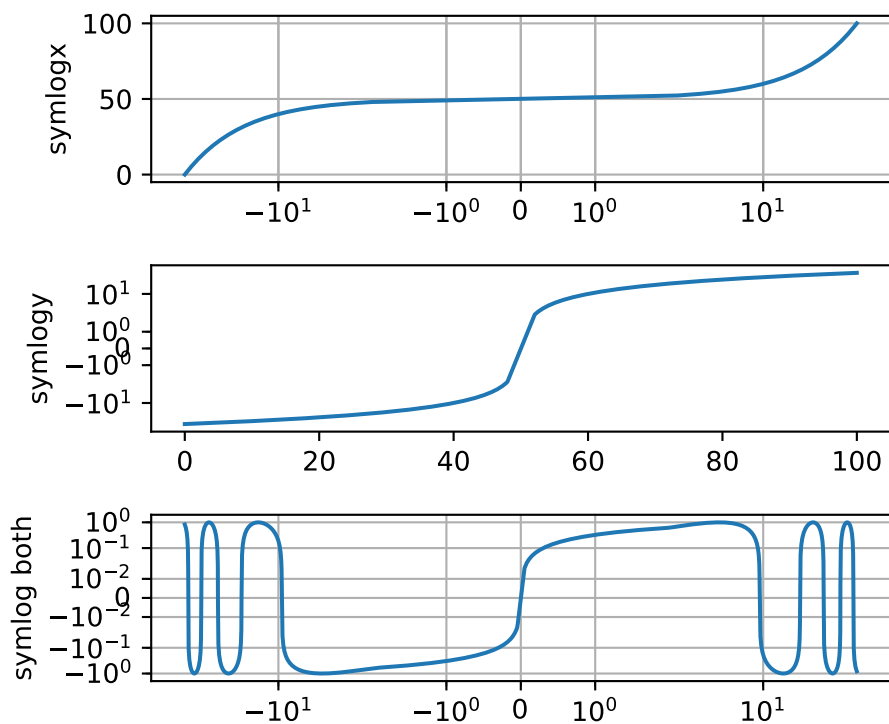

```
import matplotlib.pyplot as plt
import numpy as np

dt = 0.01
x = np.arange(-50.0, 50.0, dt)
y = np.arange(0, 100.0, dt)

plt.subplot(311)
plt.plot(x, y)
plt.xscale('symlog')
plt.ylabel('symlogx')
plt.grid(True)
plt.gca().xaxis.grid(True, which='minor') # minor grid on too

plt.subplot(312)
```



```
plt.plot(y, x)
plt.yscale('symlog')
plt.ylabel('symlogy')

plt.subplot(313)
plt.plot(x, np.sin(x / 3.0))
plt.xscale('symlog')
plt.yscale('symlog', linthreshy=0.015)
plt.grid(True)
plt.ylabel('symlog both')

plt.subplots_adjust(hspace=0.5, left=0.2)

plt.show()
```

Keywords: python, matplotlib, pylab, example, codex (see [Search examples](#))

99.184 pylab_examples example code: system_monitor.py

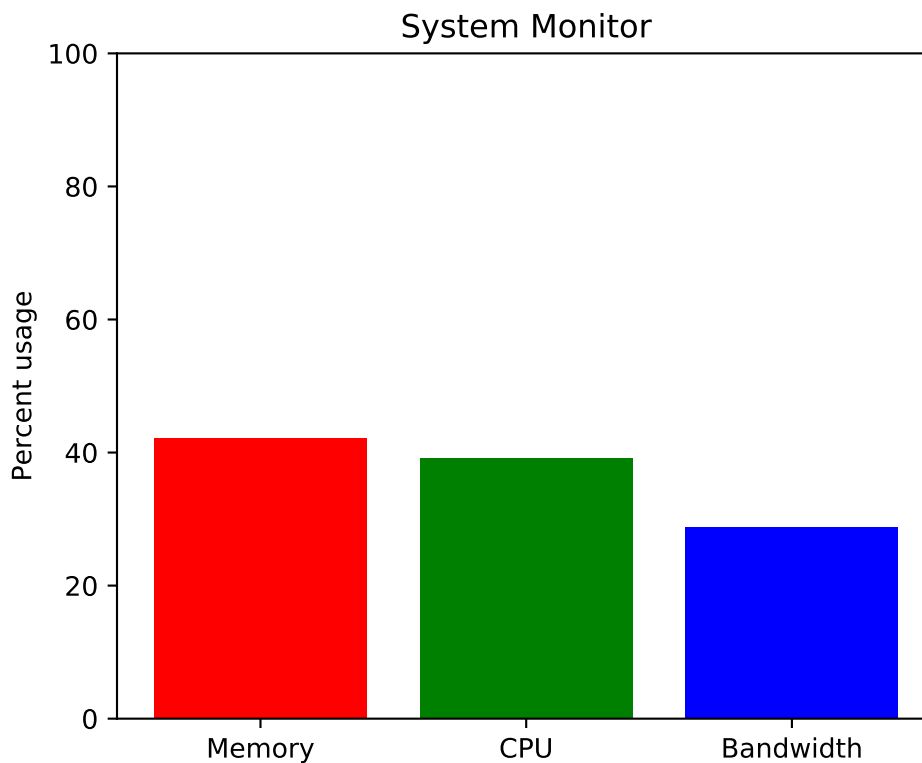

```
import time
import matplotlib.pyplot as plt
import numpy as np
```

```
def get_memory(t):
    "Simulate a function that returns system memory"
    return 100 * (0.5 + 0.5 * np.sin(0.5 * np.pi * t))

def get_cpu(t):
    "Simulate a function that returns cpu usage"
    return 100 * (0.5 + 0.5 * np.sin(0.2 * np.pi * (t - 0.25)))

def get_net(t):
    "Simulate a function that returns network bandwidth"
    return 100 * (0.5 + 0.5 * np.sin(0.7 * np.pi * (t - 0.1)))

def get_stats(t):
    return get_memory(t), get_cpu(t), get_net(t)

fig, ax = plt.subplots()
ind = np.arange(1, 4)

# show the figure, but do not block
plt.show(block=False)

pm, pc, pn = plt.bar(ind, get_stats(0))
pm.set_facecolor('r')
pc.set_facecolor('g')
pn.set_facecolor('b')
ax.set_xticks(ind)
ax.set_xticklabels(['Memory', 'CPU', 'Bandwidth'])
ax.set_ylim([0, 100])
ax.set_ylabel('Percent usage')
ax.set_title('System Monitor')

start = time.time()
for i in range(200): # run for a little while
    m, c, n = get_stats(i / 10.0)

    # update the animated artists
    pm.set_height(m)
    pc.set_height(c)
    pn.set_height(n)

    # ask the canvas to re-draw itself the next time it
    # has a chance.
    # For most of the GUI backends this adds an event to the queue
    # of the GUI frameworks event loop.
    fig.canvas.draw_idle()
    try:
        # make sure that the GUI framework has a chance to run its event loop
```

```

    # and clear any GUI events. This needs to be in a try/except block
    # because the default implementation of this method is to raise
    # NotImplementedError
    fig.canvas.flush_events()
except NotImplementedError:
    pass

stop = time.time()
print("{fps:.1f} frames per second".format(fps=200 / (stop - start)))

```

Keywords: python, matplotlib, pylab, example, codex (see [Search examples](#))

99.185 pylab_examples example code: table_demo.py

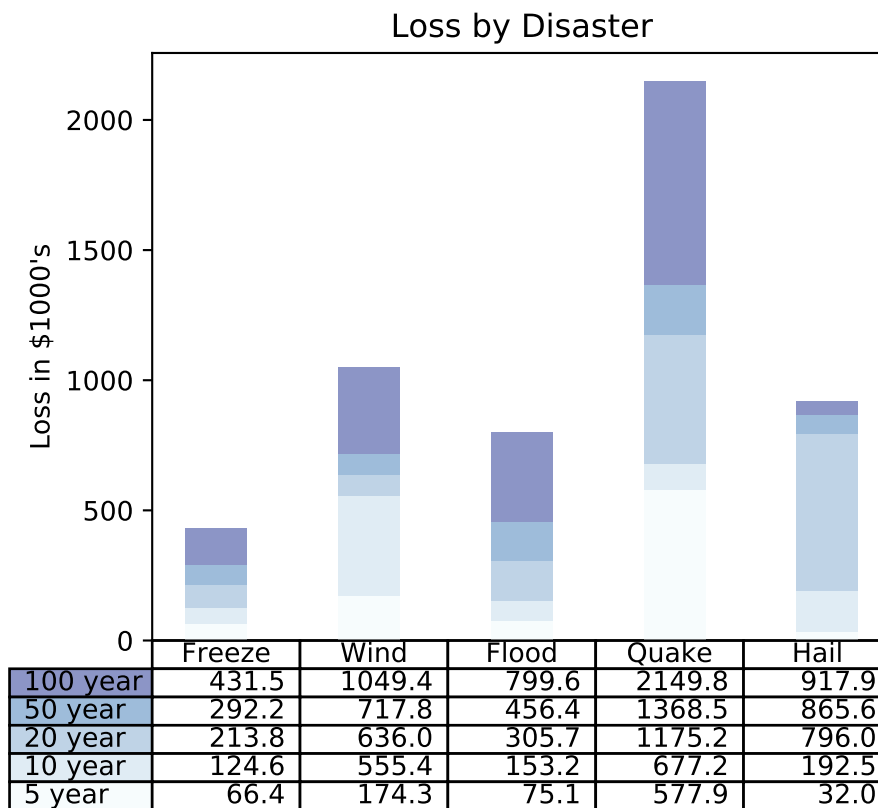

```

"""
Demo of table function to display a table within a plot.
"""
import numpy as np
import matplotlib.pyplot as plt

data = [[ 66386, 174296, 75131, 577908, 32015],

```

```

    [ 58230, 381139, 78045, 99308, 160454],
    [ 89135, 80552, 152558, 497981, 603535],
    [ 78415, 81858, 150656, 193263, 69638],
    [ 139361, 331509, 343164, 781380, 52269]]

columns = ('Freeze', 'Wind', 'Flood', 'Quake', 'Hail')
rows = ['%d year' % x for x in (100, 50, 20, 10, 5)]

values = np.arange(0, 2500, 500)
value_increment = 1000

# Get some pastel shades for the colors
colors = plt.cm.BuPu(np.linspace(0, 0.5, len(rows)))
n_rows = len(data)

index = np.arange(len(columns)) + 0.3
bar_width = 0.4

# Initialize the vertical-offset for the stacked bar chart.
y_offset = np.array([0.0] * len(columns))

# Plot bars and create text labels for the table
cell_text = []
for row in range(n_rows):
    plt.bar(index, data[row], bar_width, bottom=y_offset, color=colors[row])
    y_offset = y_offset + data[row]
    cell_text.append(['%1.1f' % (x/1000.0) for x in y_offset])
# Reverse colors and text labels to display the last value at the top.
colors = colors[::-1]
cell_text.reverse()

# Add a table at the bottom of the axes
the_table = plt.table(cellText=cell_text,
                      rowLabels=rows,
                      rowColours=colors,
                      colLabels=columns,
                      loc='bottom')

# Adjust layout to make room for the table:
plt.subplots_adjust(left=0.2, bottom=0.2)

plt.ylabel("Loss in ${0}'s".format(value_increment))
plt.yticks(values * value_increment, ['%d' % val for val in values])
plt.xticks([])
plt.title('Loss by Disaster')

plt.show()

```

Keywords: python, matplotlib, pylab, example, codex (see [Search examples](#))

99.186 pylab_examples example code: tex_demo.py

$$\text{TeX is Number } \sum_{n=1}^{\infty} \frac{-e^{i\pi}}{2^n}!$$

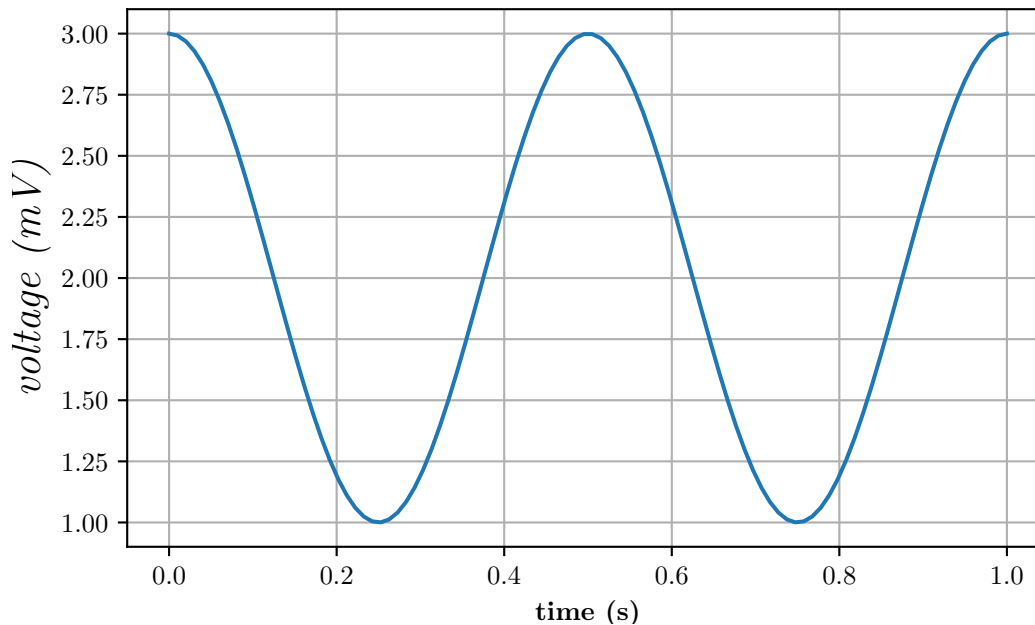

```

"""
You can use TeX to render all of your matplotlib text if the rc
parameter text.usetex is set. This works currently on the agg and ps
backends, and requires that you have tex and the other dependencies
described at http://matplotlib.org/users/usetex.html
properly installed on your system. The first time you run a script
you will see a lot of output from tex and associated tools. The next
time, the run may be silent, as a lot of the information is cached in
~/.tex.cache

"""
import numpy as np
import matplotlib.pyplot as plt

plt.rc('text', usetex=True)
plt.rc('font', family='serif')
plt.figure(1, figsize=(6, 4))
ax = plt.axes([0.1, 0.1, 0.8, 0.7])
t = np.linspace(0.0, 1.0, 100)
s = np.cos(4 * np.pi * t) + 2
plt.plot(t, s)

plt.xlabel(r'\textbf{time (s)}')
plt.ylabel(r'\textit{voltage (mV)}', fontsize=16)

```

```
plt.title(r"\TeX\ is Number  $\displaystyle\sum_{n=1}^{\infty}$ "
         r"\frac{-e^{i\pi}}{2^n}$!", fontsize=16, color='r')
plt.grid(True)
plt.savefig('tex_demo')
plt.show()
```

Keywords: python, matplotlib, pylab, example, codex (see *Search examples*)

99.187 pylab_examples example code: tex_unicode_demo.py

$$\text{\color{red}TeX is Number } \sum_{n=1}^{\infty} \frac{-e^{i\pi}}{2^n}!$$

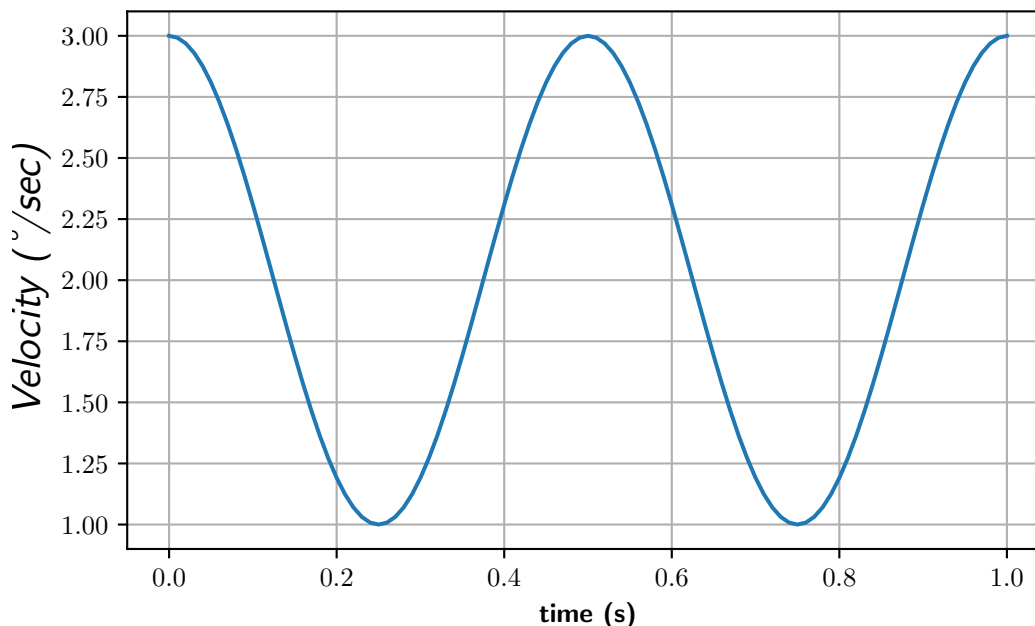

```
# -*- coding: utf-8 -*-
"""
This demo is tex_demo.py modified to have unicode. See that file for
more information.
"""

from __future__ import unicode_literals
import numpy as np
import matplotlib
matplotlib.rcParams['text.usetex'] = True
matplotlib.rcParams['text.latex.unicode'] = True
import matplotlib.pyplot as plt

plt.figure(1, figsize=(6, 4))
ax = plt.axes([0.1, 0.1, 0.8, 0.7])
```

```

t = np.arange(0.0, 1.0 + 0.01, 0.01)
s = np.cos(2*2*np.pi*t) + 2
plt.plot(t, s)

plt.xlabel(r'\textbf{time (s)}')
plt.ylabel('\textit{Velocity (\u00B0/sec)}', fontsize=16)
plt.title(r'\TeX\ is Number $\displaystyle\sum_{n=1}^{\infty}'
          r'\frac{-e^{i\pi}}{2^n}$!', fontsize=16, color='r')
plt.grid(True)
plt.show()

```

Keywords: python, matplotlib, pylab, example, codex (see [Search examples](#))

99.188 pylab_examples example code: text_handles.py

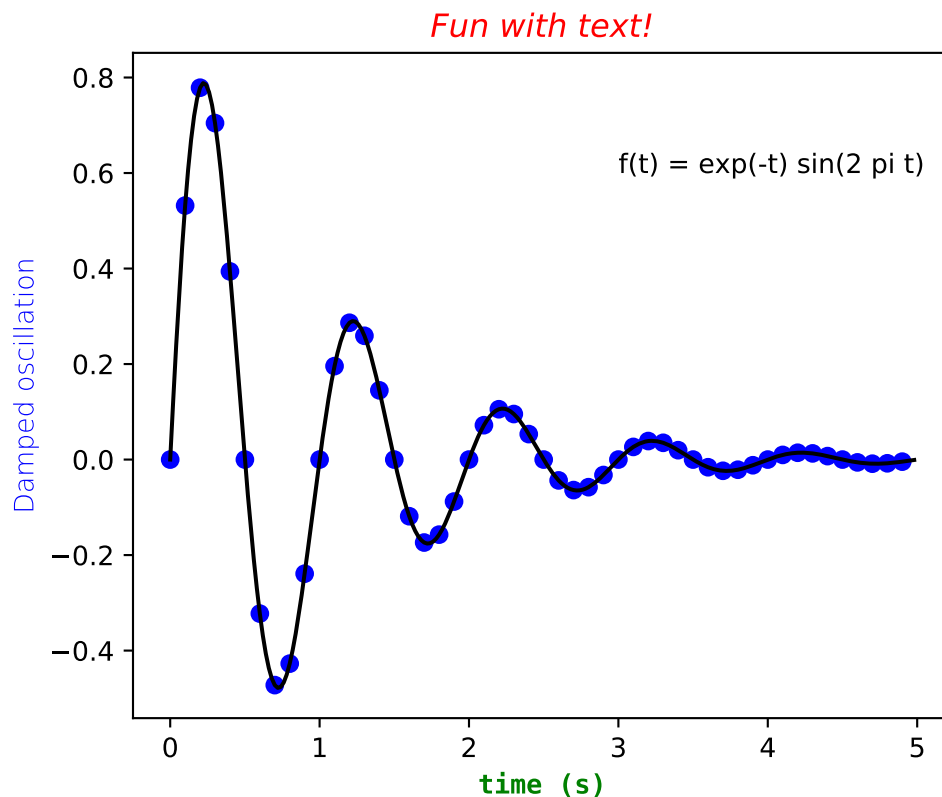

```

"""
Controlling the properties of axis text using handles

See examples/text_themes.py for a more elegant, pythonic way to control
fonts. After all, if we were slaves to MATLAB, we wouldn't be
using python!
"""

```

```
import matplotlib.pyplot as plt
import numpy as np

def f(t):
    s1 = np.sin(2*np.pi*t)
    e1 = np.exp(-t)
    return np.multiply(s1, e1)

t1 = np.arange(0.0, 5.0, 0.1)
t2 = np.arange(0.0, 5.0, 0.02)

fig, ax = plt.subplots()
plt.plot(t1, f(t1), 'bo', t2, f(t2), 'k')
plt.text(3.0, 0.6, 'f(t) = exp(-t) sin(2 pi t)')
ttext = plt.title('Fun with text!')
ytext = plt.ylabel('Damped oscillation')
xtext = plt.xlabel('time (s)')

plt.setp(ttext, size='large', color='r', style='italic')
plt.setp(xtext, size='medium', name=['Courier', 'DejaVu Sans Mono'],
         weight='bold', color='g')
plt.setp(ytext, size='medium', name=['Helvetica', 'DejaVu Sans'],
         weight='light', color='b')
plt.show()
```

Keywords: python, matplotlib, pylab, example, codex (see [Search examples](#))

99.189 pylab_examples example code: text_rotation.py

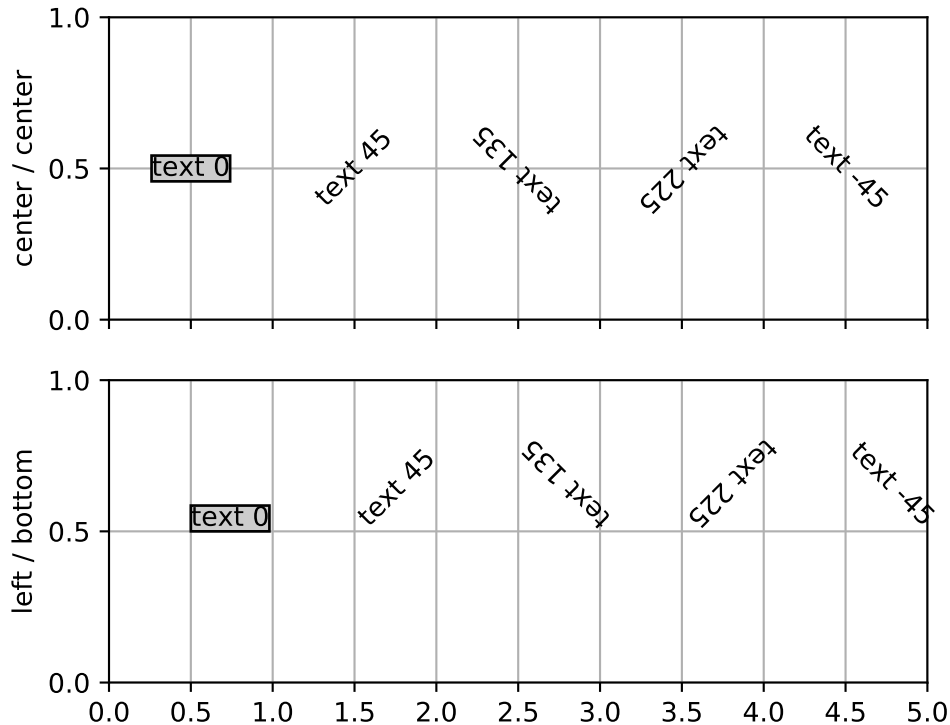

```

"""
The way matplotlib does text layout is counter-intuitive to some, so
this example is designed to make it a little clearer. The text is
aligned by it's bounding box (the rectangular box that surrounds the
ink rectangle). The order of operations is basically rotation then
alignment, rather than alignment then rotation. Basically, the text
is centered at your x,y location, rotated around this point, and then
aligned according to the bounding box of the rotated text.

So if you specify left, bottom alignment, the bottom left of the
bounding box of the rotated text will be at the x,y coordinate of the
text.

But a picture is worth a thousand words!
"""

import matplotlib.pyplot as plt
import numpy as np

def addtext(props):
    plt.text(0.5, 0.5, 'text 0', props, rotation=0)

```

```
plt.text(1.5, 0.5, 'text 45', props, rotation=45)
plt.text(2.5, 0.5, 'text 135', props, rotation=135)
plt.text(3.5, 0.5, 'text 225', props, rotation=225)
plt.text(4.5, 0.5, 'text -45', props, rotation=-45)
plt.yticks([0, .5, 1])
plt.grid(True)

# the text bounding box
bbox = {'fc': '0.8', 'pad': 0}

plt.subplot(211)
addtext({'ha': 'center', 'va': 'center', 'bbox': bbox})
plt.xlim(0, 5)
plt.xticks(np.arange(0, 5.1, 0.5), [])
plt.ylabel('center / center')

plt.subplot(212)
addtext({'ha': 'left', 'va': 'bottom', 'bbox': bbox})
plt.xlim(0, 5)
plt.xticks(np.arange(0, 5.1, 0.5))
plt.ylabel('left / bottom')
plt.show()
```

Keywords: python, matplotlib, pylab, example, codex (see [Search examples](#))

99.190 pylab_examples example code: text_rotation_relative_to_line.py

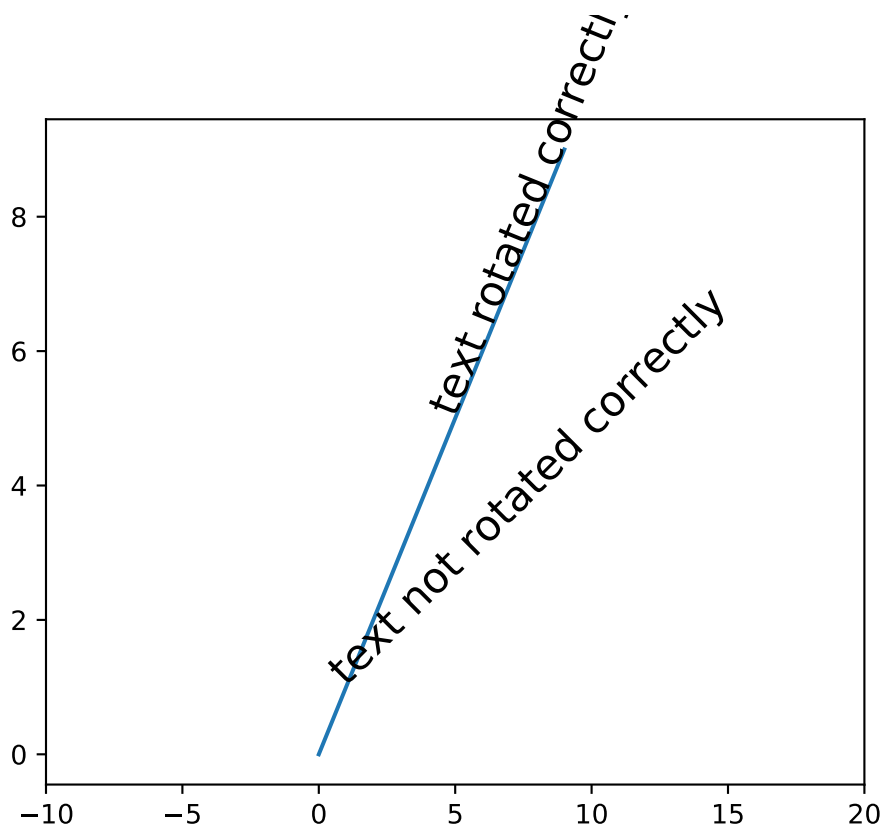

```

"""
Text objects in matplotlib are normally rotated with respect to the
screen coordinate system (i.e., 45 degrees rotation plots text along
a line that is in between horizontal and vertical no matter how the axes
are changed). However, at times one wants to rotate text with respect
to something on the plot. In this case, the correct angle won't be
the angle of that object in the plot coordinate system, but the angle
that that object APPEARS in the screen coordinate system. This angle
is found by transforming the angle from the plot to the screen
coordinate system, as shown in the example below.
"""

import matplotlib.pyplot as plt
import numpy as np

# Plot diagonal line (45 degrees)
h = plt.plot(np.arange(0, 10), np.arange(0, 10))

# set limits so that it no longer looks on screen to be 45 degrees
plt.xlim([-10, 20])

# Locations to plot text

```

```
l1 = np.array((1, 1))
l2 = np.array((5, 5))

# Rotate angle
angle = 45
trans_angle = plt.gca().transData.transform_angles(np.array((45,)),
                                                    l2.reshape((1, 2)))[0]

# Plot text
th1 = plt.text(l1[0], l1[1], 'text not rotated correctly', fontsize=16,
               rotation=angle, rotation_mode='anchor')
th2 = plt.text(l2[0], l2[1], 'text rotated correctly', fontsize=16,
               rotation=trans_angle, rotation_mode='anchor')

plt.show()
```

Keywords: python, matplotlib, pylab, example, codex (see [Search examples](#))

99.191 pylab_examples example code: titles_demo.py

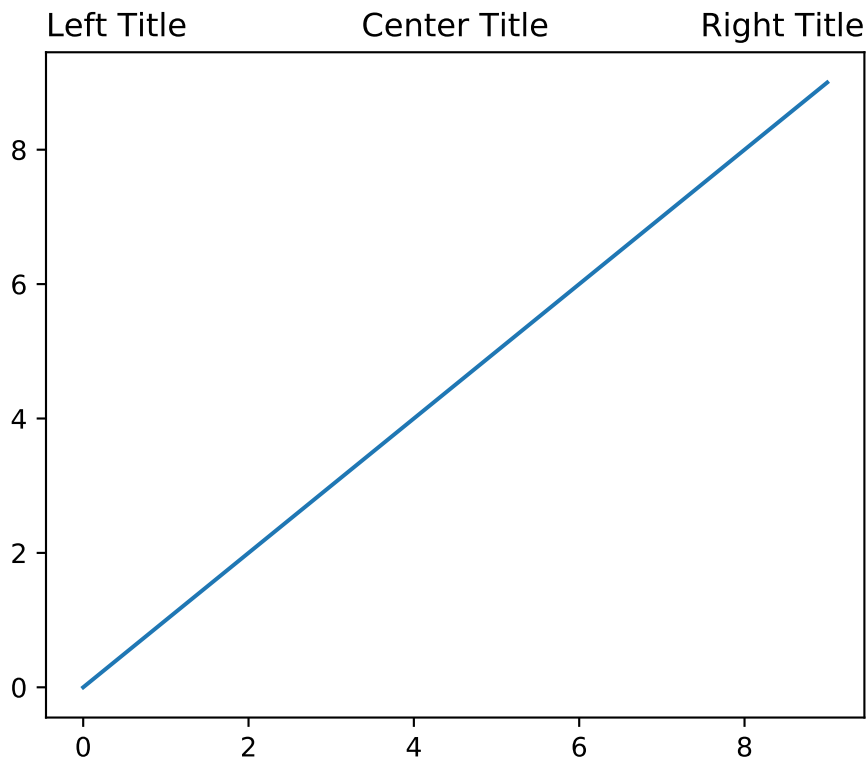

```
"""
matplotlib can display plot titles centered, flush with the left side of
```

a set of axes, and flush with the right side of a set of axes.

```
"""  
import matplotlib.pyplot as plt  
  
plt.plot(range(10))  
  
plt.title('Center Title')  
plt.title('Left Title', loc='left')  
plt.title('Right Title', loc='right')  
  
plt.show()
```

Keywords: python, matplotlib, pylab, example, codex (see *Search examples*)

99.192 pylab_examples example code: toggle_images.py

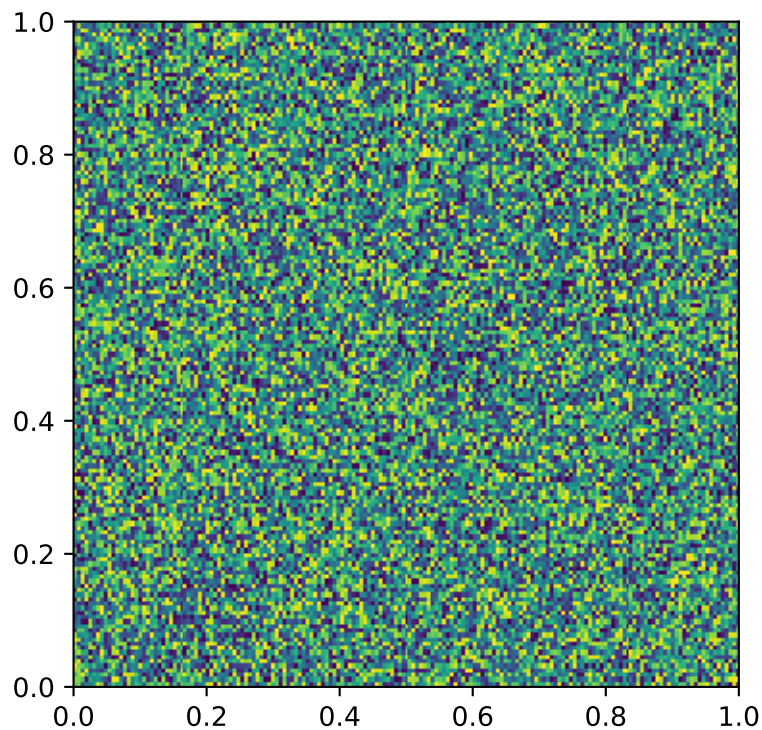

```
""" toggle between two images by pressing "t"
```

The basic idea is to load two images (they can be different shapes) and plot them to the same axes. Then, toggle the visible property of them using keypress event handling

If you want two images with different shapes to be plotted with the same extent, they must have the same "extent" property

As usual, we'll define some random images for demo. Real data is much more exciting!

Note, on the wx backend on some platforms (e.g., linux), you have to first click on the figure before the keypress events are activated. If you know how to fix this, please email us!

```
"""  
  
import matplotlib.pyplot as plt  
import numpy as np  
  
# two images x1 is initially visible, x2 is not  
x1 = np.random.random((100, 100))  
x2 = np.random.random((150, 175))  
  
# arbitrary extent - both images must have same extent if you want  
# them to be resampled into the same axes space  
extent = (0, 1, 0, 1)  
im1 = plt.imshow(x1, extent=extent)  
im2 = plt.imshow(x2, extent=extent)  
im2.set_visible(False)  
  
def toggle_images(event):  
    'toggle the visible state of the two images'  
    if event.key != 't':  
        return  
    b1 = im1.get_visible()  
    b2 = im2.get_visible()  
    im1.set_visible(not b1)  
    im2.set_visible(not b2)  
    plt.draw()  
  
plt.connect('key_press_event', toggle_images)  
  
plt.show()
```

Keywords: python, matplotlib, pylab, example, codex (see *Search examples*)

99.193 pylab_examples example code: transoffset.py

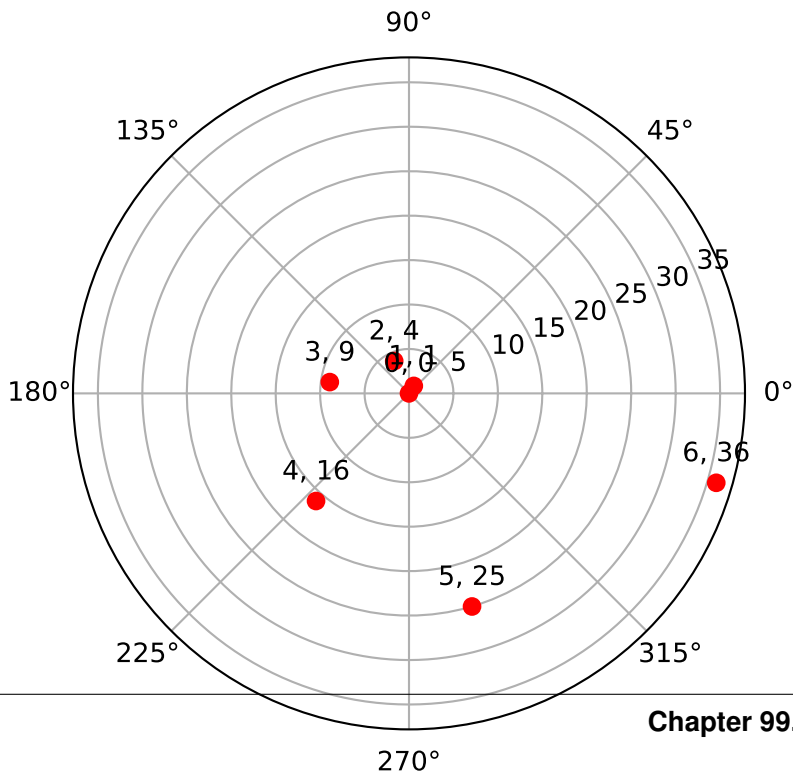
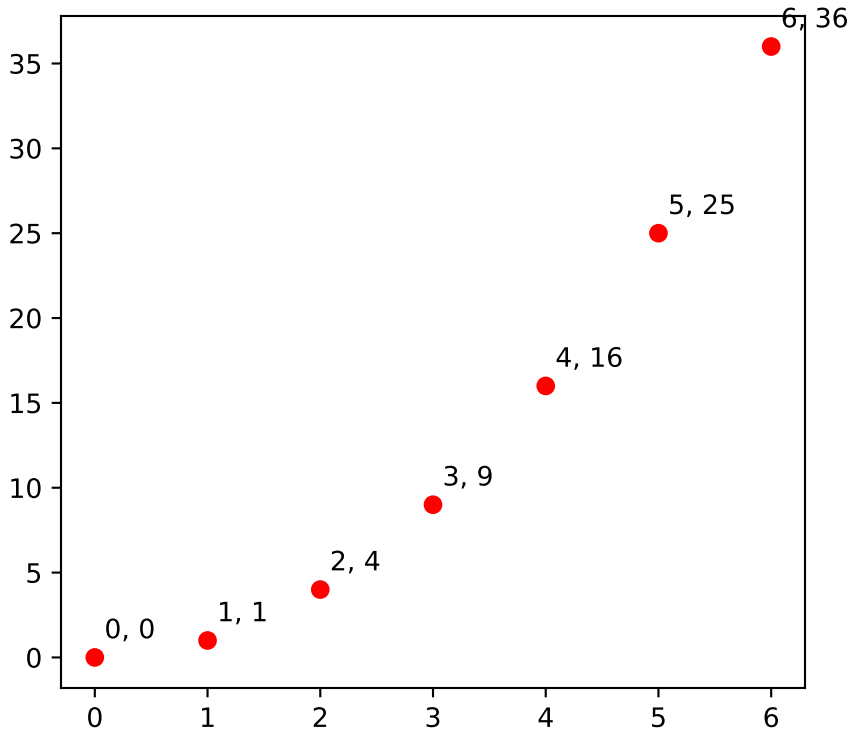

```

"""
This illustrates the use of transforms.offset_copy to
make a transform that positions a drawing element such as
a text string at a specified offset in screen coordinates
(dots or inches) relative to a location given in any
coordinates.

Every Artist--the mpl class from which classes such as
Text and Line are derived--has a transform that can be
set when the Artist is created, such as by the corresponding
pyplot command. By default this is usually the Axes.transData
transform, going from data units to screen dots. We can
use the offset_copy function to make a modified copy of
this transform, where the modification consists of an
offset.
"""

import matplotlib.pyplot as plt
import matplotlib.transforms as mtrans
import numpy as np

from matplotlib.transforms import offset_copy

xs = np.arange(7)
ys = xs**2

fig = plt.figure(figsize=(5, 10))
ax = plt.subplot(2, 1, 1)

# If we want the same offset for each text instance,
# we only need to make one transform. To get the
# transform argument to offset_copy, we need to make the axes
# first; the subplot command above is one way to do this.
trans_offset = mtrans.offset_copy(ax.transData, fig=fig,
                                  x=0.05, y=0.10, units='inches')

for x, y in zip(xs, ys):
    plt.plot((x,), (y,), 'ro')
    plt.text(x, y, '%d, %d' % (int(x), int(y)), transform=trans_offset)

# offset_copy works for polar plots also.
ax = plt.subplot(2, 1, 2, projection='polar')

trans_offset = mtrans.offset_copy(ax.transData, fig=fig, y=6, units='dots')

for x, y in zip(xs, ys):
    plt.polar((x,), (y,), 'ro')
    plt.text(x, y, '%d, %d' % (int(x), int(y)),
             transform=trans_offset,
             horizontalalignment='center',
             verticalalignment='bottom')

```

```
plt.show()
```

Keywords: python, matplotlib, pylab, example, codex (see [Search examples](#))

99.194 pylab_examples example code: tricontour_demo.py

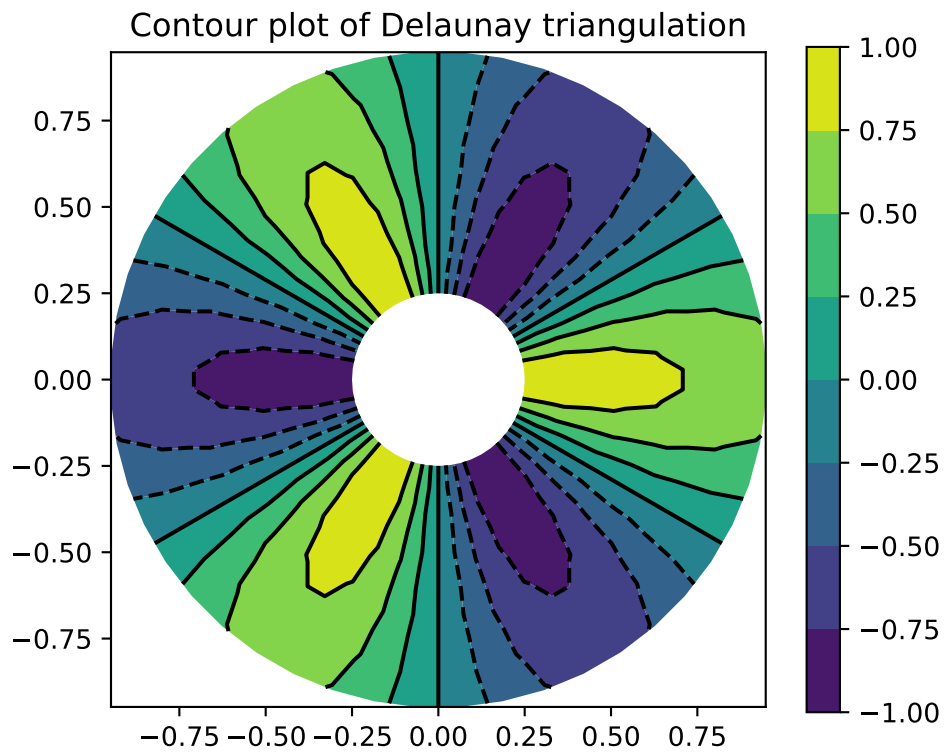

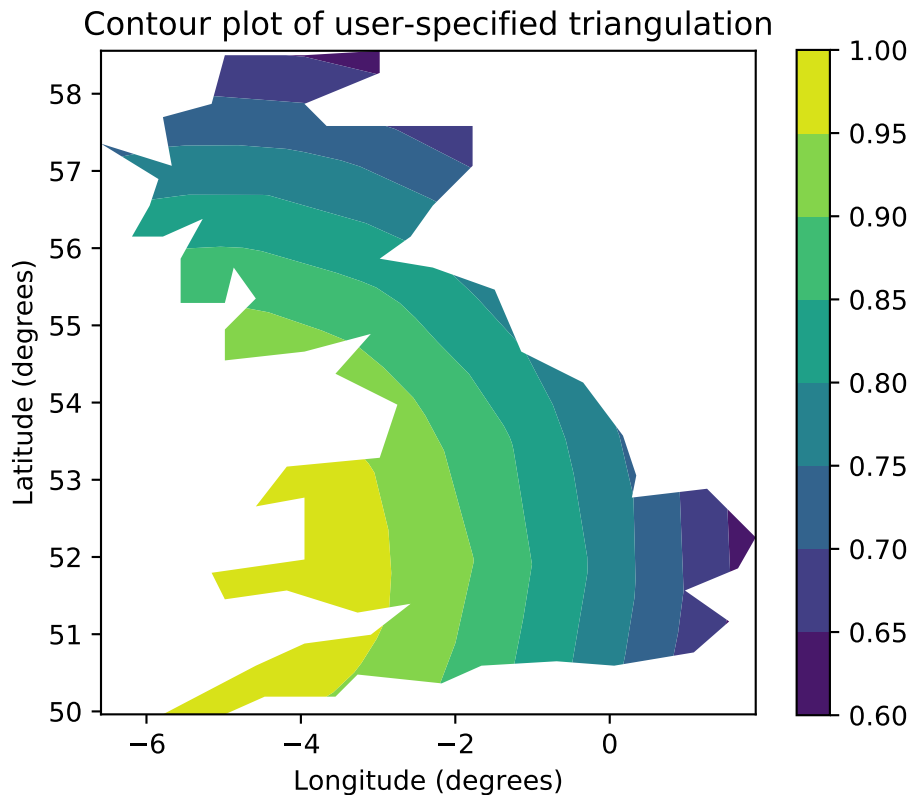

```

"""
Contour plots of unstructured triangular grids.
"""
import matplotlib.pyplot as plt
import matplotlib.tri as tri
import numpy as np
import math

# Creating a Triangulation without specifying the triangles results in the
# Delaunay triangulation of the points.

# First create the x and y coordinates of the points.
n_angles = 48
n_radii = 8
min_radius = 0.25
radii = np.linspace(min_radius, 0.95, n_radii)

angles = np.linspace(0, 2*math.pi, n_angles, endpoint=False)
angles = np.repeat(angles[..., np.newaxis], n_radii, axis=1)
angles[:, 1::2] += math.pi/n_angles

x = (radii*np.cos(angles)).flatten()
y = (radii*np.sin(angles)).flatten()
z = (np.cos(radii)*np.cos(angles*3.0)).flatten()

# Create the Triangulation; no triangles so Delaunay triangulation created.

```

```

triang = tri.Triangulation(x, y)

# Mask off unwanted triangles.
xmid = x[triang.triangles].mean(axis=1)
ymid = y[triang.triangles].mean(axis=1)
mask = np.where(xmid*xmid + ymid*ymid < min_radius*min_radius, 1, 0)
triang.set_mask(mask)

# pcolor plot.
plt.figure()
plt.gca().set_aspect('equal')
plt.tricontourf(triang, z)
plt.colorbar()
plt.tricontour(triang, z, colors='k')
plt.title('Contour plot of Delaunay triangulation')

# You can specify your own triangulation rather than perform a Delaunay
# triangulation of the points, where each triangle is given by the indices of
# the three points that make up the triangle, ordered in either a clockwise or
# anticlockwise manner.

xy = np.asarray([
    [-0.101, 0.872], [-0.080, 0.883], [-0.069, 0.888], [-0.054, 0.890],
    [-0.045, 0.897], [-0.057, 0.895], [-0.073, 0.900], [-0.087, 0.898],
    [-0.090, 0.904], [-0.069, 0.907], [-0.069, 0.921], [-0.080, 0.919],
    [-0.073, 0.928], [-0.052, 0.930], [-0.048, 0.942], [-0.062, 0.949],
    [-0.054, 0.958], [-0.069, 0.954], [-0.087, 0.952], [-0.087, 0.959],
    [-0.080, 0.966], [-0.085, 0.973], [-0.087, 0.965], [-0.097, 0.965],
    [-0.097, 0.975], [-0.092, 0.984], [-0.101, 0.980], [-0.108, 0.980],
    [-0.104, 0.987], [-0.102, 0.993], [-0.115, 1.001], [-0.099, 0.996],
    [-0.101, 1.007], [-0.090, 1.010], [-0.087, 1.021], [-0.069, 1.021],
    [-0.052, 1.022], [-0.052, 1.017], [-0.069, 1.010], [-0.064, 1.005],
    [-0.048, 1.005], [-0.031, 1.005], [-0.031, 0.996], [-0.040, 0.987],
    [-0.045, 0.980], [-0.052, 0.975], [-0.040, 0.973], [-0.026, 0.968],
    [-0.020, 0.954], [-0.006, 0.947], [ 0.003, 0.935], [ 0.006, 0.926],
    [ 0.005, 0.921], [ 0.022, 0.923], [ 0.033, 0.912], [ 0.029, 0.905],
    [ 0.017, 0.900], [ 0.012, 0.895], [ 0.027, 0.893], [ 0.019, 0.886],
    [ 0.001, 0.883], [-0.012, 0.884], [-0.029, 0.883], [-0.038, 0.879],
    [-0.057, 0.881], [-0.062, 0.876], [-0.078, 0.876], [-0.087, 0.872],
    [-0.030, 0.907], [-0.007, 0.905], [-0.057, 0.916], [-0.025, 0.933],
    [-0.077, 0.990], [-0.059, 0.993]])
x = np.degrees(xy[:, 0])
y = np.degrees(xy[:, 1])
x0 = -5
y0 = 52
z = np.exp(-0.01*((x - x0)*(x - x0) + (y - y0)*(y - y0)))

triangles = np.asarray([
    [67, 66, 1], [65, 2, 66], [1, 66, 2], [64, 2, 65], [63, 3, 64],
    [60, 59, 57], [2, 64, 3], [3, 63, 4], [0, 67, 1], [62, 4, 63],
    [57, 59, 56], [59, 58, 56], [61, 60, 69], [57, 69, 60], [4, 62, 68],
    [6, 5, 9], [61, 68, 62], [69, 68, 61], [9, 5, 70], [6, 8, 7],
    [4, 70, 5], [8, 6, 9], [56, 69, 57], [69, 56, 52], [70, 10, 9],

```

```
[54, 53, 55], [56, 55, 53], [68, 70, 4], [52, 56, 53], [11, 10, 12],
[69, 71, 68], [68, 13, 70], [10, 70, 13], [51, 50, 52], [13, 68, 71],
[52, 71, 69], [12, 10, 13], [71, 52, 50], [71, 14, 13], [50, 49, 71],
[49, 48, 71], [14, 16, 15], [14, 71, 48], [17, 19, 18], [17, 20, 19],
[48, 16, 14], [48, 47, 16], [47, 46, 16], [16, 46, 45], [23, 22, 24],
[21, 24, 22], [17, 16, 45], [20, 17, 45], [21, 25, 24], [27, 26, 28],
[20, 72, 21], [25, 21, 72], [45, 72, 20], [25, 28, 26], [44, 73, 45],
[72, 45, 73], [28, 25, 29], [29, 25, 31], [43, 73, 44], [73, 43, 40],
[72, 73, 39], [72, 31, 25], [42, 40, 43], [31, 30, 29], [39, 73, 40],
[42, 41, 40], [72, 33, 31], [32, 31, 33], [39, 38, 72], [33, 72, 38],
[33, 38, 34], [37, 35, 38], [34, 38, 35], [35, 37, 36]])

# Rather than create a Triangulation object, can simply pass x, y and triangles
# arrays to tripcolor directly. It would be better to use a Triangulation
# object if the same triangulation was to be used more than once to save
# duplicated calculations.
plt.figure()
plt.gca().set_aspect('equal')
plt.tricontourf(x, y, triangles, z)
plt.colorbar()
plt.title('Contour plot of user-specified triangulation')
plt.xlabel('Longitude (degrees)')
plt.ylabel('Latitude (degrees)')

plt.show()
```

Keywords: python, matplotlib, pylab, example, codex (see [Search examples](#))

99.195 pylab_examples example code: tricontour_smooth_delaunay.py

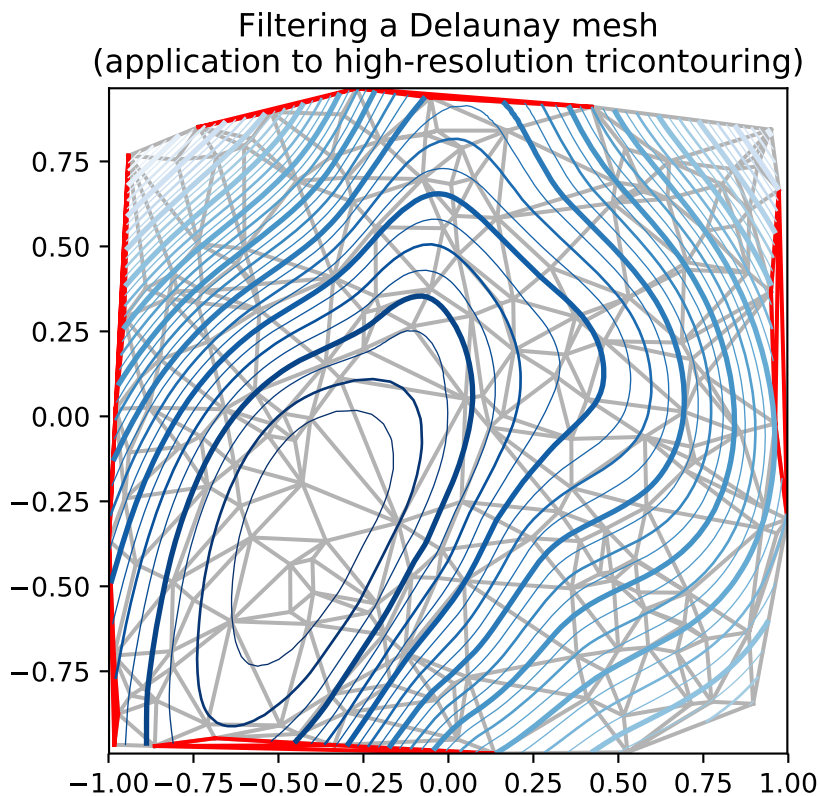

```

"""
Demonstrates high-resolution tricontouring of a random set of points ;
a matplotlib.tri.TriAnalyzer is used to improve the plot quality.

The initial data points and triangular grid for this demo are:
- a set of random points is instantiated, inside [-1, 1] x [-1, 1] square
- A Delaunay triangulation of these points is then computed, of which a
  random subset of triangles is masked out by the user (based on
  *init_mask_frac* parameter). This simulates invalidated data.

The proposed generic procedure to obtain a high resolution contouring of such
a data set is the following:
1) Compute an extended mask with a matplotlib.tri.TriAnalyzer, which will
  exclude badly shaped (flat) triangles from the border of the
  triangulation. Apply the mask to the triangulation (using set_mask).
2) Refine and interpolate the data using a
  matplotlib.tri.UniformTriRefiner.
3) Plot the refined data with tricontour.

"""
from matplotlib.tri import Triangulation, TriAnalyzer, UniformTriRefiner
import matplotlib.pyplot as plt

```

```

import matplotlib.cm as cm
import numpy as np

#-----
# Analytical test function
#-----
def experiment_res(x, y):
    """ An analytic function representing experiment results """
    x = 2.*x
    r1 = np.sqrt((0.5 - x)**2 + (0.5 - y)**2)
    theta1 = np.arctan2(0.5 - x, 0.5 - y)
    r2 = np.sqrt((-x - 0.2)**2 + (-y - 0.2)**2)
    theta2 = np.arctan2(-x - 0.2, -y - 0.2)
    z = (4*(np.exp((r1/10)**2) - 1)*30. * np.cos(3*theta1) +
         (np.exp((r2/10)**2) - 1)*30. * np.cos(5*theta2) +
         2*(x**2 + y**2))
    return (np.max(z) - z)/(np.max(z) - np.min(z))

#-----
# Generating the initial data test points and triangulation for the demo
#-----
# User parameters for data test points
n_test = 200 # Number of test data points, tested from 3 to 5000 for subdiv=3

subdiv = 3 # Number of recursive subdivisions of the initial mesh for smooth
           # plots. Values >3 might result in a very high number of triangles
           # for the refine mesh: new triangles numbering = (4**subdiv)*ntri

init_mask_frac = 0.0 # Float > 0. adjusting the proportion of
                    # (invalid) initial triangles which will be masked
                    # out. Enter 0 for no mask.

min_circle_ratio = .01 # Minimum circle ratio - border triangles with circle
                       # ratio below this will be masked if they touch a
                       # border. Suggested value 0.01 ; Use -1 to keep
                       # all triangles.

# Random points
random_gen = np.random.mtrand.RandomState(seed=127260)
x_test = random_gen.uniform(-1., 1., size=n_test)
y_test = random_gen.uniform(-1., 1., size=n_test)
z_test = experiment_res(x_test, y_test)

# meshing with Delaunay triangulation
tri = Triangulation(x_test, y_test)
ntri = tri.triangles.shape[0]

# Some invalid data are masked out
mask_init = np.zeros(ntri, dtype=np.bool)
masked_tri = random_gen.randint(0, ntri, int(ntri*init_mask_frac))
mask_init[masked_tri] = True
tri.set_mask(mask_init)

```

```

#-----
# Improving the triangulation before high-res plots: removing flat triangles
#-----
# masking badly shaped triangles at the border of the triangular mesh.
mask = TriAnalyzer(tri).get_flat_tri_mask(min_circle_ratio)
tri.set_mask(mask)

# refining the data
refiner = UniformTriRefiner(tri)
tri_refi, z_test_refi = refiner.refine_field(z_test, subdiv=subdiv)

# analytical 'results' for comparison
z_expected = experiment_res(tri_refi.x, tri_refi.y)

# for the demo: loading the 'flat' triangles for plot
flat_tri = Triangulation(x_test, y_test)
flat_tri.set_mask(~mask)

#-----
# Now the plots
#-----
# User options for plots
plot_tri = True      # plot of base triangulation
plot_masked_tri = True # plot of excessively flat excluded triangles
plot_refi_tri = False # plot of refined triangulation
plot_expected = False # plot of analytical function values for comparison

# Graphical options for tricontouring
levels = np.arange(0., 1., 0.025)
cmap = cm.get_cmap(name='Blues', lut=None)

plt.figure()
plt.gca().set_aspect('equal')
plt.title("Filtering a Delaunay mesh\n" +
          "(application to high-resolution tricontouring)")

# 1) plot of the refined (computed) data contours:
plt.tricontour(tri_refi, z_test_refi, levels=levels, cmap=cmap,
               linewidths=[2.0, 0.5, 1.0, 0.5])
# 2) plot of the expected (analytical) data contours (dashed):
if plot_expected:
    plt.tricontour(tri_refi, z_expected, levels=levels, cmap=cmap,
                   linestyle='--')
# 3) plot of the fine mesh on which interpolation was done:
if plot_refi_tri:
    plt.triplot(tri_refi, color='0.97')
# 4) plot of the initial 'coarse' mesh:
if plot_tri:
    plt.triplot(tri, color='0.7')

```



```
# 4) plot of the unvalidated triangles from naive Delaunay Triangulation:
if plot_masked_tri:
    plt.triplot(flat_tri, color='red')

plt.show()
```

Keywords: python, matplotlib, pylab, example, codex (see [Search examples](#))

99.196 pylab_examples example code: tricontour_smooth_user.py

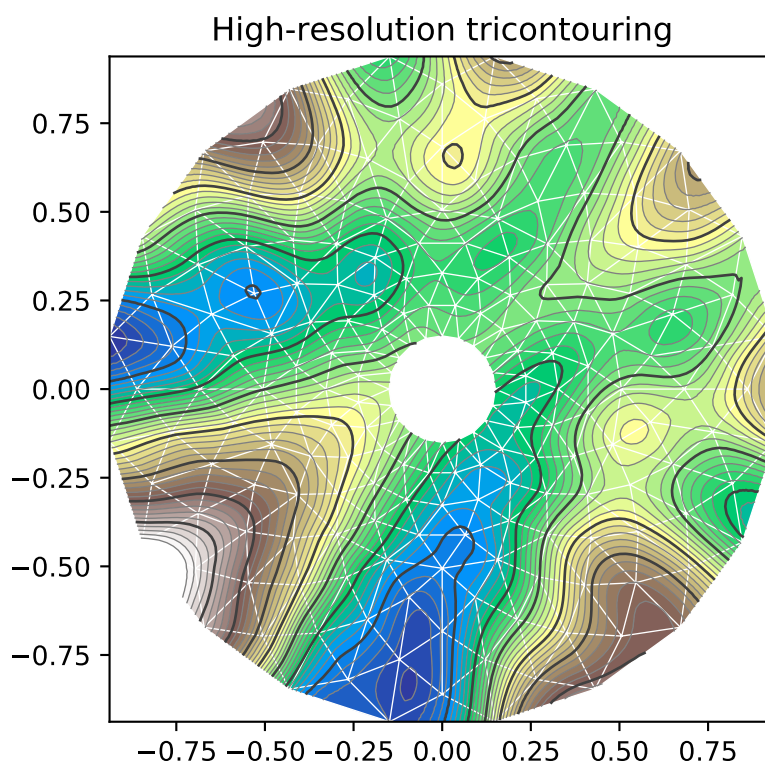

```
"""
Demonstrates high-resolution tricontouring on user-defined triangular grids
with matplotlib.tri.UniformTriRefiner
"""
import matplotlib.tri as tri
import matplotlib.pyplot as plt
import matplotlib.cm as cm
import numpy as np
import math

#-----
```

```

# Analytical test function
#-----
def function_z(x, y):
    """ A function of 2 variables """
    r1 = np.sqrt((0.5 - x)**2 + (0.5 - y)**2)
    theta1 = np.arctan2(0.5 - x, 0.5 - y)
    r2 = np.sqrt((-x - 0.2)**2 + (-y - 0.2)**2)
    theta2 = np.arctan2(-x - 0.2, -y - 0.2)
    z = -(2*(np.exp((r1/10)**2) - 1)*30. * np.cos(7.*theta1) +
          (np.exp((r2/10)**2) - 1)*30. * np.cos(11.*theta2) +
          0.7*(x**2 + y**2))
    return (np.max(z) - z)/(np.max(z) - np.min(z))

#-----
# Creating a Triangulation
#-----
# First create the x and y coordinates of the points.
n_angles = 20
n_radii = 10
min_radius = 0.15
radii = np.linspace(min_radius, 0.95, n_radii)

angles = np.linspace(0, 2*math.pi, n_angles, endpoint=False)
angles = np.repeat(angles[...], n_radii, axis=1)
angles[:, 1::2] += math.pi/n_angles

x = (radii*np.cos(angles)).flatten()
y = (radii*np.sin(angles)).flatten()
z = function_z(x, y)

# Now create the Triangulation.
# (Creating a Triangulation without specifying the triangles results in the
# Delaunay triangulation of the points.)
triang = tri.Triangulation(x, y)

# Mask off unwanted triangles.
xmid = x[triang.triangles].mean(axis=1)
ymid = y[triang.triangles].mean(axis=1)
mask = np.where(xmid*xmid + ymid*ymid < min_radius*min_radius, 1, 0)
triang.set_mask(mask)

#-----
# Refine data
#-----
refiner = tri.UniformTriRefiner(triang)
tri_refi, z_test_refi = refiner.refine_field(z, subdiv=3)

#-----
# Plot the triangulation and the high-res iso-contours
#-----
plt.figure()
plt.gca().set_aspect('equal')
plt.triplot(triang, lw=0.5, color='white')

```

```

levels = np.arange(0., 1., 0.025)
cmap = cm.get_cmap(name='terrain', lut=None)
plt.tricontourf(tri_ref, z_test_ref, levels=levels, cmap=cmap)
plt.tricontour(tri_ref, z_test_ref, levels=levels,
               colors=['0.25', '0.5', '0.5', '0.5', '0.5'],
               linewidths=[1.0, 0.5, 0.5, 0.5, 0.5])

plt.title("High-resolution tricontouring")

plt.show()

```

Keywords: python, matplotlib, pylab, example, codex (see [Search examples](#))

99.197 pylab_examples example code: tricontour_vs_griddata.py

griddata and contour (200 points, 20000 grid points)

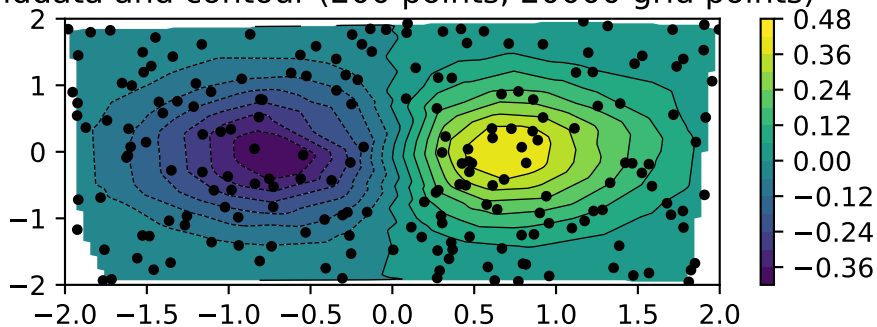

tricontour (200 points)

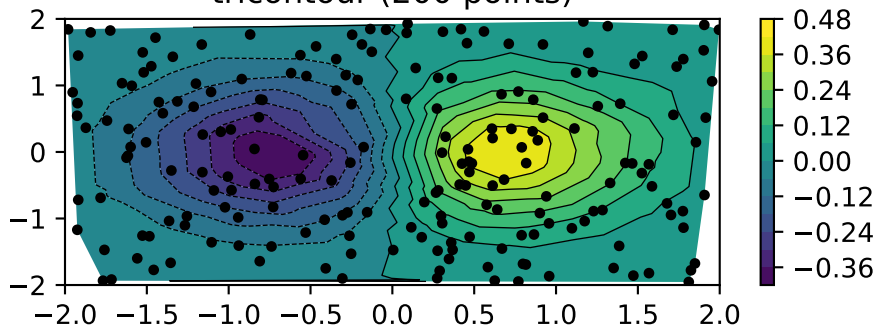

```

"""
Comparison of griddata and tricontour for an unstructured triangular grid.
"""
from __future__ import print_function
import matplotlib.pyplot as plt
import matplotlib.tri as tri

```

```

import numpy as np
import numpy.random as rnd
import matplotlib.mlab as mlab
import time

rnd.seed(0)
npts = 200
ngridx = 100
ngridy = 200
x = rnd.uniform(-2, 2, npts)
y = rnd.uniform(-2, 2, npts)
z = x*np.exp(-x**2 - y**2)

# griddata and contour.
start = time.clock()
plt.subplot(211)
xi = np.linspace(-2.1, 2.1, ngridx)
yi = np.linspace(-2.1, 2.1, ngridy)
zi = mlab.griddata(x, y, z, xi, yi, interp='linear')
plt.contour(xi, yi, zi, 15, linewidths=0.5, colors='k')
plt.contourf(xi, yi, zi, 15,
              norm=plt.Normalize(vmax=abs(zi).max(), vmin=-abs(zi).max()))
plt.colorbar() # draw colorbar
plt.plot(x, y, 'ko', ms=3)
plt.xlim(-2, 2)
plt.ylim(-2, 2)
plt.title('griddata and contour (%d points, %d grid points)' %
          (npts, ngridx*ngridy))
print('griddata and contour seconds: %f' % (time.clock() - start))

# tricontour.
start = time.clock()
plt.subplot(212)
triang = tri.Triangulation(x, y)
plt.tricontour(x, y, z, 15, linewidths=0.5, colors='k')
plt.tricontourf(x, y, z, 15,
                norm=plt.Normalize(vmax=abs(zi).max(), vmin=-abs(zi).max()))
plt.colorbar()
plt.plot(x, y, 'ko', ms=3)
plt.xlim(-2, 2)
plt.ylim(-2, 2)
plt.title('tricontour (%d points)' % npts)
print('tricontour seconds: %f' % (time.clock() - start))

plt.subplots_adjust(hspace=0.5)

plt.show()

```

Keywords: python, matplotlib, pylab, example, codex (see [Search examples](#))

99.198 pylab_examples example code: trigradient_demo.py

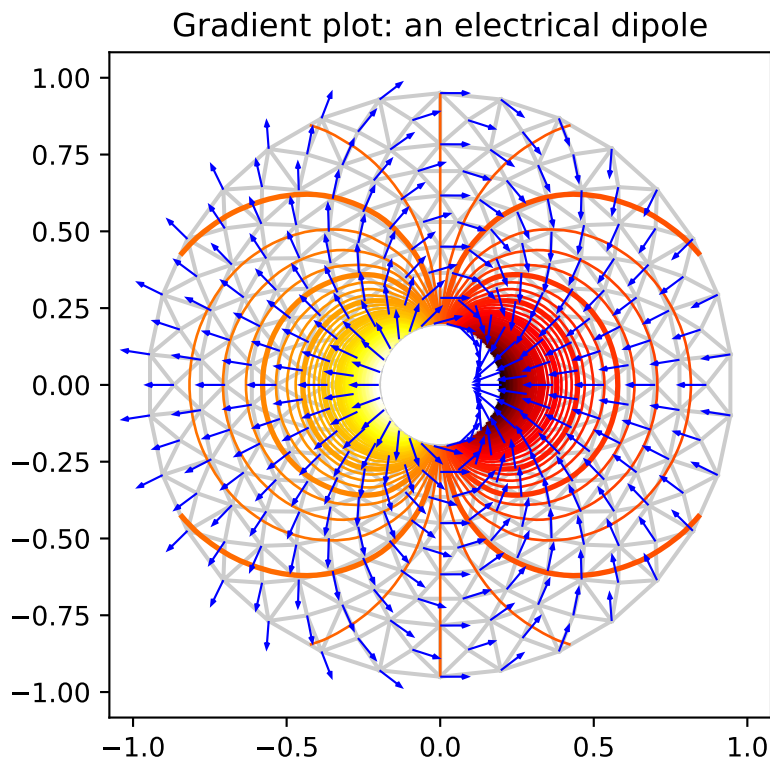

```

"""
Demonstrates computation of gradient with matplotlib.tri.CubicTriInterpolator.
"""
from matplotlib.tri import Triangulation, UniformTriRefiner,\
    CubicTriInterpolator
import matplotlib.pyplot as plt
import matplotlib.cm as cm
import numpy as np
import math

#-----
# Electrical potential of a dipole
#-----
def dipole_potential(x, y):
    """ The electric dipole potential V """
    r_sq = x**2 + y**2
    theta = np.arctan2(y, x)
    z = np.cos(theta)/r_sq
    return (np.max(z) - z) / (np.max(z) - np.min(z))

```

```

#-----
# Creating a Triangulation
#-----
# First create the x and y coordinates of the points.
n_angles = 30
n_radii = 10
min_radius = 0.2
radii = np.linspace(min_radius, 0.95, n_radii)

angles = np.linspace(0, 2*math.pi, n_angles, endpoint=False)
angles = np.repeat(angles[..., np.newaxis], n_radii, axis=1)
angles[:, 1::2] += math.pi/n_angles

x = (radii*np.cos(angles)).flatten()
y = (radii*np.sin(angles)).flatten()
V = dipole_potential(x, y)

# Create the Triangulation; no triangles specified so Delaunay triangulation
# created.
triang = Triangulation(x, y)

# Mask off unwanted triangles.
xmid = x[triang.triangles].mean(axis=1)
ymid = y[triang.triangles].mean(axis=1)
mask = np.where(xmid*xmid + ymid*ymid < min_radius*min_radius, 1, 0)
triang.set_mask(mask)

#-----
# Refine data - interpolates the electrical potential V
#-----
refiner = UniformTriRefiner(triang)
tri_refi, z_test_refi = refiner.refine_field(V, subdiv=3)

#-----
# Computes the electrical field (Ex, Ey) as gradient of electrical potential
#-----
tci = CubicTriInterpolator(triang, -V)
# Gradient requested here at the mesh nodes but could be anywhere else:
(Ex, Ey) = tci.gradient(triang.x, triang.y)
E_norm = np.sqrt(Ex**2 + Ey**2)

#-----
# Plot the triangulation, the potential iso-contours and the vector field
#-----
fig, ax = plt.subplots()
ax.set_aspect('equal')
# Enforce the margins, and enlarge them to give room for the vectors.
ax.use_sticky_edges = False
ax.margins(0.07)

ax.triplot(triang, color='0.8')

levels = np.arange(0., 1., 0.01)

```

```

cmap = cm.get_cmap(name='hot', lut=None)
ax.tricontour(tri_refi, z_test_refi, levels=levels, cmap=cmap,
              linewidths=[2.0, 1.0, 1.0, 1.0])
# Plots direction of the electrical vector field
ax.quiver(triang.x, triang.y, Ex/E_norm, Ey/E_norm,
          units='xy', scale=10., zorder=3, color='blue',
          width=0.007, headwidth=3., headlength=4.)

ax.set_title('Gradient plot: an electrical dipole')
plt.show()

```

Keywords: python, matplotlib, pylab, example, codex (see [Search examples](#))

99.199 pylab_examples example code: triinterp_demo.py

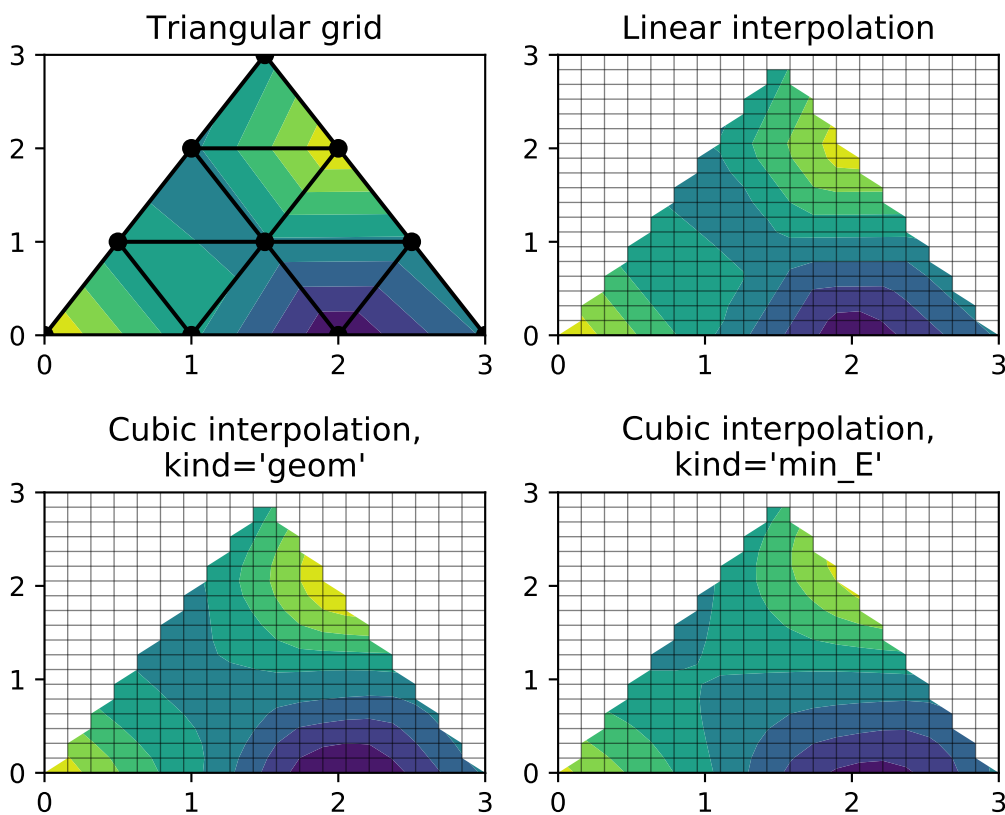

```

"""
Interpolation from triangular grid to quad grid.
"""
import matplotlib.pyplot as plt
import matplotlib.tri as mtri
import numpy as np

```

```

# Create triangulation.
x = np.asarray([0, 1, 2, 3, 0.5, 1.5, 2.5, 1, 2, 1.5])
y = np.asarray([0, 0, 0, 0, 1.0, 1.0, 1.0, 2, 2, 3.0])
triangles = [[0, 1, 4], [1, 2, 5], [2, 3, 6], [1, 5, 4], [2, 6, 5], [4, 5, 7],
             [5, 6, 8], [5, 8, 7], [7, 8, 9]]
triang = mtri.Triangulation(x, y, triangles)

# Interpolate to regularly-spaced quad grid.
z = np.cos(1.5*x)*np.cos(1.5*y)
xi, yi = np.meshgrid(np.linspace(0, 3, 20), np.linspace(0, 3, 20))

interp_lin = mtri.LinearTriInterpolator(triang, z)
zi_lin = interp_lin(xi, yi)

interp_cubic_geom = mtri.CubicTriInterpolator(triang, z, kind='geom')
zi_cubic_geom = interp_cubic_geom(xi, yi)

interp_cubic_min_E = mtri.CubicTriInterpolator(triang, z, kind='min_E')
zi_cubic_min_E = interp_cubic_min_E(xi, yi)

# Plot the triangulation.
plt.subplot(221)
plt.tricontourf(triang, z)
plt.triplot(triang, 'ko-')
plt.title('Triangular grid')

# Plot linear interpolation to quad grid.
plt.subplot(222)
plt.contourf(xi, yi, zi_lin)
plt.plot(xi, yi, 'k-', lw=0.5, alpha=0.5)
plt.plot(xi.T, yi.T, 'k-', lw=0.5, alpha=0.5)
plt.title("Linear interpolation")

# Plot cubic interpolation to quad grid, kind=geom
plt.subplot(223)
plt.contourf(xi, yi, zi_cubic_geom)
plt.plot(xi, yi, 'k-', lw=0.5, alpha=0.5)
plt.plot(xi.T, yi.T, 'k-', lw=0.5, alpha=0.5)
plt.title("Cubic interpolation,\nkind='geom'")

# Plot cubic interpolation to quad grid, kind=min_E
plt.subplot(224)
plt.contourf(xi, yi, zi_cubic_min_E)
plt.plot(xi, yi, 'k-', lw=0.5, alpha=0.5)
plt.plot(xi.T, yi.T, 'k-', lw=0.5, alpha=0.5)
plt.title("Cubic interpolation,\nkind='min_E'")

plt.tight_layout()
plt.show()

```

Keywords: python, matplotlib, pylab, example, codex (see [Search examples](#))

99.200 pylab_examples example code: tripcolor_demo.py

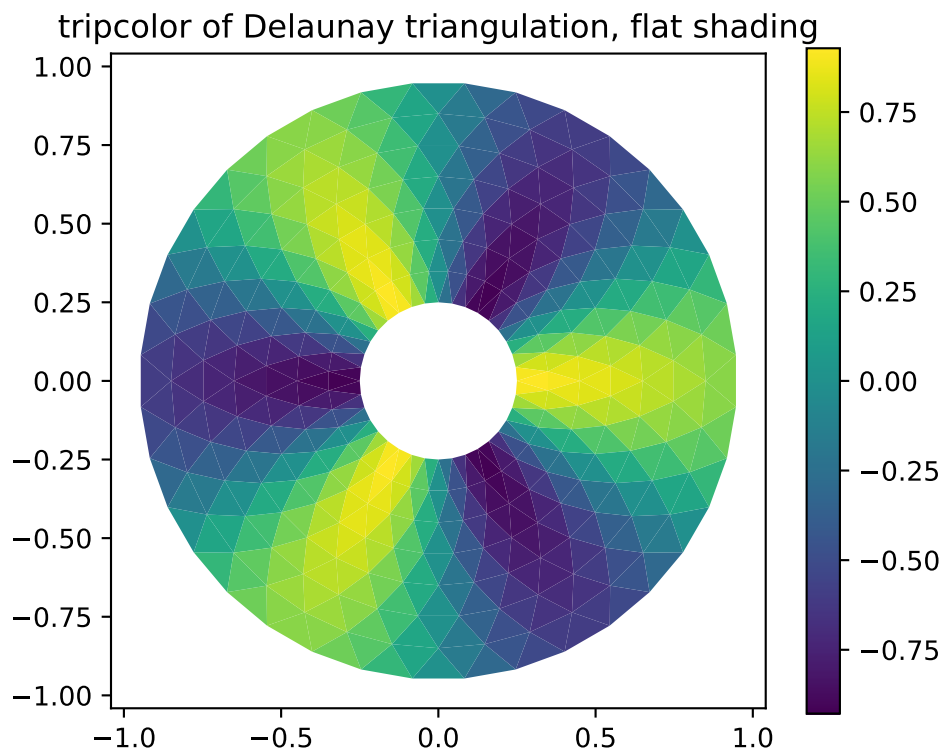

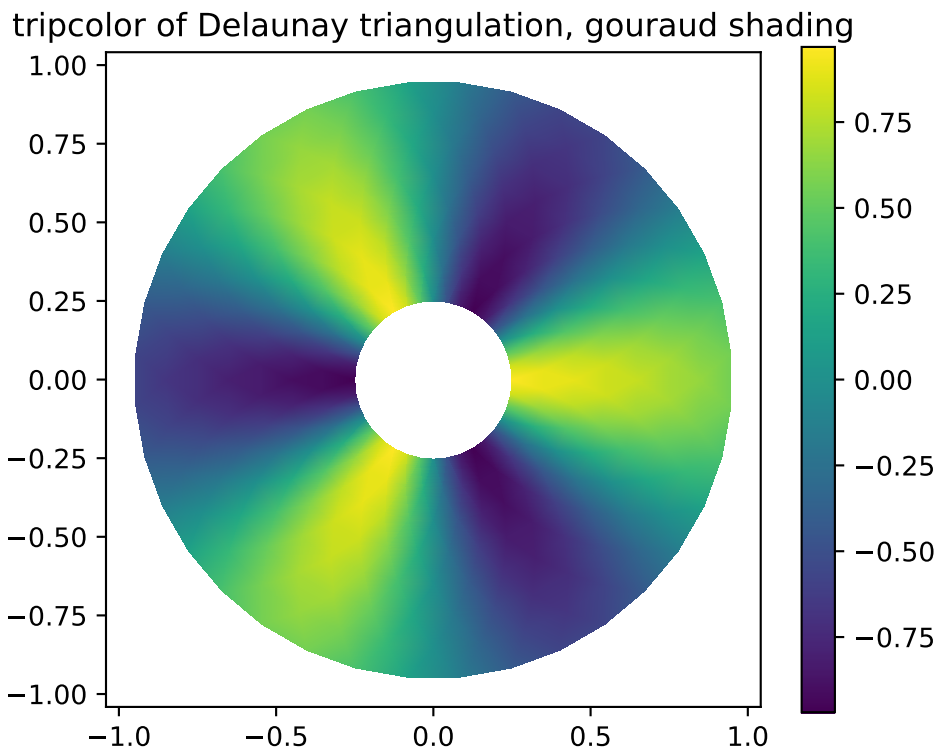

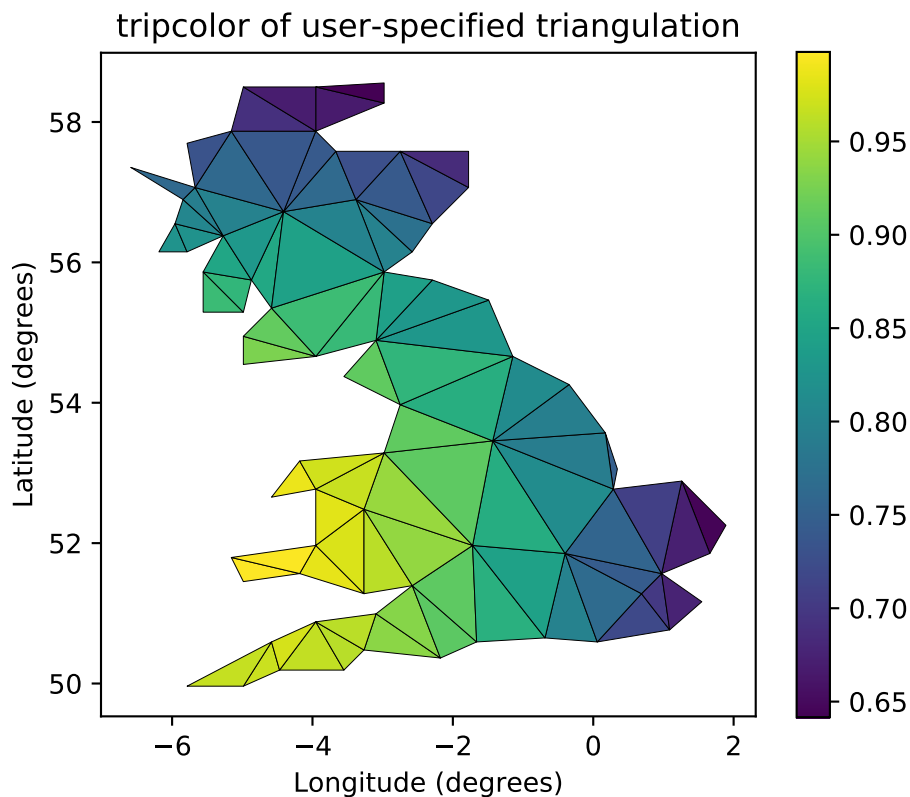

```

"""
Pseudocolor plots of unstructured triangular grids.
"""
import matplotlib.pyplot as plt
import matplotlib.tri as tri
import numpy as np
import math

# Creating a Triangulation without specifying the triangles results in the
# Delaunay triangulation of the points.

# First create the x and y coordinates of the points.
n_angles = 36
n_radii = 8
min_radius = 0.25
radii = np.linspace(min_radius, 0.95, n_radii)

angles = np.linspace(0, 2*math.pi, n_angles, endpoint=False)
angles = np.repeat(angles[..., np.newaxis], n_radii, axis=1)
angles[:, 1::2] += math.pi/n_angles

x = (radii*np.cos(angles)).flatten()
y = (radii*np.sin(angles)).flatten()
z = (np.cos(radii)*np.cos(angles*3.0)).flatten()

# Create the Triangulation; no triangles so Delaunay triangulation created.

```

```

triang = tri.Triangulation(x, y)

# Mask off unwanted triangles.
xmid = x[triang.triangles].mean(axis=1)
ymid = y[triang.triangles].mean(axis=1)
mask = np.where(xmid*xmid + ymid*ymid < min_radius*min_radius, 1, 0)
triang.set_mask(mask)

# tripcolor plot.
plt.figure()
plt.gca().set_aspect('equal')
plt.tripcolor(triang, z, shading='flat')
plt.colorbar()
plt.title('tripcolor of Delaunay triangulation, flat shading')

# Illustrate Gouraud shading.
plt.figure()
plt.gca().set_aspect('equal')
plt.tripcolor(triang, z, shading='gouraud')
plt.colorbar()
plt.title('tripcolor of Delaunay triangulation, gouraud shading')

# You can specify your own triangulation rather than perform a Delaunay
# triangulation of the points, where each triangle is given by the indices of
# the three points that make up the triangle, ordered in either a clockwise or
# anticlockwise manner.

xy = np.asarray([
    [-0.101, 0.872], [-0.080, 0.883], [-0.069, 0.888], [-0.054, 0.890],
    [-0.045, 0.897], [-0.057, 0.895], [-0.073, 0.900], [-0.087, 0.898],
    [-0.090, 0.904], [-0.069, 0.907], [-0.069, 0.921], [-0.080, 0.919],
    [-0.073, 0.928], [-0.052, 0.930], [-0.048, 0.942], [-0.062, 0.949],
    [-0.054, 0.958], [-0.069, 0.954], [-0.087, 0.952], [-0.087, 0.959],
    [-0.080, 0.966], [-0.085, 0.973], [-0.087, 0.965], [-0.097, 0.965],
    [-0.097, 0.975], [-0.092, 0.984], [-0.101, 0.980], [-0.108, 0.980],
    [-0.104, 0.987], [-0.102, 0.993], [-0.115, 1.001], [-0.099, 0.996],
    [-0.101, 1.007], [-0.090, 1.010], [-0.087, 1.021], [-0.069, 1.021],
    [-0.052, 1.022], [-0.052, 1.017], [-0.069, 1.010], [-0.064, 1.005],
    [-0.048, 1.005], [-0.031, 1.005], [-0.031, 0.996], [-0.040, 0.987],
    [-0.045, 0.980], [-0.052, 0.975], [-0.040, 0.973], [-0.026, 0.968],
    [-0.020, 0.954], [-0.006, 0.947], [ 0.003, 0.935], [ 0.006, 0.926],
    [ 0.005, 0.921], [ 0.022, 0.923], [ 0.033, 0.912], [ 0.029, 0.905],
    [ 0.017, 0.900], [ 0.012, 0.895], [ 0.027, 0.893], [ 0.019, 0.886],
    [ 0.001, 0.883], [-0.012, 0.884], [-0.029, 0.883], [-0.038, 0.879],
    [-0.057, 0.881], [-0.062, 0.876], [-0.078, 0.876], [-0.087, 0.872],
    [-0.030, 0.907], [-0.007, 0.905], [-0.057, 0.916], [-0.025, 0.933],
    [-0.077, 0.990], [-0.059, 0.993]])
x = xy[:, 0]*180/3.14159
y = xy[:, 1]*180/3.14159

triangles = np.asarray([
    [67, 66, 1], [65, 2, 66], [1, 66, 2], [64, 2, 65], [63, 3, 64],

```

```

[60, 59, 57], [ 2, 64,  3], [ 3, 63,  4], [ 0, 67,  1], [62,  4, 63],
[57, 59, 56], [59, 58, 56], [61, 60, 69], [57, 69, 60], [ 4, 62, 68],
[ 6,  5,  9], [61, 68, 62], [69, 68, 61], [ 9,  5, 70], [ 6,  8,  7],
[ 4, 70,  5], [ 8,  6,  9], [56, 69, 57], [69, 56, 52], [70, 10,  9],
[54, 53, 55], [56, 55, 53], [68, 70,  4], [52, 56, 53], [11, 10, 12],
[69, 71, 68], [68, 13, 70], [10, 70, 13], [51, 50, 52], [13, 68, 71],
[52, 71, 69], [12, 10, 13], [71, 52, 50], [71, 14, 13], [50, 49, 71],
[49, 48, 71], [14, 16, 15], [14, 71, 48], [17, 19, 18], [17, 20, 19],
[48, 16, 14], [48, 47, 16], [47, 46, 16], [16, 46, 45], [23, 22, 24],
[21, 24, 22], [17, 16, 45], [20, 17, 45], [21, 25, 24], [27, 26, 28],
[20, 72, 21], [25, 21, 72], [45, 72, 20], [25, 28, 26], [44, 73, 45],
[72, 45, 73], [28, 25, 29], [29, 25, 31], [43, 73, 44], [73, 43, 40],
[72, 73, 39], [72, 31, 25], [42, 40, 43], [31, 30, 29], [39, 73, 40],
[42, 41, 40], [72, 33, 31], [32, 31, 33], [39, 38, 72], [33, 72, 38],
[33, 38, 34], [37, 35, 38], [34, 38, 35], [35, 37, 36]])

xmid = x[triangles].mean(axis=1)
ymid = y[triangles].mean(axis=1)
x0 = -5
y0 = 52
zfaces = np.exp(-0.01*((xmid - x0)*(xmid - x0) + (ymid - y0)*(ymid - y0)))

# Rather than create a Triangulation object, can simply pass x, y and triangles
# arrays to tripcolor directly. It would be better to use a Triangulation
# object if the same triangulation was to be used more than once to save
# duplicated calculations.
# Can specify one color value per face rather than one per point by using the
# facecolors kwarg.
plt.figure()
plt.gca().set_aspect('equal')
plt.tripcolor(x, y, triangles, facecolors=zfaces, edgecolors='k')
plt.colorbar()
plt.title('tripcolor of user-specified triangulation')
plt.xlabel('Longitude (degrees)')
plt.ylabel('Latitude (degrees)')

plt.show()

```

Keywords: python, matplotlib, pylab, example, codex (see [Search examples](#))

99.201 pylab_examples example code: triplot_demo.py

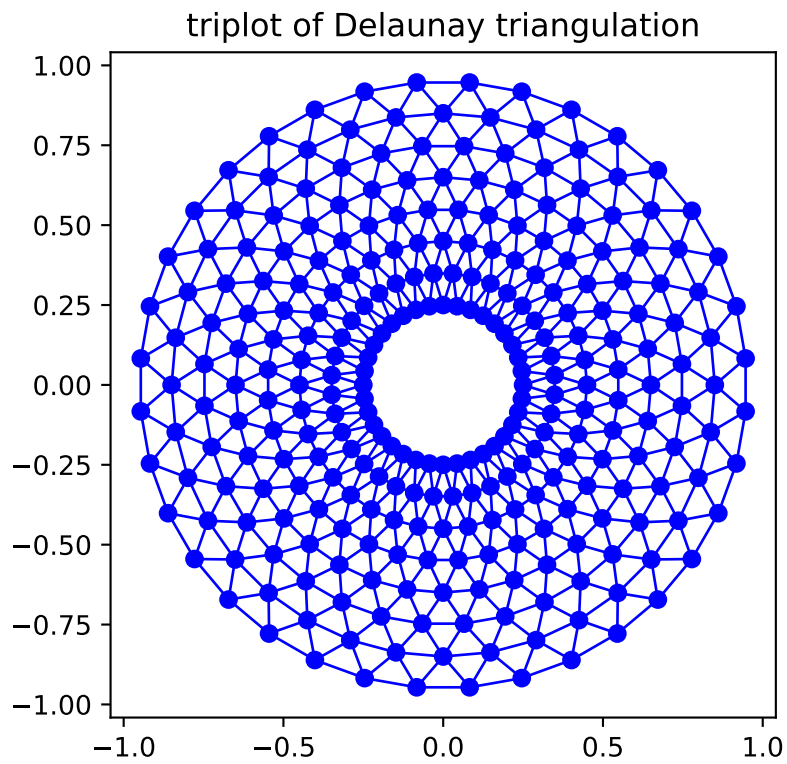

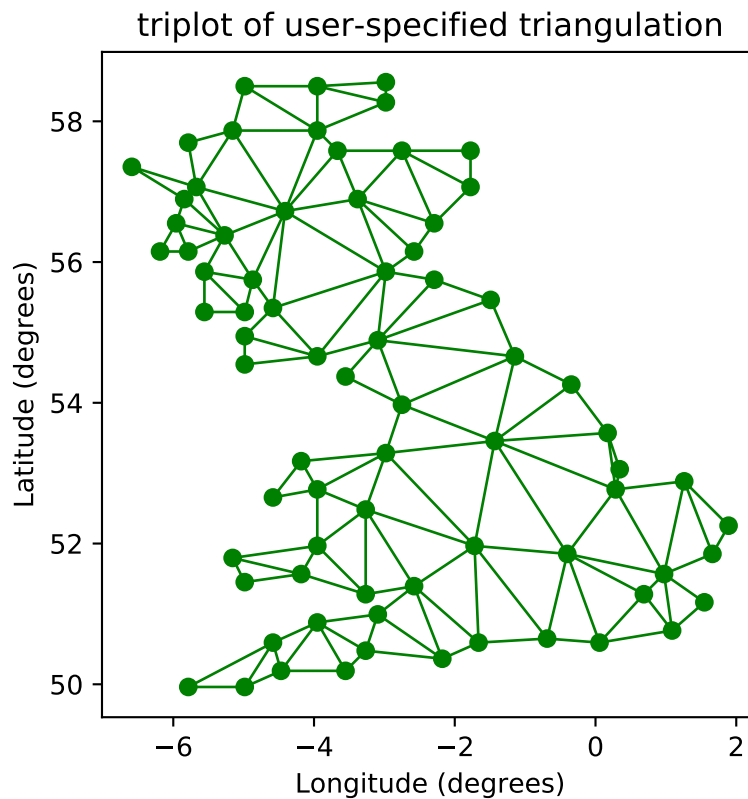

```

"""
Creating and plotting unstructured triangular grids.
"""
import matplotlib.pyplot as plt
import matplotlib.tri as tri
import numpy as np
import math

# Creating a Triangulation without specifying the triangles results in the
# Delaunay triangulation of the points.

# First create the x and y coordinates of the points.
n_angles = 36
n_radii = 8
min_radius = 0.25
radii = np.linspace(min_radius, 0.95, n_radii)

angles = np.linspace(0, 2*math.pi, n_angles, endpoint=False)
angles = np.repeat(angles[..., np.newaxis], n_radii, axis=1)
angles[:, 1::2] += math.pi/n_angles

x = (radii*np.cos(angles)).flatten()
y = (radii*np.sin(angles)).flatten()

# Create the Triangulation; no triangles so Delaunay triangulation created.
triang = tri.Triangulation(x, y)

```

```

# Mask off unwanted triangles.
xmid = x[triang.triangles].mean(axis=1)
ymid = y[triang.triangles].mean(axis=1)
mask = np.where(xmid*xmid + ymid*ymid < min_radius*min_radius, 1, 0)
triang.set_mask(mask)

# Plot the triangulation.
plt.figure()
plt.gca().set_aspect('equal')
plt.triplot(triang, 'bo-', lw=1)
plt.title('triplot of Delaunay triangulation')

# You can specify your own triangulation rather than perform a Delaunay
# triangulation of the points, where each triangle is given by the indices of
# the three points that make up the triangle, ordered in either a clockwise or
# anticlockwise manner.

xy = np.asarray([
    [-0.101, 0.872], [-0.080, 0.883], [-0.069, 0.888], [-0.054, 0.890],
    [-0.045, 0.897], [-0.057, 0.895], [-0.073, 0.900], [-0.087, 0.898],
    [-0.090, 0.904], [-0.069, 0.907], [-0.069, 0.921], [-0.080, 0.919],
    [-0.073, 0.928], [-0.052, 0.930], [-0.048, 0.942], [-0.062, 0.949],
    [-0.054, 0.958], [-0.069, 0.954], [-0.087, 0.952], [-0.087, 0.959],
    [-0.080, 0.966], [-0.085, 0.973], [-0.087, 0.965], [-0.097, 0.965],
    [-0.097, 0.975], [-0.092, 0.984], [-0.101, 0.980], [-0.108, 0.980],
    [-0.104, 0.987], [-0.102, 0.993], [-0.115, 1.001], [-0.099, 0.996],
    [-0.101, 1.007], [-0.090, 1.010], [-0.087, 1.021], [-0.069, 1.021],
    [-0.052, 1.022], [-0.052, 1.017], [-0.069, 1.010], [-0.064, 1.005],
    [-0.048, 1.005], [-0.031, 1.005], [-0.031, 0.996], [-0.040, 0.987],
    [-0.045, 0.980], [-0.052, 0.975], [-0.040, 0.973], [-0.026, 0.968],
    [-0.020, 0.954], [-0.006, 0.947], [ 0.003, 0.935], [ 0.006, 0.926],
    [ 0.005, 0.921], [ 0.022, 0.923], [ 0.033, 0.912], [ 0.029, 0.905],
    [ 0.017, 0.900], [ 0.012, 0.895], [ 0.027, 0.893], [ 0.019, 0.886],
    [ 0.001, 0.883], [-0.012, 0.884], [-0.029, 0.883], [-0.038, 0.879],
    [-0.057, 0.881], [-0.062, 0.876], [-0.078, 0.876], [-0.087, 0.872],
    [-0.030, 0.907], [-0.007, 0.905], [-0.057, 0.916], [-0.025, 0.933],
    [-0.077, 0.990], [-0.059, 0.993]])
x = np.degrees(xy[:, 0])
y = np.degrees(xy[:, 1])

triangles = np.asarray([
    [67, 66, 1], [65, 2, 66], [1, 66, 2], [64, 2, 65], [63, 3, 64],
    [60, 59, 57], [2, 64, 3], [3, 63, 4], [0, 67, 1], [62, 4, 63],
    [57, 59, 56], [59, 58, 56], [61, 60, 69], [57, 69, 60], [4, 62, 68],
    [6, 5, 9], [61, 68, 62], [69, 68, 61], [9, 5, 70], [6, 8, 7],
    [4, 70, 5], [8, 6, 9], [56, 69, 57], [69, 56, 52], [70, 10, 9],
    [54, 53, 55], [56, 55, 53], [68, 70, 4], [52, 56, 53], [11, 10, 12],
    [69, 71, 68], [68, 13, 70], [10, 70, 13], [51, 50, 52], [13, 68, 71],
    [52, 71, 69], [12, 10, 13], [71, 52, 50], [71, 14, 13], [50, 49, 71],
    [49, 48, 71], [14, 16, 15], [14, 71, 48], [17, 19, 18], [17, 20, 19],
    [48, 16, 14], [48, 47, 16], [47, 46, 16], [16, 46, 45], [23, 22, 24],

```



```
[21, 24, 22], [17, 16, 45], [20, 17, 45], [21, 25, 24], [27, 26, 28],
[20, 72, 21], [25, 21, 72], [45, 72, 20], [25, 28, 26], [44, 73, 45],
[72, 45, 73], [28, 25, 29], [29, 25, 31], [43, 73, 44], [73, 43, 40],
[72, 73, 39], [72, 31, 25], [42, 40, 43], [31, 30, 29], [39, 73, 40],
[42, 41, 40], [72, 33, 31], [32, 31, 33], [39, 38, 72], [33, 72, 38],
[33, 38, 34], [37, 35, 38], [34, 38, 35], [35, 37, 36]])

# Rather than create a Triangulation object, can simply pass x, y and triangles
# arrays to triplot directly. It would be better to use a Triangulation object
# if the same triangulation was to be used more than once to save duplicated
# calculations.
plt.figure()
plt.gca().set_aspect('equal')
plt.triplot(x, y, triangles, 'go-', lw=1.0)
plt.title('triplot of user-specified triangulation')
plt.xlabel('Longitude (degrees)')
plt.ylabel('Latitude (degrees)')

plt.show()
```

Keywords: python, matplotlib, pylab, example, codex (see [Search examples](#))

99.202 pylab_examples example code: usetex_baseline_test.py

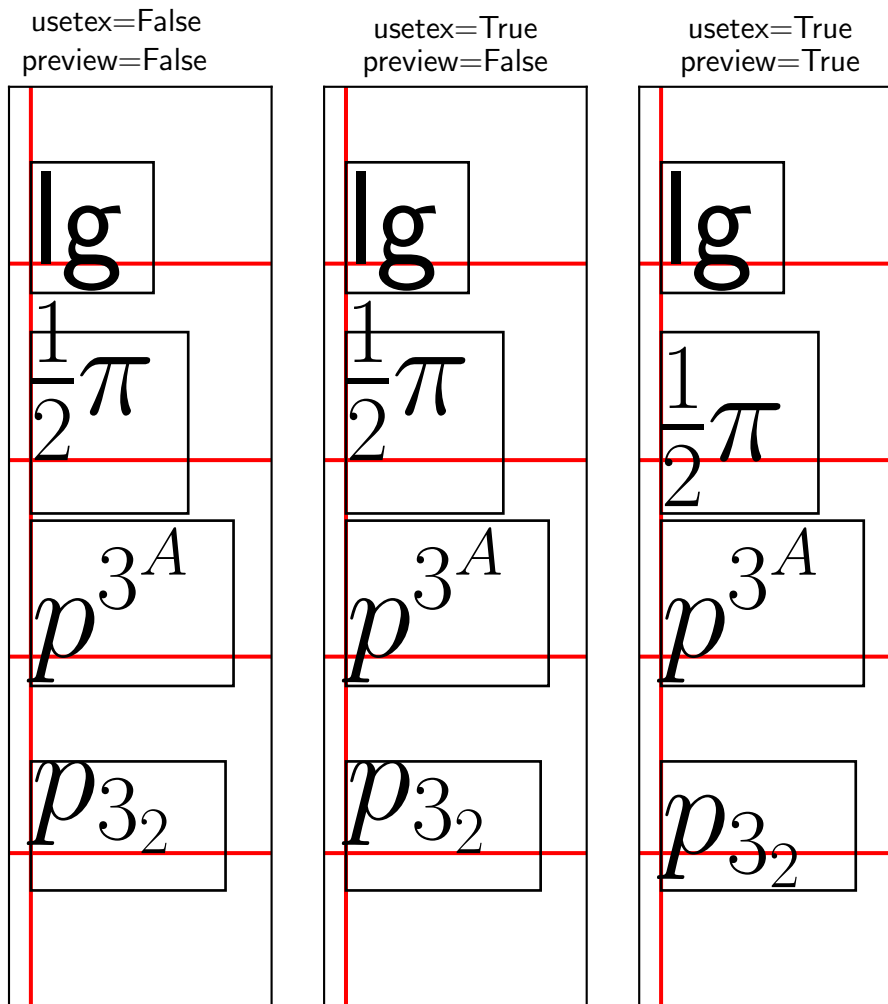

```
import matplotlib
import matplotlib.pyplot as plt
import matplotlib.axes as maxes

from matplotlib import rcParams
rcParams['text.usetex'] = True
rcParams['text.latex.unicode'] = True

class Axes(maxes.Axes):
```

```

"""
A hackish way to simultaneously draw texts w/ usetex=True and
usetex=False in the same figure. It does not work in the ps backend.
"""

def __init__(self, *kl, **kw):
    self.usetex = kw.pop("usetex", "False")
    self.preview = kw.pop("preview", "False")

    maxes.Axes.__init__(self, *kl, **kw)

def draw(self, renderer):
    usetex = plt.rcParams["text.usetex"]
    preview = plt.rcParams["text.latex.preview"]
    plt.rcParams["text.usetex"] = self.usetex
    plt.rcParams["text.latex.preview"] = self.preview

    maxes.Axes.draw(self, renderer)

    plt.rcParams["text.usetex"] = usetex
    plt.rcParams["text.latex.preview"] = preview

subplot = maxes.subplot_class_factory(Axes)

def test_window_extent(ax, usetex, preview):

    va = "baseline"
    ax.xaxis.set_visible(False)
    ax.yaxis.set_visible(False)

    #t = ax.text(0., 0., r"mlp", va="baseline", size=150)
    text_kw = dict(va=va,
                   size=50,
                   bbox=dict(pad=0., ec="k", fc="none"))

    test_strings = ["lg", r"\frac{1}{2}\pi$",
                   r"$p^{3^A}$", r"$p_{3_2}$"]

    ax.axvline(0, color="r")

    for i, s in enumerate(test_strings):

        ax.axhline(i, color="r")
        ax.text(0., 3 - i, s, **text_kw)

    ax.set_xlim(-0.1, 1.1)
    ax.set_ylim(-.8, 3.9)

    ax.set_title("usetex=%s\npreview=%s" % (str(usetex), str(preview)))

fig = plt.figure(figsize=(2.*3, 6.5))

```

```

for i, usetex, preview in [[0, False, False],
                           [1, True, False],
                           [2, True, True]]:
    ax = subplot(fig, 1, 3, i + 1, usetex=usetex, preview=preview)
    fig.add_subplot(ax)
    fig.subplots_adjust(top=0.85)

    test_window_extent(ax, usetex=usetex, preview=preview)

plt.draw()
plt.show()

```

Keywords: python, matplotlib, pylab, example, codex (see [Search examples](#))

99.203 pylab_examples example code: usetex_demo.py

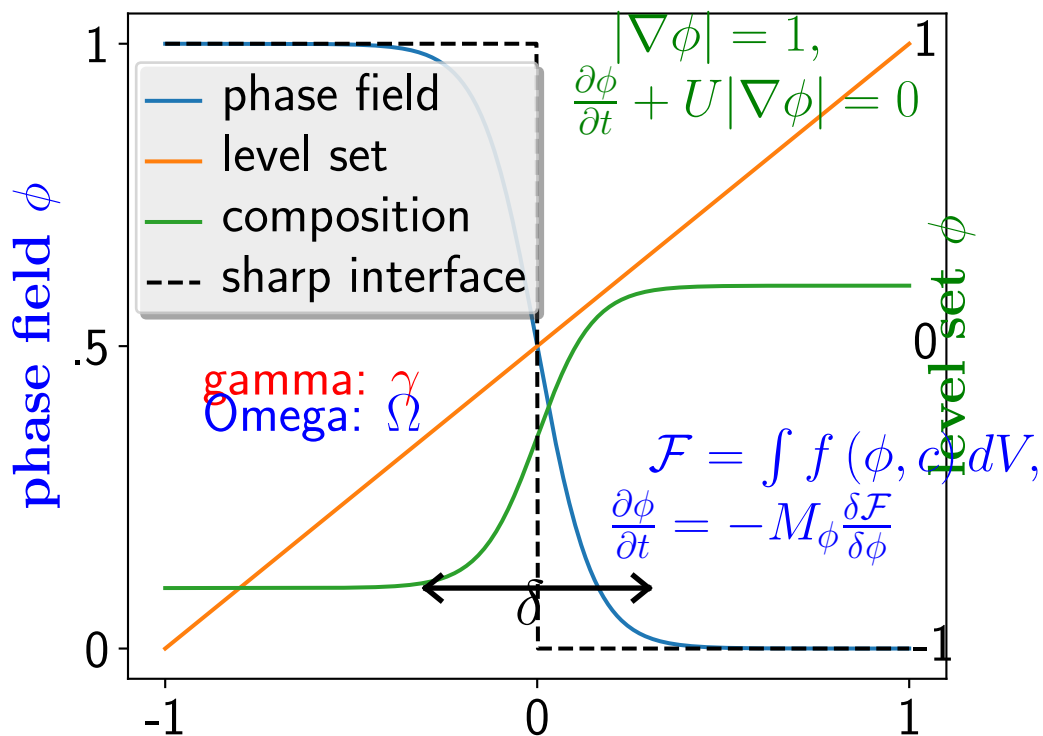

```

import matplotlib
matplotlib.rc('text', usetex=True)
import matplotlib.pyplot as plt
import numpy as np

```

```

# interface tracking profiles
N = 500
delta = 0.6
X = np.linspace(-1, 1, N)
plt.plot(X, (1 - np.tanh(4.*X/delta))/2,      # phase field tanh profiles
         X, (X + 1)/2,                       # level set distance function
         X, (1.4 + np.tanh(4.*X/delta))/4,  # composition profile
         X, X < 0, 'k--',                   # sharp interface
         )

# legend
plt.legend(('phase field', 'level set', 'composition', 'sharp interface'), shadow=True,
          loc=(0.01, 0.55))

ltext = plt.gca().get_legend().get_texts()
plt.setp(ltext[0], fontsize=20)
plt.setp(ltext[1], fontsize=20)
plt.setp(ltext[2], fontsize=20)
plt.setp(ltext[3], fontsize=20)

# the arrow
height = 0.1
offset = 0.02
plt.plot((-delta / 2., delta / 2), (height, height), 'k', linewidth=2)
plt.plot((-delta / 2, -delta / 2 + offset * 2), (height, height - offset), 'k',
         linewidth=2)
plt.plot((-delta / 2, -delta / 2 + offset * 2), (height, height + offset), 'k',
         linewidth=2)
plt.plot((delta / 2, delta / 2 - offset * 2), (height, height - offset), 'k',
         linewidth=2)
plt.plot((delta / 2, delta / 2 - offset * 2), (height, height + offset), 'k',
         linewidth=2)
plt.text(-0.06, height - 0.06, r'$\delta$', {'color': 'k', 'fontsize': 24})

# X-axis label
plt.xticks((-1, 0, 1), ('-1', '0', '1'), color='k', size=20)

# Left Y-axis labels
plt.ylabel(r'\bf{phase field} $\phi$', {'color': 'b',
                                       'fontsize': 20})
plt.yticks((0, 0.5, 1), ('0', '.5', '1'), color='k', size=20)

# Right Y-axis labels
plt.text(1.05, 0.5, r'\bf{level set} $\phi$', {'color': 'g', 'fontsize': 20},
        horizontalalignment='left',
        verticalalignment='center',
        rotation=90,
        clip_on=False)
plt.text(1.01, -0.02, "-1", {'color': 'k', 'fontsize': 20})
plt.text(1.01, 0.98, "1", {'color': 'k', 'fontsize': 20})
plt.text(1.01, 0.48, "0", {'color': 'k', 'fontsize': 20})

```

```
# level set equations
plt.text(0.1, 0.85,
        r'$|\nabla\phi| = 1,$ \newline $ \frac{\partial \phi}{\partial t}$'
        r'+ U|\nabla \phi| = 0$',
        {'color': 'g', 'fontsize': 20})

# phase field equations
plt.text(0.2, 0.15,
        r'$\mathcal{F} = \int f\left( \phi, c \right) dV,$ \newline '
        r'$ \frac{\partial \phi}{\partial t} = -M_{\phi}$ '
        r'$\frac{\delta \mathcal{F}}{\delta \phi}$',
        {'color': 'b', 'fontsize': 20})

# these went wrong in pdf in a previous version
plt.text(-.9, .42, r'gamma: $\gamma$', {'color': 'r', 'fontsize': 20})
plt.text(-.9, .36, r'Omega: $\Omega$', {'color': 'b', 'fontsize': 20})

plt.show()
```

Keywords: python, matplotlib, pylab, example, codex (see [Search examples](#))

99.204 pylab_examples example code: usetex_fonteffects.py

Usetex font effects

Nimbus Roman No9 L (extended)

Nimbus Roman No9 L (condensed)

Nimbus Roman No9 L (slanted)

Nimbus Roman No9 L Italics (real italics for con

Nimbus Roman No9 L

```

# This script demonstrates that font effects specified in your pdftex.map
# are now supported in pdf usetex.

import matplotlib
import matplotlib.pyplot as plt
matplotlib.rc('text', usetex=True)

def setfont(font):
    return r'\font\A %s at 14pt\A ' % font

for y, font, text in zip(range(5),
                        ['ptmr8r', 'ptmri8r', 'ptmro8r', 'ptmr8rn', 'ptmrr8re'],
                        ['Nimbus Roman No9 L ' + x for x in
                        ['', 'Italics (real italics for comparison)',
                        '(slanted)', '(condensed)', '(extended)']):
    plt.text(0, y, setfont(font) + text)

plt.ylim(-1, 5)
plt.xlim(-0.2, 0.6)
plt.setp(plt.gca(), frame_on=False, xticks=(), yticks=())
plt.title('Usetex font effects')
plt.savefig('usetex_fonteffects.pdf')

```

Keywords: python, matplotlib, pylab, example, codex (see [Search examples](#))

99.205 pylab_examples example code: vline_hline_demo.py

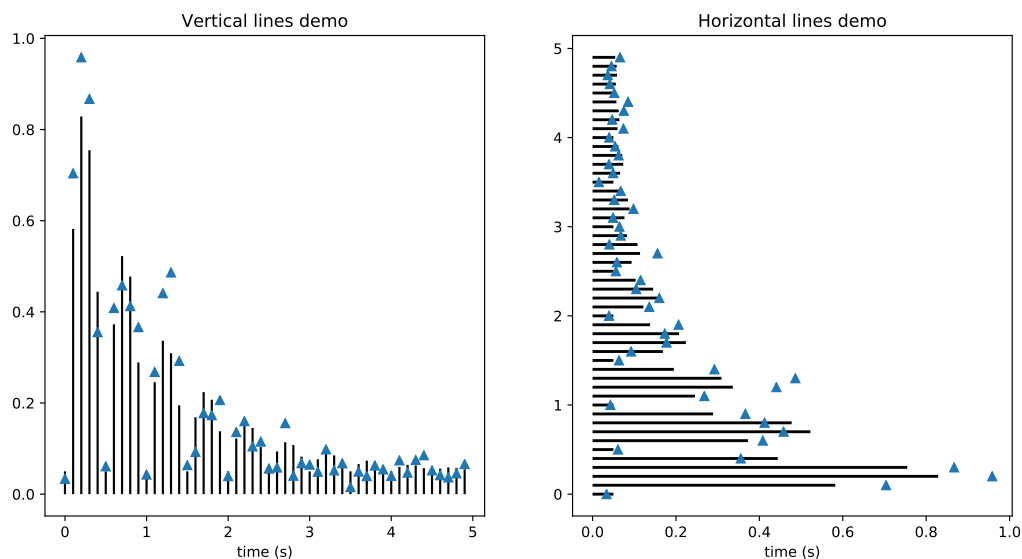

```

"""
Small demonstration of the hlines and vlines plots.

```

```

"""

import matplotlib.pyplot as plt
import numpy as np
import numpy.random as rnd

def f(t):
    s1 = np.sin(2 * np.pi * t)
    e1 = np.exp(-t)
    return np.absolute((s1 * e1)) + .05

t = np.arange(0.0, 5.0, 0.1)
s = f(t)
nse = rnd.normal(0.0, 0.3, t.shape) * s

fig = plt.figure(figsize=(12, 6))
vax = fig.add_subplot(121)
hax = fig.add_subplot(122)

vax.plot(t, s + nse, '^')
vax.vlines(t, [0], s)
vax.set_xlabel('time (s)')
vax.set_title('Vertical lines demo')

hax.plot(s + nse, t, '^')
hax.hlines(t, [0], s, lw=2)
hax.set_xlabel('time (s)')
hax.set_title('Horizontal lines demo')

plt.show()

```

Keywords: python, matplotlib, pylab, example, codex (see [Search examples](#))

99.206 pylab_examples example code: webapp_demo.py

[source code]

```

# -*- noplots -*-
"""
This example shows how to use the agg backend directly to create
images, which may be of use to web application developers who want
full control over their code without using the pyplot interface to
manage figures, figure closing etc.

.. note::

    It is not necessary to avoid using the pyplot interface in order to
    create figures without a graphical front-end - simply setting
    the backend to "Agg" would be sufficient.

```

It is also worth noting that, because matplotlib can save figures to file-like object, matplotlib can also be used inside a cgi-script **without** needing to write a figure to disk.

```

"""

from matplotlib.backends.backend_agg import FigureCanvasAgg
from matplotlib.figure import Figure
import numpy as np

def make_fig():
    """
    Make a figure and save it to "webagg.png".

    """
    fig = Figure()
    ax = fig.add_subplot(1, 1, 1)

    ax.plot([1, 2, 3], 'ro--', markersize=12, markerfacecolor='g')

    # make a translucent scatter collection
    x = np.random.rand(100)
    y = np.random.rand(100)
    area = np.pi * (10 * np.random.rand(100)) ** 2 # 0 to 10 point radii
    c = ax.scatter(x, y, area)
    c.set_alpha(0.5)

    # add some text decoration
    ax.set_title('My first image')
    ax.set_ylabel('Some numbers')
    ax.set_xticks((.2, .4, .6, .8))
    labels = ax.set_xticklabels(('Bill', 'Fred', 'Ted', 'Ed'))

    # To set object properties, you can either iterate over the
    # objects manually, or define you own set command, as in setapi
    # above.
    for label in labels:
        label.set_rotation(45)
        label.set_fontsize(12)

    FigureCanvasAgg(fig).print_png('webagg.png', dpi=150)

make_fig()

```

Keywords: python, matplotlib, pylab, example, codex (see [Search examples](#))

99.207 pylab_examples example code: xcorr_demo.py

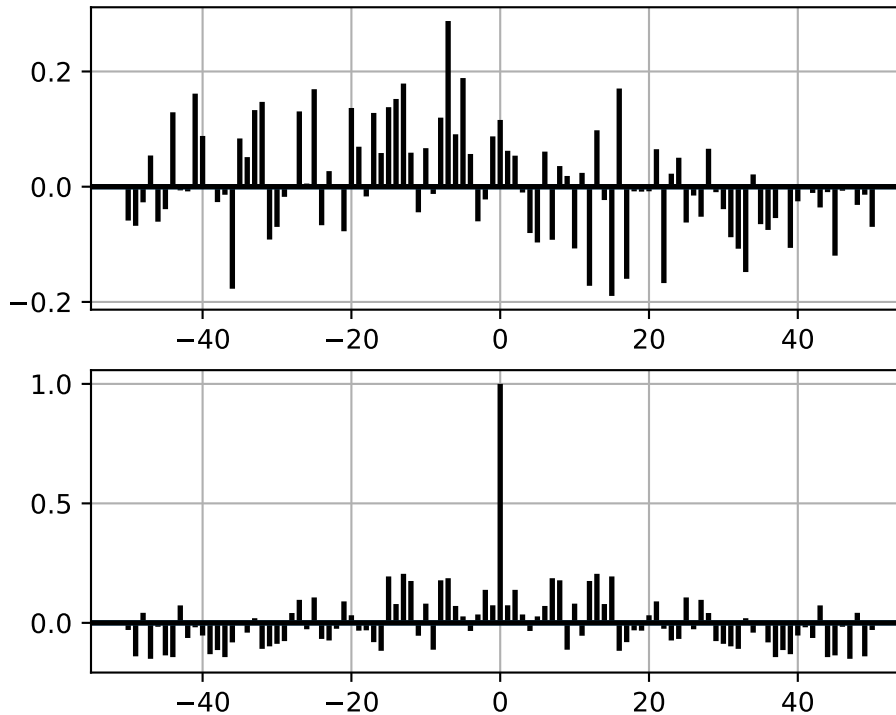

```
import matplotlib.pyplot as plt
import numpy as np

np.random.seed(0)

x, y = np.random.randn(2, 100)
fig = plt.figure()
ax1 = fig.add_subplot(211)
ax1.xcorr(x, y, usevlines=True, maxlags=50, normed=True, lw=2)
ax1.grid(True)
ax1.axhline(0, color='black', lw=2)

ax2 = fig.add_subplot(212, sharex=ax1)
ax2.acorr(x, usevlines=True, normed=True, maxlags=50, lw=2)
ax2.grid(True)
ax2.axhline(0, color='black', lw=2)

plt.show()
```

Keywords: python, matplotlib, pylab, example, codex (see [Search examples](#))

99.208 pylab_examples example code: zorder_demo.py

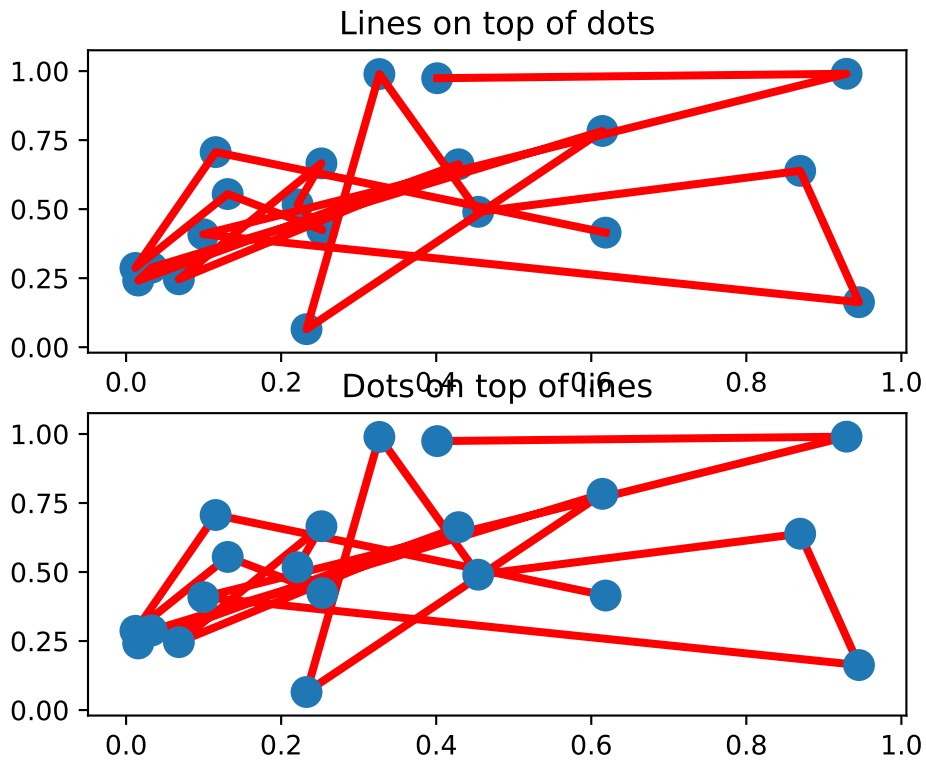

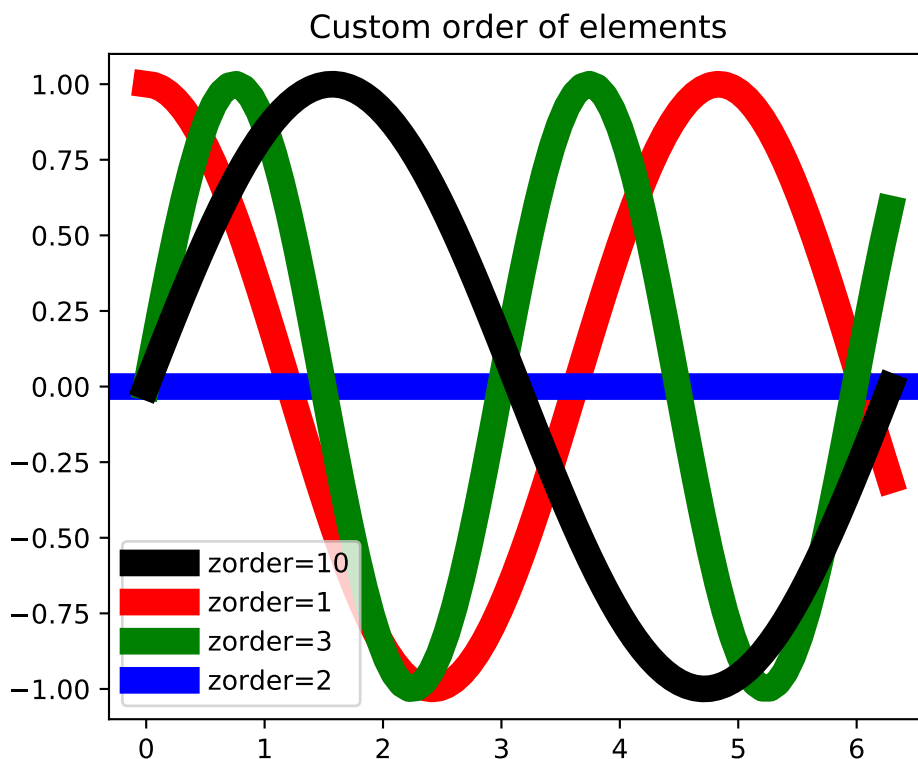

```
"""
The default drawing order for axes is patches, lines, text. This
order is determined by the zorder attribute. The following defaults
are set
```

Artist	Z-order
Patch / PatchCollection	1
Line2D / LineCollection	2
Text	3

You can change the order for individual artists by setting the zorder. Any individual plot() call can set a value for the zorder of that particular item.

In the first subplot below, the lines are drawn above the patch collection from the scatter, which is the default.

In the subplot below, the order is reversed.

The second figure shows how to control the zorder of individual lines.

```
"""
```

```
import matplotlib.pyplot as plt
import numpy as np
```

```
x = np.random.random(20)
y = np.random.random(20)
```

```
# Lines on top of scatter
plt.figure()
plt.subplot(211)
plt.plot(x, y, 'r', lw=3)
plt.scatter(x, y, s=120)
plt.title('Lines on top of dots')

# Scatter plot on top of lines
plt.subplot(212)
plt.plot(x, y, 'r', zorder=1, lw=3)
plt.scatter(x, y, s=120, zorder=2)
plt.title('Dots on top of lines')

# A new figure, with individually ordered items
x = np.linspace(0, 2*np.pi, 100)
plt.figure()
plt.plot(x, np.sin(x), linewidth=10, color='black', label='zorder=10', zorder=10) # on_
↳top
plt.plot(x, np.cos(1.3*x), linewidth=10, color='red', label='zorder=1', zorder=1) #_
↳bottom
plt.plot(x, np.sin(2.1*x), linewidth=10, color='green', label='zorder=3', zorder=3)
plt.axhline(0, linewidth=10, color='blue', label='zorder=2', zorder=2)
plt.title('Custom order of elements')
l = plt.legend()
l.set_zorder(20) # put the legend on top
plt.show()
```

Keywords: python, matplotlib, pylab, example, codex (see [Search examples](#))

100.1 pyplots example code: align_ylabels.py

[source code]

```
import numpy as np
import matplotlib.pyplot as plt

box = dict(facecolor='yellow', pad=5, alpha=0.2)

fig = plt.figure()
fig.subplots_adjust(left=0.2, wspace=0.6)

# Fixing random state for reproducibility
np.random.seed(19680801)

ax1 = fig.add_subplot(221)
ax1.plot(2000*np.random.rand(10))
ax1.set_title('ylabels not aligned')
ax1.set_ylabel('misaligned 1', bbox=box)
ax1.set_ylim(0, 2000)
ax3 = fig.add_subplot(223)
ax3.set_ylabel('misaligned 2', bbox=box)
ax3.plot(np.random.rand(10))

labelx = -0.3 # axes coords

ax2 = fig.add_subplot(222)
ax2.set_title('ylabels aligned')
ax2.plot(2000*np.random.rand(10))
ax2.set_ylabel('aligned 1', bbox=box)
ax2.yaxis.set_label_coords(labelx, 0.5)
ax2.set_ylim(0, 2000)

ax4 = fig.add_subplot(224)
ax4.plot(np.random.rand(10))
ax4.set_ylabel('aligned 2', bbox=box)
ax4.yaxis.set_label_coords(labelx, 0.5)

plt.show()
```

Keywords: python, matplotlib, pylab, example, codex (see [Search examples](#))

100.2 pyplots example code: `annotate_transform.py`

[source code]

```
import numpy as np
import matplotlib.pyplot as plt

x = np.arange(0, 10, 0.005)
y = np.exp(-x/2.) * np.sin(2*np.pi*x)

fig = plt.figure()
ax = fig.add_subplot(111)
ax.plot(x, y)
ax.set_xlim(0, 10)
ax.set_ylim(-1, 1)

xdata, ydata = 5, 0
xdisplay, ydisplay = ax.transData.transform_point((xdata, ydata))

bbox = dict(boxstyle="round", fc="0.8")
arrowprops = dict(
    arrowstyle = "->",
    connectionstyle = "angle,angleA=0,angleB=90,rad=10")

offset = 72
ax.annotate('data = (%.1f, %.1f)'%(xdata, ydata),
            (xdata, ydata), xytext=(-2*offset, offset), textcoords='offset points',
            bbox=bbox, arrowprops=arrowprops)

disp = ax.annotate('display = (%.1f, %.1f)'%(xdisplay, ydisplay),
                  (xdisplay, ydisplay), xytext=(0.5*offset, -offset),
                  xycoords='figure pixels',
                  textcoords='offset points',
                  bbox=bbox, arrowprops=arrowprops)

plt.show()
```

Keywords: python, matplotlib, pylab, example, codex (see [Search examples](#))

100.3 pyplots example code: `annotation_basic.py`

[source code]

```
import numpy as np
import matplotlib.pyplot as plt
```



```

fig = plt.figure()
ax = fig.add_subplot(111)

t = np.arange(0.0, 5.0, 0.01)
s = np.cos(2*np.pi*t)
line, = ax.plot(t, s, lw=2)

ax.annotate('local max', xy=(2, 1), xytext=(3, 1.5),
            arrowprops=dict(facecolor='black', shrink=0.05),
            )

ax.set_ylim(-2,2)
plt.show()

```

Keywords: python, matplotlib, pylab, example, codex (see [Search examples](#))

100.4 pyplots example code: annotation_polar.py

[source code]

```

import numpy as np
import matplotlib.pyplot as plt

fig = plt.figure()
ax = fig.add_subplot(111, polar=True)
r = np.arange(0,1,0.001)
theta = 2*2*np.pi*r
line, = ax.plot(theta, r, color='#ee8d18', lw=3)

ind = 800
thisr, thistheta = r[ind], theta[ind]
ax.plot([thistheta], [thisr], 'o')
ax.annotate('a polar annotation',
            xy=(thistheta, thisr), # theta, radius
            xytext=(0.05, 0.05), # fraction, fraction
            textcoords='figure fraction',
            arrowprops=dict(facecolor='black', shrink=0.05),
            horizontalalignment='left',
            verticalalignment='bottom',
            )

plt.show()

```

Keywords: python, matplotlib, pylab, example, codex (see [Search examples](#))

100.5 pyplots example code: auto_subplots_adjust.py

[source code]

```

import matplotlib.pyplot as plt
import matplotlib.transforms as mtransforms
fig = plt.figure()
ax = fig.add_subplot(111)
ax.plot(range(10))
ax.set_yticks((2,5,7))
labels = ax.set_yticklabels(('really, really, really', 'long', 'labels'))

def on_draw(event):
    bboxes = []
    for label in labels:
        bbox = label.get_window_extent()
        # the figure transform goes from relative coords->pixels and we
        # want the inverse of that
        bboxi = bbox.inverse_transformed(fig.transFigure)
        bboxes.append(bboxi)

    # this is the bbox that bounds all the bboxes, again in relative
    # figure coords
    bbox = mtransforms.Bbox.union(bboxes)
    if fig.subplotpars.left < bbox.width:
        # we need to move it over
        fig.subplots_adjust(left=1.1*bbox.width) # pad a little
        fig.canvas.draw()
    return False

fig.canvas.mpl_connect('draw_event', on_draw)

plt.show()

```

Keywords: python, matplotlib, pylab, example, codex (see [Search examples](#))

100.6 pyplots example code: boxplot_demo.py

[source code]

```

#!/usr/bin/python

#
# Example boxplot code
#

import numpy as np
import matplotlib.pyplot as plt

# Fixing random state for reproducibility
np.random.seed(19680801)

# fake up some data
spread = np.random.rand(50) * 100
center = np.ones(25) * 50

```

```

flier_high = np.random.rand(10) * 100 + 100
flier_low = np.random.rand(10) * -100
data = np.concatenate((spread, center, flier_high, flier_low), 0)

fig1, ax1 = plt.subplots()
ax1.set_title('Basic Plot')
ax1.boxplot(data)

fig2, ax2 = plt.subplots()
ax2.set_title('Notched boxes')
ax2.boxplot(data, notch=True)

green_diamond = dict(markerfacecolor='g', marker='D')
fig3, ax3 = plt.subplots()
ax3.set_title('Changed Outlier Symbols')
ax3.boxplot(data, flierprops=green_diamond)

fig4, ax4 = plt.subplots()
ax4.set_title('Hide Outlier Points')
ax4.boxplot(data, showfliers=False)

red_square = dict(markerfacecolor='r', marker='s')
fig5, ax5 = plt.subplots()
ax5.set_title('Horizontal Boxes')
ax5.boxplot(data, vert=False, flierprops=red_square)

fig6, ax6 = plt.subplots()
ax6.set_title('Shorter Whisker Length')
ax6.boxplot(data, flierprops=red_square, vert=False, whis=0.75)

# fake up some more data
spread = np.random.rand(50) * 100
center = np.ones(25) * 40
flier_high = np.random.rand(10) * 100 + 100
flier_low = np.random.rand(10) * -100
d2 = np.concatenate((spread, center, flier_high, flier_low), 0)
data.shape = (-1, 1)
d2.shape = (-1, 1)

# Making a 2-D array only works if all the columns are the
# same length. If they are not, then use a list instead.
# This is actually more efficient because boxplot converts
# a 2-D array into a list of vectors internally anyway.
data = [data, d2, d2[:,2,0]]
fig7, ax7 = plt.subplots()
ax7.set_title('Multiple Samples with Different sizes')
ax7.boxplot(data)

plt.show()

```

Keywords: python, matplotlib, pylab, example, codex (see [Search examples](#))

100.7 pyplots example code: compound_path_demo.py

[source code]

```
import numpy as np

import matplotlib.pyplot as plt
import matplotlib.patches as patches
import matplotlib.path as path

fig = plt.figure()
ax = fig.add_subplot(111)

# Fixing random state for reproducibility
np.random.seed(19680801)

# histogram our data with numpy
data = np.random.randn(1000)
n, bins = np.histogram(data, 100)

# get the corners of the rectangles for the histogram
left = np.array(bins[:-1])
right = np.array(bins[1:])
bottom = np.zeros(len(left))
top = bottom + n
nrects = len(left)

nverts = nrects*(1+3+1)
verts = np.zeros((nverts, 2))
codes = np.ones(nverts, int) * path.Path.LINETO
codes[0::5] = path.Path.MOVETO
codes[4::5] = path.Path.CLOSEPOLY
verts[0::5,0] = left
verts[0::5,1] = bottom
verts[1::5,0] = left
verts[1::5,1] = top
verts[2::5,0] = right
verts[2::5,1] = top
verts[3::5,0] = right
verts[3::5,1] = bottom

barpath = path.Path(verts, codes)
patch = patches.PathPatch(barpath, facecolor='green', edgecolor='yellow', alpha=0.5)
ax.add_patch(patch)

ax.set_xlim(left[0], right[-1])
ax.set_ylim(bottom.min(), top.max())

plt.show()
```

Keywords: python, matplotlib, pylab, example, codex (see [Search examples](#))

100.8 pyplots example code: dollar_ticks.py

[source code]

```
import numpy as np
import matplotlib.pyplot as plt
import matplotlib.ticker as ticker

# Fixing random state for reproducibility
np.random.seed(19680801)

fig = plt.figure()
ax = fig.add_subplot(111)
ax.plot(100*np.random.rand(20))

formatter = ticker.FormatStrFormatter('%$1.2f')
ax.yaxis.set_major_formatter(formatter)

for tick in ax.yaxis.get_major_ticks():
    tick.label10n = False
    tick.label20n = True
    tick.label2.set_color('green')

plt.show()
```

Keywords: python, matplotlib, pylab, example, codex (see [Search examples](#))

100.9 pyplots example code: fig_axes_customize_simple.py

[source code]

```
import numpy as np
import matplotlib.pyplot as plt

# plt.figure creates a matplotlib.figure.Figure instance
fig = plt.figure()
rect = fig.patch # a rectangle instance
rect.set_facecolor('lightgoldenrodyellow')

ax1 = fig.add_axes([0.1, 0.3, 0.4, 0.4])
rect = ax1.patch
rect.set_facecolor('lightslategray')

for label in ax1.xaxis.get_ticklabels():
    # label is a Text instance
    label.set_color('red')
    label.set_rotation(45)
    label.set_fontsize(16)

for line in ax1.yaxis.get_ticklines():
```

```
# line is a Line2D instance
line.set_color('green')
line.set_markersize(25)
line.set_markedgewidth(3)

plt.show()
```

Keywords: python, matplotlib, pylab, example, codex (see [Search examples](#))

100.10 pyplots example code: fig_axes_labels_simple.py

[source code]

```
import numpy as np
import matplotlib.pyplot as plt

fig = plt.figure()
fig.subplots_adjust(top=0.8)
ax1 = fig.add_subplot(211)
ax1.set_ylabel('volts')
ax1.set_title('a sine wave')

t = np.arange(0.0, 1.0, 0.01)
s = np.sin(2*np.pi*t)
line, = ax1.plot(t, s, color='blue', lw=2)

# Fixing random state for reproducibility
np.random.seed(19680801)

ax2 = fig.add_axes([0.15, 0.1, 0.7, 0.3])
n, bins, patches = ax2.hist(np.random.randn(1000), 50,
    facecolor='yellow', edgecolor='yellow')
ax2.set_xlabel('time (s)')

plt.show()
```

Keywords: python, matplotlib, pylab, example, codex (see [Search examples](#))

100.11 pyplots example code: fig_x.py

[source code]

```
import numpy as np
import matplotlib.pyplot as plt
import matplotlib.lines as lines

fig = plt.figure()
```

```

l1 = lines.Line2D([0, 1], [0, 1], transform=fig.transFigure, figure=fig)
l2 = lines.Line2D([0, 1], [1, 0], transform=fig.transFigure, figure=fig)
fig.lines.extend([l1, l2])

plt.show()

```

Keywords: python, matplotlib, pylab, example, codex (see [Search examples](#))

100.12 pyplots example code: pyplot_annotate.py

[source code]

```

import numpy as np
import matplotlib.pyplot as plt

ax = plt.subplot(111)

t = np.arange(0.0, 5.0, 0.01)
s = np.cos(2*np.pi*t)
line, = plt.plot(t, s, lw=2)

plt.annotate('local max', xy=(2, 1), xytext=(3, 1.5),
            arrowprops=dict(facecolor='black', shrink=0.05),
            )

plt.ylim(-2,2)
plt.show()

```

Keywords: python, matplotlib, pylab, example, codex (see [Search examples](#))

100.13 pyplots example code: pyplot_formatstr.py

[source code]

```

import matplotlib.pyplot as plt
plt.plot([1,2,3,4], [1,4,9,16], 'ro')
plt.axis([0, 6, 0, 20])
plt.show()

```

Keywords: python, matplotlib, pylab, example, codex (see [Search examples](#))

100.14 pyplots example code: pyplot_mathtext.py

[source code]

```

import numpy as np
import matplotlib.pyplot as plt
t = np.arange(0.0, 2.0, 0.01)
s = np.sin(2*np.pi*t)

plt.plot(t,s)
plt.title(r'$\alpha_i > \beta_i$', fontsize=20)
plt.text(1, -0.6, r'$\sum_{i=0}^{\infty} x_i$', fontsize=20)
plt.text(0.6, 0.6, r'$\mathcal{A}\mathrm{sin}(2 \omega t)$',
        fontsize=20)
plt.xlabel('time (s)')
plt.ylabel('volts (mV)')
plt.show()

```

Keywords: python, matplotlib, pylab, example, codex (see [Search examples](#))

100.15 pyplots example code: pyplot_scales.py

[source code]

```

import numpy as np
import matplotlib.pyplot as plt

from matplotlib.ticker import NullFormatter # useful for `logit` scale

# Fixing random state for reproducibility
np.random.seed(19680801)

# make up some data in the interval ]0, 1[
y = np.random.normal(loc=0.5, scale=0.4, size=1000)
y = y[(y > 0) & (y < 1)]
y.sort()
x = np.arange(len(y))

# plot with various axes scales
plt.figure(1)

# linear
plt.subplot(221)
plt.plot(x, y)
plt.yscale('linear')
plt.title('linear')
plt.grid(True)

# log
plt.subplot(222)
plt.plot(x, y)
plt.yscale('log')
plt.title('log')
plt.grid(True)

```



```

# symmetric log
plt.subplot(223)
plt.plot(x, y - y.mean())
plt.yscale('symlog', lincthreshy=0.01)
plt.title('symlog')
plt.grid(True)

# logit
plt.subplot(224)
plt.plot(x, y)
plt.yscale('logit')
plt.title('logit')
plt.grid(True)
# Format the minor tick labels of the y-axis into empty strings with
# `NullFormatter`, to avoid cumbering the axis with too many labels.
plt.gca().yaxis.set_minor_formatter(NullFormatter())
# Adjust the subplot layout, because the logit one may take more space
# than usual, due to y-tick labels like "1 - 10^{-3}"
plt.subplots_adjust(top=0.92, bottom=0.08, left=0.10, right=0.95, hspace=0.25,
                    wspace=0.35)

plt.show()

```

Keywords: python, matplotlib, pylab, example, codex (see [Search examples](#))

100.16 pyplots example code: pyplot_simple.py

[source code]

```

import matplotlib.pyplot as plt
plt.plot([1,2,3,4])
plt.ylabel('some numbers')
plt.show()

```

Keywords: python, matplotlib, pylab, example, codex (see [Search examples](#))

100.17 pyplots example code: pyplot_text.py

[source code]

```

import numpy as np
import matplotlib.pyplot as plt

# Fixing random state for reproducibility
np.random.seed(19680801)

mu, sigma = 100, 15

```

```
x = mu + sigma * np.random.randn(10000)

# the histogram of the data
n, bins, patches = plt.hist(x, 50, normed=1, facecolor='g', alpha=0.75)

plt.xlabel('Smarts')
plt.ylabel('Probability')
plt.title('Histogram of IQ')
plt.text(60, .025, r'\mu=100, \sigma=15$')
plt.axis([40, 160, 0, 0.03])
plt.grid(True)
plt.show()
```

Keywords: python, matplotlib, pylab, example, codex (see *Search examples*)

100.18 pyplots example code: pyplot_three.py

[source code]

```
import numpy as np
import matplotlib.pyplot as plt

# evenly sampled time at 200ms intervals
t = np.arange(0., 5., 0.2)

# red dashes, blue squares and green triangles
plt.plot(t, t, 'r--', t, t**2, 'bs', t, t**3, 'g^')
plt.show()
```

Keywords: python, matplotlib, pylab, example, codex (see *Search examples*)

100.19 pyplots example code: pyplot_two_subplots.py

[source code]

```
import numpy as np
import matplotlib.pyplot as plt

def f(t):
    return np.exp(-t) * np.cos(2*np.pi*t)

t1 = np.arange(0.0, 5.0, 0.1)
t2 = np.arange(0.0, 5.0, 0.02)

plt.figure(1)
plt.subplot(211)
plt.plot(t1, f(t1), 'bo', t2, f(t2), 'k')
```

```
plt.subplot(212)
plt.plot(t2, np.cos(2*np.pi*t2), 'r--')
plt.show()
```

Keywords: python, matplotlib, pylab, example, codex (see *Search examples*)

100.20 pyplots example code: tex_demo.py

[source code]

```
"""
Demo of TeX rendering.

You can use TeX to render all of your matplotlib text if the rc
parameter text.usetex is set. This works currently on the agg and ps
backends, and requires that you have tex and the other dependencies
described at http://matplotlib.org/users/usetex.html
properly installed on your system. The first time you run a script
you will see a lot of output from tex and associated tools. The next
time, the run may be silent, as a lot of the information is cached in
~/.tex.cache

"""
import numpy as np
import matplotlib.pyplot as plt

# Example data
t = np.arange(0.0, 1.0 + 0.01, 0.01)
s = np.cos(4 * np.pi * t) + 2

plt.rc('text', usetex=True)
plt.rc('font', family='serif')
plt.plot(t, s)

plt.xlabel(r'\textbf{time} (s)')
plt.ylabel(r'\textit{voltage} (mV)', fontsize=16)
plt.title(r"\TeX\ is Number "
          r"$\displaystyle\sum_{n=1}^{\infty}\frac{-e^{i\pi}}{2^n}$!",
          fontsize=16, color='gray')
# Make room for the ridiculously large title.
plt.subplots_adjust(top=0.8)

plt.savefig('tex_demo')
plt.show()
```

Keywords: python, matplotlib, pylab, example, codex (see *Search examples*)

100.21 pyplots example code: text_commands.py

[source code]

```
# -*- coding: utf-8 -*-
import matplotlib.pyplot as plt

fig = plt.figure()
fig.suptitle('bold figure supitle', fontsize=14, fontweight='bold')

ax = fig.add_subplot(111)
fig.subplots_adjust(top=0.85)
ax.set_title('axes title')

ax.set_xlabel('xlabel')
ax.set_ylabel('ylabel')

ax.text(3, 8, 'boxed italics text in data coords', style='italic',
        bbox={'facecolor':'red', 'alpha':0.5, 'pad':10})

ax.text(2, 6, r'an equation:  $E=mc^2$ ', fontsize=15)

ax.text(3, 2, u'unicode: Institut f\374r Festk\366rperphysik')

ax.text(0.95, 0.01, 'colored text in axes coords',
        verticalalignment='bottom', horizontalalignment='right',
        transform=ax.transAxes,
        color='green', fontsize=15)

ax.plot([2], [1], 'o')
ax.annotate('annotate', xy=(2, 1), xytext=(3, 4),
           arrowprops=dict(facecolor='black', shrink=0.05))

ax.axis([0, 10, 0, 10])

plt.show()
```

Keywords: python, matplotlib, pylab, example, codex (see [Search examples](#))

100.22 pyplots example code: text_layout.py

[source code]

```
import matplotlib.pyplot as plt
import matplotlib.patches as patches

# build a rectangle in axes coords
left, width = .25, .5
bottom, height = .25, .5
right = left + width
```

```
top = bottom + height

fig = plt.figure()
ax = fig.add_axes([0,0,1,1])

# axes coordinates are 0,0 is bottom left and 1,1 is upper right
p = patches.Rectangle(
    (left, bottom), width, height,
    fill=False, transform=ax.transAxes, clip_on=False
)

ax.add_patch(p)

ax.text(left, bottom, 'left top',
        horizontalalignment='left',
        verticalalignment='top',
        transform=ax.transAxes)

ax.text(left, bottom, 'left bottom',
        horizontalalignment='left',
        verticalalignment='bottom',
        transform=ax.transAxes)

ax.text(right, top, 'right bottom',
        horizontalalignment='right',
        verticalalignment='bottom',
        transform=ax.transAxes)

ax.text(right, top, 'right top',
        horizontalalignment='right',
        verticalalignment='top',
        transform=ax.transAxes)

ax.text(right, bottom, 'center top',
        horizontalalignment='center',
        verticalalignment='top',
        transform=ax.transAxes)

ax.text(left, 0.5*(bottom+top), 'right center',
        horizontalalignment='right',
        verticalalignment='center',
        rotation='vertical',
        transform=ax.transAxes)

ax.text(left, 0.5*(bottom+top), 'left center',
        horizontalalignment='left',
        verticalalignment='center',
        rotation='vertical',
        transform=ax.transAxes)

ax.text(0.5*(left+right), 0.5*(bottom+top), 'middle',
        horizontalalignment='center',
        verticalalignment='center',
```

```

        fontsize=20, color='red',
        transform=ax.transAxes)

ax.text(right, 0.5*(bottom+top), 'centered',
        horizontalalignment='center',
        verticalalignment='center',
        rotation='vertical',
        transform=ax.transAxes)

ax.text(left, top, 'rotated\nwith newlines',
        horizontalalignment='center',
        verticalalignment='center',
        rotation=45,
        transform=ax.transAxes)

ax.set_axis_off()
plt.show()

```

Keywords: python, matplotlib, pylab, example, codex (see [Search examples](#))

100.23 pyplots example code: whats_new_1_subplot3d.py

[source code]

```

from mpl_toolkits.mplot3d.axes3d import Axes3D
from matplotlib import cm
#from matplotlib.ticker import LinearLocator, FixedLocator, FormatStrFormatter
import matplotlib.pyplot as plt
import numpy as np

fig = plt.figure()

ax = fig.add_subplot(1, 2, 1, projection='3d')
X = np.arange(-5, 5, 0.25)
Y = np.arange(-5, 5, 0.25)
X, Y = np.meshgrid(X, Y)
R = np.sqrt(X**2 + Y**2)
Z = np.sin(R)
surf = ax.plot_surface(X, Y, Z, rstride=1, cstride=1, cmap=cm.jet,
                      linewidth=0, antialiased=False)
ax.set_zlim3d(-1.01, 1.01)

#ax.w_zaxis.set_major_locator(LinearLocator(10))
#ax.w_zaxis.set_major_formatter(FormatStrFormatter('%.03f'))

fig.colorbar(surf, shrink=0.5, aspect=5)

from mpl_toolkits.mplot3d.axes3d import get_test_data
ax = fig.add_subplot(1, 2, 2, projection='3d')
X, Y, Z = get_test_data(0.05)
ax.plot_wireframe(X, Y, Z, rstride=10, cstride=10)

```

```
plt.show()
```

Keywords: python, matplotlib, pylab, example, codex (see [Search examples](#))

100.24 pyplots example code: whats_new_98_4_fancy.py

[source code]

```
import matplotlib.patches as mpatch
import matplotlib.pyplot as plt

figheight = 8
fig = plt.figure(1, figsize=(9, figheight), dpi=80)
fontsize = 0.4 * fig.dpi

def make_boxstyles(ax):
    styles = mpatch.BoxStyle.get_styles()

    for i, (stylename, styleclass) in enumerate(sorted(styles.items())):
        ax.text(0.5, (float(len(styles)) - 0.5 - i)/len(styles), stylename,
                ha="center",
                size=fontsize,
                transform=ax.transAxes,
                bbox=dict(boxstyle=stylename, fc="w", ec="k"))

def make_arrowstyles(ax):
    styles = mpatch.ArrowStyle.get_styles()

    ax.set_xlim(0, 4)
    ax.set_ylim(0, figheight)

    for i, (stylename, styleclass) in enumerate(sorted(styles.items())):
        y = (float(len(styles)) - 0.25 - i) # /figheight
        p = mpatch.Circle((3.2, y), 0.2, fc="w")
        ax.add_patch(p)

    ax.annotate(stylename, (3.2, y),
                (2., y),
                #xycoords="figure fraction", textcoords="figure fraction",
                ha="right", va="center",
                size=fontsize,
                arrowprops=dict(arrowstyle=stylename,
                                patchB=p,
                                shrinkA=5,
                                shrinkB=5,
                                fc="w", ec="k",
                                connectionstyle="arc3,rad=-0.05",
                                ),
                bbox=dict(boxstyle="square", fc="w"))
```

```
ax.xaxis.set_visible(False)
ax.yaxis.set_visible(False)

ax1 = fig.add_subplot(121, frameon=False, xticks=[], yticks=[])
make_boxstyles(ax1)

ax2 = fig.add_subplot(122, frameon=False, xticks=[], yticks=[])
make_arrowstyles(ax2)

plt.show()
```

Keywords: python, matplotlib, pylab, example, codex (see [Search examples](#))

100.25 pyplots example code: whats_new_98_4_fill_between.py

[source code]

```
#!/usr/bin/env python
import matplotlib.mlab as mlab
import matplotlib.pyplot as plt
import numpy as np

x = np.arange(0.0, 2, 0.01)
y1 = np.sin(2*np.pi*x)
y2 = 1.2*np.sin(4*np.pi*x)

fig, ax = plt.subplots()
ax.plot(x, y1, x, y2, color='black')
ax.fill_between(x, y1, y2, where=y2>y1, facecolor='green')
ax.fill_between(x, y1, y2, where=y2<=y1, facecolor='red')
ax.set_title('fill between where')

plt.show()
```

Keywords: python, matplotlib, pylab, example, codex (see [Search examples](#))

100.26 pyplots example code: whats_new_98_4_legend.py

[source code]

```
import matplotlib.pyplot as plt
import numpy as np
import matplotlib.pyplot as plt

ax = plt.subplot(111)
t1 = np.arange(0.0, 1.0, 0.01)
```



```

for n in [1, 2, 3, 4]:
    plt.plot(t1, t1**n, label="n=%d"%(n,))

leg = plt.legend(loc='best', ncol=2, mode="expand", shadow=True, fancybox=True)
leg.get_frame().set_alpha(0.5)

plt.show()

```

Keywords: python, matplotlib, pylab, example, codex (see [Search examples](#))

100.27 pyplots example code: whats_new_99_axes_grid.py

[source code]

```

import numpy as np
import matplotlib.pyplot as plt
from mpl_toolkits.axes_grid.axes_rgb import RGBAxes

def get_demo_image():
    # prepare image
    delta = 0.5

    extent = (-3,4,-4,3)
    x = np.arange(-3.0, 4.001, delta)
    y = np.arange(-4.0, 3.001, delta)
    X, Y = np.meshgrid(x, y)
    import matplotlib.mlab as mlab
    Z1 = mlab.bivariate_normal(X, Y, 1.0, 1.0, 0.0, 0.0)
    Z2 = mlab.bivariate_normal(X, Y, 1.5, 0.5, 1, 1)
    Z = (Z1 - Z2) * 10

    return Z, extent

def get_rgb():
    Z, extent = get_demo_image()

    Z[Z<0] = 0.
    Z = Z/Z.max()

    R = Z[:13,:13]
    G = Z[2:,2:]
    B = Z[:13,2:]

    return R, G, B

fig = plt.figure(1)
ax = RGBAxes(fig, [0.1, 0.1, 0.8, 0.8])

```

```
r, g, b = get_rgb()
kwargs = dict(origin="lower", interpolation="nearest")
ax.imshow_rgb(r, g, b, **kwargs)

ax.RGB.set_xlim(0., 9.5)
ax.RGB.set_ylim(0.9, 10.6)

plt.draw()
plt.show()
```

Keywords: python, matplotlib, pylab, example, codex (see [Search examples](#))

100.28 pyplots example code: whats_new_99_mplot3d.py

[source code]

```
import random

import numpy as np
import matplotlib.pyplot as plt
from matplotlib import cm
from mpl_toolkits.mplot3d import Axes3D

X = np.arange(-5, 5, 0.25)
Y = np.arange(-5, 5, 0.25)
X, Y = np.meshgrid(X, Y)
R = np.sqrt(X**2 + Y**2)
Z = np.sin(R)

fig = plt.figure()
ax = Axes3D(fig)
ax.plot_surface(X, Y, Z, rstride=1, cstride=1, cmap=cm.viridis)

plt.show()
```

Keywords: python, matplotlib, pylab, example, codex (see [Search examples](#))

100.29 pyplots example code: whats_new_99_spines.py

[source code]

```
import matplotlib.pyplot as plt
import numpy as np

def adjust_spines(ax, spines):
    for loc, spine in ax.spines.items():
```

```
    if loc in spines:
        spine.set_position(('outward',10)) # outward by 10 points
    else:
        spine.set_color('none') # don't draw spine

# turn off ticks where there is no spine
if 'left' in spines:
    ax.yaxis.set_ticks_position('left')
else:
    # no yaxis ticks
    ax.yaxis.set_ticks([])

if 'bottom' in spines:
    ax.xaxis.set_ticks_position('bottom')
else:
    # no xaxis ticks
    ax.xaxis.set_ticks([])

fig = plt.figure()

x = np.linspace(0,2*np.pi,100)
y = 2*np.sin(x)

ax = fig.add_subplot(2,2,1)
ax.plot(x,y)
adjust_spines(ax,['left'])

ax = fig.add_subplot(2,2,2)
ax.plot(x,y)
adjust_spines(ax,[])

ax = fig.add_subplot(2,2,3)
ax.plot(x,y)
adjust_spines(ax,['left','bottom'])

ax = fig.add_subplot(2,2,4)
ax.plot(x,y)
adjust_spines(ax,['bottom'])

plt.show()
```

Keywords: python, matplotlib, pylab, example, codex (see [Search examples](#))

SCALES EXAMPLES

101.1 scales example code: scales.py

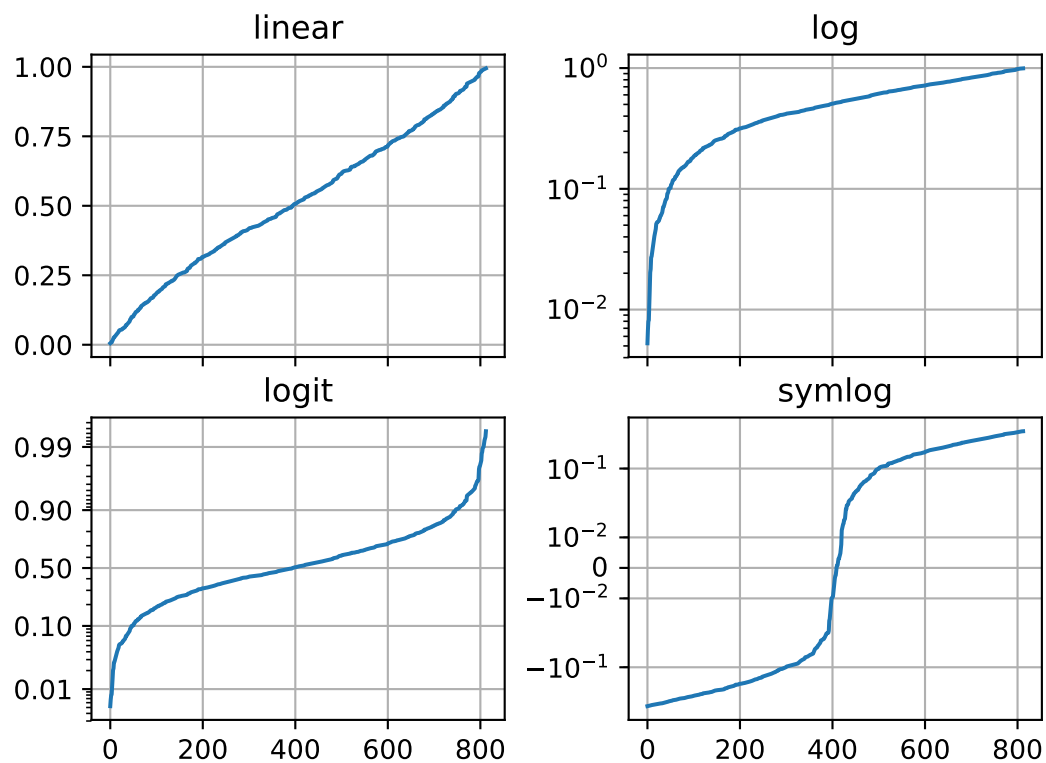

```
"""
Illustrate the scale transformations applied to axes, e.g. log, symlog, logit.
"""
import numpy as np
import matplotlib.pyplot as plt
from matplotlib.ticker import NullFormatter

np.random.seed(1)
# make up some data in the interval ]0, 1[
```

```
y = np.random.normal(loc=0.5, scale=0.4, size=1000)
y = y[(y > 0) & (y < 1)]
y.sort()
x = np.arange(len(y))

# plot with various axes scales
fig, axs = plt.subplots(2, 2, sharex=True)
fig.subplots_adjust(left=0.08, right=0.98, wspace=0.3)

# linear
ax = axs[0, 0]
ax.plot(x, y)
ax.set_yscale('linear')
ax.set_title('linear')
ax.grid(True)

# log
ax = axs[0, 1]
ax.plot(x, y)
ax.set_yscale('log')
ax.set_title('log')
ax.grid(True)

# symmetric log
ax = axs[1, 1]
ax.plot(x, y - y.mean())
ax.set_yscale('symlog', lincthreshy=0.02)
ax.set_title('symlog')
ax.grid(True)

# logit
ax = axs[1, 0]
ax.plot(x, y)
ax.set_yscale('logit')
ax.set_title('logit')
ax.grid(True)
ax.yaxis.set_minor_formatter(NullFormatter())

plt.show()
```

Keywords: python, matplotlib, pylab, example, codex (see [Search examples](#))

SHAPES_AND_COLLECTIONS EXAMPLES

102.1 shapes_and_collections example code: artist_reference.py



Wedge



Arrow



Line2D



Rectangle



Ellipse



FancyBboxPatch

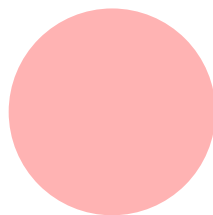

Circle

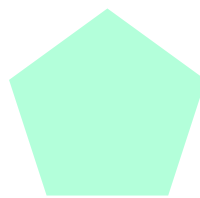

Polygon



PathPatch

```
"""
```

```
Reference for matplotlib artists
```

```
This example displays several of matplotlib's graphics primitives (artists)  
drawn using matplotlib API. A full list of artists and the documentation is  
available at http://matplotlib.org/api/artist\_api.html.
```

```
Copyright (c) 2010, Bartosz Telenczuk
BSD License
"""
import matplotlib.pyplot as plt
plt.rcParamsdefaults()

import numpy as np
import matplotlib.pyplot as plt
import matplotlib.path as mpath
import matplotlib.lines as mlines
import matplotlib.patches as mpatches
from matplotlib.collections import PatchCollection

def label(xy, text):
    y = xy[1] - 0.15 # shift y-value for label so that it's below the artist
    plt.text(xy[0], y, text, ha="center", family='sans-serif', size=14)

fig, ax = plt.subplots()
# create 3x3 grid to plot the artists
grid = np.mgrid[0.2:0.8:3j, 0.2:0.8:3j].reshape(2, -1).T

patches = []

# add a circle
circle = mpatches.Circle(grid[0], 0.1, ec="none")
patches.append(circle)
label(grid[0], "Circle")

# add a rectangle
rect = mpatches.Rectangle(grid[1] - [0.025, 0.05], 0.05, 0.1, ec="none")
patches.append(rect)
label(grid[1], "Rectangle")

# add a wedge
wedge = mpatches.Wedge(grid[2], 0.1, 30, 270, ec="none")
patches.append(wedge)
label(grid[2], "Wedge")

# add a Polygon
polygon = mpatches.RegularPolygon(grid[3], 5, 0.1)
patches.append(polygon)
label(grid[3], "Polygon")

# add an ellipse
ellipse = mpatches.Ellipse(grid[4], 0.2, 0.1)
patches.append(ellipse)
label(grid[4], "Ellipse")

# add an arrow
arrow = mpatches.Arrow(grid[5, 0] - 0.05, grid[5, 1] - 0.05, 0.1, 0.1, width=0.1)
patches.append(arrow)
```



```

label(grid[5], "Arrow")

# add a path patch
Path = mpath.Path
path_data = [
    (Path.MOVETO, [0.018, -0.11]),
    (Path.CURVE4, [-0.031, -0.051]),
    (Path.CURVE4, [-0.115, 0.073]),
    (Path.CURVE4, [-0.03, 0.073]),
    (Path.LINETO, [-0.011, 0.039]),
    (Path.CURVE4, [0.043, 0.121]),
    (Path.CURVE4, [0.075, -0.005]),
    (Path.CURVE4, [0.035, -0.027]),
    (Path.CLOSEPOLY, [0.018, -0.11])
]
codes, verts = zip(*path_data)
path = mpath.Path(verts + grid[6], codes)
patch = mpatches.PathPatch(path)
patches.append(patch)
label(grid[6], "PathPatch")

# add a fancy box
fancybox = mpatches.FancyBboxPatch(
    grid[7] - [0.025, 0.05], 0.05, 0.1,
    boxstyle=mpatches.BoxStyle("Round", pad=0.02))
patches.append(fancybox)
label(grid[7], "FancyBboxPatch")

# add a line
x, y = np.array([[[-0.06, 0.0, 0.1], [0.05, -0.05, 0.05]])
line = mlines.Line2D(x + grid[8, 0], y + grid[8, 1], lw=5., alpha=0.3)
label(grid[8], "Line2D")

colors = np.linspace(0, 1, len(patches))
collection = PatchCollection(patches, cmap=plt.cm.hsv, alpha=0.3)
collection.set_array(np.array(colors))
ax.add_collection(collection)
ax.add_line(line)

plt.subplots_adjust(left=0, right=1, bottom=0, top=1)
plt.axis('equal')
plt.axis('off')

plt.show()

```

Keywords: python, matplotlib, pylab, example, codex (see [Search examples](#))

102.2 shapes_and_collections example code: path_patch_demo.py

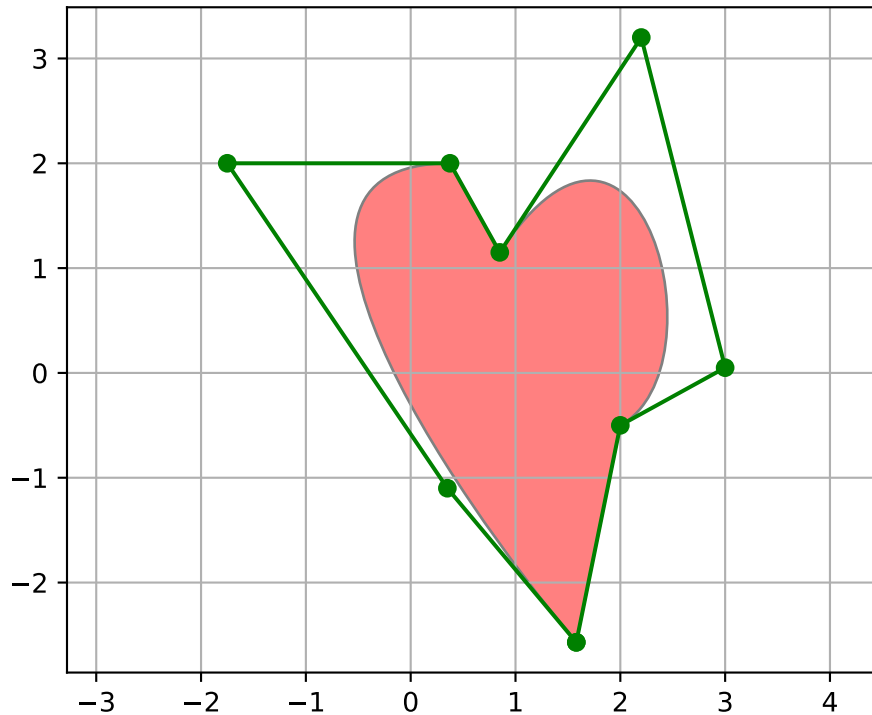

```
"""
Demo of a PathPatch object.
"""
import matplotlib.path as mpath
import matplotlib.patches as mpatches
import matplotlib.pyplot as plt

fig, ax = plt.subplots()

Path = mpath.Path
path_data = [
    (Path.MOVETO, (1.58, -2.57)),
    (Path.CURVE4, (0.35, -1.1)),
    (Path.CURVE4, (-1.75, 2.0)),
    (Path.CURVE4, (0.375, 2.0)),
    (Path.LINETO, (0.85, 1.15)),
    (Path.CURVE4, (2.2, 3.2)),
    (Path.CURVE4, (3, 0.05)),
    (Path.CURVE4, (2.0, -0.5)),
    (Path.CLOSEPOLY, (1.58, -2.57)),
]
```

```

codes, verts = zip(*path_data)
path = mpath.Path(verts, codes)
patch = mpatches.PathPatch(path, facecolor='r', alpha=0.5)
ax.add_patch(patch)

# plot control points and connecting lines
x, y = zip(*path.vertices)
line, = ax.plot(x, y, 'go-')

ax.grid()
ax.axis('equal')
plt.show()

```

Keywords: python, matplotlib, pylab, example, codex (see [Search examples](#))

102.3 shapes_and_collections example code: scatter_demo.py

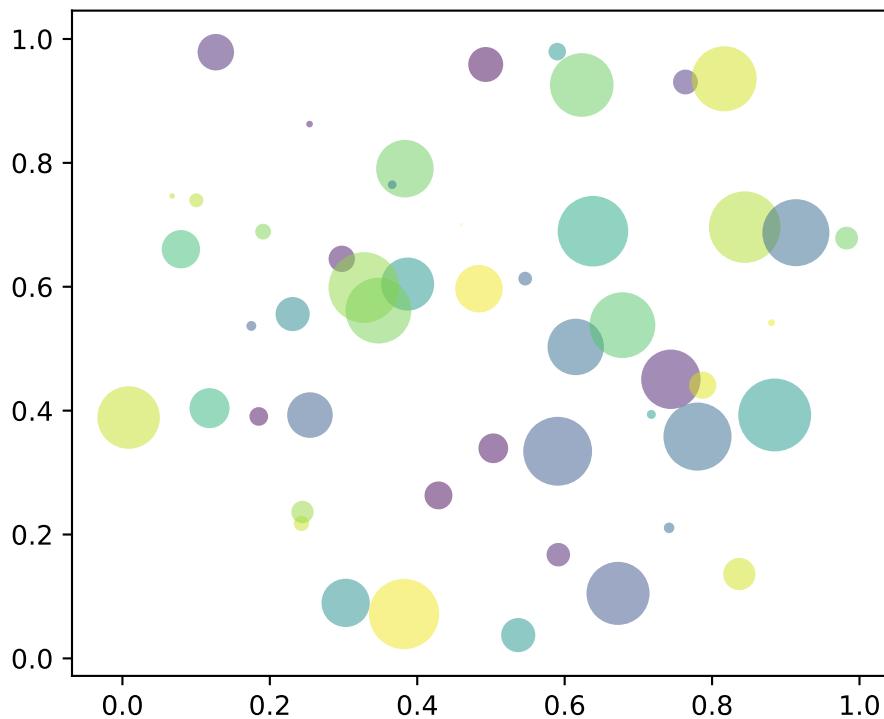

```

"""
Simple demo of a scatter plot.
"""
import numpy as np
import matplotlib.pyplot as plt

```

```
N = 50
x = np.random.rand(N)
y = np.random.rand(N)
colors = np.random.rand(N)
area = np.pi * (15 * np.random.rand(N))**2 # 0 to 15 point radii

plt.scatter(x, y, s=area, c=colors, alpha=0.5)
plt.show()
```

Keywords: python, matplotlib, pylab, example, codex (see [Search examples](#))

SHOWCASE EXAMPLES

103.1 showcase example code: anatomy.py

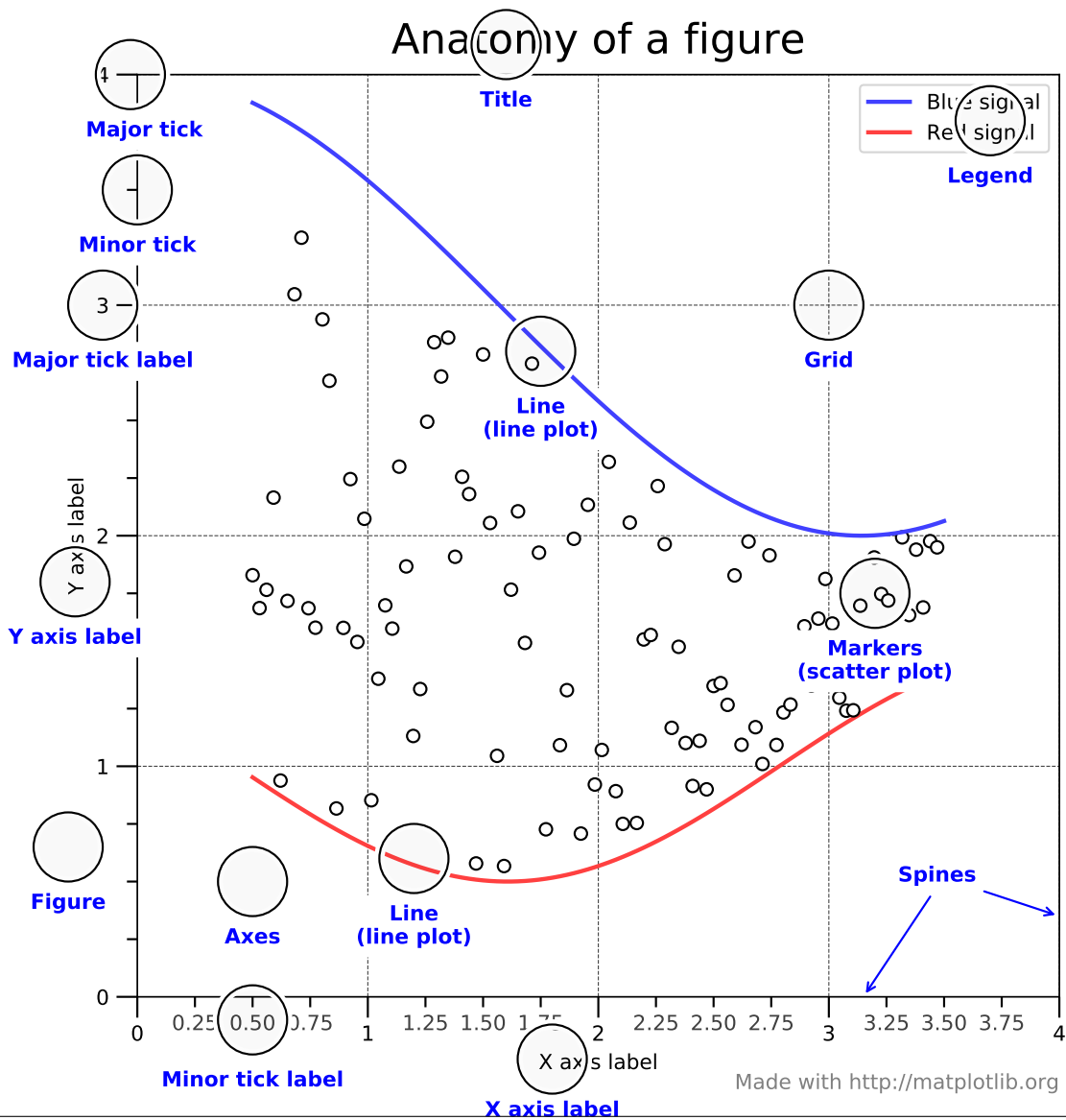

Made with <http://matplotlib.org>

```

# This figure shows the name of several matplotlib elements composing a figure

import numpy as np
import matplotlib.pyplot as plt
from matplotlib.ticker import AutoMinorLocator, MultipleLocator, FuncFormatter

np.random.seed(19680801)

X = np.linspace(0.5, 3.5, 100)
Y1 = 3+np.cos(X)
Y2 = 1+np.cos(1+X/0.75)/2
Y3 = np.random.uniform(Y1, Y2, len(X))

fig = plt.figure(figsize=(8, 8))
ax = fig.add_subplot(1, 1, 1, aspect=1)

def minor_tick(x, pos):
    if not x % 1.0:
        return ""
    return "%.2f" % x

ax.xaxis.set_major_locator(MultipleLocator(1.000))
ax.xaxis.set_minor_locator(AutoMinorLocator(4))
ax.yaxis.set_major_locator(MultipleLocator(1.000))
ax.yaxis.set_minor_locator(AutoMinorLocator(4))
ax.xaxis.set_minor_formatter(FuncFormatter(minor_tick))

ax.set_xlim(0, 4)
ax.set_ylim(0, 4)

ax.tick_params(which='major', width=1.0)
ax.tick_params(which='major', length=10)
ax.tick_params(which='minor', width=1.0, labelsize=10)
ax.tick_params(which='minor', length=5, labelsize=10, labelcolor='0.25')

ax.grid(linestyle="--", linewidth=0.5, color='.25', zorder=-10)

ax.plot(X, Y1, c=(0.25, 0.25, 1.00), lw=2, label="Blue signal", zorder=10)
ax.plot(X, Y2, c=(1.00, 0.25, 0.25), lw=2, label="Red signal")
ax.plot(X, Y3, linewidth=0,
        marker='o', markerfacecolor='w', markeredgecolor='k')

ax.set_title("Anatomy of a figure", fontsize=20, verticalalignment='bottom')
ax.set_xlabel("X axis label")
ax.set_ylabel("Y axis label")

ax.legend()

def circle(x, y, radius=0.15):
    from matplotlib.patches import Circle

```

```
from matplotlib.path_effects import withStroke
circle = Circle((x, y), radius, clip_on=False, zorder=10, linewidth=1,
                edgecolor='black', facecolor=(0, 0, 0, .0125),
                path_effects=[withStroke(linewidth=5, foreground='w')])
ax.add_artist(circle)

def text(x, y, text):
    ax.text(x, y, text, backgroundcolor="white",
            ha='center', va='top', weight='bold', color='blue')

# Minor tick
circle(0.50, -0.10)
text(0.50, -0.32, "Minor tick label")

# Major tick
circle(-0.03, 4.00)
text(0.03, 3.80, "Major tick")

# Minor tick
circle(0.00, 3.50)
text(0.00, 3.30, "Minor tick")

# Major tick label
circle(-0.15, 3.00)
text(-0.15, 2.80, "Major tick label")

# X Label
circle(1.80, -0.27)
text(1.80, -0.45, "X axis label")

# Y Label
circle(-0.27, 1.80)
text(-0.27, 1.6, "Y axis label")

# Title
circle(1.60, 4.13)
text(1.60, 3.93, "Title")

# Blue plot
circle(1.75, 2.80)
text(1.75, 2.60, "Line\n(line plot)")

# Red plot
circle(1.20, 0.60)
text(1.20, 0.40, "Line\n(line plot)")

# Scatter plot
circle(3.20, 1.75)
text(3.20, 1.55, "Markers\n(scatter plot)")

# Grid
```



```
circle(3.00, 3.00)
text(3.00, 2.80, "Grid")

# Legend
circle(3.70, 3.80)
text(3.70, 3.60, "Legend")

# Axes
circle(0.5, 0.5)
text(0.5, 0.3, "Axes")

# Figure
circle(-0.3, 0.65)
text(-0.3, 0.45, "Figure")

color = 'blue'
ax.annotate('Spines', xy=(4.0, 0.35), xycoords='data',
            xytext=(3.3, 0.5), textcoords='data',
            weight='bold', color=color,
            arrowprops=dict(arrowstyle='->',
                            connectionstyle="arc3",
                            color=color))

ax.annotate('', xy=(3.15, 0.0), xycoords='data',
            xytext=(3.45, 0.45), textcoords='data',
            weight='bold', color=color,
            arrowprops=dict(arrowstyle='->',
                            connectionstyle="arc3",
                            color=color))

ax.text(4.0, -0.4, "Made with http://matplotlib.org",
        fontsize=10, ha="right", color='.5')

plt.show()
```

Keywords: python, matplotlib, pylab, example, codex (see *Search examples*)

103.2 showcase example code: bachelors_degrees_by_gender.py

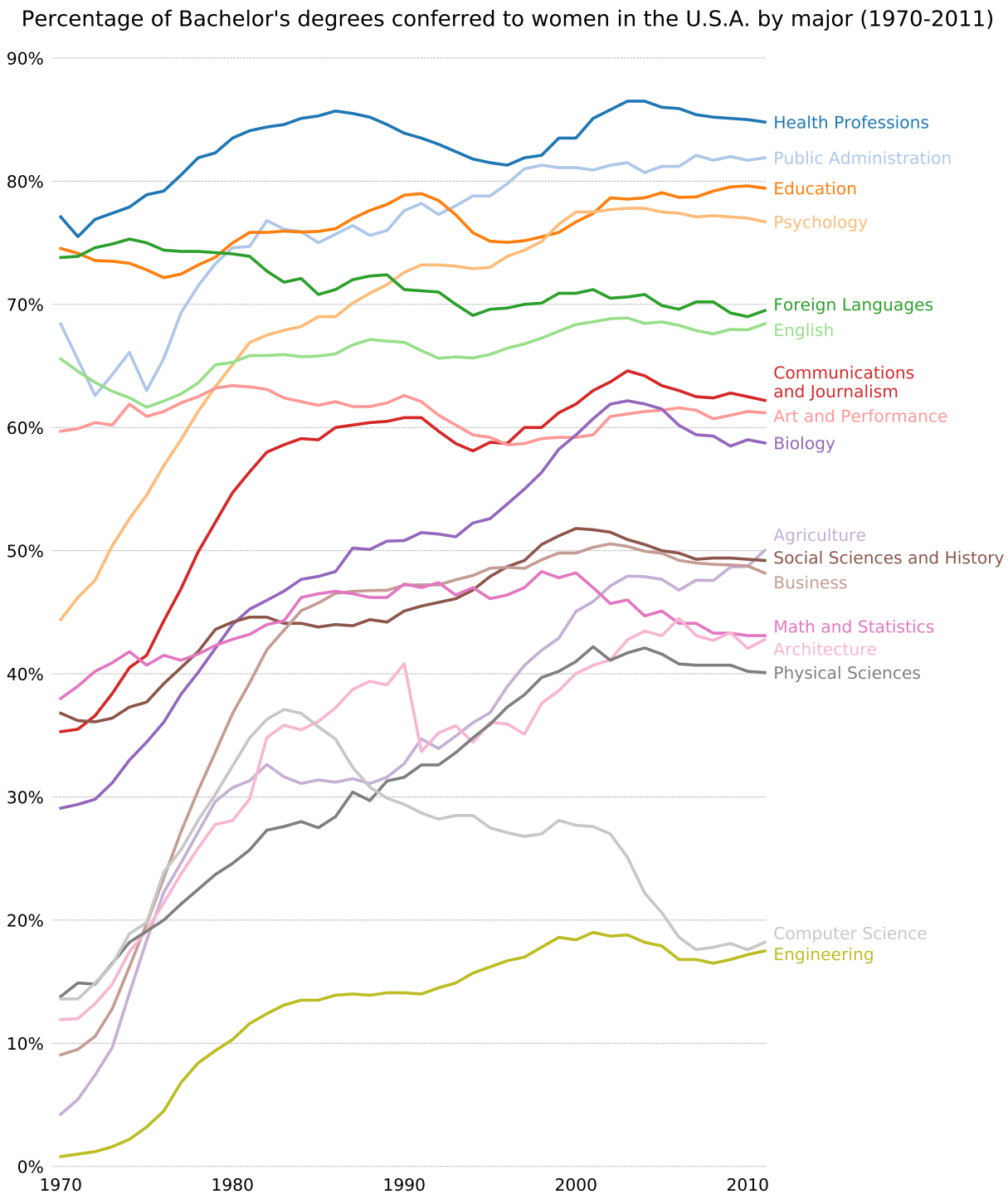

```
import matplotlib.pyplot as plt
from matplotlib.mlab import csv2rec
from matplotlib.cbook import get_sample_data
```

```

fname = get_sample_data('percent_bachelors_degrees_women_usa.csv')
gender_degree_data = csv2rec(fname)

# These are the colors that will be used in the plot
color_sequence = ['#1f77b4', '#aec7e8', '#ff7f0e', '#ffbb78', '#2ca02c',
                  '#98df8a', '#d62728', '#ff9896', '#9467bd', '#c5b0d5',
                  '#8c564b', '#c49c94', '#e377c2', '#f7b6d2', '#7f7f7f',
                  '#c7c7c7', '#bcbd22', '#d9db8d', '#17becf', '#9edae5']

# You typically want your plot to be ~1.33x wider than tall. This plot
# is a rare exception because of the number of lines being plotted on it.
# Common sizes: (10, 7.5) and (12, 9)
fig, ax = plt.subplots(1, 1, figsize=(12, 14))

# Remove the plot frame lines. They are unnecessary here.
ax.spines['top'].set_visible(False)
ax.spines['bottom'].set_visible(False)
ax.spines['right'].set_visible(False)
ax.spines['left'].set_visible(True)

# Ensure that the axis ticks only show up on the bottom and left of the plot.
# Ticks on the right and top of the plot are generally unnecessary.
ax.get_xaxis().tick_bottom()
ax.get_yaxis().tick_left()

fig.subplots_adjust(left=.06, right=.75, bottom=.02, top=.94)
# Limit the range of the plot to only where the data is.
# Avoid unnecessary whitespace.
ax.set_xlim(1969.5, 2011.1)
ax.set_ylim(-0.25, 90)

# Make sure your axis ticks are large enough to be easily read.
# You don't want your viewers squinting to read your plot.
plt.xticks(range(1970, 2011, 10), fontsize=14)
plt.yticks(range(0, 91, 10), fontsize=14)
ax.xaxis.set_major_formatter(plt.FuncFormatter('{:.0f}'.format))
ax.yaxis.set_major_formatter(plt.FuncFormatter('{:.0f}%'.format))

# Provide tick lines across the plot to help your viewers trace along
# the axis ticks. Make sure that the lines are light and small so they
# don't obscure the primary data lines.
plt.grid(True, 'major', 'y', ls='--', lw=.5, c='k', alpha=.3)

# Remove the tick marks; they are unnecessary with the tick lines we just
# plotted.
plt.tick_params(axis='both', which='both', bottom='off', top='off',
                labelbottom='on', left='off', right='off', labelleft='on')

# Now that the plot is prepared, it's time to actually plot the data!
# Note that I plotted the majors in order of the highest % in the final year.
majors = ['Health Professions', 'Public Administration', 'Education',
          'Psychology', 'Foreign Languages', 'English',
          'Communications and Journalism', 'Art and Performance', 'Biology',

```

```

    'Agriculture', 'Social Sciences and History', 'Business',
    'Math and Statistics', 'Architecture', 'Physical Sciences',
    'Computer Science', 'Engineering']

y_offsets = {'Foreign Languages': 0.5, 'English': -0.5,
             'Communications\and Journalism': 0.75,
             'Art and Performance': -0.25, 'Agriculture': 1.25,
             'Social Sciences and History': 0.25, 'Business': -0.75,
             'Math and Statistics': 0.75, 'Architecture': -0.75,
             'Computer Science': 0.75, 'Engineering': -0.25}

for rank, column in enumerate(majors):
    # Plot each line separately with its own color.
    column_rec_name = column.replace('\n', '_').replace(' ', '_').lower()

    line = plt.plot(gender_degree_data.year,
                    gender_degree_data[column_rec_name],
                    lw=2.5,
                    color=color_sequence[rank])

    # Add a text label to the right end of every line. Most of the code below
    # is adding specific offsets y position because some labels overlapped.
    y_pos = gender_degree_data[column_rec_name][-1] - 0.5

    if column in y_offsets:
        y_pos += y_offsets[column]

    # Again, make sure that all labels are large enough to be easily read
    # by the viewer.
    plt.text(2011.5, y_pos, column, fontsize=14, color=color_sequence[rank])

# Make the title big enough so it spans the entire plot, but don't make it
# so big that it requires two lines to show.

# Note that if the title is descriptive enough, it is unnecessary to include
# axis labels; they are self-evident, in this plot's case.
fig.suptitle('Percentage of Bachelor\'s degrees conferred to women in '
             'the U.S.A. by major (1970-2011)\n', fontsize=18, ha='center')

# Finally, save the figure as a PNG.
# You can also save it as a PDF, JPEG, etc.
# Just change the file extension in this call.
# plt.savefig('percent-bachelors-degrees-women-usa.png', bbox_inches='tight')
plt.show()

```

Keywords: python, matplotlib, pylab, example, codex (see [Search examples](#))

103.3 showcase example code: firefox.py

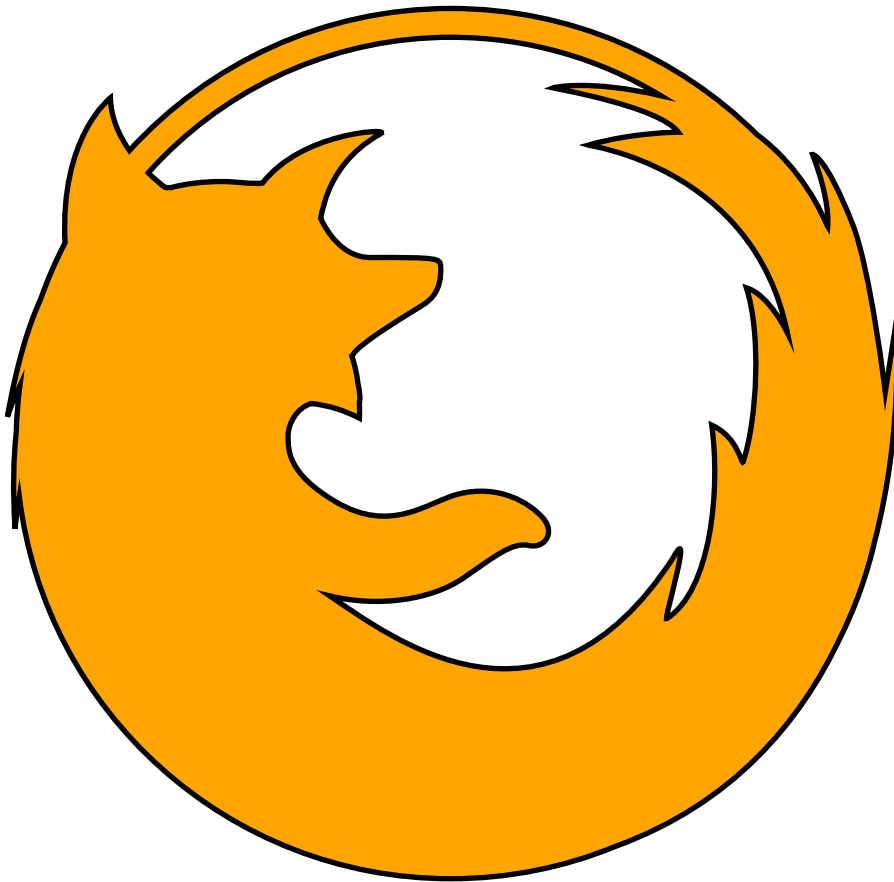

```

"""
=====
Firefox
=====

This example shows how to create the Firefox logo with path and patches.
"""

import re
import numpy as np
import matplotlib.pyplot as plt
from matplotlib.path import Path
import matplotlib.patches as patches

# From: http://raphaeljs.com/icons/#firefox
firefox = "M28.4,22.469c0.479-0.964,0.851-1.991,1.095-3.066c0.953-3.661,0.666-6.854,0.
↳666-6.854l-0.327,2.104c0,0-0.469-3.896-1.044-5.353c-0.881-2.231-1.273-2.214-1.274-2.
↳21c0.542,1.379,0.494,2.169,0.483,2.288c-0.01-0.016-0.019-0.032-0.027-0.047c-0.131-0.
↳324-0.797-1.819-2.225-2.878c-2.502-2.481-5.943-4.014-9.745-4.015c-4.056,0-7.705,1.745-
↳10.238,4.525C5.444,6.5,5.183,5.938,5.159,5.317c0,0-0.002,0.002-0.006,0.005c0-0.011-0.
↳003-0.021-0.003-0.031c0,0-1.61,1.247-1.436,4.612c-0.299,0.574-0.56,1.172-0.777,1.791c-
↳0.375,0.817-0.75,2.004-1.059,3.746c0,0,0.133-0.422,0.399-0.988c-0.064,0.482-0.103,0.
↳97-0.110,1.467c-0.09,0.045-0.118,1.865-0.039,3.088c0,0,0.032-0.406,0.136-1.021c0.854,
↳6.854,6.667,12.165,13.743,12.165l0,0c1.86,0,3.636-0.37,5.256-1.036C24.938,27.771,27.
↳116,25.196,28.4,22.469z"
M16.002,3.356c2.446,0,4.73,0.68,6.68,1.86c-2.274-0.528-3.433-0.
↳261-3.423-0.248c0.013,0.015,3.384,0.589,3.981,1.411c0,0-1.431,0-2.856,0.41c-0.065,0.

```

```

def svg_parse(path):
    commands = {'M': (Path.MOVETO,),
                'L': (Path.LINETO,),
                'Q': (Path.CURVE3,)*2,
                'C': (Path.CURVE4,)*3,
                'Z': (Path.CLOSEPOLY,)}
    path_re = re.compile(r'([MLHVCSQTAZ])([^\MLHVCSQTAZ]+)', re.IGNORECASE)
    float_re = re.compile(r'(?:[\s,]*)([+-]?\d+(?:\.\d+)?)')
    vertices = []
    codes = []
    last = (0, 0)
    for cmd, values in path_re.findall(path):
        points = [float(v) for v in float_re.findall(values)]
        points = np.array(points).reshape((len(points)//2, 2))
        if cmd.islower():
            points += last
        cmd = cmd.capitalize()
        last = points[-1]
        codes.extend(commands[cmd])
        vertices.extend(points.tolist())
    return codes, vertices

# SVG to matplotlib
codes, verts = svg_parse(firefox)
verts = np.array(verts)
path = Path(verts, codes)

# Make upside down
verts[:, 1] *= -1
xmin, xmax = verts[:, 0].min()-1, verts[:, 0].max()+1
ymin, ymax = verts[:, 1].min()-1, verts[:, 1].max()+1

fig = plt.figure(figsize=(5, 5))
ax = fig.add_axes([0.0, 0.0, 1.0, 1.0], frameon=False, aspect=1)

# White outline (width = 6)
patch = patches.PathPatch(path, facecolor='None', edgecolor='w', lw=6)
ax.add_patch(patch)

# Actual shape with black outline
patch = patches.PathPatch(path, facecolor='orange', edgecolor='k', lw=2)
ax.add_patch(patch)

# Centering
ax.set_xlim(xmin, xmax)
ax.set_ylim(ymin, ymax)

# No ticks
ax.set_xticks([])
ax.set_yticks([])

```

```
# Display
plt.show()
```

Keywords: python, matplotlib, pylab, example, codex (see *Search examples*)

103.4 showcase example code: integral_demo.py

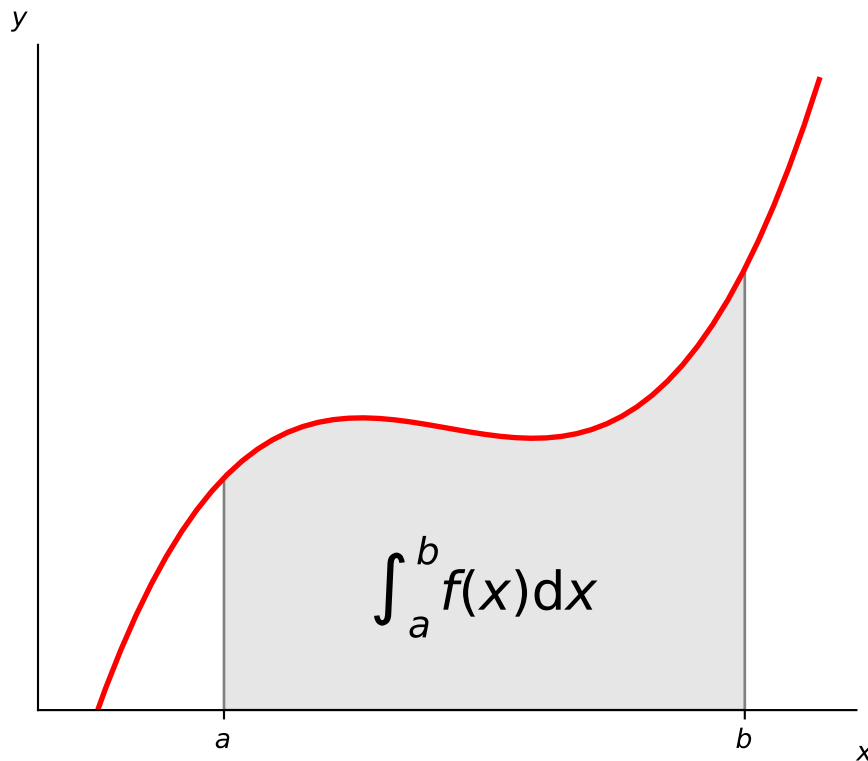

```
"""
Plot demonstrating the integral as the area under a curve.

Although this is a simple example, it demonstrates some important tweaks:

    * A simple line plot with custom color and line width.
    * A shaded region created using a Polygon patch.
    * A text label with mathtext rendering.
    * figtext calls to label the x- and y-axes.
    * Use of axis spines to hide the top and right spines.
    * Custom tick placement and labels.
"""
import numpy as np
import matplotlib.pyplot as plt
from matplotlib.patches import Polygon
```

```
def func(x):
    return (x - 3) * (x - 5) * (x - 7) + 85

a, b = 2, 9 # integral limits
x = np.linspace(0, 10)
y = func(x)

fig, ax = plt.subplots()
plt.plot(x, y, 'r', linewidth=2)
plt.ylim(ymin=0)

# Make the shaded region
ix = np.linspace(a, b)
iy = func(ix)
verts = [(a, 0)] + list(zip(ix, iy)) + [(b, 0)]
poly = Polygon(verts, facecolor='0.9', edgecolor='0.5')
ax.add_patch(poly)

plt.text(0.5 * (a + b), 30, r"\int_a^b f(x)\mathrm{d}x",
         horizontalalignment='center', fontsize=20)

plt.figtext(0.9, 0.05, '$x$')
plt.figtext(0.1, 0.9, '$y$')

ax.spines['right'].set_visible(False)
ax.spines['top'].set_visible(False)
ax.xaxis.set_ticks_position('bottom')

ax.set_xticks((a, b))
ax.set_xticklabels(('a$', 'b$'))
ax.set_yticks([])

plt.show()
```

Keywords: python, matplotlib, pylab, example, codex (see [Search examples](#))

103.5 showcase example code: mandelbrot.py

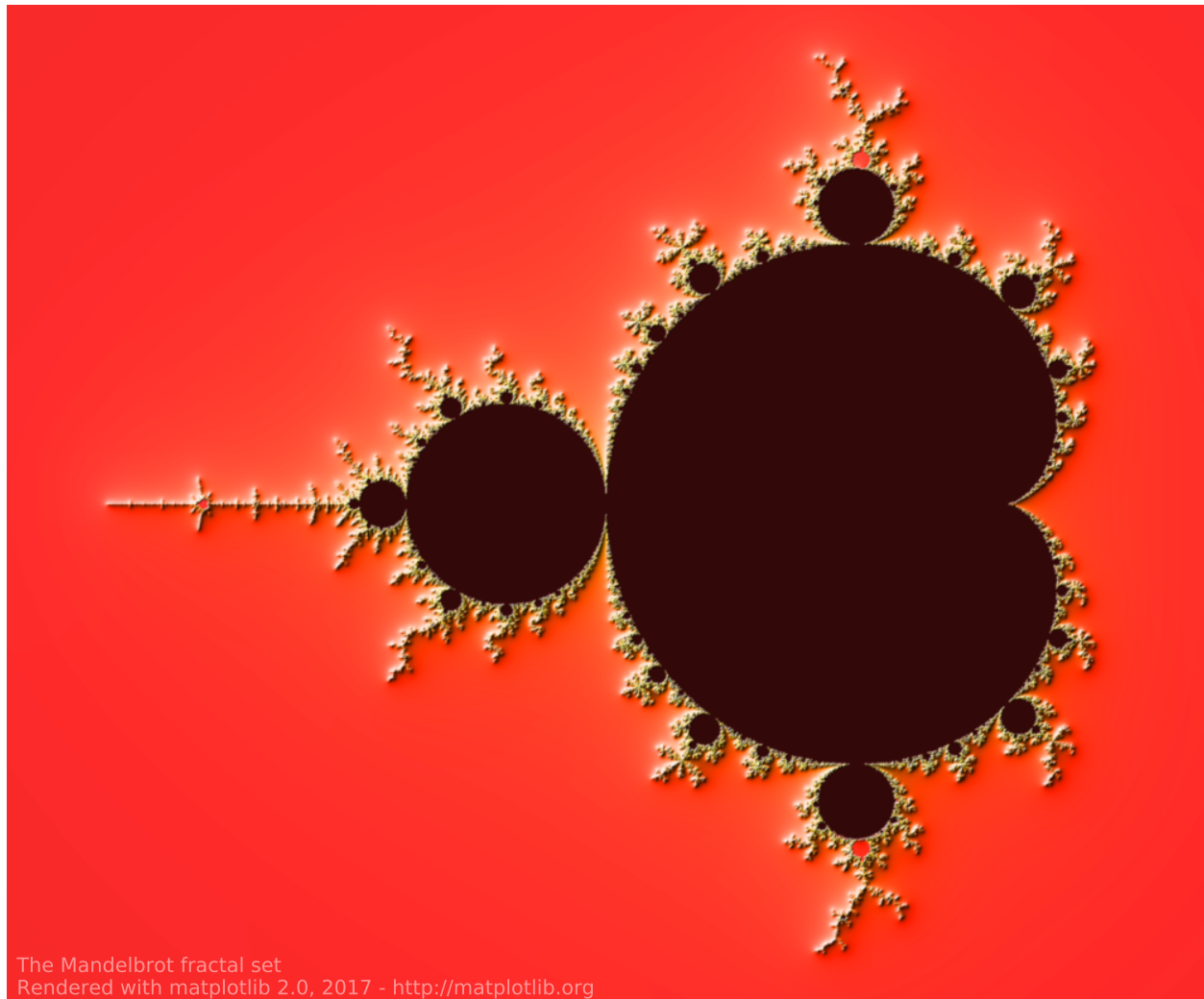

```

"""
=====
Shaded & power normalized rendering
=====

The Mandelbrot set rendering can be improved by using a normalized recount
associated with a power normalized colormap (gamma=0.3). Rendering can be
further enhanced thanks to shading.

The `maxiter` gives the precision of the computation. `maxiter=200` should
take a few seconds on most modern laptops.
"""
import numpy as np

def mandelbrot_set(xmin, xmax, ymin, ymax, xn, yn, maxiter, horizon=2.0):
    X = np.linspace(xmin, xmax, xn, dtype=np.float32)

```

```

Y = np.linspace(ymin, ymax, yn, dtype=np.float32)
C = X + Y[:, None]*1j
N = np.zeros(C.shape, dtype=int)
Z = np.zeros(C.shape, np.complex64)
for n in range(maxiter):
    I = np.less(abs(Z), horizon)
    N[I] = n
    Z[I] = Z[I]**2 + C[I]
N[N == maxiter-1] = 0
return Z, N

if __name__ == '__main__':
    import time
    import matplotlib
    from matplotlib import colors
    import matplotlib.pyplot as plt

    xmin, xmax, xn = -2.25, +0.75, 3000/2
    ymin, ymax, yn = -1.25, +1.25, 2500/2
    maxiter = 200
    horizon = 2.0 ** 40
    log_horizon = np.log(np.log(horizon))/np.log(2)
    Z, N = mandelbrot_set(xmin, xmax, ymin, ymax, xn, yn, maxiter, horizon)

    # Normalized recount as explained in:
    # https://linas.org/art-gallery/escape/smooth.html
    # https://www.ibm.com/developerworks/community/blogs/jfp/entry/My_Christmas_Gift

    # This line will generate warnings for null values but it is faster to
    # process them afterwards using the nan_to_num
    with np.errstate(invalid='ignore'):
        M = np.nan_to_num(N + 1 -
                        np.log(np.log(abs(Z)))/np.log(2) +
                        log_horizon)

    dpi = 72
    width = 10
    height = 10*yn/xn
    fig = plt.figure(figsize=(width, height), dpi=dpi)
    ax = fig.add_axes([0.0, 0.0, 1.0, 1.0], frameon=False, aspect=1)

    # Shaded rendering
    light = colors.LightSource(azdeg=315, altdeg=10)
    M = light.shade(M, cmap=plt.cm.hot, vert_exag=1.5,
                   norm=colors.PowerNorm(0.3), blend_mode='hsv')
    plt.imshow(M, extent=[xmin, xmax, ymin, ymax], interpolation="bicubic")
    ax.set_xticks([])
    ax.set_yticks([])

    # Some advertisement for matplotlib
    year = time.strftime("%Y")
    major, minor, micro = matplotlib.__version__.split('.', 2)

```

```
text = ("The Mandelbrot fractal set\n"  
        "Rendered with matplotlib %s.%s, %s - http://matplotlib.org"  
        % (major, minor, year))  
ax.text(xmin+.025, ymin+.025, text, color="white", fontsize=12, alpha=0.5)  
  
plt.show()
```

Keywords: python, matplotlib, pylab, example, codex (see *Search examples*)

103.6 showcase example code: xkcd.py

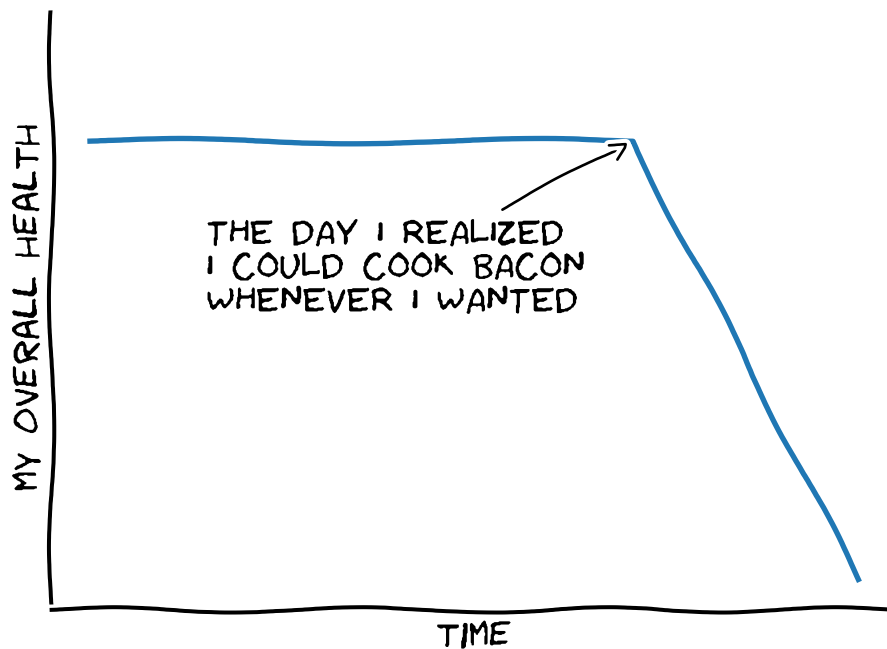

"STOVE OWNERSHIP" FROM XKCD BY RANDALL MONROE

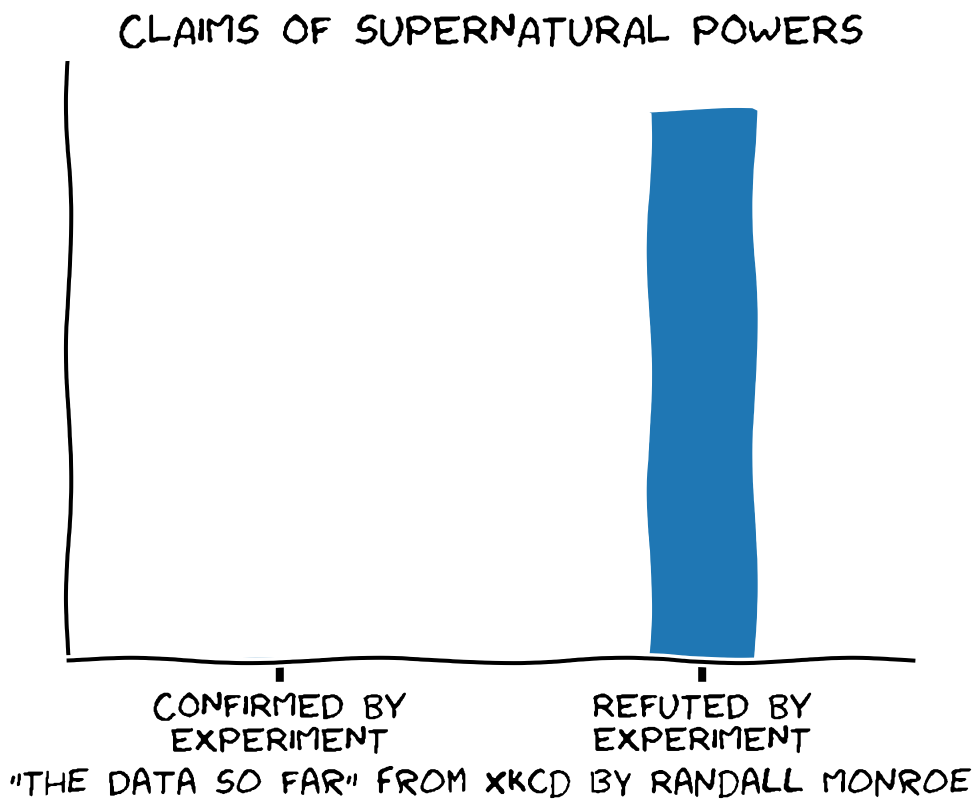

```

"""
====
XKCD
====

Shows how to create an xkcd-like plot.
"""
import matplotlib.pyplot as plt
import numpy as np

with plt.xkcd():
    # Based on "Stove Ownership" from XKCD by Randall Monroe
    # http://xkcd.com/418/

    fig = plt.figure()
    ax = fig.add_axes((0.1, 0.2, 0.8, 0.7))
    ax.spines['right'].set_color('none')
    ax.spines['top'].set_color('none')
    plt.xticks([])
    plt.yticks([])
    ax.set_ylim([-30, 10])

    data = np.ones(100)
    data[70:] -= np.arange(30)

    plt.annotate(

```

```

    'THE DAY I REALIZED\nI COULD COOK BACON\nWHENEVER I WANTED',
    xy=(70, 1), arrowprops=dict(arrowstyle='->'), xytext=(15, -10))

plt.plot(data)

plt.xlabel('time')
plt.ylabel('my overall health')
fig.text(
    0.5, 0.05,
    '"Stove Ownership" from xkcd by Randall Monroe',
    ha='center')

# Based on "The Data So Far" from XKCD by Randall Monroe
# http://xkcd.com/373/

fig = plt.figure()
ax = fig.add_axes((0.1, 0.2, 0.8, 0.7))
ax.bar([0, 1], [0, 100], 0.25)
ax.spines['right'].set_color('none')
ax.spines['top'].set_color('none')
ax.xaxis.set_ticks_position('bottom')
ax.set_xticks([0, 1])
ax.set_xlim([-0.5, 1.5])
ax.set_ylim([0, 110])
ax.set_xticklabels(['CONFIRMED BY\nEXPERIMENT', 'REFUTED BY\nEXPERIMENT'])
plt.yticks([])

plt.title("CLAIMS OF SUPERNATURAL POWERS")

fig.text(
    0.5, 0.05,
    '"The Data So Far" from xkcd by Randall Monroe',
    ha='center')

plt.show()

```

Keywords: python, matplotlib, pylab, example, codex (see *Search examples*)

SPECIALTY_PLOTS EXAMPLES

104.1 specialty_plots example code: advanced_hillshading.py

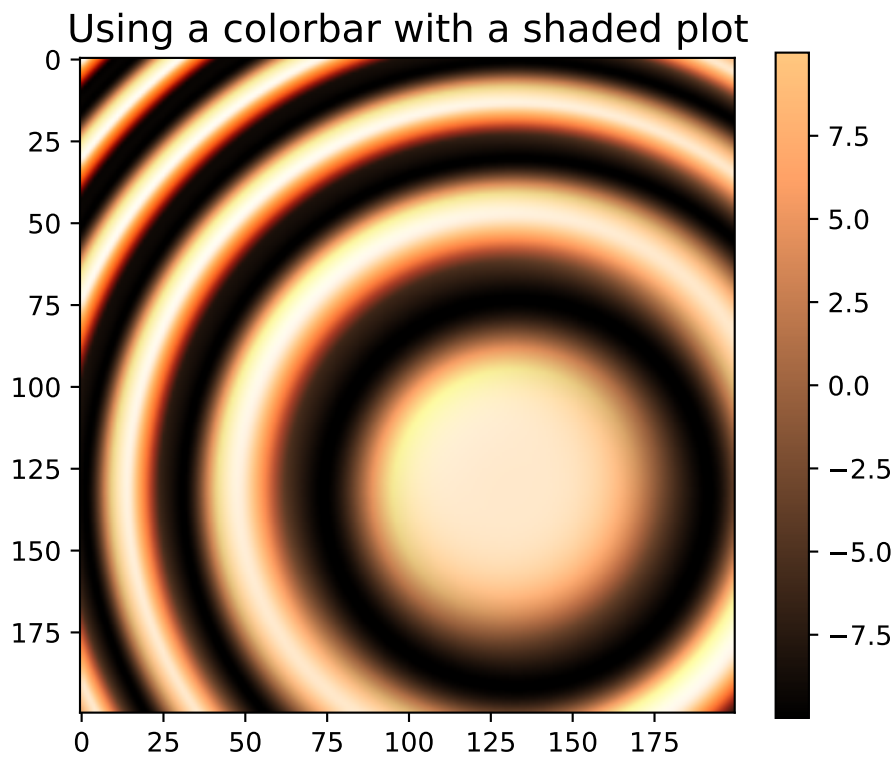

Avoiding Outliers in Shaded Plots

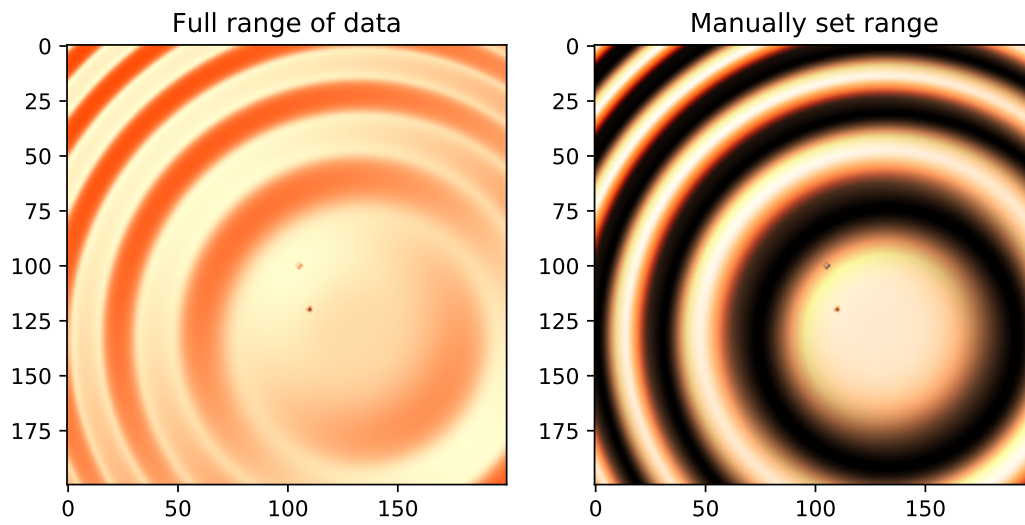

Shade by one variable, color by another

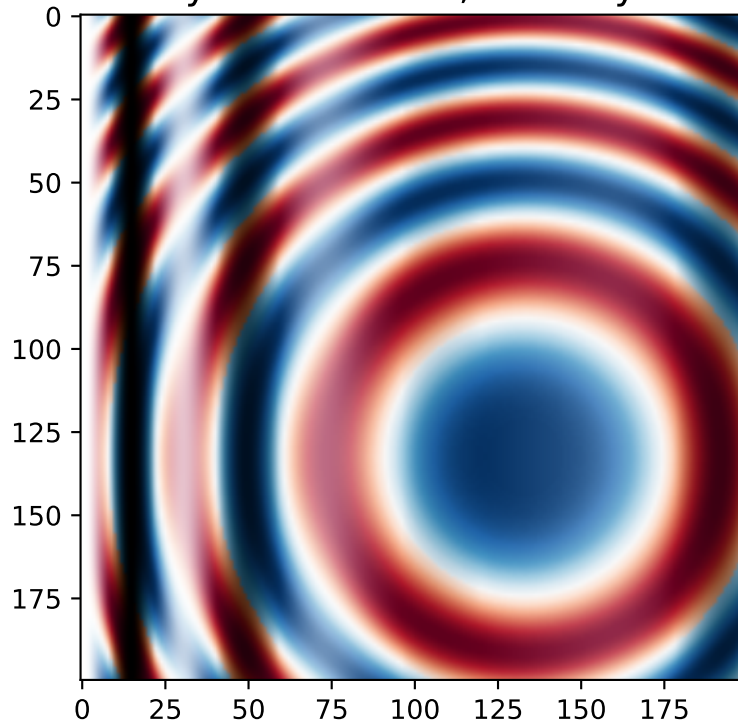

```
"""\nDemonstrates a few common tricks with shaded plots.\n"""
```



```

import numpy as np
import matplotlib.pyplot as plt
from matplotlib.colors import LightSource, Normalize

def display_colorbar():
    """Display a correct numeric colorbar for a shaded plot."""
    y, x = np.mgrid[-4:2:200j, -4:2:200j]
    z = 10 * np.cos(x**2 + y**2)

    cmap = plt.cm.copper
    ls = LightSource(315, 45)
    rgb = ls.shade(z, cmap)

    fig, ax = plt.subplots()
    ax.imshow(rgb, interpolation='bilinear')

    # Use a proxy artist for the colorbar...
    im = ax.imshow(z, cmap=cmap)
    im.remove()
    fig.colorbar(im)

    ax.set_title('Using a colorbar with a shaded plot', size='x-large')

def avoid_outliers():
    """Use a custom norm to control the displayed z-range of a shaded plot."""
    y, x = np.mgrid[-4:2:200j, -4:2:200j]
    z = 10 * np.cos(x**2 + y**2)

    # Add some outliers...
    z[100, 105] = 2000
    z[120, 110] = -9000

    ls = LightSource(315, 45)
    fig, (ax1, ax2) = plt.subplots(ncols=2, figsize=(8, 4.5))

    rgb = ls.shade(z, plt.cm.copper)
    ax1.imshow(rgb, interpolation='bilinear')
    ax1.set_title('Full range of data')

    rgb = ls.shade(z, plt.cm.copper, vmin=-10, vmax=10)
    ax2.imshow(rgb, interpolation='bilinear')
    ax2.set_title('Manually set range')

    fig.suptitle('Avoiding Outliers in Shaded Plots', size='x-large')

def shade_other_data():
    """Demonstrates displaying different variables through shade and color."""
    y, x = np.mgrid[-4:2:200j, -4:2:200j]
    z1 = np.sin(x**2) # Data to hillshade
    z2 = np.cos(x**2 + y**2) # Data to color

```

```
norm = Normalize(z2.min(), z2.max())
cmap = plt.cm.RdBu

ls = LightSource(315, 45)
rgb = ls.shade_rgb(cmap(norm(z2)), z1)

fig, ax = plt.subplots()
ax.imshow(rgb, interpolation='bilinear')
ax.set_title('Shade by one variable, color by another', size='x-large')

display_colorbar()
avoid_outliers()
shade_other_data()
plt.show()
```

Keywords: python, matplotlib, pylab, example, codex (see [Search examples](#))

104.2 specialty_plots example code: hinton_demo.py

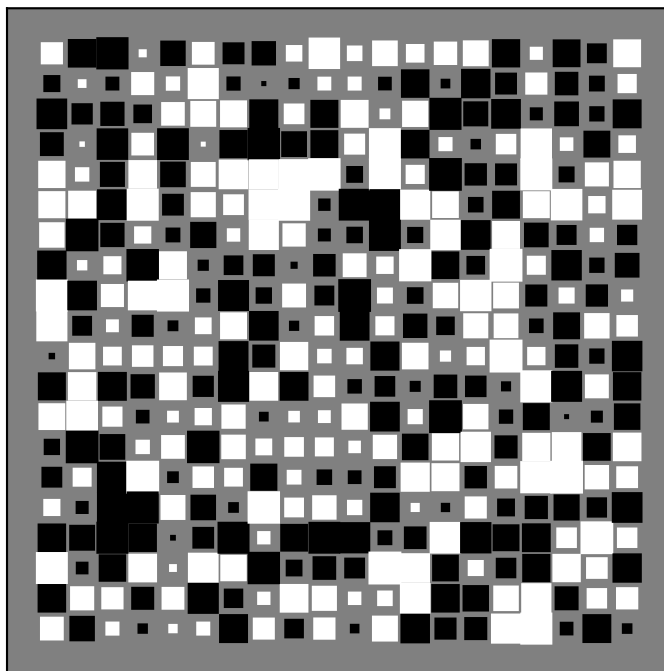

```
"""
Demo of a function to create Hinton diagrams.
```

Hinton diagrams are useful for visualizing the values of a 2D array (e.g. a weight matrix): Positive and negative values are represented by white and black squares, respectively, and the size of each square represents the magnitude of each value.

Initial idea from David Warde-Farley on the SciPy Cookbook

```

"""
import numpy as np
import matplotlib.pyplot as plt

def hinton(matrix, max_weight=None, ax=None):
    """Draw Hinton diagram for visualizing a weight matrix."""
    ax = ax if ax is not None else plt.gca()

    if not max_weight:
        max_weight = 2 ** np.ceil(np.log(np.abs(matrix).max()) / np.log(2))

    ax.patch.set_facecolor('gray')
    ax.set_aspect('equal', 'box')
    ax.xaxis.set_major_locator(plt.NullLocator())
    ax.yaxis.set_major_locator(plt.NullLocator())

    for (x, y), w in np.ndenumerate(matrix):
        color = 'white' if w > 0 else 'black'
        size = np.sqrt(np.abs(w) / max_weight)
        rect = plt.Rectangle([x - size / 2, y - size / 2], size, size,
                             facecolor=color, edgecolor=color)
        ax.add_patch(rect)

    ax.autoscale_view()
    ax.invert_yaxis()

if __name__ == '__main__':
    hinton(np.random.rand(20, 20) - 0.5)
    plt.show()

```

Keywords: python, matplotlib, pylab, example, codex (see [Search examples](#))

104.3 specialty_plots example code: topographic_hillshading.py

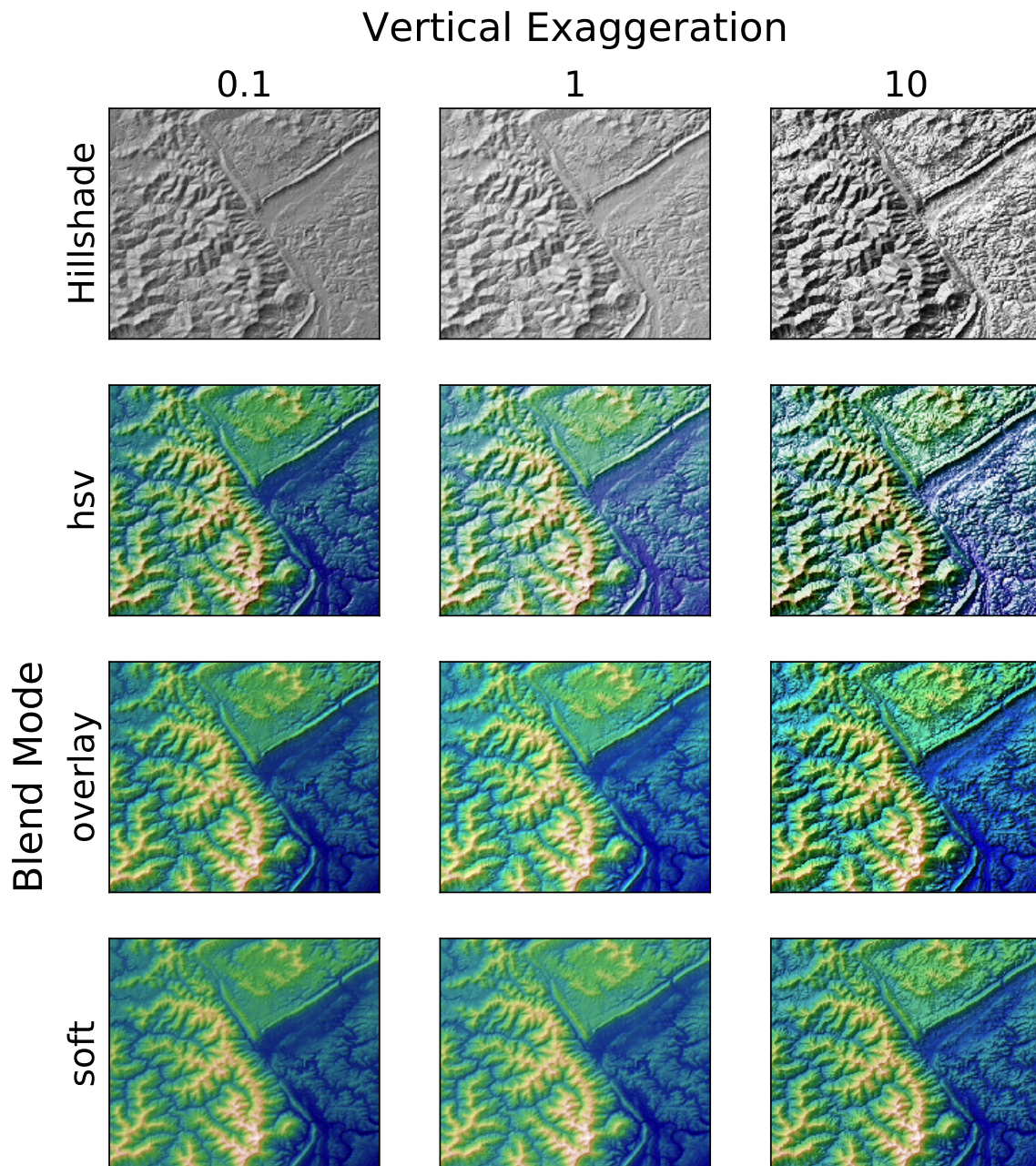

```
"""
```

Demonstrates the visual effect of varying blend mode and vertical exaggeration on "hillshaded" plots.

Note that the "overlay" and "soft" blend modes work well for complex surfaces such as this example, while the default "hsv" blend mode works best for smooth

surfaces such as many mathematical functions.

*In most cases, hillshading is used purely for visual purposes, and `*dx*/dy*` can be safely ignored. In that case, you can tweak `*vert_exag*` (vertical exaggeration) by trial and error to give the desired visual effect. However, this example demonstrates how to use the `*dx*` and `*dy*` kwargs to ensure that the `*vert_exag*` parameter is the true vertical exaggeration.*

```
"""
```

```
import numpy as np
import matplotlib.pyplot as plt
from matplotlib.cbook import get_sample_data
from matplotlib.colors import LightSource

dem = np.load(get_sample_data('jacksboro_fault_dem.npz'))
z = dem['elevation']

#-- Optional dx and dy for accurate vertical exaggeration -----
# If you need topographically accurate vertical exaggeration, or you don't want
# to guess at what *vert_exag* should be, you'll need to specify the cellsize
# of the grid (i.e. the *dx* and *dy* parameters). Otherwise, any *vert_exag*
# value you specify will be relative to the grid spacing of your input data
# (in other words, *dx* and *dy* default to 1.0, and *vert_exag* is calculated
# relative to those parameters). Similarly, *dx* and *dy* are assumed to be in
# the same units as your input z-values. Therefore, we'll need to convert the
# given dx and dy from decimal degrees to meters.
dx, dy = dem['dx'], dem['dy']
dy = 111200 * dy
dx = 111200 * dx * np.cos(np.radians(dem['ymin']))
#-----

# Shade from the northwest, with the sun 45 degrees from horizontal
ls = LightSource(azdeg=315, altdeg=45)
cmap = plt.cm.gist_earth

fig, axes = plt.subplots(nrows=4, ncols=3, figsize=(8, 9))
plt.setp(axes.flat, xticks=[], yticks=[])

# Vary vertical exaggeration and blend mode and plot all combinations
for col, ve in zip(axes.T, [0.1, 1, 10]):
    # Show the hillshade intensity image in the first row
    col[0].imshow(ls.hillshade(z, vert_exag=ve, dx=dx, dy=dy), cmap='gray')

    # Place hillshaded plots with different blend modes in the rest of the rows
    for ax, mode in zip(col[1:], ['hsv', 'overlay', 'soft']):
        rgb = ls.shade(z, cmap=cmap, blend_mode=mode,
                       vert_exag=ve, dx=dx, dy=dy)
        ax.imshow(rgb)

# Label rows and columns
for ax, ve in zip(axes[0], [0.1, 1, 10]):
    ax.set_title('{0}'.format(ve), size=18)
for ax, mode in zip(axes[:, 0], ['Hillshade', 'hsv', 'overlay', 'soft']):
    ax.set_ylabel(mode, size=18)
```

```
# Group labels...
axes[0, 1].annotate('Vertical Exaggeration', (0.5, 1), xytext=(0, 30),
                   textcoords='offset points', xycoords='axes fraction',
                   ha='center', va='bottom', size=20)
axes[2, 0].annotate('Blend Mode', (0, 0.5), xytext=(-30, 0),
                   textcoords='offset points', xycoords='axes fraction',
                   ha='right', va='center', size=20, rotation=90)
fig.subplots_adjust(bottom=0.05, right=0.95)

plt.show()
```

Keywords: python, matplotlib, pylab, example, codex (see [Search examples](#))

STATISTICS EXAMPLES

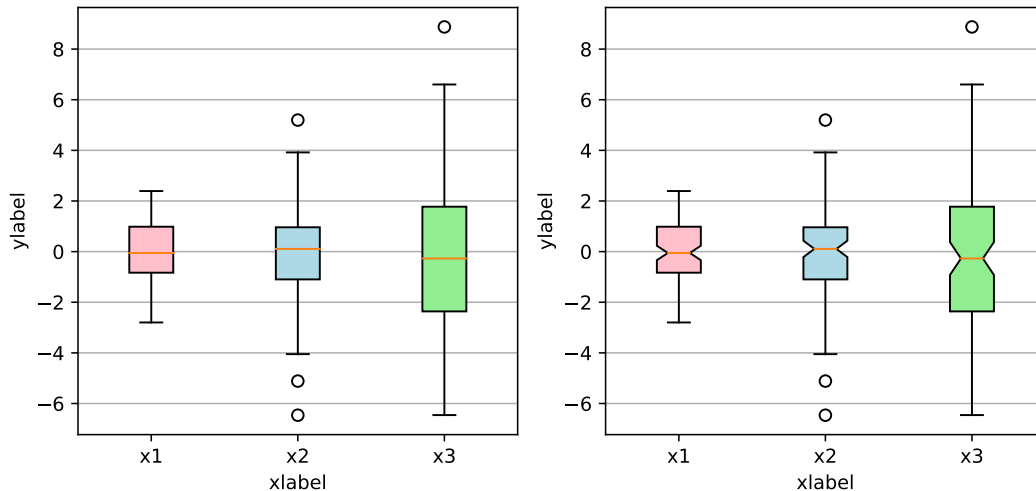
105.1 statistics example code: `boxplot_color_demo.py`

```

"""
=====
Box plots with custom fill colors
=====

This plot illustrates how to create two types of box plots
(rectangular and notched), and how to fill them with custom
colors by accessing the properties of the artists of the
box plots. Additionally, the ``labels`` parameter is used to
provide x-tick labels for each sample.

A good general reference on boxplots and their history can be found
here: http://vita.had.co.nz/papers/boxplots.pdf
"""

import matplotlib.pyplot as plt
import numpy as np

```

```
# Random test data
np.random.seed(123)
all_data = [np.random.normal(0, std, 100) for std in range(1, 4)]

fig, axes = plt.subplots(nrows=1, ncols=2, figsize=(9, 4))

# rectangular box plot
bplot1 = axes[0].boxplot(all_data,
                        vert=True, # vertical box alignment
                        patch_artist=True) # fill with color

# notch shape box plot
bplot2 = axes[1].boxplot(all_data,
                        notch=True, # notch shape
                        vert=True, # vertical box alignment
                        patch_artist=True) # fill with color

# fill with colors
colors = ['pink', 'lightblue', 'lightgreen']
for bplot in (bplot1, bplot2):
    for patch, color in zip(bplot['boxes'], colors):
        patch.set_facecolor(color)

# adding horizontal grid lines
for ax in axes:
    ax.yaxis.grid(True)
    ax.set_xticks([y+1 for y in range(len(all_data))], )
    ax.set_xlabel('xlabel')
    ax.set_ylabel('ylabel')

# add x-tick labels
plt.setp(axes, xticks=[y+1 for y in range(len(all_data))],
        xticklabels=['x1', 'x2', 'x3', 'x4'])

plt.show()
```

Keywords: python, matplotlib, pylab, example, codex (see [Search examples](#))

105.2 statistics example code: boxplot_demo.py

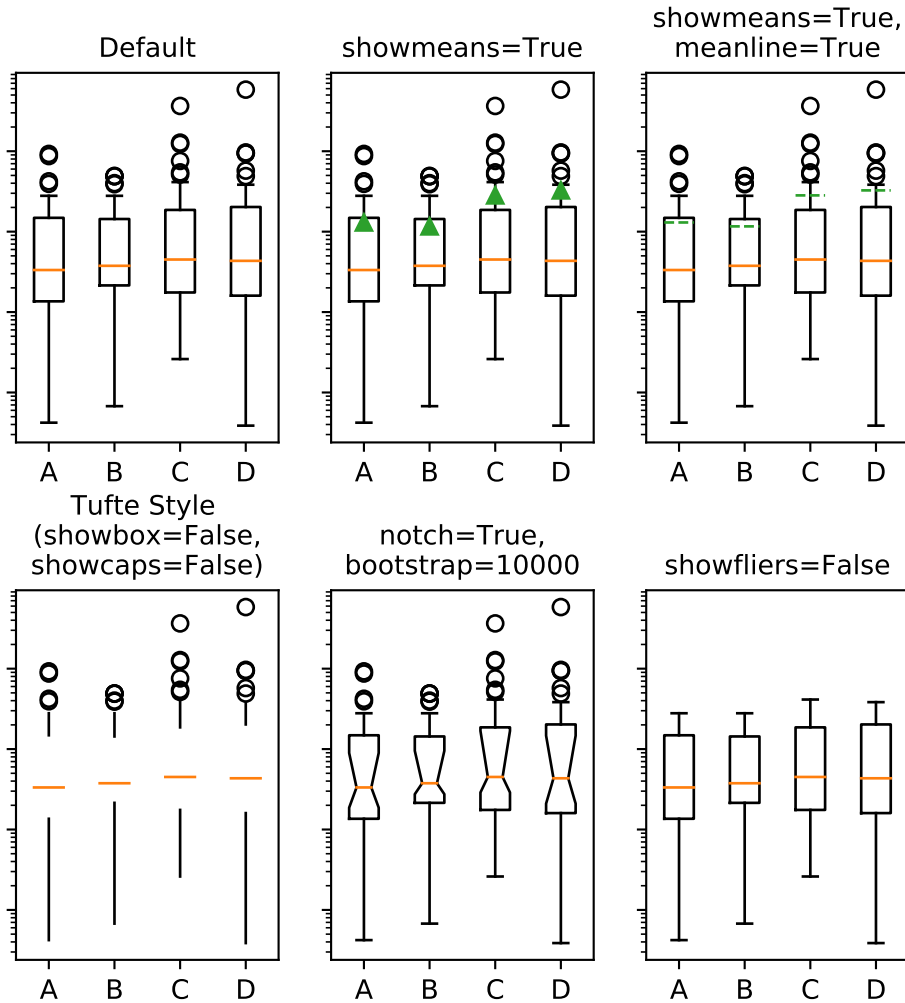

I never said they'd be pretty

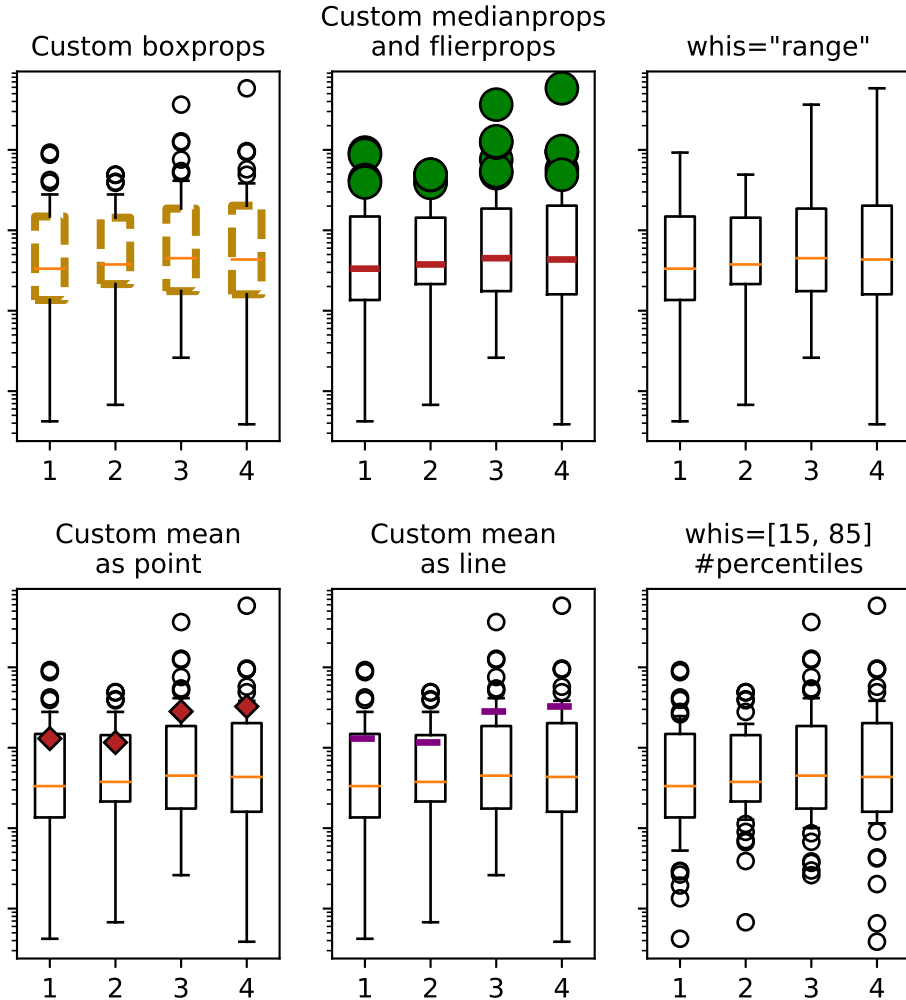

```

"""
=====
Demo of artist customization in box plots
=====

This example demonstrates how to use the various kwargs
to fully customize box plots. The first figure demonstrates
how to remove and add individual components (note that the
mean is the only value not shown by default). The second
figure demonstrates how the styles of the artists can
be customized. It also demonstrates how to set the limit
of the whiskers to specific percentiles (lower right axes)

A good general reference on boxplots and their history can be found
here: http://vita.had.co.nz/papers/boxplots.pdf

```

```

"""

import numpy as np
import matplotlib.pyplot as plt

# fake data
np.random.seed(937)
data = np.random.lognormal(size=(37, 4), mean=1.5, sigma=1.75)
labels = list('ABCD')
fs = 10 # fontsize

# demonstrate how to toggle the display of different elements:
fig, axes = plt.subplots(nrows=2, ncols=3, figsize=(6, 6), sharey=True)
axes[0, 0].boxplot(data, labels=labels)
axes[0, 0].set_title('Default', fontsize=fs)

axes[0, 1].boxplot(data, labels=labels, showmeans=True)
axes[0, 1].set_title('showmeans=True', fontsize=fs)

axes[0, 2].boxplot(data, labels=labels, showmeans=True, meanline=True)
axes[0, 2].set_title('showmeans=True,\nmeanline=True', fontsize=fs)

axes[1, 0].boxplot(data, labels=labels, showbox=False, showcaps=False)
tufte_title = 'Tufte Style \n(showbox=False,\nshowcaps=False)'
axes[1, 0].set_title(tufte_title, fontsize=fs)

axes[1, 1].boxplot(data, labels=labels, notch=True, bootstrap=10000)
axes[1, 1].set_title('notch=True,\nbootstrap=10000', fontsize=fs)

axes[1, 2].boxplot(data, labels=labels, showfliers=False)
axes[1, 2].set_title('showfliers=False', fontsize=fs)

for ax in axes.flatten():
    ax.set_yscale('log')
    ax.set_yticklabels([])

fig.subplots_adjust(hspace=0.4)
plt.show()

# demonstrate how to customize the display different elements:
boxprops = dict(linestyle='--', linewidth=3, color='darkgoldenrod')
flierprops = dict(marker='o', markerfacecolor='green', markersize=12,
                  linestyle='none')
medianprops = dict(linestyle='-.', linewidth=2.5, color='firebrick')
meanpointprops = dict(marker='D', markeredgecolor='black',
                      markerfacecolor='firebrick')
meanlineprops = dict(linestyle='--', linewidth=2.5, color='purple')

fig, axes = plt.subplots(nrows=2, ncols=3, figsize=(6, 6), sharey=True)
axes[0, 0].boxplot(data, boxprops=boxprops)
axes[0, 0].set_title('Custom boxprops', fontsize=fs)

```

```

axes[0, 1].boxplot(data, flierprops=flierprops, medianprops=medianprops)
axes[0, 1].set_title('Custom medianprops\nand flierprops', fontsize=fs)

axes[0, 2].boxplot(data, whis='range')
axes[0, 2].set_title('whis="range"', fontsize=fs)

axes[1, 0].boxplot(data, meanprops=meanpointprops, meanline=False,
                  showmeans=True)
axes[1, 0].set_title('Custom mean\nas point', fontsize=fs)

axes[1, 1].boxplot(data, meanprops=meanlineprops, meanline=True,
                  showmeans=True)
axes[1, 1].set_title('Custom mean\nas line', fontsize=fs)

axes[1, 2].boxplot(data, whis=[15, 85])
axes[1, 2].set_title('whis=[15, 85]\n#percentiles', fontsize=fs)

for ax in axes.flatten():
    ax.set_yscale('log')
    ax.set_yticklabels([])

fig.suptitle("I never said they'd be pretty")
fig.subplots_adjust(hspace=0.4)
plt.show()

```

Keywords: python, matplotlib, pylab, example, codex (see [Search examples](#))

105.3 statistics example code: boxplot_vs_violin_demo.py

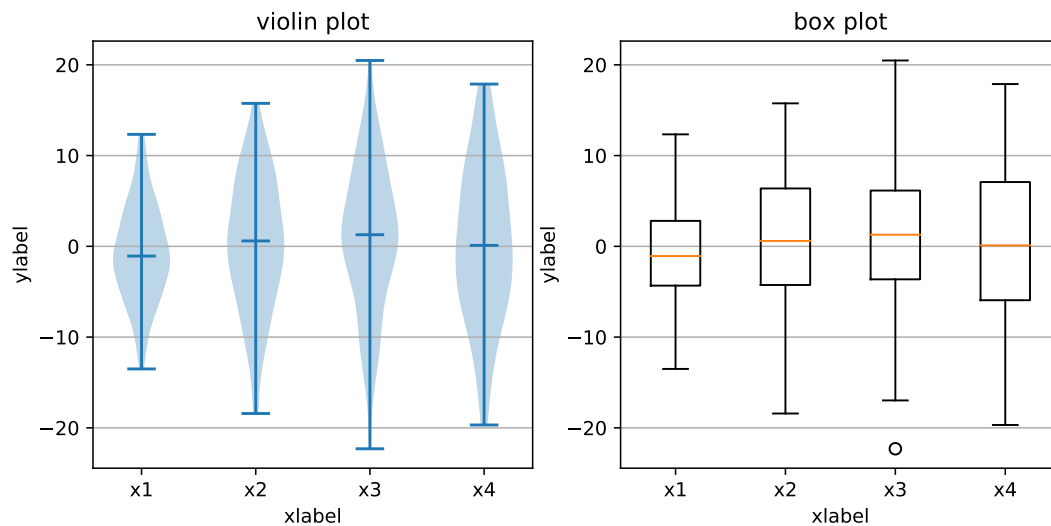

```

"""
=====
Box plot vs. violin plot comparison

```

```
=====

Note that although violin plots are closely related to Tukey's (1977)
box plots, they add useful information such as the distribution of the
sample data (density trace).
```

```
By default, box plots show data points outside 1.5 * the inter-quartile
range as outliers above or below the whiskers whereas violin plots show
the whole range of the data.
```

```
A good general reference on boxplots and their history can be found
here: http://vita.had.co.nz/papers/boxplots.pdf
```

```
Violin plots require matplotlib >= 1.4.
```

```
For more information on violin plots, the scikit-learn docs have a great
section: http://scikit-learn.org/stable/modules/density.html
"""
```

```
import matplotlib.pyplot as plt
import numpy as np

fig, axes = plt.subplots(nrows=1, ncols=2, figsize=(9, 4))

# generate some random test data
all_data = [np.random.normal(0, std, 100) for std in range(6, 10)]

# plot violin plot
axes[0].violinplot(all_data,
                   showmeans=False,
                   showmedians=True)
axes[0].set_title('violin plot')

# plot box plot
axes[1].boxplot(all_data)
axes[1].set_title('box plot')

# adding horizontal grid lines
for ax in axes:
    ax.yaxis.grid(True)
    ax.set_xticks([y+1 for y in range(len(all_data))])
    ax.set_xlabel('xlabel')
    ax.set_ylabel('ylabel')

# add x-tick labels
plt.setp(axes, xticks=[y+1 for y in range(len(all_data))],
         xticklabels=['x1', 'x2', 'x3', 'x4'])
plt.show()
```

Keywords: python, matplotlib, pylab, example, codex (see [Search examples](#))

105.4 statistics example code: bxp_demo.py

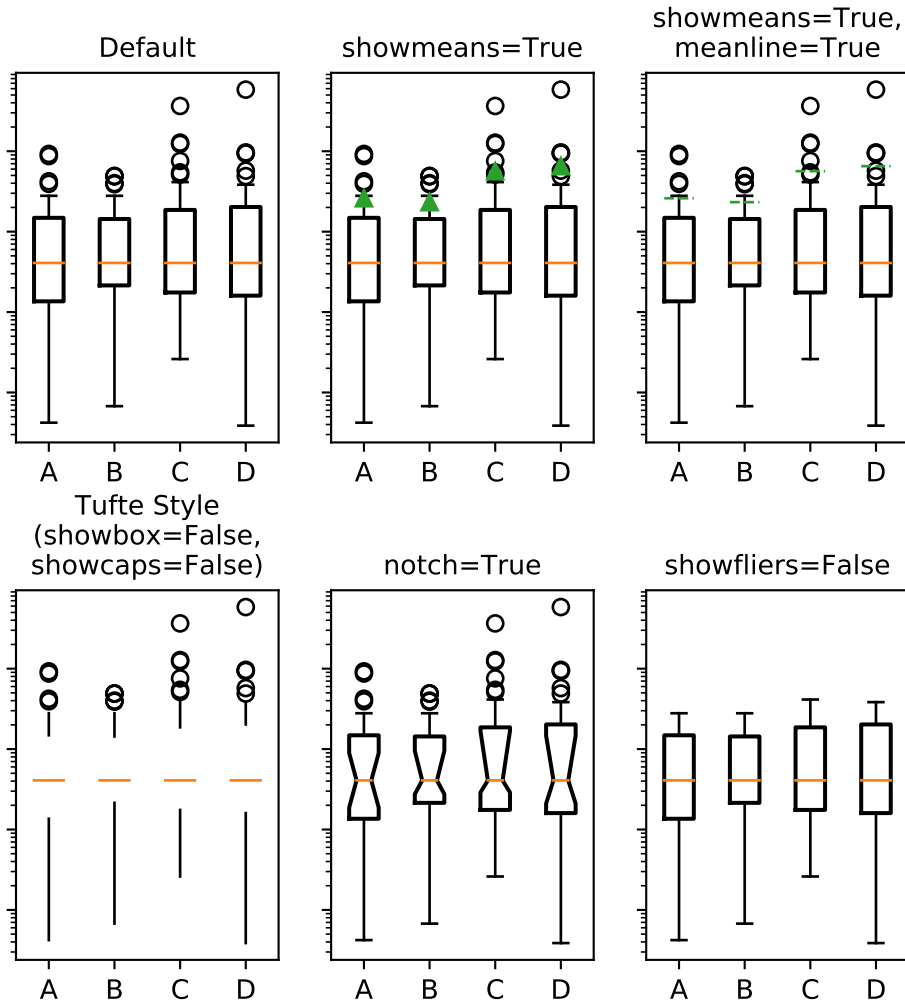

I never said they'd be pretty

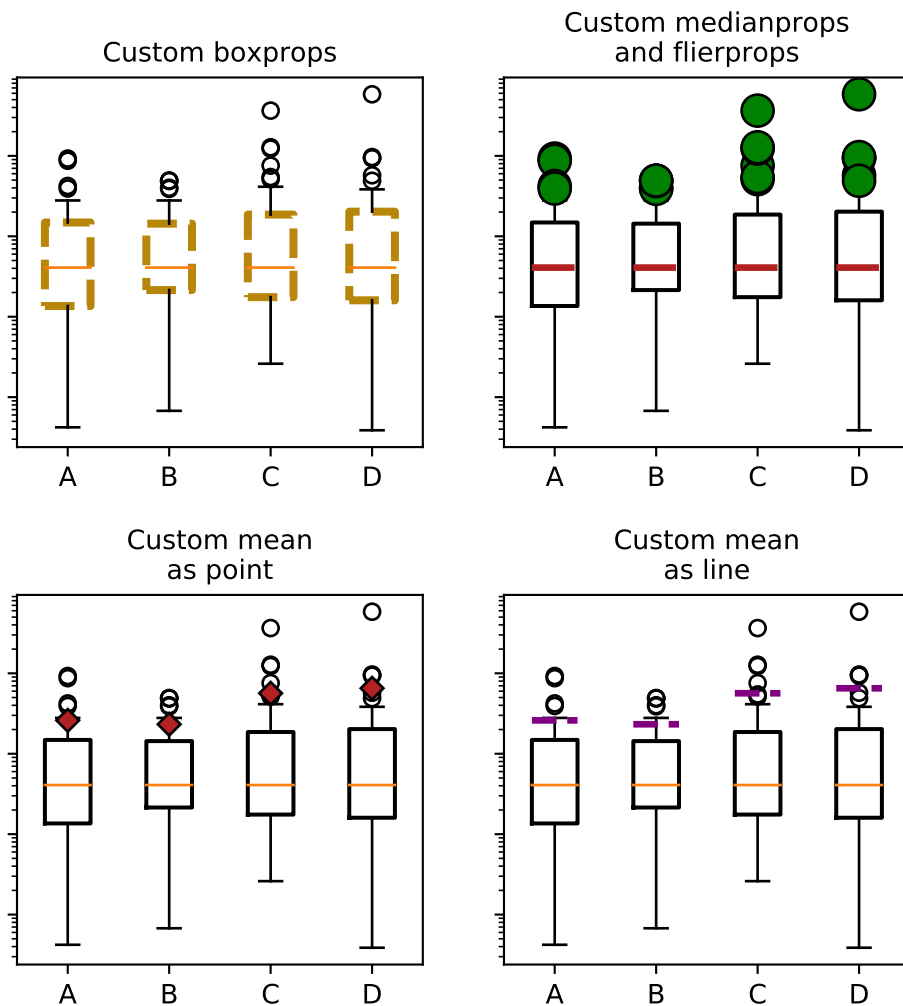

```
"""
```

```
=====
Demo of the boxplot drawer function
=====
```

This example demonstrates how to pass pre-computed box plot statistics to the box plot drawer. The first figure demonstrates how to remove and add individual components (note that the mean is the only value not shown by default). The second figure demonstrates how the styles of the artists can be customized.

A good general reference on boxplots and their history can be found here: <http://vita.had.co.nz/papers/boxplots.pdf>

```
"""
```

```
import numpy as np
import matplotlib.pyplot as plt
import matplotlib.cbook as cbook

# fake data
np.random.seed(937)
data = np.random.lognormal(size=(37, 4), mean=1.5, sigma=1.75)
labels = list('ABCD')

# compute the boxplot stats
stats = cbook.boxplot_stats(data, labels=labels, bootstrap=10000)
# After we've computed the stats, we can go through and change anything.
# Just to prove it, I'll set the median of each set to the median of all
# the data, and double the means
for n in range(len(stats)):
    stats[n]['med'] = np.median(data)
    stats[n]['mean'] *= 2

print(stats[0].keys())

fs = 10 # fontsize

# demonstrate how to toggle the display of different elements:
fig, axes = plt.subplots(nrows=2, ncols=3, figsize=(6, 6), sharey=True)
axes[0, 0].boxplot(stats)
axes[0, 0].set_title('Default', fontsize=fs)

axes[0, 1].boxplot(stats, showmeans=True)
axes[0, 1].set_title('showmeans=True', fontsize=fs)

axes[0, 2].boxplot(stats, showmeans=True, meanline=True)
axes[0, 2].set_title('showmeans=True,\nmeanline=True', fontsize=fs)

axes[1, 0].boxplot(stats, showbox=False, showcaps=False)
tufte_title = 'Tufte Style\n(showbox=False,\nshowcaps=False)'
axes[1, 0].set_title(tufte_title, fontsize=fs)

axes[1, 1].boxplot(stats, shownotches=True)
axes[1, 1].set_title('notch=True', fontsize=fs)

axes[1, 2].boxplot(stats, showfliers=False)
axes[1, 2].set_title('showfliers=False', fontsize=fs)

for ax in axes.flatten():
    ax.set_yscale('log')
    ax.set_yticklabels([])

fig.subplots_adjust(hspace=0.4)
plt.show()

# demonstrate how to customize the display different elements:
boxprops = dict(linestyle='--', linewidth=3, color='darkgoldenrod')
flierprops = dict(marker='o', markerfacecolor='green', markersize=12,
```



```

        linestyle='none')
medianprops = dict(linestyle='-.', linewidth=2.5, color='firebrick')
meanpointprops = dict(marker='D', markeredgecolor='black',
                       markerfacecolor='firebrick')
meanlineprops = dict(linestyle='--', linewidth=2.5, color='purple')

fig, axes = plt.subplots(nrows=2, ncols=2, figsize=(6, 6), sharey=True)
axes[0, 0].bxp(stats, boxprops=boxprops)
axes[0, 0].set_title('Custom boxprops', fontsize=fs)

axes[0, 1].bxp(stats, flierprops=flierprops, medianprops=medianprops)
axes[0, 1].set_title('Custom medianprops\nand flierprops', fontsize=fs)

axes[1, 0].bxp(stats, meanprops=meanpointprops, meanline=False,
               showmeans=True)
axes[1, 0].set_title('Custom mean\nas point', fontsize=fs)

axes[1, 1].bxp(stats, meanprops=meanlineprops, meanline=True,
               showmeans=True)
axes[1, 1].set_title('Custom mean\nas line', fontsize=fs)

for ax in axes.flatten():
    ax.set_yscale('log')
    ax.set_yticklabels([])

fig.suptitle("I never said they'd be pretty")
fig.subplots_adjust(hspace=0.4)
plt.show()

```

Keywords: python, matplotlib, pylab, example, codex (see [Search examples](#))

105.5 statistics example code: customized_violin_demo.py

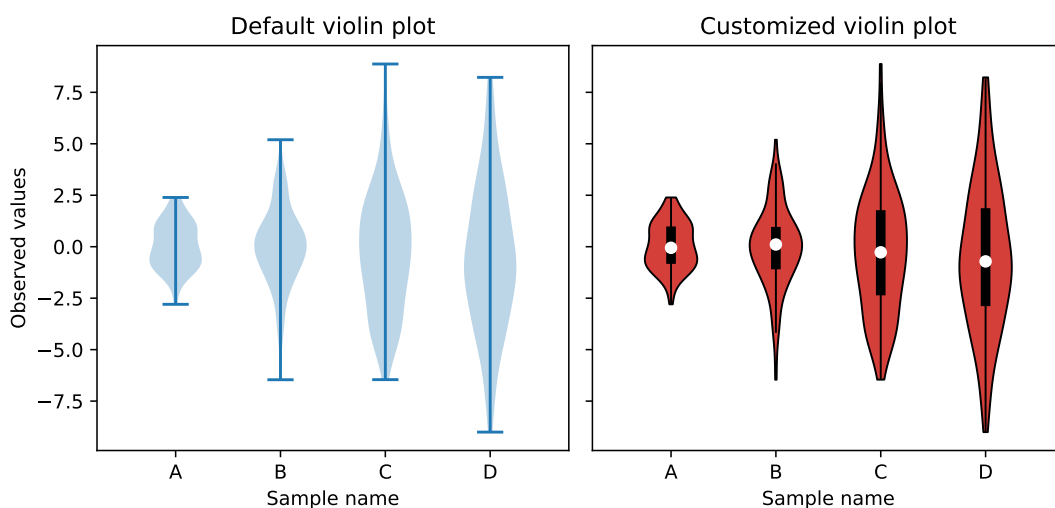

```

"""
=====
Demo of violin plot customization
=====

This example demonstrates how to fully customize violin plots.
The first plot shows the default style by providing only
the data. The second plot first limits what matplotlib draws
with additional kwargs. Then a simplified representation of
a box plot is drawn on top. Lastly, the styles of the artists
of the violins are modified.

For more information on violin plots, the scikit-learn docs have a great
section: http://scikit-learn.org/stable/modules/density.html
"""

import matplotlib.pyplot as plt
import numpy as np

def adjacent_values(vals, q1, q3):
    upper_adjacent_value = q3 + (q3 - q1) * 1.5
    upper_adjacent_value = np.clip(upper_adjacent_value, q3, vals[-1])

    lower_adjacent_value = q1 - (q3 - q1) * 1.5
    lower_adjacent_value = np.clip(lower_adjacent_value, vals[0], q1)
    return lower_adjacent_value, upper_adjacent_value

def set_axis_style(ax, labels):
    ax.get_xaxis().set_tick_params(direction='out')
    ax.xaxis.set_ticks_position('bottom')
    ax.set_xticks(np.arange(1, len(labels) + 1))
    ax.set_xticklabels(labels)
    ax.set_xlim(0.25, len(labels) + 0.75)
    ax.set_xlabel('Sample name')

# create test data
np.random.seed(123)
data = [sorted(np.random.normal(0, std, 100)) for std in range(1, 5)]

fig, (ax1, ax2) = plt.subplots(nrows=1, ncols=2, figsize=(9, 4), sharey=True)

ax1.set_title('Default violin plot')
ax1.set_ylabel('Observed values')
ax1.violinplot(data)

ax2.set_title('Customized violin plot')
parts = ax2.violinplot(
    data, showmeans=False, showmedians=False,
    showextrema=False)

```

```
for pc in parts['bodies']:
    pc.set_facecolor('#D43F3A')
    pc.set_edgecolor('black')
    pc.set_alpha(1)

quartile1, medians, quartile3 = np.percentile(data, [25, 50, 75], axis=1)
whiskers = np.array([
    adjacent_values(sorted_array, q1, q3)
    for sorted_array, q1, q3 in zip(data, quartile1, quartile3)])
whiskersMin, whiskersMax = whiskers[:, 0], whiskers[:, 1]

inds = np.arange(1, len(medians) + 1)
ax2.scatter(inds, medians, marker='o', color='white', s=30, zorder=3)
ax2.vlines(inds, quartile1, quartile3, color='k', linestyle='-', lw=5)
ax2.vlines(inds, whiskersMin, whiskersMax, color='k', linestyle='-', lw=1)

# set style for the axes
labels = ['A', 'B', 'C', 'D']
for ax in [ax1, ax2]:
    set_axis_style(ax, labels)

plt.subplots_adjust(bottom=0.15, wspace=0.05)
plt.show()
```

Keywords: python, matplotlib, pylab, example, codex (see [Search examples](#))

105.6 statistics example code: errorbar_demo.py

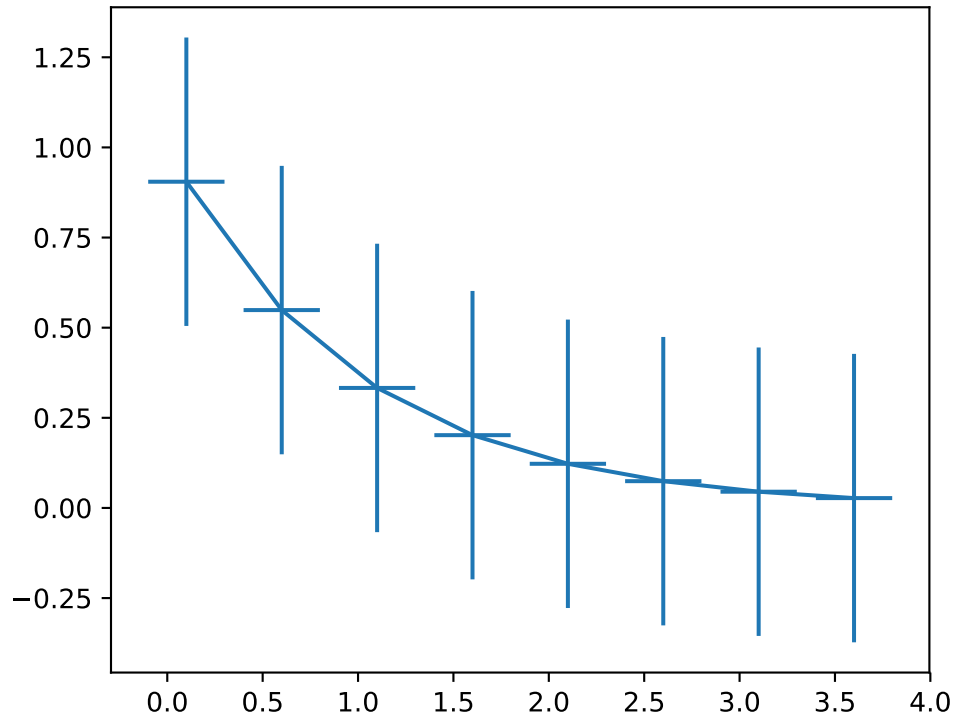

```
"""
=====
Demo of the errorbar function
=====

This exhibits the most basic use of the error bar method.
In this case, constant values are provided for the error
in both the x- and y-directions.
"""

import numpy as np
import matplotlib.pyplot as plt

# example data
x = np.arange(0.1, 4, 0.5)
y = np.exp(-x)

fig, ax = plt.subplots()
ax.errorbar(x, y, xerr=0.2, yerr=0.4)
plt.show()
```

Keywords: python, matplotlib, pylab, example, codex (see [Search examples](#))

105.7 statistics example code: errorbar_demo_features.py

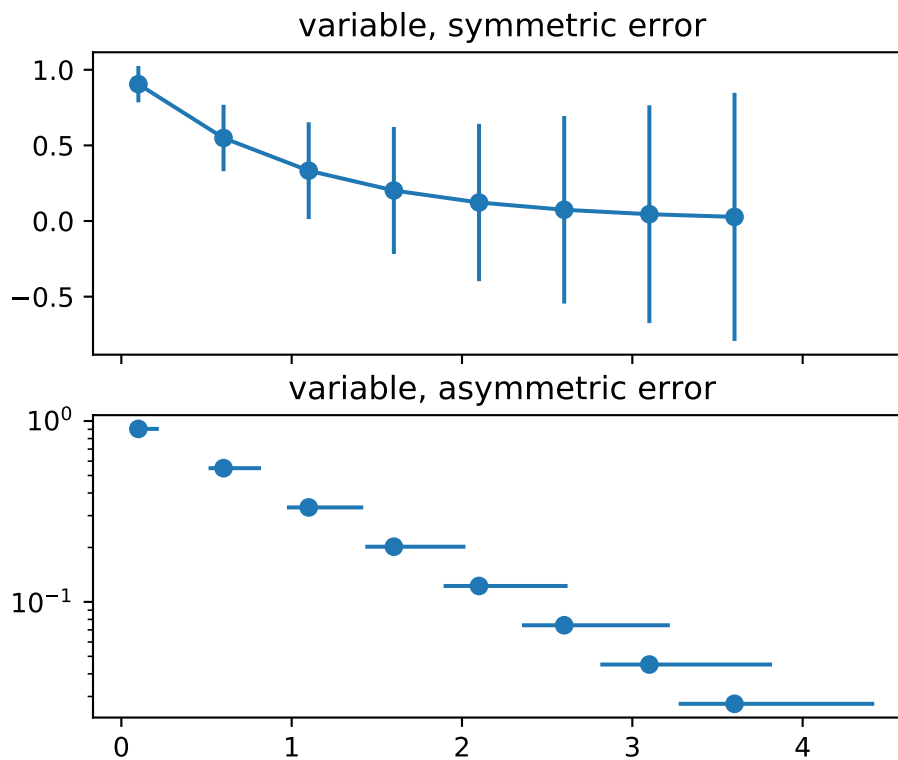

```

"""
=====
Demo of the different ways of specifying error bars
=====

Errors can be specified as a constant value (as shown in
`errorbar_demo.py`). However, this example demonstrates
how they vary by specifying arrays of error values.

If the raw ``x`` and ``y`` data have length  $N$ , there are two options:

Array of shape  $(N,)$ :
    Error varies for each point, but the error values are
    symmetric (i.e. the lower and upper values are equal).

Array of shape  $(2, N)$ :
    Error varies for each point, and the lower and upper limits
    (in that order) are different (asymmetric case)

In addition, this example demonstrates how to use log
scale with error bars.
"""

```

```
import numpy as np
import matplotlib.pyplot as plt

# example data
x = np.arange(0.1, 4, 0.5)
y = np.exp(-x)

# example error bar values that vary with x-position
error = 0.1 + 0.2 * x

fig, (ax0, ax1) = plt.subplots(nrows=2, sharex=True)
ax0.errorbar(x, y, yerr=error, fmt='-o')
ax0.set_title('variable, symmetric error')

# error bar values w/ different +/- errors that
# also vary with the x-position
lower_error = 0.4 * error
upper_error = error
asymmetric_error = [lower_error, upper_error]

ax1.errorbar(x, y, xerr=asymmetric_error, fmt='o')
ax1.set_title('variable, asymmetric error')
ax1.set_yscale('log')
plt.show()
```

Keywords: python, matplotlib, pylab, example, codex (see [Search examples](#))

105.8 statistics example code: errorbar_limits.py

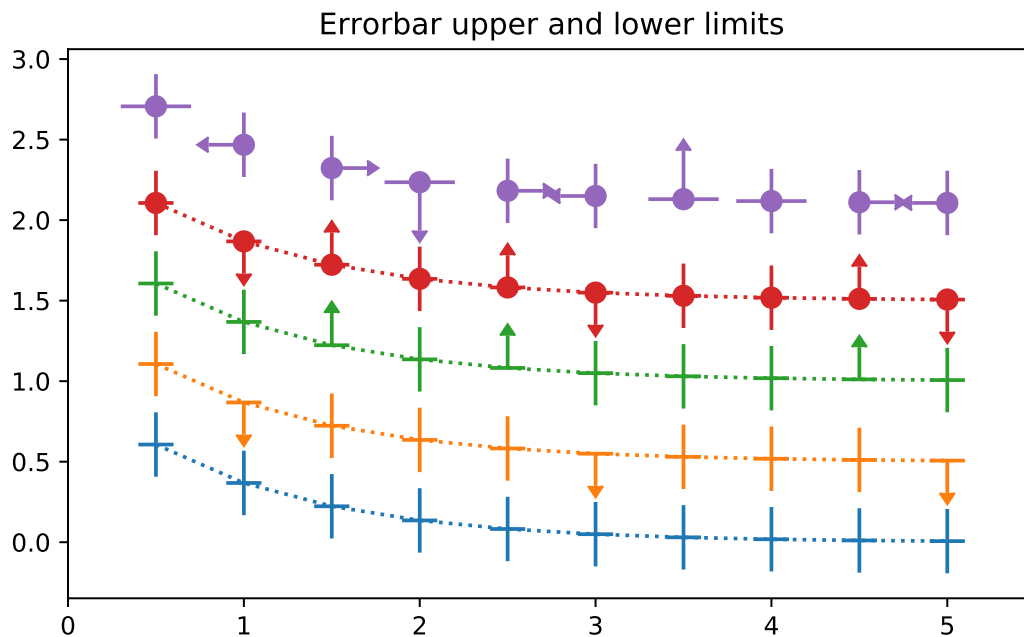

```

"""
=====
Demo of how to include upper and lower limits in error bars
=====

In matplotlib, errors bars can have "limits". Applying limits to the
error bars essentially makes the error unidirectional. Because of that,
upper and lower limits can be applied in both the y- and x-directions
via the ``uplims``, ``lolims``, ``xuplims``, and ``xlolims`` parameters,
respectively. These parameters can be scalar or boolean arrays.

For example, if ``xlolims`` is ``True``, the x-error bars will only
extend from the data towards increasing values. If ``uplims`` is an
array filled with ``False`` except for the 4th and 7th values, all of the
y-error bars will be bidirectional, except the 4th and 7th bars, which
will extend from the data towards decreasing y-values.
"""

import numpy as np
import matplotlib.pyplot as plt

# example data
x = np.array([0.5, 1.0, 1.5, 2.0, 2.5, 3.0, 3.5, 4.0, 4.5, 5.0])
y = np.exp(-x)
xerr = 0.1
yerr = 0.2

```

```

# lower & upper limits of the error
lolims = np.array([0, 0, 1, 0, 1, 0, 0, 0, 1, 0], dtype=bool)
uplims = np.array([0, 1, 0, 0, 0, 1, 0, 0, 0, 1], dtype=bool)
ls = 'dotted'

fig, ax = plt.subplots(figsize=(7, 4))

# standard error bars
ax.errorbar(x, y, xerr=xerr, yerr=yerr, linestyle=ls)

# including upper limits
ax.errorbar(x, y + 0.5, xerr=xerr, yerr=yerr, uplims=uplims,
            linestyle=ls)

# including lower limits
ax.errorbar(x, y + 1.0, xerr=xerr, yerr=yerr, lolims=lolims,
            linestyle=ls)

# including upper and lower limits
ax.errorbar(x, y + 1.5, xerr=xerr, yerr=yerr,
            lolims=lolims, uplims=uplims,
            marker='o', markersize=8,
            linestyle=ls)

# Plot a series with lower and upper limits in both x & y
# constant x-error with varying y-error
xerr = 0.2
yerr = np.zeros(x.shape) + 0.2
yerr[[3, 6]] = 0.3

# mock up some limits by modifying previous data
xlolims = lolims
xuplims = uplims
lolims = np.zeros(x.shape)
uplims = np.zeros(x.shape)
lolims[[6]] = True # only limited at this index
uplims[[3]] = True # only limited at this index

# do the plotting
ax.errorbar(x, y + 2.1, xerr=xerr, yerr=yerr,
            xlolims=xlolims, xuplims=xuplims,
            uplims=uplims, lolims=lolims,
            marker='o', markersize=8,
            linestyle='none')

# tidy up the figure
ax.set_xlim((0, 5.5))
ax.set_title('Errorbar upper and lower limits')
plt.show()

```

Keywords: python, matplotlib, pylab, example, codex (see [Search examples](#))

105.9 statistics example code: errorbars_and_boxes.py

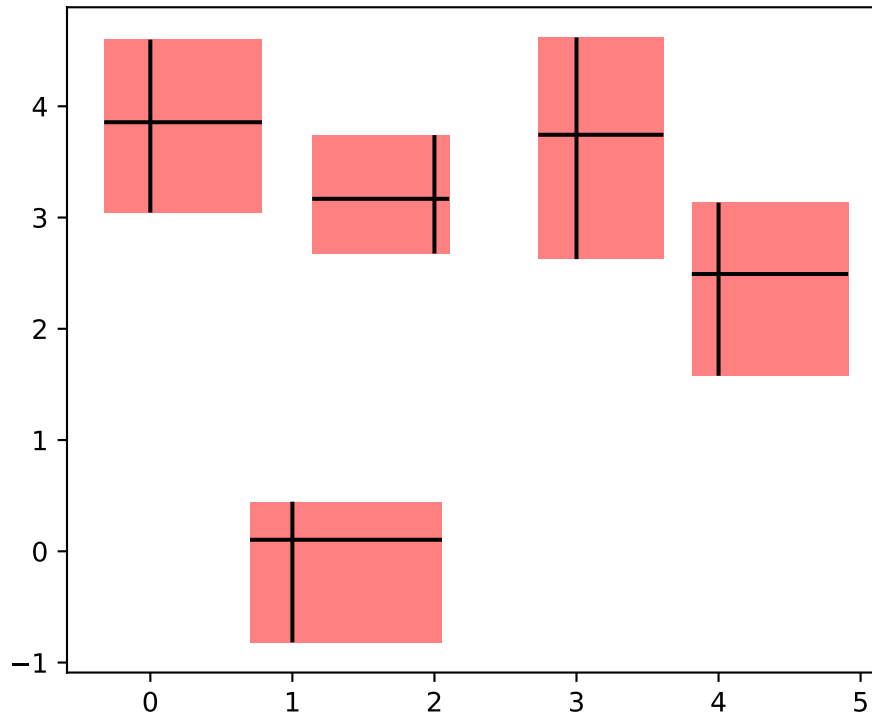

```

"""
=====
Demo on creating boxes from error bars using PatchCollection
=====

In this example, we snazz up a pretty standard error bar plot by adding
a rectangle patch defined by the limits of the bars in both the x- and
y- directions. To do this, we have to write our own custom function
called ``make_error_boxes``. Close inspection of this function will
reveal the preferred pattern in writing functions for matplotlib:

1. an ``Axes`` object is passed directly to the function
2. the function operates on the `Axes` methods directly, not through
   the ``pyplot`` interface
3. plotting kwargs that could be abbreviated are spelled out for
   better code readability in the future (for example we use
   ``facecolor`` instead of ``fc``)
4. the artists returned by the ``Axes`` plotting methods are then
   returned by the function so that, if desired, their styles
   can be modified later outside of the function (they are not
   modified in this example).
"""

```

```
import numpy as np
import matplotlib.pyplot as plt
from matplotlib.collections import PatchCollection
from matplotlib.patches import Rectangle

# Number of data points
n = 5

# Dummy data
np.random.seed(10)
x = np.arange(0, n, 1)
y = np.random.rand(n) * 5.

# Dummy errors (above and below)
xerr = np.random.rand(2, n) + 0.1
yerr = np.random.rand(2, n) + 0.2

def make_error_boxes(ax, xdata, ydata, xerror, yerror, facecolor='r',
                    edgcolor='None', alpha=0.5):

    # Create list for all the error patches
    errorboxes = []

    # Loop over data points; create box from errors at each point
    for x, y, xe, ye in zip(xdata, ydata, xerror.T, yerror.T):
        rect = Rectangle((x - xe[0], y - ye[0]), xe.sum(), ye.sum())
        errorboxes.append(rect)

    # Create patch collection with specified colour/alpha
    pc = PatchCollection(errorboxes, facecolor=facecolor, alpha=alpha,
                        edgcolor=edgcolor)

    # Add collection to axes
    ax.add_collection(pc)

    # Plot errorbars
    artists = ax.errorbar(xdata, ydata, xerr=xerror, yerr=yerror,
                          fmt='None', ecolor='k')

    return artists

# Create figure and axes
fig, ax = plt.subplots(1)

# Call function to create error boxes
_ = make_error_boxes(ax, x, y, xerr, yerr)

plt.show()
```

Keywords: python, matplotlib, pylab, example, codex (see [Search examples](#))

105.10 statistics example code: histogram_demo_cumulative.py

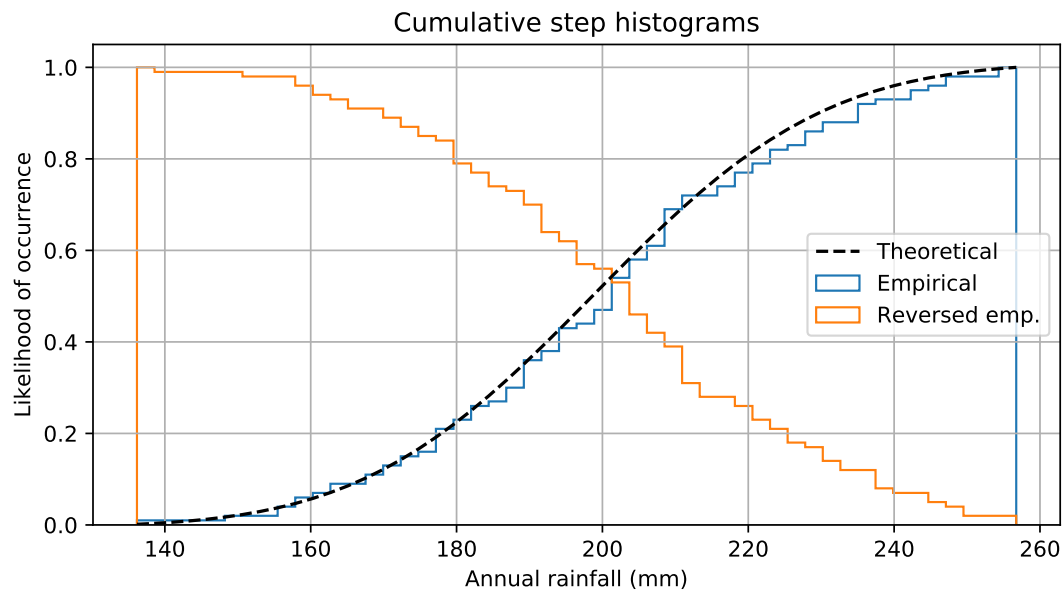

```

"""
=====
Demo of using histograms to plot a cumulative distribution
=====

This shows how to plot a cumulative, normalized histogram as a
step function in order to visualize the empirical cumulative
distribution function (CDF) of a sample. We also use the ``mlab``
module to show the theoretical CDF.

A couple of other options to the ``hist`` function are demonstrated.
Namely, we use the ``normed`` parameter to normalize the histogram and
a couple of different options to the ``cumulative`` parameter.
The ``normed`` parameter takes a boolean value. When ``True``, the bin
heights are scaled such that the total area of the histogram is 1. The
``cumulative`` kwarg is a little more nuanced. Like ``normed``, you
can pass it True or False, but you can also pass it -1 to reverse the
distribution.

Since we're showing a normalized and cumulative histogram, these curves
are effectively the cumulative distribution functions (CDFs) of the
samples. In engineering, empirical CDFs are sometimes called
"non-exceedance" curves. In other words, you can look at the
y-value for a given-x-value to get the probability of an observation
from the sample not exceeding that x-value. For example, the value of
225 on the x-axis corresponds to about 0.85 on the y-axis, so there's an
85% chance that an observation in the sample does not exceed 225.
Conversely, setting, ``cumulative`` to -1 as is done in the
last series for this example, creates a "exceedance" curve.

```

Selecting different bin counts and sizes can significantly affect the shape of a histogram. The Astropy docs have a great section on how to select these parameters:

<http://docs.astropy.org/en/stable/visualization/histogram.html>

```
"""

import numpy as np
import matplotlib.pyplot as plt
from matplotlib import mlab

np.random.seed(0)

mu = 200
sigma = 25
n_bins = 50
x = np.random.normal(mu, sigma, size=100)

fig, ax = plt.subplots(figsize=(8, 4))

# plot the cumulative histogram
n, bins, patches = ax.hist(x, n_bins, normed=1, histtype='step',
                           cumulative=True, label='Empirical')

# Add a line showing the expected distribution.
y = mlab.normpdf(bins, mu, sigma).cumsum()
y /= y[-1]

ax.plot(bins, y, 'k--', linewidth=1.5, label='Theoretical')

# Overlay a reversed cumulative histogram.
ax.hist(x, bins=bins, normed=1, histtype='step', cumulative=-1,
        label='Reversed emp.')
```

```
# tidy up the figure
ax.grid(True)
ax.legend(loc='right')
ax.set_title('Cumulative step histograms')
ax.set_xlabel('Annual rainfall (mm)')
ax.set_ylabel('Likelihood of occurrence')

plt.show()
```

Keywords: python, matplotlib, pylab, example, codex (see *Search examples*)

105.11 statistics example code: histogram_demo_features.py

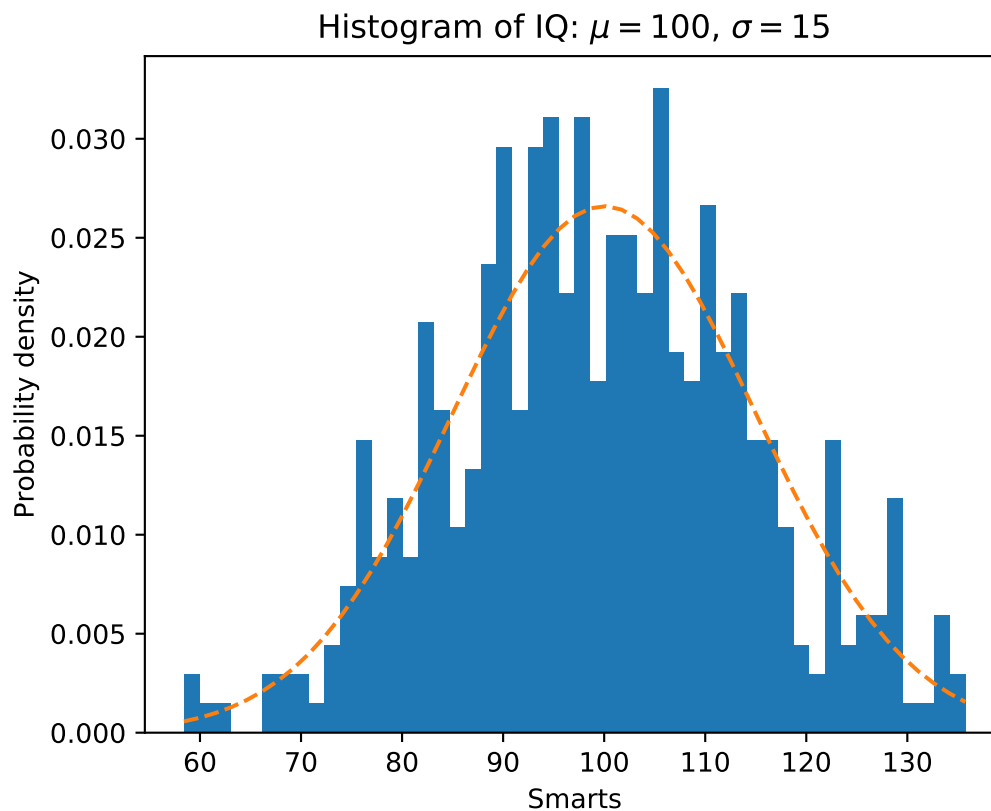

```

"""
=====
Demo of the histogram (hist) function with a few features
=====

In addition to the basic histogram, this demo shows a few optional
features:

* Setting the number of data bins
* The ``normed`` flag, which normalizes bin heights so that the
  integral of the histogram is 1. The resulting histogram is an
  approximation of the probability density function.
* Setting the face color of the bars
* Setting the opacity (alpha value).

Selecting different bin counts and sizes can significantly affect the
shape of a histogram. The Astropy docs have a great section on how to
select these parameters:
http://docs.astropy.org/en/stable/visualization/histogram.html
"""

import numpy as np

```

```
import matplotlib.mlab as mlab
import matplotlib.pyplot as plt

np.random.seed(0)

# example data
mu = 100 # mean of distribution
sigma = 15 # standard deviation of distribution
x = mu + sigma * np.random.randn(437)

num_bins = 50

fig, ax = plt.subplots()

# the histogram of the data
n, bins, patches = ax.hist(x, num_bins, normed=1)

# add a 'best fit' line
y = mlab.normpdf(bins, mu, sigma)
ax.plot(bins, y, '--')
ax.set_xlabel('Smarts')
ax.set_ylabel('Probability density')
ax.set_title(r'Histogram of IQ:  $\mu=100$ ,  $\sigma=15$ ')

# Tweak spacing to prevent clipping of ylabel
fig.tight_layout()
plt.show()
```

Keywords: python, matplotlib, pylab, example, codex (see [Search examples](#))

105.12 statistics example code: histogram_demo_histtypes.py

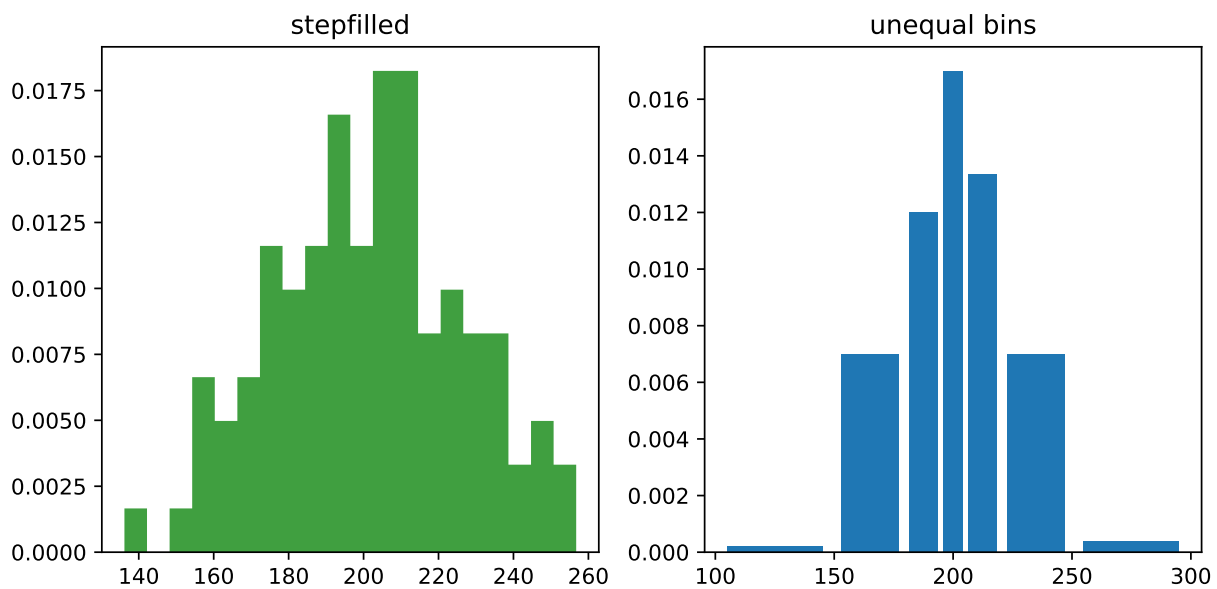

```

"""
=====
Demo of the histogram function's different ``histtype`` settings
=====

* Histogram with step curve that has a color fill.
* Histogram with custom and unequal bin widths.

Selecting different bin counts and sizes can significantly affect the
shape of a histogram. The Astropy docs have a great section on how to
select these parameters:
http://docs.astropy.org/en/stable/visualization/histogram.html
"""

import numpy as np
import matplotlib.pyplot as plt

np.random.seed(0)

mu = 200
sigma = 25
x = np.random.normal(mu, sigma, size=100)

fig, (ax0, ax1) = plt.subplots(ncols=2, figsize=(8, 4))

ax0.hist(x, 20, normed=1, histtype='stepfilled', facecolor='g', alpha=0.75)
ax0.set_title('stepfilled')

# Create a histogram by providing the bin edges (unequally spaced).
bins = [100, 150, 180, 195, 205, 220, 250, 300]

```

```
ax1.hist(x, bins, normed=1, histtype='bar', rwidth=0.8)
ax1.set_title('unequal bins')

fig.tight_layout()
plt.show()
```

Keywords: python, matplotlib, pylab, example, codex (see *Search examples*)

105.13 statistics example code: histogram_demo_multihist.py

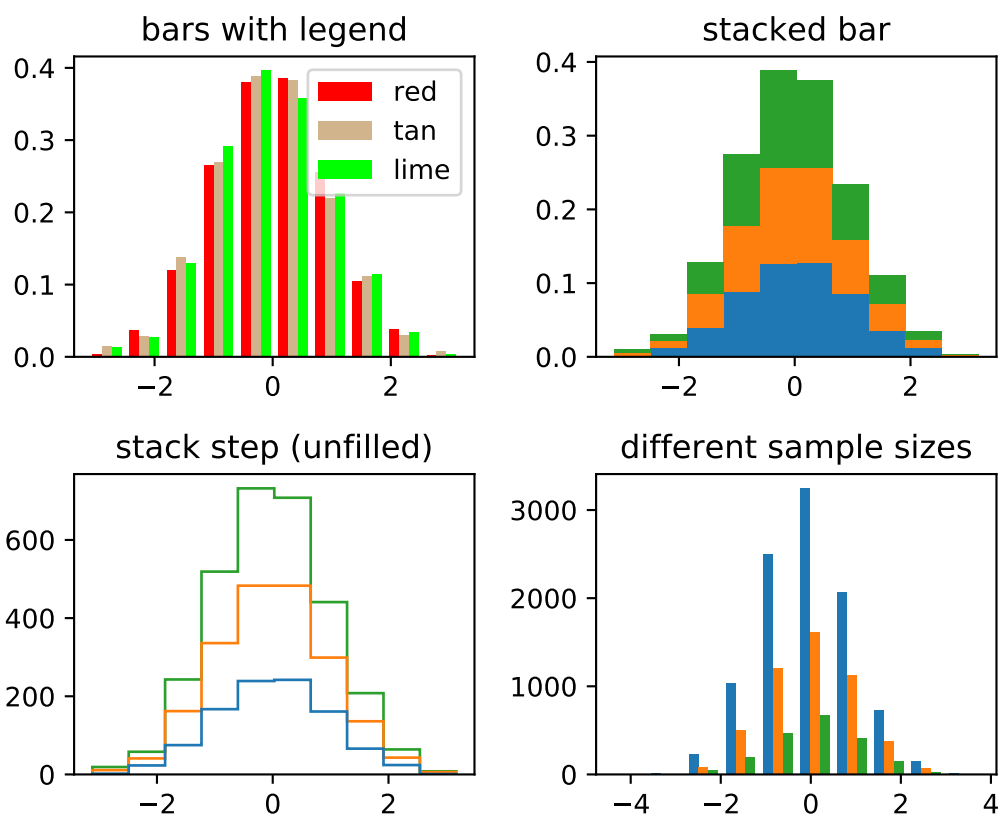

```
"""
=====
Demo of the histogram (hist) function with multiple data sets
=====

Plot histogram with multiple sample sets and demonstrate:

* Use of legend with multiple sample sets
* Stacked bars
* Step curve with no fill
* Data sets of different sample sizes
"""
```



```
Selecting different bin counts and sizes can significantly affect the
shape of a histogram. The Astropy docs have a great section on how to
select these parameters:
http://docs.astropy.org/en/stable/visualization/histogram.html
"""

import numpy as np
import matplotlib.pyplot as plt

np.random.seed(0)

n_bins = 10
x = np.random.randn(1000, 3)

fig, axes = plt.subplots(nrows=2, ncols=2)
ax0, ax1, ax2, ax3 = axes.flatten()

colors = ['red', 'tan', 'lime']
ax0.hist(x, n_bins, normed=1, histtype='bar', color=colors, label=colors)
ax0.legend(prop={'size': 10})
ax0.set_title('bars with legend')

ax1.hist(x, n_bins, normed=1, histtype='bar', stacked=True)
ax1.set_title('stacked bar')

ax2.hist(x, n_bins, histtype='step', stacked=True, fill=False)
ax2.set_title('stack step (unfilled)')

# Make a multiple-histogram of data-sets with different length.
x_multi = [np.random.randn(n) for n in [10000, 5000, 2000]]
ax3.hist(x_multi, n_bins, histtype='bar')
ax3.set_title('different sample sizes')

fig.tight_layout()
plt.show()
```

Keywords: python, matplotlib, pylab, example, codex (see *Search examples*)

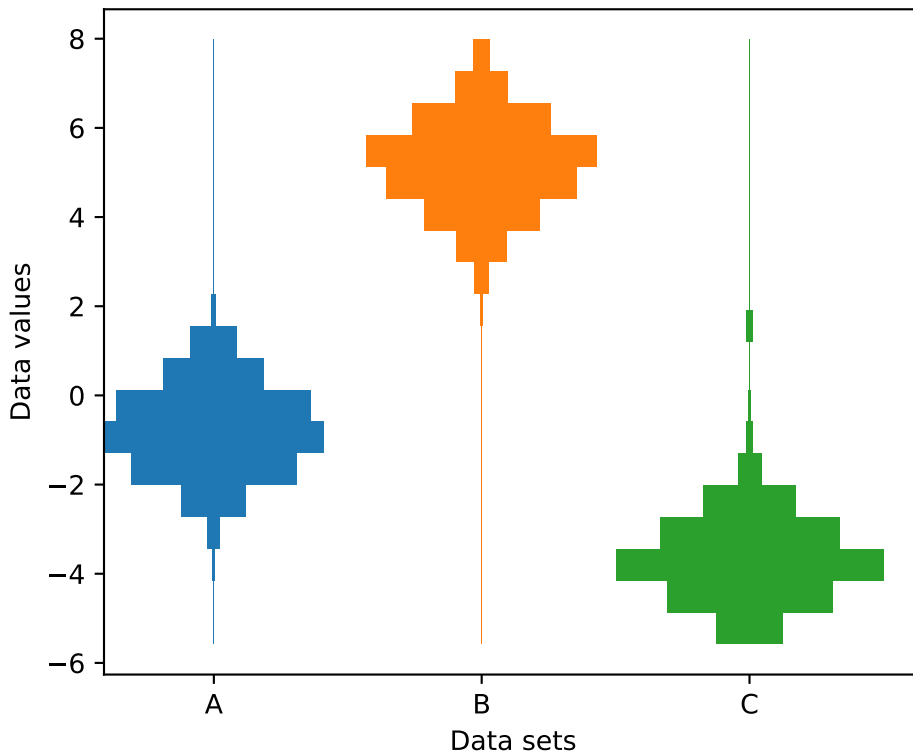
105.14 statistics example code: `multiple_histograms_side_by_side.py`

```

"""
=====
Demo of how to produce multiple histograms side by side
=====

This example plots horizontal histograms of different samples along
a categorical x-axis. Additionally, the histograms are plotted to
be symmetrical about their x-position, thus making them very similar
to violin plots.

To make this highly specialized plot, we can't use the standard ``hist``
method. Instead we use ``barh`` to draw the horizontal bars directly. The
vertical positions and lengths of the bars are computed via the
``np.histogram`` function. The histograms for all the samples are
computed using the same range (min and max values) and number of bins,
so that the bins for each sample are in the same vertical positions.

Selecting different bin counts and sizes can significantly affect the
shape of a histogram. The Astropy docs have a great section on how to
select these parameters:
http://docs.astropy.org/en/stable/visualization/histogram.html
"""

```

```
import numpy as np
import matplotlib.pyplot as plt

np.random.seed(0)
number_of_bins = 20

# An example of three data sets to compare
number_of_data_points = 387
labels = ["A", "B", "C"]
data_sets = [np.random.normal(0, 1, number_of_data_points),
             np.random.normal(6, 1, number_of_data_points),
             np.random.normal(-3, 1, number_of_data_points)]

# Computed quantities to aid plotting
hist_range = (np.min(data_sets), np.max(data_sets))
binned_data_sets = [
    np.histogram(d, range=hist_range, bins=number_of_bins)[0]
    for d in data_sets
]
binned_maximums = np.max(binned_data_sets, axis=1)
x_locations = np.arange(0, sum(binned_maximums), np.max(binned_maximums))

# The bin_edges are the same for all of the histograms
bin_edges = np.linspace(hist_range[0], hist_range[1], number_of_bins + 1)
centers = 0.5 * (bin_edges + np.roll(bin_edges, 1))[:-1]
heights = np.diff(bin_edges)

# Cycle through and plot each histogram
fig, ax = plt.subplots()
for x_loc, binned_data in zip(x_locations, binned_data_sets):
    lefts = x_loc - 0.5 * binned_data
    ax.barh(centers, binned_data, height=heights, left=lefts)

ax.set_xticks(x_locations)
ax.set_xticklabels(labels)

ax.set_ylabel("Data values")
ax.set_xlabel("Data sets")

plt.show()
```

Keywords: python, matplotlib, pylab, example, codex (see [Search examples](#))

105.15 statistics example code: violinplot_demo.py

Violin Plotting Examples

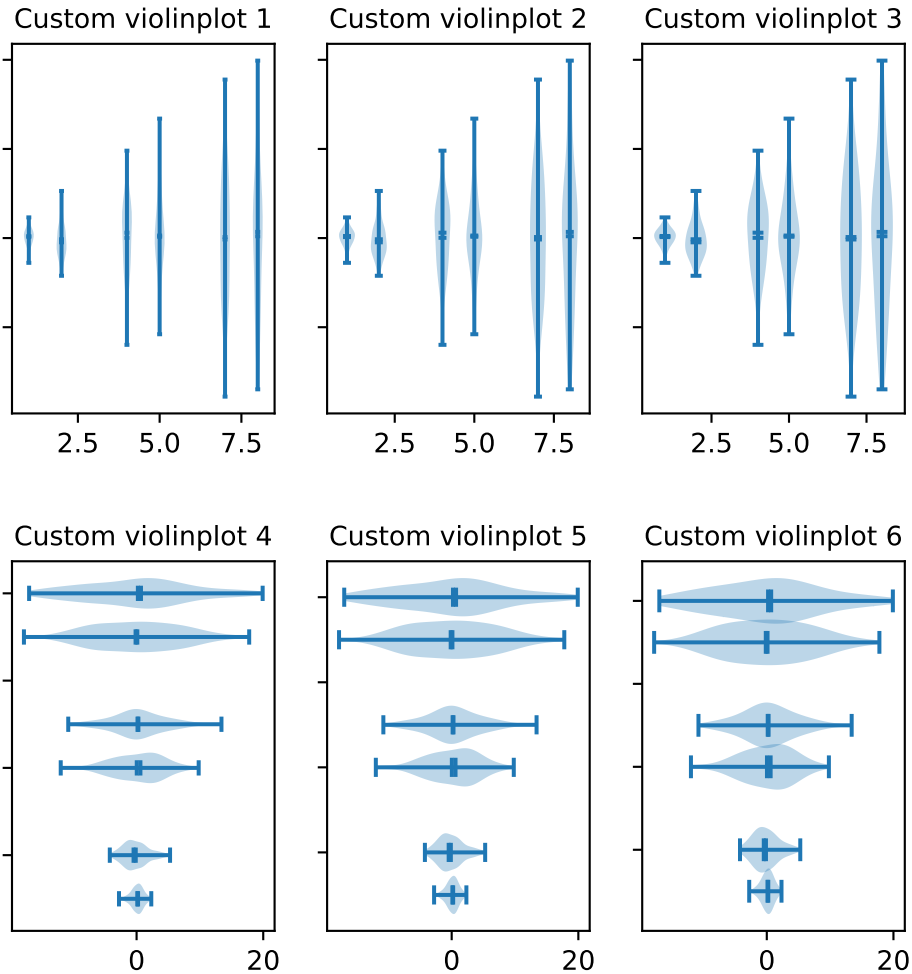

```

"""
=====
Demo of the basics of violin plots
=====

Violin plots are similar to histograms and box plots in that they show
an abstract representation of the probability distribution of the
sample. Rather than showing counts of data points that fall into bins
or order statistics, violin plots use kernel density estimation (KDE) to
compute an empirical distribution of the sample. That computation
is controlled by several parameters. This example demonstrates how to
modify the number of points at which the KDE is evaluated (`points`)
and how to modify the band-width of the KDE (`bw_method`).

```

```

For more information on violin plots and KDE, the scikit-learn docs
have a great section: http://scikit-learn.org/stable/modules/density.html
"""

import random
import numpy as np
import matplotlib.pyplot as plt

# fake data
fs = 10 # fontsize
pos = [1, 2, 4, 5, 7, 8]
data = [np.random.normal(0, std, size=100) for std in pos]

fig, axes = plt.subplots(nrows=2, ncols=3, figsize=(6, 6))

axes[0, 0].violinplot(data, pos, points=20, widths=0.3,
                      showmeans=True, showextrema=True, showmedians=True)
axes[0, 0].set_title('Custom violinplot 1', fontsize=fs)

axes[0, 1].violinplot(data, pos, points=40, widths=0.5,
                      showmeans=True, showextrema=True, showmedians=True,
                      bw_method='silverman')
axes[0, 1].set_title('Custom violinplot 2', fontsize=fs)

axes[0, 2].violinplot(data, pos, points=60, widths=0.7, showmeans=True,
                      showextrema=True, showmedians=True, bw_method=0.5)
axes[0, 2].set_title('Custom violinplot 3', fontsize=fs)

axes[1, 0].violinplot(data, pos, points=80, vert=False, widths=0.7,
                      showmeans=True, showextrema=True, showmedians=True)
axes[1, 0].set_title('Custom violinplot 4', fontsize=fs)

axes[1, 1].violinplot(data, pos, points=100, vert=False, widths=0.9,
                      showmeans=True, showextrema=True, showmedians=True,
                      bw_method='silverman')
axes[1, 1].set_title('Custom violinplot 5', fontsize=fs)

axes[1, 2].violinplot(data, pos, points=200, vert=False, widths=1.1,
                      showmeans=True, showextrema=True, showmedians=True,
                      bw_method=0.5)
axes[1, 2].set_title('Custom violinplot 6', fontsize=fs)

for ax in axes.flatten():
    ax.set_yticklabels([])

fig.suptitle("Violin Plotting Examples")
fig.subplots_adjust(hspace=0.4)
plt.show()

```

Keywords: python, matplotlib, pylab, example, codex (see [Search examples](#))

STYLE_SHEETS EXAMPLES

106.1 style_sheets example code: plot_bmh.py

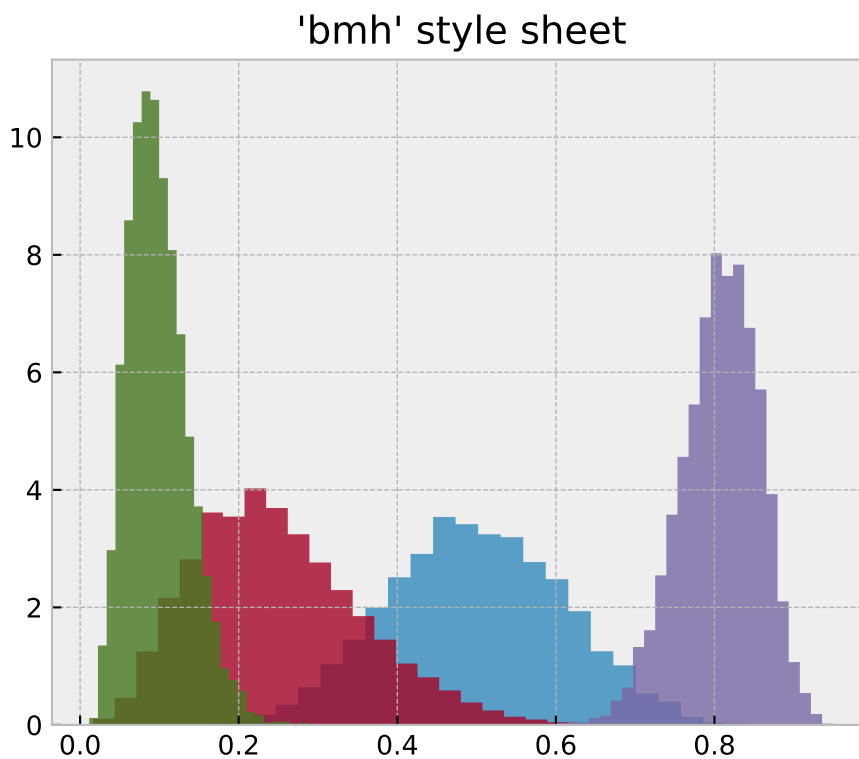

```
=====  
Bayesian Methods for Hackers style sheet  
=====  
  
This example demonstrates the style used in the Bayesian Methods for Hackers  
[1]_ online book.  
  
.. [1] http://camdavidsonpilon.github.io/Probabilistic-Programming-and-Bayesian-Methods-  
↪for-Hackers/
```

```
"""
from numpy.random import beta
import matplotlib.pyplot as plt

plt.style.use('bmh')

def plot_beta_hist(ax, a, b):
    ax.hist(beta(a, b, size=10000), histtype="stepfilled",
            bins=25, alpha=0.8, normed=True)

fig, ax = plt.subplots()
plot_beta_hist(ax, 10, 10)
plot_beta_hist(ax, 4, 12)
plot_beta_hist(ax, 50, 12)
plot_beta_hist(ax, 6, 55)
ax.set_title("'bmh' style sheet")

plt.show()
```

Keywords: python, matplotlib, pylab, example, codex (see [Search examples](#))

106.2 style_sheets example code: plot_dark_background.py

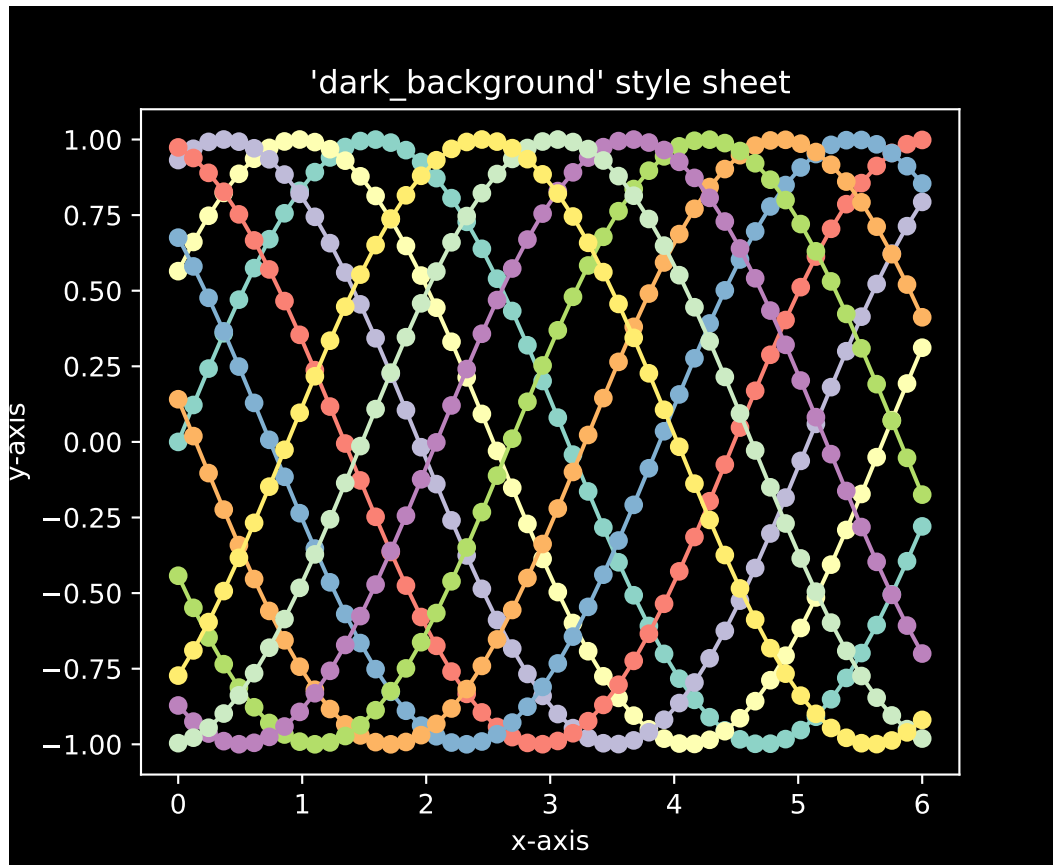

```

"""
=====
Dark background style sheet
=====

This example demonstrates the "dark_background" style, which uses white for
elements that are typically black (text, borders, etc). Note that not all plot
elements default to colors defined by an rc parameter.

"""
import numpy as np
import matplotlib.pyplot as plt

plt.style.use('dark_background')

fig, ax = plt.subplots()

L = 6
x = np.linspace(0, L)
ncolors = len(plt.rcParams['axes.prop_cycle'])
shift = np.linspace(0, L, ncolors, endpoint=False)

```

```

for s in shift:
    ax.plot(x, np.sin(x + s), 'o-')
ax.set_xlabel('x-axis')
ax.set_ylabel('y-axis')
ax.set_title("'dark_background' style sheet")

plt.show()

```

Keywords: python, matplotlib, pylab, example, codex (see [Search examples](#))

106.3 style_sheets example code: plot_fivethirtyeight.py

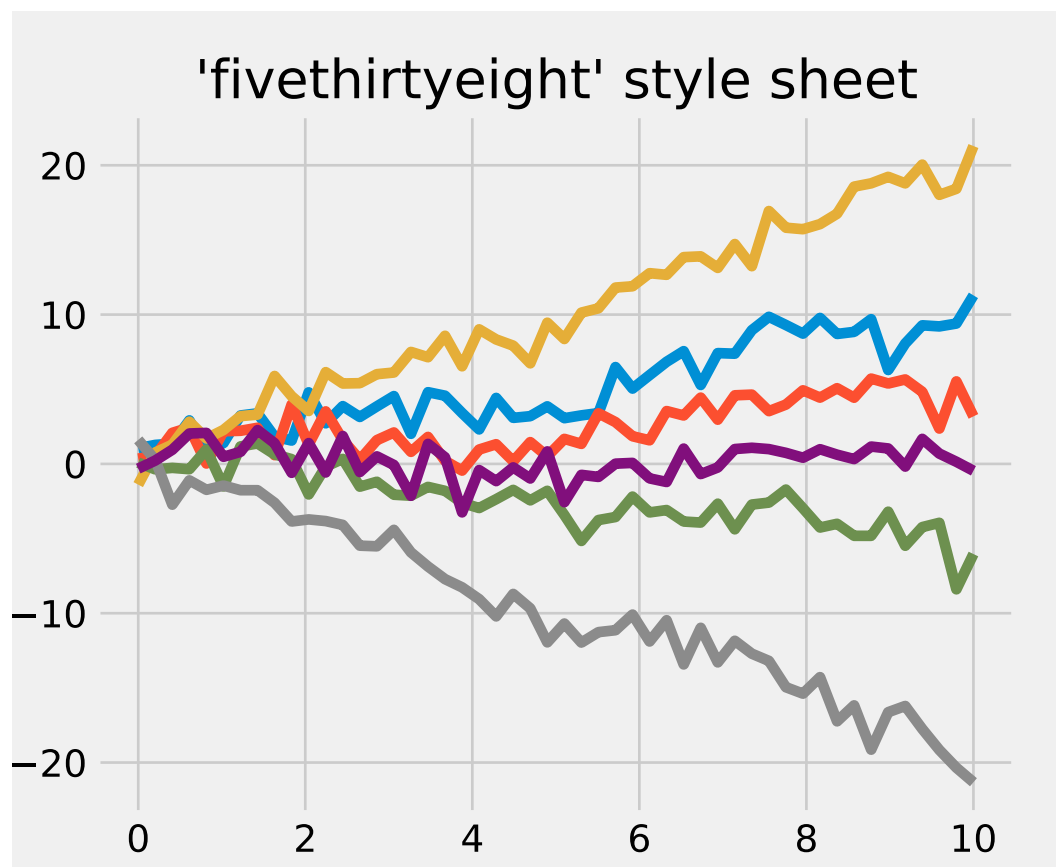

```

"""
=====
FiveThirtyEight style sheet
=====

This shows an example of the "fivethirtyeight" styling, which
tries to replicate the styles from FiveThirtyEight.com.
"""

from matplotlib import pyplot as plt

```

```
import numpy as np

plt.style.use('fivethirtyeight')

x = np.linspace(0, 10)

# Fixing random state for reproducibility
np.random.seed(19680801)

fig, ax = plt.subplots()

ax.plot(x, np.sin(x) + x + np.random.randn(50))
ax.plot(x, np.sin(x) + 0.5 * x + np.random.randn(50))
ax.plot(x, np.sin(x) + 2 * x + np.random.randn(50))
ax.plot(x, np.sin(x) - 0.5 * x + np.random.randn(50))
ax.plot(x, np.sin(x) - 2 * x + np.random.randn(50))
ax.plot(x, np.sin(x) + np.random.randn(50))
ax.set_title("'fivethirtyeight' style sheet")

plt.show()
```

Keywords: python, matplotlib, pylab, example, codex (see [Search examples](#))

106.4 style_sheets example code: plot_ggplot.py

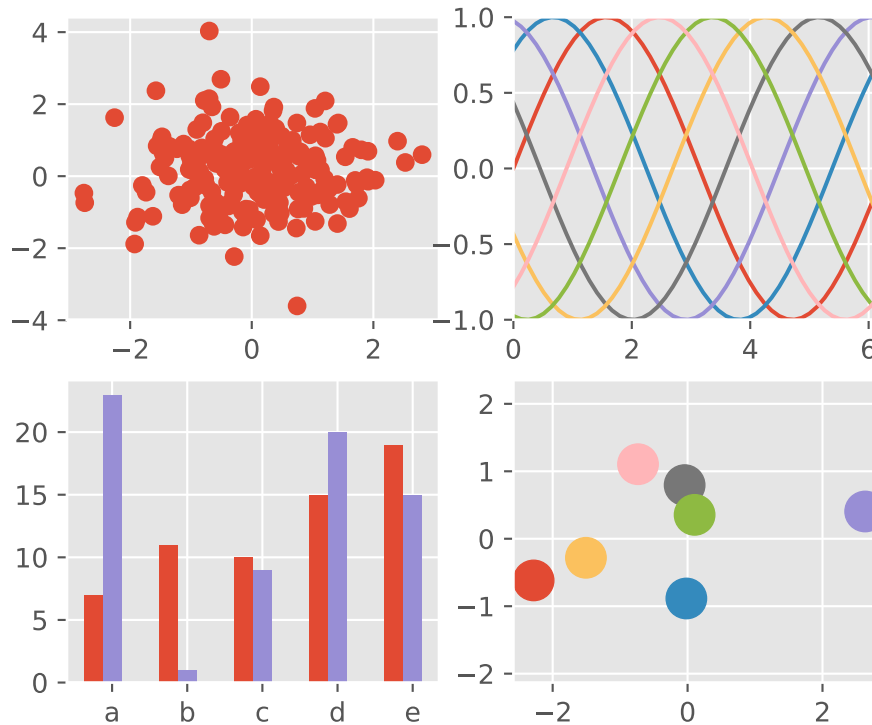

```

"""
=====
ggplot style sheet
=====

This example demonstrates the "ggplot" style, which adjusts the style to
emulate ggplot_ (a popular plotting package for R_).

These settings were shamelessly stolen from [1]_ (with permission).

.. [1] http://www.huynh.com/posts/sane-color-scheme-for-matplotlib/

.. _ggplot: http://ggplot2.org/
.. _R: https://www.r-project.org/

"""
import numpy as np
import matplotlib.pyplot as plt

plt.style.use('ggplot')

fig, axes = plt.subplots(ncols=2, nrows=2)

```

```
ax1, ax2, ax3, ax4 = axes.ravel()

# scatter plot (Note: `plt.scatter` doesn't use default colors)
x, y = np.random.normal(size=(2, 200))
ax1.plot(x, y, 'o')

# sinusoidal lines with colors from default color cycle
L = 2*np.pi
x = np.linspace(0, L)
ncolors = len(plt.rcParams['axes.prop_cycle'])
shift = np.linspace(0, L, ncolors, endpoint=False)
for s in shift:
    ax2.plot(x, np.sin(x + s), '-')
ax2.margins(0)

# bar graphs
x = np.arange(5)
y1, y2 = np.random.randint(1, 25, size=(2, 5))
width = 0.25
ax3.bar(x, y1, width)
ax3.bar(x + width, y2, width,
        color=list(plt.rcParams['axes.prop_cycle'])[2]['color'])
ax3.set_xticks(x + width)
ax3.set_xticklabels(['a', 'b', 'c', 'd', 'e'])

# circles with colors from default color cycle
for i, color in enumerate(plt.rcParams['axes.prop_cycle']):
    xy = np.random.normal(size=2)
    ax4.add_patch(plt.Circle(xy, radius=0.3, color=color['color']))
ax4.axis('equal')
ax4.margins(0)

plt.show()
```

Keywords: python, matplotlib, pylab, example, codex (see [Search examples](#))

106.5 style_sheets example code: plot_grayscale.py

'grayscale' style sheet

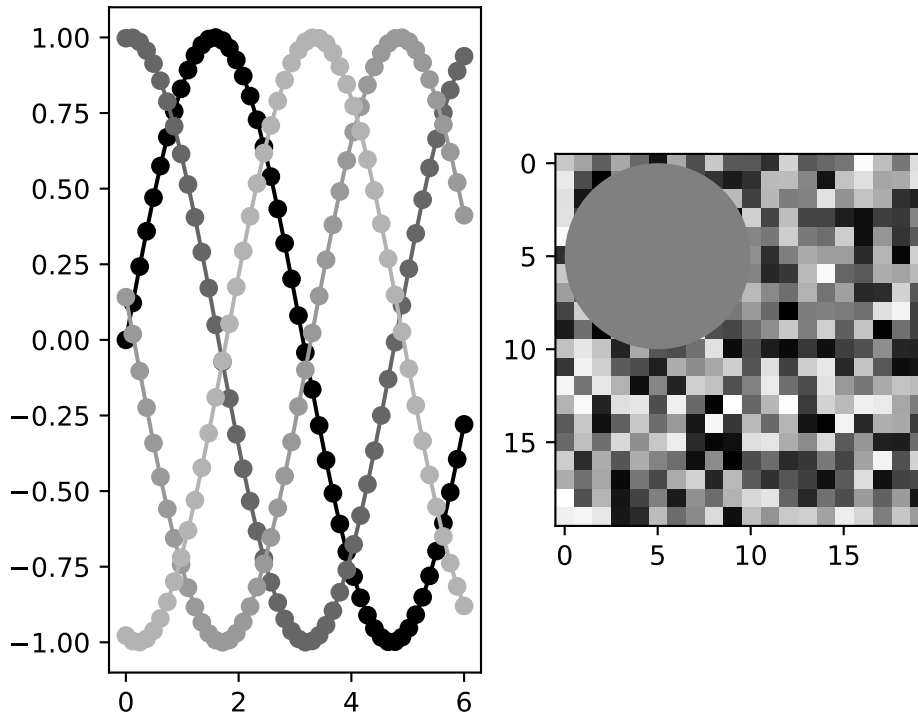

```

"""
=====
Grayscale style sheet
=====

This example demonstrates the "grayscale" style sheet, which changes all colors
that are defined as rc parameters to grayscale. Note, however, that not all
plot elements default to colors defined by an rc parameter.

"""
import numpy as np
import matplotlib.pyplot as plt

def color_cycle_example(ax):
    L = 6
    x = np.linspace(0, L)
    ncolors = len(plt.rcParams['axes.prop_cycle'])
    shift = np.linspace(0, L, ncolors, endpoint=False)
    for s in shift:
        ax.plot(x, np.sin(x + s), 'o-')

```

```

def image_and_patch_example(ax):
    ax.imshow(np.random.random(size=(20, 20)), interpolation='none')
    c = plt.Circle((5, 5), radius=5, label='patch')
    ax.add_patch(c)

plt.style.use('grayscale')

fig, (ax1, ax2) = plt.subplots(ncols=2)
fig.suptitle("'grayscale' style sheet")

color_cycle_example(ax1)
image_and_patch_example(ax2)

plt.show()

```

Keywords: python, matplotlib, pylab, example, codex (see [Search examples](#))

106.6 style_sheets example code: style_sheets_reference.py

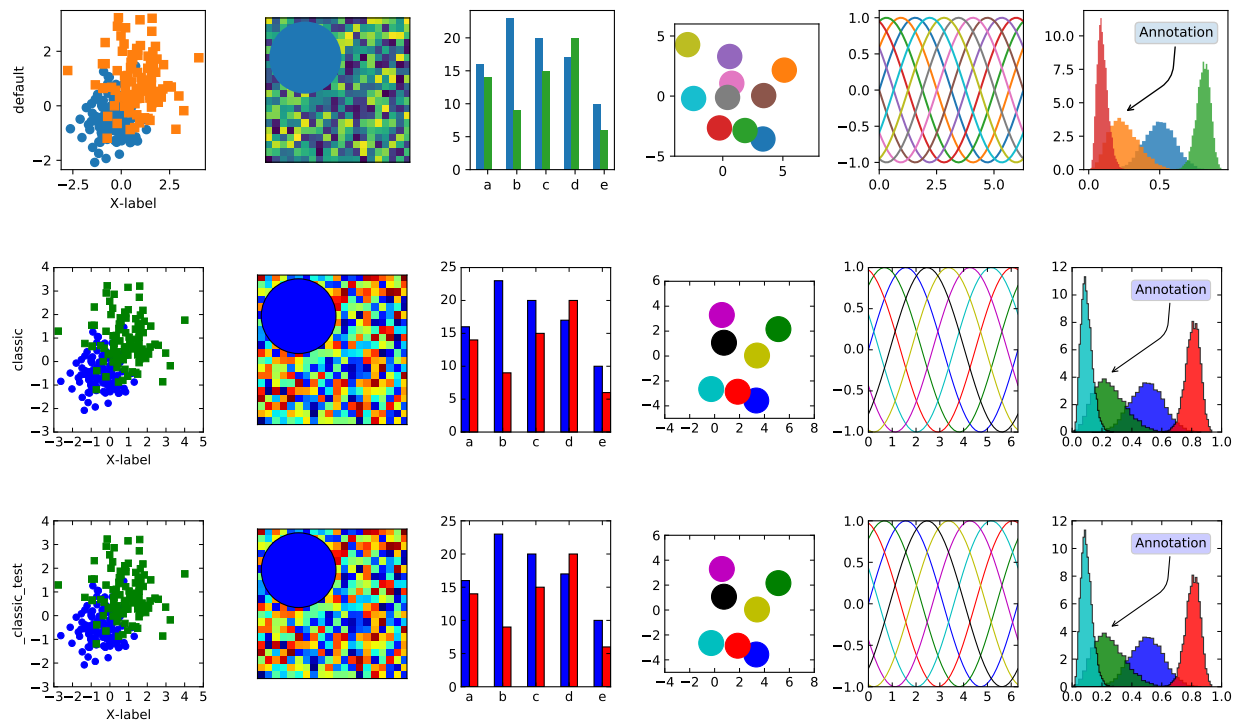

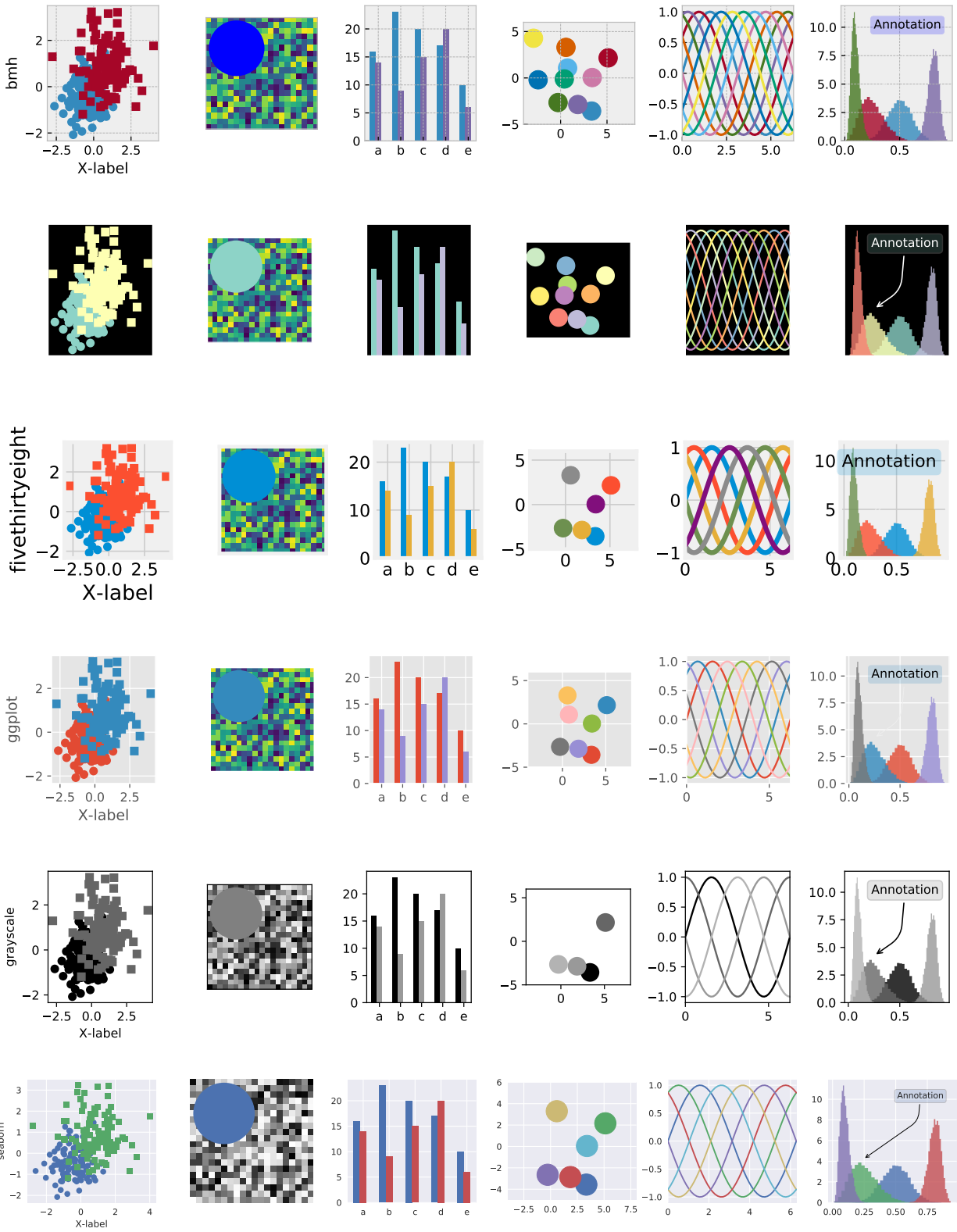

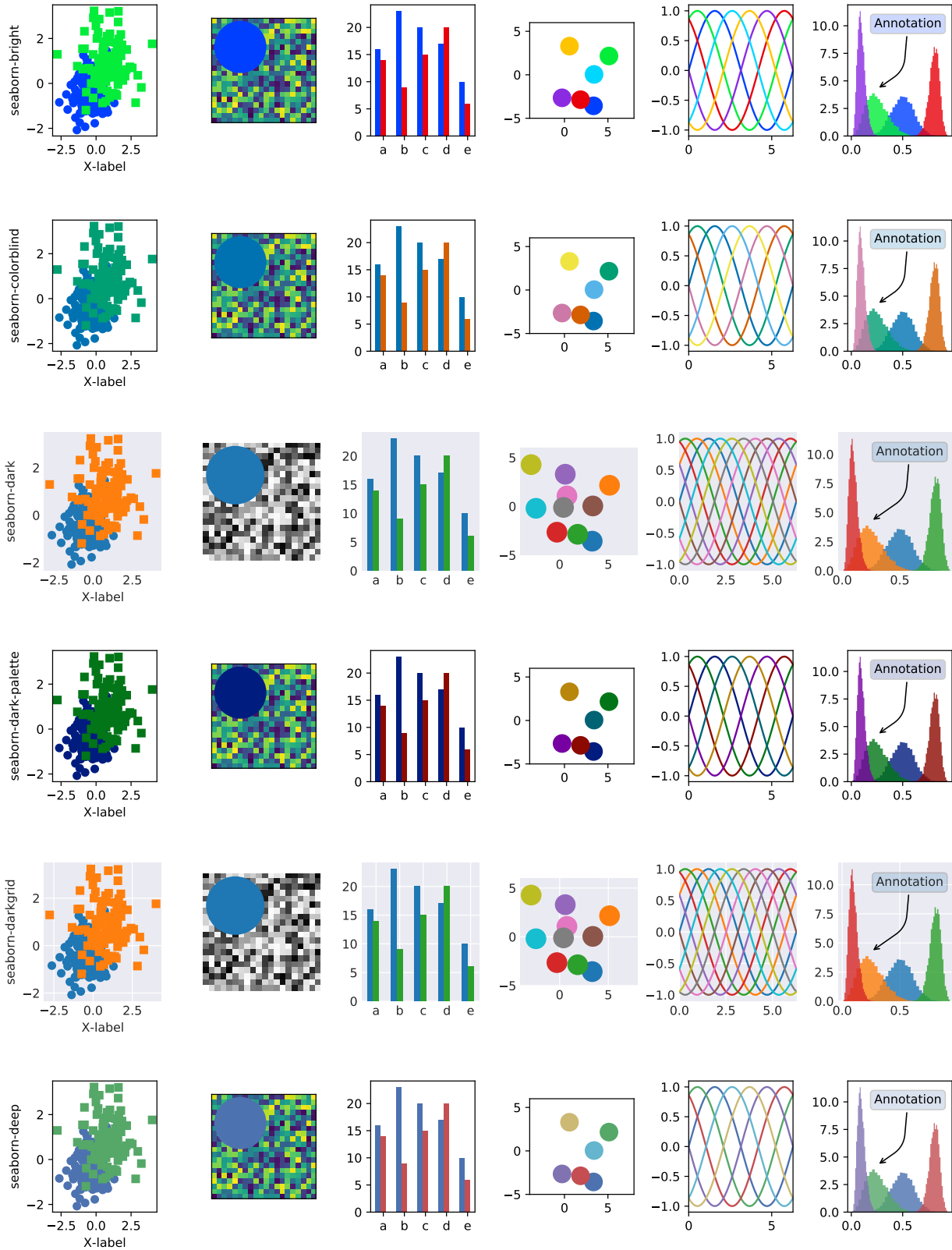

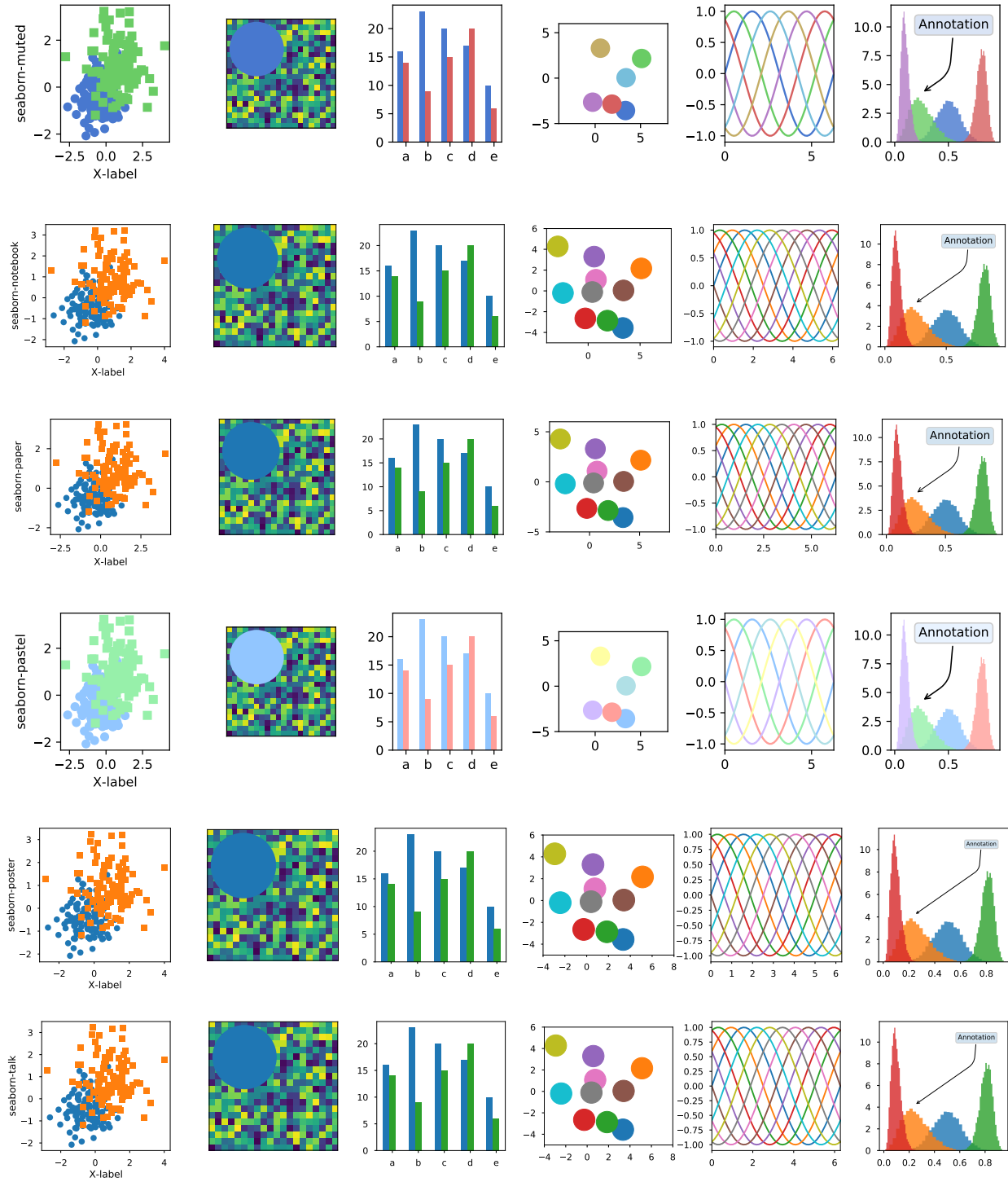

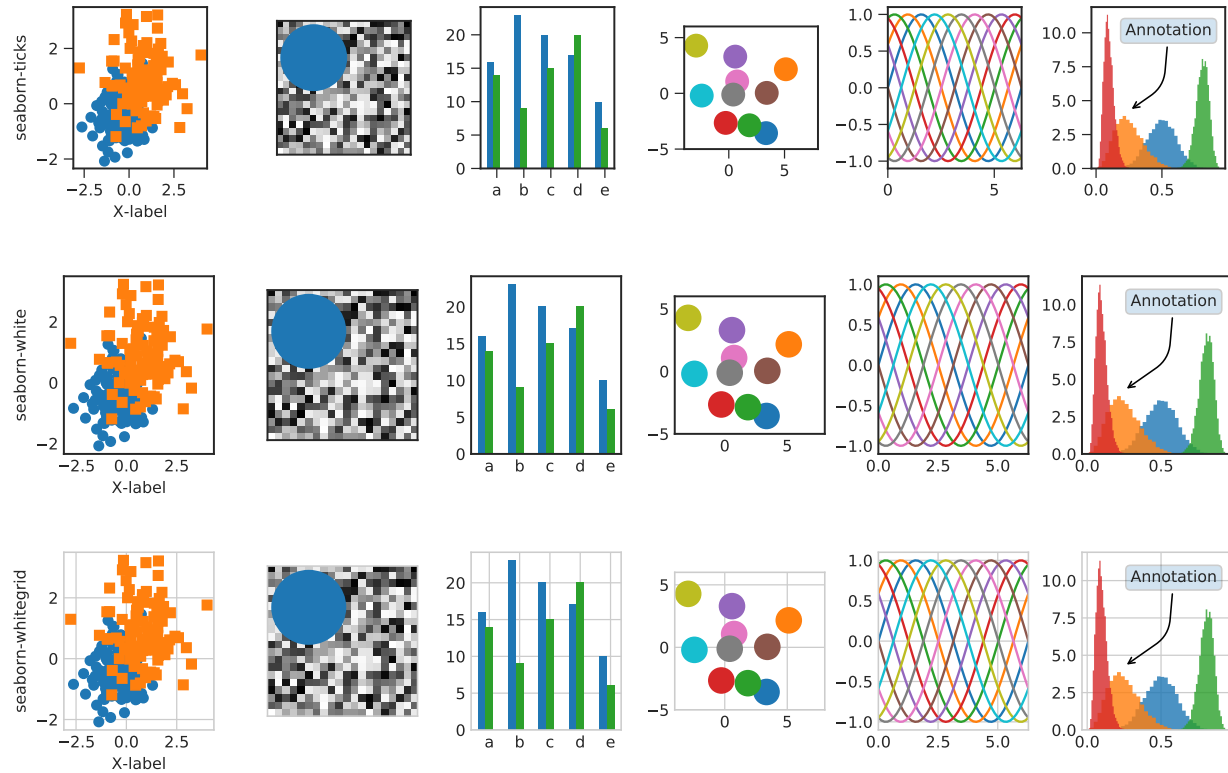

```
"""
```

```
=====
Style sheets reference
=====
```

```
This script demonstrates the different available style sheets on a
common set of example plots: scatter plot, image, bar graph, patches,
line plot and histogram,
```

```
"""
```

```
import numpy as np
import matplotlib.pyplot as plt
```

```
def plot_scatter(ax, prng, nb_samples=100):
    """Scatter plot.
    """
    for mu, sigma, marker in [(-.5, 0.75, 'o'), (0.75, 1., 's')]:
        x, y = prng.normal(loc=mu, scale=sigma, size=(2, nb_samples))
        ax.plot(x, y, ls='none', marker=marker)
    ax.set_xlabel('X-label')
    return ax

def plot_colored_sinusoidal_lines(ax):
    """Plot sinusoidal lines with colors following the style color cycle.
```

```

"""
L = 2 * np.pi
x = np.linspace(0, L)
nb_colors = len(plt.rcParams['axes.prop_cycle'])
shift = np.linspace(0, L, nb_colors, endpoint=False)
for s in shift:
    ax.plot(x, np.sin(x + s), '-')
ax.set_xlim([x[0], x[-1]])
return ax

def plot_bar_graphs(ax, prng, min_value=5, max_value=25, nb_samples=5):
    """Plot two bar graphs side by side, with letters as x-tick labels.
    """
    x = np.arange(nb_samples)
    ya, yb = prng.randint(min_value, max_value, size=(2, nb_samples))
    width = 0.25
    ax.bar(x, ya, width)
    ax.bar(x + width, yb, width, color='C2')
    ax.set_xticks(x + width)
    ax.set_xticklabels(['a', 'b', 'c', 'd', 'e'])
    return ax

def plot_colored_circles(ax, prng, nb_samples=15):
    """Plot circle patches.

    NB: draws a fixed amount of samples, rather than using the length of
    the color cycle, because different styles may have different numbers
    of colors.
    """
    for sty_dict, j in zip(plt.rcParams['axes.prop_cycle'], range(nb_samples)):
        ax.add_patch(plt.Circle(prng.normal(scale=3, size=2),
                                radius=1.0, color=sty_dict['color']))
    # Force the limits to be the same across the styles (because different
    # styles may have different numbers of available colors).
    ax.set_xlim([-4, 8])
    ax.set_ylim([-5, 6])
    ax.set_aspect('equal', adjustable='box') # to plot circles as circles
    return ax

def plot_image_and_patch(ax, prng, size=(20, 20)):
    """Plot an image with random values and superimpose a circular patch.
    """
    values = prng.random_sample(size=size)
    ax.imshow(values, interpolation='none')
    c = plt.Circle((5, 5), radius=5, label='patch')
    ax.add_patch(c)
    # Remove ticks
    ax.set_xticks([])
    ax.set_yticks([])

```

```

def plot_histograms(ax, prng, nb_samples=10000):
    """Plot 4 histograms and a text annotation.
    """
    params = ((10, 10), (4, 12), (50, 12), (6, 55))
    for a, b in params:
        values = prng.beta(a, b, size=nb_samples)
        ax.hist(values, histtype="stepfilled", bins=30, alpha=0.8, normed=True)
    # Add a small annotation.
    ax.annotate('Annotation', xy=(0.25, 4.25), xycoords='data',
                xytext=(0.9, 0.9), textcoords='axes fraction',
                va="top", ha="right",
                bbox=dict(boxstyle="round", alpha=0.2),
                arrowprops=dict(
                    arrowstyle="->",
                    connectionstyle="angle,angleA=-95,angleB=35,rad=10"),
                )
    return ax

def plot_figure(style_label=""):
    """Setup and plot the demonstration figure with a given style.
    """
    # Use a dedicated RandomState instance to draw the same "random" values
    # across the different figures.
    prng = np.random.RandomState(96917002)

    # Tweak the figure size to be better suited for a row of numerous plots:
    # double the width and halve the height. NB: use relative changes because
    # some styles may have a figure size different from the default one.
    (fig_width, fig_height) = plt.rcParams['figure.figsize']
    fig_size = [fig_width * 2, fig_height / 2]

    fig, axes = plt.subplots(ncols=6, nrows=1, num=style_label,
                             figsize=fig_size, squeeze=True)
    axes[0].set_ylabel(style_label)

    plot_scatter(axes[0], prng)
    plot_image_and_patch(axes[1], prng)
    plot_bar_graphs(axes[2], prng)
    plot_colored_circles(axes[3], prng)
    plot_colored_sinusoidal_lines(axes[4])
    plot_histograms(axes[5], prng)

    fig.tight_layout()

    return fig

if __name__ == "__main__":
    # Setup a list of all available styles, in alphabetical order but
    # the `default` and `classic` ones, which will be forced resp. in

```

```
# first and second position.
style_list = list(plt.style.available) # *new* list: avoids side effects.
style_list.remove('classic') # `classic` is in the list: first remove it.
style_list.sort()
style_list.insert(0, u'default')
style_list.insert(1, u'classic')

# Plot a demonstration figure for every available style sheet.
for style_label in style_list:
    with plt.style.context(style_label):
        fig = plot_figure(style_label=style_label)

plt.show()
```

Keywords: python, matplotlib, pylab, example, codex (see *Search examples*)

SUBPLOTS_AXES_AND_FIGURES EXAMPLES

107.1 subplots_axes_and_figures example code: fahrenheit_celsius_scales.py

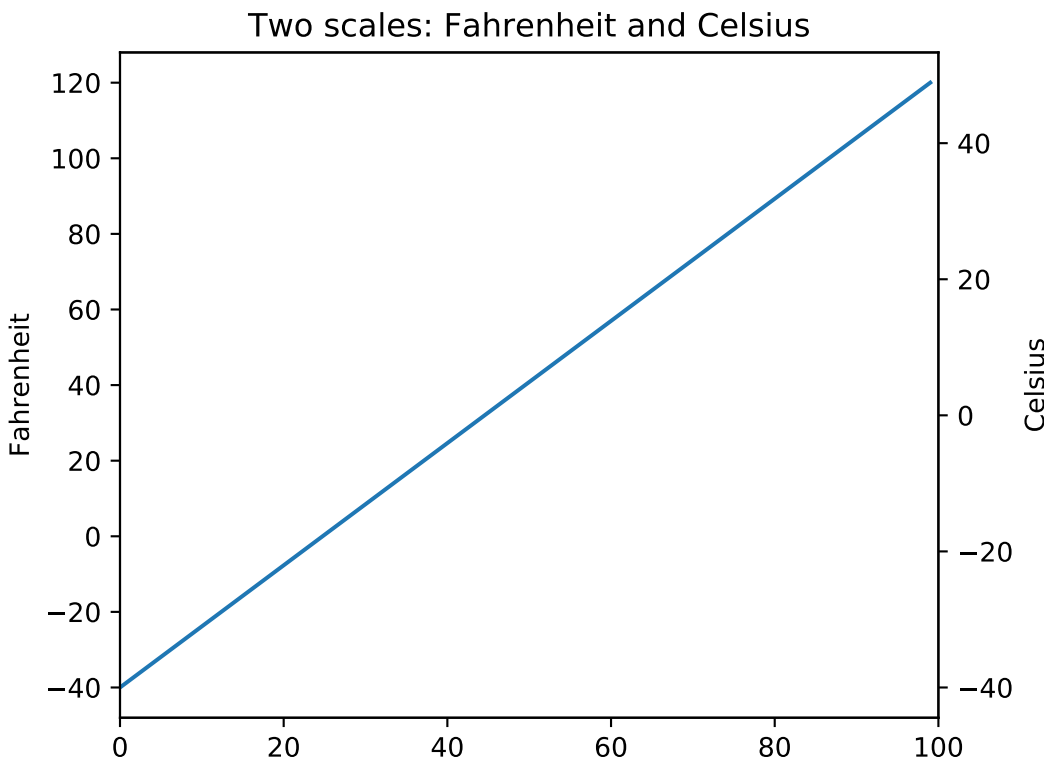

```
"""  
Demo of how to display two scales on the left and right y axis.  
  
This example uses the Fahrenheit and Celsius scales.  
"""  
import matplotlib.pyplot as plt  
import numpy as np
```

```
def fahrenheit2celsius(temp):
    """
    Returns temperature in Celsius.
    """
    return (5. / 9.) * (temp - 32)

def convert_ax_c_to_celsius(ax_f):
    """
    Update second axis according with first axis.
    """
    y1, y2 = ax_f.get_ylim()
    ax_c.set_ylim(fahrenheit2celsius(y1), fahrenheit2celsius(y2))
    ax_c.figure.canvas.draw()

fig, ax_f = plt.subplots()
ax_c = ax_f.twinx()

# automatically update ylim of ax2 when ylim of ax1 changes.
ax_f.callbacks.connect("ylim_changed", convert_ax_c_to_celsius)
ax_f.plot(np.linspace(-40, 120, 100))
ax_f.set_xlim(0, 100)

ax_f.set_title('Two scales: Fahrenheit and Celsius')
ax_f.set_ylabel('Fahrenheit')
ax_c.set_ylabel('Celsius')

plt.show()
```

Keywords: python, matplotlib, pylab, example, codex (see [Search examples](#))

107.2 subplots_axes_and_figures example code: subplot_demo.py

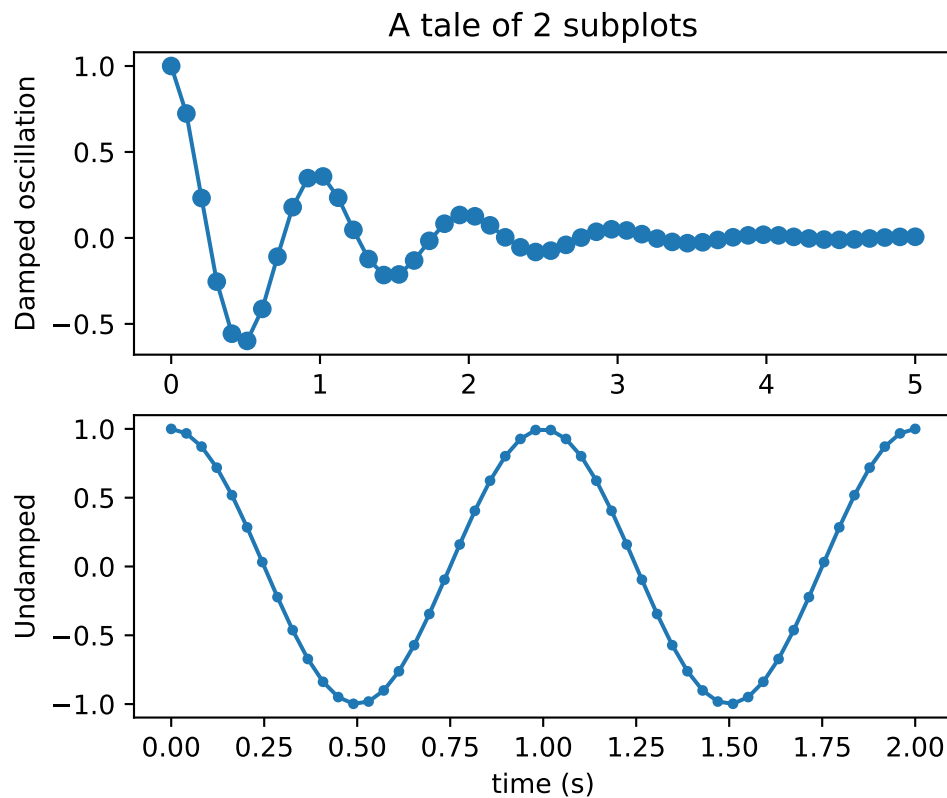

```

"""
Simple demo with multiple subplots.
"""
import numpy as np
import matplotlib.pyplot as plt

x1 = np.linspace(0.0, 5.0)
x2 = np.linspace(0.0, 2.0)

y1 = np.cos(2 * np.pi * x1) * np.exp(-x1)
y2 = np.cos(2 * np.pi * x2)

plt.subplot(2, 1, 1)
plt.plot(x1, y1, 'o-')
plt.title('A tale of 2 subplots')
plt.ylabel('Damped oscillation')

plt.subplot(2, 1, 2)
plt.plot(x2, y2, '-.')
plt.xlabel('time (s)')
plt.ylabel('Undamped')

```

```
plt.show()
```

Keywords: python, matplotlib, pylab, example, codex (see [Search examples](#))

TESTS EXAMPLES

108.1 tests example code: backend_driver.py

[source code]

```
"""
This is used to drive many of the examples across the backends, for
regression testing, and comparing backend efficiency.

You can specify the backends to be tested either via the --backends
switch, which takes a comma-separated list, or as separate arguments,
e.g.

    python backend_driver.py agg ps

would test the agg and ps backends. If no arguments are given, a
default list of backends will be tested.

Interspersed with the backend arguments can be switches for the Python
interpreter executing the tests. If entering such arguments causes an
option parsing error with the driver script, separate them from driver
switches with a --.
"""

from __future__ import print_function, division
import os
import time
import sys
import glob
from optparse import OptionParser

import matplotlib.rcsetup as rcsetup
from matplotlib.cbook import Bunch, dedent

all_backends = list(rcsetup.all_backends) # to leave the original list alone

# actual physical directory for each dir
dirs = dict(files=os.path.join '..', 'lines_bars_and_markers'),
            shapes=os.path.join '..', 'shapes_and_collections'),
```

```
images=os.path.join('.', 'images_contours_and_fields'),
pie=os.path.join('.', 'pie_and_polar_charts'),
text=os.path.join('.', 'text_labels_and_annotations'),
ticks=os.path.join('.', 'ticks_and_spines'),
subplots=os.path.join('.', 'subplots_axes_and_figures'),
specialty=os.path.join('.', 'specialty_plots'),
showcase=os.path.join('.', 'showcase'),
pylab=os.path.join('.', 'pylab_examples'),
api=os.path.join('.', 'api'),
units=os.path.join('.', 'units'),
mplot3d=os.path.join('.', 'mplot3d'),
colors=os.path.join('.', 'color'))

# files in each dir
files = dict()

files['lines'] = [
    'barh_demo.py',
    'fill_demo.py',
    'fill_demo_features.py',
    'line_demo_dash_control.py',
    'line_styles_reference.py',
    'scatter_with_legend.py'
]

files['shapes'] = [
    'path_patch_demo.py',
    'scatter_demo.py',
]

files['colors'] = [
    'color_cycle_default.py',
    'color_cycle_demo.py',
]

files['images'] = [
    'image_demo.py',
    'contourf_log.py',
]

files['statistics'] = [
    'errorbar_demo.py',
    'errorbar_demo_features.py',
    'histogram_demo_cumulative.py',
    'histogram_demo_features.py',
    'histogram_demo_histtypes.py',
    'histogram_demo_multihist.py',
]

files['pie'] = [
    'pie_demo.py',
    'polar_bar_demo.py',
]
```

```
'polar_scatter_demo.py',
]

files['text_labels_and_annotations'] = [
    'text_demo_fontdict.py',
    'unicode_demo.py',
]

files['ticks_and_spines'] = [
    'spines_demo_bounds.py',
    'ticklabels_demo_rotation.py',
]

files['subplots_axes_and_figures'] = [
    'subplot_demo.py',
]

files['showcase'] = [
    'integral_demo.py',
]

files['pylab'] = [
    'accented_text.py',
    'alignment_test.py',
    'annotation_demo.py',
    'annotation_demo.py',
    'annotation_demo2.py',
    'annotation_demo2.py',
    'anscombe.py',
    'arctest.py',
    'arrow_demo.py',
    'axes_demo.py',
    'axes_props.py',
    'axhspan_demo.py',
    'axis_equal_demo.py',
    'bar_stacked.py',
    'barb_demo.py',
    'barchart_demo.py',
    'barcode_demo.py',
    'boxplot_demo.py',
    'broken_barh.py',
    'cohere_demo.py',
    'color_by_yvalue.py',
    'color_demo.py',
    'colorbar_tick_labelling_demo.py',
    'contour_demo.py',
    'contour_image.py',
    'contour_label_demo.py',
    'contourf_demo.py',
    'coords_demo.py',
    'coords_report.py',
    'csd_demo.py',
    'cursor_demo.py',
```

```
'custom_cmap.py',
'custom_figure_class.py',
'custom_ticker1.py',
'customize_rc.py',
'dashpointlabel.py',
'date_demo_convert.py',
'date_demo_rrule.py',
'date_index_formatter.py',
'dolphin.py',
'ellipse_collection.py',
'ellipse_demo.py',
'ellipse_rotated.py',
'equal_aspect_ratio.py',
'errorbar_limits.py',
'fancyarrow_demo.py',
'fancybox_demo.py',
'fancybox_demo2.py',
'fancytextbox_demo.py',
'figimage_demo.py',
'figlegend_demo.py',
'figure_title.py',
'fill_between_demo.py',
'fill_spiral.py',
'findobj_demo.py',
'fonts_demo.py',
'fonts_demo_kw.py',
'ganged_plots.py',
'geo_demo.py',
'gradient_bar.py',
'griddata_demo.py',
'hatch_demo.py',
'hexbin_demo.py',
'hexbin_demo2.py',
'hist_colormapped.py',
'vline_hline_demo.py',

'image_clip_path.py',
'image_demo.py',
'image_demo2.py',
'image_interp.py',
'image_masked.py',
'image_nonuniform.py',
'image_origin.py',
'image_slices_viewer.py',
'interp_demo.py',
'invert_axes.py',
'layer_images.py',
'legend_demo2.py',
'legend_demo3.py',
'line_collection.py',
'line_collection2.py',
'log_bar.py',
'log_demo.py',
```

```
'log_test.py',
'major_minor_demo1.py',
'major_minor_demo2.py',
'manual_axis.py',
'masked_demo.py',
'mathtext_demo.py',
'mathtext_examples.py',
'matshow.py',
'mri_demo.py',
'mri_with_eeg.py',
'multi_image.py',
'multiline.py',
'multiple_figs_demo.py',
'nan_test.py',
'newscalarformatter_demo.py',
'pcolor_demo.py',
'pcolor_log.py',
'pcolor_small.py',
'pie_demo2.py',
'plotfile_demo.py',
'polar_demo.py',
'polar_legend.py',
'psd_demo.py',
'psd_demo2.py',
'psd_demo3.py',
'quadmesh_demo.py',
'quiver_demo.py',
'scatter_custom_symbol.py',
'scatter_demo2.py',
'scatter_masked.py',
'scatter_profile.py',
'scatter_star_poly.py',
# 'set_and_get.py',
'shared_axis_across_figures.py',
'shared_axis_demo.py',
'simple_plot.py',
'specgram_demo.py',
'spine_placement_demo.py',
'spy_demos.py',
'stem_plot.py',
'step_demo.py',
'stix_fonts_demo.py',
'subplots_adjust.py',
'symlog_demo.py',
'table_demo.py',
'text_handles.py',
'text_rotation.py',
'text_rotation_relative_to_line.py',
'transoffset.py',
'xcorr_demo.py',
'zorder_demo.py',
]
```

```
files['api'] = [
    'agg_oo.py',
    'barchart_demo.py',
    'bbox_intersect.py',
    'collections_demo.py',
    'colorbar_only.py',
    'custom_projection_example.py',
    'custom_scale_example.py',
    'date_demo.py',
    'date_index_formatter.py',
    'donut_demo.py',
    'font_family_rc.py',
    'image_zcoord.py',
    'joinstyle.py',
    'legend_demo.py',
    'line_with_text.py',
    'logo2.py',
    'mathtext_asarray.py',
    'patch_collection.py',
    'quad_bezier.py',
    'scatter_piecharts.py',
    'span_regions.py',
    'two_scales.py',
    'unicode_minus.py',
    'watermark_image.py',
    'watermark_text.py',
]

files['units'] = [
    'annotate_with_units.py',
    '#artist_tests.py', # broken, fixme
    'bar_demo2.py',
    '#bar_unit_demo.py', # broken, fixme
    '#ellipse_with_units.py', # broken, fixme
    'radian_demo.py',
    'units_sample.py',
    '#units_scatter.py', # broken, fixme
]

files['mplot3d'] = [
    '2dcollections3d_demo.py',
    'bars3d_demo.py',
    'contour3d_demo.py',
    'contour3d_demo2.py',
    'contourf3d_demo.py',
    'lines3d_demo.py',
    'polys3d_demo.py',
    'scatter3d_demo.py',
    'surface3d_demo.py',
    'surface3d_demo2.py',
    'text3d_demo.py',
]
```



```

'wire3d_demo.py',
]

# dict from dir to files we know we don't want to test (e.g., examples
# not using pyplot, examples requiring user input, animation examples,
# examples that may only work in certain environs (usetex examples?),
# examples that generate multiple figures

excluded = {
    'pylab': ['__init__.py', 'toggle_images.py', ],
    'units': ['__init__.py', 'date_support.py', ],
}

def report_missing(dir, flist):
    'report the py files in dir that are not in flist'
    globstr = os.path.join(dir, '*.py')
    fnames = glob.glob(globstr)

    pyfiles = set([os.path.split(fullpath)[-1] for fullpath in set(fnames)])

    exclude = set(excluded.get(dir, []))
    flist = set(flist)
    missing = list(pyfiles - flist - exclude)
    missing.sort()
    if missing:
        print('%s files not tested: %s' % (dir, ', '.join(missing)))

def report_all_missing(directories):
    for f in directories:
        report_missing(dirs[f], files[f])

# tests known to fail on a given backend

failbackend = dict(
    svg=('tex_demo.py', ),
    agg=('hyperlinks.py', ),
    pdf=('hyperlinks.py', ),
    ps=('hyperlinks.py', ),
)

try:
    import subprocess

    def run(arglist):
        try:
            ret = subprocess.call(arglist)
        except KeyboardInterrupt:
            sys.exit()
        else:

```

```

        return ret
except ImportError:
    def run(arglist):
        os.system(' '.join(arglist))

def drive(backend, directories, python=['python'], switches=[]):
    exclude = failbackend.get(backend, [])

    # Clear the destination directory for the examples
    path = backend
    if os.path.exists(path):
        import glob
        for fname in os.listdir(path):
            os.unlink(os.path.join(path, fname))
    else:
        os.mkdir(backend)
    failures = []

    testcases = [os.path.join(dirs[d], fname)
                  for d in directories
                  for fname in files[d]]

    for fullpath in testcases:
        print('\tdriving %-40s' % (fullpath))
        sys.stdout.flush()
        fpath, fname = os.path.split(fullpath)

        if fname in exclude:
            print('\tSkipping %s, known to fail on backend: %s' % backend)
            continue

        basename, ext = os.path.splitext(fname)
        outfile = os.path.join(path, basename)
        tmpfile_name = '_tmp_%s.py' % basename
        tmpfile = open(tmpfile_name, 'w')

        future_imports = 'from __future__ import division, print_function'
        for line in open(fullpath):
            line_lstrip = line.lstrip()
            if line_lstrip.startswith("#"):
                tmpfile.write(line)
            elif 'unicode_literals' in line:
                future_imports = future_imports + ', unicode_literals'

        tmpfile.writelines((
            future_imports + '\n',
            'import sys\n',
            'sys.path.append("%s")\n' % fpath.replace('\\', '\\\\'),
            'import matplotlib\n',
            'matplotlib.use("%s")\n' % backend,
            'from pylab import savefig\n',
            'import numpy\n',

```

```

        'numpy.seterr(invalid="ignore")\n',
    ))
    for line in open(fullpath):
        line_lstrip = line.lstrip()
        if (line_lstrip.startswith('from __future__ import') or
            line_lstrip.startswith('matplotlib.use') or
            line_lstrip.startswith('savefig') or
            line_lstrip.startswith('show')):
            continue
        tmpfile.write(line)
    if backend in rcsetup.interactive_bk:
        tmpfile.write('show()')
    else:
        tmpfile.write('\nsavefig(r"%s", dpi=150)' % outfile)

    tmpfile.close()
    start_time = time.time()
    program = [x % {'name': basename} for x in python]
    ret = run(program + [tmpfile_name] + switches)
    end_time = time.time()
    print("%s %s" % ((end_time - start_time), ret))
    #os.system('%s %s %s' % (python, tmpfile_name, '.join(switches)))
    os.remove(tmpfile_name)
    if ret:
        failures.append(fullpath)
    return failures

def parse_options():
    doc = (__doc__ and __doc__.split('\n\n')) or " "
    op = OptionParser(description=doc[0].strip(),
                      usage='%prog [options] [--] [backends and switches]',
                      #epilog='\n'.join(doc[1:]) # epilog not supported on my python2.4
↪machine: JDH
    )
    op.disable_interspersed_args()
    op.set_defaults(dirs='pylab,api,units,mplot3d',
                    clean=False, coverage=False, valgrind=False)
    op.add_option('-d', '--dirs', '--directories', type='string',
                  dest='dirs', help=dedent('''
    Run only the tests in these directories; comma-separated list of
    one or more of: pylab (or pylab_examples), api, units, mplot3d'''))
    op.add_option('-b', '--backends', type='string', dest='backends',
                  help=dedent('''
    Run tests only for these backends; comma-separated list of
    one or more of: agg, ps, svg, pdf, template, cairo,
    Default is everything except cairo.'''))
    op.add_option('--clean', action='store_true', dest='clean',
                  help='Remove result directories, run no tests')
    op.add_option('-c', '--coverage', action='store_true', dest='coverage',
                  help='Run in coverage.py')
    op.add_option('-v', '--valgrind', action='store_true', dest='valgrind',
                  help='Run in valgrind')

```

```

options, args = op.parse_args()
switches = [x for x in args if x.startswith('--')]
backends = [x.lower() for x in args if not x.startswith('--')]
if options.backends:
    backends += [be.lower() for be in options.backends.split(',')]

result = Bunch(
    dirs=options.dirs.split(','),
    backends=backends or ['agg', 'ps', 'svg', 'pdf', 'template'],
    clean=options.clean,
    coverage=options.coverage,
    valgrind=options.valgrind,
    switches=switches)
if 'pylab_examples' in result.dirs:
    result.dirs[result.dirs.index('pylab_examples')] = 'pylab'
#print(result)
return (result)

if __name__ == '__main__':
    times = {}
    failures = {}
    options = parse_options()

    if options.clean:
        localdirs = [d for d in glob.glob('*') if os.path.isdir(d)]
        all_backends_set = set(all_backends)
        for d in localdirs:
            if d.lower() not in all_backends_set:
                continue
            print('removing %s' % d)
            for fname in glob.glob(os.path.join(d, '*')):
                os.remove(fname)
            os.rmdir(d)
        for fname in glob.glob('_tmp*.py'):
            os.remove(fname)

        print('all clean...')
        raise SystemExit
    if options.coverage:
        python = ['coverage.py', '-x']
    elif options.valgrind:
        python = ['valgrind', '--tool=memcheck', '--leak-check=yes',
            '--log-file=%(name)s', sys.executable]
    elif sys.platform == 'win32':
        python = [sys.executable]
    else:
        python = [sys.executable]

    report_all_missing(options.dirs)
    for backend in options.backends:
        print('testing %s %s' % (backend, ' '.join(options.switches)))
        t0 = time.time()

```

```
failures[backend] = \
    drive(backend, options.dirs, python, options.switches)
t1 = time.time()
times[backend] = (t1 - t0)/60.0

#print(times)
for backend, elapsed in times.items():
    print('Backend %s took %1.2f minutes to complete' % (backend, elapsed))
    failed = failures[backend]
    if failed:
        print(' Failures: %s' % failed)
    if 'template' in times:
        print('\ttemplate ratio %1.3f, template residual %1.3f' % (
            elapsed/times['template'], elapsed - times['template']))
```

Keywords: python, matplotlib, pylab, example, codex (see [Search examples](#))

TEXT_LABELS_AND_ANNOTATIONS EXAMPLES

109.1 text_labels_and_annotations example code: autowrap_demo.py

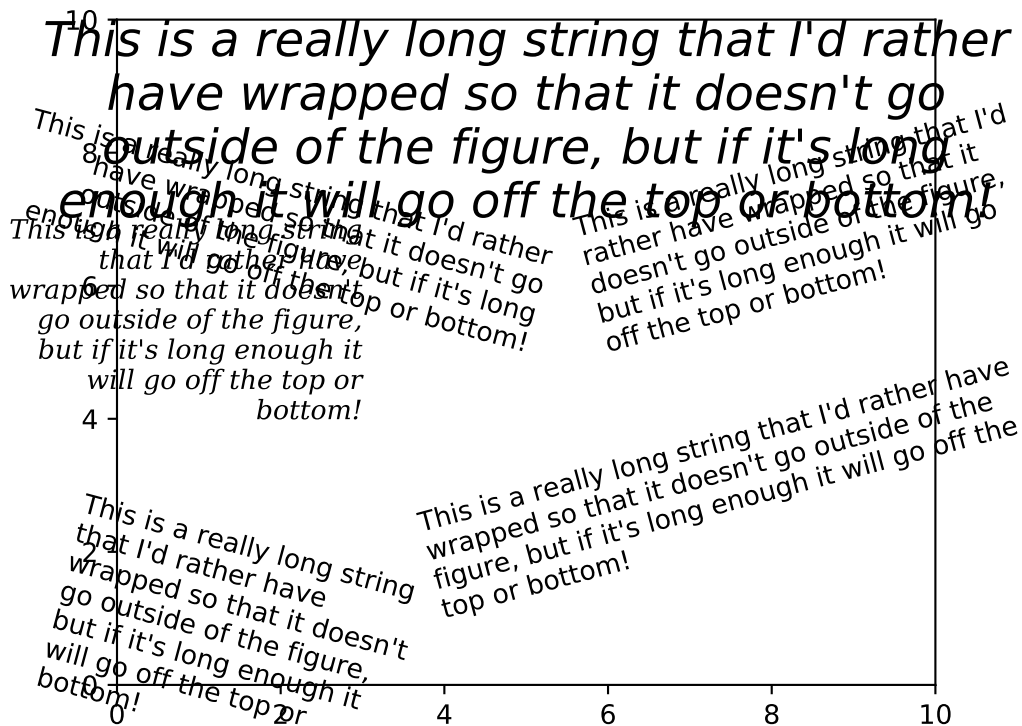

```

"""
=====
Auto-wrapping text
=====

Matplotlib can wrap text automatically, but if it's too long, the text will be
displayed slightly outside of the boundaries of the axis anyways.
"""

```

```
import matplotlib.pyplot as plt

fig = plt.figure()
plt.axis([0, 10, 0, 10])
t = "This is a really long string that I'd rather have wrapped so that it"\
    " doesn't go outside of the figure, but if it's long enough it will go"\
    " off the top or bottom!"
plt.text(4, 1, t, ha='left', rotation=15, wrap=True)
plt.text(6, 5, t, ha='left', rotation=15, wrap=True)
plt.text(5, 5, t, ha='right', rotation=-15, wrap=True)
plt.text(5, 10, t, fontsize=18, style='oblique', ha='center',
        va='top', wrap=True)
plt.text(3, 4, t, family='serif', style='italic', ha='right', wrap=True)
plt.text(-1, 0, t, ha='left', rotation=-15, wrap=True)

plt.show()
```

Keywords: python, matplotlib, pylab, example, codex (see [Search examples](#))

109.2 text_labels_and_annotations example code: rainbow_text.py

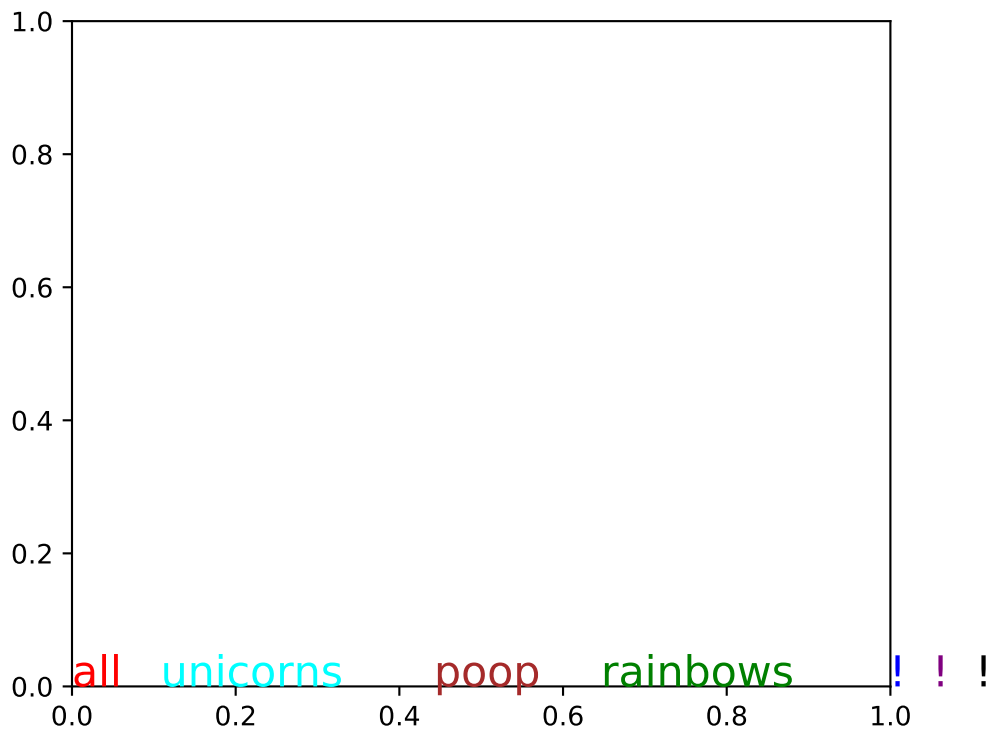

```

# -*- coding: utf-8 -*-
"""
The example shows how to string together several text objects.

HISTORY
-----
On the matplotlib-users list back in February 2012, Gökhan Sever asked the
following question:

    Is there a way in matplotlib to partially specify the color of a string?

Example:

plt.ylabel("Today is cloudy.")
How can I show "today" as red, "is" as green and "cloudy." as blue?

Thanks.

Paul Ivanov responded with this answer:
"""
import matplotlib.pyplot as plt
from matplotlib import transforms

def rainbow_text(x, y, strings, colors, ax=None, **kw):
    """
    Take a list of ``strings`` and ``colors`` and place them next to each
    other, with text strings[i] being shown in colors[i].

    This example shows how to do both vertical and horizontal text, and will
    pass all keyword arguments to plt.text, so you can set the font size,
    family, etc.

    The text will get added to the ``ax`` axes, if provided, otherwise the
    currently active axes will be used.
    """
    if ax is None:
        ax = plt.gca()
    t = ax.transData
    canvas = ax.figure.canvas

    # horizontal version
    for s, c in zip(strings, colors):
        text = ax.text(x, y, s + " ", color=c, transform=t, **kw)
        text.draw(canvas.get_renderer())
        ex = text.get_window_extent()
        t = transforms.offset_copy(text._transform, x=ex.width, units='dots')

    # vertical version
    for s, c in zip(strings, colors):
        text = ax.text(x, y, s + " ", color=c, transform=t,
                      rotation=90, va='bottom', ha='center', **kw)
        text.draw(canvas.get_renderer())

```

```

ex = text.get_window_extent()
t = transforms.offset_copy(text._transform, y=ex.height, units='dots')

rainbow_text(0, 0, "all unicorns poop rainbows ! ! !".split(),
             ['red', 'cyan', 'brown', 'green', 'blue', 'purple', 'black'],
             size=16)

plt.show()

```

Keywords: python, matplotlib, pylab, example, codex (see [Search examples](#))

109.3 text_labels_and_annotations text_demo_fontdict.py

example

code:

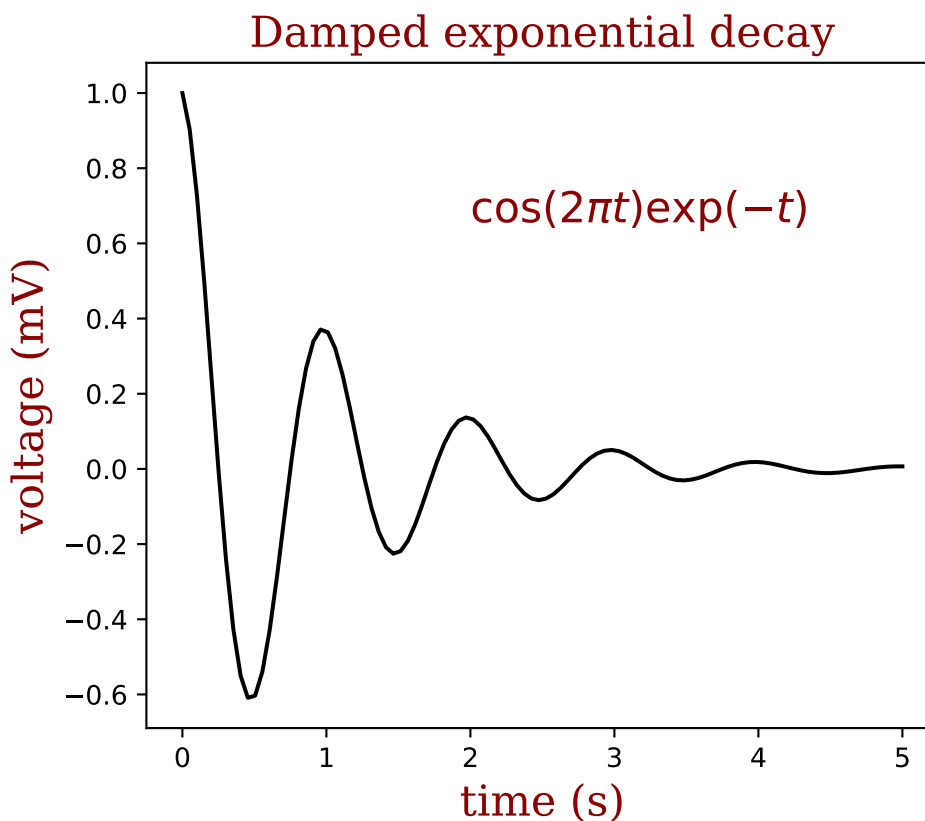

```

"""
=====
Controlling style of text and labels using a dictionary
=====

This example shows how to share parameters across many text objects and labels
by creating a dictionary of options passed across several functions.

```

```
"""  
  
import numpy as np  
import matplotlib.pyplot as plt  
  
font = {'family': 'serif',  
        'color': 'darkred',  
        'weight': 'normal',  
        'size': 16,  
        }  
  
x = np.linspace(0.0, 5.0, 100)  
y = np.cos(2*np.pi*x) * np.exp(-x)  
  
plt.plot(x, y, 'k')  
plt.title('Damped exponential decay', fontdict=font)  
plt.text(2, 0.65, r'$\cos(2 \pi t) \exp(-t)$', fontdict=font)  
plt.xlabel('time (s)', fontdict=font)  
plt.ylabel('voltage (mV)', fontdict=font)  
  
# Tweak spacing to prevent clipping of ylabel  
plt.subplots_adjust(left=0.15)  
plt.show()
```

Keywords: python, matplotlib, pylab, example, codex (see [Search examples](#))

109.4 text_labels_and_annotations example code: unicode_demo.py

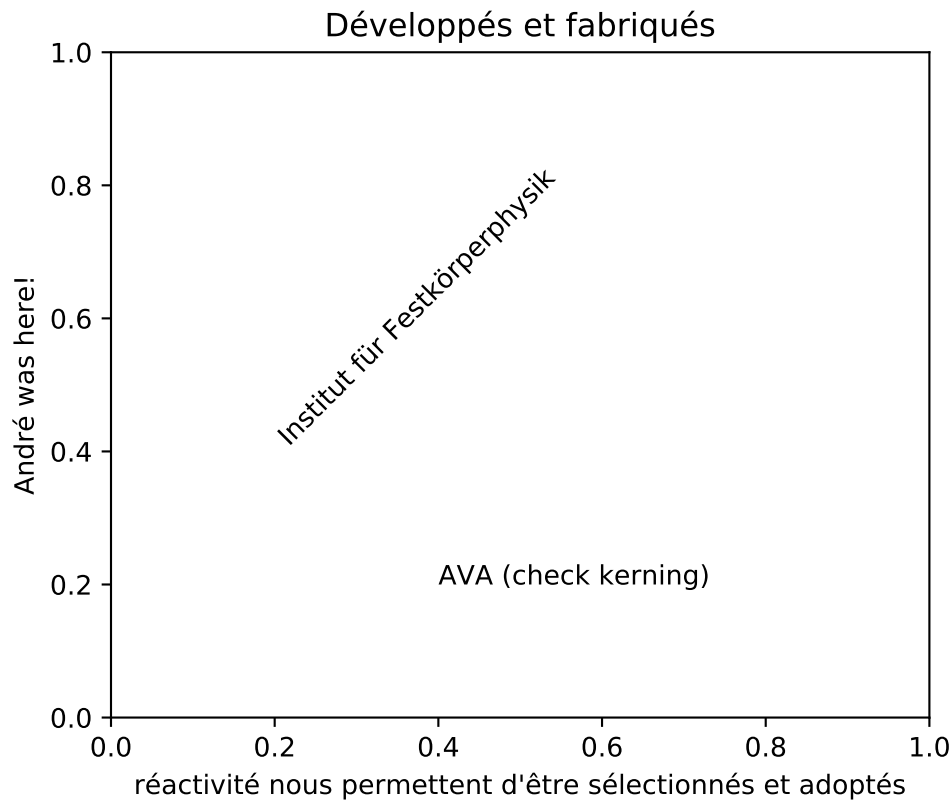

```
# -*- coding: utf-8 -*-
"""
Demo of unicode support in text and labels.
"""
from __future__ import unicode_literals

import matplotlib.pyplot as plt

plt.title('Développés et fabriqués')
plt.xlabel("réactivité nous permettent d'être sélectionnés et adoptés")
plt.ylabel('André was here!')
plt.text(0.2, 0.8, 'Institut für Festkörperphysik', rotation=45)
plt.text(0.4, 0.2, 'AVA (check kerning)')

plt.show()
```

Keywords: python, matplotlib, pylab, example, codex (see [Search examples](#))

TICKS_AND_SPINES EXAMPLES

110.1 ticks_and_spines example code: spines_demo.py

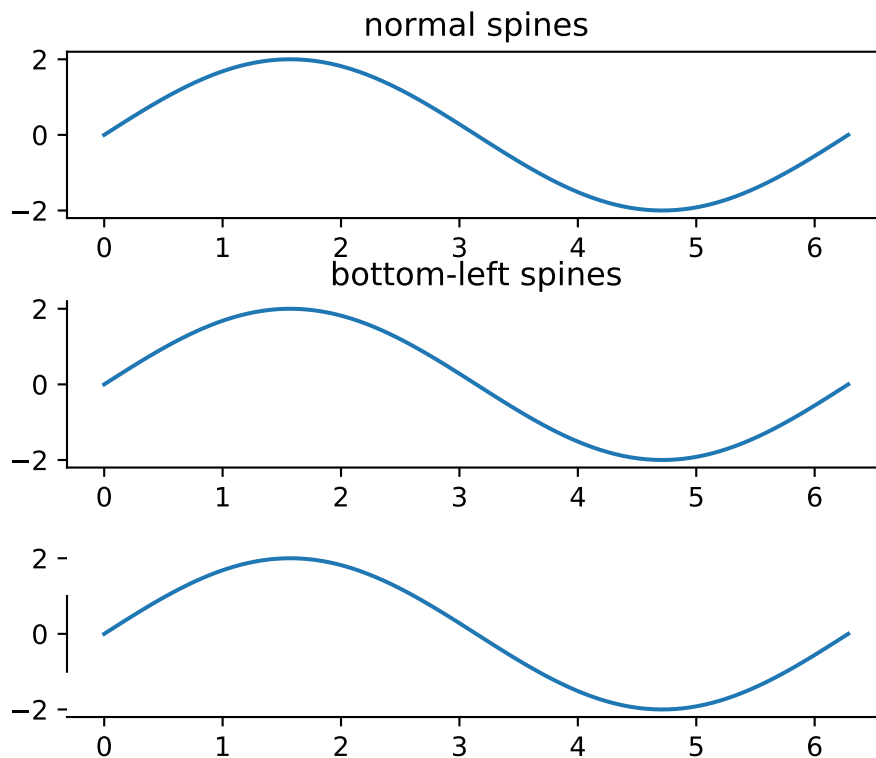

```
"""
=====
Spines
=====

This demo compares:
- normal axes, with spines on all four sides;
- an axes with spines only on the left and bottom;
- an axes using custom bounds to limit the extent of the spine.
"""
import numpy as np
```

```
import matplotlib.pyplot as plt

x = np.linspace(0, 2 * np.pi, 100)
y = 2 * np.sin(x)

fig, (ax0, ax1, ax2) = plt.subplots(nrows=3)

ax0.plot(x, y)
ax0.set_title('normal spines')

ax1.plot(x, y)
ax1.set_title('bottom-left spines')

# Hide the right and top spines
ax1.spines['right'].set_visible(False)
ax1.spines['top'].set_visible(False)
# Only show ticks on the left and bottom spines
ax1.yaxis.set_ticks_position('left')
ax1.xaxis.set_ticks_position('bottom')

ax2.plot(x, y)

# Only draw spine between the y-ticks
ax2.spines['left'].set_bounds(-1, 1)
# Hide the right and top spines
ax2.spines['right'].set_visible(False)
ax2.spines['top'].set_visible(False)
# Only show ticks on the left and bottom spines
ax2.yaxis.set_ticks_position('left')
ax2.xaxis.set_ticks_position('bottom')

# Tweak spacing between subplots to prevent labels from overlapping
plt.subplots_adjust(hspace=0.5)
plt.show()
```

Keywords: python, matplotlib, pylab, example, codex (see [Search examples](#))

110.2 ticks_and_spines example code: spines_demo_bounds.py

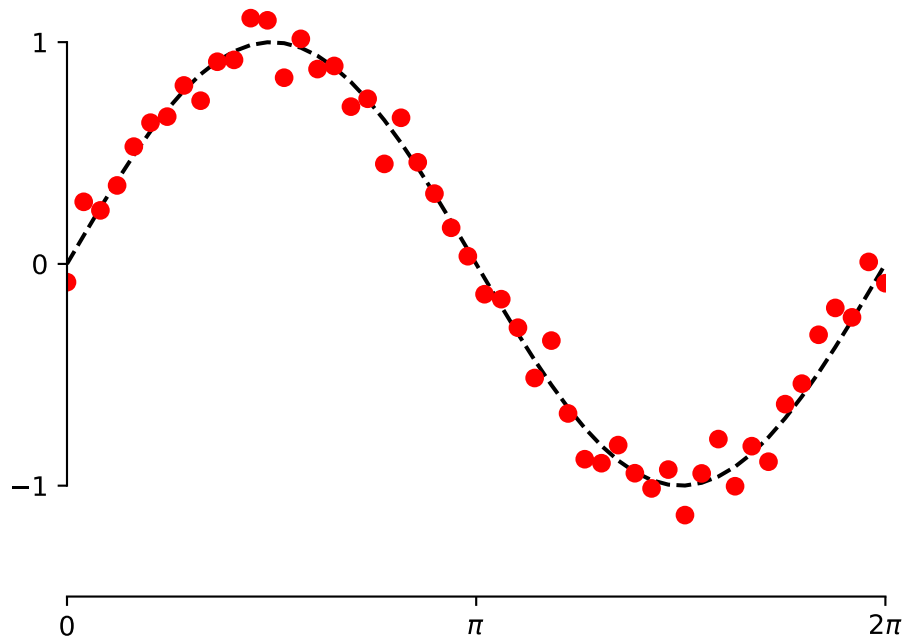

```

"""
Demo of spines using custom bounds to limit the extent of the spine.
"""
import numpy as np
import matplotlib.pyplot as plt

x = np.linspace(0, 2*np.pi, 50)
y = np.sin(x)
y2 = y + 0.1 * np.random.normal(size=x.shape)

fig, ax = plt.subplots()
ax.plot(x, y, 'k--')
ax.plot(x, y2, 'ro')

# set ticks and tick labels
ax.set_xlim((0, 2*np.pi))
ax.set_xticks([0, np.pi, 2*np.pi])
ax.set_xticklabels(['0', '$\pi$', '2$\pi$'])
ax.set_ylim((-1.5, 1.5))
ax.set_yticks([-1, 0, 1])

```

```

# Only draw spine between the y-ticks
ax.spines['left'].set_bounds(-1, 1)
# Hide the right and top spines
ax.spines['right'].set_visible(False)
ax.spines['top'].set_visible(False)
# Only show ticks on the left and bottom spines
ax.yaxis.set_ticks_position('left')
ax.xaxis.set_ticks_position('bottom')

plt.show()

```

Keywords: python, matplotlib, pylab, example, codex (see [Search examples](#))

110.3 ticks_and_spines example code: spines_demo_dropped.py

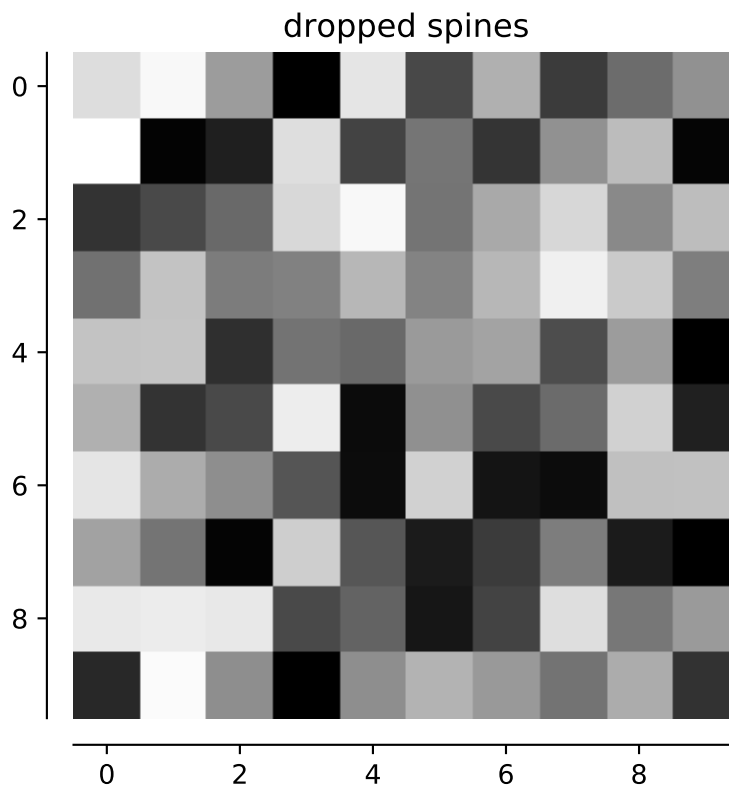

```

"""
=====
Dropped spines
=====

Demo of spines offset from the axes (a.k.a. "dropped spines").
"""

```



```

import numpy as np
import matplotlib.pyplot as plt

fig, ax = plt.subplots()

image = np.random.uniform(size=(10, 10))
ax.imshow(image, cmap=plt.cm.gray, interpolation='nearest')
ax.set_title('dropped spines')

# Move left and bottom spines outward by 10 points
ax.spines['left'].set_position(('outward', 10))
ax.spines['bottom'].set_position(('outward', 10))
# Hide the right and top spines
ax.spines['right'].set_visible(False)
ax.spines['top'].set_visible(False)
# Only show ticks on the left and bottom spines
ax.yaxis.set_ticks_position('left')
ax.xaxis.set_ticks_position('bottom')

plt.show()

```

Keywords: python, matplotlib, pylab, example, codex (see [Search examples](#))

110.4 ticks_and_spines example code: tick-formatters.py

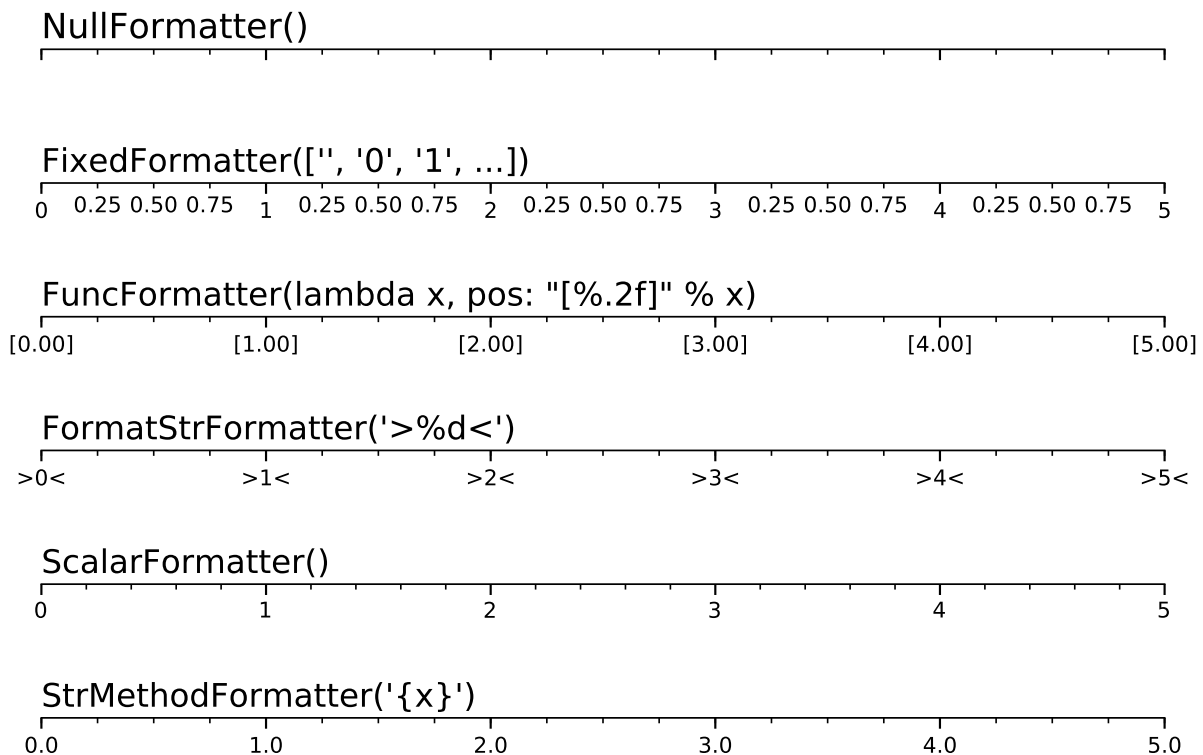

```

"""
=====
Tick formatters
=====

Show the different tick formatters.
"""

import numpy as np
import matplotlib.pyplot as plt
import matplotlib.ticker as ticker

# Setup a plot such that only the bottom spine is shown
def setup(ax):
    ax.spines['right'].set_color('none')
    ax.spines['left'].set_color('none')
    ax.yaxis.set_major_locator(ticker.NullLocator())
    ax.spines['top'].set_color('none')
    ax.xaxis.set_ticks_position('bottom')
    ax.tick_params(which='major', width=1.00, length=5)
    ax.tick_params(which='minor', width=0.75, length=2.5, labelsz=10)
    ax.set_xlim(0, 5)
    ax.set_ylim(0, 1)
    ax.patch.set_alpha(0.0)

plt.figure(figsize=(8, 5))
n = 6

# Null formatter
ax = plt.subplot(n, 1, 1)
setup(ax)
ax.xaxis.set_major_locator(ticker.MultipleLocator(1.00))
ax.xaxis.set_minor_locator(ticker.MultipleLocator(0.25))
ax.xaxis.set_major_formatter(ticker.NullFormatter())
ax.xaxis.set_minor_formatter(ticker.NullFormatter())
ax.text(0.0, 0.1, "NullFormatter()", fontsize=16, transform=ax.transAxes)

# Fixed formatter
ax = plt.subplot(n, 1, 2)
setup(ax)
ax.xaxis.set_major_locator(ticker.MultipleLocator(1.0))
ax.xaxis.set_minor_locator(ticker.MultipleLocator(0.25))
majors = ["", "0", "1", "2", "3", "4", "5"]
ax.xaxis.set_major_formatter(ticker.FixedFormatter(majors))
minors = [""] + ["%.2f" % (x-int(x)) if (x-int(x))
                 else "" for x in np.arange(0, 5, 0.25)]
ax.xaxis.set_minor_formatter(ticker.FixedFormatter(minors))
ax.text(0.0, 0.1, "FixedFormatter(['', '0', '1', ...])",
        fontsize=15, transform=ax.transAxes)

```

```

# Func formatter
def major_formatter(x, pos):
    return "[% .2f]" % x

ax = plt.subplot(n, 1, 3)
setup(ax)
ax.xaxis.set_major_locator(ticker.MultipleLocator(1.00))
ax.xaxis.set_minor_locator(ticker.MultipleLocator(0.25))
ax.xaxis.set_major_formatter(ticker.FuncFormatter(major_formatter))
ax.text(0.0, 0.1, 'FuncFormatter(lambda x, pos: "[% .2f]" % x)',
        fontsize=15, transform=ax.transAxes)

# FormatStr formatter
ax = plt.subplot(n, 1, 4)
setup(ax)
ax.xaxis.set_major_locator(ticker.MultipleLocator(1.00))
ax.xaxis.set_minor_locator(ticker.MultipleLocator(0.25))
ax.xaxis.set_major_formatter(ticker.FormatStrFormatter(">%d<"))
ax.text(0.0, 0.1, "FormatStrFormatter('>%d<')",
        fontsize=15, transform=ax.transAxes)

# Scalar formatter
ax = plt.subplot(n, 1, 5)
setup(ax)
ax.xaxis.set_major_locator(ticker.AutoLocator())
ax.xaxis.set_minor_locator(ticker.AutoMinorLocator())
ax.xaxis.set_major_formatter(ticker.ScalarFormatter(useMathText=True))
ax.text(0.0, 0.1, "ScalarFormatter()", fontsize=15, transform=ax.transAxes)

# StrMethod formatter
ax = plt.subplot(n, 1, 6)
setup(ax)
ax.xaxis.set_major_locator(ticker.MultipleLocator(1.00))
ax.xaxis.set_minor_locator(ticker.MultipleLocator(0.25))
ax.xaxis.set_major_formatter(ticker.StrMethodFormatter("{x}"))
ax.text(0.0, 0.1, "StrMethodFormatter('{x}']",
        fontsize=15, transform=ax.transAxes)

# Push the top of the top axes outside the figure because we only show the
# bottom spine.
plt.subplots_adjust(left=0.05, right=0.95, bottom=0.05, top=1.05)

plt.show()

```

Keywords: python, matplotlib, pylab, example, codex (see [Search examples](#))

110.5 ticks_and_spines example code: tick-locators.py

NullLocator()

MultipleLocator(0.5)

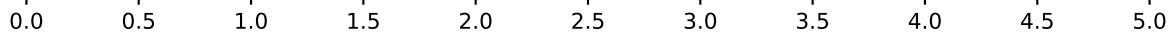

FixedLocator([0, 1, 5])



LinearLocator(numticks=3)

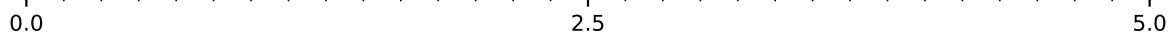

IndexLocator(base=0.5, offset=0.25)



AutoLocator()

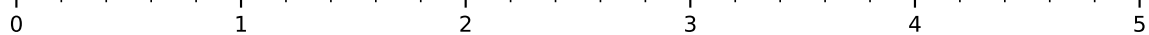

MaxNLocator(n=4)



LogLocator(base=10, numticks=15)

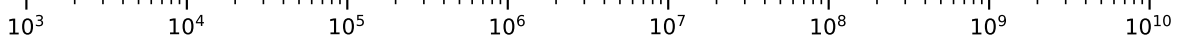

```

"""
=====
Tick locators
=====

Show the different tick locators.
"""

import numpy as np
import matplotlib.pyplot as plt
import matplotlib.ticker as ticker

# Setup a plot such that only the bottom spine is shown
def setup(ax):
    ax.spines['right'].set_color('none')
    ax.spines['left'].set_color('none')
    ax.yaxis.set_major_locator(ticker.NullLocator())
    ax.spines['top'].set_color('none')
    ax.xaxis.set_ticks_position('bottom')

```

```

ax.tick_params(which='major', width=1.00)
ax.tick_params(which='major', length=5)
ax.tick_params(which='minor', width=0.75)
ax.tick_params(which='minor', length=2.5)
ax.set_xlim(0, 5)
ax.set_ylim(0, 1)
ax.patch.set_alpha(0.0)

plt.figure(figsize=(8, 6))
n = 8

# Null Locator
ax = plt.subplot(n, 1, 1)
setup(ax)
ax.xaxis.set_major_locator(ticker.NullLocator())
ax.xaxis.set_minor_locator(ticker.NullLocator())
ax.text(0.0, 0.1, "NullLocator()", fontsize=14, transform=ax.transAxes)

# Multiple Locator
ax = plt.subplot(n, 1, 2)
setup(ax)
ax.xaxis.set_major_locator(ticker.MultipleLocator(0.5))
ax.xaxis.set_minor_locator(ticker.MultipleLocator(0.1))
ax.text(0.0, 0.1, "MultipleLocator(0.5)", fontsize=14,
        transform=ax.transAxes)

# Fixed Locator
ax = plt.subplot(n, 1, 3)
setup(ax)
majors = [0, 1, 5]
ax.xaxis.set_major_locator(ticker.FixedLocator(majors))
minors = np.linspace(0, 1, 11)[1:-1]
ax.xaxis.set_minor_locator(ticker.FixedLocator(minors))
ax.text(0.0, 0.1, "FixedLocator([0, 1, 5])", fontsize=14,
        transform=ax.transAxes)

# Linear Locator
ax = plt.subplot(n, 1, 4)
setup(ax)
ax.xaxis.set_major_locator(ticker.LinearLocator(3))
ax.xaxis.set_minor_locator(ticker.LinearLocator(31))
ax.text(0.0, 0.1, "LinearLocator(numticks=3)",
        fontsize=14, transform=ax.transAxes)

# Index Locator
ax = plt.subplot(n, 1, 5)
setup(ax)
ax.plot(range(0, 5), [0]*5, color='White')
ax.xaxis.set_major_locator(ticker.IndexLocator(base=.5, offset=.25))
ax.text(0.0, 0.1, "IndexLocator(base=0.5, offset=0.25)",
        fontsize=14, transform=ax.transAxes)

```

```
# Auto Locator
ax = plt.subplot(n, 1, 6)
setup(ax)
ax.xaxis.set_major_locator(ticker.AutoLocator())
ax.xaxis.set_minor_locator(ticker.AutoMinorLocator())
ax.text(0.0, 0.1, "AutoLocator()", fontsize=14, transform=ax.transAxes)

# MaxN Locator
ax = plt.subplot(n, 1, 7)
setup(ax)
ax.xaxis.set_major_locator(ticker.MaxNLocator(4))
ax.xaxis.set_minor_locator(ticker.MaxNLocator(40))
ax.text(0.0, 0.1, "MaxNLocator(n=4)", fontsize=14, transform=ax.transAxes)

# Log Locator
ax = plt.subplot(n, 1, 8)
setup(ax)
ax.set_xlim(10**3, 10**10)
ax.set_xscale('log')
ax.xaxis.set_major_locator(ticker.LogLocator(base=10.0, numticks=15))
ax.text(0.0, 0.1, "LogLocator(base=10, numticks=15)",
        fontsize=15, transform=ax.transAxes)

# Push the top of the top axes outside the figure because we only show the
# bottom spine.
plt.subplots_adjust(left=0.05, right=0.95, bottom=0.05, top=1.05)

plt.show()
```

Keywords: python, matplotlib, pylab, example, codex (see [Search examples](#))

110.6 ticks_and_spines example code: tick_labels_from_values.py

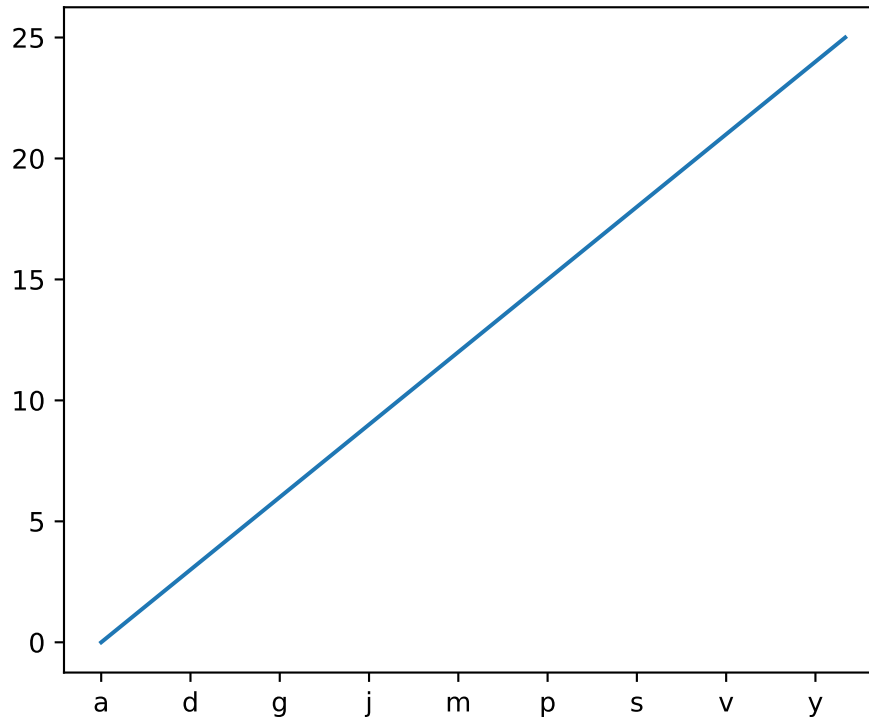

```

"""
=====
Setting tick labels from a list of values
=====

Using ax.set_xticks causes the tick labels to be set on the currently
chosen ticks. However, you may want to allow matplotlib to dynamically
choose the number of ticks and their spacing.

In this case it may be better to determine the tick label from the
value at the tick. The following example shows how to do this.

NB: The MaxNLocator is used here to ensure that the tick values
take integer values.

"""

import matplotlib.pyplot as plt
from matplotlib.ticker import FuncFormatter, MaxNLocator
fig = plt.figure()
ax = fig.add_subplot(111)
xs = range(26)

```

```
ys = range(26)
labels = list('abcdefghijklmnopqrstuvwxyz')

def format_fn(tick_val, tick_pos):
    if int(tick_val) in xs:
        return labels[int(tick_val)]
    else:
        return ''

ax.xaxis.set_major_formatter(FuncFormatter(format_fn))
ax.xaxis.set_major_locator(MaxNLocator(integer=True))
ax.plot(xs, ys)
plt.show()
```

Keywords: python, matplotlib, pylab, example, codex (see [Search examples](#))

110.7 ticks_and_spines example code: ticklabels_demo_rotation.py

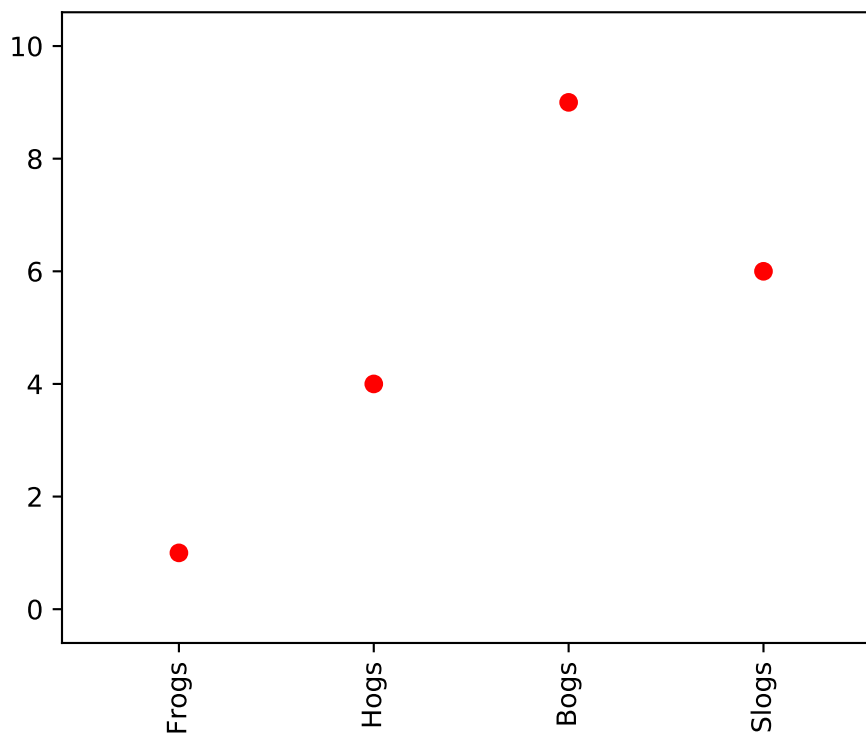

```
"""
=====
```

Rotating custom tick labels

=====

Demo of custom tick-labels with user-defined rotation.

"""

```
import matplotlib.pyplot as plt
```

```
x = [1, 2, 3, 4]
```

```
y = [1, 4, 9, 6]
```

```
labels = ['Frogs', 'Hogs', 'Bogs', 'Slogs']
```

```
plt.plot(x, y, 'ro')
```

```
# You can specify a rotation for the tick labels in degrees or with keywords.
```

```
plt.xticks(x, labels, rotation='vertical')
```

```
# Pad margins so that markers don't get clipped by the axes
```

```
plt.margins(0.2)
```

```
# Tweak spacing to prevent clipping of tick-labels
```

```
plt.subplots_adjust(bottom=0.15)
```

```
plt.show()
```

Keywords: python, matplotlib, pylab, example, codex (see *Search examples*)

UNITS EXAMPLES

111.1 units example code: `annotate_with_units.py`

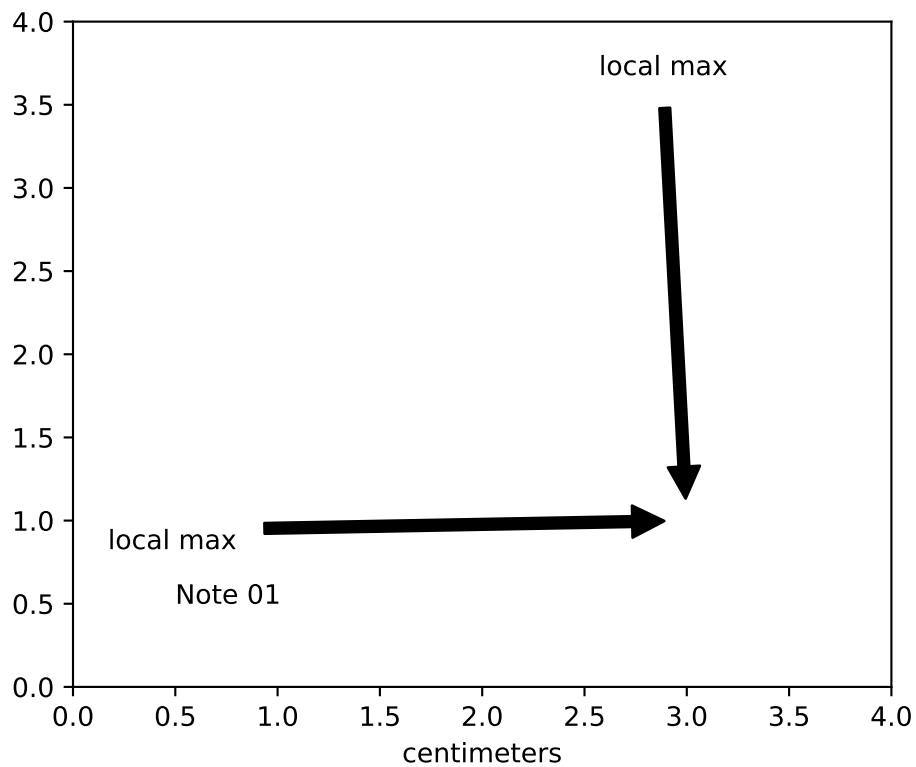

```
"""
=====
Annotation with units
=====

The example illustrates how to create text and arrow
annotations using a centimeter-scale plot.

"""
```

```
import matplotlib.pyplot as plt
from basic_units import cm

fig, ax = plt.subplots()

ax.annotate("Note 01", [0.5*cm, 0.5*cm])

# xy and text both unitized
ax.annotate('local max', xy=(3*cm, 1*cm), xycoords='data',
            xytext=(0.8*cm, 0.95*cm), textcoords='data',
            arrowprops=dict(facecolor='black', shrink=0.05),
            horizontalalignment='right', verticalalignment='top')

# mixing units w/ nonunits
ax.annotate('local max', xy=(3*cm, 1*cm), xycoords='data',
            xytext=(0.8, 0.95), textcoords='axes fraction',
            arrowprops=dict(facecolor='black', shrink=0.05),
            horizontalalignment='right', verticalalignment='top')

ax.set_xlim(0*cm, 4*cm)
ax.set_ylim(0*cm, 4*cm)
plt.show()
```

Keywords: python, matplotlib, pylab, example, codex (see [Search examples](#))

111.2 units example code: artist_tests.py

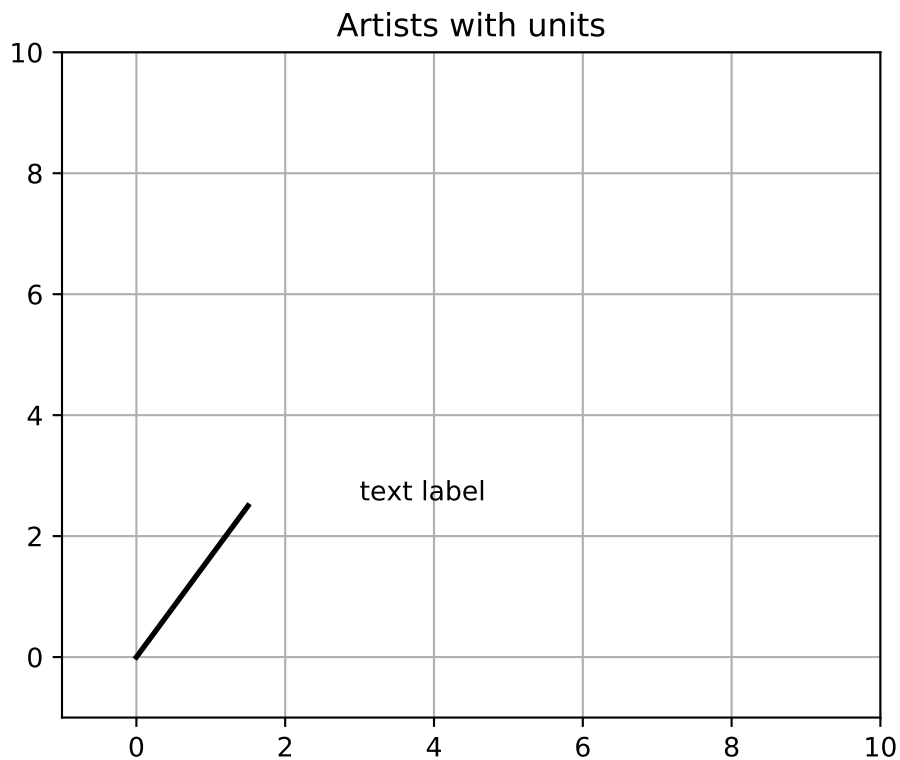

```

"""
=====
Artist tests
=====

Test unit support with each of the Matplotlib primitive artist types.

The axis handles unit conversions and the artists keep a pointer to their axis
parent. You must initialize the artists with the axis instance if you want to
use them with unit data, or else they will not know how to convert the units
to scalars.
"""
import random
import matplotlib.lines as lines
import matplotlib.patches as patches
import matplotlib.text as text
import matplotlib.collections as collections

from basic_units import cm, inch
import numpy as np
import matplotlib.pyplot as plt

```

```
fig, ax = plt.subplots()
ax.xaxis.set_units(cm)
ax.yaxis.set_units(cm)

if 0:
    # test a line collection
    # Not supported at present.
    verts = []
    for i in range(10):
        # a random line segment in inches
        verts.append(zip(*inch*10*np.random.rand(2, random.randint(2, 15))))
    lc = collections.LineCollection(verts, axes=ax)
    ax.add_collection(lc)

# test a plain-ol-line
line = lines.Line2D([0*cm, 1.5*cm], [0*cm, 2.5*cm],
                    lw=2, color='black', axes=ax)
ax.add_line(line)

if 0:
    # test a patch
    # Not supported at present.
    rect = patches.Rectangle((1*cm, 1*cm), width=5*cm, height=2*cm,
                              alpha=0.2, axes=ax)

    ax.add_patch(rect)

t = text.Text(3*cm, 2.5*cm, 'text label', ha='left', va='bottom', axes=ax)
ax.add_artist(t)

ax.set_xlim(-1*cm, 10*cm)
ax.set_ylim(-1*cm, 10*cm)
# ax.xaxis.set_units(inch)
ax.grid(True)
ax.set_title("Artists with units")
plt.show()
```

Keywords: python, matplotlib, pylab, example, codex (see [Search examples](#))

111.3 units example code: bar_demo2.py

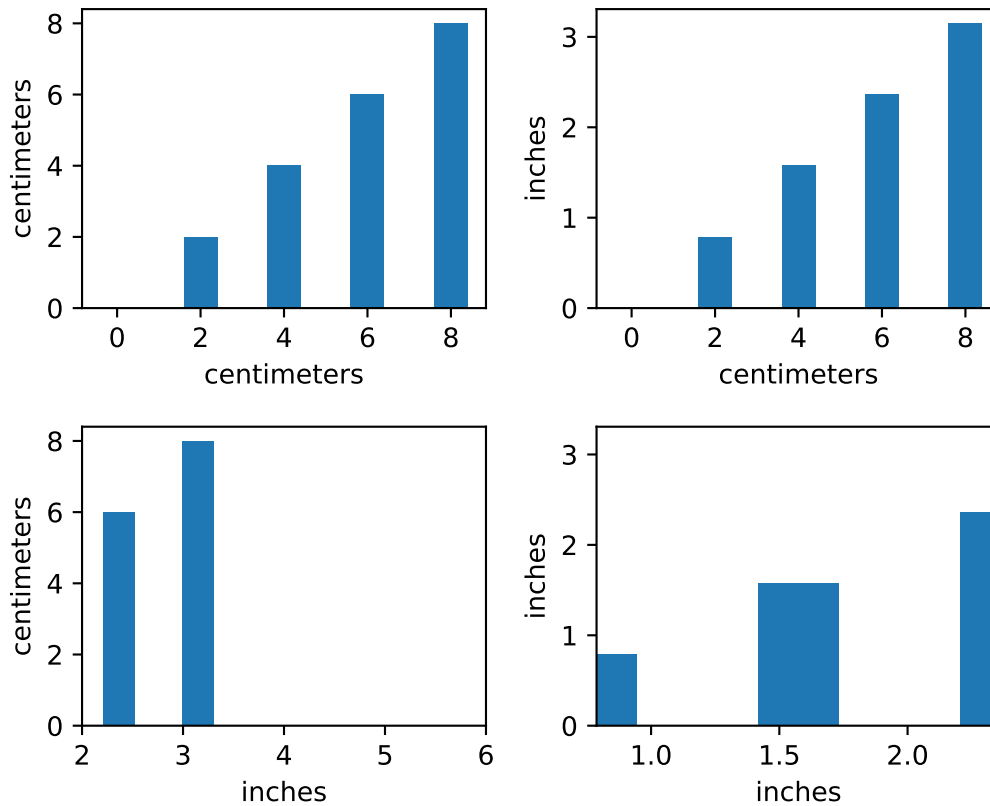

```

"""
=====
Bar demo with units
=====

A plot using a variety of centimetre and inch conversions. This example shows
how default unit introspection works (ax1), how various keywords can be used to
set the x and y units to override the defaults (ax2, ax3, ax4) and how one can
set the xlims using scalars (ax3, current units assumed) or units
(conversions applied to get the numbers to current units).

"""
import numpy as np
from basic_units import cm, inch
import matplotlib.pyplot as plt

cms = cm * np.arange(0, 10, 2)
bottom = 0 * cm
width = 0.8 * cm

fig, axs = plt.subplots(2, 2)

```

```

axs[0, 0].bar(cms, cms, bottom=bottom)

axs[0, 1].bar(cms, cms, bottom=bottom, width=width, xunits=cm, yunits=inch)

axs[1, 0].bar(cms, cms, bottom=bottom, width=width, xunits=inch, yunits=cm)
axs[1, 0].set_xlim(2, 6) # scalars are interpreted in current units

axs[1, 1].bar(cms, cms, bottom=bottom, width=width, xunits=inch, yunits=inch)
axs[1, 1].set_xlim(2 * cm, 6 * cm) # cm are converted to inches

fig.tight_layout()
plt.show()

```

Keywords: python, matplotlib, pylab, example, codex (see [Search examples](#))

111.4 units example code: bar_unit_demo.py

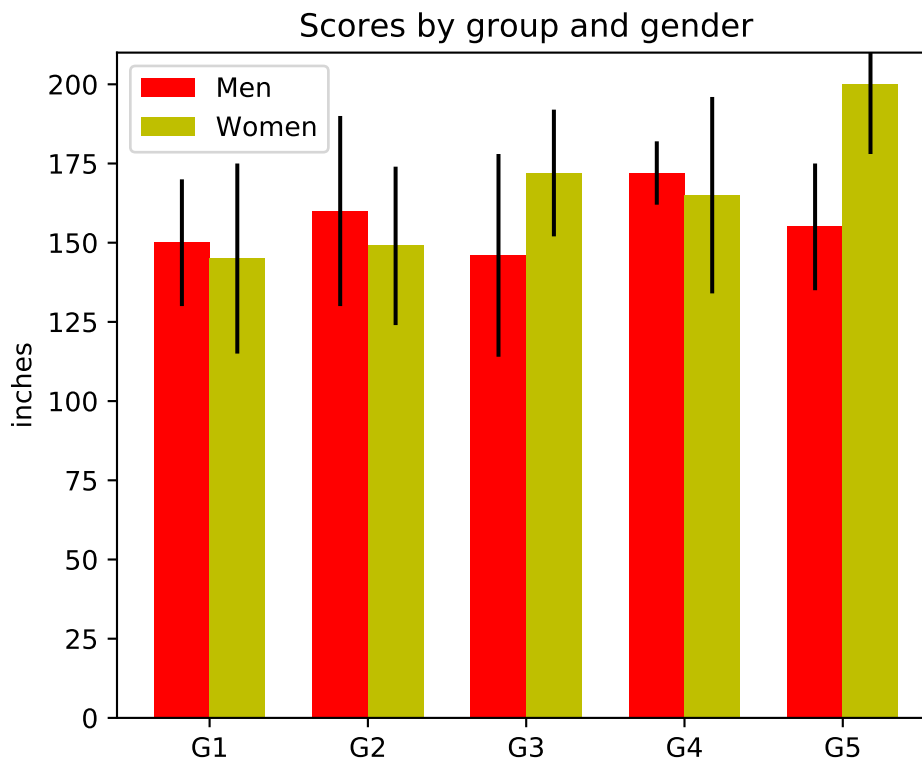

```

"""
=====
Group barchart with units
=====

```



```

This is the same example as
<a href='http://matplotlib.org/examples/api/barchart_demo.html'>
the barchart demo</a> in centimeters.
"""

import numpy as np
from basic_units import cm, inch
import matplotlib.pyplot as plt

N = 5
menMeans = (150*cm, 160*cm, 146*cm, 172*cm, 155*cm)
menStd = (20*cm, 30*cm, 32*cm, 10*cm, 20*cm)

fig, ax = plt.subplots()

ind = np.arange(N)    # the x locations for the groups
width = 0.35         # the width of the bars
p1 = ax.bar(ind, menMeans, width, color='r', bottom=0*cm, yerr=menStd)

womenMeans = (145*cm, 149*cm, 172*cm, 165*cm, 200*cm)
womenStd = (30*cm, 25*cm, 20*cm, 31*cm, 22*cm)
p2 = ax.bar(ind + width, womenMeans, width,
            color='y', bottom=0*cm, yerr=womenStd)

ax.set_title('Scores by group and gender')
ax.set_xticks(ind + width / 2)
ax.set_xticklabels(('G1', 'G2', 'G3', 'G4', 'G5'))

ax.legend((p1[0], p2[0]), ('Men', 'Women'))
ax.yaxis.set_units(inch)
ax.autoscale_view()

plt.show()

```

Keywords: python, matplotlib, pylab, example, codex (see *Search examples*)

111.5 units example code: basic_units.py

```

import math

import numpy as np

import matplotlib.units as units
import matplotlib.ticker as ticker
from matplotlib.axes import Axes
from matplotlib.cbook import iterable

class ProxyDelegate(object):

```

```

def __init__(self, fn_name, proxy_type):
    self.proxy_type = proxy_type
    self.fn_name = fn_name

def __get__(self, obj, objtype=None):
    return self.proxy_type(self.fn_name, obj)

class TaggedValueMeta (type):
    def __init__(cls, name, bases, dict):
        for fn_name in cls._proxies.keys():
            try:
                dummy = getattr(cls, fn_name)
            except AttributeError:
                setattr(cls, fn_name,
                        ProxyDelegate(fn_name, cls._proxies[fn_name]))

class PassThroughProxy(object):
    def __init__(self, fn_name, obj):
        self.fn_name = fn_name
        self.target = obj.proxy_target

    def __call__(self, *args):
        fn = getattr(self.target, self.fn_name)
        ret = fn(*args)
        return ret

class ConvertArgsProxy(PassThroughProxy):
    def __init__(self, fn_name, obj):
        PassThroughProxy.__init__(self, fn_name, obj)
        self.unit = obj.unit

    def __call__(self, *args):
        converted_args = []
        for a in args:
            try:
                converted_args.append(a.convert_to(self.unit))
            except AttributeError:
                converted_args.append(TaggedValue(a, self.unit))
        converted_args = tuple([c.get_value() for c in converted_args])
        return PassThroughProxy.__call__(self, *converted_args)

class ConvertReturnProxy(PassThroughProxy):
    def __init__(self, fn_name, obj):
        PassThroughProxy.__init__(self, fn_name, obj)
        self.unit = obj.unit

    def __call__(self, *args):
        ret = PassThroughProxy.__call__(self, *args)
        if (type(ret) == type(NotImplemented)):

```

```

        return NotImplemented
    return TaggedValue(ret, self.unit)

class ConvertAllProxy(PassThroughProxy):
    def __init__(self, fn_name, obj):
        PassThroughProxy.__init__(self, fn_name, obj)
        self.unit = obj.unit

    def __call__(self, *args):
        converted_args = []
        arg_units = [self.unit]
        for a in args:
            if hasattr(a, 'get_unit') and not hasattr(a, 'convert_to'):
                # if this arg has a unit type but no conversion ability,
                # this operation is prohibited
                return NotImplemented

            if hasattr(a, 'convert_to'):
                try:
                    a = a.convert_to(self.unit)
                except:
                    pass
                arg_units.append(a.get_unit())
                converted_args.append(a.get_value())
            else:
                converted_args.append(a)
                if hasattr(a, 'get_unit'):
                    arg_units.append(a.get_unit())
                else:
                    arg_units.append(None)
        converted_args = tuple(converted_args)
        ret = PassThroughProxy.__call__(self, *converted_args)
        if (type(ret) == type(NotImplemented)):
            return NotImplemented
        ret_unit = unit_resolver(self.fn_name, arg_units)
        if (ret_unit == NotImplemented):
            return NotImplemented
        return TaggedValue(ret, ret_unit)

class _TaggedValue(object):

    _proxies = {'__add__': ConvertAllProxy,
                '__sub__': ConvertAllProxy,
                '__mul__': ConvertAllProxy,
                '__rmul__': ConvertAllProxy,
                '__cmp__': ConvertAllProxy,
                '__lt__': ConvertAllProxy,
                '__gt__': ConvertAllProxy,
                '__len__': PassThroughProxy}

    def __new__(cls, value, unit):

```

```

# generate a new subclass for value
value_class = type(value)
try:
    subcls = type('TaggedValue_of_%s' % (value_class.__name__),
                  tuple([cls, value_class]),
                  {})
    if subcls not in units.registry:
        units.registry[subcls] = basicConverter
    return object.__new__(subcls)
except TypeError:
    if cls not in units.registry:
        units.registry[cls] = basicConverter
    return object.__new__(cls)

def __init__(self, value, unit):
    self.value = value
    self.unit = unit
    self.proxy_target = self.value

def __getattr__(self, name):
    if (name.startswith('__')):
        return object.__getattr__(self, name)
    variable = object.__getattr__(self, 'value')
    if (hasattr(variable, name) and name not in self.__class__.__dict__):
        return getattr(variable, name)
    return object.__getattr__(self, name)

def __array__(self, t=None, context=None):
    if t is not None:
        return np.asarray(self.value).astype(t)
    else:
        return np.asarray(self.value, '0')

def __array_wrap__(self, array, context):
    return TaggedValue(array, self.unit)

def __repr__(self):
    return 'TaggedValue(' + repr(self.value) + ', ' + repr(self.unit) + ')'

def __str__(self):
    return str(self.value) + ' in ' + str(self.unit)

def __len__(self):
    return len(self.value)

def __iter__(self):
    class IteratorProxy(object):
        def __init__(self, iter, unit):
            self.iter = iter
            self.unit = unit

        def __next__(self):
            value = next(self.iter)

```

```

        return TaggedValue(value, self.unit)
    next = __next__ # for Python 2
    return IteratorProxy(iter(self.value), self.unit)

def get_compressed_copy(self, mask):
    new_value = np.ma.masked_array(self.value, mask=mask).compressed()
    return TaggedValue(new_value, self.unit)

def convert_to(self, unit):
    if (unit == self.unit or not unit):
        return self
    new_value = self.unit.convert_value_to(self.value, unit)
    return TaggedValue(new_value, unit)

def get_value(self):
    return self.value

def get_unit(self):
    return self.unit

```

```
TaggedValue = TaggedValueMeta('TaggedValue', (_TaggedValue, ), {})
```

```

class BasicUnit(object):
    def __init__(self, name, fullname=None):
        self.name = name
        if fullname is None:
            fullname = name
        self.fullname = fullname
        self.conversions = dict()

    def __repr__(self):
        return 'BasicUnit(%s)' % self.name

    def __str__(self):
        return self.fullname

    def __call__(self, value):
        return TaggedValue(value, self)

    def __mul__(self, rhs):
        value = rhs
        unit = self
        if hasattr(rhs, 'get_unit'):
            value = rhs.get_value()
            unit = rhs.get_unit()
            unit = unit_resolver('__mul__', (self, unit))
        if (unit == NotImplemented):
            return NotImplemented
        return TaggedValue(value, unit)

    def __rmul__(self, lhs):

```

```
    return self*lhs

def __array_wrap__(self, array, context):
    return TaggedValue(array, self)

def __array__(self, t=None, context=None):
    ret = np.array([1])
    if t is not None:
        return ret.astype(t)
    else:
        return ret

def add_conversion_factor(self, unit, factor):
    def convert(x):
        return x*factor
    self.conversions[unit] = convert

def add_conversion_fn(self, unit, fn):
    self.conversions[unit] = fn

def get_conversion_fn(self, unit):
    return self.conversions[unit]

def convert_value_to(self, value, unit):
    conversion_fn = self.conversions[unit]
    ret = conversion_fn(value)
    return ret

def get_unit(self):
    return self

class UnitResolver(object):
    def addition_rule(self, units):
        for unit_1, unit_2 in zip(units[:-1], units[1:]):
            if unit_1 != unit_2:
                return NotImplemented
        return units[0]

    def multiplication_rule(self, units):
        non_null = [u for u in units if u]
        if (len(non_null) > 1):
            return NotImplemented
        return non_null[0]

    op_dict = {
        '__mul__': multiplication_rule,
        '__rmul__': multiplication_rule,
        '__add__': addition_rule,
        '__radd__': addition_rule,
        '__sub__': addition_rule,
        '__rsub__': addition_rule}
```

```

def __call__(self, operation, units):
    if (operation not in self.op_dict):
        return NotImplemented

    return self.op_dict[operation](self, units)

unit_resolver = UnitResolver()

cm = BasicUnit('cm', 'centimeters')
inch = BasicUnit('inch', 'inches')
inch.add_conversion_factor(cm, 2.54)
cm.add_conversion_factor(inch, 1/2.54)

radians = BasicUnit('rad', 'radians')
degrees = BasicUnit('deg', 'degrees')
radians.add_conversion_factor(degrees, 180.0/np.pi)
degrees.add_conversion_factor(radians, np.pi/180.0)

secs = BasicUnit('s', 'seconds')
hertz = BasicUnit('Hz', 'Hertz')
minutes = BasicUnit('min', 'minutes')

secs.add_conversion_fn(hertz, lambda x: 1./x)
secs.add_conversion_factor(minutes, 1/60.0)

# radians formatting
def rad_fn(x, pos=None):
    n = int((x / np.pi) * 2.0 + 0.25)
    if n == 0:
        return '0'
    elif n == 1:
        return r'$\pi/2$'
    elif n == 2:
        return r'$\pi$'
    elif n % 2 == 0:
        return r'%s\pi$' % (n//2,)
    else:
        return r'%s\pi/2$' % (n,)

class BasicUnitConverter(units.ConversionInterface):
    @staticmethod
    def axisinfo(unit, axis):
        'return AxisInfo instance for x and unit'

        if unit == radians:
            return units.AxisInfo(
                majloc=ticker.MultipleLocator(base=np.pi/2),
                majfmt=ticker.FuncFormatter(rad_fn),
                label=unit.fullname,
            )

```

```

    elif unit == degrees:
        return units.AxisInfo(
            majloc=ticker.AutoLocator(),
            majfmt=ticker.FormatStrFormatter(r'%i^\circ$'),
            label=unit.fullname,
        )
    elif unit is not None:
        if hasattr(unit, 'fullname'):
            return units.AxisInfo(label=unit.fullname)
        elif hasattr(unit, 'unit'):
            return units.AxisInfo(label=unit.unit.fullname)
    return None

    @staticmethod
    def convert(val, unit, axis):
        if units.ConversionInterface.is_numlike(val):
            return val
        if iterable(val):
            return [thisval.convert_to(unit).get_value() for thisval in val]
        else:
            return val.convert_to(unit).get_value()

    @staticmethod
    def default_units(x, axis):
        'return the default unit for x or None'
        if iterable(x):
            for thisx in x:
                return thisx.unit
        return x.unit

def cos(x):
    if iterable(x):
        return [math.cos(val.convert_to(radians).get_value()) for val in x]
    else:
        return math.cos(x.convert_to(radians).get_value())

basicConverter = BasicUnitConverter()
units.registry[BasicUnit] = basicConverter
units.registry[TaggedValue] = basicConverter

```

Keywords: python, matplotlib, pylab, example, codex (see [Search examples](#))

111.6 units example code: ellipse_with_units.py

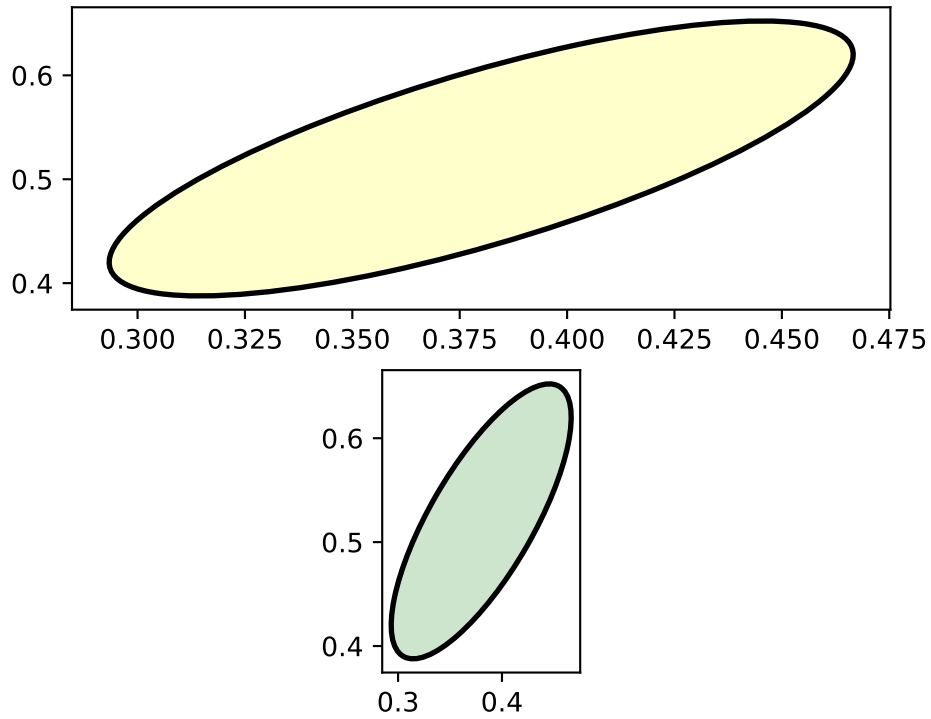

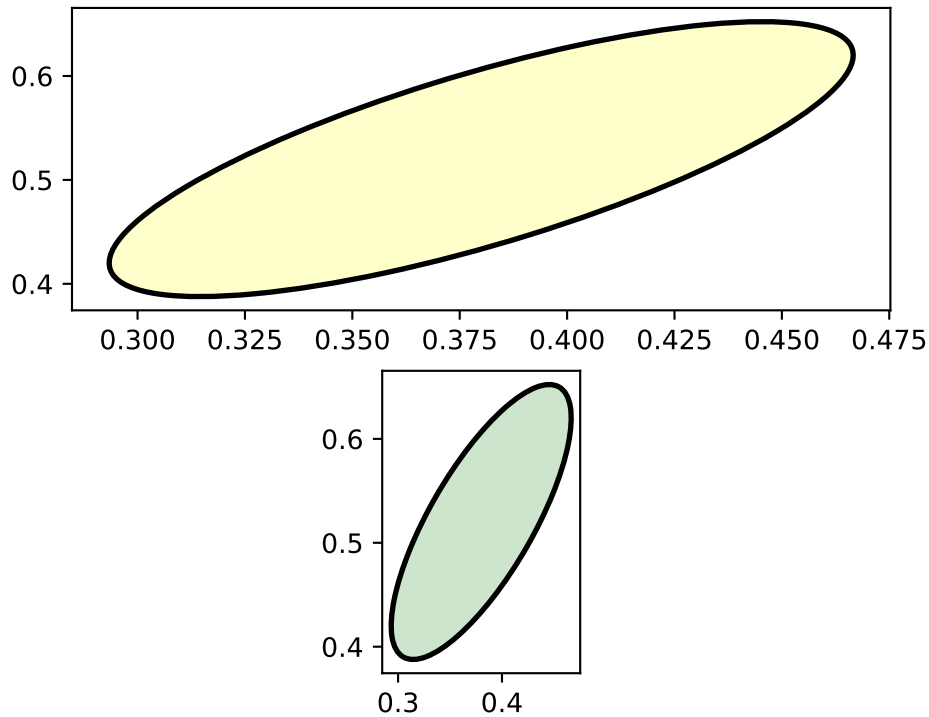

```

"""
Compare the ellipse generated with arcs versus a polygonal approximation
"""
from basic_units import cm
import numpy as np
from matplotlib import patches
import matplotlib.pyplot as plt

xcenter, ycenter = 0.38*cm, 0.52*cm
#xcenter, ycenter = 0., 0.
width, height = 1e-1*cm, 3e-1*cm
angle = -30

theta = np.arange(0.0, 360.0, 1.0)*np.pi/180.0
x = 0.5 * width * np.cos(theta)
y = 0.5 * height * np.sin(theta)

rtheta = np.radians(angle)
R = np.array([
    [np.cos(rtheta), -np.sin(rtheta)],
    [np.sin(rtheta),  np.cos(rtheta)],
    ])

x, y = np.dot(R, np.array([x, y]))

```

```
x += xcenter
y += ycenter

fig = plt.figure()
ax = fig.add_subplot(211, aspect='auto')
ax.fill(x, y, alpha=0.2, facecolor='yellow', edgecolor='yellow', linewidth=1, zorder=1)

e1 = patches.Ellipse((xcenter, ycenter), width, height,
                    angle=angle, linewidth=2, fill=False, zorder=2)

ax.add_patch(e1)

ax = fig.add_subplot(212, aspect='equal')
ax.fill(x, y, alpha=0.2, facecolor='green', edgecolor='green', zorder=1)
e2 = patches.Ellipse((xcenter, ycenter), width, height,
                    angle=angle, linewidth=2, fill=False, zorder=2)

ax.add_patch(e2)

#fig.savefig('ellipse_compare.png')
fig.savefig('ellipse_compare')

fig = plt.figure()
ax = fig.add_subplot(211, aspect='auto')
ax.fill(x, y, alpha=0.2, facecolor='yellow', edgecolor='yellow', linewidth=1, zorder=1)

e1 = patches.Arc((xcenter, ycenter), width, height,
                angle=angle, linewidth=2, fill=False, zorder=2)

ax.add_patch(e1)

ax = fig.add_subplot(212, aspect='equal')
ax.fill(x, y, alpha=0.2, facecolor='green', edgecolor='green', zorder=1)
e2 = patches.Arc((xcenter, ycenter), width, height,
                angle=angle, linewidth=2, fill=False, zorder=2)

ax.add_patch(e2)

#fig.savefig('arc_compare.png')
fig.savefig('arc_compare')

plt.show()
```

Keywords: python, matplotlib, pylab, example, codex (see [Search examples](#))

111.7 units example code: evans_test.py

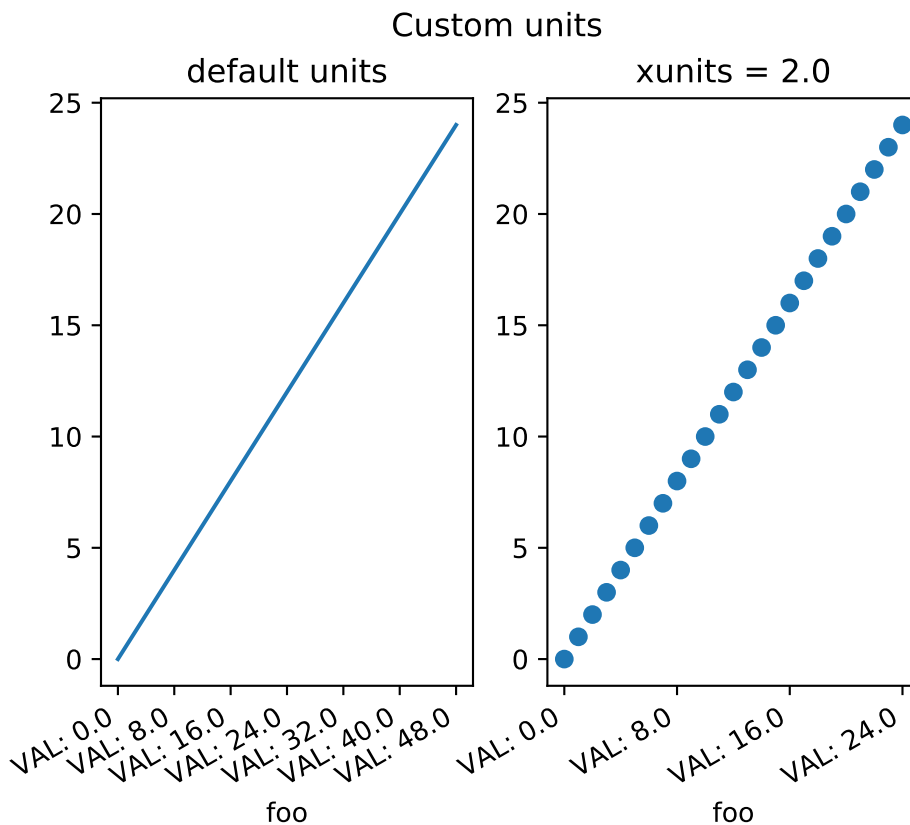

```

"""
=====
Evans test
=====

A mockup "Foo" units class which supports
conversion and different tick formatting depending on the "unit".
Here the "unit" is just a scalar conversion factor, but this example shows mpl
is entirely agnostic to what kind of units client packages use.

"""
from matplotlib.cbook import iterable
import matplotlib.units as units
import matplotlib.ticker as ticker
import matplotlib.pyplot as plt

class Foo(object):
    def __init__(self, val, unit=1.0):
        self.unit = unit
        self._val = val * unit

```

```

def value(self, unit):
    if unit is None:
        unit = self.unit
    return self._val / unit

class FooConverter(object):
    @staticmethod
    def axisinfo(unit, axis):
        'return the Foo AxisInfo'
        if unit == 1.0 or unit == 2.0:
            return units.AxisInfo(
                majloc=ticker.IndexLocator(8, 0),
                majfmt=ticker.FormatStrFormatter("VAL: %s"),
                label='foo',
            )

        else:
            return None

    @staticmethod
    def convert(obj, unit, axis):
        """
        convert obj using unit.  If obj is a sequence, return the
        converted sequence
        """
        if units.ConversionInterface.is_numlike(obj):
            return obj

        if iterable(obj):
            return [o.value(unit) for o in obj]
        else:
            return obj.value(unit)

    @staticmethod
    def default_units(x, axis):
        'return the default unit for x or None'
        if iterable(x):
            for thisx in x:
                return thisx.unit
        else:
            return x.unit

units.registry[Foo] = FooConverter()

# create some Foos
x = []
for val in range(0, 50, 2):
    x.append(Foo(val, 1.0))

# and some arbitrary y data
y = [i for i in range(len(x))]

```

```
# plot specifying units
fig = plt.figure()
fig.suptitle("Custom units")
fig.subplots_adjust(bottom=0.2)
ax = fig.add_subplot(1, 2, 2)
ax.plot(x, y, 'o', xunits=2.0)
for label in ax.get_xticklabels():
    label.set_rotation(30)
    label.set_ha('right')
ax.set_title("xunits = 2.0")

# plot without specifying units; will use the None branch for axisinfo
ax = fig.add_subplot(1, 2, 1)
ax.plot(x, y) # uses default units
ax.set_title('default units')
for label in ax.get_xticklabels():
    label.set_rotation(30)
    label.set_ha('right')

plt.show()
```

Keywords: python, matplotlib, pylab, example, codex (see [Search examples](#))

111.8 units example code: radian_demo.py

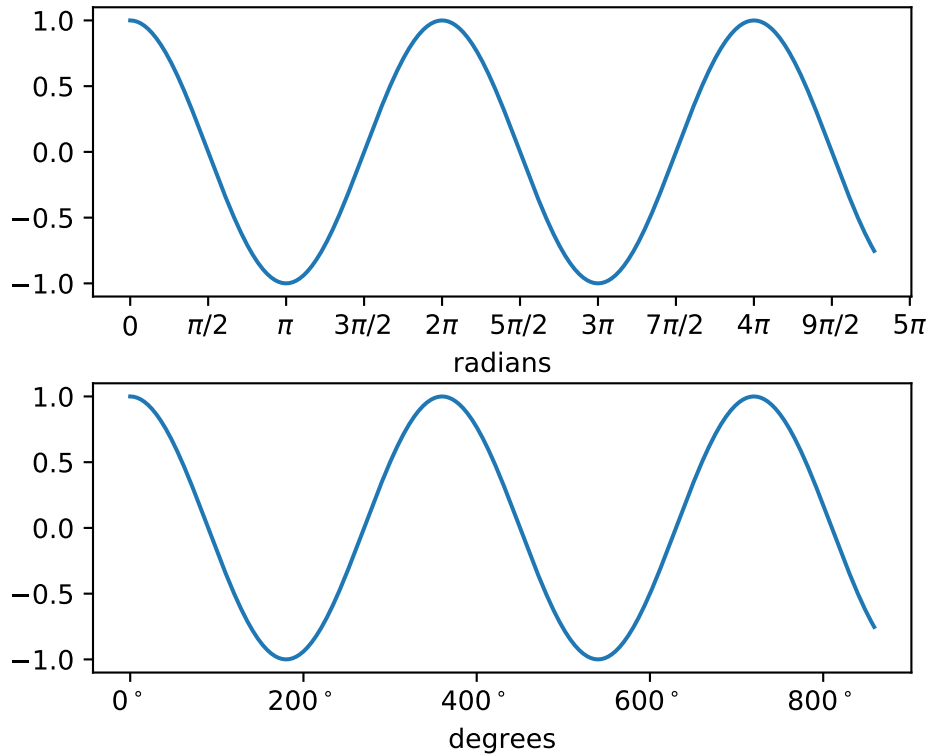

```

"""
=====
Radian ticks
=====

Plot with radians from the basic_units mockup example package.

This example shows how the unit class can determine the tick locating,
formatting and axis labeling.
"""
import numpy as np
from basic_units import radians, degrees, cos
from matplotlib.pyplot import figure, show

x = [val*radians for val in np.arange(0, 15, 0.01)]

fig = figure()
fig.subplots_adjust(hspace=0.3)

ax = fig.add_subplot(211)
line1, = ax.plot(x, cos(x), xunits=radians)

```

```
ax = fig.add_subplot(212)
line2, = ax.plot(x, cos(x), xunits=degrees)

show()
```

Keywords: python, matplotlib, pylab, example, codex (see *Search examples*)

111.9 units example code: units_sample.py

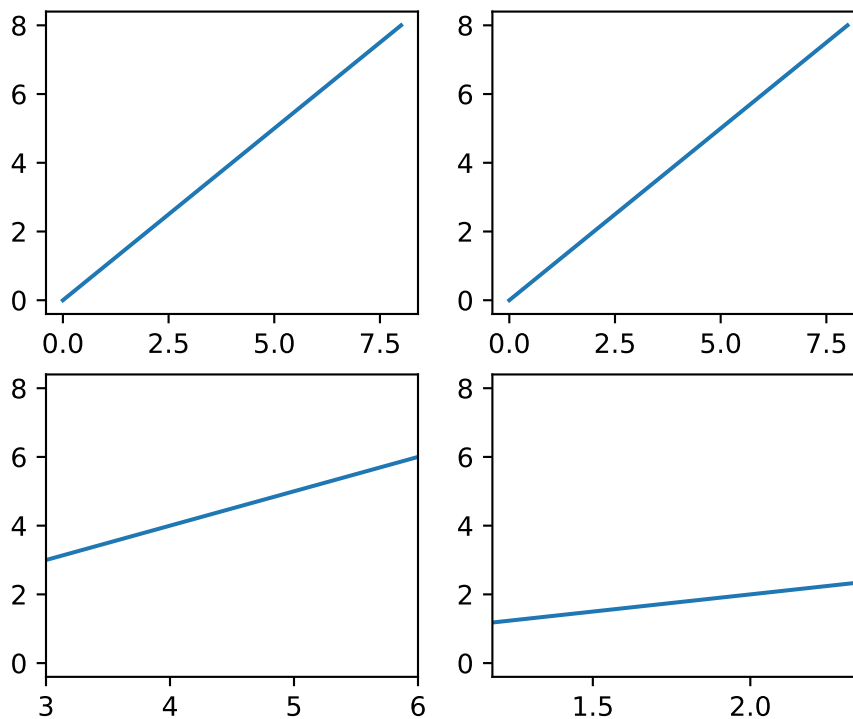

```
"""
=====
Inches and Centimeters
=====

The example illustrates the ability to override default x and y units (ax1) to
inches and centimeters using the `xunits` and `yunits` parameters for the
`plot` function. Note that conversions are applied to get numbers to correct
units.

"""
from basic_units import cm, inch
import matplotlib.pyplot as plt
```



```
import numpy

cms = cm * numpy.arange(0, 10, 2)

fig = plt.figure()

ax1 = fig.add_subplot(2, 2, 1)
ax1.plot(cms, cms)

ax2 = fig.add_subplot(2, 2, 2)
ax2.plot(cms, cms, xunits=cm, yunits=inch)

ax3 = fig.add_subplot(2, 2, 3)
ax3.plot(cms, cms, xunits=inch, yunits=cm)
ax3.set_xlim(3, 6) # scalars are interpreted in current units

ax4 = fig.add_subplot(2, 2, 4)
ax4.plot(cms, cms, xunits=inch, yunits=inch)
ax4.set_xlim(3*cm, 6*cm) # cm are converted to inches

plt.show()
```

Keywords: python, matplotlib, pylab, example, codex (see [Search examples](#))

111.10 units example code: units_scatter.py

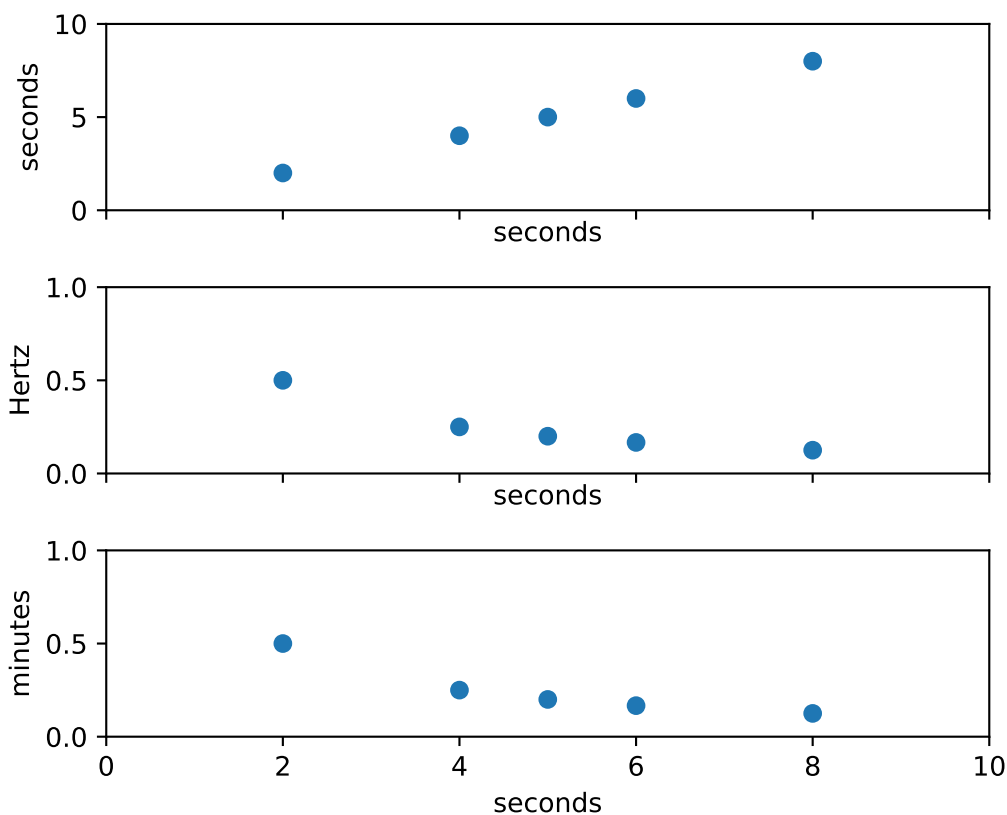

```

"""
=====
Unit handling
=====

basic_units is a mockup of a true units package used for testing
purposed, which illustrates the basic interface that a units package
must provide to matplotlib.

The example below shows support for unit conversions over masked
arrays.
"""
import numpy as np
import matplotlib.pyplot as plt
from basic_units import secs, hertz, minutes

# create masked array
data = (1, 2, 3, 4, 5, 6, 7, 8)
mask = (1, 0, 1, 0, 0, 0, 1, 0)
xsecs = secs * np.ma.MaskedArray(data, mask, float)

fig, (ax1, ax2, ax3) = plt.subplots(nrows=3, sharex=True)

```

```
ax1.scatter(xsecs, xsecs)
ax1.yaxis.set_units(secs)
ax1.axis([0, 10, 0, 10])

ax2.scatter(xsecs, xsecs, yunits=hertz)
ax2.axis([0, 10, 0, 1])

ax3.scatter(xsecs, xsecs, yunits=hertz)
ax3.yaxis.set_units(minutes)
ax3.axis([0, 10, 0, 1])

fig.tight_layout()
plt.show()
```

Keywords: python, matplotlib, pylab, example, codex (see [Search examples](#))

USER_INTERFACES EXAMPLES

112.1 user_interfaces example code: embedding_in_gtk.py

[source code]

```
"""
show how to add a matplotlib FigureCanvasGTK or FigureCanvasGTKAgg widget to a
gtk.Window
"""

import gtk

from matplotlib.figure import Figure
from numpy import arange, sin, pi

# uncomment to select /GTK/GTKAgg/GTKCairo
#from matplotlib.backends.backend_gtk import FigureCanvasGTK as FigureCanvas
from matplotlib.backends.backend_gtkagg import FigureCanvasGTKAgg as FigureCanvas
#from matplotlib.backends.backend_gtkcairo import FigureCanvasGTKCairo as FigureCanvas

win = gtk.Window()
win.connect("destroy", lambda x: gtk.main_quit())
win.set_default_size(400, 300)
win.set_title("Embedding in GTK")

f = Figure(figsize=(5, 4), dpi=100)
a = f.add_subplot(111)
t = arange(0.0, 3.0, 0.01)
s = sin(2*pi*t)
a.plot(t, s)

canvas = FigureCanvas(f) # a gtk.DrawingArea
win.add(canvas)

win.show_all()
gtk.main()
```

Keywords: python, matplotlib, pylab, example, codex (see [Search examples](#))

112.2 user_interfaces example code: embedding_in_gtk2.py

[source code]

```

"""
show how to add a matplotlib FigureCanvasGTK or FigureCanvasGTKAgg widget and
a toolbar to a gtk.Window
"""
import gtk

from matplotlib.figure import Figure
from numpy import arange, sin, pi

# uncomment to select /GTK/GTKAgg/GTKCairo
#from matplotlib.backends.backend_gtk import FigureCanvasGTK as FigureCanvas
from matplotlib.backends.backend_gtkagg import FigureCanvasGTKAgg as FigureCanvas
#from matplotlib.backends.backend_gtkcairo import FigureCanvasGTKCairo as FigureCanvas

# or NavigationToolbar for classic
#from matplotlib.backends.backend_gtk import NavigationToolbar2GTK as NavigationToolbar
from matplotlib.backends.backend_gtkagg import NavigationToolbar2GTKAgg as
NavigationToolbar

# implement the default mpl key bindings
from matplotlib.backend_bases import key_press_handler

win = gtk.Window()
win.connect("destroy", lambda x: gtk.main_quit())
win.set_default_size(400, 300)
win.set_title("Embedding in GTK")

vbox = gtk.VBox()
win.add(vbox)

fig = Figure(figsize=(5, 4), dpi=100)
ax = fig.add_subplot(111)
t = arange(0.0, 3.0, 0.01)
s = sin(2*pi*t)

ax.plot(t, s)

canvas = FigureCanvas(fig) # a gtk.DrawingArea
vbox.pack_start(canvas)
toolbar = NavigationToolbar(canvas, win)
vbox.pack_start(toolbar, False, False)

def on_key_event(event):
    print('you pressed %s' % event.key)
    key_press_handler(event, canvas, toolbar)

canvas.mpl_connect('key_press_event', on_key_event)

```

```
win.show_all()
gtk.main()
```

Keywords: python, matplotlib, pylab, example, codex (see [Search examples](#))

112.3 user_interfaces example code: embedding_in_gtk3.py

[source code]

```
"""
demonstrate adding a FigureCanvasGTK3Agg widget to a Gtk.ScrolledWindow
using GTK3 accessed via pygobject
"""

from gi.repository import Gtk

from matplotlib.figure import Figure
from numpy import arange, sin, pi
from matplotlib.backends.backend_gtk3agg import FigureCanvasGTK3Agg as FigureCanvas

win = Gtk.Window()
win.connect("delete-event", Gtk.main_quit)
win.set_default_size(400, 300)
win.set_title("Embedding in GTK")

f = Figure(figsize=(5, 4), dpi=100)
a = f.add_subplot(111)
t = arange(0.0, 3.0, 0.01)
s = sin(2*pi*t)
a.plot(t, s)

sw = Gtk.ScrolledWindow()
win.add(sw)
# A scrolled window border goes outside the scrollbars and viewport
sw.set_border_width(10)

canvas = FigureCanvas(f) # a Gtk.DrawingArea
canvas.set_size_request(800, 600)
sw.add_with_viewport(canvas)

win.show_all()
Gtk.main()
```

Keywords: python, matplotlib, pylab, example, codex (see [Search examples](#))

112.4 user_interfaces example code: embedding_in_gtk3_panzoom.py

[source code]

```
"""
demonstrate NavigationToolbar with GTK3 accessed via pygobject
"""

from gi.repository import Gtk

from matplotlib.figure import Figure
from numpy import arange, sin, pi
from matplotlib.backends.backend_gtk3agg import FigureCanvasGTK3Agg as FigureCanvas
from matplotlib.backends.backend_gtk3 import NavigationToolbar2GTK3 as NavigationToolbar

win = Gtk.Window()
win.connect("delete-event", Gtk.main_quit)
win.set_default_size(400, 300)
win.set_title("Embedding in GTK")

f = Figure(figsize=(5, 4), dpi=100)
a = f.add_subplot(1, 1, 1)
t = arange(0.0, 3.0, 0.01)
s = sin(2*pi*t)
a.plot(t, s)

vbox = Gtk.VBox()
win.add(vbox)

# Add canvas to vbox
canvas = FigureCanvas(f) # a Gtk.DrawingArea
vbox.pack_start(canvas, True, True, 0)

# Create toolbar
toolbar = NavigationToolbar(canvas, win)
vbox.pack_start(toolbar, False, False, 0)

win.show_all()
Gtk.main()
```

Keywords: python, matplotlib, pylab, example, codex (see [Search examples](#))

112.5 user_interfaces example code: embedding_in_qt4.py

[source code]

```
# embedding_in_qt4.py --- Simple Qt4 application embedding matplotlib canvases
#
# Copyright (C) 2005 Florent Rougon
#           2006 Darren Dale
#
# This file is an example program for matplotlib. It may be used and
# modified with no restriction; raw copies as well as modified versions
# may be distributed without limitation.
```



```

from __future__ import unicode_literals
import sys
import os
import random
from matplotlib.backends import qt_compat
use_pyside = qt_compat.QT_API == qt_compat.QT_API_PYSIDE
if use_pyside:
    from PySide import QtGui, QtCore
else:
    from PyQt4 import QtGui, QtCore

from numpy import arange, sin, pi
from matplotlib.backends.backend_qt4agg import FigureCanvasQTAgg as FigureCanvas
from matplotlib.figure import Figure

progname = os.path.basename(sys.argv[0])
progversion = "0.1"

class MyMplCanvas(FigureCanvas):
    """Ultimately, this is a QWidget (as well as a FigureCanvasAgg, etc.)."""

    def __init__(self, parent=None, width=5, height=4, dpi=100):
        fig = Figure(figsize=(width, height), dpi=dpi)
        self.axes = fig.add_subplot(111)

        self.compute_initial_figure()

        FigureCanvas.__init__(self, fig)
        self.setParent(parent)

        FigureCanvas.setSizePolicy(self,
                                   QtGui.QSizePolicy.Expanding,
                                   QtGui.QSizePolicy.Expanding)
        FigureCanvas.updateGeometry(self)

    def compute_initial_figure(self):
        pass

class MyStaticMplCanvas(MyMplCanvas):
    """Simple canvas with a sine plot."""

    def compute_initial_figure(self):
        t = arange(0.0, 3.0, 0.01)
        s = sin(2*pi*t)
        self.axes.plot(t, s)

class MyDynamicMplCanvas(MyMplCanvas):
    """A canvas that updates itself every second with a new plot."""

    def __init__(self, *args, **kwargs):

```

```

MyMplCanvas.__init__(self, *args, **kwargs)
timer = QtCore.QTimer(self)
timer.timeout.connect(self.update_figure)
timer.start(1000)

def compute_initial_figure(self):
    self.axes.plot([0, 1, 2, 3], [1, 2, 0, 4], 'r')

def update_figure(self):
    # Build a list of 4 random integers between 0 and 10 (both inclusive)
    l = [random.randint(0, 10) for i in range(4)]
    self.axes.cla()
    self.axes.plot([0, 1, 2, 3], l, 'r')
    self.draw()

class ApplicationWindow(QtGui.QMainWindow):
    def __init__(self):
        QtGui.QMainWindow.__init__(self)
        self.setAttribute(QtCore.Qt.WA_DeleteOnClose)
        self.setWindowTitle("application main window")

        self.file_menu = QtGui.QMenu('&File', self)
        self.file_menu.addAction('&Quit', self.fileQuit,
                                   QtCore.Qt.CTRL + QtCore.Qt.Key_Q)
        self.menuBar().addMenu(self.file_menu)

        self.help_menu = QtGui.QMenu('&Help', self)
        self.menuBar().addSeparator()
        self.menuBar().addMenu(self.help_menu)

        self.help_menu.addAction('&About', self.about)

        self.main_widget = QtGui.QWidget(self)

        l = QtGui.QVBoxLayout(self.main_widget)
        sc = MyStaticMplCanvas(self.main_widget, width=5, height=4, dpi=100)
        dc = MyDynamicMplCanvas(self.main_widget, width=5, height=4, dpi=100)
        l.addWidget(sc)
        l.addWidget(dc)

        self.main_widget.setFocus()
        self.setCentralWidget(self.main_widget)

        self.statusBar().showMessage("All hail matplotlib!", 2000)

    def fileQuit(self):
        self.close()

    def closeEvent(self, ce):
        self.fileQuit()

    def about(self):

```

```

        QtGui.QMessageBox.about(self, "About",
                                """embedding_in_qt4.py example
Copyright 2005 Florent Rougon, 2006 Darren Dale

This program is a simple example of a Qt4 application embedding matplotlib
canvases.

It may be used and modified with no restriction; raw copies as well as
modified versions may be distributed without limitation."""
        )

qApp = QtGui.QApplication(sys.argv)

aw = ApplicationWindow()
aw.setWindowTitle("%s" % progname)
aw.show()
sys.exit(qApp.exec_())
#qApp.exec_()

```

Keywords: python, matplotlib, pylab, example, codex (see [Search examples](#))

112.6 user_interfaces example code: embedding_in_qt4_wtoolbar.py

[source code]

```

from __future__ import print_function

import sys

import numpy as np
from matplotlib.figure import Figure
from matplotlib.backend_bases import key_press_handler
from matplotlib.backends.backend_qt4agg import (
    FigureCanvasQTAgg as FigureCanvas,
    NavigationToolbar2QT as NavigationToolbar)
from matplotlib.backends import qt4_compat
use_pyside = qt4_compat.QT_API == qt4_compat.QT_API_PYSIDE

if use_pyside:
    from PySide.QtCore import *
    from PySide.QtGui import *
else:
    from PyQt4.QtCore import *
    from PyQt4.QtGui import *

class AppForm(QMainWindow):
    def __init__(self, parent=None):
        QMainWindow.__init__(self, parent)
        #self.x, self.y = self.get_data()

```

```

self.data = self.get_data2()
self.create_main_frame()
self.on_draw()

def create_main_frame(self):
    self.main_frame = QWidget()

    self.fig = Figure((5.0, 4.0), dpi=100)
    self.canvas = FigureCanvas(self.fig)
    self.canvas.setParent(self.main_frame)
    self.canvas.setFocusPolicy(Qt.StrongFocus)
    self.canvas.setFocus()

    self.mpl_toolbar = NavigationToolbar(self.canvas, self.main_frame)

    self.canvas.mpl_connect('key_press_event', self.on_key_press)

    vbox = QVBoxLayout()
    vbox.addWidget(self.canvas) # the matplotlib canvas
    vbox.addWidget(self.mpl_toolbar)
    self.main_frame.setLayout(vbox)
    self.setCentralWidget(self.main_frame)

def get_data2(self):
    return np.arange(20).reshape([4, 5]).copy()

def on_draw(self):
    self.fig.clear()
    self.axes = self.fig.add_subplot(111)
    #self.axes.plot(self.x, self.y, 'ro')
    self.axes.imshow(self.data, interpolation='nearest')
    #self.axes.plot([1,2,3])
    self.canvas.draw()

def on_key_press(self, event):
    print('you pressed', event.key)
    # implement the default mpl key press events described at
    # http://matplotlib.org/users/navigation_toolbar.html#navigation-keyboard-
↳shortcuts
    key_press_handler(event, self.canvas, self.mpl_toolbar)

def main():
    app = QApplication(sys.argv)
    form = AppForm()
    form.show()
    app.exec_()

if __name__ == "__main__":
    main()

```

Keywords: python, matplotlib, pylab, example, codex (see *Search examples*)

112.7 user_interfaces example code: embedding_in_qt5.py

[source code]

```
# embedding_in_qt5.py --- Simple Qt5 application embedding matplotlib canvases
#
# Copyright (C) 2005 Florent Rougon
#           2006 Darren Dale
#           2015 Jens H Nielsen
#
# This file is an example program for matplotlib. It may be used and
# modified with no restriction; raw copies as well as modified versions
# may be distributed without limitation.

from __future__ import unicode_literals
import sys
import os
import random
import matplotlib
# Make sure that we are using QT5
matplotlib.use('Qt5Agg')
from PyQt5 import QtCore, QtWidgets

from numpy import arange, sin, pi
from matplotlib.backends.backend_qt5agg import FigureCanvasQTAgg as FigureCanvas
from matplotlib.figure import Figure

progrname = os.path.basename(sys.argv[0])
progverson = "0.1"

class MyMplCanvas(FigureCanvas):
    """Ultimately, this is a QWidget (as well as a FigureCanvasAgg, etc.)."""

    def __init__(self, parent=None, width=5, height=4, dpi=100):
        fig = Figure(figsize=(width, height), dpi=dpi)
        self.axes = fig.add_subplot(111)

        self.compute_initial_figure()

        FigureCanvas.__init__(self, fig)
        self.setParent(parent)

        FigureCanvas.setSizePolicy(self,
                                   QtWidgets.QSizePolicy.Expanding,
                                   QtWidgets.QSizePolicy.Expanding)
        FigureCanvas.updateGeometry(self)

    def compute_initial_figure(self):
        pass

class MyStaticMplCanvas(MyMplCanvas):
```

```

"""Simple canvas with a sine plot."""

def compute_initial_figure(self):
    t = arange(0.0, 3.0, 0.01)
    s = sin(2*pi*t)
    self.axes.plot(t, s)

class MyDynamicMplCanvas(MyMplCanvas):
    """A canvas that updates itself every second with a new plot."""

    def __init__(self, *args, **kwargs):
        MyMplCanvas.__init__(self, *args, **kwargs)
        timer = QtCore.QTimer(self)
        timer.timeout.connect(self.update_figure)
        timer.start(1000)

    def compute_initial_figure(self):
        self.axes.plot([0, 1, 2, 3], [1, 2, 0, 4], 'r')

    def update_figure(self):
        # Build a list of 4 random integers between 0 and 10 (both inclusive)
        l = [random.randint(0, 10) for i in range(4)]
        self.axes.cla()
        self.axes.plot([0, 1, 2, 3], l, 'r')
        self.draw()

class ApplicationWindow(QtWidgets.QMainWindow):
    def __init__(self):
        QtWidgets.QMainWindow.__init__(self)
        self.setAttribute(QtCore.Qt.WA_DeleteOnClose)
        self.setWindowTitle("application main window")

        self.file_menu = QtWidgets.QMenu('&File', self)
        self.file_menu.addAction('&Quit', self.fileQuit,
                                   QtCore.Qt.CTRL + QtCore.Qt.Key_Q)
        self.menuBar().addMenu(self.file_menu)

        self.help_menu = QtWidgets.QMenu('&Help', self)
        self.menuBar().addSeparator()
        self.menuBar().addMenu(self.help_menu)

        self.help_menu.addAction('&About', self.about)

        self.main_widget = QtWidgets.QWidget(self)

        l = QtWidgets.QVBoxLayout(self.main_widget)
        sc = MyStaticMplCanvas(self.main_widget, width=5, height=4, dpi=100)
        dc = MyDynamicMplCanvas(self.main_widget, width=5, height=4, dpi=100)
        l.addWidget(sc)
        l.addWidget(dc)

```

```

self.main_widget.setFocus()
self.setCentralWidget(self.main_widget)

self.statusBar().showMessage("All hail matplotlib!", 2000)

def fileQuit(self):
    self.close()

def closeEvent(self, ce):
    self.fileQuit()

def about(self):
    QtWidgets.QMessageBox.about(self, "About",
        """embedding_in_qt5.py example
Copyright 2005 Florent Rougon, 2006 Darren Dale, 2015 Jens H Nielsen

This program is a simple example of a Qt5 application embedding matplotlib
canvases.

It may be used and modified with no restriction; raw copies as well as
modified versions may be distributed without limitation.

This is modified from the embedding in qt4 example to show the difference
between qt4 and qt5""")
    )

qApp = QtWidgets.QApplication(sys.argv)

aw = ApplicationWindow()
aw.setWindowTitle("%s" % progname)
aw.show()
sys.exit(qApp.exec_())
#qApp.exec_()

```

Keywords: python, matplotlib, pylab, example, codex (see [Search examples](#))

112.8 user_interfaces example code: embedding_in_tk.py

[source code]

```

import matplotlib
matplotlib.use('TkAgg')

from numpy import arange, sin, pi
from matplotlib.backends.backend_tkagg import FigureCanvasTkAgg, NavigationToolbar2TkAgg
# implement the default mpl key bindings
from matplotlib.backend_bases import key_press_handler

from matplotlib.figure import Figure

```

```
import sys
if sys.version_info[0] < 3:
    import Tkinter as Tk
else:
    import tkinter as Tk

root = Tk.Tk()
root.wm_title("Embedding in TK")

f = Figure(figsize=(5, 4), dpi=100)
a = f.add_subplot(111)
t = arange(0.0, 3.0, 0.01)
s = sin(2*pi*t)

a.plot(t, s)

# a tk.DrawingArea
canvas = FigureCanvasTkAgg(f, master=root)
canvas.show()
canvas.get_tk_widget().pack(side=Tk.TOP, fill=Tk.BOTH, expand=1)

toolbar = NavigationToolbar2TkAgg(canvas, root)
toolbar.update()
canvas._tkcanvas.pack(side=Tk.TOP, fill=Tk.BOTH, expand=1)

def on_key_event(event):
    print('you pressed %s' % event.key)
    key_press_handler(event, canvas, toolbar)

canvas.mpl_connect('key_press_event', on_key_event)

def _quit():
    root.quit()      # stops mainloop
    root.destroy()  # this is necessary on Windows to prevent
                    # Fatal Python Error: PyEval_RestoreThread: NULL tstate

button = Tk.Button(master=root, text='Quit', command=_quit)
button.pack(side=Tk.BOTTOM)

Tk.mainloop()
# If you put root.destroy() here, it will cause an error if
# the window is closed with the window manager.
```

Keywords: python, matplotlib, pylab, example, codex (see [Search examples](#))

112.9 user_interfaces example code: embedding_in_tk2.py

[source code]

```
import matplotlib
matplotlib.use('TkAgg')

from numpy import arange, sin, pi
from matplotlib.backends.backend_tkagg import FigureCanvasTkAgg
from matplotlib.figure import Figure

import sys
if sys.version_info[0] < 3:
    import Tkinter as Tk
else:
    import tkinter as Tk

def destroy(e):
    sys.exit()

root = Tk.Tk()
root.wm_title("Embedding in TK")

f = Figure(figsize=(5, 4), dpi=100)
a = f.add_subplot(111)
t = arange(0.0, 3.0, 0.01)
s = sin(2*pi*t)

a.plot(t, s)
a.set_title('Tk embedding')
a.set_xlabel('X axis label')
a.set_ylabel('Y label')

# a tk.DrawingArea
canvas = FigureCanvasTkAgg(f, master=root)
canvas.show()
canvas.get_tk_widget().pack(side=Tk.TOP, fill=Tk.BOTH, expand=1)

canvas._tkcanvas.pack(side=Tk.TOP, fill=Tk.BOTH, expand=1)

button = Tk.Button(master=root, text='Quit', command=sys.exit)
button.pack(side=Tk.BOTTOM)

Tk.mainloop()
```

Keywords: python, matplotlib, pylab, example, codex (see [Search examples](#))

112.10 user_interfaces example code: embedding_in_tk_canvas.py

[source code]

```

# -*- noplots -*-

import matplotlib as mpl
import numpy as np
import sys
if sys.version_info[0] < 3:
    import Tkinter as tk
else:
    import tkinter as tk
import matplotlib.backends.tkagg as tkagg
from matplotlib.backends.backend_agg import FigureCanvasAgg

def draw_figure(canvas, figure, loc=(0, 0)):
    """ Draw a matplotlib figure onto a Tk canvas

    loc: location of top-left corner of figure on canvas in pixels.

    Inspired by matplotlib source: lib/matplotlib/backends/backend_tkagg.py
    """
    figure_canvas_agg = FigureCanvasAgg(figure)
    figure_canvas_agg.draw()
    figure_x, figure_y, figure_w, figure_h = figure.bbox.bounds
    figure_w, figure_h = int(figure_w), int(figure_h)
    photo = tk.PhotoImage(master=canvas, width=figure_w, height=figure_h)

    # Position: convert from top-left anchor to center anchor
    canvas.create_image(loc[0] + figure_w/2, loc[1] + figure_h/2, image=photo)

    # Unfortunately, there's no accessor for the pointer to the native renderer
    tkagg.blit(photo, figure_canvas_agg.get_renderer()._renderer, colormode=2)

    # Return a handle which contains a reference to the photo object
    # which must be kept live or else the picture disappears
    return photo

# Create a canvas
w, h = 300, 200
window = tk.Tk()
window.title("A figure in a canvas")
canvas = tk.Canvas(window, width=w, height=h)
canvas.pack()

# Generate some example data
X = np.linspace(0, 2.0*3.14, 50)
Y = np.sin(X)

# Create the figure we desire to add to an existing canvas
fig = mpl.figure.Figure(figsize=(2, 1))

```

```

ax = fig.add_axes([0, 0, 1, 1])
ax.plot(X, Y)

# Keep this handle alive, or else figure will disappear
fig_x, fig_y = 100, 100
fig_photo = draw_figure(canvas, fig, loc=(fig_x, fig_y))
fig_w, fig_h = fig_photo.width(), fig_photo.height()

# Add more elements to the canvas, potentially on top of the figure
canvas.create_line(200, 50, fig_x + fig_w / 2, fig_y + fig_h / 2)
canvas.create_text(200, 50, text="Zero-crossing", anchor="s")

# Let Tk take over
tk.mainloop()

```

Keywords: python, matplotlib, pylab, example, codex (see [Search examples](#))

112.11 user_interfaces example code: embedding_in_wx2.py

[source code]

```

"""
An example of how to use wx or wxagg in an application with the new
toolbar - comment out the setA_toolbar line for no toolbar
"""

# matplotlib requires wxPython 2.8+
# set the wxPython version in lib\site-packages\wx.pth file
# or if you have wxversion installed un-comment the lines below
#import wxversion
#wxversion.ensureMinimal('2.8')

from numpy import arange, sin, pi

import matplotlib

# uncomment the following to use wx rather than wxagg
#matplotlib.use('WX')
#from matplotlib.backends.backend_wx import FigureCanvasWx as FigureCanvas

# comment out the following to use wx rather than wxagg
matplotlib.use('WXagg')
from matplotlib.backends.backend_wxagg import FigureCanvasWxAgg as FigureCanvas

from matplotlib.backends.backend_wx import NavigationToolbar2Wx

from matplotlib.figure import Figure

import wx
import wx.lib.mixins.inspection as WIT

```

```

class CanvasFrame(wx.Frame):
    def __init__(self):
        wx.Frame.__init__(self, None, -1,
                          'CanvasFrame', size=(550, 350))

        self.figure = Figure()
        self.axes = self.figure.add_subplot(111)
        t = arange(0.0, 3.0, 0.01)
        s = sin(2 * pi * t)

        self.axes.plot(t, s)
        self.canvas = FigureCanvas(self, -1, self.figure)

        self.sizer = wx.BoxSizer(wx.VERTICAL)
        self.sizer.Add(self.canvas, 1, wx.LEFT | wx.TOP | wx.EXPAND)
        self.SetSizer(self.sizer)
        self.Fit()

        self.add_toolbar() # comment this out for no toolbar

    def add_toolbar(self):
        self.toolbar = NavigationToolbar2Wx(self.canvas)
        self.toolbar.Realize()
        # By adding toolbar in sizer, we are able to put it at the bottom
        # of the frame - so appearance is closer to GTK version.
        self.sizer.Add(self.toolbar, 0, wx.LEFT | wx.EXPAND)
        # update the axes menu on the toolbar
        self.toolbar.update()

# alternatively you could use
#class App(wx.App):
class App(WIT.InspectableApp):
    def OnInit(self):
        'Create the main window and insert the custom frame'
        self.Init()
        frame = CanvasFrame()
        frame.Show(True)

        return True

app = App(0)
app.MainLoop()

```

Keywords: python, matplotlib, pylab, example, codex (see [Search examples](#))

112.12 user_interfaces example code: embedding_in_wx3.py

[source code]

```

"""
Copyright (C) 2003-2004 Andrew Straw, Jeremy O'Donoghue and others

License: This work is licensed under the PSF. A copy should be included
with this source code, and is also available at
http://www.python.org/psf/license.html

This is yet another example of using matplotlib with wx. Hopefully
this is pretty full-featured:

- both matplotlib toolbar and WX buttons manipulate plot
- full wxApp framework, including widget interaction
- XRC (XML wxWidgets resource) file to create GUI (made with XRCed)

This was derived from embedding_in_wx and dynamic_image_wxagg.

Thanks to matplotlib and wx teams for creating such great software!

"""
from __future__ import print_function

# matplotlib requires wxPython 2.8+
# set the wxPython version in lib\site-packages\wx.pth file
# or if you have wxversion installed un-comment the lines below
#import wxversion
#wxversion.ensureMinimal('2.8')

import sys
import time
import os
import gc
import matplotlib
matplotlib.use('WXAgg')
import matplotlib.cm as cm
import matplotlib.cbook as cbook
from matplotlib.backends.backend_wxagg import Toolbar, FigureCanvasWxAgg
from matplotlib.figure import Figure
import numpy as np

import wx
import wx.xrc as xrc

ERR_TOL = 1e-5 # floating point slop for peak-detection

matplotlib.rc('image', origin='lower')

class PlotPanel(wx.Panel):
    def __init__(self, parent):
        wx.Panel.__init__(self, parent, -1)

        self.fig = Figure((5, 4), 75)

```

```

self.canvas = FigureCanvasWxAgg(self, -1, self.fig)
self.toolbar = Toolbar(self.canvas) # matplotlib toolbar
self.toolbar.Realize()
# self.toolbar.set_active([0,1])

# Now put all into a sizer
sizer = wx.BoxSizer(wx.VERTICAL)
# This way of adding to sizer allows resizing
sizer.Add(self.canvas, 1, wx.LEFT | wx.TOP | wx.GROW)
# Best to allow the toolbar to resize!
sizer.Add(self.toolbar, 0, wx.GROW)
self.SetSizer(sizer)
self.Fit()

def init_plot_data(self):
    a = self.fig.add_subplot(111)

    x = np.arange(120.0) * 2 * np.pi / 60.0
    y = np.arange(100.0) * 2 * np.pi / 50.0
    self.x, self.y = np.meshgrid(x, y)
    z = np.sin(self.x) + np.cos(self.y)
    self.im = a.imshow(z, cmap=cm.RdBu) # , interpolation='nearest')

    zmax = np.amax(z) - ERR_TOL
    ymax_i, xmax_i = np.nonzero(z >= zmax)
    if self.im.origin == 'upper':
        ymax_i = z.shape[0] - ymax_i
    self.lines = a.plot(xmax_i, ymax_i, 'ko')

    self.toolbar.update() # Not sure why this is needed - ADS

def GetToolBar(self):
    # You will need to override GetToolBar if you are using an
    # unmanaged toolbar in your frame
    return self.toolbar

def OnWhiz(self, evt):
    self.x += np.pi / 15
    self.y += np.pi / 20
    z = np.sin(self.x) + np.cos(self.y)
    self.im.set_array(z)

    zmax = np.amax(z) - ERR_TOL
    ymax_i, xmax_i = np.nonzero(z >= zmax)
    if self.im.origin == 'upper':
        ymax_i = z.shape[0] - ymax_i
    self.lines[0].set_data(xmax_i, ymax_i)

    self.canvas.draw()

def onEraseBackground(self, evt):
    # this is supposed to prevent redraw flicker on some X servers...
    pass

```

```

class MyApp(wx.App):
    def OnInit(self):
        xrcfile = cbook.get_sample_data('embedding_in_wx3.xrc',
                                       asfileobj=False)

        print('loading', xrcfile)

        self.res = xrc.XmlResource(xrcfile)

        # main frame and panel -----

        self.frame = self.res.LoadFrame(None, "MainFrame")
        self.panel = xrc.XRCCTRL(self.frame, "MainPanel")

        # matplotlib panel -----

        # container for matplotlib panel (I like to make a container
        # panel for our panel so I know where it'll go when in XRCed.)
        plot_container = xrc.XRCCTRL(self.frame, "plot_container_panel")
        sizer = wx.BoxSizer(wx.VERTICAL)

        # matplotlib panel itself
        self.plotpanel = PlotPanel(plot_container)
        self.plotpanel.init_plot_data()

        # wx boilerplate
        sizer.Add(self.plotpanel, 1, wx.EXPAND)
        plot_container.SetSizer(sizer)

        # whiz button -----
        whiz_button = xrc.XRCCTRL(self.frame, "whiz_button")
        whiz_button.Bind(wx.EVT_BUTTON, self.plotpanel.OnWhiz)

        # bang button -----
        bang_button = xrc.XRCCTRL(self.frame, "bang_button")
        bang_button.Bind(wx.EVT_BUTTON, self.OnBang)

        # final setup -----
        sizer = self.panel.GetSizer()
        self.frame.Show(1)

        self.SetTopWindow(self.frame)

        return True

    def OnBang(self, event):
        bang_count = xrc.XRCCTRL(self.frame, "bang_count")
        bangs = bang_count.GetValue()
        bangs = int(bangs) + 1
        bang_count.SetValue(str(bangs))

if __name__ == '__main__':

```

```
app = MyApp(0)
app.MainLoop()
```

Keywords: python, matplotlib, pylab, example, codex (see *Search examples*)

112.13 user_interfaces example code: embedding_in_wx4.py

[source code]

```
"""
An example of how to use wx or wxagg in an application with a custom
toolbar
"""

# matplotlib requires wxPython 2.8+
# set the wxPython version in lib\site-packages\wx.pth file
# or if you have wxversion installed un-comment the lines below
#import wxversion
#wxversion.ensureMinimal('2.8')

from numpy import arange, sin, pi

import matplotlib

matplotlib.use('WXAgg')
from matplotlib.backends.backend_wxagg import FigureCanvasWxAgg as FigureCanvas
from matplotlib.backends.backend_wxagg import NavigationToolbar2WxAgg

from matplotlib.backends.backend_wx import _load_bitmap
from matplotlib.figure import Figure
from numpy.random import rand

import wx

class MyNavigationToolbar(NavigationToolbar2WxAgg):
    """
    Extend the default wx toolbar with your own event handlers
    """
    ON_CUSTOM = wx.NewId()

    def __init__(self, canvas, cankill):
        NavigationToolbar2WxAgg.__init__(self, canvas)

        # for simplicity I'm going to reuse a bitmap from wx, you'll
        # probably want to add your own.
        if 'phoenix' in wx.PlatformInfo:
            self.AddTool(self.ON_CUSTOM, 'Click me',
                         _load_bitmap('back.png'),
                         'Activate custom control')
            self.Bind(wx.EVT_TOOL, self._on_custom, id=self.ON_CUSTOM)
```



```

    else:
        self.AddSimpleTool(self.ON_CUSTOM, _load_bitmap('back.png'),
                           'Click me', 'Activate custom control')
        self.Bind(wx.EVT_TOOL, self._on_custom, id=self.ON_CUSTOM)

def _on_custom(self, evt):
    # add some text to the axes in a random location in axes (0,1)
    # coords) with a random color

    # get the axes
    ax = self.canvas.figure.axes[0]

    # generate a random location can color
    x, y = tuple(rand(2))
    rgb = tuple(rand(3))

    # add the text and draw
    ax.text(x, y, 'You clicked me',
            transform=ax.transAxes,
            color=rgb)
    self.canvas.draw()
    evt.Skip()

class CanvasFrame(wx.Frame):
    def __init__(self):
        wx.Frame.__init__(self, None, -1,
                          'CanvasFrame', size=(550, 350))

        self.figure = Figure(figsize=(5, 4), dpi=100)
        self.axes = self.figure.add_subplot(111)
        t = arange(0.0, 3.0, 0.01)
        s = sin(2 * pi * t)

        self.axes.plot(t, s)

        self.canvas = FigureCanvas(self, -1, self.figure)

        self.sizer = wx.BoxSizer(wx.VERTICAL)
        self.sizer.Add(self.canvas, 1, wx.TOP | wx.LEFT | wx.EXPAND)
        # Capture the paint message
        self.Bind(wx.EVT_PAINT, self.OnPaint)

        self.toolbar = MyNavigationToolbar(self.canvas, True)
        self.toolbar.Realize()
        # By adding toolbar in sizer, we are able to put it at the bottom
        # of the frame - so appearance is closer to GTK version.
        self.sizer.Add(self.toolbar, 0, wx.LEFT | wx.EXPAND)

        # update the axes menu on the toolbar
        self.toolbar.update()
        self.SetSizer(self.sizer)
        self.Fit()

```

```

def OnPaint(self, event):
    self.canvas.draw()
    event.Skip()

class App(wx.App):
    def OnInit(self):
        'Create the main window and insert the custom frame'
        frame = CanvasFrame()
        frame.Show(True)

        return True

app = App(0)
app.MainLoop()

```

Keywords: python, matplotlib, pylab, example, codex (see [Search examples](#))

112.14 user_interfaces example code: embedding_in_wx5.py

[source code]

```

# matplotlib requires wxPython 2.8+
# set the wxPython version in lib\site-packages\wx.pth file
# or if you have wxversion installed un-comment the lines below
#import wxversion
#wxversion.ensureMinimal('2.8')

import wx
import wx.lib.mixins.inspection as wit

if 'phoenix' in wx.PlatformInfo:
    import wx.lib.agw.aui as aui
else:
    import wx.aui as aui

import matplotlib as mpl
from matplotlib.backends.backend_wxagg import FigureCanvasWxAgg as Canvas
from matplotlib.backends.backend_wxagg import NavigationToolbar2Wx as Toolbar

class Plot(wx.Panel):
    def __init__(self, parent, id=-1, dpi=None, **kwargs):
        wx.Panel.__init__(self, parent, id=id, **kwargs)
        self.figure = mpl.figure.Figure(dpi=dpi, figsize=(2, 2))
        self.canvas = Canvas(self, -1, self.figure)
        self.toolbar = Toolbar(self.canvas)
        self.toolbar.Realize()

        sizer = wx.BoxSizer(wx.VERTICAL)

```

```

sizer.Add(self.canvas, 1, wx.EXPAND)
sizer.Add(self.toolbar, 0, wx.LEFT | wx.EXPAND)
self.SetSizer(sizer)

class PlotNotebook(wx.Panel):
    def __init__(self, parent, id=-1):
        wx.Panel.__init__(self, parent, id=id)
        self.nb = aui.AuiNotebook(self)
        sizer = wx.BoxSizer()
        sizer.Add(self.nb, 1, wx.EXPAND)
        self.SetSizer(sizer)

    def add(self, name="plot"):
        page = Plot(self.nb)
        self.nb.AddPage(page, name)
        return page.figure

def demo():
    # alternatively you could use
    #app = wx.App()
    # InspectableApp is a great debug tool, see:
    # http://wiki.wxpython.org/Widget%20Inspection%20Tool
    app = wit.InspectableApp()
    frame = wx.Frame(None, -1, 'Plotter')
    plotter = PlotNotebook(frame)
    axes1 = plotter.add('figure 1').gca()
    axes1.plot([1, 2, 3], [2, 1, 4])
    axes2 = plotter.add('figure 2').gca()
    axes2.plot([1, 2, 3, 4, 5], [2, 1, 4, 2, 3])
    frame.Show()
    app.MainLoop()

if __name__ == "__main__":
    demo()

```

Keywords: python, matplotlib, pylab, example, codex (see *Search examples*)

112.15 user_interfaces example code: embedding_webagg.py

[source code]

```

"""
This example demonstrates how to embed matplotlib WebAgg interactive
plotting in your own web application and framework. It is not
necessary to do all this if you merely want to display a plot in a
browser or use matplotlib's built-in Tornado-based server "on the
side".

The framework being used must support web sockets.

```

```
"""

import io

try:
    import tornado
except ImportError:
    raise RuntimeError("This example requires tornado.")
import tornado.web
import tornado.httpserver
import tornado.ioloop
import tornado.websocket

from matplotlib.backends.backend_webagg_core import (
    FigureManagerWebAgg, new_figure_manager_given_figure)
from matplotlib.figure import Figure

import numpy as np

import json

def create_figure():
    """
    Creates a simple example figure.
    """
    fig = Figure()
    a = fig.add_subplot(111)
    t = np.arange(0.0, 3.0, 0.01)
    s = np.sin(2 * np.pi * t)
    a.plot(t, s)
    return fig

# The following is the content of the web page. You would normally
# generate this using some sort of template facility in your web
# framework, but here we just use Python string formatting.
html_content = """
<html>
<head>
    <!-- TODO: There should be a way to include all of the required javascript
        and CSS so matplotlib can add to the set in the future if it
        needs to. -->
    <link rel="stylesheet" href="_static/css/page.css" type="text/css">
    <link rel="stylesheet" href="_static/css/boilerplate.css" type="text/css" />
    <link rel="stylesheet" href="_static/css/fbm.css" type="text/css" />
    <link rel="stylesheet" href="_static/jquery/css/themes/base/jquery-ui.min.css" >
    <script src="_static/jquery/js/jquery-1.11.3.min.js"></script>
    <script src="_static/jquery/js/jquery-ui.min.js"></script>
    <script src="mpl.js"></script>

</script>

```

```

/* This is a callback that is called when the user saves
   (downloads) a file. Its purpose is really to map from a
   figure and file format to a url in the application. */
function ondownload(figure, format) {
    window.open('download.' + format, '_blank');
};

$(document).ready(
    function() {
        /* It is up to the application to provide a websocket that the figure
           will use to communicate to the server. This websocket object can
           also be a "fake" websocket that underneath multiplexes messages
           from multiple figures, if necessary. */
        var websocket_type = mpl.get_websocket_type();
        var websocket = new websocket_type("%(ws_uri)sws");

        // mpl.figure creates a new figure on the webpage.
        var fig = new mpl.figure(
            // A unique numeric identifier for the figure
            %(fig_id)s,
            // A websocket object (or something that behaves like one)
            websocket,
            // A function called when a file type is selected for download
            ondownload,
            // The HTML element in which to place the figure
            $('div#figure'));
    }
);
</script>

<title>matplotlib</title>
</head>

<body>
    <div id="figure">
    </div>
</body>
</html>
"""

class MyApplication(tornado.web.Application):
    class MainPage(tornado.web.RequestHandler):
        """
        Serves the main HTML page.
        """

        def get(self):
            manager = self.application.manager
            ws_uri = "ws://{req.host}"/".format(req=self.request)
            content = html_content % {
                "ws_uri": ws_uri, "fig_id": manager.num}
            self.write(content)

```

```

class MplJs(tornado.web.RequestHandler):
    """
    Serves the generated matplotlib javascript file. The content
    is dynamically generated based on which toolbar functions the
    user has defined. Call `FigureManagerWebAgg` to get its
    content.
    """

    def get(self):
        self.set_header('Content-Type', 'application/javascript')
        js_content = FigureManagerWebAgg.get_javascript()

        self.write(js_content)

class Download(tornado.web.RequestHandler):
    """
    Handles downloading of the figure in various file formats.
    """

    def get(self, fmt):
        manager = self.application.manager

        mimetypes = {
            'ps': 'application/postscript',
            'eps': 'application/postscript',
            'pdf': 'application/pdf',
            'svg': 'image/svg+xml',
            'png': 'image/png',
            'jpeg': 'image/jpeg',
            'tif': 'image/tiff',
            'emf': 'application/emf'
        }

        self.set_header('Content-Type', mimetypes.get(fmt, 'binary'))

        buff = io.BytesIO()
        manager.canvas.print_figure(buff, format=fmt)
        self.write(buff.getvalue())

class WebSocket(tornado.websocket.WebSocketHandler):
    """
    A websocket for interactive communication between the plot in
    the browser and the server.

    In addition to the methods required by tornado, it is required to
    have two callback methods:

    - ``send_json(json_content)`` is called by matplotlib when
      it needs to send json to the browser. `json_content` is
      a JSON tree (Python dictionary), and it is the responsibility
      of this implementation to encode it as a string to send over
      the socket.
    """

```

```

        - ``send_binary(blob)`` is called to send binary image data
          to the browser.
    """
    supports_binary = True

    def open(self):
        # Register the websocket with the FigureManager.
        manager = self.application.manager
        manager.add_web_socket(self)
        if hasattr(self, 'set_nodelay'):
            self.set_nodelay(True)

    def on_close(self):
        # When the socket is closed, deregister the websocket with
        # the FigureManager.
        manager = self.application.manager
        manager.remove_web_socket(self)

    def on_message(self, message):
        # The 'supports_binary' message is relevant to the
        # websocket itself. The other messages get passed along
        # to matplotlib as-is.

        # Every message has a "type" and a "figure_id".
        message = json.loads(message)
        if message['type'] == 'supports_binary':
            self.supports_binary = message['value']
        else:
            manager = self.application.manager
            manager.handle_json(message)

    def send_json(self, content):
        self.write_message(json.dumps(content))

    def send_binary(self, blob):
        if self.supports_binary:
            self.write_message(blob, binary=True)
        else:
            data_uri = "data:image/png;base64,{0}".format(
                blob.encode('base64').replace('\n', ''))
            self.write_message(data_uri)

    def __init__(self, figure):
        self.figure = figure
        self.manager = new_figure_manager_given_figure(
            id(figure), figure)

    super(MyApplication, self).__init__(
        # Static files for the CSS and JS
        (r'/_static/(.*)',
         tornado.web.StaticFileHandler,
         {'path': FigureManagerWebAgg.get_static_file_path()}),

```

```

        # The page that contains all of the pieces
        ('/', self.MainPage),

        ('/mpl.js', self.MplJs),

        # Sends images and events to the browser, and receives
        # events from the browser
        ('/ws', self.WebSocket),

        # Handles the downloading (i.e., saving) of static images
        (r'/download.([a-z0-9.]*)', self.Download),
    ])

if __name__ == "__main__":
    figure = create_figure()
    application = MyApplication(figure)

    http_server = tornado.httpserver.HTTPServer(application)
    http_server.listen(8080)

    print("http://127.0.0.1:8080/")
    print("Press Ctrl+C to quit")

    tornado.ioloop.IOLoop.instance().start()

```

Keywords: python, matplotlib, pylab, example, codex (see [Search examples](#))

112.16 user_interfaces example code: fourier_demo_wx.py

[source code]

```

import numpy as np

# matplotlib requires wxPython 2.8+
# set the wxPython version in lib\site-packages\wx.pth file
# or if you have wxversion installed un-comment the lines below
#import wxversion
#wxversion.ensureMinimal('2.8')

import wx
import matplotlib
matplotlib.interactive(False)
matplotlib.use('WXAgg')
from matplotlib.backends.backend_wxagg import FigureCanvasWxAgg
from matplotlib.figure import Figure
from matplotlib.pyplot import gcf, setp

class Knob(object):

```



```

"""
Knob - simple class with a "setKnob" method.
A Knob instance is attached to a Param instance, e.g., param.attach(knob)
Base class is for documentation purposes.
"""

def setKnob(self, value):
    pass

class Param(object):
    """
    The idea of the "Param" class is that some parameter in the GUI may have
    several knobs that both control it and reflect the parameter's state, e.g.
    a slider, text, and dragging can all change the value of the frequency in
    the waveform of this example.
    The class allows a cleaner way to update/"feedback" to the other knobs when
    one is being changed. Also, this class handles min/max constraints for all
    the knobs.
    Idea - knob list - in "set" method, knob object is passed as well
    - the other knobs in the knob list have a "set" method which gets
    called for the others.
    """

    def __init__(self, initialValue=None, minimum=0., maximum=1.):
        self.minimum = minimum
        self.maximum = maximum
        if initialValue != self.constrain(initialValue):
            raise ValueError('illegal initial value')
        self.value = initialValue
        self.knobs = []

    def attach(self, knob):
        self.knobs += [knob]

    def set(self, value, knob=None):
        self.value = value
        self.value = self.constrain(value)
        for feedbackKnob in self.knobs:
            if feedbackKnob != knob:
                feedbackKnob.setKnob(self.value)
        return self.value

    def constrain(self, value):
        if value <= self.minimum:
            value = self.minimum
        if value >= self.maximum:
            value = self.maximum
        return value

class SliderGroup(Knob):
    def __init__(self, parent, label, param):

```

```

self.sliderLabel = wx.StaticText(parent, label=label)
self.sliderText = wx.TextCtrl(parent, -1, style=wx.TE_PROCESS_ENTER)
self.slider = wx.Slider(parent, -1)
# self.slider.SetMax(param.maximum*1000)
self.slider.SetRange(0, param.maximum * 1000)
self.setKnob(param.value)

sizer = wx.BoxSizer(wx.HORIZONTAL)
sizer.Add(self.sliderLabel, 0,
          wx.EXPAND | wx.ALIGN_CENTER | wx.ALL,
          border=2)
sizer.Add(self.sliderText, 0,
          wx.EXPAND | wx.ALIGN_CENTER | wx.ALL,
          border=2)
sizer.Add(self.slider, 1, wx.EXPAND)
self.sizer = sizer

self.slider.Bind(wx.EVT_SLIDER, self.sliderHandler)
self.sliderText.Bind(wx.EVT_TEXT_ENTER, self.sliderTextHandler)

self.param = param
self.param.attach(self)

def sliderHandler(self, evt):
    value = evt.GetInt() / 1000.
    self.param.set(value)

def sliderTextHandler(self, evt):
    value = float(self.sliderText.GetValue())
    self.param.set(value)

def setKnob(self, value):
    self.sliderText.SetValue('%g' % value)
    self.slider.SetValue(value * 1000)

class FourierDemoFrame(wx.Frame):
    def __init__(self, *args, **kwargs):
        wx.Frame.__init__(self, *args, **kwargs)

        self.fourierDemoWindow = FourierDemoWindow(self)
        self.frequencySliderGroup = SliderGroup(
            self,
            label='Frequency f0:',
            param=self.fourierDemoWindow.f0)
        self.amplitudeSliderGroup = SliderGroup(self, label=' Amplitude a:',
                                                param=self.fourierDemoWindow.A)

        sizer = wx.BoxSizer(wx.VERTICAL)
        sizer.Add(self.fourierDemoWindow, 1, wx.EXPAND)
        sizer.Add(self.frequencySliderGroup.sizer, 0,
                  wx.EXPAND | wx.ALIGN_CENTER | wx.ALL, border=5)
        sizer.Add(self.amplitudeSliderGroup.sizer, 0,

```

```

        wx.EXPAND | wx.ALIGN_CENTER | wx.ALL, border=5)
self.SetSizer(sizer)

class FourierDemoWindow(wx.Window, Knob):
    def __init__(self, *args, **kwargs):
        wx.Window.__init__(self, *args, **kwargs)
        self.lines = []
        self.figure = Figure()
        self.canvas = FigureCanvasWxAgg(self, -1, self.figure)
        self.canvas.callbacks.connect('button_press_event', self.mouseDown)
        self.canvas.callbacks.connect('motion_notify_event', self.mouseMotion)
        self.canvas.callbacks.connect('button_release_event', self.mouseUp)
        self.state = ''
        self.mouseInfo = (None, None, None, None)
        self.f0 = Param(2., minimum=0., maximum=6.)
        self.A = Param(1., minimum=0.01, maximum=2.)
        self.draw()

        # Not sure I like having two params attached to the same Knob,
        # but that is what we have here... it works but feels kludgy -
        # although maybe it's not too bad since the knob changes both params
        # at the same time (both f0 and A are affected during a drag)
        self.f0.attach(self)
        self.A.attach(self)
        self.Bind(wx.EVT_SIZE, self.sizeHandler)

        self.Bind(wx.EVT_PAINT, self.OnPaint)

    def OnPaint(self, event):
        self.canvas.draw()
        event.Skip()

    def sizeHandler(self, *args, **kwargs):
        self.canvas.SetSize(self.GetSize())

    def mouseDown(self, evt):
        if self.lines[0] in self.figure.hitlist(evt):
            self.state = 'frequency'
        elif self.lines[1] in self.figure.hitlist(evt):
            self.state = 'time'
        else:
            self.state = ''
        self.mouseInfo = (evt.xdata, evt.ydata,
                         max(self.f0.value, .1),
                         self.A.value)

    def mouseMotion(self, evt):
        if self.state == '':
            return
        x, y = evt.xdata, evt.ydata
        if x is None: # outside the axes
            return

```

```

x0, y0, f0Init, AInit = self.mouseInfo
self.A.set(AInit + (AInit * (y - y0) / y0), self)
if self.state == 'frequency':
    self.f0.set(f0Init + (f0Init * (x - x0) / x0))
elif self.state == 'time':
    if (x - x0) / x0 != -1.:
        self.f0.set(1. / (1. / f0Init + (1. / f0Init * (x - x0) / x0)))

def mouseUp(self, evt):
    self.state = ''

def draw(self):
    if not hasattr(self, 'subplot1'):
        self.subplot1 = self.figure.add_subplot(211)
        self.subplot2 = self.figure.add_subplot(212)
    x1, y1, x2, y2 = self.compute(self.f0.value, self.A.value)
    color = (1., 0., 0.)
    self.lines += self.subplot1.plot(x1, y1, color=color, linewidth=2)
    self.lines += self.subplot2.plot(x2, y2, color=color, linewidth=2)
    # Set some plot attributes
    self.subplot1.set_title(
        "Click and drag waveforms to change frequency and amplitude",
        fontsize=12)
    self.subplot1.set_ylabel("Frequency Domain Waveform X(f)", fontsize=8)
    self.subplot1.set_xlabel("frequency f", fontsize=8)
    self.subplot2.set_ylabel("Time Domain Waveform x(t)", fontsize=8)
    self.subplot2.set_xlabel("time t", fontsize=8)
    self.subplot1.set_xlim([-6, 6])
    self.subplot1.set_ylim([0, 1])
    self.subplot2.set_xlim([-2, 2])
    self.subplot2.set_ylim([-2, 2])
    self.subplot1.text(0.05, .95,
        r'$X(f) = \mathcal{F}\{x(t)\}$',
        verticalalignment='top',
        transform=self.subplot1.transAxes)
    self.subplot2.text(0.05, .95,
        r'$x(t) = a \cdot \cos(2\pi f_0 t) e^{-\pi t^2}$',
        verticalalignment='top',
        transform=self.subplot2.transAxes)

def compute(self, f0, A):
    f = np.arange(-6., 6., 0.02)
    t = np.arange(-2., 2., 0.01)
    x = A * np.cos(2 * np.pi * f0 * t) * np.exp(-np.pi * t ** 2)
    X = A / 2 * \
        (np.exp(-np.pi * (f - f0) ** 2) + np.exp(-np.pi * (f + f0) ** 2))
    return f, X, t, x

def repaint(self):
    self.canvas.draw()

def setKnob(self, value):
    # Note, we ignore value arg here and just go by state of the params

```

```

    x1, y1, x2, y2 = self.compute(self.f0.value, self.A.value)
    setp(self.lines[0], xdata=x1, ydata=y1)
    setp(self.lines[1], xdata=x2, ydata=y2)
    self.repaint()

class App(wx.App):
    def OnInit(self):
        self.frame1 = FourierDemoFrame(parent=None, title="Fourier Demo",
                                       size=(640, 480))

        self.frame1.Show()
        return True

app = App()
app.MainLoop()

```

Keywords: python, matplotlib, pylab, example, codex (see [Search examples](#))

112.17 user_interfaces example code: gtk_spreadsheet.py

[source code]

```

"""
Example of embedding matplotlib in an application and interacting with
a treeview to store data. Double click on an entry to update plot
data
"""

import pygtk
pygtk.require('2.0')
import gtk
from gtk import gdk

import matplotlib
matplotlib.use('GTKAgg') # or 'GTK'
from matplotlib.backends.backend_gtk import FigureCanvasGTK as FigureCanvas

from numpy.random import random
from matplotlib.figure import Figure

class DataManager(gtk.Window):
    numRows, numCols = 20, 10

    data = random((numRows, numCols))

    def __init__(self):
        gtk.Window.__init__(self)
        self.set_default_size(600, 600)
        self.connect('destroy', lambda win: gtk.main_quit())

```

```

self.set_title('GtkListStore demo')
self.set_border_width(8)

vbox = gtk.VBox(False, 8)
self.add(vbox)

label = gtk.Label('Double click a row to plot the data')

vbox.pack_start(label, False, False)

sw = gtk.ScrolledWindow()
sw.set_shadow_type(gtk.SHADOW_ETCHED_IN)
sw.set_policy(gtk.POLICY_NEVER,
              gtk.POLICY_AUTOMATIC)
vbox.pack_start(sw, True, True)

model = self.create_model()

self.treeview = gtk.TreeView(model)
self.treeview.set_rules_hint(True)

# matplotlib stuff
fig = Figure(figsize=(6, 4))

self.canvas = FigureCanvas(fig) # a gtk.DrawingArea
vbox.pack_start(self.canvas, True, True)
ax = fig.add_subplot(111)
self.line, = ax.plot(self.data[0, :], 'go') # plot the first row

self.treeview.connect('row-activated', self.plot_row)
sw.add(self.treeview)

self.add_columns()

self.add_events(gdk.BUTTON_PRESS_MASK |
                gdk.KEY_PRESS_MASK |
                gdk.KEY_RELEASE_MASK)

def plot_row(self, treeview, path, view_column):
    ind, = path # get the index into data
    points = self.data[ind, :]
    self.line.set_ydata(points)
    self.canvas.draw()

def add_columns(self):
    for i in range(self.numCols):
        column = gtk.TreeViewColumn('%d' % i, gtk.CellRendererText(), text=i)
        self.treeview.append_column(column)

def create_model(self):
    types = [float]*self.numCols
    store = gtk.ListStore(*types)

```

```

        for row in self.data:
            store.append(row)
        return store

```

```

manager = DataManager()
manager.show_all()
gtk.main()

```

Keywords: python, matplotlib, pylab, example, codex (see [Search examples](#))

112.18 user_interfaces example code: histogram_demo_canvasagg.py

[source code]

```

"""
This is an example that shows you how to work directly with the agg
figure canvas to create a figure using the pythonic API.

In this example, the contents of the agg canvas are extracted to a
string, which can in turn be passed off to PIL or put in a numeric
array

"""

from matplotlib.backends.backend_agg import FigureCanvasAgg
from matplotlib.figure import Figure
from matplotlib.mlab import normpdf
from numpy.random import randn
import numpy

fig = Figure(figsize=(5, 4), dpi=100)
ax = fig.add_subplot(111)

canvas = FigureCanvasAgg(fig)

mu, sigma = 100, 15
x = mu + sigma*randn(10000)

# the histogram of the data
n, bins, patches = ax.hist(x, 50, normed=1)

# add a 'best fit' line
y = normpdf(bins, mu, sigma)
line, = ax.plot(bins, y, 'r--')
line.set_linewidth(1)

ax.set_xlabel('Smarts')
ax.set_ylabel('Probability')
ax.set_title(r'$\mathrm{Histogram of IQ: } \mu=100, \sigma=15$')

```

```
ax.set_xlim((40, 160))
ax.set_ylim((0, 0.03))

canvas.draw()

s = canvas.tostring_rgb() # save this and convert to bitmap as needed

# get the figure dimensions for creating bitmaps or numpy arrays,
# etc.
l, b, w, h = fig.bbox.bounds
w, h = int(w), int(h)

if 0:
    # convert to a numpy array
    X = numpy.fromstring(s, numpy.uint8)
    X.shape = h, w, 3

if 0:
    # pass off to PIL
    from PIL import Image
    im = Image.fromstring("RGB", (w, h), s)
    im.show()
```

Keywords: python, matplotlib, pylab, example, codex (see *Search examples*)

112.19 user_interfaces example code: interactive.py

[source code]

```
"""Multithreaded interactive interpreter with GTK and Matplotlib support.

WARNING:
As of 2010/06/25, this is not working, at least on Linux.
I have disabled it as a runnable script. - EF

Usage:

  pyint-gtk.py -> starts shell with gtk thread running separately

  pyint-gtk.py -pylab [filename] -> initializes matplotlib, optionally running
  the named file. The shell starts after the file is executed.

Threading code taken from:
http://aspn.activestate.com/ASPN/Cookbook/Python/Recipe/65109, by Brian
McErlean and John Finlay.

Matplotlib support taken from interactive.py in the matplotlib distribution.

Also borrows liberally from code.py in the Python standard library."""
```



```

from __future__ import print_function

__author__ = "Fernando Perez <Fernando.Perez@colorado.edu>"

import sys
import code
import threading

import gobject
import gtk

try:
    import readline
except ImportError:
    has_readline = False
else:
    has_readline = True

class MTConsole(code.InteractiveConsole):
    """Simple multi-threaded shell"""

    def __init__(self, on_kill=None, *args, **kw):
        code.InteractiveConsole.__init__(self, *args, **kw)
        self.code_to_run = None
        self.ready = threading.Condition()
        self._kill = False
        if on_kill is None:
            on_kill = []
        # Check that all things to kill are callable:
        for _ in on_kill:
            if not callable(_):
                raise TypeError('on_kill must be a list of callables')
        self.on_kill = on_kill
        # Set up tab-completer
        if has_readline:
            import rlcompleter
            try: # this form only works with python 2.3
                self.completer = rlcompleter.Completer(self.locals)
            except: # simpler for py2.2
                self.completer = rlcompleter.Completer()

        readline.set_completer(self.completer.complete)
        # Use tab for completions
        readline.parse_and_bind('tab: complete')
        # This forces readline to automatically print the above list when tab
        # completion is set to 'complete'.
        readline.parse_and_bind('set show-all-if-ambiguous on')
        # Bindings for incremental searches in the history. These searches
        # use the string typed so far on the command line and search
        # anything in the previous input history containing them.
        readline.parse_and_bind('"C-r": reverse-search-history')
        readline.parse_and_bind('"C-s": forward-search-history')

```

```

def runsource(self, source, filename="", symbol="single"):
    """Compile and run some source in the interpreter.

    Arguments are as for compile_command().

    One several things can happen:

    1) The input is incorrect; compile_command() raised an
    exception (SyntaxError or OverflowError). A syntax traceback
    will be printed by calling the showsyntaxerror() method.

    2) The input is incomplete, and more input is required;
    compile_command() returned None. Nothing happens.

    3) The input is complete; compile_command() returned a code
    object. The code is executed by calling self.runcode() (which
    also handles run-time exceptions, except for SystemExit).

    The return value is True in case 2, False in the other cases (unless
    an exception is raised). The return value can be used to
    decide whether to use sys.ps1 or sys.ps2 to prompt the next
    line.
    """
    try:
        code = self.compile(source, filename, symbol)
    except (OverflowError, SyntaxError, ValueError):
        # Case 1
        self.showsyntaxerror(filename)
        return False

    if code is None:
        # Case 2
        return True

    # Case 3
    # Store code in self, so the execution thread can handle it
    self.ready.acquire()
    self.code_to_run = code
    self.ready.wait() # Wait until processed in timeout interval
    self.ready.release()

    return False

def runcode(self):
    """Execute a code object.

    When an exception occurs, self.showtraceback() is called to display a
    traceback. """

    self.ready.acquire()
    if self._kill:
        print('Closing threads...')

```

```

        sys.stdout.flush()
        for tokill in self.on_kill:
            tokill()
        print('Done.')

    if self.code_to_run is not None:
        self.ready.notify()
        code.InteractiveConsole.runcode(self, self.code_to_run)

    self.code_to_run = None
    self.ready.release()
    return True

def kill(self):
    """Kill the thread, returning when it has been shut down."""
    self.ready.acquire()
    self._kill = True
    self.ready.release()

class GTKInterpreter(threading.Thread):
    """Run gtk.main in the main thread and a python interpreter in a
    separate thread.
    Python commands can be passed to the thread where they will be executed.
    This is implemented by periodically checking for passed code using a
    GTK timeout callback.
    """
    TIMEOUT = 100 # Millisecond interval between timeouts.

    def __init__(self, banner=None):
        threading.Thread.__init__(self)
        self.banner = banner
        self.shell = MTConsole(on_kill=[gtk.main_quit])

    def run(self):
        self.pre_interact()
        self.shell.interact(self.banner)
        self.shell.kill()

    def mainloop(self):
        self.start()
        gobject.timeout_add(self.TIMEOUT, self.shell.runcode)
        try:
            if gtk.gtk_version[0] >= 2:
                gtk.gdk.threads_init()
        except AttributeError:
            pass
        gtk.main()
        self.join()

    def pre_interact(self):
        """This method should be overridden by subclasses.

```

*It gets called right before interact(), but after the thread starts.
Typically used to push initialization code into the interpreter"""*

```
pass
```

```
class MatplotlibInterpreter(GTKInterpreter):
```

```
    """Threaded interpreter with matplotlib support.
```

```
    Note that this explicitly sets GTKAgg as the backend, since it has  
    specific GTK hooks in it."""
```

```
    def __init__(self, banner=None):
```

```
        banner = """\nWelcome to matplotlib, a MATLAB-like python environment.  
help(matlab)  -> help on matlab compatible commands from matplotlib.  
help(plotting) -> help on plotting commands.  
"""
```

```
        GTKInterpreter.__init__(self, banner)
```

```
    def pre_interact(self):
```

```
        """Initialize matplotlib before user interaction begins"""
```

```
        push = self.shell.push
```

```
        # Code to execute in user's namespace
```

```
        lines = ["import matplotlib",  
                "matplotlib.use('GTKAgg')",  
                "matplotlib.interactive(1)",  
                "import matplotlib.pyplot as pylab",  
                "from matplotlib.pyplot import *\n"]
```

```
        map(push, lines)
```

```
        # Execute file if given.
```

```
        if len(sys.argv) > 1:
```

```
            import matplotlib
```

```
            matplotlib.interactive(0) # turn off interaction
```

```
            fname = sys.argv[1]
```

```
            try:
```

```
                inFile = file(fname, 'r')
```

```
            except IOError:
```

```
                print('*** ERROR *** Could not read file <%s>' % fname)
```

```
            else:
```

```
                print('*** Executing file <%s>:' % fname)
```

```
                for line in inFile:
```

```
                    if line.rstrip().find('show()') == 0:
```

```
                        continue
```

```
                        print('>>', line)
```

```
                        push(line)
```

```
                    inFile.close()
```

```
            matplotlib.interactive(1) # turn on interaction
```

```
if __name__ == '__main__':
```

```
    print("This demo is not presently functional, so running")
```

```

print("it as a script has been disabled.")
sys.exit()
# Quick sys.argv hack to extract the option and leave filenames in sys.argv.
# For real option handling, use optparse or getopt.
if len(sys.argv) > 1 and sys.argv[1] == '-pylab':
    sys.argv = [sys.argv[0]] + sys.argv[2:]
    MatplotlibInterpreter().mainloop()
else:
    GTKInterpreter().mainloop()

```

Keywords: python, matplotlib, pylab, example, codex (see *Search examples*)

112.20 user_interfaces example code: interactive2.py

[source code]

```

from __future__ import print_function

# GTK Interactive Console
# (C) 2003, Jon Anderson
# See www.python.org/2.2/license.html for
# license details.
#
import gtk
import gtk.gdk

import code
import os
import sys
import pango

import __builtin__
import __main__

banner = """GTK Interactive Python Console
Thanks to Jon Anderson
%s
""" % sys.version

banner += """

Welcome to matplotlib.

    help(matplotlib) -- some general information about matplotlib
    help(plotting) -- shows a list of plot specific commands

"""

class Completer(object):

```

```

"""
Taken from rlcompleter, with readline references stripped, and a local dictionary to_
↪use.
"""

def __init__(self, locals):
    self.locals = locals

def complete(self, text, state):
    """Return the next possible completion for 'text'.
    This is called successively with state == 0, 1, 2, ... until it
    returns None. The completion should begin with 'text'.

    """
    if state == 0:
        if "." in text:
            self.matches = self.attr_matches(text)
        else:
            self.matches = self.global_matches(text)
    try:
        return self.matches[state]
    except IndexError:
        return None

def global_matches(self, text):
    """Compute matches when text is a simple name.

    Return a list of all keywords, built-in functions and names
    currently defines in __main__ that match.

    """
    import keyword
    matches = []
    n = len(text)
    for list in [keyword.kwlist, __builtin__.__dict__.keys(), __main__.__dict__.
↪keys(), self.locals.keys()]:
        for word in list:
            if word[:n] == text and word != "__builtins__":
                matches.append(word)
    return matches

def attr_matches(self, text):
    """Compute matches when text contains a dot.

    Assuming the text is of the form NAME.NAME...[NAME], and is
    evaluatable in the globals of __main__, it will be evaluated
    and its attributes (as revealed by dir()) are used as possible
    completions. (For class instances, class members are also
    considered.)

    WARNING: this can still invoke arbitrary C code, if an object
    with a __getattr__ hook is evaluated.

```

```

"""
import re
m = re.match(r"(\w+(\.\w+)*)\.(\w*)", text)
if not m:
    return
expr, attr = m.group(1, 3)
object = eval(expr, __main__.__dict__, self.locals)
words = dir(object)
if hasattr(object, '__class__'):
    words.append('__class__')
    words = words + get_class_members(object.__class__)
matches = []
n = len(attr)
for word in words:
    if word[:n] == attr and word != "__builtins__":
        matches.append("%s.%s" % (expr, word))
return matches

def get_class_members(klass):
    ret = dir(klass)
    if hasattr(klass, '__bases__'):
        for base in klass.__bases__:
            ret = ret + get_class_members(base)
    return ret

class OutputStream(object):
    """
    A Multiplexing output stream.
    It can replace another stream, and tee output to the original stream and too
    a GTK textview.
    """

    def __init__(self, view, old_out, style):
        self.view = view
        self.buffer = view.get_buffer()
        self.mark = self.buffer.create_mark("End", self.buffer.get_end_iter(), False)
        self.out = old_out
        self.style = style
        self.tee = 1

    def write(self, text):
        if self.tee:
            self.out.write(text)

        end = self.buffer.get_end_iter()

        if self.view is not None:
            self.view.scroll_to_mark(self.mark, 0, True, 1, 1)

        self.buffer.insert_with_tags(end, text, self.style)

```

```

class GTKInterpreterConsole(gtk.ScrolledWindow):
    """
    An InteractiveConsole for GTK. It's an actual widget,
    so it can be dropped in just about anywhere.
    """

    def __init__(self):
        gtk.ScrolledWindow.__init__(self)
        self.set_policy(gtk.POLICY_AUTOMATIC, gtk.POLICY_AUTOMATIC)

        self.text = gtk.TextView()
        self.text.set_wrap_mode(True)

        self.interpreter = code.InteractiveInterpreter()

        self.completer = Completer(self.interpreter.locals)
        self.buffer = []
        self.history = []
        self.banner = banner
        self.ps1 = ">>> "
        self.ps2 = "... "

        self.text.add_events(gtk.gdk.KEY_PRESS_MASK)
        self.text.connect("key_press_event", self.key_pressed)

        self.current_history = -1

        self.mark = self.text.get_buffer().create_mark("End", self.text.get_buffer().get_
↪end_iter(), False)

        # setup colors
        self.style_banner = gtk.TextTag("banner")
        self.style_banner.set_property("foreground", "saddle brown")

        self.style_ps1 = gtk.TextTag("ps1")
        self.style_ps1.set_property("foreground", "DarkOrchid4")
        self.style_ps1.set_property("editable", False)
        self.style_ps1.set_property("font", "courier")

        self.style_ps2 = gtk.TextTag("ps2")
        self.style_ps2.set_property("foreground", "DarkOliveGreen")
        self.style_ps2.set_property("editable", False)
        self.style_ps2.set_property("font", "courier")

        self.style_out = gtk.TextTag("stdout")
        self.style_out.set_property("foreground", "midnight blue")
        self.style_err = gtk.TextTag("stderr")
        self.style_err.set_property("style", pango.STYLE_ITALIC)
        self.style_err.set_property("foreground", "red")

        self.text.get_buffer().get_tag_table().add(self.style_banner)
        self.text.get_buffer().get_tag_table().add(self.style_ps1)

```



```

self.text.get_buffer().get_tag_table().add(self.style_ps2)
self.text.get_buffer().get_tag_table().add(self.style_out)
self.text.get_buffer().get_tag_table().add(self.style_err)

self.stdout = OutputStream(self.text, sys.stdout, self.style_out)
self.stderr = OutputStream(self.text, sys.stderr, self.style_err)

sys.stderr = self.stderr
sys.stdout = self.stdout

self.current_prompt = None

self.write_line(self.banner, self.style_banner)
self.prompt_ps1()

self.add(self.text)
self.text.show()

def reset_history(self):
    self.history = []

def reset_buffer(self):
    self.buffer = []

def prompt_ps1(self):
    self.current_prompt = self.prompt_ps1
    self.write_line(self.ps1, self.style_ps1)

def prompt_ps2(self):
    self.current_prompt = self.prompt_ps2
    self.write_line(self.ps2, self.style_ps2)

def write_line(self, text, style=None):
    start, end = self.text.get_buffer().get_bounds()
    if style is None:
        self.text.get_buffer().insert(end, text)
    else:
        self.text.get_buffer().insert_with_tags(end, text, style)

    self.text.scroll_to_mark(self.mark, 0, True, 1, 1)

def push(self, line):

    self.buffer.append(line)
    if len(line) > 0:
        self.history.append(line)

    source = "\n".join(self.buffer)

    more = self.interpreter.runsource(source, "<<console>>")

    if not more:
        self.reset_buffer()

```

```

    return more

def key_pressed(self, widget, event):
    if event.keyval == gtk.gdk.keyval_from_name('Return'):
        return self.execute_line()

    if event.keyval == gtk.gdk.keyval_from_name('Up'):
        self.current_history = self.current_history - 1
        if self.current_history < - len(self.history):
            self.current_history = - len(self.history)
        return self.show_history()
    elif event.keyval == gtk.gdk.keyval_from_name('Down'):
        self.current_history = self.current_history + 1
        if self.current_history > 0:
            self.current_history = 0
        return self.show_history()
    elif event.keyval == gtk.gdk.keyval_from_name('Home'):
        l = self.text.get_buffer().get_line_count() - 1
        start = self.text.get_buffer().get_iter_at_line_offset(l, 4)
        self.text.get_buffer().place_cursor(start)
        return True
    elif event.keyval == gtk.gdk.keyval_from_name('space') and event.state & gtk.gdk.
↳CONTROL_MASK:
        return self.complete_line()
    return False

def show_history(self):
    if self.current_history == 0:
        return True
    else:
        self.replace_line(self.history[self.current_history])
        return True

def current_line(self):
    start, end = self.current_line_bounds()
    return self.text.get_buffer().get_text(start, end, True)

def current_line_bounds(self):
    txt_buffer = self.text.get_buffer()
    l = txt_buffer.get_line_count() - 1

    start = txt_buffer.get_iter_at_line(l)
    if start.get_chars_in_line() >= 4:
        start.forward_chars(4)
    end = txt_buffer.get_end_iter()
    return start, end

def replace_line(self, txt):
    start, end = self.current_line_bounds()
    self.text.get_buffer().delete(start, end)
    self.write_line(txt)

```

```
def execute_line(self, line=None):
    if line is None:
        line = self.current_line()
        self.write_line("\n")
    else:
        self.write_line(line + "\n")

    more = self.push(line)

    self.text.get_buffer().place_cursor(self.text.get_buffer().get_end_iter())

    if more:
        self.prompt_ps2()
    else:
        self.prompt_ps1()

    self.current_history = 0

    self.window.raise_()

    return True

def complete_line(self):
    line = self.current_line()
    tokens = line.split()
    token = tokens[-1]

    completions = []
    p = self.completer.complete(token, len(completions))
    while p is not None:
        completions.append(p)
        p = self.completer.complete(token, len(completions))

    if len(completions) != 1:
        self.write_line("\n")
        self.write_line("\n".join(completions), self.style_ps1)
        self.write_line("\n")
        self.current_prompt()
        self.write_line(line)
    else:
        i = line.rfind(token)
        line = line[0:i] + completions[0]
        self.replace_line(line)

    return True

def main():
    w = gtk.Window()
    console = GTKInterpreterConsole()
    console.set_size_request(640, 480)
    w.add(console)
```

```

def destroy(arg=None):
    gtk.main_quit()

def key_event(widget, event):
    if gtk.gdk.keyval_name(event.keyval) == 'd' and \
        event.state & gtk.gdk.CONTROL_MASK:
        destroy()
    return False

w.connect("destroy", destroy)

w.add_events(gtk.gdk.KEY_PRESS_MASK)
w.connect('key_press_event', key_event)
w.show_all()

console.execute_line('import matplotlib')
console.execute_line("matplotlib.use('GTKAgg')")
console.execute_line('matplotlib.interactive(1)')
console.execute_line('from pylab import *')

if len(sys.argv) > 1:
    fname = sys.argv[1]
    if not os.path.exists(fname):
        print('%s does not exist' % fname)
    for line in file(fname):
        line = line.strip()

        console.execute_line(line)
gtk.main()

if __name__ == '__main__':
    main()

```

Keywords: python, matplotlib, pylab, example, codex (see [Search examples](#))

112.21 user_interfaces example code: lineprops_dialog_gtk.py

[source code]

```

import matplotlib
matplotlib.use('GTKAgg')
from matplotlib.backends.backend_gtk import DialogLineprops

import numpy as np
import matplotlib.pyplot as plt

def f(t):
    s1 = np.cos(2*np.pi*t)
    e1 = np.exp(-t)
    return np.multiply(s1, e1)

```

```

t1 = np.arange(0.0, 5.0, 0.1)
t2 = np.arange(0.0, 5.0, 0.02)
t3 = np.arange(0.0, 2.0, 0.01)

fig, ax = plt.subplots()
l1, = ax.plot(t1, f(t1), 'bo', label='line 1')
l2, = ax.plot(t2, f(t2), 'k--', label='line 2')

dlg = DialogLineprops([l1, l2])
dlg.show()
plt.show()

```

Keywords: python, matplotlib, pylab, example, codex (see [Search examples](#))

112.22 user_interfaces example code: mathtext_wx.py

[source code]

```

"""
Demonstrates how to convert mathtext to a wx.Bitmap for display in various
controls on wxPython.
"""

import matplotlib
matplotlib.use("WxAgg")
from numpy import arange, sin, pi, cos, log
from matplotlib.backends.backend_wxagg import FigureCanvasWxAgg as FigureCanvas
from matplotlib.backends.backend_wx import NavigationToolbar2Wx, wxc
from matplotlib.figure import Figure

import wx

IS_GTK = 'wxGTK' in wx.PlatformInfo
IS_WIN = 'wxMSW' in wx.PlatformInfo

#####
# This is where the "magic" happens.
from matplotlib.mathtext import MathTextParser
mathtext_parser = MathTextParser("Bitmap")

def mathtext_to_wxbitmap(s):
    ftimage, depth = mathtext_parser.parse(s, 150)
    return wxc.BitmapFromBuffer(
        ftimage.get_width(), ftimage.get_height(),
        ftimage.as_rgba_str())
#####

functions = [
    (r'\$\sin(2 \pi x)$', lambda x: sin(2*pi*x)),

```

```

(r'\frac{4}{3}\pi x^3$', lambda x: (4.0/3.0)*pi*x**3),
(r'\cos(2 \pi x)$', lambda x: cos(2*pi*x)),
(r'\log(x)$', lambda x: log(x))
]

class CanvasFrame(wx.Frame):
    def __init__(self, parent, title):
        wx.Frame.__init__(self, parent, -1, title, size=(550, 350))
        self.SetBackgroundColour(wxc.NamedColour("WHITE"))

        self.figure = Figure()
        self.axes = self.figure.add_subplot(111)

        self.canvas = FigureCanvas(self, -1, self.figure)

        self.change_plot(0)

        self.sizer = wx.BoxSizer(wx.VERTICAL)
        self.add_buttonbar()
        self.sizer.Add(self.canvas, 1, wx.LEFT | wx.TOP | wx.GROW)
        self.add_toolbar() # comment this out for no toolbar

        menuBar = wx.MenuBar()

        # File Menu
        menu = wx.Menu()
        menu.Append(wx.ID_EXIT, "E&xit\tAlt-X", "Exit this simple sample")
        menuBar.Append(menu, "&File")

        if IS_GTK or IS_WIN:
            # Equation Menu
            menu = wx.Menu()
            for i, (mt, func) in enumerate(functions):
                bm = mathtext_to_wxbitmap(mt)
                item = wx.MenuItem(menu, 1000 + i, " ")
                item.SetBitmap(bm)
                menu.AppendItem(item)
                self.Bind(wx.EVT_MENU, self.OnChangePlot, item)
            menuBar.Append(menu, "&Functions")

        self.SetMenuBar(menuBar)

        self.SetSizer(self.sizer)
        self.Fit()

    def add_buttonbar(self):
        self.button_bar = wx.Panel(self)
        self.button_bar_sizer = wx.BoxSizer(wx.HORIZONTAL)
        self.sizer.Add(self.button_bar, 0, wx.LEFT | wx.TOP | wx.GROW)

        for i, (mt, func) in enumerate(functions):
            bm = mathtext_to_wxbitmap(mt)

```

```

        button = wx.BitmapButton(self.button_bar, 1000 + i, bm)
        self.button_bar_sizer.Add(button, 1, wx.GROW)
        self.Bind(wx.EVT_BUTTON, self.OnChangePlot, button)

    self.button_bar.SetSizer(self.button_bar_sizer)

    def add_toolbar(self):
        """Copied verbatim from embedding_wx2.py"""
        self.toolbar = NavigationToolbar2Wx(self.canvas)
        self.toolbar.Realize()
        # By adding toolbar in sizer, we are able to put it at the bottom
        # of the frame - so appearance is closer to GTK version.
        self.sizer.Add(self.toolbar, 0, wx.LEFT | wx.EXPAND)
        # update the axes menu on the toolbar
        self.toolbar.update()

    def OnChangePlot(self, event):
        self.change_plot(event.GetId() - 1000)

    def change_plot(self, plot_number):
        t = arange(1.0, 3.0, 0.01)
        s = functions[plot_number][1](t)
        self.axes.clear()
        self.axes.plot(t, s)
        self.canvas.draw()

class MyApp(wx.App):
    def OnInit(self):
        frame = CanvasFrame(None, "wxPython mathtext demo app")
        self.SetTopWindow(frame)
        frame.Show(True)
        return True

app = MyApp()
app.MainLoop()

```

Keywords: python, matplotlib, pylab, example, codex (see [Search examples](#))

112.23 user_interfaces example code: mpl_with_glade.py

[source code]

```

from __future__ import print_function
import matplotlib
matplotlib.use('GTK')

from matplotlib.figure import Figure
from matplotlib.axes import Subplot
from matplotlib.backends.backend_gtkagg import FigureCanvasGTKAgg as FigureCanvas
from matplotlib.backends.backend_gtkagg import NavigationToolbar2GTKAgg as
NavigationToolbar

```

```
from matplotlib.widgets import SpanSelector

from numpy import arange, sin, pi
import gtk
import gtk.glade

def simple_msg(msg, parent=None, title=None):
    dialog = gtk.MessageDialog(
        parent=None,
        type=gtk.MESSAGE_INFO,
        buttons=gtk.BUTTONS_OK,
        message_format=msg)
    if parent is not None:
        dialog.set_transient_for(parent)
    if title is not None:
        dialog.set_title(title)
    dialog.show()
    dialog.run()
    dialog.destroy()
    return None

class GladeHandlers(object):
    def on_buttonClickMe_clicked(event):
        simple_msg('Nothing to say, really',
                  parent=widgets['windowMain'],
                  title='Thanks!')

class WidgetsWrapper(object):
    def __init__(self):
        self.widgets = gtk.glade.XML('mpl_with_glade.glade')
        self.widgets.signal_autoconnect(GladeHandlers.__dict__)

        self['windowMain'].connect('destroy', lambda x: gtk.main_quit())
        self['windowMain'].move(10, 10)
        self.figure = Figure(figsize=(8, 6), dpi=72)
        self.axis = self.figure.add_subplot(111)

        t = arange(0.0, 3.0, 0.01)
        s = sin(2*pi*t)
        self.axis.plot(t, s)
        self.axis.set_xlabel('time (s)')
        self.axis.set_ylabel('voltage')

        self.canvas = FigureCanvas(self.figure) # a gtk.DrawingArea
        self.canvas.show()
        self.canvas.set_size_request(600, 400)
        self.canvas.set_events(
            gtk.gdk.BUTTON_PRESS_MASK |
            gtk.gdk.KEY_PRESS_MASK |
            gtk.gdk.KEY_RELEASE_MASK
```



```

    )
    self.canvas.set_flags(gtk.HAS_FOCUS | gtk.CAN_FOCUS)
    self.canvas.grab_focus()

    def keypress(widget, event):
        print('key press')

    def buttonpress(widget, event):
        print('button press')

    self.canvas.connect('key_press_event', keypress)
    self.canvas.connect('button_press_event', buttonpress)

    def onselect(xmin, xmax):
        print(xmin, xmax)

    span = SpanSelector(self.axis, onselect, 'horizontal', useblit=False,
                        rectprops=dict(alpha=0.5, facecolor='red'))

    self['vboxMain'].pack_start(self.canvas, True, True)
    self['vboxMain'].show()

    # below is optional if you want the navigation toolbar
    self.navToolbar = NavigationToolbar(self.canvas, self['windowMain'])
    self.navToolbar.lastDir = '/var/tmp/'
    self['vboxMain'].pack_start(self.navToolbar)
    self.navToolbar.show()

    sep = gtk.HSeparator()
    sep.show()
    self['vboxMain'].pack_start(sep, True, True)

    self['vboxMain'].reorder_child(self['buttonClickMe'], -1)

    def __getitem__(self, key):
        return self.widgets.get_widget(key)

widgets = WidgetsWrapper()
gtk.main()

```

Keywords: python, matplotlib, pylab, example, codex (see [Search examples](#))

112.24 user_interfaces example code: mpl_with_glade_316.py

[source code]

```

from gi.repository import Gtk

from matplotlib.figure import Figure
from matplotlib.axes import Subplot
from numpy import arange, sin, pi

```

```

from matplotlib.backends.backend_gtk3agg import FigureCanvasGTK3Agg as FigureCanvas

class Window1Signals(object):
    def on_window1_destroy(self, widget):
        Gtk.main_quit()

def main():
    builder = Gtk.Builder()
    builder.add_objects_from_file("mpl_with_glade_316.glade", ("window1", ""))
    builder.connect_signals(Window1Signals())
    window = builder.get_object("window1")
    sw = builder.get_object("scrolledwindow1")

    # Start of Matplotlib specific code
    figure = Figure(figsize=(8, 6), dpi=71)
    axis = figure.add_subplot(111)
    t = arange(0.0, 3.0, 0.01)
    s = sin(2*pi*t)
    axis.plot(t, s)

    axis.set_xlabel('time [s]')
    axis.set_ylabel('voltage [V]')

    canvas = FigureCanvas(figure) # a Gtk.DrawingArea
    canvas.set_size_request(800, 600)
    sw.add_with_viewport(canvas)
    # End of Matplotlib specific code

    window.show_all()
    Gtk.main()

if __name__ == "__main__":
    main()

```

Keywords: python, matplotlib, pylab, example, codex (see [Search examples](#))

112.25 user_interfaces example code: pylab_with_gtk.py

[source code]

```

"""
An example of how to use pylab to manage your figure windows, but
modify the GUI by accessing the underlying gtk widgets
"""
from __future__ import print_function
import matplotlib
matplotlib.use('GTKAgg')
import matplotlib.pyplot as plt

```

```

fig, ax = plt.subplots()
plt.plot([1, 2, 3], 'ro-', label='easy as 1 2 3')
plt.plot([1, 4, 9], 'gs--', label='easy as 1 2 3 squared')
plt.legend()

manager = plt.get_current_fig_manager()
# you can also access the window or vbox attributes this way
toolbar = manager.toolbar

# now let's add a button to the toolbar
import gtk
next = 8 # where to insert this in the mpl toolbar
button = gtk.Button('Click me')
button.show()

def clicked(button):
    print('hi mom')
button.connect('clicked', clicked)

toolitem = gtk.ToolItem()
toolitem.show()
toolitem.set_tooltip(
    toolbar.tooltips,
    'Click me for fun and profit')

toolitem.add(button)
toolbar.insert(toolitem, next)
next += 1

# now let's add a widget to the vbox
label = gtk.Label()
label.set_markup('Drag mouse over axes for position')
label.show()
vbox = manager.vbox
vbox.pack_start(label, False, False)
vbox.reorder_child(manager.toolbar, -1)

def update(event):
    if event.xdata is None:
        label.set_markup('Drag mouse over axes for position')
    else:
        label.set_markup('<span color="#ef0000">x,y=(%f, %f)</span>' % (event.xdata,
        ↪event.ydata))

plt.connect('motion_notify_event', update)

plt.show()

```

Keywords: python, matplotlib, pylab, example, codex (see [Search examples](#))

112.26 user_interfaces example code: rec_edit_gtk_custom.py

[source code]

```

"""
generate an editable gtk treeview widget for record arrays with custom
formatting of the cells and show how to limit string entries to a list
of strings
"""
from __future__ import print_function
import gtk
import numpy as np
import matplotlib.mlab as mlab
import matplotlib.cbook as cbook
import mpl_toolkits.gtktools as gtktools

datafile = cbook.get_sample_data('demodata.csv', asfileobj=False)
r = mlab.csv2rec(datafile, converterd={'weekdays': str})

formatd = mlab.get_formatd(r)
formatd['date'] = mlab.FormatDate('%Y-%m-%d')
formatd['prices'] = mlab.FormatMillions(precision=1)
formatd['gain'] = mlab.FormatPercent(precision=2)

# use a drop down combo for weekdays
stringd = dict(weekdays=['Sun', 'Mon', 'Tue', 'Wed', 'Thu', 'Fri', 'Sat'])
constant = ['clientid'] # block editing of this field

liststore = gtktools.RecListStore(r, formatd=formatd, stringd=stringd)
treeview = gtktools.RecTreeView(liststore, constant=constant)

def mycallback(liststore, rownum, colname, oldval, newval):
    print('verify: old=%s, new=%s, rec=%s' % (oldval, newval, liststore.
    ↪r[rownum][colname]))

liststore.callbacks.connect('cell_changed', mycallback)

win = gtk.Window()
win.set_title('click to edit')
win.add(treeview)
win.show_all()
win.connect('delete-event', lambda *args: gtk.main_quit())
gtk.main()

```

Keywords: python, matplotlib, pylab, example, codex (see [Search examples](#))

112.27 user_interfaces example code: rec_edit_gtk_simple.py

[source code]

```

"""
Load a CSV file into a record array and edit it in a gtk treeview
"""

import gtk
import numpy as np
import matplotlib.mlab as mlab
import matplotlib.cbook as cbook
import mpl_toolkits.gtktools as gtktools

datafile = cbook.get_sample_data('demodata.csv', asfileobj=False)
r = mlab.csv2rec(datafile, converterd={'weekdays': str})

liststore, treeview, win = gtktools.edit_rearray(r)
win.set_title('click to edit')
win.connect('delete-event', lambda *args: gtk.main_quit())
gtk.main()

```

Keywords: python, matplotlib, pylab, example, codex (see *Search examples*)

112.28 user_interfaces example code: svg_histogram.py

[source code]

```

"""
Demonstrate how to create an interactive histogram, in which bars
are hidden or shown by clicking on legend markers.

The interactivity is encoded in ecmaScript (javascript) and inserted in
the SVG code in a post-processing step. To render the image, open it in
a web browser. SVG is supported in most web browsers used by Linux and
OSX users. Windows IE9 supports SVG, but earlier versions do not.

Notes
-----
The matplotlib backend lets us assign ids to each object. This is the
mechanism used here to relate matplotlib objects created in python and
the corresponding SVG constructs that are parsed in the second step.
While flexible, ids are cumbersome to use for large collection of
objects. Two mechanisms could be used to simplify things:
* systematic grouping of objects into SVG <g> tags,
* assigning classes to each SVG object according to its origin.

For example, instead of modifying the properties of each individual bar,
the bars from the `hist` function could either be grouped in
a PatchCollection, or be assigned a class="hist_#%" attribute.

```

CSS could also be used more extensively to replace repetitive markup throughout the generated SVG.

Author: david.huard@gmail.com

```
"""

import numpy as np
import matplotlib.pyplot as plt
import xml.etree.ElementTree as ET
from io import BytesIO
import json

plt.rcParams['svg.fonttype'] = 'none'

# Apparently, this `register_namespace` method works only with
# python 2.7 and up and is necessary to avoid garbling the XML name
# space with ns0.
ET.register_namespace("", "http://www.w3.org/2000/svg")

# --- Create histogram, legend and title ---
plt.figure()
r = np.random.randn(100)
r1 = r + 1
labels = ['Rabbits', 'Frogs']
H = plt.hist([r, r1], label=labels)
containers = H[-1]
leg = plt.legend(frameon=False)
plt.title("From a web browser, click on the legend\n"
          "marker to toggle the corresponding histogram.")

# --- Add ids to the svg objects we'll modify

hist_patches = {}
for ic, c in enumerate(containers):
    hist_patches['hist_%d' % ic] = []
    for il, element in enumerate(c):
        element.set_gid('hist_%d_patch_%d' % (ic, il))
        hist_patches['hist_%d' % ic].append('hist_%d_patch_%d' % (ic, il))

# Set ids for the legend patches
for i, t in enumerate(leg.get_patches()):
    t.set_gid('leg_patch_%d' % i)

# Set ids for the text patches
for i, t in enumerate(leg.get_texts()):
    t.set_gid('leg_text_%d' % i)

# Save SVG in a fake file object.
```

```

f = BytesIO()
plt.savefig(f, format="svg")

# Create XML tree from the SVG file.
tree, xmlid = ET.XMLID(f.getvalue())

# --- Add interactivity ---

# Add attributes to the patch objects.
for i, t in enumerate(leg.get_patches()):
    el = xmlid['leg_patch_%d' % i]
    el.set('cursor', 'pointer')
    el.set('onclick', "toggle_hist(this)")

# Add attributes to the text objects.
for i, t in enumerate(leg.get_texts()):
    el = xmlid['leg_text_%d' % i]
    el.set('cursor', 'pointer')
    el.set('onclick', "toggle_hist(this)")

# Create script defining the function `toggle_hist`.
# We create a global variable `container` that stores the patches id
# belonging to each histogram. Then a function "toggle_element" sets the
# visibility attribute of all patches of each histogram and the opacity
# of the marker itself.

script = """
<script type="text/ecmascript">
<![CDATA[
var container = %s

function toggle(oid, attribute, values) {
    /* Toggle the style attribute of an object between two values.

    Parameters
    -----
    oid : str
        Object identifier.
    attribute : str
        Name of style attribute.
    values : [on state, off state]
        The two values that are switched between.
    */
    var obj = document.getElementById(oid);
    var a = obj.style[attribute];

    a = (a == values[0] || a == "") ? values[1] : values[0];
    obj.style[attribute] = a;
}

function toggle_hist(obj) {

```

```

var num = obj.id.slice(-1);

toggle('leg_patch_' + num, 'opacity', [1, 0.3]);
toggle('leg_text_' + num, 'opacity', [1, 0.5]);

var names = container['hist_'+num]

for (var i=0; i < names.length; i++) {
    toggle(names[i], 'opacity', [1,0])
};
}
]]>
</script>
""" % json.dumps(hist_patches)

# Add a transition effect
css = tree.getchildren()[0][0]
css.text = css.text + "g {-webkit-transition:opacity 0.4s ease-out;" + \
    "-moz-transition:opacity 0.4s ease-out;}"

# Insert the script and save to file.
tree.insert(0, ET.XML(script))

ET.ElementTree(tree).write("svg_histogram.svg")

```

Keywords: python, matplotlib, pylab, example, codex (see *Search examples*)

112.29 user_interfaces example code: svg_tooltip.py

[source code]

```

"""
SVG tooltip example
=====

This example shows how to create a tooltip that will show up when
hovering over a matplotlib patch.

Although it is possible to create the tooltip from CSS or javascript,
here we create it in matplotlib and simply toggle its visibility on
when hovering over the patch. This approach provides total control over
the tooltip placement and appearance, at the expense of more code up
front.

The alternative approach would be to put the tooltip content in `title`
attributes of SVG objects. Then, using an existing js/CSS library, it
would be relatively straightforward to create the tooltip in the
browser. The content would be dictated by the `title` attribute, and
the appearance by the CSS.

```



```

:author: David Huard
"""

import matplotlib.pyplot as plt
import xml.etree.ElementTree as ET
from io import BytesIO

ET.register_namespace("", "http://www.w3.org/2000/svg")

fig, ax = plt.subplots()

# Create patches to which tooltips will be assigned.
rect1 = plt.Rectangle((10, -20), 10, 5, fc='blue')
rect2 = plt.Rectangle((-20, 15), 10, 5, fc='green')

shapes = [rect1, rect2]
labels = ['This is a blue rectangle.', 'This is a green rectangle']

for i, (item, label) in enumerate(zip(shapes, labels)):
    patch = ax.add_patch(item)
    annotate = ax.annotate(labels[i], xy=item.get_xy(), xytext=(0, 0),
                           textcoords='offset points', color='w', ha='center',
                           fontsize=8, bbox=dict(boxstyle='round, pad=.5',
                                                  fc=(.1, .1, .1, .92),
                                                  ec=(1., 1., 1.), lw=1,
                                                  zorder=1))

    ax.add_patch(patch)
    patch.set_gid('mypatch_{:03d}'.format(i))
    annotate.set_gid('mytooltip_{:03d}'.format(i))

# Save the figure in a fake file object
ax.set_xlim(-30, 30)
ax.set_ylim(-30, 30)
ax.set_aspect('equal')

f = BytesIO()
plt.savefig(f, format="svg")

# --- Add interactivity ---

# Create XML tree from the SVG file.
tree, xmlid = ET.XMLID(f.getvalue())
tree.set('onload', 'init(evt)')

for i in shapes:
    # Get the index of the shape
    index = shapes.index(i)
    # Hide the tooltips
    tooltip = xmlid['mytooltip_{:03d}'.format(index)]
    tooltip.set('visibility', 'hidden')
    # Assign onmouseover and onmouseout callbacks to patches.

```

```

mypatch = xmlid['mypatch_{:03d}'.format(index)]
mypatch.set('onmouseover', "ShowTooltip(this)")
mypatch.set('onmouseout', "HideTooltip(this)")

# This is the script defining the ShowTooltip and HideTooltip functions.
script = """
<script type="text/ecmascript">
<![CDATA[

function init(evt) {
    if ( window.svgDocument == null ) {
        svgDocument = evt.target.ownerDocument;
    }
}

function ShowTooltip(obj) {
    var cur = obj.id.split("_")[1];
    var tip = svgDocument.getElementById('mytooltip_' + cur);
    tip.setAttribute('visibility',"visible")
}

function HideTooltip(obj) {
    var cur = obj.id.split("_")[1];
    var tip = svgDocument.getElementById('mytooltip_' + cur);
    tip.setAttribute('visibility',"hidden")
}

]]>
</script>
"""

# Insert the script at the top of the file and save it.
tree.insert(0, ET.XML(script))
ET.ElementTree(tree).write('svg_tooltip.svg')

```

Keywords: python, matplotlib, pylab, example, codex (see *Search examples*)

112.30 user_interfaces example code: toolmanager.py

[source code]

```

"""This example demonstrates how to:
* Modify the Toolbar
* Create tools
* Add tools
* Remove tools
Using `matplotlib.backend_managers.ToolManager`
"""

from __future__ import print_function

```

```

import matplotlib
matplotlib.use('GTK3Cairo')
matplotlib.rcParams['toolbar'] = 'toolmanager'
import matplotlib.pyplot as plt
from matplotlib.backend_tools import ToolBase, ToolToggleBase
from gi.repository import Gtk, Gdk

class ListTools(ToolBase):
    """List all the tools controlled by the `ToolManager`"""
    # keyboard shortcut
    default_keymap = 'm'
    description = 'List Tools'

    def trigger(self, *args, **kwargs):
        print('-' * 80)
        print("{0:12} {1:45} {2}".format('Name (id)',
                                        'Tool description',
                                        'Keymap'))

        print('-' * 80)
        tools = self.toolmanager.tools
        for name in sorted(tools.keys()):
            if not tools[name].description:
                continue
            keys = ', '.join(sorted(self.toolmanager.get_tool_keymap(name)))
            print("{0:12} {1:45} {2}".format(name,
                                            tools[name].description,
                                            keys))

        print('-' * 80)
        print("Active Toggle tools")
        print("{0:12} {1:45}".format("Group", "Active"))
        print('-' * 80)
        for group, active in self.toolmanager.active_toggle.items():
            print("{0:12} {1:45}".format(group, active))

class GroupHideTool(ToolToggleBase):
    """Hide lines with a given gid"""
    default_keymap = 'G'
    description = 'Hide by gid'

    def __init__(self, *args, **kwargs):
        self.gid = kwargs.pop('gid')
        ToolToggleBase.__init__(self, *args, **kwargs)

    def enable(self, *args):
        self.set_lines_visibility(False)

    def disable(self, *args):
        self.set_lines_visibility(True)

    def set_lines_visibility(self, state):
        gr_lines = []

```

```

        for ax in self.figure.get_axes():
            for line in ax.get_lines():
                if line.get_gid() == self.gid:
                    line.set_visible(state)
            self.figure.canvas.draw()

fig = plt.figure()
plt.plot([1, 2, 3], gid='mygroup')
plt.plot([2, 3, 4], gid='unknown')
plt.plot([3, 2, 1], gid='mygroup')

# Add the custom tools that we created
fig.canvas.manager.toolmanager.add_tool('List', ListTools)
fig.canvas.manager.toolmanager.add_tool('Hide', GroupHideTool, gid='mygroup')

# Add an existing tool to new group `foo`.
# It can be added as many times as we want
fig.canvas.manager.toolbar.add_tool('zoom', 'foo')

# Remove the forward button
fig.canvas.manager.toolmanager.remove_tool('forward')

# To add a custom tool to the toolbar at specific location inside
# the navigation group
fig.canvas.manager.toolbar.add_tool('Hide', 'navigation', 1)

plt.show()

```

Keywords: python, matplotlib, pylab, example, codex (see [Search examples](#))

112.31 user_interfaces example code: wxcursor_demo.py

[source code]

```

"""
Example to draw a cursor and report the data coords in wx
"""
# matplotlib requires wxPython 2.8+
# set the wxPython version in lib\site-packages\wx.pth file
# or if you have wxversion installed un-comment the lines below
#import wxversion
#wxversion.ensureMinimal('2.8')

import matplotlib
matplotlib.use('WXAgg')

from matplotlib.backends.backend_wxagg import FigureCanvasWxAgg as FigureCanvas
from matplotlib.backends.backend_wx import NavigationToolbar2Wx, wxc
from matplotlib.figure import Figure

```

```

from numpy import arange, sin, pi

import wx

class CanvasFrame(wx.Frame):
    def __init__(self, ):
        wx.Frame.__init__(self, None, -1,
                          'CanvasFrame', size=(550, 350))

        self.SetBackgroundColour(wxc.NamedColour("WHITE"))

        self.figure = Figure()
        self.axes = self.figure.add_subplot(111)
        t = arange(0.0, 3.0, 0.01)
        s = sin(2*pi*t)

        self.axes.plot(t, s)
        self.axes.set_xlabel('t')
        self.axes.set_ylabel('sin(t)')
        self.figure_canvas = FigureCanvas(self, -1, self.figure)

        # Note that event is a MplEvent
        self.figure_canvas.mpl_connect('motion_notify_event', self.UpdateStatusBar)
        self.figure_canvas.Bind(wx.EVT_ENTER_WINDOW, self.ChangeCursor)

        self.sizer = wx.BoxSizer(wx.VERTICAL)
        self.sizer.Add(self.figure_canvas, 1, wx.LEFT | wx.TOP | wx.GROW)
        self.SetSizer(self.sizer)
        self.Fit()

        self.statusBar = wx.StatusBar(self, -1)
        self.SetStatusBar(self.statusBar)

        self.toolbar = NavigationToolbar2Wx(self.figure_canvas)
        self.sizer.Add(self.toolbar, 0, wx.LEFT | wx.EXPAND)
        self.toolbar.Show()

    def ChangeCursor(self, event):
        self.figure_canvas.SetCursor(wxc.StockCursor(wx.CURSOR_BULLSEYE))

    def UpdateStatusBar(self, event):
        if event.inaxes:
            x, y = event.xdata, event.ydata
            self.statusBar.SetStatusText(("x= " + str(x) +
                                         " y=" + str(y)),
                                         0)

class App(wx.App):
    def OnInit(self):
        'Create the main window and insert the custom frame'
        frame = CanvasFrame()

```

```
        self.SetTopWindow(frame)
        frame.Show(True)
        return True

if __name__ == '__main__':
    app = App(0)
    app.MainLoop()
```

Keywords: python, matplotlib, pylab, example, codex (see [Search examples](#))

WIDGETS EXAMPLES

113.1 widgets example code: buttons.py

[source code]

```
import numpy as np
import matplotlib.pyplot as plt
from matplotlib.widgets import Button

freqs = np.arange(2, 20, 3)

fig, ax = plt.subplots()
plt.subplots_adjust(bottom=0.2)
t = np.arange(0.0, 1.0, 0.001)
s = np.sin(2*np.pi*freqs[0]*t)
l, = plt.plot(t, s, lw=2)

class Index(object):
    ind = 0

    def next(self, event):
        self.ind += 1
        i = self.ind % len(freqs)
        ydata = np.sin(2*np.pi*freqs[i]*t)
        l.set_ydata(ydata)
        plt.draw()

    def prev(self, event):
        self.ind -= 1
        i = self.ind % len(freqs)
        ydata = np.sin(2*np.pi*freqs[i]*t)
        l.set_ydata(ydata)
        plt.draw()

callback = Index()
axprev = plt.axes([0.7, 0.05, 0.1, 0.075])
axnext = plt.axes([0.81, 0.05, 0.1, 0.075])
bnext = Button(axnext, 'Next')
bnext.on_clicked(callback.next)
```

```
bprev = Button(axprev, 'Previous')
bprev.on_clicked(callback.prev)

plt.show()
```

Keywords: python, matplotlib, pylab, example, codex (see [Search examples](#))

113.2 widgets example code: check_buttons.py

[source code]

```
import numpy as np
import matplotlib.pyplot as plt
from matplotlib.widgets import CheckButtons

t = np.arange(0.0, 2.0, 0.01)
s0 = np.sin(2*np.pi*t)
s1 = np.sin(4*np.pi*t)
s2 = np.sin(6*np.pi*t)

fig, ax = plt.subplots()
l0, = ax.plot(t, s0, visible=False, lw=2)
l1, = ax.plot(t, s1, lw=2)
l2, = ax.plot(t, s2, lw=2)
plt.subplots_adjust(left=0.2)

rax = plt.axes([0.05, 0.4, 0.1, 0.15])
check = CheckButtons(rax, ('2 Hz', '4 Hz', '6 Hz'), (False, True, True))

def func(label):
    if label == '2 Hz':
        l0.set_visible(not l0.get_visible())
    elif label == '4 Hz':
        l1.set_visible(not l1.get_visible())
    elif label == '6 Hz':
        l2.set_visible(not l2.get_visible())
    plt.draw()
check.on_clicked(func)

plt.show()
```

Keywords: python, matplotlib, pylab, example, codex (see [Search examples](#))

113.3 widgets example code: cursor.py

[source code]

```

from matplotlib.widgets import Cursor
import numpy as np
import matplotlib.pyplot as plt

fig = plt.figure(figsize=(8, 6))
ax = fig.add_subplot(111, facecolor='#FFFFCC')

x, y = 4*(np.random.rand(2, 100) - .5)
ax.plot(x, y, 'o')
ax.set_xlim(-2, 2)
ax.set_ylim(-2, 2)

# set useblit = True on gtkagg for enhanced performance
cursor = Cursor(ax, useblit=True, color='red', linewidth=2)

plt.show()

```

Keywords: python, matplotlib, pylab, example, codex (see [Search examples](#))

113.4 widgets example code: lasso_selector_demo.py

[source code]

```

from __future__ import print_function

from six.moves import input

import numpy as np

from matplotlib.widgets import LassoSelector
from matplotlib.path import Path

class SelectFromCollection(object):
    """Select indices from a matplotlib collection using `LassoSelector`.

    Selected indices are saved in the `ind` attribute. This tool highlights
    selected points by fading them out (i.e., reducing their alpha values).
    If your collection has alpha < 1, this tool will permanently alter them.

    Note that this tool selects collection objects based on their *origins*
    (i.e., `offsets`).

    Parameters
    -----
    ax : :class:`~matplotlib.axes.Axes`
        Axes to interact with.

    collection : :class:`~matplotlib.collections.Collection` subclass
        Collection you want to select from.

```

```

alpha_other : 0 <= float <= 1
    To highlight a selection, this tool sets all selected points to an
    alpha value of 1 and non-selected points to `alpha_other`.
    """

def __init__(self, ax, collection, alpha_other=0.3):
    self.canvas = ax.figure.canvas
    self.collection = collection
    self.alpha_other = alpha_other

    self.xys = collection.get_offsets()
    self.Npts = len(self.xys)

    # Ensure that we have separate colors for each object
    self.fc = collection.get_facecolors()
    if len(self.fc) == 0:
        raise ValueError('Collection must have a facecolor')
    elif len(self.fc) == 1:
        self.fc = np.tile(self.fc, self.Npts).reshape(self.Npts, -1)

    self.lasso = LassoSelector(ax, onselect=self.onselect)
    self.ind = []

def onselect(self, verts):
    path = Path(verts)
    self.ind = np.nonzero([path.contains_point(xy) for xy in self.xys])[0]
    self.fc[:, -1] = self.alpha_other
    self.fc[self.ind, -1] = 1
    self.collection.set_facecolors(self.fc)
    self.canvas.draw_idle()

def disconnect(self):
    self.lasso.disconnect_events()
    self.fc[:, -1] = 1
    self.collection.set_facecolors(self.fc)
    self.canvas.draw_idle()

if __name__ == '__main__':
    import matplotlib.pyplot as plt

    plt.ion()
    data = np.random.rand(100, 2)

    subplot_kw = dict(xlim=(0, 1), ylim=(0, 1), autoscale_on=False)
    fig, ax = plt.subplots(subplot_kw=subplot_kw)

    pts = ax.scatter(data[:, 0], data[:, 1], s=80)
    selector = SelectFromCollection(ax, pts)

    plt.draw()
    input('Press Enter to accept selected points')

```

```
print("Selected points:")
print(selector.xys[selector.ind])
selector.disconnect()

# Block end of script so you can check that the lasso is disconnected.
input('Press Enter to quit')
```

Keywords: python, matplotlib, pylab, example, codex (see [Search examples](#))

113.5 widgets example code: menu.py

[source code]

```
from __future__ import division, print_function
import numpy as np
import matplotlib
import matplotlib.colors as colors
import matplotlib.patches as patches
import matplotlib.mathtext as mathtext
import matplotlib.pyplot as plt
import matplotlib.artist as artist
import matplotlib.image as image

class ItemProperties(object):
    def __init__(self, fontsize=14, labelcolor='black', bgcolor='yellow',
                 alpha=1.0):
        self.fontsize = fontsize
        self.labelcolor = labelcolor
        self.bgcolor = bgcolor
        self.alpha = alpha

        self.labelcolor_rgb = colors.to_rgba(labelcolor)[:3]
        self.bgcolor_rgb = colors.to_rgba(bgcolor)[:3]

class MenuItem(artist.Artist):
    parser = mathtext.MathTextParser("Bitmap")
    padx = 5
    pady = 5

    def __init__(self, fig, labelstr, props=None, hoverprops=None,
                 on_select=None):
        artist.Artist.__init__(self)

        self.set_figure(fig)
        self.labelstr = labelstr

        if props is None:
            props = ItemProperties()
```

```

    if hoverprops is None:
        hoverprops = ItemProperties()

    self.props = props
    self.hoverprops = hoverprops

    self.on_select = on_select

    x, self.depth = self.parser.to_mask(
        labelstr, fontsize=props.fontsize, dpi=fig.dpi)

    if props.fontsize != hoverprops.fontsize:
        raise NotImplementedError(
            'support for different font sizes not implemented')

    self.labelwidth = x.shape[1]
    self.labelheight = x.shape[0]

    self.labelArray = np.zeros((x.shape[0], x.shape[1], 4))
    self.labelArray[:, :, -1] = x/255.

    self.label = image.FigureImage(fig, origin='upper')
    self.label.set_array(self.labelArray)

    # we'll update these later
    self.rect = patches.Rectangle((0, 0), 1, 1)

    self.set_hover_props(False)

    fig.canvas.mpl_connect('button_release_event', self.check_select)

def check_select(self, event):
    over, junk = self.rect.contains(event)
    if not over:
        return

    if self.on_select is not None:
        self.on_select(self)

def set_extent(self, x, y, w, h):
    print(x, y, w, h)
    self.rect.set_x(x)
    self.rect.set_y(y)
    self.rect.set_width(w)
    self.rect.set_height(h)

    self.label.ox = x + self.padx
    self.label.oy = y - self.depth + self.pady/2.

    self.rect._update_patch_transform()
    self.hover = False

def draw(self, renderer):

```

```

self.rect.draw(renderer)
self.label.draw(renderer)

def set_hover_props(self, b):
    if b:
        props = self.hoverprops
    else:
        props = self.props

    r, g, b = props.labelcolor_rgb
    self.labelArray[:, :, 0] = r
    self.labelArray[:, :, 1] = g
    self.labelArray[:, :, 2] = b
    self.label.set_array(self.labelArray)
    self.rect.set(facecolor=props.bgcolor, alpha=props.alpha)

def set_hover(self, event):
    'check the hover status of event and return true if status is changed'
    b, junk = self.rect.contains(event)

    changed = (b != self.hover)

    if changed:
        self.set_hover_props(b)

    self.hover = b
    return changed

class Menu(object):
    def __init__(self, fig, menuitems):
        self.figure = fig
        fig.suppressComposite = True

        self.menuitems = menuitems
        self.numitems = len(menuitems)

        maxw = max([item.labelwidth for item in menuitems])
        maxh = max([item.labelheight for item in menuitems])

        totalh = self.numitems*maxh + (self.numitems + 1)*2*MenuItem.pady

        x0 = 100
        y0 = 400

        width = maxw + 2*MenuItem.padx
        height = maxh + MenuItem.pady

        for item in menuitems:
            left = x0
            bottom = y0 - maxh - MenuItem.pady

            item.set_extent(left, bottom, width, height)

```

```

        fig.artists.append(item)
        y0 -= maxh + MenuItem.pady

    fig.canvas.mpl_connect('motion_notify_event', self.on_move)

    def on_move(self, event):
        draw = False
        for item in self.menuitems:
            draw = item.set_hover(event)
            if draw:
                self.figure.canvas.draw()
                break

fig = plt.figure()
fig.subplots_adjust(left=0.3)
props = ItemProperties(labelcolor='black', bgcolor='yellow',
                      fontsize=15, alpha=0.2)
hoverprops = ItemProperties(labelcolor='white', bgcolor='blue',
                           fontsize=15, alpha=0.2)

menuitems = []
for label in ('open', 'close', 'save', 'save as', 'quit'):
    def on_select(item):
        print('you selected %s' % item.labelstr)
        item = MenuItem(fig, label, props=props, hoverprops=hoverprops,
                       on_select=on_select)
        menuitems.append(item)

menu = Menu(fig, menuitems)
plt.show()

```

Keywords: python, matplotlib, pylab, example, codex (see [Search examples](#))

113.6 widgets example code: multicursor.py

[source code]

```

import numpy as np
import matplotlib.pyplot as plt
from matplotlib.widgets import MultiCursor

t = np.arange(0.0, 2.0, 0.01)
s1 = np.sin(2*np.pi*t)
s2 = np.sin(4*np.pi*t)
fig = plt.figure()
ax1 = fig.add_subplot(211)
ax1.plot(t, s1)

```

```

ax2 = fig.add_subplot(212, sharex=ax1)
ax2.plot(t, s2)

multi = MultiCursor(fig.canvas, (ax1, ax2), color='r', lw=1)
plt.show()

```

Keywords: python, matplotlib, pylab, example, codex (see [Search examples](#))

113.7 widgets example code: radio_buttons.py

[source code]

```

import numpy as np
import matplotlib.pyplot as plt
from matplotlib.widgets import RadioButtons

t = np.arange(0.0, 2.0, 0.01)
s0 = np.sin(2*np.pi*t)
s1 = np.sin(4*np.pi*t)
s2 = np.sin(8*np.pi*t)

fig, ax = plt.subplots()
l, = ax.plot(t, s0, lw=2, color='red')
plt.subplots_adjust(left=0.3)

axcolor = 'lightgoldenrodyellow'
rax = plt.axes([0.05, 0.7, 0.15, 0.15], facecolor=axcolor)
radio = RadioButtons(rax, ('2 Hz', '4 Hz', '8 Hz'))

def hzfunc(label):
    hzdict = {'2 Hz': s0, '4 Hz': s1, '8 Hz': s2}
    ydata = hzdict[label]
    l.set_ydata(ydata)
    plt.draw()
radio.on_clicked(hzfunc)

rax = plt.axes([0.05, 0.4, 0.15, 0.15], facecolor=axcolor)
radio2 = RadioButtons(rax, ('red', 'blue', 'green'))

def colorfunc(label):
    l.set_color(label)
    plt.draw()
radio2.on_clicked(colorfunc)

rax = plt.axes([0.05, 0.1, 0.15, 0.15], facecolor=axcolor)
radio3 = RadioButtons(rax, ('-', '--', '-.', 'steps', ':'))

def stylefunc(label):

```

```

l.set_linestyle(label)
plt.draw()
radio3.on_clicked(stylefunc)

plt.show()

```

Keywords: python, matplotlib, pylab, example, codex (see *Search examples*)

113.8 widgets example code: rectangle_selector.py

[source code]

```

from __future__ import print_function
"""
Do a mouseclick somewhere, move the mouse to some destination, release
the button. This class gives click- and release-events and also draws
a line or a box from the click-point to the actual mouseposition
(within the same axes) until the button is released. Within the
method 'self.ignore()' it is checked whether the button from eventpress
and eventrelease are the same.
"""
from matplotlib.widgets import RectangleSelector
import numpy as np
import matplotlib.pyplot as plt

def line_select_callback(eclick, erelease):
    'eclick and erelease are the press and release events'
    x1, y1 = eclick.xdata, eclick.ydata
    x2, y2 = erelease.xdata, erelease.ydata
    print("(%3.2f, %3.2f) --> (%3.2f, %3.2f)" % (x1, y1, x2, y2))
    print(" The button you used were: %s %s" % (eclick.button, erelease.button))

def toggle_selector(event):
    print(' Key pressed.')
    if event.key in ['Q', 'q'] and toggle_selector.RS.active:
        print(' RectangleSelector deactivated.')
        toggle_selector.RS.set_active(False)
    if event.key in ['A', 'a'] and not toggle_selector.RS.active:
        print(' RectangleSelector activated.')
        toggle_selector.RS.set_active(True)

fig, current_ax = plt.subplots() # make a new plotting range
N = 100000 # If N is large one can see
x = np.linspace(0.0, 10.0, N) # improvement by use blitting!

plt.plot(x, +np.sin(.2*np.pi*x), lw=3.5, c='b', alpha=.7) # plot something
plt.plot(x, +np.cos(.2*np.pi*x), lw=3.5, c='r', alpha=.5)

```



```
plt.plot(x, -np.sin(.2*np.pi*x), lw=3.5, c='g', alpha=.3)

print("\n      click --> release")

# drawtype is 'box' or 'line' or 'none'
toggle_selector.RS = RectangleSelector(current_ax, line_select_callback,
                                       drawtype='box', useblit=True,
                                       button=[1, 3], # don't use middle button
                                       minspanx=5, minspany=5,
                                       spancoords='pixels',
                                       interactive=True)

plt.connect('key_press_event', toggle_selector)
plt.show()
```

Keywords: python, matplotlib, pylab, example, codex (see [Search examples](#))

113.9 widgets example code: slider_demo.py

[source code]

```
import numpy as np
import matplotlib.pyplot as plt
from matplotlib.widgets import Slider, Button, RadioButtons

fig, ax = plt.subplots()
plt.subplots_adjust(left=0.25, bottom=0.25)
t = np.arange(0.0, 1.0, 0.001)
a0 = 5
f0 = 3
s = a0*np.sin(2*np.pi*f0*t)
l, = plt.plot(t, s, lw=2, color='red')
plt.axis([0, 1, -10, 10])

axcolor = 'lightgoldenrodyellow'
axfreq = plt.axes([0.25, 0.1, 0.65, 0.03], facecolor=axcolor)
axamp = plt.axes([0.25, 0.15, 0.65, 0.03], facecolor=axcolor)

sfreq = Slider(axfreq, 'Freq', 0.1, 30.0, valinit=f0)
samp = Slider(axamp, 'Amp', 0.1, 10.0, valinit=a0)

def update(val):
    amp = samp.val
    freq = sfreq.val
    l.set_ydata(amp*np.sin(2*np.pi*freq*t))
    fig.canvas.draw_idle()
sfreq.on_changed(update)
samp.on_changed(update)

resetax = plt.axes([0.8, 0.025, 0.1, 0.04])
button = Button(resetax, 'Reset', color=axcolor, hovercolor='0.975')
```

```

def reset(event):
    sfreq.reset()
    samp.reset()
    button.on_clicked(reset)

rax = plt.axes([0.025, 0.5, 0.15, 0.15], facecolor=axcolor)
radio = RadioButtons(rax, ('red', 'blue', 'green'), active=0)

def colorfunc(label):
    l.set_color(label)
    fig.canvas.draw_idle()
    radio.on_clicked(colorfunc)

plt.show()

```

Keywords: python, matplotlib, pylab, example, codex (see [Search examples](#))

113.10 widgets example code: span_selector.py

[source code]

```

"""
The SpanSelector is a mouse widget to select a xmin/xmax range and plot the
detail view of the selected region in the lower axes
"""
import numpy as np
import matplotlib.pyplot as plt
from matplotlib.widgets import SpanSelector

fig = plt.figure(figsize=(8, 6))
ax = fig.add_subplot(211, facecolor='#FFFFCC')

x = np.arange(0.0, 5.0, 0.01)
y = np.sin(2*np.pi*x) + 0.5*np.random.randn(len(x))

ax.plot(x, y, '-')
ax.set_ylim(-2, 2)
ax.set_title('Press left mouse button and drag to test')

ax2 = fig.add_subplot(212, facecolor='#FFFFCC')
line2, = ax2.plot(x, y, '-')

def onselect(xmin, xmax):
    indmin, indmax = np.searchsorted(x, (xmin, xmax))
    indmax = min(len(x) - 1, indmax)

    thisx = x[indmin:indmax]

```

```
    thisy = y[indmin:indmax]
    line2.set_data(thisx, thisy)
    ax2.set_xlim(thisx[0], thisx[-1])
    ax2.set_ylim(thisy.min(), thisy.max())
    fig.canvas.draw()

# set useblit True on gtkagg for enhanced performance
span = SpanSelector(ax, onselect, 'horizontal', useblit=True,
                   rectprops=dict(alpha=0.5, facecolor='red'))

plt.show()
```

Keywords: python, matplotlib, pylab, example, codex (see [Search examples](#))

Part X

Glossary

- AGG** The Anti-Grain Geometry ([Agg](#)) rendering engine, capable of rendering high-quality images
- Cairo** The [Cairo graphics](#) engine
- dateutil** The [dateutil](#) library provides extensions to the standard datetime module
- EPS** Encapsulated Postscript ([EPS](#))
- FreeType** [FreeType](#) is a font rasterization library used by matplotlib which supports TrueType, Type 1, and OpenType fonts.
- GDK** The Gimp Drawing Kit for GTK+
- GTK** The GIMP Toolkit ([GTK](#)) graphical user interface library
- JPG** The Joint Photographic Experts Group ([JPEG](#)) compression method and file format for photographic images
- numpy** [numpy](#) is the standard numerical array library for python, the successor to Numeric and numarray. numpy provides fast operations for homogeneous data sets and common mathematical operations like correlations, standard deviation, fourier transforms, and convolutions.
- PDF** Adobe's Portable Document Format ([PDF](#))
- PNG** Portable Network Graphics ([PNG](#)), a raster graphics format that employs lossless data compression which is more suitable for line art than the lossy jpg format. Unlike the gif format, png is not encumbered by requirements for a patent license.
- PS** Postscript ([PS](#)) is a vector graphics ASCII text language widely used in printers and publishing. Postscript was developed by adobe systems and is starting to show its age: for example it does not have an alpha channel. PDF was designed in part as a next-generation document format to replace postscript
- pygtk** [pygtk](#) provides python wrappers for the [GTK](#) widgets library for use with the GTK or GTKAgg backend. Widely used on linux, and is often packaged as 'python-gtk2'
- pyqt** [pyqt](#) provides python wrappers for the [Qt](#) widgets library and is required by the matplotlib Qt5Agg and Qt4Agg backends. Widely used on linux and windows; many linux distributions package this as 'python-qt5' or 'python-qt4'.
- python** [python](#) is an object oriented interpreted language widely used for scripting, application development, web application servers, scientific computing and more.
- pytz** [pytz](#) provides the Olson tz database in Python. it allows accurate and cross platform timezone calculations and solves the issue of ambiguous times at the end of daylight savings
- Qt** [Qt](#) is a cross-platform application framework for desktop and embedded development.
- Qt4** [Qt4](#) is the previous, but most widely used, version of Qt cross-platform application framework for desktop and embedded development.
- Qt5** [Qt5](#) is the current version of Qt cross-platform application framework for desktop and embedded development.
- raster graphics** [Raster graphics](#), or bitmaps, represent an image as an array of pixels which is resolution dependent. Raster graphics are generally most practical for photo-realistic images, but do not scale easily without loss of quality.

SVG The Scalable Vector Graphics format (**SVG**). An XML based vector graphics format supported by many web browsers.

TIFF Tagged Image File Format (**TIFF**) is a file format for storing images, including photographs and line art.

Tk Tk is a graphical user interface for Tcl and many other dynamic languages. It can produce rich, native applications that run unchanged across Windows, Mac OS X, Linux and more.

vector graphics **vector graphics** use geometrical primitives based upon mathematical equations to represent images in computer graphics. Primitives can include points, lines, curves, and shapes or polygons. Vector graphics are scalable, which means that they can be resized without suffering from issues related to inherent resolution like are seen in raster graphics. Vector graphics are generally most practical for typesetting and graphic design applications.

wxpython **wxpython** provides python wrappers for the *wxWidgets* library for use with the WX and WX-Agg backends. Widely used on linux, OS-X and windows, it is often packaged by linux distributions as 'python-wxgtk'

wxWidgets **WX** is cross-platform GUI and tools library for GTK, MS Windows, and MacOS. It uses native widgets for each operating system, so applications will have the look-and-feel that users on that operating system expect.

BIBLIOGRAPHY

[colorcet] <https://github.com/bokeh/colorcet>

[Ware] http://ccom.unh.edu/sites/default/files/publications/Ware_1988_CGA_Color_sequences_univariate_maps.pdf

[Moreland] <http://www.sandia.gov/~kmorel/documents/ColorMaps/ColorMapsExpanded.pdf>

[list-colormaps] <https://gist.github.com/endolith/2719900#id7>

[mycarta-banding] <https://mycarta.wordpress.com/2012/10/14/the-rainbow-is-deadlong-live-the-rainbow-part-4-cie-lab-h>

[mycarta-jet] <https://mycarta.wordpress.com/2012/10/06/the-rainbow-is-deadlong-live-the-rainbow-part-3/>

[mycarta-lablinear] <https://mycarta.wordpress.com/2012/12/06/the-rainbow-is-deadlong-live-the-rainbow-part-5-cie-lab-l>

[mycarta-cubelaw] <https://mycarta.wordpress.com/2013/02/21/perceptual-rainbow-palette-the-method/>

[bw] <http://www.tannerhelland.com/3643/grayscale-image-algorithm-vb6/>

[colorblindness] <http://www.color-blindness.com/>

[vischeck] <http://www.vischeck.com/vischeck/>

[IBM] <http://www.research.ibm.com/people/l/lloydt/color/color.HTM>

[R1] Michel Bernadou, Kamal Hassan, “Basis functions for general Hsieh-Clough-Tocher triangles, complete or reduced.”, *International Journal for Numerical Methods in Engineering*, 17(5):784 - 789. 2.01.

[R2] C.T. Kelley, “Iterative Methods for Optimization”.

PYTHON MODULE INDEX

m

- matplotlib.afm, 487
- matplotlib.animation, 491
- matplotlib.artist, 536
- matplotlib.axis, 794
- matplotlib.backend_bases, 913
- matplotlib.backend_managers, 934
- matplotlib.backend_tools, 937
- matplotlib.backends.backend_pdf, 948
- matplotlib.backends.backend_qt4agg, 946
- matplotlib.backends.backend_qt5agg, 946
- matplotlib.backends.backend_svg, 951
- matplotlib.backends.backend_wxagg, 947
- matplotlib.cbook, 953
- matplotlib.cm, 971
- matplotlib.collections, 975
- matplotlib.colorbar, 1145
- matplotlib.colors, 1151
- matplotlib.container, 1165
- matplotlib.dates, 1167
- matplotlib.dviread, 1181
- matplotlib.figure, 1185
- matplotlib.finance, 1207
- matplotlib.font_manager, 1219
- matplotlib.fontconfig_pattern, 1225
- matplotlib.gridspec, 1227
- matplotlib.image, 1231
- matplotlib.legend, 1237
- matplotlib.legend_handler, 1241
- matplotlib.lines, 1245
- matplotlib.markers, 1255
- matplotlib.mathtext, 1261
- matplotlib.mlab, 1279
- matplotlib.offsetbox, 1313
- matplotlib.patches, 1325
- matplotlib.path, 1367
- matplotlib.patheffects, 92
- matplotlib.projections, 1379
- matplotlib.projections.polar, 1380
- matplotlib.pyplot, 1387
- matplotlib.rcsetup, 1593
- matplotlib.sankey, 1597
- matplotlib.scale, 1605
- matplotlib.sphinxext.plot_directive, 1922
- matplotlib.spines, 1615
- matplotlib.style, 1619
- matplotlib.text, 1621
- matplotlib.ticker, 1635
- matplotlib.tight_layout, 1647
- matplotlib.transforms, 1649
- matplotlib.tri, 1671
- matplotlib.type1font, 1683
- matplotlib.units, 1685
- matplotlib.widgets, 1687
- mpl_toolkits.axes_grid.axes_size, 1795
- mpl_toolkits.axes_grid1.anchored_artists, 1805
- mpl_toolkits.axes_grid1.inset_locator, 1811
- mpl_toolkits.mplot3d.art3d, 1871
- mpl_toolkits.mplot3d.axes3d, 1848
- mpl_toolkits.mplot3d.axis3d, 1870
- mpl_toolkits.mplot3d.proj3d, 1876

Symbols

__call__() (matplotlib.tri.CubicTriInterpolator method), 1675
 __call__() (matplotlib.tri.LinearTriInterpolator method), 1673
 __call__() (matplotlib.tri.TrapezoidMapTriFinder method), 1672
 __init__() (matplotlib.animation.AVConvBase method), 530
 __init__() (matplotlib.animation.AVConvFileWriter method), 521
 __init__() (matplotlib.animation.AVConvWriter method), 517
 __init__() (matplotlib.animation.Animation method), 525
 __init__() (matplotlib.animation.ArtistAnimation method), 493
 __init__() (matplotlib.animation.FFMpegBase method), 530
 __init__() (matplotlib.animation.FFMpegFileWriter method), 519
 __init__() (matplotlib.animation.FFMpegWriter method), 515
 __init__() (matplotlib.animation.FileMovieWriter method), 529
 __init__() (matplotlib.animation.FuncAnimation method), 493
 __init__() (matplotlib.animation.ImageMagickBase method), 530
 __init__() (matplotlib.animation.ImageMagickFileWriter method), 516
 __init__() (matplotlib.animation.ImageMagickWriter method), 520
 __init__() (matplotlib.animation.MencoderBase method), 532
 __init__() (matplotlib.animation.MencoderFileWriter method), 532

__init__() (matplotlib.animation.MencoderWriter method), 533
 __init__() (matplotlib.animation.MovieWriter method), 528
 __init__() (matplotlib.animation.MovieWriterRegistry method), 526
 __init__() (matplotlib.animation.TimedAnimation method), 526
 __init__() (matplotlib.artist.ArtistInspector method), 553

A

AbstractPathEffect (class in matplotlib.patheffects), 1375
 Accent (class in matplotlib.mathtext), 1261
 accent() (matplotlib.mathtext.Parser method), 1272
 acorr() (in module matplotlib.pyplot), 1387
 acorr() (matplotlib.axes.Axes method), 608
 active (matplotlib.widgets.Widget attribute), 1701
 active_toggle (matplotlib.backend_managers.ToolManager attribute), 934
 add() (matplotlib.figure.AxesStack method), 1185
 add() (matplotlib.sankey.Sankey method), 1601
 add_artist() (matplotlib.axes.Axes method), 765
 add_artist() (matplotlib.offsetbox.AuxTransformBox method), 1316
 add_artist() (matplotlib.offsetbox.DrawingArea method), 1318
 add_auto_adjustable_area() (mpl_toolkits.axes_grid.axes_divider.Divider method), 1796
 add_axes() (matplotlib.figure.Figure method), 1186
 add_axobserver() (matplotlib.figure.Figure method), 1188
 add_callback() (matplotlib.artist.Artist method), 537
 add_callback() (matplotlib.axes.Axes method), 769
 add_callback() (matplotlib.axis.Axis method), 878

- add_callback() (matplotlib.axis.Tick method), 838
- add_callback() (matplotlib.axis.XAxis method), 889
- add_callback() (matplotlib.axis.XTick method), 850
- add_callback() (matplotlib.axis.YAxis method), 900
- add_callback() (matplotlib.axis.YTick method), 861
- add_callback() (matplotlib.backend_bases.TimerBase method), 932
- add_callback() (matplotlib.collections.AsteriskPolygonCollection method), 976
- add_callback() (matplotlib.collections.BrokenBarHCollection method), 988
- add_callback() (matplotlib.collections.CircleCollection method), 1000
- add_callback() (matplotlib.collections.Collection method), 1012
- add_callback() (matplotlib.collections.EllipseCollection method), 1024
- add_callback() (matplotlib.collections.EventCollection method), 1036
- add_callback() (matplotlib.collections.LineCollection method), 1049
- add_callback() (matplotlib.collections.PatchCollection method), 1061
- add_callback() (matplotlib.collections.PathCollection method), 1073
- add_callback() (matplotlib.collections.PolyCollection method), 1085
- add_callback() (matplotlib.collections.QuadMesh method), 1097
- add_callback() (matplotlib.collections.RegularPolyCollection method), 1109
- add_callback() (matplotlib.collections.StarPolygonCollection method), 1121
- add_callback() (matplotlib.collections.TriMesh method), 1133
- add_callback() (matplotlib.container.Container method), 1165
- add_checker() (matplotlib.cm.ScalarMappable method), 971
- add_checker() (matplotlib.collections.AsteriskPolygonCollection method), 976
- add_checker() (matplotlib.collections.BrokenBarHCollection method), 988
- add_checker() (matplotlib.collections.CircleCollection method), 1000
- add_checker() (matplotlib.collections.Collection method), 1012
- add_checker() (matplotlib.collections.EllipseCollection method), 1024
- add_checker() (matplotlib.collections.EventCollection method), 1037
- add_checker() (matplotlib.collections.LineCollection method), 1050
- add_checker() (matplotlib.collections.PatchCollection method), 1061
- add_checker() (matplotlib.collections.PathCollection method), 1073
- add_checker() (matplotlib.collections.PolyCollection method), 1085
- add_checker() (matplotlib.collections.QuadMesh method), 1097
- add_checker() (matplotlib.collections.RegularPolyCollection method), 1109
- add_checker() (matplotlib.collections.StarPolygonCollection method), 1122
- add_checker() (matplotlib.collections.TriMesh method), 1133
- add_collection() (matplotlib.axes.Axes method), 765
- add_collection3d() (mpl_toolkits.mplot3d.Axes3D method), 1840
- add_collection3d() (mpl_toolkits.mplot3d.axes3d.Axes3D method), 1848
- add_container() (matplotlib.axes.Axes method), 765

- add_contour_set() (mpl_toolkits.mplot3d.axes3d.Axes3D method), 1848
 add_contourf_set() (mpl_toolkits.mplot3d.axes3d.Axes3D method), 1848
 add_figure() (matplotlib.backend_tools.ToolViewsPosition method), 943
 add_image() (matplotlib.axes.Axes method), 765
 add_line() (matplotlib.axes.Axes method), 765
 add_lines() (matplotlib.colorbar.Colorbar method), 1145
 add_lines() (matplotlib.colorbar.ColorbarBase method), 1146
 add_patch() (matplotlib.axes.Axes method), 766
 add_positions() (matplotlib.collections.EventCollection method), 1037
 add_subplot() (matplotlib.figure.Figure method), 1188
 add_table() (matplotlib.axes.Axes method), 766
 add_tool() (matplotlib.backend_bases.ToolContainerBase method), 932
 add_tool() (matplotlib.backend_managers.ToolManager method), 934
 add_toolitem() (matplotlib.backend_bases.ToolContainerBase method), 932
 add_tools_to_container() (in module matplotlib.backend_tools), 945
 add_tools_to_manager() (in module matplotlib.backend_tools), 945
 adjust_drawing_area() (matplotlib.legend_handler.HandlerBase method), 1242
 Affine2D (class in matplotlib.transforms), 1662
 Affine2DBase (class in matplotlib.transforms), 1661
 AffineBase (class in matplotlib.transforms), 1660
 AFM (class in matplotlib.afm), 487
 afmFontProperty() (in module matplotlib.font_manager), 1224
 AGG, 3017
 alias (matplotlib.mathtext.BakomaFonts attribute), 1261
 align_iterators() (in module matplotlib.cbook), 957
 allequal() (in module matplotlib.cbook), 958
 allow_rasterization() (in module matplotlib.artist), 551
 allpairs() (in module matplotlib.cbook), 958
 alltrue() (in module matplotlib.cbook), 958
 AlphaState() (matplotlib.backends.backend_pdf.PdfFile method), 949
 Annap() (in module matplotlib.mlab), 1284
 aname (matplotlib.artist.Artist attribute), 550
 aname (matplotlib.axes.Axes attribute), 789
 aname (matplotlib.axis.Axis attribute), 878
 aname (matplotlib.axis.Tick attribute), 838
 aname (matplotlib.axis.XAxis attribute), 889
 aname (matplotlib.axis.XTick attribute), 850
 aname (matplotlib.axis.YAxis attribute), 901
 aname (matplotlib.axis.YTick attribute), 861
 aname (matplotlib.collections.AsteriskPolygonCollection attribute), 976
 aname (matplotlib.collections.BrokenBarHCollection attribute), 988
 aname (matplotlib.collections.CircleCollection attribute), 1000
 aname (matplotlib.collections.Collection attribute), 1013
 aname (matplotlib.collections.EllipseCollection attribute), 1024
 aname (matplotlib.collections.EventCollection attribute), 1037
 aname (matplotlib.collections.LineCollection attribute), 1050
 aname (matplotlib.collections.PatchCollection attribute), 1061
 aname (matplotlib.collections.PathCollection attribute), 1073
 aname (matplotlib.collections.PolyCollection attribute), 1085
 aname (matplotlib.collections.QuadMesh attribute), 1097
 aname (matplotlib.collections.RegularPolyCollection attribute), 1109
 aname (matplotlib.collections.StarPolygonCollection attribute), 1122
 aname (matplotlib.collections.TriMesh attribute), 1133
 anchored() (matplotlib.transforms.BboxBase method), 1651
 AnchoredAuxTransformBox (class in mpl_toolkits.axes_grid1.anchored_artists), 1805
 AnchoredDrawingArea (class in mpl_toolkits.axes_grid1.anchored_artists), 1806
 AnchoredEllipse (class in

mpl_toolkits.axes_grid1.anchored_artists), 1808
 AnchoredLocatorBase (class in mpl_toolkits.axes_grid1.inset_locator), 1811
 AnchoredOffsetbox (class in matplotlib.offsetbox), 1313
 AnchoredSizeBar (class in mpl_toolkits.axes_grid1.anchored_artists), 1809
 AnchoredSizeLocator (class in mpl_toolkits.axes_grid1.inset_locator), 1811
 AnchoredText (class in matplotlib.offsetbox), 1314
 AnchoredZoomLocator (class in mpl_toolkits.axes_grid1.inset_locator), 1811
 angle_spectrum() (in module matplotlib.mlab), 1284
 angle_spectrum() (in module matplotlib.pyplot), 1388
 angle_spectrum() (matplotlib.axes.Axes method), 610
 Animation (class in matplotlib.animation), 524
 anncoords (matplotlib.offsetbox.AnnotationBbox attribute), 1315
 anncoords (matplotlib.text.Annotation attribute), 1623
 annotate() (in module matplotlib.pyplot), 1391
 annotate() (matplotlib.axes.Axes method), 714
 Annotation (class in matplotlib.text), 1621
 AnnotationBbox (class in matplotlib.offsetbox), 1315
 append() (matplotlib.cbook.RingBuffer method), 956
 append_axes() (mpl_toolkits.axes_grid1.axes_divider.AxesDivider method), 1799
 append_positions() (matplotlib.collections.EventCollection method), 1037
 append_size() (mpl_toolkits.axes_grid1.axes_divider.Divider method), 1796
 apply_aspect() (matplotlib.axes.Axes method), 754
 apply_tickdir() (matplotlib.axis.Tick method), 808
 apply_tickdir() (matplotlib.axis.XTick method), 810
 apply_tickdir() (matplotlib.axis.YTick method), 812
 apply_window() (in module matplotlib.mlab), 1285
 Arc (class in matplotlib.patches), 1325
 arc() (matplotlib.path.Path class method), 1369
 Arrow (class in matplotlib.patches), 1327
 arrow() (in module matplotlib.pyplot), 1394
 arrow() (matplotlib.axes.Axes method), 718
 ArrowStyle (class in matplotlib.patches), 1328
 ArrowStyle.BarAB (class in matplotlib.patches), 1329
 ArrowStyle.BracketA (class in matplotlib.patches), 1330
 ArrowStyle.BracketAB (class in matplotlib.patches), 1330
 ArrowStyle.BracketB (class in matplotlib.patches), 1330
 ArrowStyle.Curve (class in matplotlib.patches), 1331
 ArrowStyle.CurveA (class in matplotlib.patches), 1331
 ArrowStyle.CurveAB (class in matplotlib.patches), 1331
 ArrowStyle.CurveB (class in matplotlib.patches), 1331
 ArrowStyle.CurveFilledA (class in matplotlib.patches), 1331
 ArrowStyle.CurveFilledAB (class in matplotlib.patches), 1332
 ArrowStyle.CurveFilledB (class in matplotlib.patches), 1332
 ArrowStyle.Fancy (class in matplotlib.patches), 1332
 ArrowStyle.Simple (class in matplotlib.patches), 1332
 ArrowStyle.Wedge (class in matplotlib.patches), 1333
 Artist (class in matplotlib.artist), 537
 artist_picker() (matplotlib.legend.DraggableLegend method), 1317
 artist_picker() (matplotlib.offsetbox.DraggableBase method), 1317
 ArtistAnimation (class in matplotlib.animation), 493
 ArtistInspector (class in matplotlib.artist), 553
 artist() (matplotlib.figure.AxesStack method), 1185
 AsteriskPolygonCollection (class in matplotlib.collections), 975
 attach_note() (matplotlib.backends.backend_pdf.PdfPages method), 950
 auto_adjust_subplotpars() (in module matplotlib.tight_layout), 1647
 auto_delim() (matplotlib.mathtext.Parser method),

1272
 auto_scale_xyz() (mpl_toolkits.mplot3d.axes3d.Axes3D method), 1848
 AutoDateFormatter (class in matplotlib.dates), 1170
 AutoDateLocator (class in matplotlib.dates), 1172
 autofmt_xdate() (matplotlib.figure.Figure method), 1190
 AutoHeightChar (class in matplotlib.mathtext), 1261
 AutoLocator (class in matplotlib.ticker), 1644
 AutoMinorLocator (class in matplotlib.ticker), 1645
 autoscale() (in module matplotlib.pyplot), 1396
 autoscale() (matplotlib.axes.Axes method), 752
 autoscale() (matplotlib.cm.ScalarMappable method), 971
 autoscale() (matplotlib.collections.AsteriskPolygonCollection method), 976
 autoscale() (matplotlib.collections.BrokenBarHCollection method), 988
 autoscale() (matplotlib.collections.CircleCollection method), 1000
 autoscale() (matplotlib.collections.Collection method), 1013
 autoscale() (matplotlib.collections.EllipseCollection method), 1024
 autoscale() (matplotlib.collections.EventCollection method), 1037
 autoscale() (matplotlib.collections.LineCollection method), 1050
 autoscale() (matplotlib.collections.PatchCollection method), 1061
 autoscale() (matplotlib.collections.PathCollection method), 1073
 autoscale() (matplotlib.collections.PolyCollection method), 1085
 autoscale() (matplotlib.collections.QuadMesh method), 1097
 autoscale() (matplotlib.collections.RegularPolygonCollection method), 1109
 autoscale() (matplotlib.collections.StarPolygonCollection method), 1122
 autoscale() (matplotlib.collections.TriMesh method), 1133
 autoscale() (matplotlib.colors.LogNorm method), 1159
 autoscale() (matplotlib.colors.Normalize method), 1160
 autoscale() (matplotlib.colors.PowerNorm method), 1161
 autoscale() (matplotlib.colors.SymLogNorm method), 1161
 autoscale() (matplotlib.dates.AutoDateLocator method), 1172
 autoscale() (matplotlib.dates.RRRuleLocator method), 1171
 autoscale() (matplotlib.dates.YearLocator method), 1173
 autoscale() (matplotlib.ticker.Locator method), 1642
 autoscale() (mpl_toolkits.mplot3d.axes3d.Axes3D method), 1848
 autoscale_None() (matplotlib.cm.ScalarMappable method), 971
 autoscale_None() (matplotlib.collections.AsteriskPolygonCollection method), 976
 autoscale_None() (matplotlib.collections.BrokenBarHCollection method), 988
 autoscale_None() (matplotlib.collections.CircleCollection method), 1000
 autoscale_None() (matplotlib.collections.Collection method), 1013
 autoscale_None() (matplotlib.collections.EllipseCollection method), 1024
 autoscale_None() (matplotlib.collections.EventCollection method), 1037
 autoscale_None() (matplotlib.collections.LineCollection method), 1050
 autoscale_None() (matplotlib.collections.PatchCollection method), 1061
 autoscale_None() (matplotlib.collections.PathCollection method), 1073
 autoscale_None() (matplotlib.collections.PolyCollection method), 1085
 autoscale_None() (matplotlib.collections.QuadMesh method), 1097
 autoscale_None() (matplotlib.collections.RegularPolygonCollection method), 1109
 autoscale_None() (matplotlib.collections.StarPolygonCollection method), 1122
 autoscale_None() (matplotlib.collections.TriMesh method), 1133
 autoscale_None() (matplotlib.colors.LogNorm method), 1159
 autoscale_None() (matplotlib.colors.Normalize method), 1160
 autoscale_None() (matplotlib.colors.PowerNorm method), 1161

- plotlib.collections.StarPolygonCollection method), 1122
- autoscale_None() (matplotlib.collections.TriMesh method), 1133
- autoscale_None() (matplotlib.colors.LogNorm method), 1160
- autoscale_None() (matplotlib.colors.Normalize method), 1160
- autoscale_None() (matplotlib.colors.PowerNorm method), 1161
- autoscale_None() (matplotlib.colors.SymLogNorm method), 1161
- autoscale_view() (matplotlib.axes.Axes method), 753
- autoscale_view() (mpl_toolkits.mplot3d.axes3d.Axes3D method), 1849
- AutoWidthChar (class in matplotlib.mathtext), 1261
- autumn() (in module matplotlib.pyplot), 1396
- AuxTransformBox (class in matplotlib.offsetbox), 1316
- available() (matplotlib.widgets.LockDraw method), 1693
- AVConvBase (class in matplotlib.animation), 530
- AVConvFileWriter (class in matplotlib.animation), 521
- AVConvWriter (class in matplotlib.animation), 517
- ax (matplotlib.colorbar.ColorbarBase attribute), 1146
- Axes (class in matplotlib.axes), 555
- axes (matplotlib.artist.Artist attribute), 547
- axes (matplotlib.axes.Axes attribute), 785
- axes (matplotlib.axis.Axis attribute), 878
- axes (matplotlib.axis.Tick attribute), 838
- axes (matplotlib.axis.XAxis attribute), 890
- axes (matplotlib.axis.XTick attribute), 850
- axes (matplotlib.axis.YAxis attribute), 901
- axes (matplotlib.axis.YTick attribute), 861
- axes (matplotlib.collections.AsteriskPolygonCollection attribute), 976
- axes (matplotlib.collections.BrokenBarHCollection attribute), 988
- axes (matplotlib.collections.CircleCollection attribute), 1000
- axes (matplotlib.collections.Collection attribute), 1013
- axes (matplotlib.collections.EllipseCollection attribute), 1024
- axes (matplotlib.collections.EventCollection attribute), 1037
- axes (matplotlib.collections.LineCollection attribute), 1050
- axes (matplotlib.collections.PatchCollection attribute), 1062
- axes (matplotlib.collections.PathCollection attribute), 1073
- axes (matplotlib.collections.PolyCollection attribute), 1085
- axes (matplotlib.collections.QuadMesh attribute), 1097
- axes (matplotlib.collections.RegularPolyCollection attribute), 1109
- axes (matplotlib.collections.StarPolygonCollection attribute), 1122
- axes (matplotlib.collections.TriMesh attribute), 1133
- axes (matplotlib.figure.Figure attribute), 1190
- axes (matplotlib.lines.Line2D attribute), 1246
- axes (matplotlib.offsetbox.OffsetBox attribute), 1319
- axes() (in module matplotlib.pyplot), 1396
- Axes3D (class in mpl_toolkits.mplot3d.axes3d), 1848
- AxesDivider (class in mpl_toolkits.axes_grid.axes_divider), 1799
- AxesImage (class in matplotlib.image), 1231
- AxesLocator (class in mpl_toolkits.axes_grid.axes_divider), 1798
- AxesStack (class in matplotlib.figure), 1185
- AxesWidget (class in matplotlib.widgets), 1687
- AxesX (class in mpl_toolkits.axes_grid.axes_size), 1795
- AxesY (class in mpl_toolkits.axes_grid.axes_size), 1795
- axhline() (in module matplotlib.pyplot), 1397
- axhline() (matplotlib.axes.Axes method), 601
- axhspan() (in module matplotlib.pyplot), 1399
- axhspan() (matplotlib.axes.Axes method), 603
- Axis (class in matplotlib.axis), 794
- Axis (class in mpl_toolkits.mplot3d.axis3d), 1870
- axis (matplotlib.ticker.TickHelper attribute), 1637
- axis() (in module matplotlib.pyplot), 1401
- axis() (matplotlib.axes.Axes method), 732
- axis_date() (matplotlib.axis.Axis method), 800
- axis_date() (matplotlib.axis.XAxis method), 824
- axis_date() (matplotlib.axis.YAxis method), 815
- axis_name (matplotlib.axis.XAxis attribute), 805

- axis_name (matplotlib.axis.YAxis attribute), 803
- AxisArtist (class in matplotlib.axes.grid.axis_artist), 1802
- AxisInfo (class in matplotlib.units), 1685
- axisinfo() (matplotlib.units.ConversionInterface static method), 1686
- AxisLabel (class in matplotlib.axes.grid.axis_artist), 1804
- AxisScaleBase (class in matplotlib.backend_tools), 937
- axvline() (in module matplotlib.pyplot), 1402
- axvline() (matplotlib.axes.Axes method), 605
- axvspan() (in module matplotlib.pyplot), 1404
- axvspan() (matplotlib.axes.Axes method), 607
- ## B
- back() (matplotlib.backend_bases.NavigationToolbar2 method), 925
- back() (matplotlib.backend_tools.ToolViewsPositions method), 943
- back() (matplotlib.cbook.Stack method), 957
- BakomaFonts (class in matplotlib.mathtext), 1261
- bar() (in module matplotlib.pyplot), 1405
- bar() (matplotlib.axes.Axes method), 583
- bar() (mpl_toolkits.mplot3d.Axes3D method), 1841
- bar() (mpl_toolkits.mplot3d.axes3d.Axes3D method), 1849
- bar3d() (mpl_toolkits.mplot3d.axes3d.Axes3D method), 1849
- barbs() (in module matplotlib.pyplot), 1408
- barbs() (matplotlib.axes.Axes method), 721
- BarContainer (class in matplotlib.container), 1165
- barh() (in module matplotlib.pyplot), 1412
- barh() (matplotlib.axes.Axes method), 586
- base (matplotlib.scale.InvertedLog10Transform attribute), 1605
- base (matplotlib.scale.InvertedLog2Transform attribute), 1605
- base (matplotlib.scale.InvertedNaturalLogTransform attribute), 1606
- base (matplotlib.scale.Log10Transform attribute), 1607
- base (matplotlib.scale.Log2Transform attribute), 1607
- base (matplotlib.scale.LogScale.InvertedLog10Transform attribute), 1608
- base (matplotlib.scale.LogScale.InvertedLog2Transform attribute), 1608
- base (matplotlib.scale.LogScale.InvertedNaturalLogTransform attribute), 1608
- base (matplotlib.scale.LogScale.Log10Transform attribute), 1608
- base (matplotlib.scale.LogScale.Log2Transform attribute), 1608
- base (matplotlib.scale.LogScale.NaturalLogTransform attribute), 1609
- base (matplotlib.scale.NaturalLogTransform attribute), 1611
- base() (matplotlib.ticker.LogFormatter method), 1641
- base() (matplotlib.ticker.LogLocator method), 1644
- base_repr() (in module matplotlib.mlab), 1285
- basepath (matplotlib.mathtext.StandardPsFonts attribute), 1275
- Bbox (class in matplotlib.transforms), 1654
- bbox_artist() (in module matplotlib.offsetbox), 1323
- bbox_artist() (in module matplotlib.patches), 1365
- BboxBase (class in matplotlib.transforms), 1651
- BboxConnector (class in matplotlib.axes.grid1.inset_locator), 1811
- BboxConnectorPatch (class in matplotlib.axes.grid1.inset_locator), 1814
- BboxImage (class in matplotlib.image), 1231
- BboxPatch (class in matplotlib.axes.grid1.inset_locator), 1815
- BboxTransform (class in matplotlib.transforms), 1668
- BboxTransformFrom (class in matplotlib.transforms), 1669
- BboxTransformTo (class in matplotlib.transforms), 1669
- bin_boundaries() (matplotlib.ticker.MaxNLocator method), 1645
- binary_repr() (in module matplotlib.mlab), 1286
- binom() (matplotlib.mathtext.Parser method), 1272
- bivariate_normal() (in module matplotlib.mlab), 1286
- blend_hsv() (matplotlib.colors.LightSource method), 1154
- blend_overlay() (matplotlib.colors.LightSource method), 1154
- blend_soft_light() (matplotlib.colors.LightSource method), 1155

- blended_transform_factory() (in module matplotlib.transforms), 1667
 - BlendedAffine2D (class in matplotlib.transforms), 1666
 - BlendedGenericTransform (class in matplotlib.transforms), 1666
 - blit() (matplotlib.backend_bases.FigureCanvasBase method), 914
 - blit() (matplotlib.backends.backend_qt5agg.FigureCanvasQTAggBase method), 947
 - blit() (matplotlib.backends.backend_wxagg.FigureCanvasWxAgg method), 948
 - bone() (in module matplotlib.pyplot), 1414
 - BoundaryNorm (class in matplotlib.colors), 1152
 - bounds (matplotlib.transforms.BboxBase attribute), 1651
 - Box (class in matplotlib.mathtext), 1262
 - box() (in module matplotlib.pyplot), 1414
 - boxplot() (in module matplotlib.pyplot), 1415
 - boxplot() (matplotlib.axes.Axes method), 636
 - boxplot_stats() (in module matplotlib.cbook), 958
 - BoxStyle (class in matplotlib.patches), 1333
 - BoxStyle.Circle (class in matplotlib.patches), 1334
 - BoxStyle.DArrow (class in matplotlib.patches), 1335
 - BoxStyle.LArrow (class in matplotlib.patches), 1335
 - BoxStyle.RArrow (class in matplotlib.patches), 1335
 - BoxStyle.Round (class in matplotlib.patches), 1335
 - BoxStyle.Round4 (class in matplotlib.patches), 1335
 - BoxStyle.Roundtooth (class in matplotlib.patches), 1335
 - BoxStyle.Sawtooth (class in matplotlib.patches), 1336
 - BoxStyle.Square (class in matplotlib.patches), 1336
 - broken_barh() (in module matplotlib.pyplot), 1420
 - broken_barh() (matplotlib.axes.Axes method), 595
 - BrokenBarHCollection (class in matplotlib.collections), 988
 - bubble() (matplotlib.cbook.Stack method), 957
 - bubble() (matplotlib.figure.AxesStack method), 1185
 - Bunch (class in matplotlib.cbook), 953
 - Button (class in matplotlib.widgets), 1687
 - button (matplotlib.backend_bases.MouseEvent attribute), 924
 - button_press_event() (matplotlib.backend_bases.FigureCanvasBase method), 914
 - button_release_event() (matplotlib.backend_bases.FigureCanvasBase method), 914
 - bxp() (matplotlib.axes.Axes method), 644
 - byAttribute() (matplotlib.cbook.Sorter method), 956
 - byItem() (matplotlib.cbook.Sorter method), 956
- ## C
- c_over_c() (matplotlib.mathtext.Parser method), 1873
 - Cairo, 3017
 - calculate_plane_coefficients() (matplotlib.tri.Triangulation method), 1671
 - CallbackRegistry (class in matplotlib.cbook), 953
 - can_pan() (matplotlib.axes.Axes method), 770
 - can_pan() (matplotlib.projections.polar.PolarAxes method), 1382
 - can_pan() (mpl_toolkits.mplot3d.axes3d.Axes3D method), 1849
 - can_zoom() (matplotlib.axes.Axes method), 771
 - can_zoom() (matplotlib.projections.polar.PolarAxes method), 1382
 - can_zoom() (mpl_toolkits.mplot3d.axes3d.Axes3D method), 1850
 - candlestick2_ochl() (in module matplotlib.finance), 1207
 - candlestick2_ohlc() (in module matplotlib.finance), 1208
 - candlestick_ochl() (in module matplotlib.finance), 1208
 - candlestick_ohlc() (in module matplotlib.finance), 1209
 - center (matplotlib.widgets.RectangleSelector attribute), 1696
 - center() (matplotlib.mlab.PCA method), 1284
 - center_matrix() (in module matplotlib.mlab), 1286
 - change_geometry() (mpl_toolkits.axes_grid.axes_divider.SubplotDiv method), 1799
 - changed() (matplotlib.cm.ScalarMappable method), 971
 - changed() (matplotlib.collections.AsteriskPolygonCollection method), 976
 - changed() (matplotlib.collections.BrokenBarHCollection method), 988
 - changed() (matplotlib.collections.CircleCollection method), 1000
 - changed() (matplotlib.collections.Collection method), 1013

- changed() (matplotlib.collections.EllipseCollection method), 1024
 changed() (matplotlib.collections.EventCollection method), 1037
 changed() (matplotlib.collections.LineCollection method), 1050
 changed() (matplotlib.collections.PatchCollection method), 1062
 changed() (matplotlib.collections.PathCollection method), 1073
 changed() (matplotlib.collections.PolyCollection method), 1085
 changed() (matplotlib.collections.QuadMesh method), 1097
 changed() (matplotlib.collections.RegularPolyCollection method), 1109
 changed() (matplotlib.collections.StarPolygonCollection method), 1122
 changed() (matplotlib.collections.TriMesh method), 1133
 Char (class in matplotlib.mathtext), 1262
 check_update() (matplotlib.cm.ScalarMappable method), 971
 check_update() (matplotlib.collections.AsteriskPolygonCollection method), 977
 check_update() (matplotlib.collections.BrokenBarHCollection method), 989
 check_update() (matplotlib.collections.CircleCollection method), 1001
 check_update() (matplotlib.collections.Collection method), 1013
 check_update() (matplotlib.collections.EllipseCollection method), 1025
 check_update() (matplotlib.collections.EventCollection method), 1037
 check_update() (matplotlib.collections.LineCollection method), 1050
 check_update() (matplotlib.collections.PatchCollection method), 1062
 check_update() (matplotlib.collections.PathCollection method), 1073
 check_update() (matplotlib.collections.PolyCollection method), 1085
 check_update() (matplotlib.collections.QuadMesh method), 1097
 check_update() (matplotlib.collections.RegularPolyCollection method), 1109
 check_update() (matplotlib.collections.StarPolygonCollection method), 1122
 check_update() (matplotlib.collections.TriMesh method), 1134
 CheckButtons (class in matplotlib.widgets), 1688
 checksum (matplotlib.dviread.Tfm attribute), 1183
 Circle (class in matplotlib.patches), 1336
 circle() (matplotlib.path.Path class method), 1369
 circle_ratios() (matplotlib.tri.TriAnalyzer method), 1679
 CircleCollection (class in matplotlib.collections), 1000
 CirclePolygon (class in matplotlib.patches), 1337
 circular_spine() (matplotlib.spines.Spine class method), 1616
 cla() (in module matplotlib.pyplot), 1422
 cla() (matplotlib.axes.Axes method), 731
 cla() (matplotlib.axis.Axis method), 795
 cla() (matplotlib.axis.XAxis method), 825
 cla() (matplotlib.axis.YAxis method), 815
 cla() (matplotlib.spines.Spine method), 1616
 cla() (mpl_toolkits.mplot3d.axes3d.Axes3D method), 1850
 clabel() (in module matplotlib.pyplot), 1422
 clabel() (matplotlib.axes.Axes method), 659
 clabel() (mpl_toolkits.mplot3d.axes3d.Axes3D method), 1850
 clamp() (matplotlib.mathtext.Ship static method), 1274
 clean() (matplotlib.cbook.Grouper method), 955
 cleaned() (matplotlib.path.Path method), 1369
 clear() (matplotlib.axes.Axes method), 731
 clear() (matplotlib.backend_tools.ToolViewsPositions method), 943
 clear() (matplotlib.cbook.MemoryMonitor method), 956
 clear() (matplotlib.cbook.Stack method), 957
 clear() (matplotlib.figure.Figure method), 1190

- clear() (matplotlib.transforms.Affine2D method), 1662
- clear() (matplotlib.widgets.Cursor method), 1690
- clear() (matplotlib.widgets.MultiCursor method), 1694
- clf() (in module matplotlib.pyplot), 1429
- clf() (matplotlib.figure.Figure method), 1190
- clim() (in module matplotlib.pyplot), 1429
- clip_children (matplotlib.offsetbox.DrawingArea attribute), 1318
- clip_to_bbox() (matplotlib.path.Path method), 1369
- close() (in module matplotlib.pyplot), 1429
- close() (matplotlib.backends.backend_pdf.PdfPages method), 950
- close() (matplotlib.dviread.Dvi method), 1181
- close_event() (matplotlib.backend_bases.FigureCanvasBase method), 914
- close_group() (matplotlib.backend_bases.RendererBase method), 927
- CloseEvent (class in matplotlib.backend_bases), 913
- CLOSEPOLY (matplotlib.path.Path attribute), 1368
- closest() (matplotlib.widgets.ToolHandles method), 1700
- cm_fallback (matplotlib.mathtext.StixFonts attribute), 1275
- cmap (matplotlib.cm.ScalarMappable attribute), 971
- code_type (matplotlib.path.Path attribute), 1370
- codes (matplotlib.legend.Legend attribute), 1239
- codes (matplotlib.path.Path attribute), 1370
- cohere() (in module matplotlib.mlab), 1286
- cohere() (in module matplotlib.pyplot), 1430
- cohere() (matplotlib.axes.Axes method), 613
- cohere_pairs() (in module matplotlib.mlab), 1287
- Collection (class in matplotlib.collections), 1011
- Colorbar (class in matplotlib.colorbar), 1145
- colorbar (matplotlib.cm.ScalarMappable attribute), 971
- colorbar() (in module matplotlib.pyplot), 1433
- colorbar() (matplotlib.figure.Figure method), 1190
- colorbar_extend (matplotlib.colors.Colormap attribute), 1153
- colorbar_factory() (in module matplotlib.colorbar), 1147
- ColorbarBase (class in matplotlib.colorbar), 1146
- ColorbarPatch (class in matplotlib.colorbar), 1147
- Colormap (class in matplotlib.colors), 1152
- colormaps() (in module matplotlib.pyplot), 428
- colors() (in module matplotlib.pyplot), 1436
- complex_spectrum() (in module matplotlib.mlab), 1289
- composite_images() (in module matplotlib.image), 1233
- composite_transform_factory() (in module matplotlib.transforms), 1668
- CompositeAffine2D (class in matplotlib.transforms), 1668
- CompositeGenericTransform (class in matplotlib.transforms), 1667
- ComputerModernFontConstants (class in matplotlib.mathtext), 1262
- config_axis() (matplotlib.colorbar.ColorbarBase method), 1146
- ConfigureSubplotsBase (class in matplotlib.backend_tools), 937
- connect() (in module matplotlib.pyplot), 1436
- connect() (matplotlib.cbook.CallbackRegistry method), 954
- connect() (matplotlib.patches.ConnectionStyle.Angle method), 1340
- connect() (matplotlib.patches.ConnectionStyle.Angle3 method), 1341
- connect() (matplotlib.patches.ConnectionStyle.Arc method), 1341
- connect() (matplotlib.patches.ConnectionStyle.Arc3 method), 1341
- connect() (matplotlib.patches.ConnectionStyle.Bar method), 1342
- connect() (matplotlib.widgets.MultiCursor method), 1694
- connect_bbox() (mpl_toolkits.axes_grid1.inset_locator.BboxConnect static method), 1813
- connect_event() (matplotlib.widgets.AxesWidget method), 1687
- ConnectionPatch (class in matplotlib.patches), 1338
- ConnectionStyle (class in matplotlib.patches), 1340
- ConnectionStyle.Angle (class in matplotlib.patches), 1340
- ConnectionStyle.Angle3 (class in matplotlib.patches), 1341
- ConnectionStyle.Arc (class in matplotlib.patches), 1341
- ConnectionStyle.Arc3 (class in matplotlib.patches), 1341
- ConnectionStyle.Bar (class in matplotlib.patches),

- 1341
- Container (class in matplotlib.container), 1165
- contains() (matplotlib.artist.Artist method), 539
- contains() (matplotlib.axes.Axes method), 774
- contains() (matplotlib.axis.Axis method), 878
- contains() (matplotlib.axis.Tick method), 839
- contains() (matplotlib.axis.XAxis method), 890
- contains() (matplotlib.axis.XTick method), 850
- contains() (matplotlib.axis.YAxis method), 901
- contains() (matplotlib.axis.YTick method), 861
- contains() (matplotlib.collections.AsteriskPolygonCollection method), 977
- contains() (matplotlib.collections.BrokenBarHCollection method), 989
- contains() (matplotlib.collections.CircleCollection method), 1001
- contains() (matplotlib.collections.Collection method), 1013
- contains() (matplotlib.collections.EllipseCollection method), 1025
- contains() (matplotlib.collections.EventCollection method), 1037
- contains() (matplotlib.collections.LineCollection method), 1050
- contains() (matplotlib.collections.PatchCollection method), 1062
- contains() (matplotlib.collections.PathCollection method), 1073
- contains() (matplotlib.collections.PolyCollection method), 1085
- contains() (matplotlib.collections.QuadMesh method), 1097
- contains() (matplotlib.collections.RegularPolyCollection method), 1110
- contains() (matplotlib.collections.StarPolygonCollection method), 1122
- contains() (matplotlib.collections.TriMesh method), 1134
- contains() (matplotlib.figure.Figure method), 1193
- contains() (matplotlib.image.BboxImage method), 1232
- contains() (matplotlib.legend.Legend method), 1239
- contains() (matplotlib.lines.Line2D method), 1246
- contains() (matplotlib.offsetbox.AnnotationBbox method), 1315
- contains() (matplotlib.offsetbox.OffsetBox method), 1319
- contains() (matplotlib.patches.Patch method), 1351
- contains() (matplotlib.text.Annotation method), 1623
- contains() (matplotlib.text.Text method), 1626
- contains() (matplotlib.transforms.BboxBase method), 1652
- contains_branch() (matplotlib.transforms.Transform method), 1657
- contains_branch_seperately() (matplotlib.transforms.Transform method), 1657
- contains_path() (matplotlib.path.Path method), 1370
- contains_point() (matplotlib.axes.Axes method), 775
- contains_point() (matplotlib.patches.Patch method), 1352
- contains_point() (matplotlib.path.Path method), 1370
- contains_points() (matplotlib.path.Path method), 1370
- containsx() (matplotlib.transforms.BboxBase method), 1652
- containsy() (matplotlib.transforms.BboxBase method), 1652
- context() (in module matplotlib.style), 1619
- contiguous_regions() (in module matplotlib.mlab), 1290
- contour() (in module matplotlib.pyplot), 1437
- contour() (matplotlib.axes.Axes method), 665
- contour() (mpl_toolkits.mplot3d.Axes3D method), 1836
- contour() (mpl_toolkits.mplot3d.axes3d.Axes3D method), 1850
- contour3D() (mpl_toolkits.mplot3d.axes3d.Axes3D method), 1850
- contourf() (in module matplotlib.pyplot), 1450
- contourf() (matplotlib.axes.Axes method), 677
- contourf() (mpl_toolkits.mplot3d.Axes3D method), 1838
- contourf() (mpl_toolkits.mplot3d.axes3d.Axes3D method), 1850
- contourf3D() (mpl_toolkits.mplot3d.axes3d.Axes3D method), 1851
- ConversionInterface (class in matplotlib.units), 1686
- convert() (matplotlib.units.ConversionInterface static method), 1686
- convert_mesh_to_paths() (matplotlib.collections.QuadMesh static method), 1097
- convert_mesh_to_paths() (mat-

plotlib.collections.TriMesh static method),
 1134
 convert_mesh_to_triangles() (mat-
 plotlib.collections.QuadMesh method),
 1098
 convert_units() (matplotlib.axis.Axis method), 802
 convert_units() (matplotlib.axis.XAxis method), 825
 convert_units() (matplotlib.axis.YAxis method), 815
 convert_xunits() (matplotlib.artist.Artist method),
 549
 convert_xunits() (matplotlib.axes.Axes method), 764
 convert_xunits() (matplotlib.axis.Axis method), 879
 convert_xunits() (matplotlib.axis.Tick method), 839
 convert_xunits() (matplotlib.axis.XAxis method),
 890
 convert_xunits() (matplotlib.axis.XTick method),
 850
 convert_xunits() (matplotlib.axis.YAxis method),
 901
 convert_xunits() (matplotlib.axis.YTick method),
 861
 convert_xunits() (mat-
 plotlib.collections.AsteriskPolygonCollection
 method), 977
 convert_xunits() (mat-
 plotlib.collections.BrokenBarHCollection
 method), 989
 convert_xunits() (mat-
 plotlib.collections.CircleCollection
 method), 1001
 convert_xunits() (matplotlib.collections.Collection
 method), 1013
 convert_xunits() (mat-
 plotlib.collections.EllipseCollection
 method), 1025
 convert_xunits() (mat-
 plotlib.collections.EventCollection
 method), 1037
 convert_xunits() (mat-
 plotlib.collections.LineCollection method),
 1050
 convert_xunits() (mat-
 plotlib.collections.PatchCollection
 method), 1062
 convert_xunits() (mat-
 plotlib.collections.PathCollection method),
 1073
 convert_xunits() (mat-
 plotlib.collections.PolyCollection method),
 1085
 convert_xunits() (matplotlib.collections.QuadMesh
 method), 1098
 convert_xunits() (mat-
 plotlib.collections.RegularPolyCollection
 method), 1110
 convert_xunits() (mat-
 plotlib.collections.StarPolygonCollection
 method), 1122
 convert_xunits() (matplotlib.collections.TriMesh
 method), 1134
 convert_yunits() (matplotlib.artist.Artist method),
 549
 convert_yunits() (matplotlib.axes.Axes method), 764
 convert_yunits() (matplotlib.axis.Axis method), 879
 convert_yunits() (matplotlib.axis.Tick method), 839
 convert_yunits() (matplotlib.axis.XAxis method),
 890
 convert_yunits() (matplotlib.axis.XTick method),
 850
 convert_yunits() (matplotlib.axis.YAxis method),
 901
 convert_yunits() (matplotlib.axis.YTick method),
 862
 convert_yunits() (mat-
 plotlib.collections.AsteriskPolygonCollection
 method), 977
 convert_yunits() (mat-
 plotlib.collections.BrokenBarHCollection
 method), 989
 convert_yunits() (mat-
 plotlib.collections.CircleCollection
 method), 1001
 convert_yunits() (matplotlib.collections.Collection
 method), 1013
 convert_yunits() (mat-
 plotlib.collections.EllipseCollection
 method), 1025
 convert_yunits() (mat-
 plotlib.collections.EventCollection
 method), 1037
 convert_yunits() (mat-
 plotlib.collections.LineCollection method),
 1050
 convert_yunits() (mat-
 plotlib.collections.PatchCollection
 method), 1062

convert_yunits() (matplotlib.collections.PathCollection method), 1074
 convert_yunits() (matplotlib.collections.PolyCollection method), 1086
 convert_yunits() (matplotlib.collections.QuadMesh method), 1098
 convert_yunits() (matplotlib.collections.RegularPolyCollection method), 1110
 convert_yunits() (matplotlib.collections.StarPolygonCollection method), 1122
 convert_yunits() (matplotlib.collections.TriMesh method), 1134
 convert_zunits() (mpl_toolkits.mplot3d.axes3d.Axes3D method), 1851
 converter (class in matplotlib.cbook), 959
 cool() (in module matplotlib.pyplot), 1462
 copper() (in module matplotlib.pyplot), 1462
 copy() (matplotlib.font_manager.FontProperties method), 1222
 copy() (matplotlib.mathtext.GlueSpec method), 1266
 copy() (matplotlib.mathtext.Parser.State method), 1271
 copy() (matplotlib.path.Path method), 1370
 copy_properties() (matplotlib.backend_bases.GraphicsContextBase method), 920
 copy_with_path_effect() (matplotlib.patheffects.PathEffectRenderer method), 1376
 corners (matplotlib.widgets.RectangleSelector attribute), 1696
 corners() (matplotlib.transforms.BboxBase method), 1652
 count_contains() (matplotlib.transforms.BboxBase method), 1652
 count_overlaps() (matplotlib.transforms.BboxBase method), 1652
 covariance_factor() (matplotlib.mlab.GaussianKDE method), 1283
 create_artists() (matplotlib.legend_handler.HandlerBase method), 1242
 create_artists() (matplotlib.legend_handler.HandlerErrorbar method), 1242
 create_artists() (matplotlib.legend_handler.HandlerLine2D method), 1242
 create_artists() (matplotlib.legend_handler.HandlerLineCollection method), 1243
 create_artists() (matplotlib.legend_handler.HandlerPatch method), 1243
 create_artists() (matplotlib.legend_handler.HandlerPolyCollection method), 1243
 create_artists() (matplotlib.legend_handler.HandlerRegularPolyCollection method), 1244
 create_artists() (matplotlib.legend_handler.HandlerStem method), 1244
 create_artists() (matplotlib.legend_handler.HandlerTuple method), 1244
 create_collection() (matplotlib.legend_handler.HandlerCircleCollection method), 1242
 create_collection() (matplotlib.legend_handler.HandlerPathCollection method), 1243
 create_collection() (matplotlib.legend_handler.HandlerRegularPolyCollection method), 1244
 create_dummy_axis() (matplotlib.ticker.TickHelper method), 1637
 createFontList() (in module matplotlib.font_manager), 1224
 cross_from_above() (in module matplotlib.mlab), 1290
 cross_from_below() (in module matplotlib.mlab), 1290
 csd() (in module matplotlib.mlab), 1290
 csd() (in module matplotlib.pyplot), 1462
 csd() (matplotlib.axes.Axes method), 617
 csv2rec() (in module matplotlib.mlab), 1292
 csvformat_factory() (in module matplotlib.mlab), 1293
 CubicTriInterpolator (class in matplotlib.tri), 1674
 current_key_axes() (matplotlib.figure.AxesStack

- method), 1185
- Cursor (class in matplotlib.widgets), 1689
- cursor (matplotlib.backend_tools.ToolPan attribute), 941
- cursor (matplotlib.backend_tools.ToolToggleBase attribute), 942
- cursor (matplotlib.backend_tools.ToolZoom attribute), 944
- Cursors (class in matplotlib.backend_tools), 937
- CURVE3 (matplotlib.path.Path attribute), 1368
- CURVE4 (matplotlib.path.Path attribute), 1368
- customspace() (matplotlib.mathtext.Parser method), 1272
- cycler() (in module matplotlib.rcsetup), 1593
- D**
- datalim_to_dt() (matplotlib.dates.DateLocator method), 1171
- date2num() (in module matplotlib.dates), 1169
- DateFormatter (class in matplotlib.dates), 1169
- DateLocator (class in matplotlib.dates), 1171
- dateutil, 3017
- DayLocator (class in matplotlib.dates), 1174
- dblclick (matplotlib.backend_bases.MouseEvent attribute), 924
- dedent() (in module matplotlib.cbook), 959
- deepcopy() (matplotlib.path.Path method), 1370
- default_keymap (matplotlib.backend_tools.SaveFigureBase attribute), 938
- default_keymap (matplotlib.backend_tools.ToolBack attribute), 938
- default_keymap (matplotlib.backend_tools.ToolBase attribute), 939
- default_keymap (matplotlib.backend_tools.ToolEnableAllNavigation attribute), 940
- default_keymap (matplotlib.backend_tools.ToolEnableNavigation attribute), 940
- default_keymap (matplotlib.backend_tools.ToolForward attribute), 940
- default_keymap (matplotlib.backend_tools.ToolFullScreen attribute), 941
- default_keymap (matplotlib.backend_tools.ToolGrid attribute), 941
- default_keymap (matplotlib.backend_tools.ToolHome attribute), 941
- default_keymap (matplotlib.backend_tools.ToolPan attribute), 941
- default_keymap (matplotlib.backend_tools.ToolQuit attribute), 942
- default_keymap (matplotlib.backend_tools.ToolXScale attribute), 943
- default_keymap (matplotlib.backend_tools.ToolYScale attribute), 944
- default_keymap (matplotlib.backend_tools.ToolZoom attribute), 944
- default_params (matplotlib.ticker.MaxNLocator attribute), 1645
- default_toolbar_tools (in module matplotlib.backend_tools), 946
- default_tools (in module matplotlib.backend_tools), 946
- default_units() (matplotlib.units.ConversionInterface static method), 1686
- DejaVuFonts (class in matplotlib.mathtext), 1263
- DejaVuSansFontConstants (class in matplotlib.mathtext), 1263
- DejaVuSansFonts (class in matplotlib.mathtext), 1263
- DejaVuSerifFontConstants (class in matplotlib.mathtext), 1263
- DejaVuSerifFonts (class in matplotlib.mathtext), 1263
- delaxes() (in module matplotlib.pyplot), 1466
- delaxes() (matplotlib.figure.Figure method), 1193
- delete_masked_points() (in module matplotlib.cbook), 959
- delta (matplotlib.mathtext.ComputerModernFontConstants attribute), 1262
- delta (matplotlib.mathtext.FontConstantsBase attribute), 1263
- delta (matplotlib.mathtext.STIXFontConstants attribute), 1274
- delta_integral (matplotlib.mathtext.ComputerModernFontConstants

attribute), 1262

delta_integral (matplotlib.mathtext.FontConstantsBase attribute), 1264

delta_integral (matplotlib.mathtext.STIXFontConstants attribute), 1274

delta_integral (matplotlib.mathtext.STIXSansFontConstants attribute), 1274

delta_slanted (matplotlib.mathtext.ComputerModernFontConstants attribute), 1262

delta_slanted (matplotlib.mathtext.FontConstantsBase attribute), 1264

delta_slanted (matplotlib.mathtext.STIXFontConstants attribute), 1274

delta_slanted (matplotlib.mathtext.STIXSansFontConstants attribute), 1274

demean() (in module matplotlib.mlab), 1293

deprecate_axes_colorcycle() (in module matplotlib.rcsetup), 1594

deprecate_axes_hold() (in module matplotlib.rcsetup), 1594

deprecate_savefig_extension() (in module matplotlib.rcsetup), 1594

deprecate_svg_embed_char_paths() (in module matplotlib.rcsetup), 1594

deprecate_svg_image_noscale() (in module matplotlib.rcsetup), 1594

deprecated() (in module matplotlib.cbook), 960

depth (matplotlib.dviread.Tfm attribute), 1183

depth (matplotlib.mathtext.Kern attribute), 1267

depth (matplotlib.transforms.Transform attribute), 1657

description (matplotlib.backend_tools.ConfigureSubplotsBase attribute), 937

description (matplotlib.backend_tools.SaveFigureBase attribute), 938

description (matplotlib.backend_tools.ToolBack attribute), 938

description (matplotlib.backend_tools.ToolBase attribute), 939

description (matplotlib.backend_tools.ToolEnableAllNavigation attribute), 940

description (matplotlib.backend_tools.ToolEnableNavigation attribute), 940

description (matplotlib.backend_tools.ToolForward attribute), 940

description (matplotlib.backend_tools.ToolFullScreen attribute), 941

description (matplotlib.backend_tools.ToolGrid attribute), 941

description (matplotlib.backend_tools.ToolHome attribute), 941

description (matplotlib.backend_tools.ToolPan attribute), 942

description (matplotlib.backend_tools.ToolQuit attribute), 942

description (matplotlib.backend_tools.ToolXScale attribute), 943

description (matplotlib.backend_tools.ToolYScale attribute), 944

description (matplotlib.backend_tools.ToolZoom attribute), 944

design_size (matplotlib.dviread.Tfm attribute), 1183

destroy() (matplotlib.backend_bases.FigureManagerBase method), 919

destroy() (matplotlib.backend_tools.ToolBase method), 939

destroy() (matplotlib.mathtext.Fonts method), 1264

destroy() (matplotlib.mathtext.TruetypeFonts method), 1276

detrend() (in module matplotlib.mlab), 1293

detrend_linear() (in module matplotlib.mlab), 1294

detrend_mean() (in module matplotlib.mlab), 1294

detrend_none() (in module matplotlib.mlab), 1295

dict_delall() (in module matplotlib.cbook), 961

disable() (matplotlib.backend_tools.AxisScaleBase method), 937

disable() (matplotlib.backend_tools.ToolFullScreen method), 941

disable() (matplotlib.backend_tools.ToolGrid method), 941

disable() (matplotlib.backend_tools.ToolToggleBase method), 942

disable() (matplotlib.backend_tools.ZoomPanBase method), 944

disable_mouse_rotation() (mpl_toolkits.mplot3d.axes3d.Axes3D method), 1851

disconnect() (in module matplotlib.pyplot), 1466

disconnect() (matplotlib.cbook.CallbackRegistry

- method), 954
- disconnect() (matplotlib.offsetbox.DraggableBase method), 1317
- disconnect() (matplotlib.widgets.Button method), 1688
- disconnect() (matplotlib.widgets.CheckButtons method), 1689
- disconnect() (matplotlib.widgets.MultiCursor method), 1694
- disconnect() (matplotlib.widgets.RadioButtons method), 1695
- disconnect() (matplotlib.widgets.Slider method), 1698
- disconnect_events() (matplotlib.widgets.AxesWidget method), 1687
- dist() (in module matplotlib.mlab), 1295
- dist_point_to_segment() (in module matplotlib.mlab), 1295
- distances_along_curve() (in module matplotlib.mlab), 1295
- Divider (class in mpl_toolkits.axes_grid.axes_divider), 1796
- do_3d_projection() (mpl_toolkits.mplot3d.art3d.Line3DCollection method), 1871
- do_3d_projection() (mpl_toolkits.mplot3d.art3d.Patch3D method), 1872
- do_3d_projection() (mpl_toolkits.mplot3d.art3d.Patch3DCollection method), 1872
- do_3d_projection() (mpl_toolkits.mplot3d.art3d.Path3DCollection method), 1873
- do_3d_projection() (mpl_toolkits.mplot3d.art3d.PathPatch3D method), 1873
- do_3d_projection() (mpl_toolkits.mplot3d.art3d.Poly3DCollection method), 1873
- donothing_callback() (in module matplotlib.mlab), 1295
- dpi (matplotlib.figure.Figure attribute), 1193
- drag_pan() (matplotlib.axes.Axes method), 772
- drag_pan() (matplotlib.backend_bases.NavigationToolbar2 method), 925
- drag_zoom() (matplotlib.backend_bases.NavigationToolbar2 method), 925
- draggable() (matplotlib.legend.Legend method), 1239
- DraggableAnnotation (class in matplotlib.offsetbox), 1316
- DraggableBase (class in matplotlib.offsetbox), 1316
- DraggableLegend (class in matplotlib.legend), 1237
- DraggableOffsetBox (class in matplotlib.offsetbox), 1317
- drange() (in module matplotlib.dates), 1169
- draw() (in module matplotlib.pyplot), 1466
- draw() (matplotlib.artist.Artist method), 543
- draw() (matplotlib.axes.Axes method), 777
- draw() (matplotlib.axis.Axis method), 879
- draw() (matplotlib.axis.Tick method), 839
- draw() (matplotlib.axis.XAxis method), 890
- draw() (matplotlib.axis.XTick method), 850
- draw() (matplotlib.axis.YAxis method), 901
- draw() (matplotlib.axis.YTick method), 862
- draw() (matplotlib.backend_bases.FigureCanvasBase method), 914
- draw() (matplotlib.backend_bases.NavigationToolbar2 method), 925
- draw() (matplotlib.backends.backend_qt5agg.FigureCanvasQTAggBase method), 947
- draw() (matplotlib.backends.backend_wxagg.FigureCanvasWxAgg method), 948
- draw() (matplotlib.collections.AsteriskPolygonCollection method), 977
- draw() (matplotlib.collections.BrokenBarHCollection method), 989
- draw() (matplotlib.collections.CircleCollection method), 1001
- draw() (matplotlib.collections.Collection method), 1013
- draw() (matplotlib.collections.EllipseCollection method), 1025
- draw() (matplotlib.collections.EventCollection method), 1037
- draw() (matplotlib.collections.LineCollection method), 1050
- draw() (matplotlib.collections.PatchCollection method), 1062
- draw() (matplotlib.collections.PathCollection method), 1074
- draw() (matplotlib.collections.PolyCollection method), 1086
- draw() (matplotlib.collections.QuadMesh method), 1098
- draw() (matplotlib.collections.RegularPolyCollection method), 1110
- draw() (matplotlib.collections.StarPolygonCollection method), 1122

- draw() (matplotlib.collections.TriMesh method), 1134
- draw() (matplotlib.figure.Figure method), 1193
- draw() (matplotlib.legend.Legend method), 1240
- draw() (matplotlib.lines.Line2D method), 1246
- draw() (matplotlib.offsetbox.AnchoredOffsetbox method), 1314
- draw() (matplotlib.offsetbox.AnnotationBbox method), 1315
- draw() (matplotlib.offsetbox.AuxTransformBox method), 1316
- draw() (matplotlib.offsetbox.DrawingArea method), 1318
- draw() (matplotlib.offsetbox.OffsetBox method), 1319
- draw() (matplotlib.offsetbox.OffsetImage method), 1320
- draw() (matplotlib.offsetbox.PaddedBox method), 1321
- draw() (matplotlib.offsetbox.TextArea method), 1322
- draw() (matplotlib.patches.Arc method), 1326
- draw() (matplotlib.patches.ConnectionPatch method), 1339
- draw() (matplotlib.patches.FancyArrowPatch method), 1346
- draw() (matplotlib.patches.Patch method), 1352
- draw() (matplotlib.patches.Shadow method), 1362
- draw() (matplotlib.spines.Spine method), 1616
- draw() (matplotlib.text.Annotation method), 1624
- draw() (matplotlib.text.Text method), 1626
- draw() (matplotlib.text.TextWithDash method), 1632
- draw() (mpl_toolkits.axes_grid.axis_artist.AxisArtist method), 1802
- draw() (mpl_toolkits.axes_grid1.inset_locator.AnchoredOffsetbox method), 1811
- draw() (mpl_toolkits.mplot3d.art3d.Line3D method), 1871
- draw() (mpl_toolkits.mplot3d.art3d.Line3DCollection method), 1871
- draw() (mpl_toolkits.mplot3d.art3d.Patch3D method), 1872
- draw() (mpl_toolkits.mplot3d.art3d.Poly3DCollection method), 1873
- draw() (mpl_toolkits.mplot3d.art3d.Text3D method), 1874
- draw() (mpl_toolkits.mplot3d.axes3d.Axes3D method), 1851
- draw() (mpl_toolkits.mplot3d.axis3d.Axis method), 1870
- draw_all() (matplotlib.colorbar.ColorbarBase method), 1146
- draw_artist() (matplotlib.axes.Axes method), 777
- draw_artist() (matplotlib.figure.Figure method), 1193
- draw_bbox() (in module matplotlib.patches), 1365
- draw_cursor() (matplotlib.backend_bases.FigureCanvasBase method), 914
- draw_event() (matplotlib.backend_bases.FigureCanvasBase method), 914
- draw_frame() (matplotlib.legend.Legend method), 1240
- draw_frame() (matplotlib.offsetbox.PaddedBox method), 1321
- draw_gouraud_triangle() (matplotlib.backend_bases.RendererBase method), 928
- draw_gouraud_triangles() (matplotlib.backend_bases.RendererBase method), 928
- draw_idle() (matplotlib.backend_bases.FigureCanvasBase method), 914
- draw_idle() (matplotlib.backends.backend_qt5agg.FigureCanvasQTAgg method), 947
- draw_image() (matplotlib.backend_bases.RendererBase method), 928
- draw_markers() (matplotlib.backend_bases.RendererBase method), 928
- draw_path() (matplotlib.backend_bases.RendererBase method), 1376
- draw_pane() (mpl_toolkits.mplot3d.axis3d.Axis method), 1870
- draw_path() (matplotlib.backend_bases.RendererBase method), 928
- draw_path() (matplotlib.patheffects.AbstractPathEffect method), 1375
- draw_path() (matplotlib.patheffects.PathEffectRenderer method), 1376
- draw_path() (matplotlib.patheffects.PathPatchEffect method), 1376
- draw_path() (matplotlib.patheffects.SimpleLineShadow

- method), 1377
 - draw_path() (matplotlib.patheffects.SimplePatchShadow method), 1377
 - draw_path() (matplotlib.patheffects.Stroke method), 1377
 - draw_path() (matplotlib.patheffects.withSimplePatchShadow method), 1378
 - draw_path() (matplotlib.patheffects.withStroke method), 1378
 - draw_path_collection() (matplotlib.backend_bases.RendererBase method), 928
 - draw_path_collection() (matplotlib.patheffects.PathEffectRenderer method), 1376
 - draw_quad_mesh() (matplotlib.backend_bases.RendererBase method), 929
 - draw_rubberband() (matplotlib.backend_bases.NavigationToolbar2 method), 925
 - draw_rubberband() (matplotlib.backend_tools.RubberbandBase method), 938
 - draw_shape() (matplotlib.widgets.EllipseSelector method), 1692
 - draw_shape() (matplotlib.widgets.RectangleSelector method), 1696
 - draw_tex() (matplotlib.backend_bases.RendererBase method), 929
 - draw_text() (matplotlib.backend_bases.RendererBase method), 929
 - DrawEvent (class in matplotlib.backend_bases), 913
 - DrawingArea (class in matplotlib.offsetbox), 1318
 - drawon (matplotlib.widgets.Widget attribute), 1701
 - drawRectangle() (matplotlib.backends.backend_qt5agg.FigureCanvasQTAgg method), 947
 - drawStyleKeys (matplotlib.lines.Line2D attribute), 1247
 - drawStyles (matplotlib.lines.Line2D attribute), 1247
 - Dvi (class in matplotlib.dviread), 1181
 - DviFont (class in matplotlib.dviread), 1181
 - dynamic_update() (matplotlib.backend_bases.NavigationToolbar2 method), 925
- ## E
- edge_centers (matplotlib.widgets.RectangleSelector attribute), 1697
 - edges (matplotlib.tri.Triangulation attribute), 1672
 - Ellipse (class in matplotlib.patches), 1342
 - EllipseCollection (class in matplotlib.collections), 1023
 - EllipseSelector (class in matplotlib.widgets), 1690
 - embedTTF() (matplotlib.backends.backend_pdf.PdfFile method), 949
 - empty() (matplotlib.cbook.Stack method), 957
 - enable() (matplotlib.backend_tools.AxisScaleBase method), 937
 - enable() (matplotlib.backend_tools.ToolFullScreen method), 941
 - enable() (matplotlib.backend_tools.ToolGrid method), 941
 - enable() (matplotlib.backend_tools.ToolToggleBase method), 942
 - enable() (matplotlib.backend_tools.ZoomPanBase method), 944
 - Encoding (class in matplotlib.dviread), 1182
 - encoding (matplotlib.dviread.Encoding attribute), 1182
 - end() (matplotlib.backends.backend_pdf.Stream method), 951
 - end_group() (matplotlib.mathtext.Parser method), 1272
 - end_pan() (matplotlib.axes.Axes method), 772
 - enter_notify_event() (matplotlib.backend_bases.FigureCanvasBase method), 914
 - entropy() (in module matplotlib.mlab), 1295
 - environment variable
 - HOME, 1742, 1745
 - MPLBACKEND, 325, 1719, 1720, 1745, 1909
 - MPLCONFIGDIR, 1742, 1745
 - PATH, 135, 139, 140, 143, 1745
 - PYTHONPATH, 1745, 1909
 - epoch2num() (in module matplotlib.dates), 1169
 - EPS, 3017
 - Error() (in module matplotlib.mathtext), 1263
 - errorbar() (in module matplotlib.pyplot), 1467
 - errorbar() (matplotlib.axes.Axes method), 560
 - ErrorbarContainer (class in matplotlib.container), 1165

- evaluate() (matplotlib.mlab.GaussianKDE method), 1283
 Event (class in matplotlib.backend_bases), 913
 EventCollection (class in matplotlib.collections), 1035
 eventplot() (in module matplotlib.pyplot), 1470
 eventplot() (matplotlib.axes.Axes method), 590
 events (matplotlib.backend_bases.FigureCanvasBase attribute), 915
 eventson (matplotlib.widgets.Widget attribute), 1701
 exception_to_str() (in module matplotlib.cbook), 961
 exp_safe() (in module matplotlib.mlab), 1295
 expanded() (matplotlib.transforms.BboxBase method), 1652
 extend_positions() (matplotlib.collections.EventCollection method), 1037
 extents (matplotlib.transforms.BboxBase attribute), 1652
 extents (matplotlib.widgets.RectangleSelector attribute), 1697
- ## F
- factory() (matplotlib.mathtext.GlueSpec class method), 1266
 family_escape() (in module matplotlib.fontconfig_pattern), 1225
 family_name (matplotlib.afm.AFM attribute), 487
 family_unescape() (in module matplotlib.fontconfig_pattern), 1225
 FancyArrow (class in matplotlib.patches), 1343
 FancyArrowPatch (class in matplotlib.patches), 1344
 FancyBboxPatch (class in matplotlib.patches), 1347
 fetch_historical_yahoo() (in module matplotlib.finance), 1210
 FFMpegBase (class in matplotlib.animation), 530
 FFMpegFileWriter (class in matplotlib.animation), 519
 FFMpegWriter (class in matplotlib.animation), 514
 fftsurf() (in module matplotlib.mlab), 1296
 figaspect() (in module matplotlib.figure), 1205
 figimage() (in module matplotlib.pyplot), 1472
 figimage() (matplotlib.figure.Figure method), 1193
 figlegend() (in module matplotlib.pyplot), 1474
 fignum_exists() (in module matplotlib.pyplot), 1474
 figtext() (in module matplotlib.pyplot), 1474
 Figure (class in matplotlib.figure), 1186
 figure (matplotlib.backend_tools.ToolBase attribute), 939
 figure() (in module matplotlib.pyplot), 1476
 FigureCanvas (in module matplotlib.backends.backend_pdf), 948
 FigureCanvas (in module matplotlib.backends.backend_qt4agg), 946
 FigureCanvas (in module matplotlib.backends.backend_qt5agg), 946
 FigureCanvas (in module matplotlib.backends.backend_wxagg), 947
 FigureCanvasBase (class in matplotlib.backend_bases), 914
 FigureCanvasPdf (class in matplotlib.backends.backend_pdf), 948
 FigureCanvasQTAagg (class in matplotlib.backends.backend_qt4agg), 946
 FigureCanvasQTAagg (class in matplotlib.backends.backend_qt5agg), 946
 FigureCanvasQTAaggBase (class in matplotlib.backends.backend_qt4agg), 946
 FigureCanvasQTAaggBase (class in matplotlib.backends.backend_qt5agg), 947
 FigureCanvasWxAgg (class in matplotlib.backends.backend_wxagg), 947
 FigureFrameWxAgg (class in matplotlib.backends.backend_wxagg), 948
 FigureImage (class in matplotlib.image), 1232
 FigureManagerBase (class in matplotlib.backend_bases), 919
 Fil (class in matplotlib.mathtext), 1263
 file_requires_unicode() (in module matplotlib.cbook), 961
 FileMovieWriter (class in matplotlib.animation), 529
 filetypes (matplotlib.backend_bases.FigureCanvasBase attribute), 915
 filetypes (matplotlib.backends.backend_wxagg.FigureCanvasWxAgg attribute), 948
 Fill (class in matplotlib.mathtext), 1263
 fill (matplotlib.patches.Patch attribute), 1352
 fill() (in module matplotlib.backends.backend_pdf), 951
 fill() (in module matplotlib.pyplot), 1476
 fill() (matplotlib.axes.Axes method), 599
 fill_between() (in module matplotlib.pyplot), 1478
 fill_between() (matplotlib.axes.Axes method), 575
 fill_betweenx() (in module matplotlib.pyplot), 1482

- fill_betweenx() (matplotlib.axes.Axes method), 580
- filled_markers (matplotlib.lines.Line2D attribute), 1247
- filled_markers (matplotlib.markers.MarkerStyle attribute), 1257
- Filll (class in matplotlib.mathtext), 1263
- fillStyles (matplotlib.lines.Line2D attribute), 1247
- fillstyles (matplotlib.markers.MarkerStyle attribute), 1257
- finalize_offset() (matplotlib.legend.DraggableLegend method), 1237
- finalize_offset() (matplotlib.offsetbox.DraggableBase method), 1317
- find() (in module matplotlib.mlab), 1296
- find_tex_file() (in module matplotlib.dviread), 1183
- finddir() (in module matplotlib.cbook), 961
- findfont() (in module matplotlib.font_manager), 1224
- findfont() (matplotlib.font_manager.FontManager method), 1219
- findobj() (in module matplotlib.pyplot), 1485
- findobj() (matplotlib.artist.Artist method), 548
- findobj() (matplotlib.axes.Axes method), 776
- findobj() (matplotlib.axis.Axis method), 879
- findobj() (matplotlib.axis.Tick method), 839
- findobj() (matplotlib.axis.XAxis method), 890
- findobj() (matplotlib.axis.XTick method), 851
- findobj() (matplotlib.axis.YAxis method), 901
- findobj() (matplotlib.axis.YTick method), 862
- findobj() (matplotlib.collections.AsteriskPolygonCollection method), 977
- findobj() (matplotlib.collections.BrokenBarHCollection method), 989
- findobj() (matplotlib.collections.CircleCollection method), 1001
- findobj() (matplotlib.collections.Collection method), 1013
- findobj() (matplotlib.collections.EllipseCollection method), 1025
- findobj() (matplotlib.collections.EventCollection method), 1037
- findobj() (matplotlib.collections.LineCollection method), 1050
- findobj() (matplotlib.collections.PatchCollection method), 1062
- findobj() (matplotlib.collections.PathCollection method), 1074
- findobj() (matplotlib.collections.PolyCollection method), 1086
- findobj() (matplotlib.collections.QuadMesh method), 1098
- findobj() (matplotlib.collections.RegularPolyCollection method), 1110
- findobj() (matplotlib.collections.StarPolygonCollection method), 1122
- findobj() (matplotlib.collections.TriMesh method), 1134
- findSystemFonts() (in module matplotlib.font_manager), 1224
- finish() (matplotlib.animation.MovieWriter method), 523
- finish() (matplotlib.sankey.Sankey method), 1603
- fix_minus() (matplotlib.ticker.Formatter method), 1637
- fix_minus() (matplotlib.ticker.ScalarFormatter method), 1639
- Fixed (class in mpl_toolkits.axes_grid.axes_size), 1795
- fixed_dpi (matplotlib.backend_bases.FigureCanvasBase attribute), 915
- FixedFormatter (class in matplotlib.ticker), 1638
- FixedLocator (class in matplotlib.ticker), 1643
- flag() (in module matplotlib.pyplot), 1485
- flatten() (in module matplotlib.cbook), 961
- flipy() (matplotlib.backend_bases.RendererBase method), 929
- flush_events() (matplotlib.backend_bases.FigureCanvasBase method), 915
- font (matplotlib.mathtext.Parser.State attribute), 1272
- font() (matplotlib.mathtext.Parser method), 1272
- FontconfigPatternParser (class in matplotlib.fontconfig_pattern), 1225
- FontConstantsBase (class in matplotlib.mathtext), 1263
- FontEntry (class in matplotlib.font_manager), 1219
- FontManager (class in matplotlib.font_manager), 1219
- fontmap (matplotlib.mathtext.StandardPsFonts attribute), 1275
- fontName() (matplotlib.backends.backend_pdf.PdfFile method), 949
- FontProperties (class in matplotlib.font_manager),

- 1221
- Fonts (class in matplotlib.mathtext), 1264
- format_coord() (matplotlib.axes.Axes method), 772
- format_coord() (matplotlib.projections.polar.PolarAxes method), 1382
- format_coord() (mpl_toolkits.mplot3d.axes3d.Axes3D method), 1851
- format_cursor_data() (matplotlib.artist.Artist method), 537
- format_cursor_data() (matplotlib.axes.Axes method), 772
- format_cursor_data() (matplotlib.axis.Axis method), 879
- format_cursor_data() (matplotlib.axis.Tick method), 839
- format_cursor_data() (matplotlib.axis.XAxis method), 891
- format_cursor_data() (matplotlib.axis.XTick method), 851
- format_cursor_data() (matplotlib.axis.YAxis method), 902
- format_cursor_data() (matplotlib.axis.YTick method), 862
- format_cursor_data() (matplotlib.collections.AsteriskPolygonCollection method), 977
- format_cursor_data() (matplotlib.collections.BrokenBarHCollection method), 989
- format_cursor_data() (matplotlib.collections.CircleCollection method), 1001
- format_cursor_data() (matplotlib.collections.Collection method), 1013
- format_cursor_data() (matplotlib.collections.EllipseCollection method), 1025
- format_cursor_data() (matplotlib.collections.EventCollection method), 1038
- format_cursor_data() (matplotlib.collections.LineCollection method), 1050
- format_cursor_data() (matplotlib.collections.PatchCollection method), 1062
- format_cursor_data() (matplotlib.collections.PathCollection method), 1074
- format_cursor_data() (matplotlib.collections.PolyCollection method), 1086
- format_cursor_data() (matplotlib.collections.QuadMesh method), 1098
- format_cursor_data() (matplotlib.collections.RegularPolyCollection method), 1110
- format_cursor_data() (matplotlib.collections.StarPolygonCollection method), 1122
- format_cursor_data() (matplotlib.collections.TriMesh method), 1134
- format_data() (matplotlib.ticker.Formatter method), 1638
- format_data() (matplotlib.ticker.LogFormatter method), 1641
- format_data() (matplotlib.ticker.ScalarFormatter method), 1639
- format_data_short() (matplotlib.ticker.Formatter method), 1638
- format_data_short() (matplotlib.ticker.LogFormatter method), 1641
- format_data_short() (matplotlib.ticker.ScalarFormatter method), 1639
- format_xdata() (matplotlib.axes.Axes method), 772
- format_ydata() (matplotlib.axes.Axes method), 773
- format_zdata() (mpl_toolkits.mplot3d.axes3d.Axes3D method), 1851
- FormatBool (class in matplotlib.mlab), 1281
- FormatDate (class in matplotlib.mlab), 1281
- FormatDatetime (class in matplotlib.mlab), 1281
- FormatFloat (class in matplotlib.mlab), 1281
- FormatFormatStr (class in matplotlib.mlab), 1281
- FormatInt (class in matplotlib.mlab), 1281
- FormatMillions (class in matplotlib.mlab), 1282
- FormatObj (class in matplotlib.mlab), 1282
- FormatPercent (class in matplotlib.mlab), 1282
- FormatStrFormatter (class in matplotlib.ticker), 1638
- FormatString (class in matplotlib.mlab), 1282
- Formatter (class in matplotlib.ticker), 1637
- FormatThousands (class in matplotlib.mlab), 1282

forward() (matplotlib.backend_bases.NavigationToolbar2 method), 926

forward() (matplotlib.backend_tools.ToolViewsPositioner method), 943

forward() (matplotlib.cbook.Stack method), 957

frac() (matplotlib.mathtext.Parser method), 1272

Fraction (class in mpl_toolkits.axes_grid.axes_size), 1795

frange() (in module matplotlib.mlab), 1296

FreeType, 3017

from_any() (in module mpl_toolkits.axes_grid.axes_size), 1795

from_bounds() (matplotlib.transforms.Bbox static method), 1655

from_extents() (matplotlib.transforms.Bbox static method), 1655

from_levels_and_colors() (in module matplotlib.colors), 1161

from_list() (matplotlib.colors.LinearSegmentedColormap static method), 1159

from_values() (matplotlib.transforms.Affine2D static method), 1662

fromstr() (matplotlib.mlab.FormatBool method), 1281

fromstr() (matplotlib.mlab.FormatDate method), 1281

fromstr() (matplotlib.mlab.FormatDatetime method), 1281

fromstr() (matplotlib.mlab.FormatFloat method), 1281

fromstr() (matplotlib.mlab.FormatInt method), 1281

fromstr() (matplotlib.mlab.FormatObj method), 1282

frozen() (matplotlib.transforms.Affine2DBase method), 1661

frozen() (matplotlib.transforms.BboxBase method), 1652

frozen() (matplotlib.transforms.BlendedGenericTransform method), 1666

frozen() (matplotlib.transforms.CompositeGenericTransform method), 1667

frozen() (matplotlib.transforms.IdentityTransform method), 1664

frozen() (matplotlib.transforms.TransformNode method), 1651

frozen() (matplotlib.transforms.TransformWrapper method), 1660

full_screen_toggle() (matplotlib.backend_bases.FigureManagerBase method), 919

fully_contains() (matplotlib.transforms.BboxBase method), 1652

fully_containsx() (matplotlib.transforms.BboxBase method), 1652

fully_containsy() (matplotlib.transforms.BboxBase method), 1652

fully_overlaps() (matplotlib.transforms.BboxBase method), 1652

FuncAnimation (class in matplotlib.animation), 491

funcbottom() (matplotlib.widgets.SubplotTool method), 1700

FuncFormatter (class in matplotlib.ticker), 1638

funcspace() (matplotlib.widgets.SubplotTool method), 1700

funcleft() (matplotlib.widgets.SubplotTool method), 1700

funcright() (matplotlib.widgets.SubplotTool method), 1700

function() (matplotlib.mathtext.Parser method), 1272

funcstop() (matplotlib.widgets.SubplotTool method), 1700

funcwspace() (matplotlib.widgets.SubplotTool method), 1700

G

GaussianKDE (class in matplotlib.mlab), 1282

gca() (in module matplotlib.pyplot), 1485

gca() (matplotlib.figure.Figure method), 1195

gcf() (in module matplotlib.pyplot), 1486

gci() (in module matplotlib.pyplot), 1486

GDK, 3017

generate_fontconfig_pattern() (in module matplotlib.fontconfig_pattern), 1225

genfrac() (matplotlib.mathtext.Parser method), 1272

geometry (matplotlib.widgets.RectangleSelector attribute), 1697

get() (in module matplotlib.artist), 551

get() (matplotlib.cbook.RingBuffer method), 956

get() (matplotlib.figure.AxesStack method), 1185

get() (matplotlib.font_manager.TempCache method), 1223

get_aa() (matplotlib.lines.Line2D method), 1247

get_aa() (matplotlib.patches.Patch method), 1352

get_active() (matplotlib.widgets.Widget method), 1701

- `get_adjustable()` (matplotlib.axes.Axes method), 755
`get_affine()` (matplotlib.transforms.AffineBase method), 1660
`get_affine()` (matplotlib.transforms.BlendedGenericTransform method), 1666
`get_affine()` (matplotlib.transforms.CompositeGenericTransform method), 1667
`get_affine()` (matplotlib.transforms.IdentityTransform method), 1664
`get_affine()` (matplotlib.transforms.Transform method), 1658
`get_agg_filter()` (matplotlib.artist.Artist method), 543
`get_agg_filter()` (matplotlib.axes.Axes method), 782
`get_agg_filter()` (matplotlib.axis.Axis method), 879
`get_agg_filter()` (matplotlib.axis.Tick method), 840
`get_agg_filter()` (matplotlib.axis.XAxis method), 891
`get_agg_filter()` (matplotlib.axis.XTick method), 851
`get_agg_filter()` (matplotlib.axis.YAxis method), 902
`get_agg_filter()` (matplotlib.axis.YTick method), 862
`get_agg_filter()` (matplotlib.collections.AsteriskPolygonCollection method), 977
`get_agg_filter()` (matplotlib.collections.BrokenBarHCollection method), 989
`get_agg_filter()` (matplotlib.collections.CircleCollection method), 1001
`get_agg_filter()` (matplotlib.collections.Collection method), 1013
`get_agg_filter()` (matplotlib.collections.EllipseCollection method), 1025
`get_agg_filter()` (matplotlib.collections.EventCollection method), 1038
`get_agg_filter()` (matplotlib.collections.LineCollection method), 1051
`get_agg_filter()` (matplotlib.collections.PatchCollection method), 1062
`get_agg_filter()` (matplotlib.collections.PathCollection method), 1074
`get_agg_filter()` (matplotlib.collections.PolyCollection method), 1086
`get_agg_filter()` (matplotlib.collections.QuadMesh method), 1098
`get_agg_filter()` (matplotlib.collections.RegularPolyCollection method), 1110
`get_agg_filter()` (matplotlib.collections.StarPolygonCollection method), 1122
`get_alpha()` (matplotlib.artist.Artist method), 543
`get_alpha()` (matplotlib.axes.Axes method), 783
`get_alpha()` (matplotlib.axis.Axis method), 880
`get_alpha()` (matplotlib.axis.Tick method), 840
`get_alpha()` (matplotlib.axis.XAxis method), 891
`get_alpha()` (matplotlib.axis.XTick method), 851
`get_alpha()` (matplotlib.axis.YAxis method), 902
`get_alpha()` (matplotlib.axis.YTick method), 862
`get_alpha()` (matplotlib.backend_bases.GraphicsContextBase method), 920
`get_alpha()` (matplotlib.collections.AsteriskPolygonCollection method), 977
`get_alpha()` (matplotlib.collections.BrokenBarHCollection method), 989
`get_alpha()` (matplotlib.collections.CircleCollection method), 1001
`get_alpha()` (matplotlib.collections.Collection method), 1013
`get_alpha()` (matplotlib.collections.EllipseCollection method), 1025
`get_alpha()` (matplotlib.collections.EventCollection method), 1038
`get_alpha()` (matplotlib.collections.LineCollection method), 1051
`get_alpha()` (matplotlib.collections.PatchCollection method), 1062
`get_alpha()` (matplotlib.collections.PathCollection method), 1074
`get_alpha()` (matplotlib.collections.PolyCollection method), 1086
`get_alpha()` (matplotlib.collections.QuadMesh method), 1098
`get_alpha()` (matplotlib.collections.RegularPolyCollection method), 1110
`get_alpha()` (matplotlib.collections.StarPolygonCollection method), 1123

[get_alpha\(\)](#) (matplotlib.collections.TriMesh method), 1134
[get_alt_path\(\)](#) (matplotlib.markers.MarkerStyle method), 1257
[get_alt_transform\(\)](#) (matplotlib.markers.MarkerStyle method), 1257
[get_anchor\(\)](#) (matplotlib.axes.Axes method), 767
[get_anchor\(\)](#) (mpl_toolkits.axes_grid.axes_divider.Divider method), 1796
[get_angle\(\)](#) (matplotlib.afm.AFM method), 487
[get_animated\(\)](#) (matplotlib.artist.Artist method), 543
[get_animated\(\)](#) (matplotlib.axes.Axes method), 783
[get_animated\(\)](#) (matplotlib.axis.Axis method), 880
[get_animated\(\)](#) (matplotlib.axis.Tick method), 840
[get_animated\(\)](#) (matplotlib.axis.XAxis method), 891
[get_animated\(\)](#) (matplotlib.axis.XTick method), 851
[get_animated\(\)](#) (matplotlib.axis.YAxis method), 902
[get_animated\(\)](#) (matplotlib.axis.YTick method), 863
[get_animated\(\)](#) (matplotlib.collections.AsteriskPolygonCollection method), 977
[get_animated\(\)](#) (matplotlib.collections.BrokenBarHCollection method), 989
[get_animated\(\)](#) (matplotlib.collections.CircleCollection method), 1001
[get_animated\(\)](#) (matplotlib.collections.Collection method), 1014
[get_animated\(\)](#) (matplotlib.collections.EllipseCollection method), 1025
[get_animated\(\)](#) (matplotlib.collections.EventCollection method), 1038
[get_animated\(\)](#) (matplotlib.collections.LineCollection method), 1051
[get_animated\(\)](#) (matplotlib.collections.PatchCollection method), 1062
[get_animated\(\)](#) (matplotlib.collections.PathCollection method), 1074
[get_animated\(\)](#) (matplotlib.collections.PolyCollection method), 1086
[get_animated\(\)](#) (matplotlib.collections.QuadMesh method), 1098
[get_animated\(\)](#) (matplotlib.collections.RegularPolyCollection method), 1110
[get_animated\(\)](#) (matplotlib.collections.StarPolygonCollection method), 1123
[get_array\(\)](#) (matplotlib.cm.ScalarMappable method), 972
[get_array\(\)](#) (matplotlib.collections.AsteriskPolygonCollection method), 977
[get_array\(\)](#) (matplotlib.collections.BrokenBarHCollection method), 989
[get_array\(\)](#) (matplotlib.collections.CircleCollection method), 1001
[get_array\(\)](#) (matplotlib.collections.Collection method), 1014
[get_array\(\)](#) (matplotlib.collections.EllipseCollection method), 1025
[get_array\(\)](#) (matplotlib.collections.EventCollection method), 1038
[get_array\(\)](#) (matplotlib.collections.LineCollection method), 1051
[get_array\(\)](#) (matplotlib.collections.PatchCollection method), 1062
[get_array\(\)](#) (matplotlib.collections.PathCollection method), 1074
[get_array\(\)](#) (matplotlib.collections.PolyCollection method), 1086
[get_array\(\)](#) (matplotlib.collections.QuadMesh method), 1098
[get_array\(\)](#) (matplotlib.collections.RegularPolyCollection method), 1110
[get_array\(\)](#) (matplotlib.collections.StarPolygonCollection method), 1123

[get_array\(\)](#) (matplotlib.collections.TriMesh method), 1134
[get_arrowstyle\(\)](#) (matplotlib.patches.FancyArrowPatch method), 1346
[get_aspect\(\)](#) (matplotlib.axes.Axes method), 754
[get_aspect\(\)](#) (mpl_toolkits.axes_grid.axes_divider.Divider method), 1796
[get_autoscale_on\(\)](#) (matplotlib.axes.Axes method), 753
[get_autoscale_on\(\)](#) (mpl_toolkits.mplot3d.axes3d.Axes3D method), 1851
[get_autoscalex_on\(\)](#) (matplotlib.axes.Axes method), 753
[get_autoscaley_on\(\)](#) (matplotlib.axes.Axes method), 754
[get_autoscalez_on\(\)](#) (mpl_toolkits.mplot3d.axes3d.Axes3D method), 1851
[get_axes\(\)](#) (matplotlib.artist.Artist method), 547
[get_axes\(\)](#) (matplotlib.axes.Axes method), 785
[get_axes\(\)](#) (matplotlib.axis.Axis method), 880
[get_axes\(\)](#) (matplotlib.axis.Tick method), 840
[get_axes\(\)](#) (matplotlib.axis.XAxis method), 891
[get_axes\(\)](#) (matplotlib.axis.XTick method), 851
[get_axes\(\)](#) (matplotlib.axis.YAxis method), 902
[get_axes\(\)](#) (matplotlib.axis.YTick method), 863
[get_axes\(\)](#) (matplotlib.collections.AsteriskPolygonCollection method), 977
[get_axes\(\)](#) (matplotlib.collections.BrokenBarHCollection method), 989
[get_axes\(\)](#) (matplotlib.collections.CircleCollection method), 1001
[get_axes\(\)](#) (matplotlib.collections.Collection method), 1014
[get_axes\(\)](#) (matplotlib.collections.EllipseCollection method), 1025
[get_axes\(\)](#) (matplotlib.collections.EventCollection method), 1038
[get_axes\(\)](#) (matplotlib.collections.LineCollection method), 1051
[get_axes\(\)](#) (matplotlib.collections.PatchCollection method), 1062
[get_axes\(\)](#) (matplotlib.collections.PathCollection method), 1074
[get_axes\(\)](#) (matplotlib.collections.PolyCollection method), 1086
[get_axes\(\)](#) (matplotlib.collections.QuadMesh method), 1098
[get_axes\(\)](#) (matplotlib.collections.RegularPolyCollection method), 1110
[get_axes\(\)](#) (matplotlib.collections.StarPolygonCollection method), 1123
[get_axes\(\)](#) (matplotlib.collections.TriMesh method), 1134
[get_axes\(\)](#) (matplotlib.figure.Figure method), 1196
[get_axes_locator\(\)](#) (matplotlib.axes.Axes method), 768
[get_axis_bgcolor\(\)](#) (matplotlib.axes.Axes method), 735
[get_axis_position\(\)](#) (mpl_toolkits.mplot3d.axes3d.Axes3D method), 1852
[get_axisbelow\(\)](#) (matplotlib.axes.Axes method), 734
[get_axisbelow\(\)](#) (mpl_toolkits.mplot3d.axes3d.Axes3D method), 1852
[get_axisline_style\(\)](#) (mpl_toolkits.axes_grid.axis_artist.AxisArtist method), 1802
[get_backend\(\)](#) (in module matplotlib), 483
[get_bbox\(\)](#) (matplotlib.patches.FancyBboxPatch method), 1349
[get_bbox\(\)](#) (matplotlib.patches.Rectangle method), 1359
[get_bbox_char\(\)](#) (matplotlib.afm.AFM method), 488
[get_bbox_edge_pos\(\)](#) (mpl_toolkits.axes_grid1.inset_locator.BboxConnector static method), 1813
[get_bbox_patch\(\)](#) (matplotlib.text.Text method), 1626
[get_bbox_to_anchor\(\)](#) (matplotlib.legend.Legend method), 1240
[get_bbox_to_anchor\(\)](#) (matplotlib.offsetbox.AnchoredOffsetbox method), 1314
[get_bounds\(\)](#) (matplotlib.spines.Spine method), 1616
[get_boxstyle\(\)](#) (matplotlib.patches.FancyBboxPatch method), 1349
[get_c\(\)](#) (matplotlib.lines.Line2D method), 1247
[get_canvas\(\)](#) (matplotlib.backends.backend_wxagg.FigureFrameWxAgg method), 948
[get_canvas\(\)](#) (matplotlib.backends.backend_wxagg.NavigationToolbar2WxAgg method), 948
[get_canvas_width_height\(\)](#) (matplotlib.backend_bases.RendererBase

- method), 929
- get_capheight() (matplotlib.afm.AFM method), 488
- get_capstyle() (matplotlib.backend_bases.GraphicsContextBase method), 920
- get_capstyle() (matplotlib.markers.MarkerStyle method), 1257
- get_capstyle() (matplotlib.patches.Patch method), 1352
- get_child() (matplotlib.offsetbox.AnchoredOffsetbox method), 1314
- get_children() (matplotlib.artist.Artist method), 548
- get_children() (matplotlib.axes.Axes method), 776
- get_children() (matplotlib.axis.Axis method), 880
- get_children() (matplotlib.axis.Tick method), 840
- get_children() (matplotlib.axis.XAxis method), 891
- get_children() (matplotlib.axis.XTick method), 852
- get_children() (matplotlib.axis.YAxis method), 902
- get_children() (matplotlib.axis.YTick method), 863
- get_children() (matplotlib.collections.AsteriskPolygonCollection method), 977
- get_children() (matplotlib.collections.BrokenBarHCollection method), 989
- get_children() (matplotlib.collections.CircleCollection method), 1001
- get_children() (matplotlib.collections.Collection method), 1014
- get_children() (matplotlib.collections.EllipseCollection method), 1025
- get_children() (matplotlib.collections.EventCollection method), 1038
- get_children() (matplotlib.collections.LineCollection method), 1051
- get_children() (matplotlib.collections.PatchCollection method), 1063
- get_children() (matplotlib.collections.PathCollection method), 1074
- get_children() (matplotlib.collections.PolyCollection method), 1086
- get_children() (matplotlib.collections.QuadMesh method), 1098
- get_children() (matplotlib.collections.RegularPolyCollection method), 1110
- get_children() (matplotlib.collections.StarPolygonCollection method), 1123
- get_children() (matplotlib.collections.TriMesh method), 1135
- get_children() (matplotlib.container.Container method), 1165
- get_children() (matplotlib.figure.Figure method), 1196
- get_children() (matplotlib.legend.Legend method), 1240
- get_children() (matplotlib.offsetbox.AnchoredOffsetbox method), 1314
- get_children() (matplotlib.offsetbox.AnnotationBbox method), 1315
- get_children() (matplotlib.offsetbox.OffsetBox method), 1319
- get_children() (matplotlib.offsetbox.OffsetImage method), 1320
- get_children() (mpl_toolkits.mplot3d.axes3d.Axes3D method), 1852
- get_clim() (matplotlib.cm.ScalarMappable method), 972
- get_clim() (matplotlib.collections.AsteriskPolygonCollection method), 977
- get_clim() (matplotlib.collections.BrokenBarHCollection method), 989
- get_clim() (matplotlib.collections.CircleCollection method), 1001
- get_clim() (matplotlib.collections.Collection method), 1014
- get_clim() (matplotlib.collections.EllipseCollection method), 1025
- get_clim() (matplotlib.collections.EventCollection method), 1038
- get_clim() (matplotlib.collections.LineCollection method), 1051
- get_clim() (matplotlib.collections.PatchCollection method), 1063
- get_clim() (matplotlib.collections.PathCollection method), 1074

get_clim() (matplotlib.collections.PolyCollection method), 1086
 get_clim() (matplotlib.collections.QuadMesh method), 1098
 get_clim() (matplotlib.collections.RegularPolyCollection method), 1110
 get_clim() (matplotlib.collections.StarPolygonCollection method), 1123
 get_clim() (matplotlib.collections.TriMesh method), 1135
 get_clip_box() (matplotlib.artist.Artist method), 540
 get_clip_box() (matplotlib.axes.Axes method), 783
 get_clip_box() (matplotlib.axis.Axis method), 880
 get_clip_box() (matplotlib.axis.Tick method), 840
 get_clip_box() (matplotlib.axis.XAxis method), 891
 get_clip_box() (matplotlib.axis.XTick method), 852
 get_clip_box() (matplotlib.axis.YAxis method), 902
 get_clip_box() (matplotlib.axis.YTick method), 863
 get_clip_box() (matplotlib.collections.AsteriskPolygonCollection method), 978
 get_clip_box() (matplotlib.collections.BrokenBarHCollection method), 990
 get_clip_box() (matplotlib.collections.CircleCollection method), 1002
 get_clip_box() (matplotlib.collections.Collection method), 1014
 get_clip_box() (matplotlib.collections.EllipseCollection method), 1026
 get_clip_box() (matplotlib.collections.EventCollection method), 1038
 get_clip_box() (matplotlib.collections.LineCollection method), 1051
 get_clip_box() (matplotlib.collections.PatchCollection method), 1063
 get_clip_box() (matplotlib.collections.PathCollection method), 1074
 get_clip_box() (matplotlib.collections.PolyCollection method), 1086
 get_clip_box() (matplotlib.collections.QuadMesh method), 1099
 get_clip_box() (matplotlib.collections.RegularPolyCollection method), 1111
 get_clip_box() (matplotlib.collections.StarPolygonCollection method), 1123
 get_clip_box() (matplotlib.collections.TriMesh method), 1135
 get_clip_on() (matplotlib.artist.Artist method), 540
 get_clip_on() (matplotlib.axes.Axes method), 783
 get_clip_on() (matplotlib.axis.Axis method), 880
 get_clip_on() (matplotlib.axis.Tick method), 840
 get_clip_on() (matplotlib.axis.XAxis method), 891
 get_clip_on() (matplotlib.axis.XTick method), 852
 get_clip_on() (matplotlib.axis.YAxis method), 902
 get_clip_on() (matplotlib.axis.YTick method), 863
 get_clip_on() (matplotlib.collections.AsteriskPolygonCollection method), 978
 get_clip_on() (matplotlib.collections.BrokenBarHCollection method), 990
 get_clip_on() (matplotlib.collections.CircleCollection method), 1002
 get_clip_on() (matplotlib.collections.Collection method), 1014
 get_clip_on() (matplotlib.collections.EllipseCollection method), 1026
 get_clip_on() (matplotlib.collections.EventCollection method), 1038
 get_clip_on() (matplotlib.collections.LineCollection method), 1051
 get_clip_on() (matplotlib.collections.PatchCollection method), 1063
 get_clip_on() (matplotlib.collections.PathCollection method), 1074
 get_clip_on() (matplotlib.collections.PolyCollection method), 1086
 get_clip_on() (matplotlib.collections.QuadMesh method), 1099
 get_clip_on() (matplotlib.collections.RegularPolyCollection method), 1111

`get_clip_on()` (matplotlib.collections.StarPolygonCollection method), 1123
`get_clip_on()` (matplotlib.collections.TriMesh method), 1135
`get_clip_path()` (matplotlib.artist.Artist method), 540
`get_clip_path()` (matplotlib.axes.Axes method), 783
`get_clip_path()` (matplotlib.axis.Axis method), 880
`get_clip_path()` (matplotlib.axis.Tick method), 840
`get_clip_path()` (matplotlib.axis.XAxis method), 892
`get_clip_path()` (matplotlib.axis.XTick method), 852
`get_clip_path()` (matplotlib.axis.YAxis method), 903
`get_clip_path()` (matplotlib.axis.YTick method), 863
`get_clip_path()` (matplotlib.backend_bases.GraphicsContextBase method), 920
`get_clip_path()` (matplotlib.collections.AsteriskPolygonCollection method), 978
`get_clip_path()` (matplotlib.collections.BrokenBarHCollection method), 990
`get_clip_path()` (matplotlib.collections.CircleCollection method), 1002
`get_clip_path()` (matplotlib.collections.Collection method), 1014
`get_clip_path()` (matplotlib.collections.EllipseCollection method), 1026
`get_clip_path()` (matplotlib.collections.EventCollection method), 1038
`get_clip_path()` (matplotlib.collections.LineCollection method), 1051
`get_clip_path()` (matplotlib.collections.PatchCollection method), 1063
`get_clip_path()` (matplotlib.collections.PathCollection method), 1074
`get_clip_path()` (matplotlib.collections.PolyCollection method), 1086
`get_clip_path()` (matplotlib.collections.QuadMesh method), 1099
`get_clip_path()` (matplotlib.collections.RegularPolyCollection method), 1111
`get_clip_path()` (matplotlib.collections.StarPolygonCollection method), 1123
`get_clip_path()` (matplotlib.collections.TriMesh method), 1135
`get_clip_rectangle()` (matplotlib.backend_bases.GraphicsContextBase method), 920
`get_closed()` (matplotlib.patches.Polygon method), 1357
`get_cmap()` (in module matplotlib.cm), 972
`get_cmap()` (matplotlib.cm.ScalarMappable method), 972
`get_cmap()` (matplotlib.collections.AsteriskPolygonCollection method), 978
`get_cmap()` (matplotlib.collections.BrokenBarHCollection method), 990
`get_cmap()` (matplotlib.collections.CircleCollection method), 1002
`get_cmap()` (matplotlib.collections.Collection method), 1014
`get_cmap()` (matplotlib.collections.EllipseCollection method), 1026
`get_cmap()` (matplotlib.collections.EventCollection method), 1038
`get_cmap()` (matplotlib.collections.LineCollection method), 1051
`get_cmap()` (matplotlib.collections.PatchCollection method), 1063
`get_cmap()` (matplotlib.collections.PathCollection method), 1074
`get_cmap()` (matplotlib.collections.PolyCollection method), 1086
`get_cmap()` (matplotlib.collections.QuadMesh method), 1099
`get_cmap()` (matplotlib.collections.RegularPolyCollection method), 1111
`get_cmap()` (matplotlib.collections.StarPolygonCollection method), 1123
`get_cmap()` (matplotlib.collections.TriMesh method), 1135
`get_color()` (matplotlib.collections.EventCollection method), 1038
`get_color()` (matplotlib.collections.LineCollection method), 1051
`get_color()` (matplotlib.lines.Line2D method), 1247

- get_color() (matplotlib.text.Text method), 1626
- get_colors() (in module matplotlib_toolkits.mplot3d.art3d), 1874
- get_colors() (matplotlib.collections.EventCollection method), 1038
- get_colors() (matplotlib.collections.LineCollection method), 1051
- get_connectionstyle() (matplotlib.patches.FancyArrowPatch method), 1346
- get_contains() (matplotlib.artist.Artist method), 537
- get_contains() (matplotlib.axes.Axes method), 774
- get_contains() (matplotlib.axis.Axis method), 880
- get_contains() (matplotlib.axis.Tick method), 841
- get_contains() (matplotlib.axis.XAxis method), 892
- get_contains() (matplotlib.axis.XTick method), 852
- get_contains() (matplotlib.axis.YAxis method), 903
- get_contains() (matplotlib.axis.YTick method), 863
- get_contains() (matplotlib.collections.AsteriskPolygonCollection method), 978
- get_contains() (matplotlib.collections.BrokenBarHCollection method), 990
- get_contains() (matplotlib.collections.CircleCollection method), 1002
- get_contains() (matplotlib.collections.Collection method), 1014
- get_contains() (matplotlib.collections.EllipseCollection method), 1026
- get_contains() (matplotlib.collections.EventCollection method), 1038
- get_contains() (matplotlib.collections.LineCollection method), 1051
- get_contains() (matplotlib.collections.PatchCollection method), 1063
- get_contains() (matplotlib.collections.PathCollection method), 1075
- get_contains() (matplotlib.collections.PolyCollection method), 1087
- get_contains() (matplotlib.collections.QuadMesh method), 1099
- get_contains() (matplotlib.collections.RegularPolyCollection method), 1111
- get_contains() (matplotlib.collections.StarPolygonCollection method), 1123
- get_contains() (matplotlib.collections.TriMesh method), 1135
- get_converter() (matplotlib.units.Registry method), 1686
- get_current_fig_manager() (in module matplotlib.pyplot), 1486
- get_cursor_data() (matplotlib.artist.Artist method), 538
- get_cursor_data() (matplotlib.axes.Axes method), 775
- get_cursor_data() (matplotlib.axis.Axis method), 881
- get_cursor_data() (matplotlib.axis.Tick method), 841
- get_cursor_data() (matplotlib.axis.XAxis method), 892
- get_cursor_data() (matplotlib.axis.XTick method), 852
- get_cursor_data() (matplotlib.axis.YAxis method), 903
- get_cursor_data() (matplotlib.axis.YTick method), 863
- get_cursor_data() (matplotlib.collections.AsteriskPolygonCollection method), 978
- get_cursor_data() (matplotlib.collections.BrokenBarHCollection method), 990
- get_cursor_data() (matplotlib.collections.CircleCollection method), 1002
- get_cursor_data() (matplotlib.collections.Collection method), 1014
- get_cursor_data() (matplotlib.collections.EllipseCollection method), 1026
- get_cursor_data() (matplotlib.collections.EventCollection method), 1038
- get_cursor_data() (matplotlib.collections.LineCollection method), 1051
- get_cursor_data() (matplotlib.collections.PatchCollection method), 1063
- get_cursor_data() (matplotlib.collections.PathCollection method), 1075
- get_cursor_data() (matplotlib.collections.PolyCollection method), 1087
- get_cursor_data() (matplotlib.collections.QuadMesh method), 1099
- get_cursor_data() (matplotlib.collections.RegularPolyCollection method), 1111
- get_cursor_data() (matplotlib.collections.StarPolygonCollection method), 1123
- get_cursor_data() (matplotlib.collections.TriMesh method), 1135

- 1051
- get_cursor_data() (matplotlib.collections.PatchCollection method), 1063
- get_cursor_data() (matplotlib.collections.PathCollection method), 1075
- get_cursor_data() (matplotlib.collections.PolyCollection method), 1087
- get_cursor_data() (matplotlib.collections.QuadMesh method), 1099
- get_cursor_data() (matplotlib.collections.RegularPolyCollection method), 1111
- get_cursor_data() (matplotlib.collections.StarPolygonCollection method), 1123
- get_cursor_data() (matplotlib.collections.TriMesh method), 1135
- get_cursor_data() (matplotlib.image.AxesImage method), 1231
- get_cursor_data() (matplotlib.image.PcolorImage method), 1233
- get_cursor_props() (matplotlib.axes.Axes method), 775
- get_dash_capstyle() (matplotlib.lines.Line2D method), 1247
- get_dash_joinstyle() (matplotlib.lines.Line2D method), 1247
- get_dashdirection() (matplotlib.text.TextWithDash method), 1632
- get_dashes() (matplotlib.backend_bases.GraphicsContextBase method), 920
- get_dashes() (matplotlib.collections.AsteriskPolygonCollection method), 978
- get_dashes() (matplotlib.collections.BrokenBarHCollection method), 990
- get_dashes() (matplotlib.collections.CircleCollection method), 1002
- get_dashes() (matplotlib.collections.Collection method), 1014
- get_dashes() (matplotlib.collections.EllipseCollection method), 1026
- get_dashes() (matplotlib.collections.EventCollection method), 1038
- get_dashes() (matplotlib.collections.LineCollection method), 1051
- get_dashes() (matplotlib.collections.PatchCollection method), 1063
- get_dashes() (matplotlib.collections.PathCollection method), 1075
- get_dashes() (matplotlib.collections.PolyCollection method), 1087
- get_dashes() (matplotlib.collections.QuadMesh method), 1099
- get_dashes() (matplotlib.collections.RegularPolyCollection method), 1111
- get_dashes() (matplotlib.collections.StarPolygonCollection method), 1123
- get_dashes() (matplotlib.collections.TriMesh method), 1135
- get_dashlength() (matplotlib.text.TextWithDash method), 1632
- get_dashpad() (matplotlib.text.TextWithDash method), 1632
- get_dashpush() (matplotlib.text.TextWithDash method), 1632
- get_dashrotation() (matplotlib.text.TextWithDash method), 1632
- get_data() (matplotlib.lines.Line2D method), 1247
- get_data() (matplotlib.offsetbox.OffsetImage method), 1320
- get_data_interval() (matplotlib.axis.Axis method), 801
- get_data_interval() (matplotlib.axis.XAxis method), 825
- get_data_interval() (matplotlib.axis.YAxis method), 815
- get_data_interval() (mpl_toolkits.mplot3d.axis3d.XAxis method), 1870
- get_data_interval() (mpl_toolkits.mplot3d.axis3d.YAxis method), 1870
- get_data_interval() (mpl_toolkits.mplot3d.axis3d.ZAxis method), 1871
- get_data_ratio() (matplotlib.axes.Axes method), 787
- get_data_ratio() (matplotlib.projections.polar.PolarAxes method), 1382

get_data_ratio_log() (matplotlib.axes.Axes method), 787	plotlib.backend_bases.FigureCanvasBase class method), 915
get_data_transform() (matplotlib.patches.Patch method), 1352	get_default_handler_map() (mat- plotlib.legend.Legend class method), 1240
get_datalim() (mat- plotlib.collections.AsteriskPolygonCollection method), 978	get_default_size() (mat- plotlib.font_manager.FontManager static method), 1220
get_datalim() (mat- plotlib.collections.BrokenBarHCollection method), 990	get_default_weight() (mat- plotlib.font_manager.FontManager method), 1220
get_datalim() (mat- plotlib.collections.CircleCollection method), 1002	get_depth() (matplotlib.mathtext.MathTextParser method), 1267
get_datalim() (matplotlib.collections.Collection method), 1014	get_dir_vector() (in module mpl_toolkits.mplot3d.art3d), 1874
get_datalim() (mat- plotlib.collections.EllipseCollection method), 1026	get_dpi() (matplotlib.figure.Figure method), 1197
get_datalim() (mat- plotlib.collections.EventCollection method), 1038	get_dpi_cor() (matplotlib.patches.FancyArrowPatch method), 1346
get_datalim() (matplotlib.collections.LineCollection method), 1051	get_drawstyle() (matplotlib.lines.Line2D method), 1247
get_datalim() (mat- plotlib.collections.PatchCollection method), 1063	get_ec() (matplotlib.patches.Patch method), 1352
get_datalim() (matplotlib.collections.PathCollection method), 1075	get_edgecolor() (mat- plotlib.collections.AsteriskPolygonCollection method), 978
get_datalim() (matplotlib.collections.PolyCollection method), 1087	get_edgecolor() (mat- plotlib.collections.BrokenBarHCollection method), 990
get_datalim() (matplotlib.collections.QuadMesh method), 1099	get_edgecolor() (mat- plotlib.collections.CircleCollection method), 1002
get_datalim() (mat- plotlib.collections.RegularPolyCollection method), 1111	get_edgecolor() (matplotlib.collections.Collection method), 1014
get_datalim() (mat- plotlib.collections.StarPolygonCollection method), 1123	get_edgecolor() (mat- plotlib.collections.EllipseCollection method), 1026
get_datalim() (matplotlib.collections.TriMesh method), 1135	get_edgecolor() (mat- plotlib.collections.EventCollection method), 1039
get_default_bbox_extra_artists() (mat- plotlib.axes.Axes method), 789	get_edgecolor() (mat- plotlib.collections.LineCollection method), 1051
get_default_bbox_extra_artists() (mat- plotlib.figure.Figure method), 1196	get_edgecolor() (mat- plotlib.collections.PatchCollection method), 1063
get_default_filename() (mat- plotlib.backend_bases.FigureCanvasBase method), 915	get_edgecolor() (mat- plotlib.collections.PathCollection method), 1075
get_default_filetype() (mat-	get_edgecolor() (mat-

plotlib.collections.PolyCollection method), 1087
 get_edgecolor() (matplotlib.collections.QuadMesh method), 1099
 get_edgecolor() (matplotlib.collections.RegularPolyCollection method), 1111
 get_edgecolor() (matplotlib.collections.StarPolygonCollection method), 1123
 get_edgecolor() (matplotlib.collections.TriMesh method), 1135
 get_edgecolor() (matplotlib.figure.Figure method), 1197
 get_edgecolor() (matplotlib.patches.Patch method), 1352
 get_edgecolor() (mpl_toolkits.mplot3d.art3d.Poly3DCollection method), 1873
 get_edgecolors() (matplotlib.collections.AsteriskPolygonCollection method), 978
 get_edgecolors() (matplotlib.collections.BrokenBarHCollection method), 990
 get_edgecolors() (matplotlib.collections.CircleCollection method), 1002
 get_edgecolors() (matplotlib.collections.Collection method), 1014
 get_edgecolors() (matplotlib.collections.EllipseCollection method), 1026
 get_edgecolors() (matplotlib.collections.EventCollection method), 1039
 get_edgecolors() (matplotlib.collections.LineCollection method), 1052
 get_edgecolors() (matplotlib.collections.PatchCollection method), 1063
 get_edgecolors() (matplotlib.collections.PathCollection method), 1075
 get_edgecolors() (matplotlib.collections.PolyCollection method), 1087
 get_edgecolors() (matplotlib.collections.QuadMesh method), 1099
 get_edgecolors() (matplotlib.collections.RegularPolyCollection method), 1111
 get_edgecolors() (matplotlib.collections.StarPolygonCollection method), 1123
 get_edgecolors() (matplotlib.collections.TriMesh method), 1135
 get_edgecolors() (mpl_toolkits.mplot3d.art3d.Poly3DCollection method), 1873
 get_err_size() (matplotlib.legend_handler.HandlerErrorbar method), 1242
 get_extent() (matplotlib.image.AxesImage method), 1231
 get_extent() (matplotlib.image.FigureImage method), 1232
 get_extent() (matplotlib.image.NonUniformImage method), 1232
 get_extent() (matplotlib.offsetbox.AnchoredOffsetbox method), 1314
 get_extent() (matplotlib.offsetbox.AuxTransformBox method), 1316
 get_extent() (matplotlib.offsetbox.DrawingArea method), 1318
 get_extent() (matplotlib.offsetbox.OffsetBox method), 1319
 get_extent() (matplotlib.offsetbox.OffsetImage method), 1320
 get_extent() (matplotlib.offsetbox.TextArea method), 1322
 get_extent() (mpl_toolkits.axes_grid1.inset_locator.AnchoredSizeLocator method), 1811
 get_extent() (mpl_toolkits.axes_grid1.inset_locator.AnchoredZoomLocator method), 1811
 get_extent_offsets() (matplotlib.offsetbox.HPacker method), 1319
 get_extent_offsets() (matplotlib.offsetbox.OffsetBox method), 1319
 get_extent_offsets() (matplotlib.offsetbox.PaddedBox method), 1321
 get_extent_offsets() (matplotlib.offsetbox.VPacker method), 1323
 get_extents() (matplotlib.patches.Patch method), 1352
 get_extents() (matplotlib.path.Path method), 1370

[get_facecolor\(\)](#) (matplotlib.axes.Axes method), [735](#)
[get_facecolor\(\)](#) (matplotlib.collections.AsteriskPolygonCollection method), [978](#)
[get_facecolor\(\)](#) (matplotlib.collections.BrokenBarHCollection method), [990](#)
[get_facecolor\(\)](#) (matplotlib.collections.CircleCollection method), [1002](#)
[get_facecolor\(\)](#) (matplotlib.collections.Collection method), [1014](#)
[get_facecolor\(\)](#) (matplotlib.collections.EllipseCollection method), [1026](#)
[get_facecolor\(\)](#) (matplotlib.collections.EventCollection method), [1039](#)
[get_facecolor\(\)](#) (matplotlib.collections.LineCollection method), [1052](#)
[get_facecolor\(\)](#) (matplotlib.collections.PatchCollection method), [1063](#)
[get_facecolor\(\)](#) (matplotlib.collections.PathCollection method), [1075](#)
[get_facecolor\(\)](#) (matplotlib.collections.PolyCollection method), [1087](#)
[get_facecolor\(\)](#) (matplotlib.collections.QuadMesh method), [1099](#)
[get_facecolor\(\)](#) (matplotlib.collections.RegularPolyCollection method), [1111](#)
[get_facecolor\(\)](#) (matplotlib.collections.StarPolygonCollection method), [1123](#)
[get_facecolor\(\)](#) (matplotlib.collections.TriMesh method), [1135](#)
[get_facecolor\(\)](#) (matplotlib.figure.Figure method), [1197](#)
[get_facecolor\(\)](#) (matplotlib.patches.Patch method), [1352](#)
[get_facecolor\(\)](#) (mpl_toolkits.mplot3d.art3d.Patch3D method), [1872](#)
[get_facecolor\(\)](#) (mpl_toolkits.mplot3d.art3d.Poly3DCollection method), [1873](#)
[get_facecolors\(\)](#) (matplotlib.collections.AsteriskPolygonCollection method), [978](#)
[get_facecolors\(\)](#) (matplotlib.collections.BrokenBarHCollection method), [990](#)
[get_facecolors\(\)](#) (matplotlib.collections.CircleCollection method), [1002](#)
[get_facecolors\(\)](#) (matplotlib.collections.Collection method), [1014](#)
[get_facecolors\(\)](#) (matplotlib.collections.EllipseCollection method), [1026](#)
[get_facecolors\(\)](#) (matplotlib.collections.EventCollection method), [1039](#)
[get_facecolors\(\)](#) (matplotlib.collections.LineCollection method), [1052](#)
[get_facecolors\(\)](#) (matplotlib.collections.PatchCollection method), [1063](#)
[get_facecolors\(\)](#) (matplotlib.collections.PathCollection method), [1075](#)
[get_facecolors\(\)](#) (matplotlib.collections.PolyCollection method), [1087](#)
[get_facecolors\(\)](#) (matplotlib.collections.QuadMesh method), [1099](#)
[get_facecolors\(\)](#) (matplotlib.collections.RegularPolyCollection method), [1111](#)
[get_facecolors\(\)](#) (matplotlib.collections.StarPolygonCollection method), [1123](#)
[get_facecolors\(\)](#) (matplotlib.collections.TriMesh method), [1135](#)
[get_facecolors\(\)](#) (mpl_toolkits.mplot3d.art3d.Poly3DCollection method), [1873](#)
[get_family\(\)](#) (matplotlib.font_manager.FontProperties method), [1222](#)
[get_family\(\)](#) (matplotlib.text.Text method), [1626](#)
[get_familyname\(\)](#) (matplotlib.afm.AFM method), [1626](#)
[get_fc\(\)](#) (matplotlib.axes.Axes method), [736](#)

- get_fc() (matplotlib.patches.Patch method), 1352
- get_figheight() (matplotlib.figure.Figure method), 1197
- get_figlabels() (in module matplotlib.pyplot), 1486
- get_fignums() (in module matplotlib.pyplot), 1486
- get_figure() (matplotlib.artist.Artist method), 547
- get_figure() (matplotlib.axes.Axes method), 785
- get_figure() (matplotlib.axis.Axis method), 881
- get_figure() (matplotlib.axis.Tick method), 841
- get_figure() (matplotlib.axis.XAxis method), 892
- get_figure() (matplotlib.axis.XTick method), 852
- get_figure() (matplotlib.axis.YAxis method), 903
- get_figure() (matplotlib.axis.YTick method), 864
- get_figure() (matplotlib.collections.AsteriskPolygonCollection method), 978
- get_figure() (matplotlib.collections.BrokenBarHCollection method), 990
- get_figure() (matplotlib.collections.CircleCollection method), 1002
- get_figure() (matplotlib.collections.Collection method), 1014
- get_figure() (matplotlib.collections.EllipseCollection method), 1026
- get_figure() (matplotlib.collections.EventCollection method), 1039
- get_figure() (matplotlib.collections.LineCollection method), 1052
- get_figure() (matplotlib.collections.PatchCollection method), 1063
- get_figure() (matplotlib.collections.PathCollection method), 1075
- get_figure() (matplotlib.collections.PolyCollection method), 1087
- get_figure() (matplotlib.collections.QuadMesh method), 1099
- get_figure() (matplotlib.collections.RegularPolyCollection method), 1111
- get_figure() (matplotlib.collections.StarPolygonCollection method), 1124
- get_figure() (matplotlib.collections.TriMesh method), 1135
- get_figure() (matplotlib.text.TextWithDash method), 1633
- get_figwidth() (matplotlib.figure.Figure method), 1197
- get_file() (matplotlib.font_manager.FontProperties method), 1222
- get_fill() (matplotlib.collections.AsteriskPolygonCollection method), 978
- get_fill() (matplotlib.collections.BrokenBarHCollection method), 990
- get_fill() (matplotlib.collections.CircleCollection method), 1002
- get_fill() (matplotlib.collections.Collection method), 1015
- get_fill() (matplotlib.collections.EllipseCollection method), 1026
- get_fill() (matplotlib.collections.EventCollection method), 1039
- get_fill() (matplotlib.collections.LineCollection method), 1052
- get_fill() (matplotlib.collections.PatchCollection method), 1063
- get_fill() (matplotlib.collections.PathCollection method), 1075
- get_fill() (matplotlib.collections.PolyCollection method), 1087
- get_fill() (matplotlib.collections.QuadMesh method), 1099
- get_fill() (matplotlib.collections.RegularPolyCollection method), 1111
- get_fill() (matplotlib.collections.StarPolygonCollection method), 1124
- get_fill() (matplotlib.collections.TriMesh method), 1135
- get_fill() (matplotlib.patches.Patch method), 1352
- get_fillstyle() (matplotlib.lines.Line2D method), 1247
- get_fillstyle() (matplotlib.markers.MarkerStyle method), 1257
- get_flat_tri_mask() (matplotlib.tri.TriAnalyzer method), 1679
- get_flip_min_max() (in module matplotlib.mpl_toolkits.mplot3d.axis3d), 1871
- get_font_properties() (matplotlib.text.Text method), 1626
- get_fontconfig_fonts() (in module matplotlib.font_manager), 1224
- get_fontconfig_pattern() (matplotlib.font_manager.FontProperties method), 1222
- get_fonttext_synonyms() (in module matplotlib.font_manager), 1224
- get_fontfamily() (matplotlib.text.Text method), 1626
- get_fontname() (matplotlib.afm.AFM method), 488
- get_fontname() (matplotlib.text.Text method), 1626

- `get_fontproperties()` (matplotlib.text.Text method), 1626
`get_fontsize()` (matplotlib.offsetbox.AnnotationBbox method), 1315
`get_fontsize()` (matplotlib.text.Text method), 1626
`get_fontstretch()` (matplotlib.text.Text method), 1626
`get_fontstyle()` (matplotlib.text.Text method), 1626
`get_fontvariant()` (matplotlib.text.Text method), 1626
`get_fontweight()` (matplotlib.text.Text method), 1626
`get_forced_alpha()` (matplotlib.backend_bases.GraphicsContextBase method), 920
`get_formatd()` (in module matplotlib.mlab), 1296
`get_frame()` (matplotlib.legend.Legend method), 1240
`get_frame_on()` (matplotlib.axes.Axes method), 733
`get_frame_on()` (matplotlib.legend.Legend method), 1240
`get_frame_on()` (mpl_toolkits.mplot3d.axes3d.Axes3D method), 1852
`get_frameon()` (matplotlib.figure.Figure method), 1197
`get_from_args_and_kwargs()` (matplotlib.tri.Triangulation static method), 1672
`get_fullname()` (matplotlib.afm.AFM method), 488
`get_fully_transformed_path()` (matplotlib.transforms.TransformedPath method), 1669
`get_geometry()` (matplotlib.gridspec.GridSpecBase method), 1228
`get_geometry()` (matplotlib.gridspec.SubplotSpec method), 1229
`get_geometry()` (mpl_toolkits.axes_grid.axes_divider.SubplotDivisor method), 1799
`get_gid()` (matplotlib.artist.Artist method), 549
`get_gid()` (matplotlib.axes.Axes method), 783
`get_gid()` (matplotlib.axis.Axis method), 881
`get_gid()` (matplotlib.axis.Tick method), 841
`get_gid()` (matplotlib.axis.XAxis method), 892
`get_gid()` (matplotlib.axis.XTick method), 852
`get_gid()` (matplotlib.axis.YAxis method), 903
`get_gid()` (matplotlib.axis.YTick method), 864
`get_gid()` (matplotlib.backend_bases.GraphicsContextBase method), 920
`get_gid()` (matplotlib.collections.AsteriskPolygonCollection method), 978
`get_gid()` (matplotlib.collections.BrokenBarHCollection method), 990
`get_gid()` (matplotlib.collections.CircleCollection method), 1002
`get_gid()` (matplotlib.collections.Collection method), 1015
`get_gid()` (matplotlib.collections.EllipseCollection method), 1026
`get_gid()` (matplotlib.collections.EventCollection method), 1039
`get_gid()` (matplotlib.collections.LineCollection method), 1052
`get_gid()` (matplotlib.collections.PatchCollection method), 1063
`get_gid()` (matplotlib.collections.PathCollection method), 1075
`get_gid()` (matplotlib.collections.PolyCollection method), 1087
`get_gid()` (matplotlib.collections.QuadMesh method), 1099
`get_gid()` (matplotlib.collections.RegularPolyCollection method), 1111
`get_gid()` (matplotlib.collections.StarPolygonCollection method), 1124
`get_gid()` (matplotlib.collections.TriMesh method), 1135
`get_grid_positions()` (matplotlib.gridspec.GridSpecBase method), 1228
`get_gridlines()` (matplotlib.axis.Axis method), 800
`get_gridlines()` (matplotlib.axis.XAxis method), 825
`get_gridlines()` (matplotlib.axis.YAxis method), 815
`get_gridspec()` (matplotlib.gridspec.SubplotSpec method), 1229
`get_gid()` (matplotlib.text.Text method), 1626
`get_hatch()` (matplotlib.backend_bases.GraphicsContextBase method), 920
`get_hatch()` (matplotlib.collections.AsteriskPolygonCollection method), 978
`get_hatch()` (matplotlib.collections.BrokenBarHCollection method), 990
`get_hatch()` (matplotlib.collections.CircleCollection method), 1002
`get_hatch()` (matplotlib.collections.Collection method), 1015
`get_hatch()` (matplotlib.collections.EllipseCollection

- method), 1026
- get_hatch() (matplotlib.collections.EventCollection method), 1039
- get_hatch() (matplotlib.collections.LineCollection method), 1052
- get_hatch() (matplotlib.collections.PatchCollection method), 1063
- get_hatch() (matplotlib.collections.PathCollection method), 1075
- get_hatch() (matplotlib.collections.PolyCollection method), 1087
- get_hatch() (matplotlib.collections.QuadMesh method), 1099
- get_hatch() (matplotlib.collections.RegularPolyCollection method), 1111
- get_hatch() (matplotlib.collections.StarPolygonCollection method), 1124
- get_hatch() (matplotlib.collections.TriMesh method), 1135
- get_hatch() (matplotlib.patches.Patch method), 1352
- get_hatch_color() (matplotlib.backend_bases.GraphicsContextBase method), 920
- get_hatch_linewidth() (matplotlib.backend_bases.GraphicsContextBase method), 920
- get_hatch_path() (matplotlib.backend_bases.GraphicsContextBase method), 920
- get_height() (matplotlib.patches.FancyBboxPatch method), 1349
- get_height() (matplotlib.patches.Rectangle method), 1359
- get_height_char() (matplotlib.afm.AFM method), 488
- get_height_ratios() (matplotlib.gridspec.GridSpecBase method), 1228
- get_helper() (mpl_toolkits.axes_grid.axis_artist.AxisArtist method), 1802
- get_hinting_type() (matplotlib.mathtext.MathtextBackend method), 1269
- get_hinting_type() (matplotlib.mathtext.MathtextBackendAgg method), 1269
- get_horizontal() (mpl_toolkits.axes_grid.axes_divider.Divider method), 1796
- get_horizontal_sizes() (mpl_toolkits.axes_grid.axes_divider.Divider method), 1796
- get_horizontal_stem_width() (matplotlib.afm.AFM method), 488
- get_horizontalalignment() (matplotlib.text.Text method), 1627
- get_image_magnification() (matplotlib.backend_bases.RendererBase method), 929
- get_images() (matplotlib.axes.Axes method), 776
- get_joinstyle() (matplotlib.backend_bases.GraphicsContextBase method), 920
- get_joinstyle() (matplotlib.markers.MarkerStyle method), 1257
- get_joinstyle() (matplotlib.patches.Patch method), 1352
- get_kern() (matplotlib.mathtext.Fonts method), 1264
- get_kern() (matplotlib.mathtext.StandardPsFonts method), 1275
- get_kern() (matplotlib.mathtext.TruetypeFonts method), 1276
- get_kern_dist() (matplotlib.afm.AFM method), 488
- get_kern_dist_from_name() (matplotlib.afm.AFM method), 488
- get_kerning() (matplotlib.mathtext.Char method), 1262
- get_kerning() (matplotlib.mathtext.Node method), 1271
- get_label() (in module matplotlib.cbook), 961
- get_label() (matplotlib.artist.Artist method), 550
- get_label() (matplotlib.axes.Axes method), 783
- get_label() (matplotlib.axis.Axis method), 881
- get_label() (matplotlib.axis.Tick method), 841
- get_label() (matplotlib.axis.XAxis method), 892
- get_label() (matplotlib.axis.XTick method), 853
- get_label() (matplotlib.axis.YAxis method), 903
- get_label() (matplotlib.axis.YTick method), 864
- get_label() (matplotlib.collections.AsteriskPolygonCollection method), 978
- get_label() (matplotlib.collections.BrokenBarHCollection method), 990
- get_label() (matplotlib.collections.CircleCollection method), 1002
- get_label() (matplotlib.collections.Collection method), 920
- get_label() (matplotlib.collections.EllipseCollection

method), 1026

get_label() (matplotlib.collections.EventCollection method), 1039

get_label() (matplotlib.collections.LineCollection method), 1052

get_label() (matplotlib.collections.PatchCollection method), 1064

get_label() (matplotlib.collections.PathCollection method), 1075

get_label() (matplotlib.collections.PolyCollection method), 1087

get_label() (matplotlib.collections.QuadMesh method), 1099

get_label() (matplotlib.collections.RegularPolyCollection method), 1111

get_label() (matplotlib.collections.StarPolygonCollection method), 1124

get_label() (matplotlib.collections.TriMesh method), 1136

get_label() (matplotlib.container.Container method), 1165

get_label_position() (matplotlib.axis.Axis method), 797

get_label_position() (matplotlib.axis.XAxis method), 825

get_label_position() (matplotlib.axis.YAxis method), 816

get_label_text() (matplotlib.axis.Axis method), 797

get_label_text() (matplotlib.axis.XAxis method), 825

get_label_text() (matplotlib.axis.YAxis method), 816

get_legend() (matplotlib.axes.Axes method), 748

get_legend_handler() (matplotlib.legend.Legend static method), 1240

get_legend_handler_map() (matplotlib.legend.Legend method), 1240

get_legend_handles_labels() (matplotlib.axes.Axes method), 748

get_linelength() (matplotlib.collections.EventCollection method), 1039

get_lineoffset() (matplotlib.collections.EventCollection method), 1039

get_lines() (matplotlib.axes.Axes method), 776

get_lines() (matplotlib.legend.Legend method), 1240

get_linestyle() (matplotlib.backend_bases.GraphicsContextBase method), 920

get_linestyle() (matplotlib.collections.AsteriskPolygonCollection method), 978

get_linestyle() (matplotlib.collections.BrokenBarHCollection method), 990

get_linestyle() (matplotlib.collections.CircleCollection method), 1002

get_linestyle() (matplotlib.collections.Collection method), 1015

get_linestyle() (matplotlib.collections.EllipseCollection method), 1026

get_linestyle() (matplotlib.collections.EventCollection method), 1039

get_linestyle() (matplotlib.collections.LineCollection method), 1052

get_linestyle() (matplotlib.collections.PatchCollection method), 1064

get_linestyle() (matplotlib.collections.PathCollection method), 1075

get_linestyle() (matplotlib.collections.PolyCollection method), 1087

get_linestyle() (matplotlib.collections.QuadMesh method), 1099

get_linestyle() (matplotlib.collections.RegularPolyCollection method), 1111

get_linestyle() (matplotlib.collections.StarPolygonCollection method), 1124

get_linestyle() (matplotlib.collections.TriMesh method), 1136

get_linestyle() (matplotlib.lines.Line2D method), 1247

get_linestyle() (matplotlib.patches.Patch method), 1352

get_linestyles() (matplotlib.collections.AsteriskPolygonCollection method), 978

get_linestyles() (matplotlib.collections.AsteriskPolygonCollection method), 978

plotlib.collections.EventCollection method), 1039
 get_linewidths() (matplotlib.collections.LineCollection method), 1052
 get_linewidths() (matplotlib.collections.PatchCollection method), 1064
 get_linewidths() (matplotlib.collections.PathCollection method), 1075
 get_linewidths() (matplotlib.collections.PolyCollection method), 1087
 get_linewidths() (matplotlib.collections.QuadMesh method), 1100
 get_linewidths() (matplotlib.collections.RegularPolyCollection method), 1112
 get_linewidths() (matplotlib.collections.StarPolygonCollection method), 1124
 get_linewidths() (matplotlib.collections.TriMesh method), 1136
 get_loc() (matplotlib.axis.Tick method), 809
 get_loc() (matplotlib.axis.XTick method), 810
 get_loc() (matplotlib.axis.YTick method), 812
 get_loc_in_canvas() (matplotlib.offsetbox.DraggableOffsetBox method), 1317
 get_locator() (matplotlib.dates.AutoDateLocator method), 1172
 get_locator() (mpl_toolkits.axes_grid.axes_divider.Divider method), 1796
 get_ls() (matplotlib.lines.Line2D method), 1247
 get_ls() (matplotlib.patches.Patch method), 1352
 get_lw() (matplotlib.lines.Line2D method), 1247
 get_lw() (matplotlib.patches.Patch method), 1352
 get_major_formatter() (matplotlib.axis.Axis method), 795
 get_major_formatter() (matplotlib.axis.XAxis method), 825
 get_major_formatter() (matplotlib.axis.YAxis method), 816
 get_major_locator() (matplotlib.axis.Axis method), 795
 get_major_locator() (matplotlib.axis.XAxis method), 825
 get_major_locator() (matplotlib.axis.YAxis method), 816
 get_major_ticks() (matplotlib.axis.Axis method), 798
 get_major_ticks() (matplotlib.axis.XAxis method), 826
 get_major_ticks() (matplotlib.axis.YAxis method), 816
 get_major_ticks() (mpl_toolkits.mplot3d.axis3d.Axis method), 1870
 get_majorticklabels() (matplotlib.axis.Axis method), 798
 get_majorticklabels() (matplotlib.axis.XAxis method), 826
 get_majorticklabels() (matplotlib.axis.YAxis method), 816
 get_majorticklines() (matplotlib.axis.Axis method), 798
 get_majorticklines() (matplotlib.axis.XAxis method), 826
 get_majorticklines() (matplotlib.axis.YAxis method), 816
 get_majorticklocs() (matplotlib.axis.Axis method), 798
 get_majorticklocs() (matplotlib.axis.XAxis method), 826
 get_majorticklocs() (matplotlib.axis.YAxis method), 816
 get_marker() (matplotlib.lines.Line2D method), 1247
 get_marker() (matplotlib.markers.MarkerStyle method), 1257
 get_markeredgecolor() (matplotlib.lines.Line2D method), 1247
 get_markeredgewidth() (matplotlib.lines.Line2D method), 1248
 get_markerfacecolor() (matplotlib.lines.Line2D method), 1248
 get_markerfacecoloralt() (matplotlib.lines.Line2D method), 1248
 get_markersize() (matplotlib.lines.Line2D method), 1248
 get_markevery() (matplotlib.lines.Line2D method), 1248
 get_masked_triangles() (matplotlib.tri.Triangulation method), 1672
 get_matrix() (matplotlib.projections.polar.PolarAffine

method), 1380

get_matrix() (matplotlib.projections.polar.PolarAxes.PolarAffine method), 1381

get_matrix() (matplotlib.transforms.Affine2D method), 1663

get_matrix() (matplotlib.transforms.BboxTransform method), 1669

get_matrix() (matplotlib.transforms.BboxTransformFrom method), 1669

get_matrix() (matplotlib.transforms.BboxTransformTo method), 1669

get_matrix() (matplotlib.transforms.BlendedAffine2D method), 1667

get_matrix() (matplotlib.transforms.CompositeAffine2D method), 1668

get_matrix() (matplotlib.transforms.IdentityTransform method), 1664

get_matrix() (matplotlib.transforms.ScaledTranslation method), 1669

get_matrix() (matplotlib.transforms.Transform method), 1658

get_mec() (matplotlib.lines.Line2D method), 1248

get_metrics() (matplotlib.mathtext.Fonts method), 1264

get_mew() (matplotlib.lines.Line2D method), 1248

get_mfc() (matplotlib.lines.Line2D method), 1248

get_mfcalt() (matplotlib.lines.Line2D method), 1248

get_minimumdescent() (matplotlib.offsetbox.TextArea method), 1322

get_minor_formatter() (matplotlib.axis.Axis method), 795

get_minor_formatter() (matplotlib.axis.XAxis method), 826

get_minor_formatter() (matplotlib.axis.YAxis method), 817

get_minor_locator() (matplotlib.axis.Axis method), 795

get_minor_locator() (matplotlib.axis.XAxis method), 826

get_minor_locator() (matplotlib.axis.YAxis method), 817

get_minor_ticks() (matplotlib.axis.Axis method), 798

get_minor_ticks() (matplotlib.axis.XAxis method), 826

get_minor_ticks() (matplotlib.axis.YAxis method), 817

get_minorticklabels() (matplotlib.axis.Axis method), 798

get_minorticklabels() (matplotlib.axis.XAxis method), 826

get_minorticklabels() (matplotlib.axis.YAxis method), 817

get_minorticklines() (matplotlib.axis.Axis method), 798

get_minorticklines() (matplotlib.axis.XAxis method), 827

get_minorticklines() (matplotlib.axis.YAxis method), 817

get_minorticklocs() (matplotlib.axis.Axis method), 799

get_minorticklocs() (matplotlib.axis.XAxis method), 827

get_minorticklocs() (matplotlib.axis.YAxis method), 817

get_minpos() (matplotlib.axis.Axis method), 801

get_minpos() (matplotlib.axis.XAxis method), 827

get_minpos() (matplotlib.axis.YAxis method), 817

get_ms() (matplotlib.lines.Line2D method), 1248

get_multilinebaseline() (matplotlib.offsetbox.TextArea method), 1322

get_mutation_aspect() (matplotlib.patches.FancyArrowPatch method), 1346

get_mutation_aspect() (matplotlib.patches.FancyBboxPatch method), 1349

get_mutation_scale() (matplotlib.patches.FancyArrowPatch method), 1346

get_mutation_scale() (matplotlib.patches.FancyBboxPatch method), 1349

get_name() (matplotlib.font_manager.FontProperties method), 1222

get_name() (matplotlib.text.Text method), 1627

get_name_char() (matplotlib.afm.AFM method),

- 488
- `get_named_colors_mapping()` (in module `matplotlib.colors`), 1162
- `get_navigate()` (`matplotlib.axes.Axes` method), 771
- `get_navigate_mode()` (`matplotlib.axes.Axes` method), 771
- `get_numpoints()` (`matplotlib.legend_handler.HandlerLineCollection` method), 1243
- `get_numpoints()` (`matplotlib.legend_handler.HandlerNpoints` method), 1243
- `get_numpoints()` (`matplotlib.legend_handler.HandlerRegularPolygonCollection` method), 1244
- `get_numsides()` (`matplotlib.collections.AsteriskPolygonCollection` method), 979
- `get_numsides()` (`matplotlib.collections.RegularPolygonCollection` method), 1112
- `get_numsides()` (`matplotlib.collections.StarPolygonCollection` method), 1124
- `get_offset()` (`matplotlib.offsetbox.AuxTransformBox` method), 1316
- `get_offset()` (`matplotlib.offsetbox.DrawingArea` method), 1318
- `get_offset()` (`matplotlib.offsetbox.OffsetBox` method), 1319
- `get_offset()` (`matplotlib.offsetbox.OffsetImage` method), 1320
- `get_offset()` (`matplotlib.offsetbox.TextArea` method), 1322
- `get_offset()` (`matplotlib.ticker.FixedFormatter` method), 1638
- `get_offset()` (`matplotlib.ticker.Formatter` method), 1638
- `get_offset()` (`matplotlib.ticker.ScalarFormatter` method), 1639
- `get_offset_position()` (`matplotlib.collections.AsteriskPolygonCollection` method), 979
- `get_offset_position()` (`matplotlib.collections.BrokenBarHCollection` method), 991
- `get_offset_position()` (`matplotlib.collections.CircleCollection` method), 1003
- `get_offset_position()` (`matplotlib.collections.Collection` method), 1015
- `get_offset_position()` (`matplotlib.collections.EllipseCollection` method), 1027
- `get_offset_position()` (`matplotlib.collections.EventCollection` method), 1039
- `get_offset_position()` (`matplotlib.collections.LineCollection` method), 1052
- `get_offset_position()` (`matplotlib.collections.PatchCollection` method), 1064
- `get_offset_position()` (`matplotlib.collections.PathCollection` method), 1075
- `get_offset_position()` (`matplotlib.collections.PolyCollection` method), 1087
- `get_offset_position()` (`matplotlib.collections.QuadMesh` method), 1100
- `get_offset_position()` (`matplotlib.collections.RegularPolygonCollection` method), 1112
- `get_offset_position()` (`matplotlib.collections.StarPolygonCollection` method), 1124
- `get_offset_position()` (`matplotlib.collections.TriMesh` method), 1136
- `get_offset_text()` (`matplotlib.axis.Axis` method), 799
- `get_offset_text()` (`matplotlib.axis.XAxis` method), 827
- `get_offset_text()` (`matplotlib.axis.YAxis` method), 817
- `get_offset_transform()` (`matplotlib.collections.AsteriskPolygonCollection` method), 979
- `get_offset_transform()` (`matplotlib.collections.BrokenBarHCollection` method), 991
- `get_offset_transform()` (`matplotlib.collections.CircleCollection` method), 1003

`get_offset_transform()` (matplotlib.collections.Collection method), 1015
`get_offset_transform()` (matplotlib.collections.EllipseCollection method), 1027
`get_offset_transform()` (matplotlib.collections.EventCollection method), 1039
`get_offset_transform()` (matplotlib.collections.LineCollection method), 1052
`get_offset_transform()` (matplotlib.collections.PatchCollection method), 1064
`get_offset_transform()` (matplotlib.collections.PathCollection method), 1076
`get_offset_transform()` (matplotlib.collections.PolyCollection method), 1088
`get_offset_transform()` (matplotlib.collections.QuadMesh method), 1100
`get_offset_transform()` (matplotlib.collections.RegularPolyCollection method), 1112
`get_offset_transform()` (matplotlib.collections.StarPolygonCollection method), 1124
`get_offset_transform()` (matplotlib.collections.TriMesh method), 1136
`get_offset_transform()` (matplotlib.collections.EventCollection method), 1040
`get_offset_transform()` (matplotlib.collections.QuadMesh method), 1100
`get_offset_transform()` (matplotlib.collections.RegularPolyCollection method), 1112
`get_offset_transform()` (matplotlib.collections.StarPolygonCollection method), 1124
`get_offset_transform()` (matplotlib.collections.TriMesh method), 1136
`get_offsets()` (matplotlib.collections.AsteriskPolygonCollection method), 979
`get_offsets()` (matplotlib.collections.BrokenBarHCollection method), 991
`get_offsets()` (matplotlib.collections.CircleCollection method), 1003
`get_offsets()` (matplotlib.collections.Collection method), 1015
`get_offsets()` (matplotlib.collections.EllipseCollection method), 1027
`get_offsets()` (matplotlib.collections.EventCollection method), 1039
`get_offsets()` (matplotlib.collections.LineCollection method), 1052
`get_offsets()` (matplotlib.collections.PatchCollection method), 1064
`get_offsets()` (matplotlib.collections.PathCollection method), 1076
`get_offsets()` (matplotlib.collections.PolyCollection method), 1088
`get_offsets()` (matplotlib.collections.QuadMesh method), 1100
`get_offsets()` (matplotlib.collections.RegularPolyCollection method), 1112
`get_offsets()` (matplotlib.collections.StarPolygonCollection method), 1124
`get_offsets()` (matplotlib.collections.TriMesh method), 1136
`get_orientation()` (matplotlib.collections.EventCollection method), 1040
`get_pad()` (matplotlib.axis.Tick method), 809
`get_pad()` (matplotlib.axis.XTick method), 810
`get_pad()` (matplotlib.axis.YTick method), 812
`get_pad()` (mpl_toolkits.axes_grid.axis_artist.AxisLabel method), 1804
`get_pad_pixels()` (matplotlib.axis.Tick method), 809
`get_pad_pixels()` (matplotlib.axis.XTick method), 811
`get_pad_pixels()` (matplotlib.axis.YTick method), 812
`get_pagecount()` (matplotlib.backends.backend_pdf.PdfPages method), 950
`get_patch_transform()` (matplotlib.patches.Arrow method), 1328
`get_patch_transform()` (matplotlib.patches.Ellipse method), 1343
`get_patch_transform()` (matplotlib.patches.Patch method), 1353
`get_patch_transform()` (matplotlib.patches.Rectangle method), 1359
`get_patch_transform()` (matplotlib.patches.RegularPolygon method), 1361
`get_patch_transform()` (matplotlib.patches.Shadow method), 1362

`get_patch_transform()` (matplotlib.patches.YAArrow method), 1365
`get_patch_transform()` (matplotlib.spines.Spine method), 1616
`get_patch_verts()` (in module `mpl_toolkits.mplot3d.art3d`), 1874
`get_patches()` (matplotlib.legend.Legend method), 1240
`get_path()` (matplotlib.lines.Line2D method), 1248
`get_path()` (matplotlib.markers.MarkerStyle method), 1257
`get_path()` (matplotlib.patches.Arrow method), 1328
`get_path()` (matplotlib.patches.Ellipse method), 1343
`get_path()` (matplotlib.patches.FancyArrowPatch method), 1346
`get_path()` (matplotlib.patches.FancyBboxPatch method), 1349
`get_path()` (matplotlib.patches.Patch method), 1353
`get_path()` (matplotlib.patches.PathPatch method), 1356
`get_path()` (matplotlib.patches.Polygon method), 1357
`get_path()` (matplotlib.patches.Rectangle method), 1359
`get_path()` (matplotlib.patches.RegularPolygon method), 1361
`get_path()` (matplotlib.patches.Shadow method), 1362
`get_path()` (matplotlib.patches.Wedge method), 1363
`get_path()` (matplotlib.patches.YAArrow method), 1365
`get_path()` (matplotlib.spines.Spine method), 1616
`get_path()` (mpl_toolkits.axes_grid1.inset_locator.BboxConnecton method), 1814
`get_path()` (mpl_toolkits.axes_grid1.inset_locator.BboxConnectonPatch method), 1815
`get_path()` (mpl_toolkits.axes_grid1.inset_locator.BboxPatch method), 1816
`get_path()` (mpl_toolkits.mplot3d.art3d.Patch3D method), 1872
`get_path_collection_extents()` (in module `matplotlib.path`), 1373
`get_path_effects()` (matplotlib.artist.Artist method), 546
`get_path_effects()` (matplotlib.axes.Axes method), 784
`get_path_effects()` (matplotlib.axis.Axis method), 881
`get_path_effects()` (matplotlib.axis.Tick method), 841
`get_path_effects()` (matplotlib.axis.XAxis method), 892
`get_path_effects()` (matplotlib.axis.XTick method), 853
`get_path_effects()` (matplotlib.axis.YAxis method), 903
`get_path_effects()` (matplotlib.axis.YTick method), 864
`get_path_effects()` (matplotlib.collections.AsteriskPolygonCollection method), 979
`get_path_effects()` (matplotlib.collections.BrokenBarHCollection method), 991
`get_path_effects()` (matplotlib.collections.CircleCollection method), 1003
`get_path_effects()` (matplotlib.collections.Collection method), 1015
`get_path_effects()` (matplotlib.collections.EllipseCollection method), 1027
`get_path_effects()` (matplotlib.collections.EventCollection method), 1040
`get_path_effects()` (matplotlib.collections.LineCollection method), 1052
`get_path_effects()` (matplotlib.collections.PatchCollection method), 1064
`get_path_effects()` (matplotlib.collections.PathCollection method), 1076
`get_path_effects()` (matplotlib.collections.PolyCollection method), 1088
`get_path_effects()` (matplotlib.collections.QuadMesh method), 1100
`get_path_effects()` (matplotlib.collections.RegularPolyCollection method), 1112
`get_path_effects()` (matplotlib.collections.StarPolygonCollection method), 1124

`get_path_effects()` (matplotlib.collections.TriMesh method), 1136
`get_path_in_displaycoord()` (matplotlib.patches.ConnectionPatch method), 1339
`get_path_in_displaycoord()` (matplotlib.patches.FancyArrowPatch method), 1347
`get_paths()` (matplotlib.collections.AsteriskPolygonCollection method), 979
`get_paths()` (matplotlib.collections.BrokenBarHCollection method), 991
`get_paths()` (matplotlib.collections.CircleCollection method), 1003
`get_paths()` (matplotlib.collections.Collection method), 1015
`get_paths()` (matplotlib.collections.EllipseCollection method), 1027
`get_paths()` (matplotlib.collections.EventCollection method), 1040
`get_paths()` (matplotlib.collections.LineCollection method), 1052
`get_paths()` (matplotlib.collections.PatchCollection method), 1064
`get_paths()` (matplotlib.collections.PathCollection method), 1076
`get_paths()` (matplotlib.collections.PolyCollection method), 1088
`get_paths()` (matplotlib.collections.QuadMesh method), 1100
`get_paths()` (matplotlib.collections.RegularPolyCollection method), 1112
`get_paths()` (matplotlib.collections.StarPolygonCollection method), 1124
`get_paths()` (matplotlib.collections.TriMesh method), 1136
`get_paths_extents()` (in module matplotlib.path), 1374
`get_picker()` (matplotlib.artist.Artist method), 538
`get_picker()` (matplotlib.axes.Axes method), 773
`get_picker()` (matplotlib.axis.Axis method), 881
`get_picker()` (matplotlib.axis.Tick method), 841
`get_picker()` (matplotlib.axis.XAxis method), 892
`get_picker()` (matplotlib.axis.XTick method), 853
`get_picker()` (matplotlib.axis.YAxis method), 904
`get_picker()` (matplotlib.axis.YTick method), 864
`get_picker()` (matplotlib.collections.AsteriskPolygonCollection method), 979
`get_picker()` (matplotlib.collections.BrokenBarHCollection method), 991
`get_picker()` (matplotlib.collections.CircleCollection method), 1003
`get_picker()` (matplotlib.collections.Collection method), 1015
`get_picker()` (matplotlib.collections.EllipseCollection method), 1027
`get_picker()` (matplotlib.collections.EventCollection method), 1040
`get_picker()` (matplotlib.collections.LineCollection method), 1052
`get_picker()` (matplotlib.collections.PatchCollection method), 1064
`get_picker()` (matplotlib.collections.PathCollection method), 1076
`get_picker()` (matplotlib.collections.PolyCollection method), 1088
`get_picker()` (matplotlib.collections.QuadMesh method), 1100
`get_picker()` (matplotlib.collections.RegularPolyCollection method), 1112
`get_picker()` (matplotlib.collections.StarPolygonCollection method), 1124
`get_picker()` (matplotlib.collections.TriMesh method), 1136
`get_pickradius()` (matplotlib.axis.Axis method), 802
`get_pickradius()` (matplotlib.axis.XAxis method), 827
`get_pickradius()` (matplotlib.axis.YAxis method), 818
`get_pickradius()` (matplotlib.collections.AsteriskPolygonCollection method), 979
`get_pickradius()` (matplotlib.collections.BrokenBarHCollection method), 991
`get_pickradius()` (matplotlib.collections.CircleCollection method), 1003
`get_pickradius()` (matplotlib.collections.Collection method), 1015
`get_pickradius()` (matplotlib.collections.EllipseCollection method), 1027
`get_pickradius()` (matplotlib.collections.EventCollection method), 1040

`get_pickradius()` (matplotlib.collections.LineCollection method), 1053
`get_pickradius()` (matplotlib.collections.PatchCollection method), 1064
`get_pickradius()` (matplotlib.collections.PathCollection method), 1076
`get_pickradius()` (matplotlib.collections.PolyCollection method), 1088
`get_pickradius()` (matplotlib.collections.QuadMesh method), 1100
`get_pickradius()` (matplotlib.collections.RegularPolyCollection method), 1112
`get_pickradius()` (matplotlib.collections.StarPolygonCollection method), 1124
`get_pickradius()` (matplotlib.collections.TriMesh method), 1136
`get_pickradius()` (matplotlib.lines.Line2D method), 1248
`get_plot_commands()` (in module matplotlib.pyplot), 1486
`get_points()` (matplotlib.transforms.Bbox method), 1655
`get_points()` (matplotlib.transforms.TransformedBbox method), 1657
`get_position()` (matplotlib.axes.Axes method), 768
`get_position()` (matplotlib.gridspec.SubplotSpec method), 1229
`get_position()` (matplotlib.spines.Spine method), 1616
`get_position()` (matplotlib.text.Text method), 1627
`get_position()` (matplotlib.text.TextWithDash method), 1633
`get_position()` (mpl_toolkits.axes_grid.axes_divider.Divider method), 1796
`get_position()` (mpl_toolkits.axes_grid.axes_divider.SubplotDivider method), 1799
`get_position_runtime()` (mpl_toolkits.axes_grid.axes_divider.Divider method), 1796
`get_positions()` (matplotlib.collections.EventCollection method), 1040
`get_proj()` (mpl_toolkits.mplot3d.axes3d.Axes3D method), 1852
`get_projection_class()` (in module matplotlib.projections), 1379
`get_projection_class()` (matplotlib.projections.ProjectionRegistry method), 1379
`get_projection_names()` (in module matplotlib.projections), 1379
`get_projection_names()` (matplotlib.projections.ProjectionRegistry method), 1379
`get_prop_tup()` (matplotlib.text.Text method), 1627
`get_prop_tup()` (matplotlib.text.TextWithDash method), 1633
`get_radius()` (matplotlib.patches.Circle method), 1337
`get_rasterization_zorder()` (matplotlib.axes.Axes method), 777
`get_rasterized()` (matplotlib.artist.Artist method), 545
`get_rasterized()` (matplotlib.axes.Axes method), 784
`get_rasterized()` (matplotlib.axis.Axis method), 881
`get_rasterized()` (matplotlib.axis.Tick method), 841
`get_rasterized()` (matplotlib.axis.XAxis method), 893
`get_rasterized()` (matplotlib.axis.XTick method), 853
`get_rasterized()` (matplotlib.axis.YAxis method), 904
`get_rasterized()` (matplotlib.axis.YTick method), 864
`get_rasterized()` (matplotlib.collections.AsteriskPolygonCollection method), 979
`get_rasterized()` (matplotlib.collections.BrokenBarHCollection method), 991
`get_rasterized()` (matplotlib.collections.CircleCollection method), 1003
`get_rasterized()` (matplotlib.collections.Collection method), 1015
`get_rasterized()` (matplotlib.collections.EllipseCollection method), 1027
`get_rasterized()` (matplotlib.collections.EventCollection method), 1040
`get_rasterized()` (matplotlib.collections.LineCollection method),

- 1053
- get_rasterized() (matplotlib.collections.PatchCollection method), 1064
- get_rasterized() (matplotlib.collections.PathCollection method), 1076
- get_rasterized() (matplotlib.collections.PolyCollection method), 1088
- get_rasterized() (matplotlib.collections.QuadMesh method), 1100
- get_rasterized() (matplotlib.collections.RegularPolyCollection method), 1112
- get_rasterized() (matplotlib.collections.StarPolygonCollection method), 1124
- get_rasterized() (matplotlib.collections.TriMesh method), 1136
- get_recursive_filelist() (in module matplotlib.cbook), 961
- get_registered_canvas_class() (in module matplotlib.backend_bases), 933
- get_renderer() (in module matplotlib.tight_layout), 1647
- get_renderer_cache() (matplotlib.axes.Axes method), 777
- get_results() (matplotlib.mathtext.Fonts method), 1265
- get_results() (matplotlib.mathtext.MathtextBackend method), 1269
- get_results() (matplotlib.mathtext.MathtextBackendAgg method), 1269
- get_results() (matplotlib.mathtext.MathtextBackendBitmap method), 1269
- get_results() (matplotlib.mathtext.MathtextBackendCairo method), 1270
- get_results() (matplotlib.mathtext.MathtextBackendPath method), 1270
- get_results() (matplotlib.mathtext.MathtextBackendPdf method), 1270
- get_results() (matplotlib.mathtext.MathtextBackendPps method), 1270
- get_results() (matplotlib.mathtext.MathtextBackendSvg method), 1271
- get_rgb() (matplotlib.backend_bases.GraphicsContextBase method), 921
- get_rlabel_position() (matplotlib.projections.polar.PolarAxes method), 1382
- get_rotate_label() (mpl_toolkits.mplot3d.axis3d.Axis method), 1870
- get_rotation() (in module matplotlib.text), 1634
- get_rotation() (matplotlib.collections.AsteriskPolygonCollection method), 979
- get_rotation() (matplotlib.collections.RegularPolyCollection method), 1112
- get_rotation() (matplotlib.collections.StarPolygonCollection method), 1125
- get_rotation() (matplotlib.text.Text method), 1627
- get_rotation_mode() (matplotlib.text.Text method), 1627
- get_sample_data() (in module matplotlib.cbook), 961
- get_scale() (matplotlib.axis.Axis method), 795
- get_scale() (matplotlib.axis.XAxis method), 827
- get_scale() (matplotlib.axis.YAxis method), 818
- get_scale_docs() (in module matplotlib.scale), 1613
- get_scale_names() (in module matplotlib.scale), 1613
- get_segments() (matplotlib.collections.EventCollection method), 1040
- get_segments() (matplotlib.collections.LineCollection method), 1053
- get_shared_x_axes() (matplotlib.axes.Axes method), 767
- get_shared_y_axes() (matplotlib.axes.Axes method), 767
- get_siblings() (matplotlib.cbook.Grouper method), 955
- get_size() (matplotlib.font_manager.FontProperties method), 1222
- get_size() (matplotlib.text.Text method), 1627

get_size_in_points()	(matplotlib.font_manager.FontProperties method), 1222	get_sketch_params()	(matplotlib.backend_bases.GraphicsContextBase method), 921
get_size_inches()	(matplotlib.figure.Figure method), 1197	get_sketch_params()	(matplotlib.collections.AsteriskPolygonCollection method), 979
get_sized_alternatives_for_symbol()	(matplotlib.mathtext.BakomaFonts method), 1261	get_sketch_params()	(matplotlib.collections.BrokenBarHCollection method), 991
get_sized_alternatives_for_symbol()	(matplotlib.mathtext.Fonts method), 1265	get_sketch_params()	(matplotlib.collections.CircleCollection method), 1003
get_sized_alternatives_for_symbol()	(matplotlib.mathtext.StixFonts method), 1275	get_sketch_params()	(matplotlib.collections.Collection method), 1015
get_sized_alternatives_for_symbol()	(matplotlib.mathtext.UnicodeFonts method), 1276	get_sketch_params()	(matplotlib.collections.EllipseCollection method), 1027
get_sizes()	(matplotlib.collections.AsteriskPolygonCollection method), 979	get_sketch_params()	(matplotlib.collections.EventCollection method), 1040
get_sizes()	(matplotlib.collections.BrokenBarHCollection method), 991	get_sketch_params()	(matplotlib.collections.LineCollection method), 1053
get_sizes()	(matplotlib.collections.CircleCollection method), 1003	get_sketch_params()	(matplotlib.collections.PatchCollection method), 1064
get_sizes()	(matplotlib.collections.PathCollection method), 1076	get_sketch_params()	(matplotlib.collections.PathCollection method), 1076
get_sizes()	(matplotlib.collections.PolyCollection method), 1088	get_sketch_params()	(matplotlib.collections.PolyCollection method), 1088
get_sizes()	(matplotlib.collections.RegularPolyCollection method), 1112	get_sketch_params()	(matplotlib.collections.QuadMesh method), 1100
get_sizes()	(matplotlib.collections.StarPolygonCollection method), 1125	get_sketch_params()	(matplotlib.collections.RegularPolyCollection method), 1112
get_sizes()	(matplotlib.legend_handler.HandlerRegularPolyCollection method), 1244	get_sketch_params()	(matplotlib.collections.StarPolygonCollection method), 1125
get_sketch_params()	(matplotlib.artist.Artist method), 545	get_sketch_params()	(matplotlib.collections.TriMesh method), 1136
get_sketch_params()	(matplotlib.axes.Axes method), 782	get_slant()	(matplotlib.font_manager.FontProperties method), 1222
get_sketch_params()	(matplotlib.axis.Axis method), 881	get_smart_bounds()	(matplotlib.axis.Axis method),
get_sketch_params()	(matplotlib.axis.Tick method), 842		
get_sketch_params()	(matplotlib.axis.XAxis method), 893		
get_sketch_params()	(matplotlib.axis.XTick method), 853		
get_sketch_params()	(matplotlib.axis.YAxis method), 904		
get_sketch_params()	(matplotlib.axis.YTick method), 864		

- 806
- get_smart_bounds() (matplotlib.axis.XAxis method), 827
- get_smart_bounds() (matplotlib.axis.YAxis method), 818
- get_smart_bounds() (matplotlib.spines.Spine method), 1616
- get_snap() (matplotlib.artist.Artist method), 543
- get_snap() (matplotlib.axes.Axes method), 784
- get_snap() (matplotlib.axis.Axis method), 882
- get_snap() (matplotlib.axis.Tick method), 842
- get_snap() (matplotlib.axis.XAxis method), 893
- get_snap() (matplotlib.axis.XTick method), 853
- get_snap() (matplotlib.axis.YAxis method), 904
- get_snap() (matplotlib.axis.YTick method), 865
- get_snap() (matplotlib.backend_bases.GraphicsContextBase method), 921
- get_snap() (matplotlib.collections.AsteriskPolygonCollection method), 980
- get_snap() (matplotlib.collections.BrokenBarHCollection method), 991
- get_snap() (matplotlib.collections.CircleCollection method), 1003
- get_snap() (matplotlib.collections.Collection method), 1016
- get_snap() (matplotlib.collections.EllipseCollection method), 1027
- get_snap() (matplotlib.collections.EventCollection method), 1040
- get_snap() (matplotlib.collections.LineCollection method), 1053
- get_snap() (matplotlib.collections.PatchCollection method), 1065
- get_snap() (matplotlib.collections.PathCollection method), 1076
- get_snap() (matplotlib.collections.PolyCollection method), 1088
- get_snap() (matplotlib.collections.QuadMesh method), 1100
- get_snap() (matplotlib.collections.RegularPolyCollection method), 1113
- get_snap() (matplotlib.collections.StarPolygonCollection method), 1125
- get_snap() (matplotlib.collections.TriMesh method), 1137
- get_snap_threshold() (matplotlib.markers.MarkerStyle method), 1257
- get_solid_capstyle() (matplotlib.lines.Line2D method), 1248
- get_solid_joinstyle() (matplotlib.lines.Line2D method), 1248
- get_sparse_matrix() (in module matplotlib.mlab), 1296
- get_spine_transform() (matplotlib.spines.Spine method), 1616
- get_split_ind() (in module matplotlib.cbook), 961
- get_state() (matplotlib.mathtext.Parser method), 1272
- get_str_bbox() (matplotlib.afm.AFM method), 488
- get_str_bbox_and_descent() (matplotlib.afm.AFM method), 488
- get_stretch() (matplotlib.font_manager.FontProperties method), 1222
- get_stretch() (matplotlib.text.Text method), 1627
- get_style() (matplotlib.font_manager.FontProperties method), 1222
- get_style() (matplotlib.text.Text method), 1627
- get_subplot_params() (matplotlib.gridspec.GridSpec method), 1227
- get_subplot_params() (matplotlib.gridspec.GridSpecBase method), 1228
- get_subplot_params() (matplotlib.gridspec.GridSpecFromSubplotSpec method), 1228
- get_subplotspec() (mpl_toolkits.axes_grid.axes_divider.AxesLocator method), 1798
- get_subplotspec() (mpl_toolkits.axes_grid.axes_divider.SubplotDivi method), 1799
- get_subplotspec_list() (in module matplotlib.tight_layout), 1647
- get_supported_filetypes() (matplotlib.backend_bases.FigureCanvasBase class method), 915
- get_supported_filetypes_grouped() (matplotlib.backend_bases.FigureCanvasBase class method), 915
- get_test_data() (in module mpl_toolkits.mplot3d.axes3d), 1869
- get_texmanager() (matplotlib.backend_bases.RendererBase method), 929
- get_text() (matplotlib.offsetbox.TextArea method), 1322

- [get_text\(\) \(matplotlib.text.Text method\), 1627](#)
[get_text_heights\(\) \(matplotlib.axis.XAxis method\), 805](#)
[get_text_width_height_descent\(\) \(matplotlib.backend_bases.RendererBase method\), 930](#)
[get_text_widths\(\) \(matplotlib.axis.YAxis method\), 804](#)
[get_texts\(\) \(matplotlib.legend.Legend method\), 1240](#)
[get_texts_widths_heights_descents\(\) \(mpl_toolkits.axes_grid.axis_artist.TickLabel method\), 1804](#)
[get_theta_direction\(\) \(matplotlib.projections.polar.PolarAxes method\), 1382](#)
[get_theta_offset\(\) \(matplotlib.projections.polar.PolarAxes method\), 1382](#)
[get_tick_out\(\) \(mpl_toolkits.axes_grid.axis_artist.Tick method\), 1803](#)
[get_tick_padding\(\) \(matplotlib.axis.Axis method\), 799](#)
[get_tick_padding\(\) \(matplotlib.axis.Tick method\), 809](#)
[get_tick_padding\(\) \(matplotlib.axis.XAxis method\), 827](#)
[get_tick_padding\(\) \(matplotlib.axis.XTick method\), 811](#)
[get_tick_padding\(\) \(matplotlib.axis.YAxis method\), 818](#)
[get_tick_padding\(\) \(matplotlib.axis.YTick method\), 812](#)
[get_tick_positions\(\) \(mpl_toolkits.mplot3d.axis3d.Axis method\), 1870](#)
[get_tick_space\(\) \(matplotlib.axis.Axis method\), 801](#)
[get_tick_space\(\) \(matplotlib.axis.XAxis method\), 828](#)
[get_tick_space\(\) \(matplotlib.axis.YAxis method\), 818](#)
[get_tickdir\(\) \(matplotlib.axis.Tick method\), 809](#)
[get_tickdir\(\) \(matplotlib.axis.XTick method\), 811](#)
[get_tickdir\(\) \(matplotlib.axis.YTick method\), 812](#)
[get_ticklabel_extents\(\) \(matplotlib.axis.Axis method\), 801](#)
[get_ticklabel_extents\(\) \(matplotlib.axis.XAxis method\), 828](#)
[get_ticklabel_extents\(\) \(matplotlib.axis.YAxis method\), 818](#)
[get_ticklabels\(\) \(matplotlib.axis.Axis method\), 799](#)
[get_ticklabels\(\) \(matplotlib.axis.XAxis method\), 828](#)
[get_ticklabels\(\) \(matplotlib.axis.YAxis method\), 818](#)
[get_ticklines\(\) \(matplotlib.axis.Axis method\), 799](#)
[get_ticklines\(\) \(matplotlib.axis.XAxis method\), 828](#)
[get_ticklines\(\) \(matplotlib.axis.YAxis method\), 819](#)
[get_ticklocs\(\) \(matplotlib.axis.Axis method\), 799](#)
[get_ticklocs\(\) \(matplotlib.axis.XAxis method\), 828](#)
[get_ticklocs\(\) \(matplotlib.axis.YAxis method\), 819](#)
[get_ticks_position\(\) \(matplotlib.axis.XAxis method\), 805](#)
[get_ticks_position\(\) \(matplotlib.axis.YAxis method\), 804](#)
[get_ticks_size\(\) \(mpl_toolkits.axes_grid.axis_artist.Ticks method\), 1803](#)
[get_tight_layout\(\) \(matplotlib.figure.Figure method\), 1197](#)
[get_tight_layout_figure\(\) \(in module matplotlib.tight_layout\), 1648](#)
[get_tightbbox\(\) \(matplotlib.axes.Axes method\), 777](#)
[get_tightbbox\(\) \(matplotlib.axis.Axis method\), 802](#)
[get_tightbbox\(\) \(matplotlib.axis.XAxis method\), 828](#)
[get_tightbbox\(\) \(matplotlib.axis.YAxis method\), 819](#)
[get_tightbbox\(\) \(matplotlib.figure.Figure method\), 1197](#)
[get_tightbbox\(\) \(mpl_toolkits.axes_grid.axis_artist.AxisArtist method\), 1802](#)
[get_tightbbox\(\) \(mpl_toolkits.mplot3d.axis3d.Axis method\), 1870](#)
[get_title\(\) \(matplotlib.axes.Axes method\), 744](#)
[get_title\(\) \(matplotlib.legend.Legend method\), 1240](#)
[get_tool\(\) \(matplotlib.backend_managers.ToolManager method\), 935](#)
[get_tool_keymap\(\) \(matplotlib.backend_managers.ToolManager method\), 935](#)
[get_topmost_subplotspec\(\) \(matplotlib.gridspec.GridSpecFromSubplotSpec method\), 1229](#)
[get_topmost_subplotspec\(\) \(matplotlib.gridspec.SubplotSpec method\), 1229](#)
[get_transform\(\) \(matplotlib.artist.Artist method\), 548](#)
[get_transform\(\) \(matplotlib.axes.Axes method\), 784](#)
[get_transform\(\) \(matplotlib.axis.Axis method\), 882](#)

- get_transform() (matplotlib.axis.Tick method), 842
- get_transform() (matplotlib.axis.XAxis method), 893
- get_transform() (matplotlib.axis.XTick method), 854
- get_transform() (matplotlib.axis.YAxis method), 904
- get_transform() (matplotlib.axis.YTick method), 865
- get_transform() (matplotlib.collections.AsteriskPolygonCollection method), 980
- get_transform() (matplotlib.collections.BrokenBarHCollection method), 992
- get_transform() (matplotlib.collections.CircleCollection method), 1004
- get_transform() (matplotlib.collections.Collection method), 1016
- get_transform() (matplotlib.collections.EllipseCollection method), 1028
- get_transform() (matplotlib.collections.EventCollection method), 1040
- get_transform() (matplotlib.collections.LineCollection method), 1053
- get_transform() (matplotlib.collections.PatchCollection method), 1065
- get_transform() (matplotlib.collections.PathCollection method), 1076
- get_transform() (matplotlib.collections.PolyCollection method), 1088
- get_transform() (matplotlib.collections.QuadMesh method), 1101
- get_transform() (matplotlib.collections.RegularPolyCollection method), 1113
- get_transform() (matplotlib.collections.StarPolygonCollection method), 1125
- get_transform() (matplotlib.collections.TriMesh method), 1137
- get_transform() (matplotlib.image.BboxImage method), 1232
- get_transform() (matplotlib.markers.MarkerStyle method), 1257
- get_transform() (matplotlib.offsetbox.AuxTransformBox method), 1316
- get_transform() (matplotlib.offsetbox.DrawingArea method), 1318
- get_transform() (matplotlib.patches.Patch method), 1353
- get_transform() (matplotlib.scale.LinearScale method), 1606
- get_transform() (matplotlib.scale.LogitScale method), 1610
- get_transform() (matplotlib.scale.LogScale method), 1609
- get_transform() (matplotlib.scale.ScaleBase method), 1611
- get_transform() (matplotlib.scale.SymmetricalLogScale method), 1613
- get_transform() (mpl_toolkits.axes_grid.axis_artist.AxisArtist method), 1802
- get_transformed_clip_path_and_affine() (matplotlib.artist.Artist method), 546
- get_transformed_clip_path_and_affine() (matplotlib.axes.Axes method), 789
- get_transformed_clip_path_and_affine() (matplotlib.axis.Axis method), 882
- get_transformed_clip_path_and_affine() (matplotlib.axis.Tick method), 842
- get_transformed_clip_path_and_affine() (matplotlib.axis.XAxis method), 893
- get_transformed_clip_path_and_affine() (matplotlib.axis.XTick method), 854
- get_transformed_clip_path_and_affine() (matplotlib.axis.YAxis method), 905
- get_transformed_clip_path_and_affine() (matplotlib.axis.YTick method), 865
- get_transformed_clip_path_and_affine() (matplotlib.collections.AsteriskPolygonCollection method), 980
- get_transformed_clip_path_and_affine() (matplotlib.collections.BrokenBarHCollection method), 992
- get_transformed_clip_path_and_affine() (matplotlib.collections.CircleCollection method), 1004
- get_transformed_clip_path_and_affine() (matplotlib.collections.Collection method),

1016		plotlib.collections.EllipseCollection
get_transformed_clip_path_and_affine()	(matplotlib.collections.EllipseCollection method), 1028	get_transforms() (matplotlib.collections.EventCollection method), 1041
get_transformed_clip_path_and_affine()	(matplotlib.collections.EventCollection method), 1040	get_transforms() (matplotlib.collections.LineCollection method), 1053
get_transformed_clip_path_and_affine()	(matplotlib.collections.LineCollection method), 1053	get_transforms() (matplotlib.collections.PatchCollection method), 1065
get_transformed_clip_path_and_affine()	(matplotlib.collections.PatchCollection method), 1065	get_transforms() (matplotlib.collections.PathCollection method), 1077
get_transformed_clip_path_and_affine()	(matplotlib.collections.PathCollection method), 1077	get_transforms() (matplotlib.collections.PolyCollection method), 1089
get_transformed_clip_path_and_affine()	(matplotlib.collections.PolyCollection method), 1089	get_transforms() (matplotlib.collections.QuadMesh method), 1101
get_transformed_clip_path_and_affine()	(matplotlib.collections.QuadMesh method), 1101	get_transforms() (matplotlib.collections.RegularPolyCollection method), 1113
get_transformed_clip_path_and_affine()	(matplotlib.collections.RegularPolyCollection method), 1113	get_transforms() (matplotlib.collections.StarPolygonCollection method), 1125
get_transformed_clip_path_and_affine()	(matplotlib.collections.StarPolygonCollection method), 1125	get_transforms() (matplotlib.collections.TriMesh method), 1137
get_transformed_clip_path_and_affine()	(matplotlib.collections.TriMesh method), 1137	get_trifinder() (matplotlib.tri.Triangulation method), 1672
get_transformed_path_and_affine()	(matplotlib.transforms.TransformedPath method), 1669	get_underline_thickness() (matplotlib.afm.AFM method), 488
get_transformed_points_and_affine()	(matplotlib.transforms.TransformedPath method), 1669	get_underline_thickness() (matplotlib.mathtext.Fonts method), 1265
get_transforms()	(matplotlib.collections.AsteriskPolygonCollection method), 980	get_underline_thickness() (matplotlib.mathtext.StandardPsFonts method), 1275
get_transforms()	(matplotlib.collections.BrokenBarHCollection method), 992	get_underline_thickness() (matplotlib.mathtext.TruetypeFonts method), 1276
get_transforms()	(matplotlib.collections.CircleCollection method), 1004	get_unicode_index() (in module matplotlib.mathtext), 1277
get_transforms() (matplotlib.collections.Collection method), 1016		get_unit() (matplotlib.text.OffsetFrom method), 1624
get_transforms()	(matplotlib.collections.CircleCollection method), 1004	get_unit_generic() (matplotlib.dates.RRRuleLocator static method), 1171
get_transforms() (matplotlib.collections.Collection method), 1016		get_unitless_position() (matplotlib.text.Text method), 1627
get_transforms()	(matplotlib.collections.CircleCollection method), 1004	get_unitless_position() (matplotlib.text.Text method), 1627

- plotlib.text.TextWithDash method), 1633
- get_units() (matplotlib.axis.Axis method), 803
- get_units() (matplotlib.axis.XAxis method), 828
- get_units() (matplotlib.axis.YAxis method), 819
- get_url() (matplotlib.artist.Artist method), 550
- get_url() (matplotlib.axes.Axes method), 784
- get_url() (matplotlib.axis.Axis method), 882
- get_url() (matplotlib.axis.Tick method), 842
- get_url() (matplotlib.axis.XAxis method), 894
- get_url() (matplotlib.axis.XTick method), 854
- get_url() (matplotlib.axis.YAxis method), 905
- get_url() (matplotlib.axis.YTick method), 865
- get_url() (matplotlib.backend_bases.GraphicsContextBase method), 921
- get_url() (matplotlib.collections.AsteriskPolygonCollection method), 980
- get_url() (matplotlib.collections.BrokenBarHCollection method), 992
- get_url() (matplotlib.collections.CircleCollection method), 1004
- get_url() (matplotlib.collections.Collection method), 1016
- get_url() (matplotlib.collections.EllipseCollection method), 1028
- get_url() (matplotlib.collections.EventCollection method), 1041
- get_url() (matplotlib.collections.LineCollection method), 1053
- get_url() (matplotlib.collections.PatchCollection method), 1065
- get_url() (matplotlib.collections.PathCollection method), 1077
- get_url() (matplotlib.collections.PolyCollection method), 1089
- get_url() (matplotlib.collections.QuadMesh method), 1101
- get_url() (matplotlib.collections.RegularPolyCollection method), 1113
- get_url() (matplotlib.collections.StarPolygonCollection method), 1125
- get_url() (matplotlib.collections.TriMesh method), 1137
- get_used_characters() (matplotlib.mathtext.Fonts method), 1265
- get_useLocale() (matplotlib.ticker.ScalarFormatter method), 1639
- get_useOffset() (matplotlib.ticker.ScalarFormatter method), 1639
- get_usetex() (matplotlib.text.Text method), 1627
- get_va() (matplotlib.text.Text method), 1627
- get_variant() (matplotlib.font_manager.FontProperties method), 1222
- get_variant() (matplotlib.text.Text method), 1627
- get_vector() (mpl_toolkits.mplot3d.art3d.Poly3DCollection method), 1873
- get_vertical() (mpl_toolkits.axes_grid.axes_divider.Divider method), 1797
- get_vertical_sizes() (mpl_toolkits.axes_grid.axes_divider.Divider method), 1797
- get_vertical_stem_width() (matplotlib.afm.AFM method), 488
- get_verticalalignment() (matplotlib.text.Text method), 1627
- get_verts() (matplotlib.patches.Patch method), 1353
- get_view_interval() (matplotlib.axis.Axis method), 801
- get_view_interval() (matplotlib.axis.Tick method),

- 809
- `get_view_interval()` (matplotlib.axis.XAxis method), 829
- `get_view_interval()` (matplotlib.axis.XTick method), 811
- `get_view_interval()` (matplotlib.axis.YAxis method), 819
- `get_view_interval()` (matplotlib.axis.YTick method), 813
- `get_view_interval()` (mpl_toolkits.mplot3d.axes3d.Axes method), 1870
- `get_visible()` (matplotlib.artist.Artist method), 543
- `get_visible()` (matplotlib.axes.Axes method), 784
- `get_visible()` (matplotlib.axis.Axis method), 882
- `get_visible()` (matplotlib.axis.Tick method), 843
- `get_visible()` (matplotlib.axis.XAxis method), 894
- `get_visible()` (matplotlib.axis.XTick method), 854
- `get_visible()` (matplotlib.axis.YAxis method), 905
- `get_visible()` (matplotlib.axis.YTick method), 865
- `get_visible()` (matplotlib.collections.AsteriskPolygonCollection method), 980
- `get_visible()` (matplotlib.collections.BrokenBarHCollection method), 992
- `get_visible()` (matplotlib.collections.CircleCollection method), 1004
- `get_visible()` (matplotlib.collections.Collection method), 1016
- `get_visible()` (matplotlib.collections.EllipseCollection method), 1028
- `get_visible()` (matplotlib.collections.EventCollection method), 1041
- `get_visible()` (matplotlib.collections.LineCollection method), 1053
- `get_visible()` (matplotlib.collections.PatchCollection method), 1065
- `get_visible()` (matplotlib.collections.PathCollection method), 1077
- `get_visible()` (matplotlib.collections.PolyCollection method), 1089
- `get_visible()` (matplotlib.collections.QuadMesh method), 1101
- `get_visible()` (matplotlib.collections.RegularPolyCollection method), 1113
- `get_visible()` (matplotlib.collections.StarPolygonCollection method), 1125
- `get_visible()` (matplotlib.collections.TriMesh method), 1137
- `get_visible_children()` (matplotlib.offsetbox.OffsetBox method), 1319
- `get_vsize_hsize()` (mpl_toolkits.axes_grid.axes_divider.Divider method), 1797
- `get_w_lims()` (mpl_toolkits.mplot3d.axes3d.Axes3D method), 1852
- `get_weight()` (matplotlib.afm.AFM method), 488
- `get_weight()` (matplotlib.font_manager.FontProperties method), 1222
- `get_weight()` (matplotlib.text.Text method), 1627
- `get_width()` (matplotlib.patches.FancyBboxPatch method), 1349
- `get_width()` (matplotlib.patches.Rectangle method), 1359
- `get_width_char()` (matplotlib.afm.AFM method), 488
- `get_width_from_char_name()` (matplotlib.afm.AFM method), 488
- `get_width_height()` (matplotlib.backend_bases.FigureCanvasBase method), 915
- `get_width_ratios()` (matplotlib.gridspec.GridSpecBase method), 1228
- `get_window_extent()` (matplotlib.artist.Artist method), 546
- `get_window_extent()` (matplotlib.axes.Axes method), 777
- `get_window_extent()` (matplotlib.axis.Axis method), 883
- `get_window_extent()` (matplotlib.axis.Tick method), 843
- `get_window_extent()` (matplotlib.axis.XAxis method), 894
- `get_window_extent()` (matplotlib.axis.XTick method), 854
- `get_window_extent()` (matplotlib.axis.YAxis method), 905
- `get_window_extent()` (matplotlib.axis.YTick method), 865
- `get_window_extent()` (matplotlib.collections.StarPolygonCollection method), 1125

plotlib.collections.AsteriskPolygonCollection method), 1240
 method), 980
 get_window_extent() (matplotlib.collections.BrokenBarHCollection method), 992
 get_window_extent() (matplotlib.collections.CircleCollection method), 1004
 get_window_extent() (matplotlib.collections.Collection method), 1016
 get_window_extent() (matplotlib.collections.EllipseCollection method), 1028
 get_window_extent() (matplotlib.collections.EventCollection method), 1041
 get_window_extent() (matplotlib.collections.LineCollection method), 1053
 get_window_extent() (matplotlib.collections.PatchCollection method), 1065
 get_window_extent() (matplotlib.collections.PathCollection method), 1077
 get_window_extent() (matplotlib.collections.PolyCollection method), 1089
 get_window_extent() (matplotlib.collections.QuadMesh method), 1101
 get_window_extent() (matplotlib.collections.RegularPolyCollection method), 1113
 get_window_extent() (matplotlib.collections.StarPolygonCollection method), 1125
 get_window_extent() (matplotlib.collections.TriMesh method), 1137
 get_window_extent() (matplotlib.figure.Figure method), 1197
 get_window_extent() (matplotlib.image.AxesImage method), 1231
 get_window_extent() (matplotlib.image.BboxImage method), 1232
 get_window_extent() (matplotlib.legend.Legend method), 1240
 get_window_extent() (matplotlib.lines.Line2D method), 1248
 get_window_extent() (matplotlib.offsetbox.AnchoredOffsetbox method), 1314
 get_window_extent() (matplotlib.offsetbox.AuxTransformBox method), 1316
 get_window_extent() (matplotlib.offsetbox.DrawingArea method), 1318
 get_window_extent() (matplotlib.offsetbox.OffsetBox method), 1320
 get_window_extent() (matplotlib.offsetbox.OffsetImage method), 1320
 get_window_extent() (matplotlib.offsetbox.TextArea method), 1322
 get_window_extent() (matplotlib.patches.Patch method), 1353
 get_window_extent() (matplotlib.text.Annotation method), 1624
 get_window_extent() (matplotlib.text.Text method), 1627
 get_window_extent() (matplotlib.text.TextWithDash method), 1633
 get_window_title() (matplotlib.backend_bases.FigureCanvasBase method), 915
 get_window_title() (matplotlib.backend_bases.FigureManagerBase method), 919
 get_wrap() (matplotlib.text.Text method), 1628
 get_x() (matplotlib.patches.FancyBboxPatch method), 1349
 get_x() (matplotlib.patches.Rectangle method), 1359
 get_xaxis() (matplotlib.axes.Axes method), 737
 get_xaxis_text1_transform() (matplotlib.axes.Axes method), 787
 get_xaxis_text2_transform() (matplotlib.axes.Axes method), 788
 get_xaxis_transform() (matplotlib.axes.Axes method), 787
 get_xbound() (matplotlib.axes.Axes method), 742
 get_xdata() (matplotlib.legend_handler.HandlerNpoints

- method), 1243
- get_xdata() (matplotlib.lines.Line2D method), 1248
- get_xgridlines() (matplotlib.axes.Axes method), 761
- get_xheight() (matplotlib.afm.AFM method), 488
- get_xheight() (matplotlib.mathtext.Fonts method), 1265
- get_xheight() (matplotlib.mathtext.StandardPsFonts method), 1275
- get_xheight() (matplotlib.mathtext.TruetypeFonts method), 1276
- get_xlabel() (matplotlib.axes.Axes method), 742
- get_xlim() (matplotlib.axes.Axes method), 741
- get_xlim() (mpl_toolkits.mplot3d.axes3d.Axes3D method), 1852
- get_xlim3d() (mpl_toolkits.mplot3d.axes3d.Axes3D method), 1852
- get_xmajorticklabels() (matplotlib.axes.Axes method), 756
- get_xminorticklabels() (matplotlib.axes.Axes method), 757
- get_xscale() (matplotlib.axes.Axes method), 750
- get_xticklabels() (matplotlib.axes.Axes method), 757
- get_xticklines() (matplotlib.axes.Axes method), 757
- get_xticks() (matplotlib.axes.Axes method), 757
- get_xy() (matplotlib.patches.Polygon method), 1358
- get_xy() (matplotlib.patches.Rectangle method), 1359
- get_xydata() (matplotlib.lines.Line2D method), 1248
- get_xyz_where() (in module matplotlib.mlab), 1296
- get_y() (matplotlib.patches.FancyBboxPatch method), 1349
- get_y() (matplotlib.patches.Rectangle method), 1359
- get_yaxis() (matplotlib.axes.Axes method), 737
- get_yaxis_text1_transform() (matplotlib.axes.Axes method), 788
- get_yaxis_text2_transform() (matplotlib.axes.Axes method), 788
- get_yaxis_transform() (matplotlib.axes.Axes method), 787
- get_ybound() (matplotlib.axes.Axes method), 742
- get_ydata() (matplotlib.legend_handler.HandlerNpoints method), 1243
- get_ydata() (matplotlib.legend_handler.HandlerStem method), 1244
- get_ydata() (matplotlib.lines.Line2D method), 1248
- get_ygridlines() (matplotlib.axes.Axes method), 761
- get_ylabel() (matplotlib.axes.Axes method), 742
- get_ylim() (matplotlib.axes.Axes method), 740
- get_ylim() (mpl_toolkits.mplot3d.axes3d.Axes3D method), 1853
- get_ylim3d() (mpl_toolkits.mplot3d.axes3d.Axes3D method), 1853
- get_ymajorticklabels() (matplotlib.axes.Axes method), 757
- get_yminorticklabels() (matplotlib.axes.Axes method), 757
- get_yscale() (matplotlib.axes.Axes method), 750
- get_yticklabels() (matplotlib.axes.Axes method), 758
- get_yticklines() (matplotlib.axes.Axes method), 758
- get_yticks() (matplotlib.axes.Axes method), 758
- get_zbound() (mpl_toolkits.mplot3d.axes3d.Axes3D method), 1853
- get_zlabel() (mpl_toolkits.mplot3d.axes3d.Axes3D method), 1853
- get_zlim() (mpl_toolkits.mplot3d.axes3d.Axes3D method), 1853
- get_zlim3d() (mpl_toolkits.mplot3d.axes3d.Axes3D method), 1853
- get_zmajorticklabels() (mpl_toolkits.mplot3d.axes3d.Axes3D method), 1853
- get_zminorticklabels() (mpl_toolkits.mplot3d.axes3d.Axes3D method), 1853
- get_zoom() (matplotlib.offsetbox.OffsetImage method), 1320
- get_zorder() (matplotlib.artist.Artist method), 544
- get_zorder() (matplotlib.axes.Axes method), 784
- get_zorder() (matplotlib.axis.Axis method), 883
- get_zorder() (matplotlib.axis.Tick method), 843
- get_zorder() (matplotlib.axis.XAxis method), 894
- get_zorder() (matplotlib.axis.XTick method), 854
- get_zorder() (matplotlib.axis.YAxis method), 905
- get_zorder() (matplotlib.axis.YTick method), 866
- get_zorder() (matplotlib.collections.AsteriskPolygonCollection method), 980
- get_zorder() (matplotlib.collections.BrokenBarHCollection method), 992
- get_zorder() (matplotlib.collections.CircleCollection method), 1004
- get_zorder() (matplotlib.collections.Collection method), 1016
- get_zorder() (matplotlib.collections.EllipseCollection

- method), 1028
 - get_zorder() (matplotlib.collections.EventCollection method), 1041
 - get_zorder() (matplotlib.collections.LineCollection method), 1054
 - get_zorder() (matplotlib.collections.PatchCollection method), 1065
 - get_zorder() (matplotlib.collections.PathCollection method), 1077
 - get_zorder() (matplotlib.collections.PolyCollection method), 1089
 - get_zorder() (matplotlib.collections.QuadMesh method), 1101
 - get_zorder() (matplotlib.collections.RegularPolygonCollection method), 1113
 - get_zorder() (matplotlib.collections.StarPolygonCollection method), 1126
 - get_zorder() (matplotlib.collections.TriMesh method), 1137
 - get_zscale() (mpl_toolkits.mplot3d.axes3d.Axes3D method), 1854
 - get_zticklabels() (mpl_toolkits.mplot3d.axes3d.Axes3D method), 1854
 - get_zticklines() (mpl_toolkits.mplot3d.axes3d.Axes3D method), 1854
 - get_zticks() (mpl_toolkits.mplot3d.axes3d.Axes3D method), 1854
 - getp() (in module matplotlib.artist), 552
 - getpoints() (matplotlib.patches.YAArrow method), 1365
 - GetRealpathAndStat (class in matplotlib.cbook), 954
 - ginput() (in module matplotlib.pyplot), 1486
 - ginput() (matplotlib.figure.Figure method), 1197
 - Glue (class in matplotlib.mathtext), 1266
 - GlueSpec (class in matplotlib.mathtext), 1266
 - grab_frame() (matplotlib.animation.MovieWriter method), 523
 - grab_mouse() (matplotlib.backend_bases.FigureCanvasBase method), 915
 - gradient() (matplotlib.tri.CubicTriInterpolator method), 1675
 - gradient() (matplotlib.tri.LinearTriInterpolator method), 1673
 - GraphicsContextBase (class in matplotlib.backend_bases), 920
 - gray() (in module matplotlib.pyplot), 1486
 - Grid (class in mpl_toolkits.axes_grid.axes_grid), 1800
 - grid() (in module matplotlib.pyplot), 1486
 - grid() (matplotlib.axes.Axes method), 734
 - grid() (matplotlib.axis.Axis method), 800
 - grid() (matplotlib.axis.XAxis method), 829
 - grid() (matplotlib.axis.YAxis method), 819
 - grid() (mpl_toolkits.mplot3d.axes3d.Axes3D method), 1854
 - griddata() (in module matplotlib.mlab), 1296
 - GridSpec (class in matplotlib.gridspec), 1227
 - GridSpecBase (class in matplotlib.gridspec), 1228
 - GridSpecFromSubplotSpec (class in matplotlib.gridspec), 1228
 - group() (matplotlib.mathtext.Parser method), 1272
 - Grouper (class in matplotlib.cbook), 954
 - grow() (matplotlib.mathtext.Accent method), 1261
 - grow() (matplotlib.mathtext.Box method), 1262
 - grow() (matplotlib.mathtext.Char method), 1262
 - grow() (matplotlib.mathtext.Glue method), 1266
 - grow() (matplotlib.mathtext.Kern method), 1267
 - grow() (matplotlib.mathtext.List method), 1267
 - grow() (matplotlib.mathtext.Node method), 1271
 - GTK, 3017
- ## H
- HAND (matplotlib.backend_tools.Cursors attribute), 937
 - HandlerBase (class in matplotlib.legend_handler), 1241
 - HandlerCircleCollection (class in matplotlib.legend_handler), 1242
 - HandlerErrorbar (class in matplotlib.legend_handler), 1242
 - HandlerLine2D (class in matplotlib.legend_handler), 1242
 - HandlerLineCollection (class in matplotlib.legend_handler), 1242
 - HandlerNpoints (class in matplotlib.legend_handler), 1243
 - HandlerNpointsYoffsets (class in matplotlib.legend_handler), 1243
 - HandlerPatch (class in matplotlib.legend_handler), 1243
 - HandlerPathCollection (class in matplotlib.legend_handler), 1243
 - HandlerPolyCollection (class in matplotlib.legend_handler), 1243

HandlerRegularPolyCollection (class in matplotlib.legend_handler), 1243
 HandlerStem (class in matplotlib.legend_handler), 1244
 HandlerTuple (class in matplotlib.legend_handler), 1244
 has_data() (matplotlib.axes.Axes method), 790
 has_inverse (matplotlib.scale.InvertedLogTransformBase attribute), 1606
 has_inverse (matplotlib.scale.InvertedSymmetricalLogTransform attribute), 1606
 has_inverse (matplotlib.scale.LogisticTransform attribute), 1610
 has_inverse (matplotlib.scale.LogitTransform attribute), 1611
 has_inverse (matplotlib.scale.LogScale.LogTransformBase attribute), 1609
 has_inverse (matplotlib.scale.LogTransformBase attribute), 1610
 has_inverse (matplotlib.scale.SymmetricalLogScale.InvertedSymmetricalLogTransform attribute), 1612
 has_inverse (matplotlib.scale.SymmetricalLogScale.SymmetricalLogTransform attribute), 1612
 has_inverse (matplotlib.scale.SymmetricalLogTransform attribute), 1613
 has_inverse (matplotlib.transforms.Transform attribute), 1658
 has_nonfinite (matplotlib.path.Path attribute), 1370
 hatch() (matplotlib.path.Path class method), 1370
 have_units() (matplotlib.artist.Artist method), 549
 have_units() (matplotlib.axes.Axes method), 764
 have_units() (matplotlib.axis.Axis method), 883
 have_units() (matplotlib.axis.Tick method), 843
 have_units() (matplotlib.axis.XAxis method), 894
 have_units() (matplotlib.axis.XTick method), 855
 have_units() (matplotlib.axis.YAxis method), 905
 have_units() (matplotlib.axis.YTick method), 866
 have_units() (matplotlib.collections.AsteriskPolygonCollection method), 980
 have_units() (matplotlib.collections.BrokenBarHCollection method), 992
 have_units() (matplotlib.collections.CircleCollection method), 1004
 have_units() (matplotlib.collections.Collection method), 1016
 have_units() (matplotlib.collections.EllipseCollection method), 1028
 have_units() (matplotlib.collections.EventCollection method), 1041
 have_units() (matplotlib.collections.LineCollection method), 1054
 have_units() (matplotlib.collections.PatchCollection method), 1065
 have_units() (matplotlib.collections.PathCollection method), 1077
 have_units() (matplotlib.collections.PolyCollection method), 1089
 have_units() (matplotlib.collections.QuadMesh method), 1101
 have_units() (matplotlib.collections.RegularPolyCollection method), 1113
 have_units() (matplotlib.collections.RegularStarPolygonCollection method), 1126
 have_units() (matplotlib.collections.TriMesh method), 1137
 have_units() (mpl_toolkits.mplot3d.axes3d.Axes3D method), 1854
 Hbox (class in matplotlib.mathtext), 1266
 HCentered (class in matplotlib.mathtext), 1266
 height (matplotlib.dviread.Tfm attribute), 1183
 height (matplotlib.mathtext.Kern attribute), 1267
 height (matplotlib.transforms.BboxBase attribute), 1652
 hexbin() (in module matplotlib.pyplot), 1488
 hexbin() (matplotlib.axes.Axes method), 648
 hillshade() (matplotlib.colors.LightSource method), 1155
 hist() (in module matplotlib.pyplot), 1491
 hist() (matplotlib.axes.Axes method), 652
 hist2d() (in module matplotlib.pyplot), 1495
 hist2d() (matplotlib.axes.Axes method), 656
 hitlist() (matplotlib.artist.Artist method), 538
 hitlist() (matplotlib.axes.Axes method), 773
 hitlist() (matplotlib.axis.Axis method), 883
 hitlist() (matplotlib.axis.Tick method), 843
 hitlist() (matplotlib.axis.XAxis method), 894
 hitlist() (matplotlib.axis.XTick method), 855
 hitlist() (matplotlib.axis.YAxis method), 905
 hitlist() (matplotlib.axis.YTick method), 866
 hitlist() (matplotlib.collections.AsteriskPolygonCollection

- method), 980
 - hitlist() (matplotlib.collections.BrokenBarHCollection method), 992
 - hitlist() (matplotlib.collections.CircleCollection method), 1004
 - hitlist() (matplotlib.collections.Collection method), 1016
 - hitlist() (matplotlib.collections.EllipseCollection method), 1028
 - hitlist() (matplotlib.collections.EventCollection method), 1041
 - hitlist() (matplotlib.collections.LineCollection method), 1054
 - hitlist() (matplotlib.collections.PatchCollection method), 1065
 - hitlist() (matplotlib.collections.PathCollection method), 1077
 - hitlist() (matplotlib.collections.PolyCollection method), 1089
 - hitlist() (matplotlib.collections.QuadMesh method), 1101
 - hitlist() (matplotlib.collections.RegularPolyCollection method), 1113
 - hitlist() (matplotlib.collections.StarPolygonCollection method), 1126
 - hitlist() (matplotlib.collections.TriMesh method), 1137
 - hlines() (in module matplotlib.pyplot), 1497
 - hlines() (matplotlib.axes.Axes method), 598
 - Hlist (class in matplotlib.mathtext), 1266
 - hlist_out() (matplotlib.mathtext.Ship method), 1275
 - hms0d (matplotlib.dates.DateLocator attribute), 1171
 - hold() (in module matplotlib.pyplot), 1498
 - hold() (matplotlib.axes.Axes method), 790
 - hold() (matplotlib.figure.Figure method), 1198
 - HOME, 1742, 1745
 - home() (matplotlib.backend_bases.NavigationToolbar2ImageMagickBase method), 926
 - home() (matplotlib.backend_tools.ToolViewsPositions method), 943
 - home() (matplotlib.cbook.Stack method), 957
 - hot() (in module matplotlib.pyplot), 1499
 - HourLocator (class in matplotlib.dates), 1174
 - hours() (in module matplotlib.dates), 1179
 - hpack() (matplotlib.mathtext.Hlist method), 1266
 - HPacker (class in matplotlib.offsetbox), 1318
 - Hrule (class in matplotlib.mathtext), 1267
 - hsv() (in module matplotlib.pyplot), 1499
 - hsv_to_rgb() (in module matplotlib.colors), 1162
- I**
- identity() (in module matplotlib.mlab), 1297
 - identity() (matplotlib.transforms.Affine2D static method), 1663
 - IdentityTransform (class in matplotlib.transforms), 1664
 - idle_event() (matplotlib.backend_bases.FigureCanvasBase method), 915
 - IdleEvent (class in matplotlib.backend_bases), 923
 - ignore() (matplotlib.transforms.Bbox method), 1655
 - ignore() (matplotlib.widgets.SpanSelector method), 1699
 - ignore() (matplotlib.widgets.Widget method), 1701
 - IgnoredKeywordWarning, 955
 - illegal_s (matplotlib.dates.DateFormatter attribute), 1170
 - image (matplotlib.backend_tools.ConfigureSubplotsBase attribute), 937
 - image (matplotlib.backend_tools.SaveFigureBase attribute), 938
 - image (matplotlib.backend_tools.ToolBack attribute), 938
 - image (matplotlib.backend_tools.ToolBase attribute), 939
 - image (matplotlib.backend_tools.ToolForward attribute), 940
 - image (matplotlib.backend_tools.ToolHome attribute), 941
 - image (matplotlib.backend_tools.ToolPan attribute), 942
 - image (matplotlib.backend_tools.ToolZoom attribute), 944
 - ImageGrid (class in mpl_toolkits.axes_grid.axes_grid), 1801
 - ImageMagickBase (class in matplotlib.animation), 530
 - ImageMagickFileWriter (class in matplotlib.animation), 516
 - ImageMagickWriter (class in matplotlib.animation), 520
 - imageObject() (matplotlib.backends.backend_pdf.PdfFile method), 949
 - imread() (in module matplotlib.image), 1234
 - imread() (in module matplotlib.pyplot), 1499

- imsave() (in module matplotlib.image), 1234
- imsave() (in module matplotlib.pyplot), 1499
- imshow() (in module matplotlib.pyplot), 1500
- imshow() (matplotlib.axes.Axes method), 689
- in_axes() (matplotlib.axes.Axes method), 773
- inaxes (matplotlib.backend_bases.LocationEvent attribute), 923
- inaxes (matplotlib.backend_bases.MouseEvent attribute), 924
- index_bar() (in module matplotlib.finance), 1210
- index_of() (in module matplotlib.cbook), 962
- IndexDateFormatter (class in matplotlib.dates), 1170
- IndexLocator (class in matplotlib.ticker), 1642
- inferno() (in module matplotlib.pyplot), 1502
- infodict() (matplotlib.backends.backend_pdf.PdfPages method), 950
- init3d() (mpl_toolkits.mplot3d.axis3d.Axis method), 1870
- input_dims (matplotlib.scale.InvertedLogTransformBase attribute), 1606
- input_dims (matplotlib.scale.InvertedSymmetricalLogTransform method), 1152
attribute), 1606
- input_dims (matplotlib.scale.LogisticTransform attribute), 1610
- input_dims (matplotlib.scale.LogitTransform attribute), 1611
- input_dims (matplotlib.scale.LogScale.LogTransformBase attribute), 1609
- input_dims (matplotlib.scale.LogTransformBase attribute), 1610
- input_dims (matplotlib.scale.SymmetricalLogScale.InvertedSymmetricalLogTransform attribute), 1612
- input_dims (matplotlib.scale.SymmetricalLogScale.SymmetricalLogTransform attribute), 1613
- input_dims (matplotlib.scale.SymmetricalLogTransform attribute), 1613
- input_dims (matplotlib.transforms.Transform attribute), 1658
- inset_axes() (in module mpl_toolkits.axes_grid1.inset_locator), 1817
- InsetPosition (class in mpl_toolkits.axes_grid1.inset_locator), 1816
- inside_poly() (in module matplotlib.mlab), 1297
- install_repl_displayhook() (in module matplotlib.pyplot), 1502
- interpolated() (matplotlib.path.Path method), 1370
- intersection() (matplotlib.transforms.BboxBase static method), 1652
- intersects_bbox() (matplotlib.path.Path method), 1370
- intersects_path() (matplotlib.path.Path method), 1371
- interval (matplotlib.backend_bases.TimerBase attribute), 932
- intervalx (matplotlib.transforms.BboxBase attribute), 1653
- intervaly (matplotlib.transforms.BboxBase attribute), 1653
- inv_transform() (in module mpl_toolkits.mplot3d.proj3d), 1876
- invalidate() (matplotlib.transforms.TransformNode method), 1651
- invalidating_rcparams (matplotlib.font_manager.TempCache attribute), 1223
- inverse() (matplotlib.colors.BoundaryNorm method), 1160
- inverse() (matplotlib.colors.LogNorm method), 1160
- inverse() (matplotlib.colors.NoNorm method), 1160
- inverse() (matplotlib.colors.Normalize method), 1160
- inverse() (matplotlib.colors.PowerNorm method), 1161
- inverse() (matplotlib.colors.SymLogNorm method), 1161
- inverse_transformed() (matplotlib.transforms.TransformNode method), 1653
- invert_xaxis() (matplotlib.axes.Axes method), 738
- invert_yaxis() (matplotlib.axes.Axes method), 738
- invert_zaxis() (mpl_toolkits.mplot3d.axes3d.Axes3D method), 1854
- inverted() (matplotlib.projections.polar.InvertedPolarTransform method), 1380
- inverted() (matplotlib.projections.polar.PolarAxes.InvertedPolarTransform method), 1380
- inverted() (matplotlib.projections.polar.PolarAxes.PolarTransform method), 1381
- inverted() (matplotlib.projections.polar.PolarTransform method), 1386
- inverted() (matplotlib.scale.InvertedLog10Transform

method), 1605

inverted() (matplotlib.scale.InvertedLog2Transform method), 1605

inverted() (matplotlib.scale.InvertedLogTransform method), 1605

inverted() (matplotlib.scale.InvertedNaturalLogTransform method), 1606

inverted() (matplotlib.scale.InvertedSymmetricalLogTransform method), 1606

inverted() (matplotlib.scale.Log10Transform method), 1607

inverted() (matplotlib.scale.Log2Transform method), 1607

inverted() (matplotlib.scale.LogisticTransform method), 1610

inverted() (matplotlib.scale.LogitTransform method), 1611

inverted() (matplotlib.scale.LogScale.InvertedLog10Transform method), 1608

inverted() (matplotlib.scale.LogScale.InvertedLog2Transform method), 1608

inverted() (matplotlib.scale.LogScale.InvertedLogTransform method), 1608

inverted() (matplotlib.scale.LogScale.InvertedNaturalLogTransform method), 1608

inverted() (matplotlib.scale.LogScale.Log10Transform method), 1608

inverted() (matplotlib.scale.LogScale.Log2Transform method), 1609

inverted() (matplotlib.scale.LogScale.LogTransform method), 1609

inverted() (matplotlib.scale.LogScale.NaturalLogTransform method), 1609

inverted() (matplotlib.scale.LogTransform method), 1609

inverted() (matplotlib.scale.NaturalLogTransform method), 1611

inverted() (matplotlib.scale.SymmetricalLogScale.InvertedSymmetricalLogTransform method), 1612

inverted() (matplotlib.scale.SymmetricalLogScale.SymmetricalLogTransform method), 1613

inverted() (matplotlib.scale.SymmetricalLogTransform method), 1613

inverted() (matplotlib.transforms.Affine2DBase method), 1662

inverted() (matplotlib.transforms.BlendedGenericTransform method), 1666

inverted() (matplotlib.transforms.CompositeGenericTransform method), 1016

method), 1667

inverted() (matplotlib.transforms.IdentityTransform method), 1664

inverted() (matplotlib.transforms.Transform method), 1658

InvertedLog10Transform (class in matplotlib.scale), 1605

InvertedLog2Transform (class in matplotlib.scale), 1605

InvertedLogTransform (class in matplotlib.scale), 1605

InvertedLogTransformBase (class in matplotlib.scale), 1605

InvertedNaturalLogTransform (class in matplotlib.scale), 1606

InvertedPolarTransform (class in matplotlib.projections.polar), 1380

InvertedSymmetricalLogTransform (class in matplotlib.scale), 1606

ion() (in module matplotlib.pyplot), 1502

ion() (in module matplotlib.pyplot), 1503

is_between_brackets() (matplotlib.mathtext.Parser method), 1272

is_closed() (in module matplotlib.mlab), 1297

is_color_like() (in module matplotlib.colors), 1162

is_dashed() (matplotlib.lines.Line2D method), 1249

is_dropsup() (matplotlib.mathtext.Parser method), 1272

is_figure_set() (matplotlib.artist.Artist method), 547

is_figure_set() (matplotlib.axes.Axes method), 785

is_figure_set() (matplotlib.axis.Axis method), 883

is_figure_set() (matplotlib.axis.Tick method), 843

is_figure_set() (matplotlib.axis.XAxis method), 894

is_figure_set() (matplotlib.axis.XTick method), 855

is_figure_set() (matplotlib.axis.YAxis method), 906

is_figure_set() (matplotlib.axis.YTick method), 866

is_inverted() (matplotlib.collections.AsteriskPolygonCollection method), 980

is_figure_set() (matplotlib.collections.BrokenBarHCollection method), 992

is_figure_set() (matplotlib.collections.CircleCollection method), 1004

is_figure_set() (matplotlib.collections.Collection method), 1016

- `is_figure_set()` (matplotlib.collections.EllipseCollection method), 1028
`is_figure_set()` (matplotlib.collections.EventCollection method), 1041
`is_figure_set()` (matplotlib.collections.LineCollection method), 1054
`is_figure_set()` (matplotlib.collections.PatchCollection method), 1065
`is_figure_set()` (matplotlib.collections.PathCollection method), 1077
`is_figure_set()` (matplotlib.collections.PolyCollection method), 1089
`is_figure_set()` (matplotlib.collections.QuadMesh method), 1101
`is_figure_set()` (matplotlib.collections.RegularPolyCollection method), 1113
`is_figure_set()` (matplotlib.collections.StarPolygonCollection method), 1126
`is_figure_set()` (matplotlib.collections.TriMesh method), 1137
`is_filled()` (matplotlib.markers.MarkerStyle method), 1257
`is_frame_like()` (matplotlib.spines.Spine method), 1616
`is_gray()` (matplotlib.colors.Colormap method), 1153
`is_hashable()` (in module matplotlib.cbook), 962
`is_horizontal()` (matplotlib.collections.EventCollection method), 1041
`is_math_text()` (in module matplotlib.cbook), 962
`is_math_text()` (matplotlib.text.Text static method), 1628
`is_missing()` (matplotlib.cbook.converter method), 959
`is_numlike()` (in module matplotlib.cbook), 962
`is_numlike()` (matplotlib.units.ConversionInterface static method), 1686
`is_opentype_cff_font()` (in module matplotlib.font_manager), 1224
`is_overunder()` (matplotlib.mathtext.Parser method), 1272
`is_saving()` (matplotlib.backend_bases.FigureCanvasBase method), 915
`is_scalar()` (in module matplotlib.cbook), 962
`is_scalar_or_string()` (in module matplotlib.cbook), 962
`is_separable` (matplotlib.scale.InvertedLogTransformBase attribute), 1606
`is_separable` (matplotlib.scale.InvertedSymmetricalLogTransform attribute), 1606
`is_separable` (matplotlib.scale.LogisticTransform attribute), 1610
`is_separable` (matplotlib.scale.LogitTransform attribute), 1611
`is_separable` (matplotlib.scale.LogScale.LogTransformBase attribute), 1609
`is_separable` (matplotlib.scale.LogTransformBase attribute), 1610
`is_separable` (matplotlib.scale.SymmetricalLogScale.InvertedSymmetricalLogScale attribute), 1612
`is_separable` (matplotlib.scale.SymmetricalLogScale.SymmetricalLogScale attribute), 1613
`is_separable` (matplotlib.scale.SymmetricalLogTransform attribute), 1613
`is_separable` (matplotlib.transforms.Transform attribute), 1658
`is_sequence_of_strings()` (in module matplotlib.cbook), 962
`is_slanted()` (matplotlib.mathtext.Char method), 1262
`is_slanted()` (matplotlib.mathtext.Parser method), 1272
`is_string_like()` (in module matplotlib.cbook), 962
`is_transform_set()` (matplotlib.artist.Artist method), 549
`is_transform_set()` (matplotlib.axes.Axes method), 786
`is_transform_set()` (matplotlib.axis.Axis method), 883
`is_transform_set()` (matplotlib.axis.Tick method), 843
`is_transform_set()` (matplotlib.axis.XAxis method), 895
`is_transform_set()` (matplotlib.axis.XTick method), 855
`is_transform_set()` (matplotlib.axis.YAxis method), 906

- is_transform_set() (matplotlib.axis.YTick method), 866
 - is_transform_set() (matplotlib.collections.AsteriskPolygonCollection method), 980
 - is_transform_set() (matplotlib.collections.BrokenBarHCollection method), 992
 - is_transform_set() (matplotlib.collections.CircleCollection method), 1004
 - is_transform_set() (matplotlib.collections.Collection method), 1016
 - is_transform_set() (matplotlib.collections.EllipseCollection method), 1028
 - is_transform_set() (matplotlib.collections.EventCollection method), 1041
 - is_transform_set() (matplotlib.collections.LineCollection method), 1054
 - is_transform_set() (matplotlib.collections.PatchCollection method), 1065
 - is_transform_set() (matplotlib.collections.PathCollection method), 1077
 - is_transform_set() (matplotlib.collections.PolyCollection method), 1089
 - is_transform_set() (matplotlib.collections.QuadMesh method), 1101
 - is_transform_set() (matplotlib.collections.RegularPolyCollection method), 1113
 - is_transform_set() (matplotlib.collections.StarPolygonCollection method), 1126
 - is_transform_set() (matplotlib.collections.TriMesh method), 1137
 - is_unit() (matplotlib.transforms.BboxBase method), 1653
 - is_writable_file_like() (in module matplotlib.cbook), 962
 - iscolor() (in module mpl_toolkits.mplot3d.art3d), 1875
 - ishold() (in module matplotlib.pyplot), 1503
 - ishold() (matplotlib.axes.Axes method), 790
 - isinteractive() (in module matplotlib.pyplot), 1503
 - isowner() (matplotlib.widgets.LockDraw method), 1693
 - ispower2() (in module matplotlib.mlab), 1298
 - issubclass_safe() (in module matplotlib.cbook), 962
 - isvector() (in module matplotlib.mlab), 1298
 - iter_segments() (matplotlib.path.Path method), 1371
 - iter_ticks() (matplotlib.axis.Axis method), 800
 - iter_ticks() (matplotlib.axis.XAxis method), 829
 - iter_ticks() (matplotlib.axis.YAxis method), 819
 - iterable() (in module matplotlib.cbook), 962
- ## J
- jet() (in module matplotlib.pyplot), 1503
 - join() (matplotlib.cbook.Grouper method), 955
 - joined() (matplotlib.cbook.Grouper method), 955
 - JPG, 3017
 - juggle_axes() (in module mpl_toolkits.mplot3d.art3d), 1875
- ## K
- Kern (class in matplotlib.mathtext), 1267
 - kern() (matplotlib.mathtext.Hlist method), 1267
 - key_press() (matplotlib.backend_bases.FigureManagerBase method), 919
 - key_press_event() (matplotlib.backend_bases.FigureCanvasBase method), 915
 - key_press_handler() (in module matplotlib.backend_bases), 933
 - key_release_event() (matplotlib.backend_bases.FigureCanvasBase method), 915
 - KeyEvent (class in matplotlib.backend_bases), 923
 - kwdoc() (in module matplotlib.artist), 553
- ## L
- l1norm() (in module matplotlib.mlab), 1298
 - l2norm() (in module matplotlib.mlab), 1298
 - label_minor() (matplotlib.ticker.LogFormatter method), 1641
 - LABELPAD (mpl_toolkits.axes_grid.axis_artist.AxisArtist attribute), 1802
 - Lasso (class in matplotlib.widgets), 1692
 - LassoSelector (class in matplotlib.widgets), 1692

- lastevent (matplotlib.backend_bases.LocationEvent attribute), 924
- leave_notify_event() (matplotlib.backend_bases.FigureCanvasBase method), 915
- Legend (class in matplotlib.legend), 1237
- legend entry, 68
- legend handle, 68
- legend key, 68
- legend label, 68
- legend() (in module matplotlib.pyplot), 1503
- legend() (matplotlib.axes.Axes method), 744
- legend() (matplotlib.figure.Figure method), 1198
- legend_artist() (matplotlib.legend_handler.HandlerBase method), 1242
- less_simple_linear_interpolation() (in module matplotlib.mlab), 1298
- LightSource (class in matplotlib.colors), 1153
- limit_range_for_scale() (matplotlib.axis.Axis method), 806
- limit_range_for_scale() (matplotlib.axis.XAxis method), 829
- limit_range_for_scale() (matplotlib.axis.YAxis method), 820
- limit_range_for_scale() (matplotlib.scale.LogitScale method), 1610
- limit_range_for_scale() (matplotlib.scale.LogScale method), 1609
- limit_range_for_scale() (matplotlib.scale.ScaleBase method), 1611
- Line2D (class in matplotlib.lines), 1245
- line2d() (in module mpl_toolkits.mplot3d.proj3d), 1876
- line2d_dist() (in module mpl_toolkits.mplot3d.proj3d), 1876
- line2d_seg_dist() (in module mpl_toolkits.mplot3d.proj3d), 1876
- Line3D (class in mpl_toolkits.mplot3d.art3d), 1871
- Line3DCollection (class in mpl_toolkits.mplot3d.art3d), 1871
- line_2d_to_3d() (in module mpl_toolkits.mplot3d.art3d), 1875
- line_collection_2d_to_3d() (in module mpl_toolkits.mplot3d.art3d), 1875
- linear_spine() (matplotlib.spines.Spine class method), 1617
- LinearLocator (class in matplotlib.ticker), 1643
- LinearScale (class in matplotlib.scale), 1606
- LinearSegmentedColormap (class in matplotlib.colors), 1158
- LinearTriInterpolator (class in matplotlib.tri), 1673
- LineCollection (class in matplotlib.collections), 1048
- lineStyles (matplotlib.lines.Line2D attribute), 1249
- LINETO (matplotlib.path.Path attribute), 1368
- List (class in matplotlib.mathtext), 1267
- list_fonts() (in module matplotlib.font_manager), 1224
- ListedColormap (class in matplotlib.colors), 1159
- listFiles() (in module matplotlib.cbook), 962
- local_over_kwdict() (in module matplotlib.cbook), 962
- locally_modified_subplot_params() (matplotlib.gridspec.GridSpec method), 1227
- locate() (mpl_toolkits.axes_grid.axes_divider.Divider method), 1797
- LocationEvent (class in matplotlib.backend_bases), 923
- Locator (class in matplotlib.ticker), 1642
- locator_params() (in module matplotlib.pyplot), 1507
- locator_params() (matplotlib.axes.Axes method), 763
- locator_params() (mpl_toolkits.mplot3d.axes3d.Axes3D method), 1854
- LockDraw (class in matplotlib.widgets), 1693
- Locked (class in matplotlib.cbook), 955
- locked() (matplotlib.widgets.LockDraw method), 1693
- Locked.TimeoutError, 955
- LOCKFN (matplotlib.cbook.Locked attribute), 955
- locs (matplotlib.ticker.Formatter attribute), 1638
- Log10Transform (class in matplotlib.scale), 1607
- log2() (in module matplotlib.mlab), 1298
- Log2Transform (class in matplotlib.scale), 1607
- LogFormatter (class in matplotlib.ticker), 1640
- LogFormatterExponent (class in matplotlib.ticker), 1641
- LogFormatterMathtext (class in matplotlib.ticker), 1641
- LogisticTransform (class in matplotlib.scale), 1610
- LogitScale (class in matplotlib.scale), 1610
- LogitTransform (class in matplotlib.scale), 1611
- LogLocator (class in matplotlib.ticker), 1644
- loglog() (in module matplotlib.pyplot), 1507

- loglog() (matplotlib.axes.Axes method), 569
 - LogNorm (class in matplotlib.colors), 1159
 - LogScale (class in matplotlib.scale), 1607
 - LogScale.InvertedLog10Transform (class in matplotlib.scale), 1607
 - LogScale.InvertedLog2Transform (class in matplotlib.scale), 1608
 - LogScale.InvertedLogTransform (class in matplotlib.scale), 1608
 - LogScale.InvertedNaturalLogTransform (class in matplotlib.scale), 1608
 - LogScale.Log10Transform (class in matplotlib.scale), 1608
 - LogScale.Log2Transform (class in matplotlib.scale), 1608
 - LogScale.LogTransform (class in matplotlib.scale), 1609
 - LogScale.LogTransformBase (class in matplotlib.scale), 1609
 - LogScale.NaturalLogTransform (class in matplotlib.scale), 1609
 - logspace() (in module matplotlib.mlab), 1298
 - LogTransform (class in matplotlib.scale), 1609
 - LogTransformBase (class in matplotlib.scale), 1609
 - longest_contiguous_ones() (in module matplotlib.mlab), 1298
 - longest_ones() (in module matplotlib.mlab), 1298
- M**
- magma() (in module matplotlib.pyplot), 1509
 - magnitude_spectrum() (in module matplotlib.mlab), 1298
 - magnitude_spectrum() (in module matplotlib.pyplot), 1509
 - magnitude_spectrum() (matplotlib.axes.Axes method), 621
 - main() (matplotlib.mathtext.Parser method), 1272
 - mainloop() (matplotlib.backend_bases.ShowBase method), 931
 - make_axes() (in module matplotlib.colorbar), 1147
 - make_axes_gridspec() (in module matplotlib.colorbar), 1148
 - make_compound_path() (matplotlib.path.Path class method), 1371
 - make_compound_path_from_polys() (matplotlib.path.Path class method), 1372
 - make_image() (matplotlib.image.AxesImage method), 1231
 - make_image() (matplotlib.image.BboxImage method), 1232
 - make_image() (matplotlib.image.FigureImage method), 1232
 - make_image() (matplotlib.image.NonUniformImage method), 1232
 - make_image() (matplotlib.image.PcolorImage method), 1233
 - make_rcparams_key() (matplotlib.font_manager.TempCache method), 1223
 - makeMappingArray() (in module matplotlib.colors), 1162
 - margins() (in module matplotlib.pyplot), 1513
 - margins() (matplotlib.axes.Axes method), 751
 - margins() (mpl_toolkits.mplot3d.axes3d.Axes3D method), 1855
 - mark_inset() (in module mpl_toolkits.axes_grid1.inset_locator), 1819
 - markerObject() (matplotlib.backends.backend_pdf.PdfFile method), 949
 - markers (matplotlib.lines.Line2D attribute), 1249
 - markers (matplotlib.markers.MarkerStyle attribute), 1257
 - MarkerStyle (class in matplotlib.markers), 1256
 - math() (matplotlib.mathtext.Parser method), 1272
 - math_string() (matplotlib.mathtext.Parser method), 1273
 - math_to_image() (in module matplotlib.mathtext), 1277
 - MathtextBackend (class in matplotlib.mathtext), 1268
 - MathtextBackendAgg (class in matplotlib.mathtext), 1269
 - MathtextBackendBitmap (class in matplotlib.mathtext), 1269
 - MathtextBackendCairo (class in matplotlib.mathtext), 1270
 - MathtextBackendPath (class in matplotlib.mathtext), 1270
 - MathtextBackendPdf (class in matplotlib.mathtext), 1270
 - MathtextBackendPs (class in matplotlib.mathtext), 1270
 - MathtextBackendSvg (class in matplotlib.mathtext), 1270

- MathTextParser (class in matplotlib.mathtext), 1267
 MathTextWarning, 1268
 matplotlib.afm (module), 487
 matplotlib.animation (module), 491
 matplotlib.artist (module), 536
 matplotlib.axis (module), 794
 matplotlib.backend_bases (module), 913
 matplotlib.backend_managers (module), 934
 matplotlib.backend_tools (module), 937
 matplotlib.backends.backend_pdf (module), 948
 matplotlib.backends.backend_qt4agg (module), 946
 matplotlib.backends.backend_qt5agg (module), 946
 matplotlib.backends.backend_svg (module), 951
 matplotlib.backends.backend_wxagg (module), 947
 matplotlib.cbook (module), 953
 matplotlib.cm (module), 971
 matplotlib.collections (module), 975
 matplotlib.colorbar (module), 1145
 matplotlib.colors (module), 1151
 matplotlib.container (module), 1165
 matplotlib.dates (module), 1167
 matplotlib.dviread (module), 1181
 matplotlib.figure (module), 1185
 matplotlib.finance (module), 1207
 matplotlib.font_manager (module), 1219
 matplotlib.fontconfig_pattern (module), 1225
 matplotlib.gridspec (module), 1227
 matplotlib.image (module), 1231
 matplotlib.legend (module), 1237
 matplotlib.legend_handler (module), 1241
 matplotlib.lines (module), 1245
 matplotlib.markers (module), 1255
 matplotlib.mathtext (module), 1261
 matplotlib.mlab (module), 1279
 matplotlib.offsetbox (module), 1313
 matplotlib.patches (module), 1325
 matplotlib.path (module), 1367
 matplotlib.patheffects (module), 92, 1375
 matplotlib.projections (module), 1379
 matplotlib.projections.polar (module), 1380
 matplotlib.pyplot (module), 1387
 matplotlib.rcsetup (module), 1593
 matplotlib.sankey (module), 1597
 matplotlib.scale (module), 1605
 matplotlib.sphinxext.plot_directive (module), 1922
 matplotlib.spines (module), 1615
 matplotlib.style (module), 1619
 matplotlib.style.available (in module matplotlib.style), 1619
 matplotlib.style.library (in module matplotlib.style), 1619
 matplotlib.text (module), 1621
 matplotlib.ticker (module), 1635
 matplotlib.tight_layout (module), 1647
 matplotlib.transforms (module), 1649
 matplotlib.tri (module), 1671
 matplotlib.type1font (module), 1683
 matplotlib.units (module), 1685
 matplotlib.widgets (module), 1687
 matplotlib_fname() (in module matplotlib), 484
 MatplotlibDeprecationWarning, 955
 matrix_from_values() (matplotlib.transforms.Affine2DBase static method), 1662
 matshow() (in module matplotlib.pyplot), 1514
 matshow() (matplotlib.axes.Axes method), 692
 max (matplotlib.transforms.BboxBase attribute), 1653
 maxdict (class in matplotlib.cbook), 963
 MaxHeight (class in mpl_toolkits.axes_grid.axes_size), 1795
 MaxNLocator (class in matplotlib.ticker), 1644
 MAXTICKS (matplotlib.ticker.Locator attribute), 1642
 MaxWidth (class in mpl_toolkits.axes_grid.axes_size), 1795
 md5() (in module matplotlib.finance), 1211
 MemoryMonitor (class in matplotlib.cbook), 955
 MencoderBase (class in matplotlib.animation), 532
 MencoderFileWriter (class in matplotlib.animation), 532
 MencoderWriter (class in matplotlib.animation), 533
 message_event() (matplotlib.backend_managers.ToolManager method), 935
 MicrosecondLocator (class in matplotlib.dates), 1174
 min (matplotlib.transforms.BboxBase attribute), 1653
 minorticks_off() (in module matplotlib.pyplot), 1514
 minorticks_off() (matplotlib.axes.Axes method), 758
 minorticks_on() (in module matplotlib.pyplot), 1514
 minorticks_on() (matplotlib.axes.Axes method), 758
 MinuteLocator (class in matplotlib.dates), 1174
 minutes() (in module matplotlib.dates), 1178

- mkdircs() (in module matplotlib.cbook), 963
 - mod() (in module mpl_toolkits.mplot3d.proj3d), 1876
 - MonthLocator (class in matplotlib.dates), 1173
 - motion_notify_event() (matplotlib.backend_bases.FigureCanvasBase method), 916
 - mouse_init() (mpl_toolkits.mplot3d.axes3d.Axes3D method), 1855
 - mouse_move() (matplotlib.backend_bases.NavigationToolbar2 method), 926
 - MouseEvent (class in matplotlib.backend_bases), 924
 - mouseover (matplotlib.artist.Artist attribute), 538
 - mouseover (matplotlib.axes.Axes attribute), 773
 - mouseover (matplotlib.axis.Axis attribute), 883
 - mouseover (matplotlib.axis.Tick attribute), 844
 - mouseover (matplotlib.axis.XAxis attribute), 895
 - mouseover (matplotlib.axis.XTick attribute), 855
 - mouseover (matplotlib.axis.YAxis attribute), 906
 - mouseover (matplotlib.axis.YTick attribute), 866
 - mouseover (matplotlib.collections.AsteriskPolygonCollection attribute), 980
 - mouseover (matplotlib.collections.BrokenBarHCollection attribute), 992
 - mouseover (matplotlib.collections.CircleCollection attribute), 1004
 - mouseover (matplotlib.collections.Collection attribute), 1017
 - mouseover (matplotlib.collections.EllipseCollection attribute), 1028
 - mouseover (matplotlib.collections.EventCollection attribute), 1041
 - mouseover (matplotlib.collections.LineCollection attribute), 1054
 - mouseover (matplotlib.collections.PatchCollection attribute), 1065
 - mouseover (matplotlib.collections.PathCollection attribute), 1077
 - mouseover (matplotlib.collections.PolyCollection attribute), 1089
 - mouseover (matplotlib.collections.QuadMesh attribute), 1101
 - mouseover (matplotlib.collections.RegularPolyCollection attribute), 1113
 - mouseover (matplotlib.collections.StarPolygonCollection attribute), 1126
 - mouseover (matplotlib.collections.TriMesh attribute), 1137
 - movavg() (in module matplotlib.mlab), 1299
 - MOVE (matplotlib.backend_tools.Cursors attribute), 937
 - move_from_center() (in module mpl_toolkits.mplot3d.axis3d), 1871
 - MOVETO (matplotlib.path.Path attribute), 1368
 - MovieWriter (class in matplotlib.animation), 527
 - MovieWriterRegistry (class in matplotlib.animation), 526
 - mpl_connect() (matplotlib.backend_bases.FigureCanvasBase method), 916
 - mpl_disconnect() (matplotlib.backend_bases.FigureCanvasBase method), 917
 - mpl_toolkits.axes_grid.axes_size (module), 1795
 - mpl_toolkits.axes_grid1.anchored_artists (module), 1805
 - mpl_toolkits.axes_grid1.inset_locator (module), 1811
 - mpl_toolkits.mplot3d.art3d (module), 1871
 - mpl_toolkits.mplot3d.axes3d (module), 1848
 - mpl_toolkits.mplot3d.axis3d (module), 1870
 - mpl_toolkits.mplot3d.proj3d (module), 1876
 - MPLBACKEND, 325, 1719, 1720, 1909
 - MPLCONFIGDIR, 1742, 1745
 - mplDeprecation (in module matplotlib.cbook), 963
 - MultiCursor (class in matplotlib.widgets), 1693
 - MultipleLocator (class in matplotlib.ticker), 1644
 - mutated() (matplotlib.transforms.Bbox method), 1655
 - mutatedx() (matplotlib.transforms.Bbox method), 1655
 - mutatedy() (matplotlib.transforms.Bbox method), 1655
 - mx2num() (in module matplotlib.dates), 1169
- ## N
- n_rasterize (matplotlib.colorbar.ColorbarBase attribute), 1146
 - Name (class in matplotlib.backends.backend_pdf), 949
 - name (matplotlib.axes.Axes attribute), 786
 - name (matplotlib.backend_tools.ToolBase attribute), 939
 - name (matplotlib.scale.LinearScale attribute), 1607

- name (matplotlib.scale.LogitScale attribute), 1610
- name (matplotlib.scale.LogScale attribute), 1609
- name (matplotlib.scale.SymmetricalLogScale attribute), 1613
- name (mpl_toolkits.mplot3d.axes3d.Axes3D attribute), 1855
- NaturalLogTransform (class in matplotlib.scale), 1611
- NavigationToolBar2 (class in matplotlib.backend_bases), 925
- NavigationToolBar2WxAgg (class in matplotlib.backends.backend_wxagg), 948
- NegFil (class in matplotlib.mathtext), 1271
- NegFill (class in matplotlib.mathtext), 1271
- NegFilll (class in matplotlib.mathtext), 1271
- neighbors (matplotlib.tri.Triangulation attribute), 1672
- new_axes() (matplotlib.widgets.SpanSelector method), 1700
- new_figure_manager() (in module matplotlib.backends.backend_pdf), 951
- new_figure_manager() (in module matplotlib.backends.backend_qt4agg), 946
- new_figure_manager() (in module matplotlib.backends.backend_qt5agg), 947
- new_figure_manager() (in module matplotlib.backends.backend_wxagg), 948
- new_figure_manager_given_figure() (in module matplotlib.backends.backend_pdf), 951
- new_figure_manager_given_figure() (in module matplotlib.backends.backend_qt4agg), 946
- new_figure_manager_given_figure() (in module matplotlib.backends.backend_qt5agg), 947
- new_figure_manager_given_figure() (in module matplotlib.backends.backend_svg), 951
- new_figure_manager_given_figure() (in module matplotlib.backends.backend_wxagg), 948
- new_gc() (matplotlib.backend_bases.RendererBase method), 930
- new_gc() (matplotlib.patheffects.PathEffectRenderer method), 1376
- new_horizontal() (mpl_toolkits.axes_grid.axes_divider.AxesDivider method), 1799
- new_locator() (mpl_toolkits.axes_grid.axes_divider.Divider method), 1797
- new_subplotspec() (matplotlib.gridspec.GridSpecBase method), 1228
- new_timer() (matplotlib.backend_bases.FigureCanvasBase method), 917
- new_vertical() (mpl_toolkits.axes_grid.axes_divider.AxesDivider method), 1800
- nipy_spectral() (in module matplotlib.pyplot), 1514
- Node (class in matplotlib.mathtext), 1271
- non_math() (matplotlib.mathtext.Parser method), 1273
- NonGuiException, 927
- NoNorm (class in matplotlib.colors), 1160
- nonsingular() (in module matplotlib.transforms), 1670
- nonsingular() (matplotlib.dates.AutoDateLocator method), 1173
- nonsingular() (matplotlib.dates.DateLocator method), 1171
- nonsingular() (matplotlib.ticker.LogLocator method), 1644
- NonUniformImage (class in matplotlib.image), 1232
- norm (matplotlib.cm.ScalarMappable attribute), 972
- norm_angle() (in module mpl_toolkits.mplot3d.art3d), 1875
- norm_flat() (in module matplotlib.mlab), 1300
- norm_text_angle() (in module mpl_toolkits.mplot3d.art3d), 1875
- Normal (class in matplotlib.patheffects), 1375
- Normalize (class in matplotlib.colors), 1160
- normalize_kwargs() (in module matplotlib.cbook), 963
- normalized() (matplotlib.dates.relativedelta method), 1178
- normpdf() (in module matplotlib.mlab), 1300
- Null (class in matplotlib.cbook), 956
- null() (matplotlib.transforms.Bbox static method), 1655
- NullFormatter (class in matplotlib.ticker), 1638
- NullLocator (class in matplotlib.ticker), 1643
- num2date() (in module matplotlib.dates), 1169
- num2epoch() (in module matplotlib.dates), 1169
- NUM_VERTICES_FOR_CODE (matplotlib.path.Path attribute), 1368
- numvertices (matplotlib.patches.RegularPolygon attribute), 1361

O

- offset_line() (in module matplotlib.mlab), 1300
- OffsetBox (class in matplotlib.offsetbox), 1319

- OffsetFrom (class in matplotlib.text), 1624
 - OffsetImage (class in matplotlib.offsetbox), 1320
 - OFFSETEXTPAD (matplotlib.axis.Axis attribute), 806
 - OFFSETEXTPAD (matplotlib.axis.XAxis attribute), 824
 - OFFSETEXTPAD (matplotlib.axis.YAxis attribute), 815
 - on_changed() (matplotlib.widgets.Slider method), 1698
 - on_clicked() (matplotlib.widgets.Button method), 1688
 - on_clicked() (matplotlib.widgets.CheckButtons method), 1689
 - on_clicked() (matplotlib.widgets.RadioButton method), 1695
 - on_mappable_changed() (matplotlib.colorbar.Colorbar method), 1145
 - on_motion() (matplotlib.offsetbox.DraggableBase method), 1317
 - on_motion_blit() (matplotlib.offsetbox.DraggableBase method), 1317
 - on_pick() (matplotlib.offsetbox.DraggableBase method), 1317
 - on_release() (matplotlib.offsetbox.DraggableBase method), 1317
 - onetrue() (in module matplotlib.cbook), 964
 - onHilite() (matplotlib.backend_bases.FigureCanvasBase method), 917
 - onmove() (matplotlib.widgets.Cursor method), 1690
 - onmove() (matplotlib.widgets.Lasso method), 1692
 - onmove() (matplotlib.widgets.MultiCursor method), 1694
 - onpick() (matplotlib.lines.VertexSelector method), 1253
 - onpress() (matplotlib.widgets.LassoSelector method), 1693
 - onrelease() (matplotlib.widgets.Lasso method), 1692
 - onrelease() (matplotlib.widgets.LassoSelector method), 1693
 - onRemove() (matplotlib.backend_bases.FigureCanvasBase method), 917
 - open_group() (matplotlib.backend_bases.RendererBase method), 930
 - Operator (class in matplotlib.backends.backend_pdf), 949
 - operatorname() (matplotlib.mathtext.Parser method), 1273
 - option_image_nocomposite() (matplotlib.backend_bases.RendererBase method), 930
 - option_scale_image() (matplotlib.backend_bases.RendererBase method), 930
 - ord() (in module matplotlib.dviread), 1184
 - ord() (in module matplotlib.type1font), 1684
 - orientation (matplotlib.patches.RegularPolygon attribute), 1361
 - OSXInstalledFonts() (in module matplotlib.font_manager), 1223
 - output_dims (matplotlib.scale.InvertedLogTransformBase attribute), 1606
 - output_dims (matplotlib.scale.InvertedSymmetricalLogTransform attribute), 1606
 - output_dims (matplotlib.scale.LogisticTransform attribute), 1610
 - output_dims (matplotlib.scale.LogitTransform attribute), 1611
 - output_dims (matplotlib.scale.LogScale.LogTransformBase attribute), 1609
 - output_dims (matplotlib.scale.LogTransformBase attribute), 1610
 - output_dims (matplotlib.scale.SymmetricalLogScale.InvertedSymmetricalLog attribute), 1612
 - output_dims (matplotlib.scale.SymmetricalLogScale.SymmetricalLogTransform attribute), 1613
 - output_dims (matplotlib.scale.SymmetricalLogTransform attribute), 1613
 - output_dims (matplotlib.transforms.Transform attribute), 1658
 - over() (in module matplotlib.pyplot), 1514
 - overlaps() (matplotlib.transforms.BboxBase method), 1653
 - overline() (matplotlib.mathtext.Parser method), 1273
- P**
- p0 (matplotlib.transforms.BboxBase attribute), 1653

- p1 (matplotlib.transforms.BboxBase attribute), 1653
 PackerBase (class in matplotlib.offsetbox), 1321
 Padded (class in mpl_toolkits.axes_grid.axes_size), 1795
 padded() (matplotlib.transforms.BboxBase method), 1653
 PaddedBox (class in matplotlib.offsetbox), 1321
 paintEvent() (matplotlib.backends.backend_qt5agg.FigureCanvasAgg method), 947
 pan() (matplotlib.axis.Axis method), 803
 pan() (matplotlib.axis.XAxis method), 829
 pan() (matplotlib.axis.YAxis method), 820
 pan() (matplotlib.backend_bases.NavigationToolbar2 method), 926
 pan() (matplotlib.ticker.Locator method), 1642
 parse() (matplotlib.fontconfig_pattern.FontconfigPattern method), 1225
 parse() (matplotlib.mathtext.MathTextParser method), 1268
 parse() (matplotlib.mathtext.Parser method), 1273
 parse_afm() (in module matplotlib.afm), 489
 parse_yahoo_historical_ohl() (in module matplotlib.finance), 1211
 parse_yahoo_historical_ohlc() (in module matplotlib.finance), 1211
 Parser (class in matplotlib.mathtext), 1271
 Parser.State (class in matplotlib.mathtext), 1271
 parts (matplotlib.type1font.Type1Font attribute), 1683
 pass_through (matplotlib.transforms.TransformNode attribute), 1651
 Patch (class in matplotlib.patches), 1351
 Patch3D (class in mpl_toolkits.mplot3d.art3d), 1871
 Patch3DCollection (class in mpl_toolkits.mplot3d.art3d), 1872
 patch_2d_to_3d() (in module mpl_toolkits.mplot3d.art3d), 1875
 patch_collection_2d_to_3d() (in module mpl_toolkits.mplot3d.art3d), 1875
 PatchCollection (class in matplotlib.collections), 1061
 PATH, 135, 139, 140, 143
 Path (class in matplotlib.path), 1367
 Path3DCollection (class in mpl_toolkits.mplot3d.art3d), 1872
 path_length() (in module matplotlib.mlab), 1300
 path_to_3d_segment() (in module mpl_toolkits.mplot3d.art3d), 1875
 path_to_3d_segment_with_codes() (in module mpl_toolkits.mplot3d.art3d), 1875
 PathCollection (class in matplotlib.collections), 1072
 PathEffectRenderer (class in matplotlib.patheffects), 1375
 PathPatch (class in matplotlib.patches), 1355
 PathPatch3D (class in mpl_toolkits.mplot3d.art3d), 1873
 pathpatch_2d_to_3d() (in module mpl_toolkits.mplot3d.art3d), 1875
 PathPatchEffect (class in matplotlib.patheffects), 1376
 paths_to_3d_segments() (in module mpl_toolkits.mplot3d.art3d), 1875
 paths_to_3d_segments_with_codes() (in module mpl_toolkits.mplot3d.art3d), 1875
 pause() (in module matplotlib.pyplot), 1514
 PCA (class in matplotlib.mlab), 1283
 pchanged() (matplotlib.artist.Artist method), 538
 pchanged() (matplotlib.axes.Axes method), 769
 pchanged() (matplotlib.axis.Axis method), 884
 pchanged() (matplotlib.axis.Tick method), 844
 pchanged() (matplotlib.axis.XAxis method), 895
 pchanged() (matplotlib.axis.XTick method), 855
 pchanged() (matplotlib.axis.YAxis method), 906
 pchanged() (matplotlib.axis.YTick method), 866
 pchanged() (matplotlib.collections.AsteriskPolygonCollection method), 980
 pchanged() (matplotlib.collections.BrokenBarHCollection method), 992
 pchanged() (matplotlib.collections.CircleCollection method), 1004
 pchanged() (matplotlib.collections.Collection method), 1017
 pchanged() (matplotlib.collections.EllipseCollection method), 1028
 pchanged() (matplotlib.collections.EventCollection method), 1041
 pchanged() (matplotlib.collections.LineCollection method), 1054
 pchanged() (matplotlib.collections.PatchCollection method), 1065
 pchanged() (matplotlib.collections.PathCollection method), 1077
 pchanged() (matplotlib.collections.PolyCollection

- method), 1089
- pchanged() (matplotlib.collections.QuadMesh method), 1101
- pchanged() (matplotlib.collections.RegularPolygonCollection method), 1113
- pchanged() (matplotlib.collections.StarPolygonCollection method), 1126
- pchanged() (matplotlib.collections.TriMesh method), 1137
- pchanged() (matplotlib.container.Container method), 1165
- pcolor() (in module matplotlib.pyplot), 1515
- pcolor() (matplotlib.axes.Axes method), 693
- pcolorfast() (matplotlib.axes.Axes method), 696
- PcolorImage (class in matplotlib.image), 1233
- pcolormesh() (in module matplotlib.pyplot), 1518
- pcolormesh() (matplotlib.axes.Axes method), 698
- PDF, 3017
- PdfFile (class in matplotlib.backends.backend_pdf), 949
- PdfPages (class in matplotlib.backends.backend_pdf), 949
- pdfRepr() (in module matplotlib.backends.backend_pdf), 951
- persp_transformation() (in module mpl_toolkits.mplot3d.proj3d), 1876
- phase_spectrum() (in module matplotlib.mlab), 1300
- phase_spectrum() (in module matplotlib.pyplot), 1520
- phase_spectrum() (matplotlib.axes.Axes method), 624
- pick() (matplotlib.artist.Artist method), 538
- pick() (matplotlib.axes.Axes method), 773
- pick() (matplotlib.axis.Axis method), 884
- pick() (matplotlib.axis.Tick method), 844
- pick() (matplotlib.axis.XAxis method), 895
- pick() (matplotlib.axis.XTick method), 855
- pick() (matplotlib.axis.YAxis method), 906
- pick() (matplotlib.axis.YTick method), 867
- pick() (matplotlib.backend_bases.FigureCanvasBase method), 917
- pick() (matplotlib.collections.AsteriskPolygonCollection method), 981
- pick() (matplotlib.collections.BrokenBarHCollection method), 992
- pick() (matplotlib.collections.CircleCollection method), 1004
- pick() (matplotlib.collections.Collection method), 1017
- pick() (matplotlib.collections.EllipseCollection method), 1028
- pick() (matplotlib.collections.EventCollection method), 1041
- pick() (matplotlib.collections.LineCollection method), 1054
- pick() (matplotlib.collections.PatchCollection method), 1065
- pick() (matplotlib.collections.PolyCollection method), 1089
- pick() (matplotlib.collections.QuadMesh method), 1101
- pick() (matplotlib.collections.RegularPolygonCollection method), 1114
- pick() (matplotlib.collections.StarPolygonCollection method), 1126
- pick() (matplotlib.collections.TriMesh method), 1137
- pick_event() (matplotlib.backend_bases.FigureCanvasBase method), 917
- pickable() (matplotlib.artist.Artist method), 538
- pickable() (matplotlib.axes.Axes method), 773
- pickable() (matplotlib.axis.Axis method), 884
- pickable() (matplotlib.axis.Tick method), 844
- pickable() (matplotlib.axis.XAxis method), 895
- pickable() (matplotlib.axis.XTick method), 855
- pickable() (matplotlib.axis.YAxis method), 906
- pickable() (matplotlib.axis.YTick method), 867
- pickable() (matplotlib.collections.AsteriskPolygonCollection method), 981
- pickable() (matplotlib.collections.BrokenBarHCollection method), 993
- pickable() (matplotlib.collections.CircleCollection method), 1005
- pickable() (matplotlib.collections.Collection method), 1017
- pickable() (matplotlib.collections.EllipseCollection method), 1028
- pickable() (matplotlib.collections.EventCollection method), 1041
- pickable() (matplotlib.collections.LineCollection method), 1054
- pickable() (matplotlib.collections.PatchCollection method), 1066

- pickable() (matplotlib.collections.PathCollection method), 1077
 pickable() (matplotlib.collections.PolyCollection method), 1089
 pickable() (matplotlib.collections.QuadMesh method), 1101
 pickable() (matplotlib.collections.RegularPolyCollection method), 1114
 pickable() (matplotlib.collections.StarPolygonCollection method), 1126
 pickable() (matplotlib.collections.TriMesh method), 1138
 PickEvent (class in matplotlib.backend_bases), 927
 pickle_dump() (in module matplotlib.font_manager), 1224
 pickle_load() (in module matplotlib.font_manager), 1224
 pie() (in module matplotlib.pyplot), 1523
 pie() (matplotlib.axes.Axes method), 592
 pieces() (in module matplotlib.cbook), 964
 pil_to_array() (in module matplotlib.image), 1235
 pink() (in module matplotlib.pyplot), 1525
 plasma() (in module matplotlib.pyplot), 1525
 plot() (in module matplotlib.pyplot), 1526
 plot() (matplotlib.axes.Axes method), 557
 plot() (matplotlib.cbook.MemoryMonitor method), 956
 plot() (mpl_toolkits.mplot3d.Axes3D method), 1827
 plot() (mpl_toolkits.mplot3d.axes3d.Axes3D method), 1855
 plot3D() (mpl_toolkits.mplot3d.axes3d.Axes3D method), 1856
 plot_date() (in module matplotlib.pyplot), 1529
 plot_date() (matplotlib.axes.Axes method), 566
 plot_day_summary2_ohl() (in module matplotlib.finance), 1212
 plot_day_summary2_ohlc() (in module matplotlib.finance), 1213
 plot_day_summary_ohl() (in module matplotlib.finance), 1213
 plot_day_summary_ohlc() (in module matplotlib.finance), 1214
 plot_surface() (mpl_toolkits.mplot3d.Axes3D method), 1830
 plot_surface() (mpl_toolkits.mplot3d.axes3d.Axes3D method), 1856
 plot_trisurf() (mpl_toolkits.mplot3d.Axes3D method), 1833
 plot_trisurf() (mpl_toolkits.mplot3d.axes3d.Axes3D method), 1856
 plot_wireframe() (mpl_toolkits.mplot3d.Axes3D method), 1829
 plot_wireframe() (mpl_toolkits.mplot3d.axes3d.Axes3D method), 1858
 plotfile() (in module matplotlib.pyplot), 1531
 plotting() (in module matplotlib.pyplot), 425
 PNG, 3017
 POINTER (matplotlib.backend_tools.Cursors attribute), 937
 points_to_pixels() (matplotlib.backend_bases.RendererBase method), 930
 points_to_pixels() (matplotlib.patheffects.PathEffectRenderer method), 1376
 polar() (in module matplotlib.pyplot), 1532
 PolarAffine (class in matplotlib.projections.polar), 1380
 PolarAxes (class in matplotlib.projections.polar), 1380
 PolarAxes.InvertedPolarTransform (class in matplotlib.projections.polar), 1380
 PolarAxes.PolarAffine (class in matplotlib.projections.polar), 1381
 PolarAxes.PolarTransform (class in matplotlib.projections.polar), 1381
 PolarAxes.RadialLocator (class in matplotlib.projections.polar), 1382
 PolarAxes.ThetaFormatter (class in matplotlib.projections.polar), 1382
 PolarTransform (class in matplotlib.projections.polar), 1385
 Poly3DCollection (class in mpl_toolkits.mplot3d.art3d), 1873
 poly_below() (in module matplotlib.mlab), 1301
 poly_between() (in module matplotlib.mlab), 1301
 poly_collection_2d_to_3d() (in module mpl_toolkits.mplot3d.art3d), 1875
 PolyCollection (class in matplotlib.collections), 1084
 Polygon (class in matplotlib.patches), 1356
 pop_state() (matplotlib.mathtext.Parser method), 1273
 popall() (in module matplotlib.cbook), 964
 PowerNorm (class in matplotlib.colors), 1161
 pprint_val() (matplotlib.ticker.LogFormatter

- method), 1641
- pprint_val() (matplotlib.ticker.ScalarFormatter method), 1639
- prctile() (in module matplotlib.mlab), 1301
- prctile_rank() (in module matplotlib.mlab), 1302
- press() (matplotlib.backend_bases.NavigationToolbar2 method), 926
- press_pan() (matplotlib.backend_bases.NavigationToolbar2 method), 926
- press_zoom() (matplotlib.backend_bases.NavigationToolbar2 method), 926
- print_cycles() (in module matplotlib.cbook), 964
- print_figure() (matplotlib.backend_bases.FigureCanvasBase method), 917
- print_figure() (matplotlib.backends.backend_qt5agg.FigureCanvasQTAggBase method), 947
- print_figure() (matplotlib.backends.backend_wxagg.FigureCanvasWxAgg method), 948
- prism() (in module matplotlib.pyplot), 1532
- process() (matplotlib.cbook.CallbackRegistry method), 954
- process_projection_requirements() (in module matplotlib.projections), 1379
- process_selected() (matplotlib.lines.VertexSelector method), 1254
- process_value() (matplotlib.colors.Normalize static method), 1160
- proj_points() (in module mpl_toolkits.mplot3d.proj3d), 1876
- proj_trans_clip_points() (in module mpl_toolkits.mplot3d.proj3d), 1876
- proj_trans_points() (in module mpl_toolkits.mplot3d.proj3d), 1876
- proj_transform() (in module mpl_toolkits.mplot3d.proj3d), 1876
- proj_transform_clip() (in module mpl_toolkits.mplot3d.proj3d), 1876
- proj_transform_vec() (in module mpl_toolkits.mplot3d.proj3d), 1876
- proj_transform_vec_clip() (in module mpl_toolkits.mplot3d.proj3d), 1876
- project() (matplotlib.mlab.PCA method), 1284
- ProjectionRegistry (class in matplotlib.projections), 1379
- prop (matplotlib.type1font.Type1Font attribute), 1683
- properties() (matplotlib.artist.Artist method), 542
- properties() (matplotlib.axes.Axes method), 778
- properties() (matplotlib.axis.Axis method), 884
- properties() (matplotlib.axis.Tick method), 844
- properties() (matplotlib.axis.XAxis method), 895
- properties() (matplotlib.axis.XTick method), 856
- properties() (matplotlib.axis.YAxis method), 906
- properties() (matplotlib.axis.YTick method), 867
- properties() (matplotlib.collections.AsteriskPolygonCollection method), 981
- properties() (matplotlib.collections.BrokenBarHCollection method), 993
- properties() (matplotlib.collections.CircleCollection method), 1005
- properties() (matplotlib.collections.Collection method), 1017
- properties() (matplotlib.collections.EllipseCollection method), 1028
- properties() (matplotlib.collections.EventCollection method), 1041
- properties() (matplotlib.collections.LineCollection method), 1054
- properties() (matplotlib.collections.PatchCollection method), 1066
- properties() (matplotlib.collections.PathCollection method), 1077
- properties() (matplotlib.collections.PolyCollection method), 1089
- properties() (matplotlib.collections.QuadMesh method), 1101
- properties() (matplotlib.collections.RegularPolyCollection method), 1114
- properties() (matplotlib.collections.StarPolygonCollection method), 1126
- properties() (matplotlib.collections.TriMesh method), 1138
- PS, 3017
- psd() (in module matplotlib.mlab), 1302
- psd() (in module matplotlib.pyplot), 1532
- psd() (matplotlib.axes.Axes method), 627
- PsfondsMap (class in matplotlib.dviread), 1182
- pts_to_midstep() (in module matplotlib.cbook), 964
- pts_to_poststep() (in module matplotlib.cbook), 965
- pts_to_prestep() (in module matplotlib.cbook), 965
- push() (matplotlib.cbook.Stack method), 957
- push_current() (mat-

- plotlib.backend_bases.NavigationToolbar2
 method), 926
 push_current() (matplotlib.backend_tools.ToolViewsPositions
 method), 943
 push_state() (matplotlib.mathtext.Parser method),
 1273
 pygtk, 3017
 pyqt, 3017
 python, 3017
 Python Enhancement Proposals
 PEP 440, 1960
 PYTHONPATH, 1745, 1909
 pytz, 3017
- ## Q
- Qt, 3017
 Qt4, 3017
 Qt5, 3017
 quad2cubic() (in module matplotlib.mlab), 1304
 QuadMesh (class in matplotlib.collections), 1096
 quiver() (in module matplotlib.pyplot), 1536
 quiver() (matplotlib.axes.Axes method), 725
 quiver() (mpl_toolkits.mplot3d.Axes3D method),
 1842
 quiver() (mpl_toolkits.mplot3d.axes3d.Axes3D
 method), 1859
 quiver3D() (mpl_toolkits.mplot3d.axes3d.Axes3D
 method), 1860
 quiverkey() (in module matplotlib.pyplot), 1540
 quiverkey() (matplotlib.axes.Axes method), 729
 quotes_historical_yahoo_ochl() (in module mat-
 plotlib.finance), 1214
 quotes_historical_yahoo_ohlc() (in module mat-
 plotlib.finance), 1215
- ## R
- RadialLocator (class in mat-
 plotlib.projections.polar), 1386
 radio_group (matplotlib.backend_tools.ToolPan at-
 tribute), 942
 radio_group (matplotlib.backend_tools.ToolToggleBase
 attribute), 942
 radio_group (matplotlib.backend_tools.ToolZoom
 attribute), 944
 RadioButtons (class in matplotlib.widgets), 1694
 radius (matplotlib.patches.Circle attribute), 1337
 radius (matplotlib.patches.RegularPolygon at-
 tribute), 1361
 raise_if_exceeds() (matplotlib.ticker.Locator
 method), 1642
 raster graphics, 3017
 rc() (in module matplotlib), 483
 rc() (in module matplotlib.pyplot), 1541
 rc_context (class in matplotlib), 485
 rc_context() (in module matplotlib.pyplot), 1542
 rc_params() (in module matplotlib), 484
 rc_params_from_file() (in module matplotlib), 485
 rcdefaults() (in module matplotlib.pyplot), 1542
 RcParams (class in matplotlib), 484
 rcParams (in module matplotlib), 483
 readonly (matplotlib.path.Path attribute), 1372
 rec2csv() (in module matplotlib.mlab), 1304
 rec2txt() (in module matplotlib.mlab), 1304
 rec_append_fields() (in module matplotlib.mlab),
 1305
 rec_drop_fields() (in module matplotlib.mlab), 1305
 rec_groupby() (in module matplotlib.mlab), 1305
 rec_join() (in module matplotlib.mlab), 1305
 rec_keep_fields() (in module matplotlib.mlab), 1305
 rec_summarize() (in module matplotlib.mlab), 1305
 recache() (matplotlib.lines.Line2D method), 1249
 recache_always() (matplotlib.lines.Line2D method),
 1249
 recs_join() (in module matplotlib.mlab), 1305
 Rectangle (class in matplotlib.patches), 1358
 RectangleSelector (class in matplotlib.widgets),
 1695
 recursive_remove() (in module matplotlib.cbook),
 965
 redraw_in_frame() (matplotlib.axes.Axes method),
 777
 Reference (class in mat-
 plotlib.backends.backend_pdf), 950
 refine_field() (matplotlib.tri.UniformTriRefiner
 method), 1677
 refine_triangulation() (mat-
 plotlib.tri.UniformTriRefiner method),
 1678
 refresh() (matplotlib.dates.AutoDateLocator
 method), 1173
 refresh() (matplotlib.ticker.Locator method), 1642
 refresh_locators() (mat-
 plotlib.backend_tools.ToolViewsPositions
 method), 943

register() (matplotlib.projections.ProjectionRegistry method), 1379
 register_axis() (matplotlib.spines.Spine method), 1617
 register_backend() (in module matplotlib.backend_bases), 934
 register_cmap() (in module matplotlib.cm), 973
 register_scale() (in module matplotlib.scale), 1613
 Registry (class in matplotlib.units), 1686
 RegularPolyCollection (class in matplotlib.collections), 1108
 RegularPolygon (class in matplotlib.patches), 1360
 relativedelta (class in matplotlib.dates), 1177
 release() (matplotlib.backend_bases.NavigationToolbar2 method), 926
 release() (matplotlib.widgets.LockDraw method), 1693
 release_mouse() (matplotlib.backend_bases.FigureCanvasBase method), 918
 release_pan() (matplotlib.backend_bases.NavigationToolbar2 method), 926
 release_zoom() (matplotlib.backend_bases.NavigationToolbar2 method), 926
 relim() (matplotlib.axes.Axes method), 752
 reload_library() (in module matplotlib.style), 1619
 remove() (matplotlib.artist.Artist method), 546
 remove() (matplotlib.axes.Axes method), 786
 remove() (matplotlib.axis.Axis method), 884
 remove() (matplotlib.axis.Tick method), 844
 remove() (matplotlib.axis.XAxis method), 895
 remove() (matplotlib.axis.XTick method), 856
 remove() (matplotlib.axis.YAxis method), 906
 remove() (matplotlib.axis.YTick method), 867
 remove() (matplotlib.cbook.Grouper method), 955
 remove() (matplotlib.cbook.Stack method), 957
 remove() (matplotlib.collections.AsteriskPolygonCollection method), 981
 remove() (matplotlib.collections.BrokenBarHCollection method), 993
 remove() (matplotlib.collections.CircleCollection method), 1005
 remove() (matplotlib.collections.Collection method), 1017
 remove() (matplotlib.collections.EllipseCollection method), 1029
 remove() (matplotlib.collections.EventCollection method), 1041
 remove() (matplotlib.collections.LineCollection method), 1054
 remove() (matplotlib.collections.PatchCollection method), 1066
 remove() (matplotlib.collections.PathCollection method), 1077
 remove() (matplotlib.collections.PolyCollection method), 1089
 remove() (matplotlib.collections.QuadMesh method), 1102
 remove() (matplotlib.collections.RegularPolyCollection method), 1114
 remove() (matplotlib.collections.StarPolygonCollection method), 1126
 remove() (matplotlib.collections.TriMesh method), 1138
 remove() (matplotlib.colorbar.Colorbar method), 1145
 remove() (matplotlib.colorbar.ColorbarBase method), 1147
 remove() (matplotlib.container.Container method), 1165
 remove() (matplotlib.figure.AxesStack method), 1185
 remove_callback() (matplotlib.artist.Artist method), 538
 remove_callback() (matplotlib.axes.Axes method), 769
 remove_callback() (matplotlib.axis.Axis method), 884
 remove_callback() (matplotlib.axis.Tick method), 844
 remove_callback() (matplotlib.axis.XAxis method), 896
 remove_callback() (matplotlib.axis.XTick method), 856
 remove_callback() (matplotlib.axis.YAxis method), 907
 remove_callback() (matplotlib.axis.YTick method), 867
 remove_callback() (matplotlib.backend_bases.TimerBase method), 932
 remove_callback() (matplotlib.collections.AsteriskPolygonCollection method), 981

remove_callback()	(matplotlib.collections.BrokenBarHCollection method), 993	remove_toolitem()	(matplotlib.backend_bases.ToolContainerBase method), 933
remove_callback()	(matplotlib.collections.CircleCollection method), 1005	render()	(matplotlib.mathtext.Accent method), 1261
remove_callback()	(matplotlib.collections.Collection method), 1017	render()	(matplotlib.mathtext.Box method), 1262
remove_callback()	(matplotlib.collections.EllipseCollection method), 1029	render()	(matplotlib.mathtext.Char method), 1262
remove_callback()	(matplotlib.collections.EventCollection method), 1042	render()	(matplotlib.mathtext.Node method), 1271
remove_callback()	(matplotlib.collections.LineCollection method), 1054	render()	(matplotlib.mathtext.Rule method), 1274
remove_callback()	(matplotlib.collections.PatchCollection method), 1066	render_glyph()	(matplotlib.mathtext.Fonts method), 1265
remove_callback()	(matplotlib.collections.PathCollection method), 1078	render_glyph()	(matplotlib.mathtext.MathtextBackend method), 1269
remove_callback()	(matplotlib.collections.PolyCollection method), 1090	render_glyph()	(matplotlib.mathtext.MathtextBackendAgg method), 1269
remove_callback()	(matplotlib.collections.QuadMesh method), 1102	render_glyph()	(matplotlib.mathtext.MathtextBackendCairo method), 1270
remove_callback()	(matplotlib.collections.RegularPolyCollection method), 1114	render_glyph()	(matplotlib.mathtext.MathtextBackendPath method), 1270
remove_callback()	(matplotlib.collections.StarPolygonCollection method), 1126	render_glyph()	(matplotlib.mathtext.MathtextBackendPdf method), 1270
remove_callback()	(matplotlib.collections.TriMesh method), 1138	render_glyph()	(matplotlib.mathtext.MathtextBackendPs method), 1270
remove_callback()	(matplotlib.container.Container method), 1165	render_glyph()	(matplotlib.mathtext.MathtextBackendSvg method), 1271
remove_rubberband()	(matplotlib.backend_bases.NavigationToolbar2 method), 926	render_rect_filled()	(matplotlib.mathtext.Fonts method), 1266
remove_rubberband()	(matplotlib.backend_tools.RubberbandBase method), 938	render_rect_filled()	(matplotlib.mathtext.MathtextBackend method), 1269
remove_tool()	(matplotlib.backend_managers.ToolManager method), 935	render_rect_filled()	(matplotlib.mathtext.MathtextBackendAgg method), 1269
		render_rect_filled()	(matplotlib.mathtext.MathtextBackendCairo method), 1270
		render_rect_filled()	(matplotlib.mathtext.MathtextBackendPath method), 1270
		render_rect_filled()	(matplotlib.mathtext.MathtextBackendPdf method), 1270

method), 1270

render_rect_filled() (matplotlib.mathtext.MathtextBackendPs method), 1270

render_rect_filled() (matplotlib.mathtext.MathtextBackendSvg method), 1271

RendererBase (class in matplotlib.backend_bases), 927

replace() (matplotlib.dates.rrule method), 1177

report() (matplotlib.cbook.MemoryMonitor method), 956

report_memory() (in module matplotlib.cbook), 965

required_group() (matplotlib.mathtext.Parser method), 1273

reserveObject() (matplotlib.backends.backend_pdf.PdfFile method), 949

reset() (matplotlib.widgets.Slider method), 1698

reset_position() (matplotlib.axes.Axes method), 768

reset_ticks() (matplotlib.axis.Axis method), 806

reset_ticks() (matplotlib.axis.XAxis method), 829

reset_ticks() (matplotlib.axis.YAxis method), 820

resize() (matplotlib.backend_bases.FigureCanvasBase method), 918

resize() (matplotlib.backend_bases.FigureManagerBase method), 919

resize_event() (matplotlib.backend_bases.FigureCanvasBase method), 918

ResizeEvent (class in matplotlib.backend_bases), 930

restore() (matplotlib.backend_bases.GraphicsContextBase method), 921

restrict_dict() (in module matplotlib.cbook), 966

revcmmap() (in module matplotlib.cm), 973

reverse_dict() (in module matplotlib.cbook), 966

rgb_to_hsv() (in module matplotlib.colors), 1162

rgrids() (in module matplotlib.pyplot), 1542

RingBuffer (class in matplotlib.cbook), 956

rk4() (in module matplotlib.mlab), 1306

rms_flat() (in module matplotlib.mlab), 1307

rot_x() (in module mpl_toolkits.mplot3d.proj3d), 1876

rotate() (matplotlib.transforms.Affine2D method), 1663

rotate_around() (matplotlib.transforms.Affine2D method), 1663

rotate_axes() (in module mpl_toolkits.mplot3d.art3d), 1875

rotate_deg() (matplotlib.transforms.Affine2D method), 1663

rotate_deg_around() (matplotlib.transforms.Affine2D method), 1663

rotated() (matplotlib.transforms.BboxBase method), 1653

rrule (class in matplotlib.dates), 1175

RRuleLocator (class in matplotlib.dates), 1171

RubberbandBase (class in matplotlib.backend_tools), 937

Rule (class in matplotlib.mathtext), 1273

S

safe_first_element() (in module matplotlib.cbook), 966

safe_isinf() (in module matplotlib.mlab), 1307

safe_isnan() (in module matplotlib.mlab), 1307

safe_masked_invalid() (in module matplotlib.cbook), 966

safezip() (in module matplotlib.cbook), 966

Sankey (class in matplotlib.sankey), 1597

save() (matplotlib.animation.Animation method), 494

save_figure() (matplotlib.backend_bases.NavigationToolbar2 method), 926

save_offset() (matplotlib.offsetbox.DraggableAnnotation method), 1316

save_offset() (matplotlib.offsetbox.DraggableBase method), 1317

save_offset() (matplotlib.offsetbox.DraggableOffsetBox method), 1318

savefig() (in module matplotlib.pyplot), 1543

savefig() (matplotlib.backends.backend_pdf.PdfPages method), 950

savefig() (matplotlib.figure.Figure method), 1200

SaveFigureBase (class in matplotlib.backend_tools), 938

saving() (matplotlib.animation.MovieWriter method), 524

sca() (in module matplotlib.pyplot), 1544

sca() (matplotlib.figure.Figure method), 1201

ScalarFormatter (class in matplotlib.ticker), 1639

- ScalarMappable (class in matplotlib.cm), 971
- scale() (matplotlib.transforms.Affine2D method), 1663
- scale_factors (matplotlib.tri.TriAnalyzer attribute), 1681
- scale_factory() (in module matplotlib.scale), 1614
- ScaleBase (class in matplotlib.scale), 1611
- Scaled (class in mpl_toolkits.axes_grid.axes_size), 1795
- scaled() (matplotlib.colors.Normalize method), 1161
- ScaledTranslation (class in matplotlib.transforms), 1669
- scatter() (in module matplotlib.pyplot), 1544
- scatter() (matplotlib.axes.Axes method), 564
- scatter() (mpl_toolkits.mplot3d.Axes3D method), 1827
- scatter() (mpl_toolkits.mplot3d.axes3d.Axes3D method), 1860
- scatter3D() (mpl_toolkits.mplot3d.axes3d.Axes3D method), 1861
- sci() (in module matplotlib.pyplot), 1546
- score_family() (matplotlib.font_manager.FontManager method), 1220
- score_size() (matplotlib.font_manager.FontManager method), 1220
- score_stretch() (matplotlib.font_manager.FontManager method), 1220
- score_style() (matplotlib.font_manager.FontManager method), 1220
- score_variant() (matplotlib.font_manager.FontManager method), 1220
- score_weight() (matplotlib.font_manager.FontManager method), 1220
- scotts_factor() (matplotlib.mlab.GaussianKDE method), 1283
- script_space (matplotlib.mathtext.ComputerModernFontConstants attribute), 1262
- script_space (matplotlib.mathtext.FontConstantsBase attribute), 1264
- script_space (matplotlib.mathtext.STIXFontConstants attribute), 1274
- script_space (matplotlib.mathtext.STIXSansFontConstants attribute), 1274
- scroll_event() (matplotlib.backend_bases.FigureCanvasBase method), 918
- scroll_zoom() (matplotlib.backend_tools.ZoomPanBase method), 944
- SecondLocator (class in matplotlib.dates), 1174
- seconds() (in module matplotlib.dates), 1178
- segment_hits() (in module matplotlib.lines), 1254
- segments_intersect() (in module matplotlib.mlab), 1307
- SELECT_REGION (matplotlib.backend_tools.Cursors attribute), 937
- semilogx() (in module matplotlib.pyplot), 1546
- semilogx() (matplotlib.axes.Axes method), 571
- semilogy() (in module matplotlib.pyplot), 1548
- semilogy() (matplotlib.axes.Axes method), 573
- send_message() (matplotlib.backend_tools.ToolCursorPosition method), 940
- set() (matplotlib.artist.Artist method), 542
- set() (matplotlib.axes.Axes method), 778
- set() (matplotlib.axis.Axis method), 885
- set() (matplotlib.axis.Tick method), 845
- set() (matplotlib.axis.XAxis method), 896
- set() (matplotlib.axis.XTick method), 856
- set() (matplotlib.axis.YAxis method), 907
- set() (matplotlib.axis.YTick method), 867
- set() (matplotlib.collections.AsteriskPolygonCollection method), 981
- set() (matplotlib.collections.BrokenBarHCollection method), 993
- set() (matplotlib.collections.CircleCollection method), 1005
- set() (matplotlib.collections.Collection method), 1017
- set() (matplotlib.collections.EllipseCollection method), 1029
- set() (matplotlib.collections.EventCollection method), 1042
- set() (matplotlib.collections.LineCollection method), 1054
- set() (matplotlib.collections.PatchCollection method), 1066
- set() (matplotlib.collections.PathCollection method), 1078
- set() (matplotlib.collections.PolyCollection method),

- 1090
- set() (matplotlib.collections.QuadMesh method), 1102
- set() (matplotlib.collections.RegularPolyCollection method), 1114
- set() (matplotlib.collections.StarPolygonCollection method), 1126
- set() (matplotlib.collections.TriMesh method), 1138
- set() (matplotlib.font_manager.TempCache method), 1224
- set() (matplotlib.transforms.Affine2D method), 1663
- set() (matplotlib.transforms.Bbox method), 1655
- set() (matplotlib.transforms.TransformWrapper method), 1660
- set_3d_properties() (mpl_toolkits.mplot3d.art3d.Line3DCollection method), 1871
- set_3d_properties() (mpl_toolkits.mplot3d.art3d.Patch3DCollection method), 1872
- set_3d_properties() (mpl_toolkits.mplot3d.art3d.Patch3DCollection method), 1872
- set_3d_properties() (mpl_toolkits.mplot3d.art3d.Path3DCollection method), 1873
- set_3d_properties() (mpl_toolkits.mplot3d.art3d.PathPatch3DCollection method), 1873
- set_3d_properties() (mpl_toolkits.mplot3d.art3d.Poly3DCollection method), 1873
- set_3d_properties() (mpl_toolkits.mplot3d.art3d.Text3DCollection method), 1874
- set_aa() (matplotlib.lines.Line2D method), 1249
- set_aa() (matplotlib.patches.Patch method), 1353
- set_active() (matplotlib.widgets.CheckButtons method), 1689
- set_active() (matplotlib.widgets.RadioButtons method), 1695
- set_active() (matplotlib.widgets.Widget method), 1701
- set_adjustable() (matplotlib.axes.Axes method), 755
- set_agg_filter() (matplotlib.artist.Artist method), 544
- set_agg_filter() (matplotlib.axes.Axes method), 782
- set_agg_filter() (matplotlib.axis.Axis method), 885
- set_agg_filter() (matplotlib.axis.Tick method), 845
- set_agg_filter() (matplotlib.axis.XAxis method), 896
- set_agg_filter() (matplotlib.axis.XTick method), 856
- set_agg_filter() (matplotlib.axis.YAxis method), 907
- set_agg_filter() (matplotlib.axis.YTick method), 868
- set_agg_filter() (matplotlib.collections.AsteriskPolygonCollection method), 981
- set_agg_filter() (matplotlib.collections.BrokenBarHCollection method), 993
- set_agg_filter() (matplotlib.collections.CircleCollection method), 1005
- set_agg_filter() (matplotlib.collections.Collection method), 1017
- set_agg_filter() (matplotlib.collections.EllipseCollection method), 1029
- set_agg_filter() (matplotlib.collections.EventCollection method), 1042
- set_agg_filter() (matplotlib.collections.LineCollection method), 1054
- set_agg_filter() (matplotlib.collections.PatchCollection method), 1066
- set_agg_filter() (matplotlib.collections.PathCollection method), 1078
- set_agg_filter() (matplotlib.collections.PolyCollection method), 1090
- set_agg_filter() (matplotlib.collections.QuadMesh method), 1102
- set_agg_filter() (matplotlib.collections.RegularPolyCollection method), 1114
- set_agg_filter() (matplotlib.collections.StarPolygonCollection method), 1126
- set_agg_filter() (matplotlib.collections.TriMesh method), 1138
- set_alpha() (matplotlib.artist.Artist method), 544
- set_alpha() (matplotlib.axes.Axes method), 779
- set_alpha() (matplotlib.axis.Axis method), 885
- set_alpha() (matplotlib.axis.Tick method), 845
- set_alpha() (matplotlib.axis.XAxis method), 896
- set_alpha() (matplotlib.axis.XTick method), 856
- set_alpha() (matplotlib.axis.YAxis method), 907
- set_alpha() (matplotlib.axis.YTick method), 868
- set_alpha() (matplotlib.backend_bases.GraphicsContextBase method), 921
- set_alpha() (matplotlib.collections.AsteriskPolygonCollection method), 981

set_alpha() (matplotlib.collections.BrokenBarHCollection method), 993
 set_alpha() (matplotlib.collections.CircleCollection method), 1005
 set_alpha() (matplotlib.collections.Collection method), 1017
 set_alpha() (matplotlib.collections.EllipseCollection method), 1029
 set_alpha() (matplotlib.collections.EventCollection method), 1042
 set_alpha() (matplotlib.collections.LineCollection method), 1055
 set_alpha() (matplotlib.collections.PatchCollection method), 1066
 set_alpha() (matplotlib.collections.PathCollection method), 1078
 set_alpha() (matplotlib.collections.PolyCollection method), 1090
 set_alpha() (matplotlib.collections.QuadMesh method), 1102
 set_alpha() (matplotlib.collections.RegularPolyCollection method), 1114
 set_alpha() (matplotlib.collections.StarPolygonCollection method), 1127
 set_alpha() (matplotlib.collections.TriMesh method), 1138
 set_alpha() (matplotlib.colorbar.ColorbarBase method), 1147
 set_alpha() (matplotlib.patches.Patch method), 1353
 set_alpha() (mpl_toolkits.mplot3d.art3d.Poly3DCollection method), 1874
 set_anchor() (matplotlib.axes.Axes method), 767
 set_anchor() (mpl_toolkits.axes_grid.axes_divider.Divider method), 1797
 set_animated() (matplotlib.artist.Artist method), 543
 set_animated() (matplotlib.axes.Axes method), 780
 set_animated() (matplotlib.axis.Axis method), 885
 set_animated() (matplotlib.axis.Tick method), 845
 set_animated() (matplotlib.axis.XAxis method), 896
 set_animated() (matplotlib.axis.XTick method), 857
 set_animated() (matplotlib.axis.YAxis method), 907
 set_animated() (matplotlib.axis.YTick method), 868
 set_animated() (matplotlib.collections.AsteriskPolygonCollection method), 981
 set_animated() (matplotlib.collections.BrokenBarHCollection method), 993
 set_animated() (matplotlib.collections.CircleCollection method), 1005
 set_animated() (matplotlib.collections.Collection method), 1017
 set_animated() (matplotlib.collections.EllipseCollection method), 1029
 set_animated() (matplotlib.collections.EventCollection method), 1042
 set_animated() (matplotlib.collections.LineCollection method), 1055
 set_animated() (matplotlib.collections.PatchCollection method), 1066
 set_animated() (matplotlib.collections.PathCollection method), 1078
 set_animated() (matplotlib.collections.PolyCollection method), 1090
 set_animated() (matplotlib.collections.QuadMesh method), 1102
 set_animated() (matplotlib.collections.RegularPolyCollection method), 1114
 set_animated() (matplotlib.collections.StarPolygonCollection method), 1127
 set_animated() (matplotlib.collections.TriMesh method), 1138
 set_animated() (matplotlib.widgets.ToolHandles method), 1700
 set_annotation_clip() (matplotlib.patches.ConnectionPatch method), 1339
 set_antialiased() (matplotlib.backend_bases.GraphicsContextBase method), 921
 set_antialiased() (matplotlib.collections.AsteriskPolygonCollection method), 981
 set_antialiased() (matplotlib.collections.BrokenBarHCollection method), 993
 set_antialiased() (matplotlib.collections.CircleCollection method), 1005
 set_antialiased() (matplotlib.collections.Collection method), 1017
 set_antialiased() (matplotlib.collections.EllipseCollection method), 1029
 set_antialiased() (matplotlib.collections.EventCollection method), 1042
 set_antialiased() (matplotlib.collections.LineCollection method), 1055
 set_antialiased() (matplotlib.collections.PatchCollection method), 1066
 set_antialiased() (matplotlib.collections.PathCollection method), 1078
 set_antialiased() (matplotlib.collections.PolyCollection method), 1090
 set_antialiased() (matplotlib.collections.QuadMesh method), 1102
 set_antialiased() (matplotlib.collections.RegularPolyCollection method), 1114
 set_antialiased() (matplotlib.collections.StarPolygonCollection method), 1127
 set_antialiased() (matplotlib.collections.TriMesh method), 1138
 set_antialiased() (matplotlib.widgets.ToolHandles method), 1700

plotlib.collections.CircleCollection method), 1005	plotlib.collections.EllipseCollection method), 1029
set_antialiased() (matplotlib.collections.Collection method), 1017	set_antialiaseds() (matplotlib.collections.EventCollection method), 1042
set_antialiased() (matplotlib.collections.EllipseCollection method), 1029	set_antialiaseds() (matplotlib.collections.LineCollection method), 1055
set_antialiased() (matplotlib.collections.EventCollection method), 1042	set_antialiaseds() (matplotlib.collections.PatchCollection method), 1066
set_antialiased() (matplotlib.collections.LineCollection method), 1055	set_antialiaseds() (matplotlib.collections.PathCollection method), 1078
set_antialiased() (matplotlib.collections.PatchCollection method), 1066	set_antialiaseds() (matplotlib.collections.PolyCollection method), 1090
set_antialiased() (matplotlib.collections.PathCollection method), 1078	set_antialiaseds() (matplotlib.collections.QuadMesh method), 1102
set_antialiased() (matplotlib.collections.PolyCollection method), 1090	set_antialiaseds() (matplotlib.collections.RegularPolyCollection method), 1114
set_antialiased() (matplotlib.collections.QuadMesh method), 1102	set_antialiaseds() (matplotlib.collections.StarPolygonCollection method), 1127
set_antialiased() (matplotlib.collections.RegularPolyCollection method), 1114	set_antialiaseds() (matplotlib.collections.TriMesh method), 1138
set_antialiased() (matplotlib.collections.StarPolygonCollection method), 1127	set_array() (matplotlib.cm.ScalarMappable method), 972
set_antialiased() (matplotlib.collections.TriMesh method), 1138	set_array() (matplotlib.collections.AsteriskPolygonCollection method), 981
set_antialiased() (matplotlib.lines.Line2D method), 1249	set_array() (matplotlib.collections.BrokenBarHCCollection method), 993
set_antialiased() (matplotlib.patches.Patch method), 1353	set_array() (matplotlib.collections.CircleCollection method), 1005
set_antialiaseds() (matplotlib.collections.AsteriskPolygonCollection method), 981	set_array() (matplotlib.collections.Collection method), 1018
set_antialiaseds() (matplotlib.collections.BrokenBarHCCollection method), 993	set_array() (matplotlib.collections.EllipseCollection method), 1029
set_antialiaseds() (matplotlib.collections.CircleCollection method), 1005	set_array() (matplotlib.collections.EventCollection method), 1042
set_antialiaseds() (matplotlib.collections.Collection method), 1018	set_array() (matplotlib.collections.LineCollection method), 1055
set_antialiaseds() (matplotlib.collections.PatchCollection method), 1066	set_array() (matplotlib.collections.PatchCollection method), 1066
set_antialiaseds() (matplotlib.collections.PathCollection method), 1078	set_array() (matplotlib.collections.PathCollection method), 1078
set_antialiaseds() (matplotlib.collections.PolyCollection	set_array() (matplotlib.collections.PolyCollection

method), 1090

set_array() (matplotlib.collections.QuadMesh method), 1102

set_array() (matplotlib.collections.RegularPolygonCollection method), 1114

set_array() (matplotlib.collections.StarPolygonCollection method), 1127

set_array() (matplotlib.collections.TriMesh method), 1138

set_array() (matplotlib.image.NonUniformImage method), 1232

set_array() (matplotlib.image.PcolorImage method), 1233

set_arrowstyle() (matplotlib.patches.FancyArrowPatch method), 1347

set_aspect() (matplotlib.axes.Axes method), 754

set_aspect() (mpl_toolkits.axes_grid.axes_divider.Divider method), 1798

set_autoscale_on() (matplotlib.axes.Axes method), 753

set_autoscale_on() (mpl_toolkits.mplot3d.axes3d.Axes3D method), 1861

set_autoscalex_on() (matplotlib.axes.Axes method), 754

set_autoscaley_on() (matplotlib.axes.Axes method), 754

set_autoscalez_on() (mpl_toolkits.mplot3d.axes3d.Axes3D method), 1861

set_axes() (matplotlib.artist.Artist method), 547

set_axes() (matplotlib.axes.Axes method), 785

set_axes() (matplotlib.axis.Axis method), 885

set_axes() (matplotlib.axis.Tick method), 845

set_axes() (matplotlib.axis.XAxis method), 896

set_axes() (matplotlib.axis.XTick method), 857

set_axes() (matplotlib.axis.YAxis method), 907

set_axes() (matplotlib.axis.YTick method), 868

set_axes() (matplotlib.collections.AsteriskPolygonCollection method), 982

set_axes() (matplotlib.collections.BrokenBarHCollection method), 993

set_axes() (matplotlib.collections.CircleCollection method), 1005

set_axes() (matplotlib.collections.Collection method), 1018

set_axes() (matplotlib.collections.EllipseCollection method), 1029

set_axes() (matplotlib.collections.EventCollection method), 1042

set_axes() (matplotlib.collections.LineCollection method), 1055

set_axes() (matplotlib.collections.PatchCollection method), 1066

set_axes() (matplotlib.collections.PathCollection method), 1078

set_axes() (matplotlib.collections.PolyCollection method), 1090

set_axes() (matplotlib.collections.QuadMesh method), 1102

set_axes() (matplotlib.collections.RegularPolygonCollection method), 1115

set_axes() (matplotlib.collections.StarPolygonCollection method), 1127

set_axes() (matplotlib.collections.TriMesh method), 1138

set_axis_locator() (matplotlib.axes.Axes method), 768

set_axis() (matplotlib.dates.AutoDateLocator method), 1173

set_axis() (matplotlib.dates.MicrosecondLocator method), 1174

set_axis() (matplotlib.ticker.TickHelper method), 1637

set_axis_bgcolor() (matplotlib.axes.Axes method), 736

set_axis_direction() (mpl_toolkits.axes_grid.axis_artist.AxisArtist method), 1802

set_axis_direction() (mpl_toolkits.axes_grid.axis_artist.AxisLabel method), 1804

set_axis_direction() (mpl_toolkits.axes_grid.axis_artist.TickLabels method), 1804

set_axis_off() (matplotlib.axes.Axes method), 733

set_axis_off() (mpl_toolkits.mplot3d.axes3d.Axes3D method), 1862

set_axis_on() (matplotlib.axes.Axes method), 733

set_axis_on() (mpl_toolkits.mplot3d.axes3d.Axes3D method), 1862

set_axisbelow() (matplotlib.axes.Axes method), 734

set_axisbelow() (mpl_toolkits.mplot3d.axes3d.Axes3D method), 1862

set_axislabel_direction() (mpl_toolkits.axes_grid.axis_artist.AxisArtist method), 1802

set_axisline_style() (mpl_toolkits.axes_grid.axis_artist.AxisArtist method), 1803

set_backgroundcolor() (matplotlib.text.Text method), 1042

- method), 1628
- set_bad() (matplotlib.colors.Colormap method), 1153
- set_bbox() (matplotlib.text.Text method), 1628
- set_bbox_to_anchor() (matplotlib.legend.Legend method), 1240
- set_bbox_to_anchor() (matplotlib.offsetbox.AnchoredOffsetbox method), 1314
- set_bounds() (matplotlib.patches.FancyBboxPatch method), 1349
- set_bounds() (matplotlib.patches.Rectangle method), 1359
- set_bounds() (matplotlib.spines.Spine method), 1617
- set_bounds() (matplotlib.ticker.TickHelper method), 1637
- set_boxstyle() (matplotlib.patches.FancyBboxPatch method), 1349
- set_c() (matplotlib.lines.Line2D method), 1249
- set_canvas() (matplotlib.figure.Figure method), 1201
- set_canvas_size() (matplotlib.mathtext.Fonts method), 1266
- set_canvas_size() (matplotlib.mathtext.MathtextBackend method), 1269
- set_canvas_size() (matplotlib.mathtext.MathtextBackendAgg method), 1269
- set_capstyle() (matplotlib.backend_bases.GraphicsContextBase method), 921
- set_capstyle() (matplotlib.patches.Patch method), 1353
- set_center() (matplotlib.patches.Wedge method), 1363
- set_child() (matplotlib.offsetbox.AnchoredOffsetbox method), 1314
- set_children() (matplotlib.transforms.TransformNode method), 1651
- set_clim() (matplotlib.cm.ScalarMappable method), 972
- set_clim() (matplotlib.collections.AsteriskPolygonCollection method), 982
- set_clim() (matplotlib.collections.BrokenBarHCollection method), 994
- set_clim() (matplotlib.collections.CircleCollection method), 1006
- set_clim() (matplotlib.collections.Collection method), 1018
- set_clim() (matplotlib.collections.EllipseCollection method), 1029
- set_clim() (matplotlib.collections.EventCollection method), 1042
- set_clim() (matplotlib.collections.LineCollection method), 1055
- set_clim() (matplotlib.collections.PatchCollection method), 1067
- set_clim() (matplotlib.collections.PathCollection method), 1078
- set_clim() (matplotlib.collections.PolyCollection method), 1090
- set_clim() (matplotlib.collections.QuadMesh method), 1102
- set_clim() (matplotlib.collections.RegularPolyCollection method), 1115
- set_clim() (matplotlib.collections.StarPolygonCollection method), 1127
- set_clim() (matplotlib.collections.TriMesh method), 1139
- set_clip_box() (matplotlib.artist.Artist method), 541
- set_clip_box() (matplotlib.axes.Axes method), 780
- set_clip_box() (matplotlib.axis.Axis method), 885
- set_clip_box() (matplotlib.axis.Tick method), 845
- set_clip_box() (matplotlib.axis.XAxis method), 897
- set_clip_box() (matplotlib.axis.XTick method), 857
- set_clip_box() (matplotlib.axis.YAxis method), 908
- set_clip_box() (matplotlib.axis.YTick method), 868
- set_clip_box() (matplotlib.collections.AsteriskPolygonCollection method), 982
- set_clip_box() (matplotlib.collections.BrokenBarHCollection method), 994
- set_clip_box() (matplotlib.collections.CircleCollection method), 1006
- set_clip_box() (matplotlib.collections.Collection method), 1018
- set_clip_box() (matplotlib.collections.EllipseCollection method), 1030
- set_clip_box() (matplotlib.collections.EventCollection method), 1042

- `set_clip_box()` (matplotlib.collections.LineCollection method), 1055
`set_clip_box()` (matplotlib.collections.PatchCollection method), 1067
`set_clip_box()` (matplotlib.collections.PathCollection method), 1078
`set_clip_box()` (matplotlib.collections.PolyCollection method), 1090
`set_clip_box()` (matplotlib.collections.QuadMesh method), 1103
`set_clip_box()` (matplotlib.collections.RegularPolyCollection method), 1115
`set_clip_box()` (matplotlib.collections.StarPolygonCollection method), 1127
`set_clip_box()` (matplotlib.collections.TriMesh method), 1139
`set_clip_box()` (matplotlib.text.Text method), 1628
`set_clip_on()` (matplotlib.artist.Artist method), 541
`set_clip_on()` (matplotlib.axes.Axes method), 780
`set_clip_on()` (matplotlib.axis.Axis method), 885
`set_clip_on()` (matplotlib.axis.Tick method), 846
`set_clip_on()` (matplotlib.axis.XAxis method), 897
`set_clip_on()` (matplotlib.axis.XTick method), 857
`set_clip_on()` (matplotlib.axis.YAxis method), 908
`set_clip_on()` (matplotlib.axis.YTick method), 868
`set_clip_on()` (matplotlib.collections.AsteriskPolygonCollection method), 982
`set_clip_on()` (matplotlib.collections.BrokenBarHCollection method), 994
`set_clip_on()` (matplotlib.collections.CircleCollection method), 1006
`set_clip_on()` (matplotlib.collections.Collection method), 1018
`set_clip_on()` (matplotlib.collections.EllipseCollection method), 1030
`set_clip_on()` (matplotlib.collections.EventCollection method), 1043
`set_clip_on()` (matplotlib.collections.LineCollection method), 1055
`set_clip_on()` (matplotlib.collections.PatchCollection method), 1067
`set_clip_on()` (matplotlib.collections.PathCollection method), 1079
`set_clip_on()` (matplotlib.collections.PolyCollection method), 1091
`set_clip_on()` (matplotlib.collections.QuadMesh method), 1103
`set_clip_on()` (matplotlib.collections.RegularPolyCollection method), 1115
`set_clip_on()` (matplotlib.collections.StarPolygonCollection method), 1127
`set_clip_on()` (matplotlib.collections.TriMesh method), 1139
`set_clip_on()` (matplotlib.text.Text method), 1628
`set_clip_path()` (matplotlib.artist.Artist method), 541
`set_clip_path()` (matplotlib.axes.Axes method), 780
`set_clip_path()` (matplotlib.axis.Axis method), 886
`set_clip_path()` (matplotlib.axis.Tick method), 846
`set_clip_path()` (matplotlib.axis.XAxis method), 897
`set_clip_path()` (matplotlib.axis.XTick method), 857
`set_clip_path()` (matplotlib.axis.YAxis method), 908
`set_clip_path()` (matplotlib.axis.YTick method), 869
`set_clip_path()` (matplotlib.backend_bases.GraphicsContextBase method), 921
`set_clip_path()` (matplotlib.collections.AsteriskPolygonCollection method), 982
`set_clip_path()` (matplotlib.collections.BrokenBarHCollection method), 994
`set_clip_path()` (matplotlib.collections.CircleCollection method), 1006
`set_clip_path()` (matplotlib.collections.Collection method), 1018
`set_clip_path()` (matplotlib.collections.EllipseCollection method), 1030
`set_clip_path()` (matplotlib.collections.EventCollection method), 1043

`set_clip_path()` (matplotlib.collections.LineCollection method), 1055
`set_clip_path()` (matplotlib.collections.PatchCollection method), 1067
`set_clip_path()` (matplotlib.collections.PathCollection method), 1079
`set_clip_path()` (matplotlib.collections.PolyCollection method), 1091
`set_clip_path()` (matplotlib.collections.QuadMesh method), 1103
`set_clip_path()` (matplotlib.collections.RegularPolyCollection method), 1115
`set_clip_path()` (matplotlib.collections.StarPolygonCollection method), 1127
`set_clip_path()` (matplotlib.collections.TriMesh method), 1139
`set_clip_path()` (matplotlib.text.Text method), 1628
`set_clip_rectangle()` (matplotlib.backend_bases.GraphicsContextBase method), 921
`set_closed()` (matplotlib.patches.Polygon method), 1358
`set_cmap()` (in module matplotlib.pyplot), 1551
`set_cmap()` (matplotlib.cm.ScalarMappable method), 972
`set_cmap()` (matplotlib.collections.AsteriskPolygonCollection method), 982
`set_cmap()` (matplotlib.collections.BrokenBarHCollection method), 994
`set_cmap()` (matplotlib.collections.CircleCollection method), 1006
`set_cmap()` (matplotlib.collections.Collection method), 1018
`set_cmap()` (matplotlib.collections.EllipseCollection method), 1030
`set_cmap()` (matplotlib.collections.EventCollection method), 1043
`set_cmap()` (matplotlib.collections.LineCollection method), 1056
`set_cmap()` (matplotlib.collections.PatchCollection method), 1067
`set_cmap()` (matplotlib.collections.PathCollection method), 1079
`set_cmap()` (matplotlib.collections.PolyCollection method), 1091
`set_cmap()` (matplotlib.collections.QuadMesh method), 1103
`set_cmap()` (matplotlib.collections.RegularPolyCollection method), 1115
`set_cmap()` (matplotlib.collections.StarPolygonCollection method), 1128
`set_cmap()` (matplotlib.collections.TriMesh method), 1139
`set_color()` (matplotlib.lines.Line2D method), 1249
`set_color()` (matplotlib.patches.Patch method), 1353
`set_color()` (matplotlib.spines.Spine method), 1617
`set_color()` (matplotlib.text.Text method), 1629
`set_color_cycle()` (matplotlib.axes.Axes method), 737
`set_connectionstyle()` (mat-

- plotlib.patches.FancyArrowPatch method), 1347
- set_contains() (matplotlib.artist.Artist method), 539
- set_contains() (matplotlib.axes.Axes method), 774
- set_contains() (matplotlib.axis.Axis method), 886
- set_contains() (matplotlib.axis.Tick method), 846
- set_contains() (matplotlib.axis.XAxis method), 897
- set_contains() (matplotlib.axis.XTick method), 858
- set_contains() (matplotlib.axis.YAxis method), 908
- set_contains() (matplotlib.axis.YTick method), 869
- set_contains() (matplotlib.collections.AsteriskPolygonCollection method), 982
- set_contains() (matplotlib.collections.BrokenBarHCollection method), 994
- set_contains() (matplotlib.collections.CircleCollection method), 1006
- set_contains() (matplotlib.collections.Collection method), 1019
- set_contains() (matplotlib.collections.EllipseCollection method), 1030
- set_contains() (matplotlib.collections.EventCollection method), 1043
- set_contains() (matplotlib.collections.LineCollection method), 1056
- set_contains() (matplotlib.collections.PatchCollection method), 1067
- set_contains() (matplotlib.collections.PathCollection method), 1079
- set_contains() (matplotlib.collections.PolyCollection method), 1091
- set_contains() (matplotlib.collections.QuadMesh method), 1103
- set_contains() (matplotlib.collections.RegularPolyCollection method), 1115
- set_contains() (matplotlib.collections.StarPolygonCollection method), 1128
- set_contains() (matplotlib.collections.TriMesh method), 1139
- set_cursor() (matplotlib.backend_bases.NavigationToolbar2 method), 926
- set_cursor() (matplotlib.backend_tools.SetCursorBase method), 938
- set_cursor_props() (matplotlib.axes.Axes method), 775
- set_dash_capstyle() (matplotlib.lines.Line2D method), 1249
- set_dash_joinstyle() (matplotlib.lines.Line2D method), 1249
- set_dashdirection() (matplotlib.text.TextWithDash method), 1633
- set_dashes() (matplotlib.backend_bases.GraphicsContextBase method), 921
- set_dashes() (matplotlib.collections.AsteriskPolygonCollection method), 983
- set_dashes() (matplotlib.collections.BrokenBarHCollection method), 995
- set_dashes() (matplotlib.collections.CircleCollection method), 1007
- set_dashes() (matplotlib.collections.Collection method), 1019
- set_dashes() (matplotlib.collections.EllipseCollection method), 1030
- set_dashes() (matplotlib.collections.EventCollection method), 1043
- set_dashes() (matplotlib.collections.LineCollection method), 1056
- set_dashes() (matplotlib.collections.PatchCollection method), 1068
- set_dashes() (matplotlib.collections.PathCollection method), 1079
- set_dashes() (matplotlib.collections.PolyCollection method), 1091
- set_dashes() (matplotlib.collections.QuadMesh method), 1103
- set_dashes() (matplotlib.collections.RegularPolyCollection method), 1116
- set_dashes() (matplotlib.collections.StarPolygonCollection method), 1128
- set_dashes() (matplotlib.collections.TriMesh method), 1140
- set_dashes() (matplotlib.lines.Line2D method), 1249
- set_dashlength() (matplotlib.text.TextWithDash method), 1633
- set_dashpad() (matplotlib.text.TextWithDash method), 1633
- set_dashpush() (matplotlib.text.TextWithDash method), 1633

- method), 1633
- set_dashrotation() (matplotlib.text.TextWithDash method), 1633
- set_data() (matplotlib.image.FigureImage method), 1232
- set_data() (matplotlib.image.NonUniformImage method), 1233
- set_data() (matplotlib.image.PcolorImage method), 1233
- set_data() (matplotlib.lines.Line2D method), 1249
- set_data() (matplotlib.offsetbox.OffsetImage method), 1320
- set_data() (matplotlib.widgets.ToolHandles method), 1701
- set_data_interval() (matplotlib.axis.Axis method), 801
- set_data_interval() (matplotlib.axis.XAxis method), 829
- set_data_interval() (matplotlib.axis.YAxis method), 820
- set_data_interval() (matplotlib.dates.MicrosecondLocator method), 1174
- set_data_interval() (matplotlib.ticker.TickHelper method), 1637
- set_default_handler_map() (matplotlib.legend.Legend class method), 1241
- set_default_intervals() (matplotlib.axis.Axis method), 806
- set_default_intervals() (matplotlib.axis.XAxis method), 830
- set_default_intervals() (matplotlib.axis.YAxis method), 820
- set_default_locators_and_formatters() (matplotlib.scale.LinearScale method), 1607
- set_default_locators_and_formatters() (matplotlib.scale.LogitScale method), 1611
- set_default_locators_and_formatters() (matplotlib.scale.LogScale method), 1609
- set_default_locators_and_formatters() (matplotlib.scale.ScaleBase method), 1612
- set_default_locators_and_formatters() (matplotlib.scale.SymmetricalLogScale method), 1613
- set_default_weight() (matplotlib.font_manager.FontManager method), 1221
- set_dpi() (matplotlib.figure.Figure method), 1201
- set_dpi_cor() (matplotlib.patches.FancyArrowPatch method), 1347
- set_drawstyle() (matplotlib.lines.Line2D method), 1249
- set_ec() (matplotlib.patches.Patch method), 1353
- set_edgecolor() (matplotlib.collections.AsteriskPolygonCollection method), 983
- set_edgecolor() (matplotlib.collections.BrokenBarHCollection method), 995
- set_edgecolor() (matplotlib.collections.CircleCollection method), 1007
- set_edgecolor() (matplotlib.collections.Collection method), 1019
- set_edgecolor() (matplotlib.collections.EllipseCollection method), 1030
- set_edgecolor() (matplotlib.collections.EventCollection method), 1043
- set_edgecolor() (matplotlib.collections.LineCollection method), 1056
- set_edgecolor() (matplotlib.collections.PatchCollection method), 1068
- set_edgecolor() (matplotlib.collections.PathCollection method), 1079
- set_edgecolor() (matplotlib.collections.PolyCollection method), 1091
- set_edgecolor() (matplotlib.collections.QuadMesh method), 1103
- set_edgecolor() (matplotlib.collections.RegularPolyCollection method), 1116
- set_edgecolor() (matplotlib.collections.StarPolygonCollection method), 1128
- set_edgecolor() (matplotlib.collections.TriMesh method), 1140
- set_edgecolor() (matplotlib.figure.Figure method), 1201
- set_edgecolor() (matplotlib.patches.Patch method),

1353

set_edgecolor() (mpl_toolkits.mplot3d.art3d.Poly3DCollection method), 1874

set_edgecolor() (matplotlib.collections.AsteriskPolygonCollection method), 983

set_edgecolor() (matplotlib.collections.BrokenBarHCollection method), 995

set_edgecolor() (matplotlib.collections.CircleCollection method), 1007

set_edgecolor() (matplotlib.collections.Collection method), 1019

set_edgecolor() (matplotlib.collections.EllipseCollection method), 1031

set_edgecolor() (matplotlib.collections.EventCollection method), 1044

set_edgecolor() (matplotlib.collections.LineCollection method), 1056

set_edgecolor() (matplotlib.collections.PatchCollection method), 1068

set_edgecolor() (matplotlib.collections.PathCollection method), 1080

set_edgecolor() (matplotlib.collections.PolyCollection method), 1092

set_edgecolor() (matplotlib.collections.QuadMesh method), 1104

set_edgecolor() (matplotlib.collections.RegularPolyCollection method), 1116

set_edgecolor() (matplotlib.collections.StarPolygonCollection method), 1128

set_edgecolor() (matplotlib.collections.TriMesh method), 1140

set_edgecolor() (mpl_toolkits.mplot3d.art3d.Poly3DCollection method), 1874

set_extent() (matplotlib.image.AxesImage method), 1231

set_facecolor() (matplotlib.axes.Axes method), 736

set_facecolor() (matplotlib.collections.AsteriskPolygonCollection method), 983

set_facecolor() (matplotlib.collections.BrokenBarHCollection method), 995

set_facecolor() (matplotlib.collections.CircleCollection method), 1007

set_facecolor() (matplotlib.collections.Collection method), 1019

set_facecolor() (matplotlib.collections.EllipseCollection method), 1031

set_facecolor() (matplotlib.collections.EventCollection method), 1044

set_facecolor() (matplotlib.collections.LineCollection method), 1056

set_facecolor() (matplotlib.collections.PatchCollection method), 1068

set_facecolor() (matplotlib.collections.PathCollection method), 1080

set_facecolor() (matplotlib.collections.PolyCollection method), 1092

set_facecolor() (matplotlib.collections.QuadMesh method), 1104

set_facecolor() (matplotlib.collections.RegularPolyCollection method), 1116

set_facecolor() (matplotlib.collections.StarPolygonCollection method), 1128

set_facecolor() (matplotlib.collections.TriMesh method), 1140

set_facecolor() (matplotlib.figure.Figure method), 1201

set_facecolor() (matplotlib.patches.Patch method), 1354

set_facecolor() (mpl_toolkits.mplot3d.art3d.Poly3DCollection method), 1874

set_facecolors() (matplotlib.collections.AsteriskPolygonCollection method), 983

set_facecolors() (matplotlib.collections.BrokenBarHCollection method), 995

set_facecolors() (matplotlib.collections.CircleCollection method), 1007

set_facecolors() (matplotlib.collections.Collection method), 1019

set_facecolors() (matplotlib.collections.EllipseCollection method), 1031

set_facecolors() (matplotlib.collections.EventCollection method), 1044

set_facecolors() (matplotlib.collections.LineCollection method), 1056

set_facecolors() (matplotlib.collections.PatchCollection method), 1068

set_facecolors() (matplotlib.collections.PathCollection method), 1080

set_facecolors() (matplotlib.collections.PolyCollection method), 1092

set_facecolors() (matplotlib.collections.QuadMesh method), 1104

set_facecolors() (matplotlib.collections.RegularPolyCollection method), 1116

set_facecolors() (matplotlib.collections.StarPolygonCollection method), 1128

set_facecolors() (matplotlib.collections.TriMesh method), 1140

set_facecolors() (matplotlib.figure.Figure method), 1201

set_facecolors() (matplotlib.patches.Patch method), 1354

set_facecolors() (mpl_toolkits.mplot3d.art3d.Poly3DCollection method), 1874

plotlib.collections.BrokenBarHCollection method), 995
 set_facecolors() (matplotlib.collections.CircleCollection method), 1007
 set_facecolors() (matplotlib.collections.Collection method), 1019
 set_facecolors() (matplotlib.collections.EllipseCollection method), 1031
 set_facecolors() (matplotlib.collections.EventCollection method), 1044
 set_facecolors() (matplotlib.collections.LineCollection method), 1056
 set_facecolors() (matplotlib.collections.PatchCollection method), 1068
 set_facecolors() (matplotlib.collections.PathCollection method), 1080
 set_facecolors() (matplotlib.collections.PolyCollection method), 1092
 set_facecolors() (matplotlib.collections.QuadMesh method), 1104
 set_facecolors() (matplotlib.collections.RegularPolyCollection method), 1116
 set_facecolors() (matplotlib.collections.StarPolygonCollection method), 1128
 set_facecolors() (matplotlib.collections.TriMesh method), 1140
 set_facecolors() (mpl_toolkits.mplot3d.art3d.Poly3DCollection method), 1874
 set_family() (matplotlib.font_manager.FontProperties method), 1222
 set_family() (matplotlib.text.Text method), 1629
 set_fc() (matplotlib.axes.Axes method), 736
 set_fc() (matplotlib.patches.Patch method), 1354
 set_figheight() (matplotlib.figure.Figure method), 1201
 set_figure() (matplotlib.artist.Artist method), 547
 set_figure() (matplotlib.axes.Axes method), 785
 set_figure() (matplotlib.axis.Axis method), 886
 set_figure() (matplotlib.axis.Tick method), 846
 set_figure() (matplotlib.axis.XAxis method), 897
 set_figure() (matplotlib.axis.XTick method), 858
 set_figure() (matplotlib.axis.YAxis method), 908
 set_figure() (matplotlib.axis.YTick method), 869
 set_figure() (matplotlib.collections.AsteriskPolygonCollection method), 983
 set_figure() (matplotlib.collections.BrokenBarHCollection method), 995
 set_figure() (matplotlib.collections.CircleCollection method), 1007
 set_figure() (matplotlib.collections.Collection method), 1019
 set_figure() (matplotlib.collections.EllipseCollection method), 1031
 set_figure() (matplotlib.collections.EventCollection method), 1044
 set_figure() (matplotlib.collections.LineCollection method), 1056
 set_figure() (matplotlib.collections.PatchCollection method), 1068
 set_figure() (matplotlib.collections.PathCollection method), 1080
 set_figure() (matplotlib.collections.PolyCollection method), 1092
 set_figure() (matplotlib.collections.QuadMesh method), 1104
 set_figure() (matplotlib.collections.RegularPolyCollection method), 1116
 set_figure() (matplotlib.collections.StarPolygonCollection method), 1128
 set_figure() (matplotlib.collections.TriMesh method), 1140
 set_figure() (matplotlib.offsetbox.AnnotationBbox method), 1315
 set_figure() (matplotlib.offsetbox.OffsetBox method), 1624
 set_figure() (matplotlib.text.Annotation method), 1633
 set_figwidth() (matplotlib.figure.Figure method), 1201
 set_file() (matplotlib.font_manager.FontProperties method), 1222
 set_fill() (matplotlib.patches.Patch method), 1354
 set_fillstyle() (matplotlib.lines.Line2D method), 1250
 set_fillstyle() (matplotlib.markers.MarkerStyle

- method), 1257
- set_filtnorm() (matplotlib.image.NonUniformImage method), 1233
- set_filterrad() (matplotlib.image.NonUniformImage method), 1233
- set_font_properties() (matplotlib.text.Text method), 1629
- set_fontconfig_pattern() (matplotlib.font_manager.FontProperties method), 1223
- set_fontname() (matplotlib.text.Text method), 1629
- set_fontproperties() (matplotlib.text.Text method), 1629
- set_fontsize() (matplotlib.offsetbox.AnnotationBbox method), 1315
- set_fontsize() (matplotlib.text.Text method), 1629
- set_fontstretch() (matplotlib.text.Text method), 1629
- set_fontstyle() (matplotlib.text.Text method), 1629
- set_fontvariant() (matplotlib.text.Text method), 1629
- set_fontweight() (matplotlib.text.Text method), 1629
- set_foreground() (matplotlib.backend_bases.GraphicsContextBase method), 922
- set_frame_on() (matplotlib.axes.Axes method), 733
- set_frame_on() (matplotlib.legend.Legend method), 1241
- set_frame_on() (mpl_toolkits.mplot3d.axes3d.Axes3D method), 1862
- set_frameon() (matplotlib.figure.Figure method), 1202
- set_gamma() (matplotlib.colors.LinearSegmentedColormap method), 1159
- set_gid() (matplotlib.artist.Artist method), 550
- set_gid() (matplotlib.axes.Axes method), 780
- set_gid() (matplotlib.axis.Axis method), 886
- set_gid() (matplotlib.axis.Tick method), 847
- set_gid() (matplotlib.axis.XAxis method), 897
- set_gid() (matplotlib.axis.XTick method), 858
- set_gid() (matplotlib.axis.YAxis method), 909
- set_gid() (matplotlib.axis.YTick method), 869
- set_gid() (matplotlib.backend_bases.GraphicsContextBase method), 922
- set_gid() (matplotlib.collections.AsteriskPolygonCollection method), 983
- set_gid() (matplotlib.collections.BrokenBarHCollection method), 995
- set_gid() (matplotlib.collections.CircleCollection method), 1007
- set_gid() (matplotlib.collections.Collection method), 1019
- set_gid() (matplotlib.collections.EllipseCollection method), 1031
- set_gid() (matplotlib.collections.EventCollection method), 1044
- set_gid() (matplotlib.collections.LineCollection method), 1057
- set_gid() (matplotlib.collections.PatchCollection method), 1068
- set_gid() (matplotlib.collections.PathCollection method), 1080
- set_gid() (matplotlib.collections.PolyCollection method), 1092
- set_gid() (matplotlib.collections.QuadMesh method), 1104
- set_gid() (matplotlib.collections.RegularPolyCollection method), 1116
- set_gid() (matplotlib.collections.StarPolygonCollection method), 1129
- set_gid() (matplotlib.collections.TriMesh method), 1140
- set_graylevel() (matplotlib.backend_bases.GraphicsContextBase method), 922
- set_ha() (matplotlib.text.Text method), 1629
- set_hatch() (matplotlib.backend_bases.GraphicsContextBase method), 922
- set_hatch() (matplotlib.collections.AsteriskPolygonCollection method), 983
- set_hatch() (matplotlib.collections.BrokenBarHCollection method), 995
- set_hatch() (matplotlib.collections.CircleCollection method), 1007
- set_hatch() (matplotlib.collections.Collection method), 1019
- set_hatch() (matplotlib.collections.EllipseCollection method), 1031
- set_hatch() (matplotlib.collections.EventCollection method), 1044
- set_hatch() (matplotlib.collections.LineCollection method), 1057
- set_hatch() (matplotlib.collections.PatchCollection method), 1068
- set_hatch() (matplotlib.collections.PathCollection method), 1080

set_hatch() (matplotlib.collections.PolyCollection method), 1092
 set_hatch() (matplotlib.collections.QuadMesh method), 1104
 set_hatch() (matplotlib.collections.RegularPolyCollection method), 1116
 set_hatch() (matplotlib.collections.StarPolygonCollection method), 1129
 set_hatch() (matplotlib.collections.TriMesh method), 1140
 set_hatch() (matplotlib.patches.Patch method), 1354
 set_hatch_color() (matplotlib.backend_bases.GraphicsContextBase method), 922
 set_height() (matplotlib.offsetbox.OffsetBox method), 1320
 set_height() (matplotlib.patches.FancyBboxPatch method), 1350
 set_height() (matplotlib.patches.Rectangle method), 1359
 set_height_ratios() (matplotlib.gridspec.GridSpecBase method), 1228
 set_history_buttons() (matplotlib.backend_bases.NavigationToolbar2 method), 926
 set_horizontal() (mpl_toolkits.axes_grid.axes_divider.Divider method), 1798
 set_horizontalalignment() (matplotlib.text.Text method), 1629
 set_interpolation() (matplotlib.image.NonUniformImage method), 1233
 set_joinstyle() (matplotlib.backend_bases.GraphicsContextBase method), 922
 set_joinstyle() (matplotlib.patches.Patch method), 1354
 set_label() (matplotlib.artist.Artist method), 550
 set_label() (matplotlib.axes.Axes method), 781
 set_label() (matplotlib.axis.Axis method), 886
 set_label() (matplotlib.axis.Tick method), 847
 set_label() (matplotlib.axis.XAxis method), 898
 set_label() (matplotlib.axis.XTick method), 858
 set_label() (matplotlib.axis.YAxis method), 909
 set_label() (matplotlib.axis.YTick method), 869
 set_label() (matplotlib.collections.AsteriskPolygonCollection method), 984
 set_label() (matplotlib.collections.BrokenBarHCollection method), 996
 set_label() (matplotlib.collections.CircleCollection method), 1008
 set_label() (matplotlib.collections.Collection method), 1020
 set_label() (matplotlib.collections.EllipseCollection method), 1032
 set_label() (matplotlib.collections.EventCollection method), 1044
 set_label() (matplotlib.collections.LineCollection method), 1057
 set_label() (matplotlib.collections.PatchCollection method), 1069
 set_label() (matplotlib.collections.PathCollection method), 1080
 set_label() (matplotlib.collections.PolyCollection method), 1092
 set_label() (matplotlib.collections.QuadMesh method), 1105
 set_label() (matplotlib.collections.RegularPolyCollection method), 1117
 set_label() (matplotlib.collections.StarPolygonCollection method), 1129
 set_label() (matplotlib.collections.TriMesh method), 1141
 set_label() (matplotlib.colorbar.ColorbarBase method), 1147
 set_label() (matplotlib.container.Container method), 1165
 set_label() (mpl_toolkits.axes_grid.axis_artist.AxisArtist method), 1803
 set_label1() (matplotlib.axis.Tick method), 809
 set_label1() (matplotlib.axis.XTick method), 811
 set_label1() (matplotlib.axis.YTick method), 813
 set_label2() (matplotlib.axis.Tick method), 809
 set_label2() (matplotlib.axis.XTick method), 811
 set_label2() (matplotlib.axis.YTick method), 813
 set_label_coords() (matplotlib.axis.Axis method), 796
 set_label_coords() (matplotlib.axis.XAxis method), 830
 set_label_coords() (matplotlib.axis.YAxis method), 820
 set_label_position() (matplotlib.axis.Axis method), 797
 set_label_position() (matplotlib.axis.XAxis method), 830

set_label_position() (matplotlib.axis.YAxis method), 820
 set_label_text() (matplotlib.axis.Axis method), 797
 set_label_text() (matplotlib.axis.XAxis method), 830
 set_label_text() (matplotlib.axis.YAxis method), 821
 set_linelength() (matplotlib.collections.EventCollection method), 1044
 set_lineoffset() (matplotlib.collections.EventCollection method), 1045
 set_linespacing() (matplotlib.text.Text method), 1629
 set_linestyle() (matplotlib.backend_bases.GraphicsContextBase method), 922
 set_linestyle() (matplotlib.collections.AsteriskPolygonCollection method), 984
 set_linestyle() (matplotlib.collections.BrokenBarHCollection method), 996
 set_linestyle() (matplotlib.collections.CircleCollection method), 1008
 set_linestyle() (matplotlib.collections.Collection method), 1020
 set_linestyle() (matplotlib.collections.EllipseCollection method), 1032
 set_linestyle() (matplotlib.collections.EventCollection method), 1045
 set_linestyle() (matplotlib.collections.LineCollection method), 1057
 set_linestyle() (matplotlib.collections.PatchCollection method), 1069
 set_linestyle() (matplotlib.collections.PathCollection method), 1081
 set_linestyle() (matplotlib.collections.PolyCollection method), 1093
 set_linestyle() (matplotlib.collections.QuadMesh method), 1105
 set_linestyle() (matplotlib.collections.RegularPolyCollection method), 1117
 set_linestyle() (matplotlib.collections.StarPolygonCollection method), 1129
 set_linestyle() (matplotlib.collections.TriMesh method), 1141
 set_linestyle() (matplotlib.lines.Line2D method), 1250
 set_linestyle() (matplotlib.patches.Patch method), 1354
 set_linestyles() (matplotlib.collections.AsteriskPolygonCollection method), 984
 set_linestyles() (matplotlib.collections.BrokenBarHCollection method), 996
 set_linestyles() (matplotlib.collections.CircleCollection method), 1008
 set_linestyles() (matplotlib.collections.Collection method), 1020
 set_linestyles() (matplotlib.collections.EllipseCollection method), 1032
 set_linestyles() (matplotlib.collections.EventCollection method), 1045
 set_linestyles() (matplotlib.collections.LineCollection method), 1058
 set_linestyles() (matplotlib.collections.PatchCollection method), 1069
 set_linestyles() (matplotlib.collections.PathCollection method), 1081
 set_linestyles() (matplotlib.collections.PolyCollection method), 1093
 set_linestyles() (matplotlib.collections.QuadMesh method), 1105
 set_linestyles() (matplotlib.collections.RegularPolyCollection method), 1117
 set_linestyles() (matplotlib.collections.StarPolygonCollection

method), 1130

set_linestyles() (matplotlib.collections.TriMesh method), 1141

set_linewidth() (matplotlib.backend_bases.GraphicsContextBase method), 922

set_linewidth() (matplotlib.collections.AsteriskPolygonCollection method), 984

set_linewidth() (matplotlib.collections.BrokenBarHCollection method), 996

set_linewidth() (matplotlib.collections.CircleCollection method), 1008

set_linewidth() (matplotlib.collections.Collection method), 1020

set_linewidth() (matplotlib.collections.EllipseCollection method), 1032

set_linewidth() (matplotlib.collections.EventCollection method), 1045

set_linewidth() (matplotlib.collections.LineCollection method), 1058

set_linewidth() (matplotlib.collections.PatchCollection method), 1069

set_linewidth() (matplotlib.collections.PathCollection method), 1081

set_linewidth() (matplotlib.collections.PolyCollection method), 1093

set_linewidth() (matplotlib.collections.QuadMesh method), 1105

set_linewidth() (matplotlib.collections.RegularPolyCollection method), 1117

set_linewidth() (matplotlib.collections.StarPolygonCollection method), 1130

set_linewidth() (matplotlib.collections.TriMesh method), 1141

set_linewidth() (matplotlib.lines.Line2D method), 1250

set_linewidth() (matplotlib.patches.Patch method), 1355

set_linewidths() (matplotlib.collections.AsteriskPolygonCollection method), 984

set_linewidths() (matplotlib.collections.BrokenBarHCollection method), 996

set_linewidths() (matplotlib.collections.CircleCollection method), 1008

set_linewidths() (matplotlib.collections.Collection method), 1020

set_linewidths() (matplotlib.collections.EllipseCollection method), 1032

set_linewidths() (matplotlib.collections.EventCollection method), 1045

set_linewidths() (matplotlib.collections.LineCollection method), 1058

set_linewidths() (matplotlib.collections.PatchCollection method), 1069

set_linewidths() (matplotlib.collections.PathCollection method), 1081

set_linewidths() (matplotlib.collections.PolyCollection method), 1093

set_linewidths() (matplotlib.collections.QuadMesh method), 1105

set_linewidths() (matplotlib.collections.RegularPolyCollection method), 1117

set_linewidths() (matplotlib.collections.StarPolygonCollection method), 1130

set_linewidths() (matplotlib.collections.TriMesh method), 1141

set_locator() (mpl_toolkits.axes_grid.axes_divider.Divider method), 1798

set_locs() (matplotlib.ticker.Formatter method), 1638

set_locs() (matplotlib.ticker.LogFormatter method), 1641

set_locs() (matplotlib.ticker.ScalarFormatter method), 1639

set_ls() (matplotlib.lines.Line2D method), 1250
 set_ls() (matplotlib.patches.Patch method), 1355
 set_lw() (matplotlib.collections.AsteriskPolygonCollection method), 984
 set_lw() (matplotlib.collections.BrokenBarHCollection method), 996
 set_lw() (matplotlib.collections.CircleCollection method), 1008
 set_lw() (matplotlib.collections.Collection method), 1021
 set_lw() (matplotlib.collections.EllipseCollection method), 1032
 set_lw() (matplotlib.collections.EventCollection method), 1045
 set_lw() (matplotlib.collections.LineCollection method), 1058
 set_lw() (matplotlib.collections.PatchCollection method), 1069
 set_lw() (matplotlib.collections.PathCollection method), 1081
 set_lw() (matplotlib.collections.PolyCollection method), 1093
 set_lw() (matplotlib.collections.QuadMesh method), 1105
 set_lw() (matplotlib.collections.RegularPolyCollection method), 1117
 set_lw() (matplotlib.collections.StarPolygonCollection method), 1130
 set_lw() (matplotlib.collections.TriMesh method), 1141
 set_lw() (matplotlib.lines.Line2D method), 1250
 set_lw() (matplotlib.patches.Patch method), 1355
 set_ma() (matplotlib.text.Text method), 1630
 set_major_formatter() (matplotlib.axis.Axis method), 796
 set_major_formatter() (matplotlib.axis.XAxis method), 830
 set_major_formatter() (matplotlib.axis.YAxis method), 821
 set_major_locator() (matplotlib.axis.Axis method), 796
 set_major_locator() (matplotlib.axis.XAxis method), 830
 set_major_locator() (matplotlib.axis.YAxis method), 821
 set_marker() (matplotlib.lines.Line2D method), 1250
 set_marker() (matplotlib.markers.MarkerStyle method), 1257
 set_marcgedgecolor() (matplotlib.lines.Line2D method), 1251
 set_marcgedgewidth() (matplotlib.lines.Line2D method), 1251
 set_markerfacecolor() (matplotlib.lines.Line2D method), 1251
 set_markerfacecoloralt() (matplotlib.lines.Line2D method), 1251
 set_markersize() (matplotlib.lines.Line2D method), 1251
 set_markevery() (matplotlib.lines.Line2D method), 1251
 set_mask() (matplotlib.tri.Triangulation method), 1672
 set_matrix() (matplotlib.transforms.Affine2D method), 1663
 set_mec() (matplotlib.lines.Line2D method), 1252
 set_message() (matplotlib.backend_bases.NavigationToolbar2 method), 926
 set_message() (matplotlib.backend_bases.StatusbarBase method), 931
 set_mew() (matplotlib.lines.Line2D method), 1252
 set_mfc() (matplotlib.lines.Line2D method), 1252
 set_mfcalt() (matplotlib.lines.Line2D method), 1252
 set_minimumdescent() (matplotlib.offsetbox.TextArea method), 1322
 set_minor_formatter() (matplotlib.axis.Axis method), 796
 set_minor_formatter() (matplotlib.axis.XAxis method), 831
 set_minor_formatter() (matplotlib.axis.YAxis method), 821
 set_minor_locator() (matplotlib.axis.Axis method), 796
 set_minor_locator() (matplotlib.axis.XAxis method), 831
 set_minor_locator() (matplotlib.axis.YAxis method), 821
 set_ms() (matplotlib.lines.Line2D method), 1252
 set_multialignment() (matplotlib.text.Text method), 1630
 set_multilinebaseline() (matplotlib.offsetbox.TextArea method), 1322

set_mutation_aspect() (matplotlib.patches.FancyArrowPatch method), 1347
 set_mutation_aspect() (matplotlib.patches.FancyBboxPatch method), 1350
 set_mutation_scale() (matplotlib.patches.FancyArrowPatch method), 1347
 set_mutation_scale() (matplotlib.patches.FancyBboxPatch method), 1350
 set_name() (matplotlib.font_manager.FontProperties method), 1223
 set_name() (matplotlib.text.Text method), 1630
 set_navigate() (matplotlib.axes.Axes method), 771
 set_navigate_mode() (matplotlib.axes.Axes method), 771
 set_norm() (matplotlib.cm.ScalarMappable method), 972
 set_norm() (matplotlib.collections.AsteriskPolygonCollection method), 984
 set_norm() (matplotlib.collections.BrokenBarHCollection method), 996
 set_norm() (matplotlib.collections.CircleCollection method), 1008
 set_norm() (matplotlib.collections.Collection method), 1021
 set_norm() (matplotlib.collections.EllipseCollection method), 1032
 set_norm() (matplotlib.collections.EventCollection method), 1045
 set_norm() (matplotlib.collections.LineCollection method), 1058
 set_norm() (matplotlib.collections.PatchCollection method), 1069
 set_norm() (matplotlib.collections.PathCollection method), 1081
 set_norm() (matplotlib.collections.PolyCollection method), 1093
 set_norm() (matplotlib.collections.QuadMesh method), 1105
 set_norm() (matplotlib.collections.RegularPolygonCollection method), 1117
 set_norm() (matplotlib.collections.StarPolygonCollection method), 1130
 set_norm() (matplotlib.collections.TriMesh method), 1141
 set_norm() (matplotlib.image.NonUniformImage method), 1233
 set_offset() (matplotlib.offsetbox.AuxTransformBox method), 1316
 set_offset() (matplotlib.offsetbox.DrawingArea method), 1318
 set_offset() (matplotlib.offsetbox.OffsetBox method), 1320
 set_offset() (matplotlib.offsetbox.TextArea method), 1322
 set_offset_position() (matplotlib.axis.YAxis method), 804
 set_offset_position() (matplotlib.collections.AsteriskPolygonCollection method), 985
 set_offset_position() (matplotlib.collections.BrokenBarHCollection method), 996
 set_offset_position() (matplotlib.collections.CircleCollection method), 1008
 set_offset_position() (matplotlib.collections.Collection method), 1021
 set_offset_position() (matplotlib.collections.EllipseCollection method), 1032
 set_offset_position() (matplotlib.collections.EventCollection method), 1045
 set_offset_position() (matplotlib.collections.LineCollection method), 1058
 set_offset_position() (matplotlib.collections.PatchCollection method), 1070
 set_offset_position() (matplotlib.collections.PathCollection method), 1081
 set_offset_position() (matplotlib.collections.PolyCollection method), 1093
 set_offset_position() (matplotlib.collections.QuadMesh method), 1105
 set_offset_position() (matplotlib.collections.RegularPolygonCollection method), 1118

set_offset_position() (matplotlib.collections.StarPolygonCollection method), 1130
 set_offset_position() (matplotlib.collections.TriMesh method), 1142
 set_offset_string() (matplotlib.ticker.FixedFormatter method), 1638
 set_offsets() (matplotlib.collections.AsteriskPolygonCollection method), 985
 set_offsets() (matplotlib.collections.BrokenBarHCollection method), 997
 set_offsets() (matplotlib.collections.CircleCollection method), 1009
 set_offsets() (matplotlib.collections.Collection method), 1021
 set_offsets() (matplotlib.collections.EllipseCollection method), 1032
 set_offsets() (matplotlib.collections.EventCollection method), 1045
 set_offsets() (matplotlib.collections.LineCollection method), 1058
 set_offsets() (matplotlib.collections.PatchCollection method), 1070
 set_offsets() (matplotlib.collections.PathCollection method), 1081
 set_offsets() (matplotlib.collections.PolyCollection method), 1093
 set_offsets() (matplotlib.collections.QuadMesh method), 1105
 set_offsets() (matplotlib.collections.RegularPolyCollection method), 1118
 set_offsets() (matplotlib.collections.StarPolygonCollection method), 1130
 set_offsets() (matplotlib.collections.TriMesh method), 1142
 set_orientation() (matplotlib.collections.EventCollection method), 1046
 set_over() (matplotlib.colors.Colormap method), 1153
 set_pad() (matplotlib.axis.Tick method), 810
 set_pad() (matplotlib.axis.XTick method), 811
 set_pad() (matplotlib.axis.YTick method), 813
 set_pad() (mpl_toolkits.axes_grid.axis_artist.AxisLabel method), 1804
 set_pane_color() (mpl_toolkits.mplot3d.axis3d.Axis method), 1870
 set_pane_pos() (mpl_toolkits.mplot3d.axis3d.Axis method), 1870
 set_params() (matplotlib.ticker.FixedLocator method), 1643
 set_params() (matplotlib.ticker.IndexLocator method), 1643
 set_params() (matplotlib.ticker.LinearLocator method), 1643
 set_params() (matplotlib.ticker.Locator method), 1642
 set_params() (matplotlib.ticker.LogLocator method), 1644
 set_params() (matplotlib.ticker.MaxNLocator method), 1645
 set_params() (matplotlib.ticker.MultipleLocator method), 1644
 set_params() (matplotlib.ticker.SymmetricalLogLocator method), 1646
 set_patch_circle() (matplotlib.spines.Spine method), 1617
 set_patch_line() (matplotlib.spines.Spine method), 1617
 set_patchA() (matplotlib.patches.FancyArrowPatch method), 1347
 set_patchB() (matplotlib.patches.FancyArrowPatch method), 1347
 set_path_effects() (matplotlib.artist.Artist method), 545
 set_path_effects() (matplotlib.axes.Axes method), 782
 set_path_effects() (matplotlib.axis.Axis method), 887
 set_path_effects() (matplotlib.axis.Tick method), 847
 set_path_effects() (matplotlib.axis.XAxis method), 898
 set_path_effects() (matplotlib.axis.XTick method), 858
 set_path_effects() (matplotlib.axis.YAxis method), 909
 set_path_effects() (matplotlib.axis.YTick method), 870
 set_path_effects() (matplotlib.collections.AsteriskPolygonCollection method), 985
 set_path_effects() (matplotlib.collections.BrokenBarHCollection method), 997

method), 997

set_path_effects() (matplotlib.collections.CircleCollection method), 1009

set_path_effects() (matplotlib.collections.Collection method), 1021

set_path_effects() (matplotlib.collections.EllipseCollection method), 1033

set_path_effects() (matplotlib.collections.EventCollection method), 1046

set_path_effects() (matplotlib.collections.LineCollection method), 1058

set_path_effects() (matplotlib.collections.PatchCollection method), 1070

set_path_effects() (matplotlib.collections.PathCollection method), 1081

set_path_effects() (matplotlib.collections.PolyCollection method), 1093

set_path_effects() (matplotlib.collections.QuadMesh method), 1106

set_path_effects() (matplotlib.collections.RegularPolyCollection method), 1118

set_path_effects() (matplotlib.collections.StarPolygonCollection method), 1130

set_path_effects() (matplotlib.collections.TriMesh method), 1142

set_paths() (matplotlib.collections.AsteriskPolygonCollection method), 985

set_paths() (matplotlib.collections.BrokenBarHCollection method), 997

set_paths() (matplotlib.collections.CircleCollection method), 1009

set_paths() (matplotlib.collections.Collection method), 1021

set_paths() (matplotlib.collections.EllipseCollection method), 1033

set_paths() (matplotlib.collections.EventCollection method), 1046

set_paths() (matplotlib.collections.LineCollection method), 1058

set_paths() (matplotlib.collections.PatchCollection method), 1070

set_paths() (matplotlib.collections.PathCollection method), 1082

set_paths() (matplotlib.collections.PolyCollection method), 1094

set_paths() (matplotlib.collections.QuadMesh method), 1106

set_paths() (matplotlib.collections.RegularPolyCollection method), 1118

set_paths() (matplotlib.collections.StarPolygonCollection method), 1130

set_paths() (matplotlib.collections.PatchCollection method), 1070

set_paths() (matplotlib.collections.PathCollection method), 1082

set_paths() (matplotlib.collections.PolyCollection method), 1094

set_paths() (matplotlib.collections.QuadMesh method), 1106

set_paths() (matplotlib.collections.RegularPolyCollection method), 1118

set_paths() (matplotlib.collections.StarPolygonCollection method), 1130

set_picker() (matplotlib.artist.Artist method), 539

set_picker() (matplotlib.axes.Axes method), 774

set_picker() (matplotlib.axis.Axis method), 887

set_picker() (matplotlib.axis.Tick method), 847

set_picker() (matplotlib.axis.XAxis method), 898

set_picker() (matplotlib.axis.XTick method), 858

set_picker() (matplotlib.axis.YAxis method), 909

set_picker() (matplotlib.axis.YTick method), 870

set_picker() (matplotlib.collections.AsteriskPolygonCollection method), 985

set_picker() (matplotlib.collections.BrokenBarHCollection method), 997

set_picker() (matplotlib.collections.CircleCollection method), 1009

set_picker() (matplotlib.collections.Collection method), 1021

set_picker() (matplotlib.collections.EllipseCollection method), 1033

set_picker() (matplotlib.collections.EventCollection method), 1046

set_picker() (matplotlib.collections.LineCollection method), 1058

set_picker() (matplotlib.collections.PatchCollection method), 1070

set_picker() (matplotlib.collections.PathCollection method), 1082

set_picker() (matplotlib.collections.PolyCollection method), 1094

set_picker() (matplotlib.collections.QuadMesh method), 1106

set_picker() (matplotlib.collections.RegularPolyCollection method), 1118

set_picker() (matplotlib.collections.StarPolygonCollection method), 1130

set_picker() (matplotlib.collections.TriMesh method), 1142
 set_picker() (matplotlib.lines.Line2D method), 1252
 set_pickradius() (matplotlib.axis.Axis method), 802
 set_pickradius() (matplotlib.axis.XAxis method), 831
 set_pickradius() (matplotlib.axis.YAxis method), 821
 set_pickradius() (matplotlib.collections.AsteriskPolygonCollection method), 985
 set_pickradius() (matplotlib.collections.BrokenBarHCollection method), 997
 set_pickradius() (matplotlib.collections.CircleCollection method), 1009
 set_pickradius() (matplotlib.collections.Collection method), 1021
 set_pickradius() (matplotlib.collections.EllipseCollection method), 1033
 set_pickradius() (matplotlib.collections.EventCollection method), 1046
 set_pickradius() (matplotlib.collections.LineCollection method), 1059
 set_pickradius() (matplotlib.collections.PatchCollection method), 1070
 set_pickradius() (matplotlib.collections.PathCollection method), 1082
 set_pickradius() (matplotlib.collections.PolyCollection method), 1094
 set_pickradius() (matplotlib.collections.QuadMesh method), 1106
 set_pickradius() (matplotlib.collections.RegularPolyCollection method), 1118
 set_pickradius() (matplotlib.collections.StarPolygonCollection method), 1131
 set_pickradius() (matplotlib.collections.TriMesh method), 1142
 set_pickradius() (matplotlib.lines.Line2D method), 1252
 set_points() (matplotlib.transforms.Bbox method), 1655
 set_position() (matplotlib.axes.Axes method), 768
 set_position() (matplotlib.spines.Spine method), 1617
 set_position() (matplotlib.text.Text method), 1630
 set_position() (matplotlib.text.TextWithDash method), 1634
 set_position() (mpl_toolkits.axes_grid.axes_divider.Divider method), 1798
 set_positions() (matplotlib.collections.EventCollection method), 1046
 set_positions() (matplotlib.patches.FancyArrowPatch method), 1347
 set_powerlimits() (matplotlib.ticker.ScalarFormatter method), 1639
 set_prop_cycle() (matplotlib.axes.Axes method), 736
 set_radius() (matplotlib.patches.Circle method), 1337
 set_radius() (matplotlib.patches.Wedge method), 1363
 set_rasterization_zorder() (matplotlib.axes.Axes method), 777
 set_rasterized() (matplotlib.artist.Artist method), 545
 set_rasterized() (matplotlib.axes.Axes method), 781
 set_rasterized() (matplotlib.axis.Axis method), 887
 set_rasterized() (matplotlib.axis.Tick method), 848
 set_rasterized() (matplotlib.axis.XAxis method), 898
 set_rasterized() (matplotlib.axis.XTick method), 859
 set_rasterized() (matplotlib.axis.YAxis method), 910
 set_rasterized() (matplotlib.axis.YTick method), 870
 set_rasterized() (matplotlib.collections.AsteriskPolygonCollection method), 985
 set_rasterized() (matplotlib.collections.BrokenBarHCollection method), 997
 set_rasterized() (matplotlib.collections.CircleCollection method), 1009
 set_rasterized() (matplotlib.collections.Collection method), 1021
 set_rasterized() (matplotlib.collections.EllipseCollection method), 1033
 set_rasterized() (matplotlib.collections.EventCollection method), 1046
 set_rasterized() (matplotlib.collections.LineCollection method), 1059
 set_rasterized() (matplotlib.collections.PatchCollection method), 1070
 set_rasterized() (matplotlib.collections.PathCollection method), 1082
 set_rasterized() (matplotlib.collections.PolyCollection method), 1094
 set_rasterized() (matplotlib.collections.QuadMesh method), 1106
 set_rasterized() (matplotlib.collections.RegularPolyCollection method), 1118
 set_rasterized() (matplotlib.collections.StarPolygonCollection method), 1131
 set_rasterized() (matplotlib.collections.TriMesh method), 1142
 set_rasterized() (matplotlib.lines.Line2D method), 1252

plotlib.collections.EllipseCollection method), 1033
 set_rasterized() (matplotlib.collections.EventCollection method), 1046
 set_rasterized() (matplotlib.collections.LineCollection method), 1059
 set_rasterized() (matplotlib.collections.PatchCollection method), 1070
 set_rasterized() (matplotlib.collections.PathCollection method), 1082
 set_rasterized() (matplotlib.collections.PolyCollection method), 1094
 set_rasterized() (matplotlib.collections.QuadMesh method), 1106
 set_rasterized() (matplotlib.collections.RegularPolyCollection method), 1118
 set_rasterized() (matplotlib.collections.StarPolygonCollection method), 1131
 set_rasterized() (matplotlib.collections.TriMesh method), 1142
 set_remove_method() (matplotlib.container.Container method), 1165
 set_rgrids() (matplotlib.projections.polar.PolarAxes method), 1382
 set_rlabel_position() (matplotlib.projections.polar.PolarAxes method), 1384
 set_rotate_label() (mpl_toolkits.mplot3d.axis3d.Axis method), 1870
 set_rotation() (matplotlib.text.Text method), 1630
 set_rotation_mode() (matplotlib.text.Text method), 1630
 set_scale() (matplotlib.backend_tools.ToolXScale method), 943
 set_scale() (matplotlib.backend_tools.ToolYScale method), 944
 set_scientific() (matplotlib.ticker.ScalarFormatter method), 1640
 set_segments() (matplotlib.collections.EventCollection method), 1046
 set_segments() (matplotlib.collections.LineCollection method), 1059
 set_segments() (mpl_toolkits.mplot3d.art3d.Line3DCollection method), 1871
 set_size() (matplotlib.font_manager.FontProperties method), 1223
 set_size() (matplotlib.text.Text method), 1630
 set_size_inches() (matplotlib.figure.Figure method), 1202
 set_sizes() (matplotlib.collections.AsteriskPolygonCollection method), 985
 set_sizes() (matplotlib.collections.BrokenBarHCollection method), 997
 set_sizes() (matplotlib.collections.CircleCollection method), 1009
 set_sizes() (matplotlib.collections.PathCollection method), 1082
 set_sizes() (matplotlib.collections.PolyCollection method), 1094
 set_sizes() (matplotlib.collections.RegularPolyCollection method), 1118
 set_sizes() (matplotlib.collections.StarPolygonCollection method), 1131
 set_sketch_params() (matplotlib.artist.Artist method), 544
 set_sketch_params() (matplotlib.axes.Axes method), 781
 set_sketch_params() (matplotlib.axis.Axis method), 887
 set_sketch_params() (matplotlib.axis.Tick method), 848
 set_sketch_params() (matplotlib.axis.XAxis method), 899
 set_sketch_params() (matplotlib.axis.XTick method), 859
 set_sketch_params() (matplotlib.axis.YAxis method), 910
 set_sketch_params() (matplotlib.axis.YTick method), 870
 set_sketch_params() (matplotlib.backend_bases.GraphicsContextBase method), 922
 set_sketch_params() (matplotlib.collections.AsteriskPolygonCollection method), 986
 set_sketch_params() (mat-

- `plotlib.collections.BrokenBarHCollection` method), 998
`set_sketch_params()` (`matplotlib.collections.CircleCollection` method), 1010
`set_sketch_params()` (`matplotlib.collections.Collection` method), 1022
`set_sketch_params()` (`matplotlib.collections.EllipseCollection` method), 1033
`set_sketch_params()` (`matplotlib.collections.EventCollection` method), 1046
`set_sketch_params()` (`matplotlib.collections.LineCollection` method), 1059
`set_sketch_params()` (`matplotlib.collections.PatchCollection` method), 1070
`set_sketch_params()` (`matplotlib.collections.PathCollection` method), 1082
`set_sketch_params()` (`matplotlib.collections.PolyCollection` method), 1094
`set_sketch_params()` (`matplotlib.collections.QuadMesh` method), 1106
`set_sketch_params()` (`matplotlib.collections.RegularPolyCollection` method), 1119
`set_sketch_params()` (`matplotlib.collections.StarPolygonCollection` method), 1131
`set_sketch_params()` (`matplotlib.collections.TriMesh` method), 1142
`set_slant()` (`matplotlib.font_manager.FontProperties` method), 1223
`set_smart_bounds()` (`matplotlib.axis.Axis` method), 806
`set_smart_bounds()` (`matplotlib.axis.XAxis` method), 831
`set_smart_bounds()` (`matplotlib.axis.YAxis` method), 821
`set_smart_bounds()` (`matplotlib.spines.Spine` method), 1617
`set_snap()` (`matplotlib.artist.Artist` method), 544
`set_snap()` (`matplotlib.axes.Axes` method), 782
`set_snap()` (`matplotlib.axis.Axis` method), 888
`set_snap()` (`matplotlib.axis.Tick` method), 848
`set_snap()` (`matplotlib.axis.XAxis` method), 899
`set_snap()` (`matplotlib.axis.XTick` method), 859
`set_snap()` (`matplotlib.axis.YAxis` method), 910
`set_snap()` (`matplotlib.axis.YTick` method), 871
`set_snap()` (`matplotlib.backend_bases.GraphicsContextBase` method), 922
`set_snap()` (`matplotlib.collections.AsteriskPolygonCollection` method), 986
`set_snap()` (`matplotlib.collections.BrokenBarHCollection` method), 998
`set_snap()` (`matplotlib.collections.CircleCollection` method), 1010
`set_snap()` (`matplotlib.collections.Collection` method), 1022
`set_snap()` (`matplotlib.collections.EllipseCollection` method), 1034
`set_snap()` (`matplotlib.collections.EventCollection` method), 1047
`set_snap()` (`matplotlib.collections.LineCollection` method), 1059
`set_snap()` (`matplotlib.collections.PatchCollection` method), 1071
`set_snap()` (`matplotlib.collections.PathCollection` method), 1083
`set_snap()` (`matplotlib.collections.PolyCollection` method), 1095
`set_snap()` (`matplotlib.collections.QuadMesh` method), 1107
`set_snap()` (`matplotlib.collections.RegularPolyCollection` method), 1119
`set_snap()` (`matplotlib.collections.StarPolygonCollection` method), 1131
`set_snap()` (`matplotlib.collections.TriMesh` method), 1143
`set_solid_capstyle()` (`matplotlib.lines.Line2D` method), 1252
`set_solid_joinstyle()` (`matplotlib.lines.Line2D` method), 1252
`set_sort_zpos()` (`mpl_toolkits.mplot3d.art3d.Line3DCollection` method), 1871
`set_sort_zpos()` (`mpl_toolkits.mplot3d.art3d.Patch3DCollection` method), 1872
`set_sort_zpos()` (`mpl_toolkits.mplot3d.art3d.Path3DCollection` method), 1873

set_sort_zpos() (mpl_toolkits.mplot3d.art3d.Poly3DCollections method), 1874
 set_stretch() (matplotlib.font_manager.FontProperties method), 1223
 set_stretch() (matplotlib.text.Text method), 1630
 set_style() (matplotlib.font_manager.FontProperties method), 1223
 set_style() (matplotlib.text.Text method), 1630
 set_subplotspec() (mpl_toolkits.axes_grid.axes_dividers.SubplotLocator method), 1799
 set_text() (matplotlib.offsetbox.TextArea method), 1322
 set_text() (matplotlib.text.Text method), 1630
 set_theta1() (matplotlib.patches.Wedge method), 1363
 set_theta2() (matplotlib.patches.Wedge method), 1363
 set_theta_direction() (matplotlib.projections.polar.PolarAxes method), 1384
 set_theta_offset() (matplotlib.projections.polar.PolarAxes method), 1384
 set_theta_zero_location() (matplotlib.projections.polar.PolarAxes method), 1384
 set_thetagrids() (matplotlib.projections.polar.PolarAxes method), 1384
 set_tick_out() (mpl_toolkits.axes_grid.axis_artist.Ticks method), 1803
 set_tick_params() (matplotlib.axis.Axis method), 800
 set_tick_params() (matplotlib.axis.XAxis method), 831
 set_tick_params() (matplotlib.axis.YAxis method), 822
 set_ticklabel_direction() (mpl_toolkits.axes_grid.axis_artist.AxisArtist method), 1803
 set_ticklabels() (matplotlib.axis.Axis method), 807
 set_ticklabels() (matplotlib.axis.XAxis method), 831
 set_ticklabels() (matplotlib.axis.YAxis method), 822
 set_ticklabels() (matplotlib.colorbar.ColorbarBase method), 1147
 set_ticks() (matplotlib.axis.Axis method), 807
 set_ticks() (matplotlib.axis.XAxis method), 832
 set_ticks() (matplotlib.axis.YAxis method), 822
 set_ticks_position() (matplotlib.axis.XAxis method), 805
 set_ticks_position() (matplotlib.axis.YAxis method), 804
 set_ticksiz() (mpl_toolkits.axes_grid.axis_artist.Ticks method), 1804
 set_title() (matplotlib.figure.Figure method), 1202
 set_title() (matplotlib.axes.Axes method), 743
 set_title() (matplotlib.legend.Legend method), 1241
 set_title() (mpl_toolkits.mplot3d.axes3d.Axes3D method), 1862
 set_top_view() (mpl_toolkits.mplot3d.axes3d.Axes3D method), 1862
 set_transform() (matplotlib.artist.Artist method), 548
 set_transform() (matplotlib.axes.Axes method), 782
 set_transform() (matplotlib.axis.Axis method), 888
 set_transform() (matplotlib.axis.Tick method), 848
 set_transform() (matplotlib.axis.XAxis method), 899
 set_transform() (matplotlib.axis.XTick method), 860
 set_transform() (matplotlib.axis.YAxis method), 910
 set_transform() (matplotlib.axis.YTick method), 871
 set_transform() (matplotlib.collections.AsteriskPolygonCollection method), 986
 set_transform() (matplotlib.collections.BrokenBarHCollection method), 998
 set_transform() (matplotlib.collections.CircleCollection method), 1010
 set_transform() (matplotlib.collections.Collection method), 1022
 set_transform() (matplotlib.collections.EllipseCollection method), 1034
 set_transform() (matplotlib.collections.EventCollection method), 1047
 set_transform() (matplotlib.collections.LineCollection method), 1059
 set_transform() (matplotlib.collections.PatchCollection method), 1071

set_transform() (matplotlib.collections.PathCollection method), 1083
 set_transform() (matplotlib.collections.PolyCollection method), 1095
 set_transform() (matplotlib.collections.QuadMesh method), 1107
 set_transform() (matplotlib.collections.RegularPolyCollection method), 1119
 set_transform() (matplotlib.collections.StarPolygonCollection method), 1132
 set_transform() (matplotlib.collections.TriMesh method), 1143
 set_transform() (matplotlib.lines.Line2D method), 1252
 set_transform() (matplotlib.offsetbox.AuxTransformBox method), 1316
 set_transform() (matplotlib.offsetbox.DrawingArea method), 1318
 set_transform() (matplotlib.offsetbox.TextArea method), 1323
 set_transform() (matplotlib.text.TextWithDash method), 1634
 set_tzinfo() (matplotlib.dates.DateFormatter method), 1170
 set_tzinfo() (matplotlib.dates.DateLocator method), 1171
 set_under() (matplotlib.colors.Colormap method), 1153
 set_unit() (matplotlib.text.OffsetFrom method), 1624
 set_units() (matplotlib.axis.Axis method), 802
 set_units() (matplotlib.axis.XAxis method), 832
 set_units() (matplotlib.axis.YAxis method), 822
 set_url() (matplotlib.artist.Artist method), 550
 set_url() (matplotlib.axes.Axes method), 781
 set_url() (matplotlib.axis.Axis method), 888
 set_url() (matplotlib.axis.Tick method), 849
 set_url() (matplotlib.axis.XAxis method), 899
 set_url() (matplotlib.axis.XTick method), 860
 set_url() (matplotlib.axis.YAxis method), 911
 set_url() (matplotlib.axis.YTick method), 871
 set_url() (matplotlib.backend_bases.GraphicsContextBase method), 923
 set_url() (matplotlib.collections.AsteriskPolygonCollection method), 986
 set_url() (matplotlib.collections.BrokenBarHCollection method), 998
 set_url() (matplotlib.collections.CircleCollection method), 1010
 set_url() (matplotlib.collections.Collection method), 1022
 set_url() (matplotlib.collections.EllipseCollection method), 1034
 set_url() (matplotlib.collections.EventCollection method), 1047
 set_url() (matplotlib.collections.LineCollection method), 1059
 set_url() (matplotlib.collections.PatchCollection method), 1071
 set_url() (matplotlib.collections.PathCollection method), 1083
 set_url() (matplotlib.collections.PolyCollection method), 1095
 set_url() (matplotlib.collections.QuadMesh method), 1107
 set_url() (matplotlib.collections.RegularPolyCollection method), 1119
 set_url() (matplotlib.collections.StarPolygonCollection method), 1132
 set_url() (matplotlib.collections.TriMesh method), 1143
 set_urls() (matplotlib.collections.AsteriskPolygonCollection method), 986
 set_urls() (matplotlib.collections.BrokenBarHCollection method), 998
 set_urls() (matplotlib.collections.CircleCollection method), 1010
 set_urls() (matplotlib.collections.Collection method), 1022
 set_urls() (matplotlib.collections.EllipseCollection method), 1034
 set_urls() (matplotlib.collections.EventCollection method), 1047
 set_urls() (matplotlib.collections.LineCollection method), 1060
 set_urls() (matplotlib.collections.PatchCollection method), 1071
 set_urls() (matplotlib.collections.PathCollection method), 1083
 set_urls() (matplotlib.collections.PolyCollection method), 1095
 set_urls() (matplotlib.collections.QuadMesh method), 1107

method), 1107

set_urls() (matplotlib.collections.RegularPolyCollection method), 1119

set_urls() (matplotlib.collections.StarPolygonCollection method), 1132

set_urls() (matplotlib.collections.TriMesh method), 1143

set_useLocale() (matplotlib.ticker.ScalarFormatter method), 1640

set_useOffset() (matplotlib.ticker.ScalarFormatter method), 1640

set_usetex() (matplotlib.text.Text method), 1631

set_va() (matplotlib.text.Text method), 1631

set_val() (matplotlib.widgets.Slider method), 1698

set_variant() (matplotlib.font_manager.FontProperties method), 1223

set_variant() (matplotlib.text.Text method), 1631

set_vertical() (mpl_toolkits.axes_grid.axes_divider.Divider method), 1798

set_verticalalignment() (matplotlib.text.Text method), 1631

set_verts() (matplotlib.collections.BrokenBarHCollection method), 998

set_verts() (matplotlib.collections.EventCollection method), 1047

set_verts() (matplotlib.collections.LineCollection method), 1060

set_verts() (matplotlib.collections.PolyCollection method), 1095

set_verts() (mpl_toolkits.mplot3d.art3d.Poly3DCollection method), 1874

set_verts_and_codes() (matplotlib.collections.BrokenBarHCollection method), 998

set_verts_and_codes() (matplotlib.collections.PolyCollection method), 1095

set_verts_and_codes() (mpl_toolkits.mplot3d.art3d.Poly3DCollection method), 1874

set_view_interval() (matplotlib.axis.Axis method), 801

set_view_interval() (matplotlib.axis.XAxis method), 832

set_view_interval() (matplotlib.axis.YAxis method), 822

set_view_interval() (matplotlib.dates.MicrosecondLocator method), 1174

set_view_interval() (matplotlib.ticker.TickHelper method), 1637

set_view_interval() (mpl_toolkits.mplot3d.axis3d.Axis method), 1870

set_visible() (matplotlib.artist.Artist method), 545

set_visible() (matplotlib.axes.Axes method), 781

set_visible() (matplotlib.axis.Axis method), 888

set_visible() (matplotlib.axis.Tick method), 849

set_visible() (matplotlib.axis.XAxis method), 900

set_visible() (matplotlib.axis.XTick method), 860

set_visible() (matplotlib.axis.YAxis method), 911

set_visible() (matplotlib.axis.YTick method), 871

set_visible() (matplotlib.collections.AsteriskPolygonCollection method), 986

set_visible() (matplotlib.collections.BrokenBarHCollection method), 998

set_visible() (matplotlib.collections.CircleCollection method), 1010

set_visible() (matplotlib.collections.Collection method), 1022

set_visible() (matplotlib.collections.EllipseCollection method), 1034

set_visible() (matplotlib.collections.EventCollection method), 1047

set_visible() (matplotlib.collections.LineCollection method), 1060

set_visible() (matplotlib.collections.PatchCollection method), 1071

set_visible() (matplotlib.collections.PathCollection method), 1083

set_visible() (matplotlib.collections.PolyCollection method), 1095

set_visible() (matplotlib.collections.QuadMesh method), 1107

set_visible() (matplotlib.collections.RegularPolyCollection method), 1119

set_visible() (matplotlib.collections.StarPolygonCollection method), 1132

set_visible() (matplotlib.collections.TriMesh method), 1143

set_visible() (matplotlib.widgets.ToolHandles method), 1701

set_weight() (matplotlib.font_manager.FontProperties method), 1223

set_weight() (matplotlib.text.Text method), 1631

- set_width() (matplotlib.offsetbox.OffsetBox method), 1320
 set_width() (matplotlib.patches.FancyBboxPatch method), 1350
 set_width() (matplotlib.patches.Rectangle method), 1359
 set_width() (matplotlib.patches.Wedge method), 1364
 set_width_ratios() (matplotlib.gridspec.GridSpecBase method), 1228
 set_window_title() (matplotlib.backend_bases.FigureCanvasBase method), 918
 set_window_title() (matplotlib.backend_bases.FigureManagerBase method), 919
 set_wrap() (matplotlib.text.Text method), 1631
 set_x() (matplotlib.patches.FancyBboxPatch method), 1350
 set_x() (matplotlib.patches.Rectangle method), 1360
 set_x() (matplotlib.text.Text method), 1631
 set_x() (matplotlib.text.TextWithDash method), 1634
 set_xbound() (matplotlib.axes.Axes method), 742
 set_xdata() (matplotlib.lines.Line2D method), 1253
 set_xlabel() (matplotlib.axes.Axes method), 743
 set_xlim() (matplotlib.axes.Axes method), 738
 set_xlim() (mpl_toolkits.mplot3d.axes3d.Axes3D method), 1863
 set_xlim3d() (mpl_toolkits.mplot3d.axes3d.Axes3D method), 1863
 set_xmargin() (matplotlib.axes.Axes method), 752
 set_xscale() (matplotlib.axes.Axes method), 749
 set_xscale() (mpl_toolkits.mplot3d.axes3d.Axes3D method), 1863
 set_xticklabels() (matplotlib.axes.Axes method), 758
 set_xticks() (matplotlib.axes.Axes method), 760
 set_xy() (matplotlib.patches.Polygon method), 1358
 set_xy() (matplotlib.patches.Rectangle method), 1360
 set_y() (matplotlib.patches.FancyBboxPatch method), 1350
 set_y() (matplotlib.patches.Rectangle method), 1360
 set_y() (matplotlib.text.Text method), 1631
 set_y() (matplotlib.text.TextWithDash method), 1634
 set_ybound() (matplotlib.axes.Axes method), 741
 set_ydata() (matplotlib.lines.Line2D method), 1253
 set_ylabel() (matplotlib.axes.Axes method), 743
 set_ylim() (matplotlib.axes.Axes method), 739
 set_ylim() (mpl_toolkits.mplot3d.axes3d.Axes3D method), 1864
 set_ylim3d() (mpl_toolkits.mplot3d.axes3d.Axes3D method), 1864
 set_ymargin() (matplotlib.axes.Axes method), 752
 set_yscale() (matplotlib.axes.Axes method), 750
 set_yscale() (mpl_toolkits.mplot3d.axes3d.Axes3D method), 1864
 set_yticklabels() (matplotlib.axes.Axes method), 760
 set_yticks() (matplotlib.axes.Axes method), 761
 set_zbound() (mpl_toolkits.mplot3d.axes3d.Axes3D method), 1865
 set_zlabel() (mpl_toolkits.mplot3d.axes3d.Axes3D method), 1865
 set_zlim() (mpl_toolkits.mplot3d.axes3d.Axes3D method), 1865
 set_zlim3d() (mpl_toolkits.mplot3d.axes3d.Axes3D method), 1865
 set_zmargin() (mpl_toolkits.mplot3d.axes3d.Axes3D method), 1865
 set_zoom() (matplotlib.offsetbox.OffsetImage method), 1320
 set_zorder() (matplotlib.artist.Artist method), 546
 set_zorder() (matplotlib.axes.Axes method), 781
 set_zorder() (matplotlib.axis.Axis method), 889
 set_zorder() (matplotlib.axis.Tick method), 849
 set_zorder() (matplotlib.axis.XAxis method), 900
 set_zorder() (matplotlib.axis.XTick method), 860
 set_zorder() (matplotlib.axis.YAxis method), 911
 set_zorder() (matplotlib.axis.YTick method), 872
 set_zorder() (matplotlib.collections.AsteriskPolygonCollection method), 986
 set_zorder() (matplotlib.collections.BrokenBarHCollection method), 998
 set_zorder() (matplotlib.collections.CircleCollection method), 1010
 set_zorder() (matplotlib.collections.Collection method), 1022
 set_zorder() (matplotlib.collections.EllipseCollection method), 1034
 set_zorder() (matplotlib.collections.EventCollection method), 1047
 set_zorder() (matplotlib.collections.LineCollection method), 1060
 set_zorder() (matplotlib.collections.PatchCollection

- method), 1071
- set_zorder() (matplotlib.collections.PathCollection method), 1083
- set_zorder() (matplotlib.collections.PolyCollection method), 1095
- set_zorder() (matplotlib.collections.QuadMesh method), 1107
- set_zorder() (matplotlib.collections.RegularPolyCollection method), 1119
- set_zorder() (matplotlib.collections.StarPolygonCollection method), 1132
- set_zorder() (matplotlib.collections.TriMesh method), 1143
- set_zscale() (mpl_toolkits.mplot3d.axes3d.Axes3D method), 1865
- set_zsort() (mpl_toolkits.mplot3d.art3d.Poly3DCollection method), 1874
- set_zticklabels() (mpl_toolkits.mplot3d.axes3d.Axes3D method), 1866
- set_zticks() (mpl_toolkits.mplot3d.axes3d.Axes3D method), 1866
- SetCursorBase (class in matplotlib.backend_tools), 938
- setp() (in module matplotlib.artist), 552
- setp() (in module matplotlib.pyplot), 1551
- setup() (matplotlib.animation.FileMovieWriter method), 523
- setup() (matplotlib.animation.MovieWriter method), 522
- shade() (matplotlib.colors.LightSource method), 1156
- shade_rgb() (matplotlib.colors.LightSource method), 1157
- Shadow (class in matplotlib.patches), 1361
- Ship (class in matplotlib.mathtext), 1274
- short_float_fmt() (in module matplotlib.backends.backend_svg), 951
- should_simplify (matplotlib.path.Path attribute), 1372
- show() (in module matplotlib.pyplot), 1551
- show() (matplotlib.backend_bases.FigureManagerBasespace() method), 919
- show() (matplotlib.figure.Figure method), 1202
- show_popup() (matplotlib.backend_bases.FigureManagerBase method), 920
- ShowBase (class in matplotlib.backend_bases), 931
- shrink() (matplotlib.mathtext.Accent method), 1261
- shrink() (matplotlib.mathtext.Box method), 1262
- shrink() (matplotlib.mathtext.Char method), 1262
- shrink() (matplotlib.mathtext.Glue method), 1266
- shrink() (matplotlib.mathtext.Kern method), 1267
- shrink() (matplotlib.mathtext.List method), 1267
- shrink() (matplotlib.mathtext.Node method), 1271
- shrunk() (matplotlib.transforms.BboxBase method), 1653
- shrunk_to_aspect() (matplotlib.transforms.BboxBase method), 1653
- silent_list (class in matplotlib.cbook), 966
- silverman_factor() (matplotlib.mlab.GaussianKDE method), 1283
- simple_group() (matplotlib.mathtext.Parser method), 1273
- simple_linear_interpolation() (in module matplotlib.cbook), 966
- SimpleLineShadow (class in matplotlib.patheffects), 1376
- SimplePatchShadow (class in matplotlib.patheffects), 1377
- simplify_threshold (matplotlib.path.Path attribute), 1372
- single_shot (matplotlib.backend_bases.TimerBase attribute), 932
- size (matplotlib.dviread.DviFont attribute), 1182
- size (matplotlib.transforms.BboxBase attribute), 1653
- skew() (matplotlib.transforms.Affine2D method), 1664
- skew_deg() (matplotlib.transforms.Affine2D method), 1664
- Slider (class in matplotlib.widgets), 1697
- slopes() (in module matplotlib.mlab), 1307
- snowflake() (matplotlib.mathtext.Parser method), 1273
- sort() (matplotlib.cbook.Sorter method), 956
- Sorter (class in matplotlib.cbook), 956
- soundex() (in module matplotlib.cbook), 966
- space() (matplotlib.mathtext.Parser method), 1273
- span_where() (matplotlib.collections.BrokenBarHCollection static method), 999
- SpanSelector (class in matplotlib.widgets), 1698
- specgram() (in module matplotlib.mlab), 1307
- specgram() (in module matplotlib.pyplot), 1552
- specgram() (matplotlib.axes.Axes method), 631

- spectral() (in module matplotlib.pyplot), 1555
- Spine (class in matplotlib.spines), 1615
- splitx() (matplotlib.transforms.BboxBase method), 1654
- splity() (matplotlib.transforms.BboxBase method), 1654
- spring() (in module matplotlib.pyplot), 1555
- spy() (in module matplotlib.pyplot), 1555
- spy() (matplotlib.axes.Axes method), 700
- sqrt() (matplotlib.mathtext.Parser method), 1273
- SsGlue (class in matplotlib.mathtext), 1275
- Stack (class in matplotlib.cbook), 956
- stackplot() (in module matplotlib.pyplot), 1556
- stackplot() (matplotlib.axes.Axes method), 595
- stackrel() (matplotlib.mathtext.Parser method), 1273
- stale (matplotlib.artist.Artist attribute), 551
- stale (matplotlib.axes.Axes attribute), 769
- stale (matplotlib.axis.Axis attribute), 889
- stale (matplotlib.axis.Tick attribute), 849
- stale (matplotlib.axis.XAxis attribute), 900
- stale (matplotlib.axis.XTick attribute), 860
- stale (matplotlib.axis.YAxis attribute), 911
- stale (matplotlib.axis.YTick attribute), 872
- stale (matplotlib.collections.AsteriskPolygonCollection attribute), 987
- stale (matplotlib.collections.BrokenBarHCollection attribute), 999
- stale (matplotlib.collections.CircleCollection attribute), 1010
- stale (matplotlib.collections.Collection attribute), 1022
- stale (matplotlib.collections.EllipseCollection attribute), 1034
- stale (matplotlib.collections.EventCollection attribute), 1047
- stale (matplotlib.collections.LineCollection attribute), 1060
- stale (matplotlib.collections.PatchCollection attribute), 1071
- stale (matplotlib.collections.PathCollection attribute), 1083
- stale (matplotlib.collections.PolyCollection attribute), 1095
- stale (matplotlib.collections.QuadMesh attribute), 1107
- stale (matplotlib.collections.RegularPolyCollection attribute), 1120
- stale (matplotlib.collections.StarPolygonCollection attribute), 1132
- stale (matplotlib.collections.TriMesh attribute), 1143
- StandardPsfFonts (class in matplotlib.mathtext), 1275
- StarPolygonCollection (class in matplotlib.collections), 1121
- start() (matplotlib.backend_bases.TimerBase method), 932
- start_event_loop() (matplotlib.backend_bases.FigureCanvasBase method), 918
- start_event_loop_default() (matplotlib.backend_bases.FigureCanvasBase method), 918
- start_filter() (matplotlib.backend_bases.RendererBase method), 930
- start_group() (matplotlib.mathtext.Parser method), 1273
- start_pan() (matplotlib.axes.Axes method), 771
- start_rasterizing() (matplotlib.backend_bases.RendererBase method), 930
- StatusbarBase (class in matplotlib.backend_bases), 931
- stem() (in module matplotlib.pyplot), 1557
- stem() (matplotlib.axes.Axes method), 589
- StemContainer (class in matplotlib.container), 1166
- step (matplotlib.backend_bases.MouseEvent attribute), 924
- step() (in module matplotlib.pyplot), 1558
- step() (matplotlib.axes.Axes method), 568
- sticky_edges (matplotlib.artist.Artist attribute), 540
- sticky_edges (matplotlib.collections.AsteriskPolygonCollection attribute), 987
- sticky_edges (matplotlib.collections.BrokenBarHCollection attribute), 999
- sticky_edges (matplotlib.collections.CircleCollection attribute), 1010
- sticky_edges (matplotlib.collections.Collection attribute), 1022
- sticky_edges (matplotlib.collections.EllipseCollection attribute), 1034
- sticky_edges (matplotlib.collections.EventCollection at-

- tribute), 1047
- sticky_edges (matplotlib.collections.LineCollection attribute), 1060
- sticky_edges (matplotlib.collections.PatchCollection attribute), 1071
- sticky_edges (matplotlib.collections.PathCollection attribute), 1083
- sticky_edges (matplotlib.collections.PolyCollection attribute), 1095
- sticky_edges (matplotlib.collections.QuadMesh attribute), 1107
- sticky_edges (matplotlib.collections.RegularPolyCollection attribute), 1120
- sticky_edges (matplotlib.collections.StarPolygonCollection attribute), 1132
- sticky_edges (matplotlib.collections.TriMesh attribute), 1143
- stineman_interp() (in module matplotlib.mlab), 1309
- STIXFontConstants (class in matplotlib.mathtext), 1274
- StixFonts (class in matplotlib.mathtext), 1275
- STIXSansFontConstants (class in matplotlib.mathtext), 1274
- StixSansFonts (class in matplotlib.mathtext), 1275
- STOP (matplotlib.path.Path attribute), 1369
- stop() (matplotlib.backend_bases.TimerBase method), 932
- stop_event_loop() (matplotlib.backend_bases.FigureCanvasBase method), 919
- stop_event_loop_default() (matplotlib.backend_bases.FigureCanvasBase method), 919
- stop_filter() (matplotlib.backend_bases.RendererBase method), 930
- stop_rasterizing() (matplotlib.backend_bases.RendererBase method), 930
- Stream (class in matplotlib.backends.backend_pdf), 951
- streamplot() (in module matplotlib.pyplot), 1559
- streamplot() (matplotlib.axes.Axes method), 730
- strftime() (matplotlib.dates.DateFormatter method), 1170
- strftime_pre_1900() (matplotlib.dates.DateFormatter method), 1170
- stride_repeat() (in module matplotlib.mlab), 1310
- stride_windows() (in module matplotlib.mlab), 1310
- string_width_height() (matplotlib.afm.AFM method), 488
- strip_math() (in module matplotlib.cbook), 966
- strip_math() (matplotlib.backend_bases.RendererBase method), 930
- StrMethodFormatter (class in matplotlib.ticker), 1639
- Stroke (class in matplotlib.patheffects), 1377
- sub1 (matplotlib.mathtext.ComputerModernFontConstants attribute), 1263
- sub1 (matplotlib.mathtext.FontConstantsBase attribute), 1264
- sub2 (matplotlib.mathtext.ComputerModernFontConstants attribute), 1263
- sub2 (matplotlib.mathtext.FontConstantsBase attribute), 1264
- sub2 (matplotlib.mathtext.STIXFontConstants attribute), 1274
- subdrop (matplotlib.mathtext.ComputerModernFontConstants attribute), 1263
- subdrop (matplotlib.mathtext.FontConstantsBase attribute), 1264
- subplot() (in module matplotlib.pyplot), 1560
- subplot2grid() (in module matplotlib.pyplot), 1561
- subplot_tool() (in module matplotlib.pyplot), 1561
- SubplotDivider (class in mpl_toolkits.axes_grid.axes_divider), 1799
- SubplotParams (class in matplotlib.figure), 1205
- subplots() (in module matplotlib.pyplot), 1562
- subplots_adjust() (in module matplotlib.pyplot), 1564
- subplots_adjust() (matplotlib.figure.Figure method), 1202
- SubplotSpec (class in matplotlib.gridspec), 1229
- SubplotTool (class in matplotlib.widgets), 1700
- subs() (matplotlib.ticker.LogLocator method), 1644
- subsuper() (matplotlib.mathtext.Parser method), 1273
- SubSuperCluster (class in matplotlib.mathtext), 1276
- summer() (in module matplotlib.pyplot), 1564
- sup1 (matplotlib.mathtext.ComputerModernFontConstants attribute), 1263
- sup1 (matplotlib.mathtext.FontConstantsBase attribute), 1263

- attribute), 1264
- sup1 (matplotlib.mattext.STIXFontConstants attribute), 1274
- sup1 (matplotlib.mattext.STIXSansFontConstants attribute), 1274
- supports_blit (matplotlib.backend_bases.FigureCanvasBase attribute), 919
- suptitle() (in module matplotlib.pyplot), 1564
- suptitle() (matplotlib.figure.Figure method), 1202
- SVG, 3018
- switch_backend() (in module matplotlib.pyplot), 1564
- switch_backends() (matplotlib.backend_bases.FigureCanvasBase method), 919
- switch_orientation() (matplotlib.collections.EventCollection method), 1048
- symbol() (matplotlib.mattext.Parser method), 1273
- SymLogNorm (class in matplotlib.colors), 1161
- SymmetricalLogLocator (class in matplotlib.ticker), 1645
- SymmetricalLogScale (class in matplotlib.scale), 1612
- SymmetricalLogScale.InvertedSymmetricalLogTransform (class in matplotlib.scale), 1612
- SymmetricalLogScale.SymmetricalLogTransform (class in matplotlib.scale), 1612
- SymmetricalLogTransform (class in matplotlib.scale), 1613
- ## T
- table() (in module matplotlib.pyplot), 1565
- table() (matplotlib.axes.Axes method), 717
- target (matplotlib.mattext.BakomaFonts attribute), 1262
- TempCache (class in matplotlib.font_manager), 1223
- test_lines_dists() (in module mpl_toolkits.mplot3d.proj3d), 1877
- test_proj() (in module mpl_toolkits.mplot3d.proj3d), 1877
- test_proj_draw_axes() (in module mpl_toolkits.mplot3d.proj3d), 1877
- test_proj_make_M() (in module mpl_toolkits.mplot3d.proj3d), 1877
- test_rot() (in module mpl_toolkits.mplot3d.proj3d), 1877
- test_world() (in module mpl_toolkits.mplot3d.proj3d), 1877
- texname (matplotlib.dviread.DviFont attribute), 1181, 1182
- Text (class in matplotlib.text), 1624
- text() (in module matplotlib.pyplot), 1565
- text() (matplotlib.axes.Axes method), 717
- text() (matplotlib.figure.Figure method), 1203
- text() (mpl_toolkits.mplot3d.Axes3D method), 1844
- text() (mpl_toolkits.mplot3d.axes3d.Axes3D method), 1866
- text2D() (mpl_toolkits.mplot3d.axes3d.Axes3D method), 1866
- Text3D (class in mpl_toolkits.mplot3d.art3d), 1874
- text3D() (mpl_toolkits.mplot3d.axes3d.Axes3D method), 1867
- text_2d_to_3d() (in module mpl_toolkits.mplot3d.art3d), 1875
- TextArea (class in matplotlib.offsetbox), 1321
- TextWithDash (class in matplotlib.text), 1631
- Tfm (class in matplotlib.dviread), 1183
- ThetaFormatter (class in matplotlib.projections.polar), 1386
- thetaagrids() (in module matplotlib.pyplot), 1566
- thumbnail() (in module matplotlib.image), 1235
- Tick (class in matplotlib.axis), 807
- tick_bottom() (matplotlib.axis.XAxis method), 805
- tick_left() (matplotlib.axis.YAxis method), 804
- tick_params() (in module matplotlib.pyplot), 1567
- tick_params() (matplotlib.axes.Axes method), 762
- tick_params() (mpl_toolkits.mplot3d.axes3d.Axes3D method), 1867
- tick_right() (matplotlib.axis.YAxis method), 804
- tick_top() (matplotlib.axis.XAxis method), 805
- tick_update_position() (in module mpl_toolkits.mplot3d.axis3d), 1871
- tick_values() (matplotlib.dates.AutoDateLocator method), 1173
- tick_values() (matplotlib.dates.MicrosecondLocator method), 1175
- tick_values() (matplotlib.dates.RRRuleLocator method), 1172
- tick_values() (matplotlib.dates.YearLocator method), 1173
- tick_values() (matplotlib.ticker.AutoMinorLocator method), 1645

tick_values() (matplotlib.ticker.FixedLocator method), 1643
 tick_values() (matplotlib.ticker.IndexLocator method), 1643
 tick_values() (matplotlib.ticker.LinearLocator method), 1643
 tick_values() (matplotlib.ticker.Locator method), 1642
 tick_values() (matplotlib.ticker.LogLocator method), 1644
 tick_values() (matplotlib.ticker.MaxNLocator method), 1645
 tick_values() (matplotlib.ticker.MultipleLocator method), 1644
 tick_values() (matplotlib.ticker.NullLocator method), 1643
 tick_values() (matplotlib.ticker.SymmetricalLogLocator method), 1646
 Ticker (class in matplotlib.axis), 794
 TickHelper (class in matplotlib.ticker), 1637
 ticklabel_format() (in module matplotlib.pyplot), 1568
 ticklabel_format() (matplotlib.axes.Axes method), 762
 ticklabel_format() (mpl_toolkits.mplot3d.axes3d.Axes3D method), 1868
 TickLabels (class in mpl_toolkits.axes_grid.axis_artist), 1804
 Ticks (class in mpl_toolkits.axes_grid.axis_artist), 1803
 TIFF, 3018
 tight_layout() (in module matplotlib.pyplot), 1569
 tight_layout() (matplotlib.figure.Figure method), 1204
 tight_layout() (matplotlib.gridspec.GridSpec method), 1227
 TimedAnimation (class in matplotlib.animation), 525
 TimerBase (class in matplotlib.backend_bases), 931
 title() (in module matplotlib.pyplot), 1569
 Tk, 3018
 to_filehandle() (in module matplotlib.cbook), 966
 to_hex() (in module matplotlib.colors), 1163
 to_html5_video() (matplotlib.animation.Animation method), 495
 to_mask() (matplotlib.mathtext.MathTextParser method), 1268
 to_png() (matplotlib.mathtext.MathTextParser method), 1268
 to_polygons() (matplotlib.path.Path method), 1372
 to_rgb() (in module matplotlib.colors), 1163
 to_rgba() (in module matplotlib.colors), 1163
 to_rgba() (matplotlib.cm.ScalarMappable method), 972
 to_rgba() (matplotlib.collections.AsteriskPolygonCollection method), 987
 to_rgba() (matplotlib.collections.BrokenBarHCollection method), 999
 to_rgba() (matplotlib.collections.CircleCollection method), 1011
 to_rgba() (matplotlib.collections.Collection method), 1023
 to_rgba() (matplotlib.collections.EllipseCollection method), 1035
 to_rgba() (matplotlib.collections.EventCollection method), 1048
 to_rgba() (matplotlib.collections.LineCollection method), 1060
 to_rgba() (matplotlib.collections.PatchCollection method), 1072
 to_rgba() (matplotlib.collections.PathCollection method), 1084
 to_rgba() (matplotlib.collections.PolyCollection method), 1096
 to_rgba() (matplotlib.collections.QuadMesh method), 1108
 to_rgba() (matplotlib.collections.RegularPolyCollection method), 1120
 to_rgba() (matplotlib.collections.StarPolygonCollection method), 1132
 to_rgba() (matplotlib.collections.TriMesh method), 1144
 to_rgba() (matplotlib.mathtext.MathTextParser method), 1268
 to_rgba_array() (in module matplotlib.colors), 1163
 to_values() (matplotlib.transforms.Affine2DBase method), 1662
 todate (class in matplotlib.cbook), 966
 todatetime (class in matplotlib.cbook), 966
 tofloat (class in matplotlib.cbook), 966
 toggle() (mpl_toolkits.axes_grid.axis_artist.AxisArtist method), 1803
 toggle_toolitem() (matplotlib.backend_bases.ToolContainerBase method), 933

- toggled (matplotlib.backend_tools.ToolToggleBase attribute), 942
 toint (class in matplotlib.cbook), 966
 ToolBack (class in matplotlib.backend_tools), 938
 ToolBase (class in matplotlib.backend_tools), 938
 ToolContainerBase (class in matplotlib.backend_bases), 932
 ToolCursorPosition (class in matplotlib.backend_tools), 940
 ToolEnableAllNavigation (class in matplotlib.backend_tools), 940
 ToolEnableNavigation (class in matplotlib.backend_tools), 940
 ToolEvent (class in matplotlib.backend_managers), 934
 ToolForward (class in matplotlib.backend_tools), 940
 ToolFullScreen (class in matplotlib.backend_tools), 940
 ToolGrid (class in matplotlib.backend_tools), 941
 ToolHandles (class in matplotlib.widgets), 1700
 ToolHome (class in matplotlib.backend_tools), 941
 toolitems (matplotlib.backend_bases.NavigationToolbar2 attribute), 926
 ToolManager (class in matplotlib.backend_managers), 934
 toolmanager_connect() (matplotlib.backend_managers.ToolManager method), 935
 toolmanager_disconnect() (matplotlib.backend_managers.ToolManager method), 936
 ToolManagerMessageEvent (class in matplotlib.backend_managers), 936
 ToolPan (class in matplotlib.backend_tools), 941
 ToolQuit (class in matplotlib.backend_tools), 942
 tools (matplotlib.backend_managers.ToolManager attribute), 936
 ToolToggleBase (class in matplotlib.backend_tools), 942
 ToolTriggerEvent (class in matplotlib.backend_managers), 936
 ToolViewsPositions (class in matplotlib.backend_tools), 943
 ToolXScale (class in matplotlib.backend_tools), 943
 ToolYScale (class in matplotlib.backend_tools), 944
 ToolZoom (class in matplotlib.backend_tools), 944
 tostr (class in matplotlib.cbook), 967
 tostr() (matplotlib.mlab.FormatFormatStr method), 1281
 tostr() (matplotlib.mlab.FormatInt method), 1282
 tostr() (matplotlib.mlab.FormatObj method), 1282
 tostr() (matplotlib.mlab.FormatString method), 1282
 toval() (matplotlib.mlab.FormatBool method), 1281
 toval() (matplotlib.mlab.FormatDate method), 1281
 toval() (matplotlib.mlab.FormatFloat method), 1281
 toval() (matplotlib.mlab.FormatInt method), 1282
 toval() (matplotlib.mlab.FormatObj method), 1282
 Transform (class in matplotlib.transforms), 1657
 transform() (in module mpl_toolkits.mplot3d.proj3d), 1877
 transform() (matplotlib.transforms.AffineBase method), 1660
 transform() (matplotlib.transforms.IdentityTransform method), 1665
 transform() (matplotlib.transforms.Transform method), 1658
 transform() (matplotlib.type1font.Type1Font method), 1683
 transform_affine() (matplotlib.transforms.Affine2DBase method), 1662
 transform_affine() (matplotlib.transforms.AffineBase method), 1660
 transform_affine() (matplotlib.transforms.CompositeGenericTransform method), 1667
 transform_affine() (matplotlib.transforms.IdentityTransform method), 1665
 transform_affine() (matplotlib.transforms.Transform method), 1658
 transform_angles() (matplotlib.transforms.Transform method), 1658
 transform_bbox() (matplotlib.transforms.Transform method), 1659
 transform_non_affine() (matplotlib.projections.polar.InvertedPolarTransform method), 1380
 transform_non_affine() (matplotlib.projections.polar.PolarAxes.InvertedPolarTransform method), 1381
 transform_non_affine() (matplotlib.projections.polar.PolarAxes.PolarTransform

method), 1381		transform_path() (mat-
transform_non_affine() (mat-	plotlib.projections.polar.PolarTransform	method), 1665
method), 1386		transform_path() (matplotlib.transforms.Transform
transform_non_affine() (mat-	plotlib.scale.InvertedLogTransformBase	method), 1659
method), 1606		transform_path_affine() (mat-
transform_non_affine() (mat-	plotlib.scale.InvertedSymmetricalLogTransform	method), 1661
method), 1606		transform_path_affine() (mat-
transform_non_affine() (mat-	plotlib.scale.LogisticTransform	method), 1665
1610		transform_path_affine() (mat-
transform_non_affine() (mat-	plotlib.scale.LogitTransform	method), 1659
1611		transform_path_non_affine() (mat-
transform_non_affine() (mat-	plotlib.scale.LogScale.LogTransformBase	method), 1382
method), 1609		transform_path_non_affine() (mat-
transform_non_affine() (mat-	plotlib.scale.LogTransformBase	method), 1386
1610		transform_path_non_affine() (mat-
transform_non_affine() (mat-	plotlib.scale.SymmetricalLogScale.InvertedSymmetricalLogTransform	method), 1661
method), 1612		transform_path_non_affine() (mat-
transform_non_affine() (mat-	plotlib.scale.SymmetricalLogScale.SymmetricalLogTransform	method), 1668
method), 1613		transform_path_non_affine() (mat-
transform_non_affine() (mat-	plotlib.scale.SymmetricalLogTransform	method), 1665
method), 1613		transform_path_non_affine() (mat-
transform_non_affine() (mat-	plotlib.transforms.AffineBase	method), 1659
1661		transform_point() (mat-
transform_non_affine() (mat-	plotlib.transforms.BlendedGenericTransform	method), 1662
method), 1666		transform_point() (matplotlib.transforms.Transform
transform_non_affine() (mat-	plotlib.transforms.CompositeGenericTransform	method), 1659
method), 1668		transformed() (matplotlib.path.Path
transform_non_affine() (mat-	plotlib.transforms.IdentityTransform	method), 1373
method), 1665		transformed() (matplotlib.transforms.BboxBase
transform_non_affine() (mat-	plotlib.transforms.Transform	method), 1654
1659		TransformedBbox (class in matplotlib.transforms),
transform_path() (matplotlib.transforms.AffineBase		1656
method), 1661		TransformedPath (class in matplotlib.transforms),
		1669
		TransformNode (class in matplotlib.transforms),
		1650
		TransformWrapper (class in matplotlib.transforms),
		1660

- translate() (matplotlib.transforms.Affine2D method), 1664
- translated() (matplotlib.transforms.BboxBase method), 1654
- transmute() (matplotlib.patches.ArrowStyle.Fancy method), 1332
- transmute() (matplotlib.patches.ArrowStyle.Simple method), 1333
- transmute() (matplotlib.patches.ArrowStyle.Wedge method), 1333
- transmute() (matplotlib.patches.BoxStyle.Circle method), 1335
- transmute() (matplotlib.patches.BoxStyle.DArrow method), 1335
- transmute() (matplotlib.patches.BoxStyle.LArrow method), 1335
- transmute() (matplotlib.patches.BoxStyle.RArrow method), 1335
- transmute() (matplotlib.patches.BoxStyle.Round method), 1335
- transmute() (matplotlib.patches.BoxStyle.Round4 method), 1335
- transmute() (matplotlib.patches.BoxStyle.Roundtooth method), 1336
- transmute() (matplotlib.patches.BoxStyle.Sawtooth method), 1336
- transmute() (matplotlib.patches.BoxStyle.Square method), 1336
- TrapezoidMapTriFinder (class in matplotlib.tri), 1672
- TriAnalyzer (class in matplotlib.tri), 1679
- Triangulation (class in matplotlib.tri), 1671
- tricontour() (in module matplotlib.pyplot), 1570
- tricontour() (matplotlib.axes.Axes method), 706
- tricontour() (mpl_toolkits.mplot3d.axes3d.Axes3D method), 1868
- tricontourf() (in module matplotlib.pyplot), 1574
- tricontourf() (matplotlib.axes.Axes method), 710
- tricontourf() (mpl_toolkits.mplot3d.axes3d.Axes3D method), 1868
- TriFinder (class in matplotlib.tri), 1672
- trigger() (matplotlib.backend_tools.AxisScaleBase method), 937
- trigger() (matplotlib.backend_tools.RubberbandBase method), 938
- trigger() (matplotlib.backend_tools.ToolBase method), 939
- trigger() (matplotlib.backend_tools.ToolEnableAllNavigation method), 940
- trigger() (matplotlib.backend_tools.ToolEnableNavigation method), 940
- trigger() (matplotlib.backend_tools.ToolGrid method), 941
- trigger() (matplotlib.backend_tools.ToolQuit method), 942
- trigger() (matplotlib.backend_tools.ToolToggleBase method), 943
- trigger() (matplotlib.backend_tools.ViewsPositionsBase method), 944
- trigger() (matplotlib.backend_tools.ZoomPanBase method), 944
- trigger_tool() (matplotlib.backend_bases.ToolContainerBase method), 933
- trigger_tool() (matplotlib.backend_managers.ToolManager method), 936
- TriInterpolator (class in matplotlib.tri), 1673
- TriMesh (class in matplotlib.collections), 1133
- tripcolor() (in module matplotlib.pyplot), 1578
- tripcolor() (matplotlib.axes.Axes method), 701
- tripplot() (in module matplotlib.pyplot), 1581
- tripplot() (matplotlib.axes.Axes method), 704
- TriRefiner (class in matplotlib.tri), 1676
- TruetypeFonts (class in matplotlib.mathtext), 1276
- ttfdict_to_fnames() (in module matplotlib.font_manager), 1224
- ttfFontProperty() (in module matplotlib.font_manager), 1224
- tunit_cube() (mpl_toolkits.mplot3d.axes3d.Axes3D method), 1869
- tunit_edges() (mpl_toolkits.mplot3d.axes3d.Axes3D method), 1869
- twinx() (in module matplotlib.pyplot), 1583
- twinx() (matplotlib.axes.Axes method), 766
- twiny() (in module matplotlib.pyplot), 1583
- twiny() (matplotlib.axes.Axes method), 766
- Type1Font (class in matplotlib.type1font), 1683
- ## U
- unichr_safe() (in module matplotlib.mathtext), 1277
- unicode_safe() (in module matplotlib.cbook), 967
- UnicodeFonts (class in matplotlib.mathtext), 1276
- UniformTriRefiner (class in matplotlib.tri), 1677
- uninstall_repl_displayhook() (in module matplotlib.pyplot), 1583

union() (matplotlib.transforms.BboxBase static method), 1654
 unique() (in module matplotlib.cbook), 967
 unit() (matplotlib.transforms.Bbox static method), 1655
 unit_bbox() (in module mpl_toolkits.mplot3d.axes3d), 1869
 unit_circle() (matplotlib.path.Path class method), 1373
 unit_circle_righthalf() (matplotlib.path.Path class method), 1373
 unit_cube() (mpl_toolkits.mplot3d.axes3d.Axes3D method), 1869
 unit_rectangle() (matplotlib.path.Path class method), 1373
 unit_regular_asterisk() (matplotlib.path.Path class method), 1373
 unit_regular_polygon() (matplotlib.path.Path class method), 1373
 unit_regular_star() (matplotlib.path.Path class method), 1373
 unknown_symbol() (matplotlib.mathtext.Parser method), 1273
 unmasked_index_ranges() (in module matplotlib.cbook), 967
 update() (matplotlib.artist.Artist method), 541
 update() (matplotlib.axes.Axes method), 778
 update() (matplotlib.axis.Axis method), 889
 update() (matplotlib.axis.Tick method), 849
 update() (matplotlib.axis.XAxis method), 900
 update() (matplotlib.axis.XTick method), 860
 update() (matplotlib.axis.YAxis method), 911
 update() (matplotlib.axis.YTick method), 872
 update() (matplotlib.backend_bases.NavigationToolbar2 method), 926
 update() (matplotlib.collections.AsteriskPolygonCollection method), 987
 update() (matplotlib.collections.BrokenBarHCollection method), 999
 update() (matplotlib.collections.CircleCollection method), 1011
 update() (matplotlib.collections.Collection method), 1023
 update() (matplotlib.collections.EllipseCollection method), 1035
 update() (matplotlib.collections.EventCollection method), 1048
 update() (matplotlib.collections.LineCollection method), 1061
 update() (matplotlib.collections.PatchCollection method), 1072
 update() (matplotlib.collections.PathCollection method), 1084
 update() (matplotlib.collections.PolyCollection method), 1096
 update() (matplotlib.collections.QuadMesh method), 1108
 update() (matplotlib.collections.RegularPolyCollection method), 1120
 update() (matplotlib.collections.StarPolygonCollection method), 1133
 update() (matplotlib.collections.TriMesh method), 1144
 update() (matplotlib.figure.SubplotParams method), 1205
 update() (matplotlib.gridspec.GridSpec method), 1228
 update() (matplotlib.text.Text method), 1631
 update_bbox_position_size() (matplotlib.text.Text method), 1631
 update_bruteforce() (matplotlib.colorbar.Colorbar method), 1145
 update_coords() (matplotlib.text.TextWithDash method), 1634
 update_datalim() (matplotlib.axes.Axes method), 741
 update_datalim() (mpl_toolkits.mplot3d.axes3d.Axes3D method), 1869
 update_datalim_bounds() (matplotlib.axes.Axes method), 741
 update_datalim_numerix() (matplotlib.axes.Axes method), 741
 update_default_handler_map() (matplotlib.legend.Legend class method), 1241
 update_fonts() (matplotlib.font_manager.FontManager method), 1221
 update_frame() (matplotlib.offsetbox.AnchoredOffsetbox method), 1314
 update_frame() (matplotlib.offsetbox.PaddedBox method), 1321
 update_from() (matplotlib.artist.Artist method), 542
 update_from() (matplotlib.axes.Axes method), 778
 update_from() (matplotlib.axis.Axis method), 889

- [update_from\(\) \(matplotlib.axis.Tick method\), 849](#)
[update_from\(\) \(matplotlib.axis.XAxis method\), 900](#)
[update_from\(\) \(matplotlib.axis.XTick method\), 861](#)
[update_from\(\) \(matplotlib.axis.YAxis method\), 911](#)
[update_from\(\) \(matplotlib.axis.YTick method\), 872](#)
[update_from\(\) \(matplotlib.collections.AsteriskPolygonCollection method\), 987](#)
[update_from\(\) \(matplotlib.collections.BrokenBarHCollection method\), 999](#)
[update_from\(\) \(matplotlib.collections.CircleCollection method\), 1011](#)
[update_from\(\) \(matplotlib.collections.Collection method\), 1023](#)
[update_from\(\) \(matplotlib.collections.EllipseCollection method\), 1035](#)
[update_from\(\) \(matplotlib.collections.EventCollection method\), 1048](#)
[update_from\(\) \(matplotlib.collections.LineCollection method\), 1061](#)
[update_from\(\) \(matplotlib.collections.PatchCollection method\), 1072](#)
[update_from\(\) \(matplotlib.collections.PathCollection method\), 1084](#)
[update_from\(\) \(matplotlib.collections.PolyCollection method\), 1096](#)
[update_from\(\) \(matplotlib.collections.QuadMesh method\), 1108](#)
[update_from\(\) \(matplotlib.collections.RegularPolyCollection method\), 1120](#)
[update_from\(\) \(matplotlib.collections.StarPolygonCollection method\), 1133](#)
[update_from\(\) \(matplotlib.collections.TriMesh method\), 1144](#)
[update_from\(\) \(matplotlib.lines.Line2D method\), 1253](#)
[update_from\(\) \(matplotlib.patches.Patch method\), 1355](#)
[update_from\(\) \(matplotlib.text.Text method\), 1631](#)
[update_from_data\(\) \(matplotlib.transforms.Bbox method\), 1655](#)
[update_from_data_xy\(\) \(matplotlib.transforms.Bbox method\), 1656](#)
[update_from_first_child\(\) \(in module matplotlib.legend_handler\), 1244](#)
[update_from_path\(\) \(matplotlib.transforms.Bbox method\), 1656](#)
[update_keymap\(\) \(matplotlib.backend_managers.ToolManager method\), 936](#)
[update_normal\(\) \(matplotlib.colorbar.Colorbar method\), 1146](#)
[update_offset\(\) \(matplotlib.offsetbox.DraggableAnnotation method\), 1316](#)
[update_offset\(\) \(matplotlib.offsetbox.DraggableBase method\), 1317](#)
[update_offset\(\) \(matplotlib.offsetbox.DraggableOffsetBox method\), 1318](#)
[update_params\(\) \(mpl_toolkits.axes_grid.axes_divider.SubplotDivide method\), 1799](#)
[update_position\(\) \(matplotlib.axis.Tick method\), 810](#)
[update_position\(\) \(matplotlib.axis.XTick method\), 811](#)
[update_position\(\) \(matplotlib.axis.YTick method\), 813](#)
[update_positions\(\) \(matplotlib.offsetbox.AnnotationBbox method\), 1315](#)
[update_positions\(\) \(matplotlib.text.Annotation method\), 1624](#)
[update_prop\(\) \(matplotlib.legend_handler.HandlerBase method\), 1242](#)
[update_prop\(\) \(matplotlib.legend_handler.HandlerRegularPolygonCollection method\), 1244](#)
[update_savefig_format\(\) \(in module matplotlib.rcsetup\), 1594](#)
[update_scalarmappable\(\) \(matplotlib.collections.AsteriskPolygonCollection method\), 988](#)
[update_scalarmappable\(\) \(matplotlib.collections.BrokenBarHCollection](#)

method), 1000

update_scalarmappable() (matplotlib.collections.CircleCollection method), 1011

update_scalarmappable() (matplotlib.collections.Collection method), 1023

update_scalarmappable() (matplotlib.collections.EllipseCollection method), 1035

update_scalarmappable() (matplotlib.collections.EventCollection method), 1048

update_scalarmappable() (matplotlib.collections.LineCollection method), 1061

update_scalarmappable() (matplotlib.collections.PatchCollection method), 1072

update_scalarmappable() (matplotlib.collections.PathCollection method), 1084

update_scalarmappable() (matplotlib.collections.PolyCollection method), 1096

update_scalarmappable() (matplotlib.collections.QuadMesh method), 1108

update_scalarmappable() (matplotlib.collections.RegularPolyCollection method), 1121

update_scalarmappable() (matplotlib.collections.StarPolygonCollection method), 1133

update_scalarmappable() (matplotlib.collections.TriMesh method), 1144

update_ticks() (matplotlib.colorbar.ColorbarBase method), 1147

update_units() (matplotlib.axis.Axis method), 803

update_units() (matplotlib.axis.XAxis method), 832

update_units() (matplotlib.axis.YAxis method), 822

update_view() (matplotlib.backend_tools.ToolViewsPositions method), 943

use() (in module matplotlib), 483

use() (in module matplotlib.style), 1619

use_cmex (matplotlib.mathtext.DejaVuFonts attribute), 1263

use_cmex (matplotlib.mathtext.StixFonts attribute), 1275

use_cmex (matplotlib.mathtext.UnicodeFonts attribute), 1276

use_sticky_edges (matplotlib.axes.Axes attribute), 751

useLocale (matplotlib.ticker.ScalarFormatter attribute), 1640

useOffset (matplotlib.ticker.ScalarFormatter attribute), 1640

V

validate_animation_writer_path() (in module matplotlib.rcsetup), 1594

validate_any() (in module matplotlib.rcsetup), 1594

validate_anylist() (in module matplotlib.rcsetup), 1594

validate_aspect() (in module matplotlib.rcsetup), 1594

validate_axisbelow() (in module matplotlib.rcsetup), 1594

validate_backend() (in module matplotlib.rcsetup), 1594

validate_bbox() (in module matplotlib.rcsetup), 1594

validate_bool() (in module matplotlib.rcsetup), 1594

validate_bool_maybe_none() (in module matplotlib.rcsetup), 1594

validate_capstylelist() (in module matplotlib.rcsetup), 1594

validate_color() (in module matplotlib.rcsetup), 1595

validate_color_for_prop_cycle() (in module matplotlib.rcsetup), 1595

validate_color_or_auto() (in module matplotlib.rcsetup), 1595

validate_color_or_inherit() (in module matplotlib.rcsetup), 1595

validate_colorlist() (in module matplotlib.rcsetup), 1595

validate_corner_mask() (in module matplotlib.rcsetup), 1595

validate_cycler() (in module matplotlib.rcsetup), 1595

validate_dashlist() (in module matplotlib.rcsetup), 1595

validate_dpi() (in module matplotlib.rcsetup), 1595

- validate_fillstylelist() (in module matplotlib.rcsetup), 1595
 validate_float() (in module matplotlib.rcsetup), 1595
 validate_float_or_None() (in module matplotlib.rcsetup), 1595
 validate_floatlist() (in module matplotlib.rcsetup), 1595
 validate_font_properties() (in module matplotlib.rcsetup), 1595
 validate_fontsize() (in module matplotlib.rcsetup), 1595
 validate_fontsizelist() (in module matplotlib.rcsetup), 1595
 validate_fonttype() (in module matplotlib.rcsetup), 1595
 validate_hatch() (in module matplotlib.rcsetup), 1595
 validate_hatchlist() (in module matplotlib.rcsetup), 1596
 validate_hinting() (in module matplotlib.rcsetup), 1596
 validate_hist_bins() (in module matplotlib.rcsetup), 1596
 validate_int() (in module matplotlib.rcsetup), 1596
 validate_int_or_None() (in module matplotlib.rcsetup), 1596
 validate_joinstylelist() (in module matplotlib.rcsetup), 1596
 validate_maskedarray() (in module matplotlib.rcsetup), 1596
 validate_negative_linestyle_legacy() (in module matplotlib.rcsetup), 1596
 validate_nseq_float (class in matplotlib.rcsetup), 1596
 validate_nseq_int (class in matplotlib.rcsetup), 1596
 validate_path_exists() (in module matplotlib.rcsetup), 1596
 validate_ps_distiller() (in module matplotlib.rcsetup), 1596
 validate_sketch() (in module matplotlib.rcsetup), 1596
 validate_string_or_None() (in module matplotlib.rcsetup), 1596
 validate_stringlist() (in module matplotlib.rcsetup), 1596
 validate_tkpythoninspect() (in module matplotlib.rcsetup), 1596
 validate_toolbar() (in module matplotlib.rcsetup), 1596
 validate_whiskers() (in module matplotlib.rcsetup), 1596
 ValidateInStrings (class in matplotlib.rcsetup), 1593
 ValidateInterval (class in matplotlib.rcsetup), 1593
 validCap (matplotlib.lines.Line2D attribute), 1253
 validCap (matplotlib.patches.Patch attribute), 1355
 validJoin (matplotlib.lines.Line2D attribute), 1253
 validJoin (matplotlib.patches.Patch attribute), 1355
 value_escape() (in module matplotlib.fontconfig_pattern), 1225
 value_unescape() (in module matplotlib.fontconfig_pattern), 1225
 VBox (class in matplotlib.mathtext), 1276
 VCentered (class in matplotlib.mathtext), 1276
 vec_pad_ones() (in module mpl_toolkits.mplot3d.proj3d), 1877
 vector graphics, 3018
 vector_lengths() (in module matplotlib.mlab), 1311
 Verbatim (class in matplotlib.backends.backend_pdf), 951
 VertexSelector (class in matplotlib.lines), 1253
 vertices (matplotlib.path.Path attribute), 1373
 Vf (class in matplotlib.dviread), 1183
 view_init() (mpl_toolkits.mplot3d.axes3d.Axes3D method), 1869
 view_limits() (matplotlib.ticker.LinearLocator method), 1643
 view_limits() (matplotlib.ticker.Locator method), 1642
 view_limits() (matplotlib.ticker.LogLocator method), 1644
 view_limits() (matplotlib.ticker.MaxNLocator method), 1645
 view_limits() (matplotlib.ticker.MultipleLocator method), 1644
 view_limits() (matplotlib.ticker.SymmetricalLogLocator method), 1646
 view_transformation() (in module mpl_toolkits.mplot3d.proj3d), 1877
 viewlim_to_dt() (matplotlib.dates.DateLocator method), 1171
 ViewsPositionsBase (class in matplotlib.backend_tools), 944
 violin() (matplotlib.axes.Axes method), 643
 violin_stats() (in module matplotlib.cbook), 967
 violinplot() (in module matplotlib.pyplot), 1583

- violinplot() (matplotlib.axes.Axes method), 641
 - viridis() (in module matplotlib.pyplot), 1585
 - vlines() (in module matplotlib.pyplot), 1585
 - vlines() (matplotlib.axes.Axes method), 597
 - Vlist (class in matplotlib.mathtext), 1276
 - vlist_out() (matplotlib.mathtext.Ship method), 1275
 - volume_overlay() (in module matplotlib.finance), 1216
 - volume_overlay2() (in module matplotlib.finance), 1216
 - volume_overlay3() (in module matplotlib.finance), 1217
 - vpack() (matplotlib.mathtext.Vlist method), 1276
 - Vpaker (class in matplotlib.offsetbox), 1323
 - Vrule (class in matplotlib.mathtext), 1277
- W**
- waitforbuttonpress() (in module matplotlib.pyplot), 1586
 - waitforbuttonpress() (matplotlib.figure.Figure method), 1204
 - warn_deprecated() (in module matplotlib.cbook), 968
 - Wedge (class in matplotlib.patches), 1362
 - wedge() (matplotlib.path.Path class method), 1373
 - WeekdayLocator (class in matplotlib.dates), 1173
 - weeks (matplotlib.dates.relativedelta attribute), 1178
 - weeks() (in module matplotlib.dates), 1179
 - weight_as_number() (in module matplotlib.font_manager), 1224
 - Widget (class in matplotlib.widgets), 1701
 - width (matplotlib.dviread.Tfm attribute), 1183
 - width (matplotlib.transforms.BboxBase attribute), 1654
 - widths (matplotlib.dviread.DviFont attribute), 1182
 - win32FontDirectory() (in module matplotlib.font_manager), 1224
 - win32InstalledFonts() (in module matplotlib.font_manager), 1225
 - window_hanning() (in module matplotlib.mlab), 1311
 - window_none() (in module matplotlib.mlab), 1311
 - winter() (in module matplotlib.pyplot), 1586
 - withSimplePatchShadow (class in matplotlib.patheffects), 1377
 - withStroke (class in matplotlib.patheffects), 1378
 - world_transformation() (in module mpl_toolkits.mplot3d.proj3d), 1877
 - wrap() (in module matplotlib.cbook), 969
 - write() (matplotlib.backends.backend_pdf.Stream method), 951
 - writeInfoDict() (matplotlib.backends.backend_pdf.PdfFile method), 949
 - writeTrailer() (matplotlib.backends.backend_pdf.PdfFile method), 949
 - writeXref() (matplotlib.backends.backend_pdf.PdfFile method), 949
 - wxpython, 3018
 - wxWidgets, 3018
- X**
- x (matplotlib.backend_bases.LocationEvent attribute), 924
 - x (matplotlib.backend_bases.MouseEvent attribute), 924
 - x (matplotlib.widgets.ToolHandles attribute), 1701
 - x0 (matplotlib.transforms.BboxBase attribute), 1654
 - x1 (matplotlib.transforms.BboxBase attribute), 1654
 - XAxis (class in matplotlib.axis), 794
 - XAxis (class in mpl_toolkits.mplot3d.axis3d), 1870
 - xaxis_date() (matplotlib.axes.Axes method), 756
 - xaxis_inverted() (matplotlib.axes.Axes method), 738
 - xcorr() (in module matplotlib.pyplot), 1586
 - xcorr() (matplotlib.axes.Axes method), 635
 - xdata (matplotlib.backend_bases.LocationEvent attribute), 924
 - xdata (matplotlib.backend_bases.MouseEvent attribute), 925
 - xkcd() (in module matplotlib.pyplot), 1587
 - xlabel() (in module matplotlib.pyplot), 1588
 - xlat() (matplotlib.cbook.Xlator method), 957
 - Xlator (class in matplotlib.cbook), 957
 - xlim() (in module matplotlib.pyplot), 1588
 - xmax (matplotlib.transforms.BboxBase attribute), 1654
 - xmin (matplotlib.transforms.BboxBase attribute), 1654
 - xscale() (in module matplotlib.pyplot), 1588
 - XTick (class in matplotlib.axis), 808
 - xticks() (in module matplotlib.pyplot), 1589
 - xy (matplotlib.patches.Polygon attribute), 1358
 - xy (matplotlib.patches.Rectangle attribute), 1360
 - xy (matplotlib.patches.RegularPolygon attribute), 1361

- xy() (matplotlib.cbook.MemoryMonitor method), 956
- xyann (matplotlib.offsetbox.AnnotationBbox attribute), 1316
- xyann (matplotlib.text.Annotation attribute), 1624
- ## Y
- y (matplotlib.backend_bases.LocationEvent attribute), 924
- y (matplotlib.backend_bases.MouseEvent attribute), 925
- y (matplotlib.widgets.ToolHandles attribute), 1701
- y0 (matplotlib.transforms.BboxBase attribute), 1654
- y1 (matplotlib.transforms.BboxBase attribute), 1654
- YAArrow (class in matplotlib.patches), 1364
- YAxis (class in matplotlib.axis), 794
- YAxis (class in mpl_toolkits.mplot3d.axis3d), 1870
- yaxis_date() (matplotlib.axes.Axes method), 756
- yaxis_inverted() (matplotlib.axes.Axes method), 738
- ydata (matplotlib.backend_bases.LocationEvent attribute), 924
- ydata (matplotlib.backend_bases.MouseEvent attribute), 925
- YearLocator (class in matplotlib.dates), 1173
- ylabel() (in module matplotlib.pyplot), 1590
- ylim() (in module matplotlib.pyplot), 1590
- ymax (matplotlib.transforms.BboxBase attribute), 1654
- ymin (matplotlib.transforms.BboxBase attribute), 1654
- yscale() (in module matplotlib.pyplot), 1590
- YTick (class in matplotlib.axis), 808
- yticks() (in module matplotlib.pyplot), 1591
- ## Z
- zalpha() (in module mpl_toolkits.mplot3d.art3d), 1876
- ZAxis (class in mpl_toolkits.mplot3d.axis3d), 1871
- zaxis_date() (mpl_toolkits.mplot3d.axes3d.Axes3D method), 1869
- zaxis_inverted() (mpl_toolkits.mplot3d.axes3d.Axes3D method), 1869
- zoom() (matplotlib.axis.Axis method), 803
- zoom() (matplotlib.axis.XAxis method), 832
- zoom() (matplotlib.axis.YAxis method), 823
- zoom() (matplotlib.backend_bases.NavigationToolbar2 method), 926
- zoom() (matplotlib.ticker.Locator method), 1642
- zoomed_inset_axes() (in module mpl_toolkits.axes_grid1.inset_locator), 1820
- ZoomPanBase (class in matplotlib.backend_tools), 944
- zorder (matplotlib.artist.Artist attribute), 545
- zorder (matplotlib.axes.Axes attribute), 789
- zorder (matplotlib.axis.Axis attribute), 889
- zorder (matplotlib.axis.Tick attribute), 849
- zorder (matplotlib.axis.XAxis attribute), 900
- zorder (matplotlib.axis.XTick attribute), 861
- zorder (matplotlib.axis.YAxis attribute), 911
- zorder (matplotlib.axis.YTick attribute), 872
- zorder (matplotlib.collections.AsteriskPolygonCollection attribute), 988
- zorder (matplotlib.collections.BrokenBarHCollection attribute), 1000
- zorder (matplotlib.collections.CircleCollection attribute), 1011
- zorder (matplotlib.collections.Collection attribute), 1023
- zorder (matplotlib.collections.EllipseCollection attribute), 1035
- zorder (matplotlib.collections.EventCollection attribute), 1048
- zorder (matplotlib.collections.LineCollection attribute), 1061
- zorder (matplotlib.collections.PatchCollection attribute), 1072
- zorder (matplotlib.collections.PathCollection attribute), 1084
- zorder (matplotlib.collections.PolyCollection attribute), 1096
- zorder (matplotlib.collections.QuadMesh attribute), 1108
- zorder (matplotlib.collections.RegularPolyCollection attribute), 1121
- zorder (matplotlib.collections.StarPolygonCollection attribute), 1133
- zorder (matplotlib.collections.TriMesh attribute), 1144
- zorder (matplotlib.image.FigureImage attribute), 1232
- zorder (matplotlib.legend.Legend attribute), 1241
- zorder (matplotlib.lines.Line2D attribute), 1253
- zorder (matplotlib.offsetbox.AnchoredOffsetbox attribute), 1314
- zorder (matplotlib.offsetbox.AnnotationBbox

attribute), 1316
zorder (matplotlib.patches.Patch attribute), 1355
zorder (matplotlib.text.Text attribute), 1631
ZORDER (mpl_toolkits.axes_grid.axis_artist.AxisArtist
attribute), 1802